



HAL
open science

3D Multimodal Interaction with Physically-based Virtual Environments

Maud Marchal

► **To cite this version:**

Maud Marchal. 3D Multimodal Interaction with Physically-based Virtual Environments. Graphics [cs.GR]. Université de Rennes 1, 2014. <tel-01139872>

HAL Id: tel-01139872

<https://inria.hal.science/tel-01139872v1>

Submitted on 7 Apr 2015

HAL is a multi-disciplinary open access archive for the deposit and dissemination of scientific research documents, whether they are published or not. The documents may come from teaching and research institutions in France or abroad, or from public or private research centers.

L'archive ouverte pluridisciplinaire **HAL**, est destinée au dépôt et à la diffusion de documents scientifiques de niveau recherche, publiés ou non, émanant des établissements d'enseignement et de recherche français ou étrangers, des laboratoires publics ou privés.



HAL Authorization

HABILITATION À DIRIGER DES RECHERCHES

Université Rennes 1

3D Multimodal Interaction with Physically-based Virtual Environments

Maud Marchal

November 20th, 2014

Jury:

Marie-Paule Cani	Professor, Grenoble-INP, France
Bernd Fröhlich	Professor, University of Weimar, Germany
Pascal Guitton	Professor, Université de Bordeaux, France
Jean-Marc Jézéquel	Professor, Université de Rennes 1, France
Torsten Kuhlen	Professor, University of Aachen, Germany
Karon MacLean	Professor, University of British Columbia, Canada
Jos Stam	Research scientist Autodesk, Canada

Contents

I	Introduction	5
II	Physically-based Modeling of Complex Virtual Objects and their Interactions	17
1	Deformable objects modeling and validation methodology	21
1.1	Validation methodology	21
1.2	Design of phantoms	29
1.3	Conclusion	32
2	Topology modifications of virtual objects	35
2.1	Novel models for real-time simulation of brittle fracture	35
2.2	Fiber-based fracture model for simulating soft tissue tearing	42
2.3	Conclusion	44
3	Interactions through deformable instruments and hands	45
3.1	Model and simulation of needle insertion	46
3.2	Model and simulation of coil deployment	49
3.3	Towards interactions through virtual deformable hands	53
3.4	Conclusion	59
III	Multimodal Feedback with Complex Virtual Environments	61
4	Haptic feedback	65
4.1	6 DoF haptic interaction with the different states of the matter	66
4.2	Haptic sub-world: a coupling scheme for a high number of rigid bodies interaction	70
4.3	The God-finger method for emulating a contact area during 6 DoF haptic interaction	73
4.4	Conclusion	76
5	Visual feedback	77
5.1	Example-based fracture appearance	78
5.2	Stereoscopic rendering of virtual environments with wide field-of-views	82
5.3	Conclusion	84
6	Multimodal feedback	87
6.1	Multimodal rendering of fluids	88
6.2	King-Kong Effects: improving sensation of walking with multimodal vibrations at each step	91

6.3	Toward adaptive VR simulators combining visual, haptic, and brain-computer interfaces	93
6.4	Conclusion	97
7	Crossmodal feedback	99
7.1	Pseudo-haptic walking	99
7.2	Elastic images	103
7.3	Conclusion	104
IV	3D Interaction Techniques with Complex Virtual Environments using Body Skills	107
8	3D interaction devices	111
8.1	Joyman: a human-scale joystick for navigating in virtual environments	111
8.2	FlyVIZ: a display device to provide humans with 360° vision	114
8.3	Conclusion	116
9	3D manipulation techniques	119
9.1	Virtual Mitten: an interaction paradigm for visuo-haptic manipulation of objects using grip force	120
9.2	Bimanual interaction techniques	122
9.3	Conclusion	126
10	3D navigation techniques	127
10.1	Navigation in large virtual environments within restricted real workspaces	128
10.2	Shake-Your-Head: a navigation technique revisiting walking-in-place	131
10.3	Conclusion	134
V	Conclusion	135
	Bibliography	145

Remerciements

Ce manuscrit n'aurait jamais vu le jour sans le travail, l'engagement et l'inspiration d'un grand nombre de personnes. Je profite de ce manuscrit pour les remercier chaleureusement, et plus particulièrement :

I would like first to thank all the members of my habilitation committee. I am very honored that you have accepted to read my manuscript and to travel all around the world for the defense. Thus, I would like particularly to thank the three reviewers: Marie-Paule Cani, Bernd Fröhlich and Pascal Guittou for having taken the time to review my manuscript. Then, I would like to thank also the committee members: Karon MacLean, Jean-Marc Jezequel, Torsten Kuhlen and Jos Stam. The presence of such a multidisciplinary committee was a very high honor for me.

Pour leur soutien au quotidien, je remercie mes collègues à Rennes. Je remercie plus particulièrement Anatole Lécuyer pour nos brainstormings de recherche si motivants et nos échanges depuis mon arrivée à Rennes. Je remercie également Bruno Arnaldi pour ses conseils (très!) avisés, que ce soit côté enseignement ou côté recherche. L'équipe Hybrid créée en 2013 offre un cadre de travail très agréable et une ambiance à toute épreuve: merci à tous ses membres et particulièrement aux "permanents" Ferran, Florian, Thierry, Valérie et notre super assistante Nathalie. Depuis mon arrivée à Rennes en septembre 2008, j'ai déjà eu l'occasion d'expérimenter plusieurs équipes. Merci à Stéphane Donikian pour m'avoir accueillie dans Bunraku puis Georges Dumont dans VR4i. Depuis l'époque Bunraku, plusieurs équipes ont vu le jour et je remercie tout particulièrement les anciens zukaris, dont Julien et Franck avec qui j'ai plus particulièrement travaillé. Enfin, un grand merci à mes co-bureaux (dans l'ordre chronologique) Gabriel, Tony, Anne-Hélène et Ferran. Parce que dans notre métier d'enseignant-chercheur, l'enseignement nous occupe la moitié de notre temps, j'aimerai également profiter de ce manuscrit pour remercier mes collègues de l'INSA de Rennes pour leur accueil lors de mon arrivée, ainsi que pour les (nombreux et intéressants!) échanges pédagogiques que nous pouvons avoir au quotidien.

Si une grande partie du travail décrit dans ce manuscrit a été réalisée depuis mon arrivée à Rennes, j'ai également eu la chance de travailler à plusieurs endroits dans le monde pour lesquels je garde de très bons souvenirs scientifiques et humains. A Grenoble, j'ai une pensée particulière pour mes directeurs de thèse Jocelyne Troccaz et Emmanuel Promayon pour m'avoir initiée aux joies de la recherche. Tim Salcudean m'a ensuite accueillie à l'Université de Colombie Britannique au Canada où j'ai pu notamment travaillé avec Orcun Goksel et Ehsan Dehghan. Merci à tous les membres de St John's College qui m'ont fait découvrir la superbe ville de Vancouver. Je suis revenue en France par le Nord avec un séjour à Lille au cours duquel j'ai pu collaborer sur des sujets qui me tenaient à cœur. Merci à Jérémie Allard, Christophe Chaillou, Stéphane Cotin, Christian Duriez, Jérémie Dequidt et Laurent Grisoni.

Réaliser ses travaux de recherche entourée d'autres personnes est pour moi inestimable, que ce soit sur le plan scientifique ou humain. Je remercie toutes les personnes avec qui j'ai pu collaborer ces dernières années, à Rennes, en France ou bien dans d'autres pays. J'espère que nous pourrons initier d'autres projets de recherche aussi passionnants dans les années à venir! Un remerciement particulier à (ordre alphabétique) : Carlos Botsch, Sean

Chen, Géry Casiez, Jeremy Cooperstock, Guillaume Dardenne, George Drettakis, Caroline Essert, Federico Fontana, Jean-Yves Gauvrit, Laurent George, David Gomez Jauregui, Taku Hachisu, Claire Haegelen, Pierre Hellier, Sébastien Hillaire, Pierre Jannin, Hiroyuki Kajimoto, Alexandre Krupa, Anthony Le Bras, Fabien Lotte, Emilie Loup-Escande, Eric Marchand, Xavier Morandi, Miguel Otaduy, Holly Rushmeier, Stefania Serafin, Peter Vangorp, Yon Visell.

Enfin, les travaux de recherche présentés dans ce manuscrit n'auraient pour la plupart jamais vu le jour sans la présence des étudiants avec qui j'ai eu la chance de travailler. Un grand merci à tous mes doctorants pour leurs efforts, leur passion et leur travail (dans l'ordre chronologique) : Gabriel Cirio, Lœiz Glondu, Léo Terziman, Anthony Talvas, Jérôme Ardouin, Jonathan Mercier-Ganady, Merwan Achibet, Lucas Royer et Benoît Le Gouis. Merci également aux post-doctorants avec qui j'ai pu travaillé: Tony Regia-Corte et Adrien Girard, ainsi qu'aux étudiants de Master : Maxime Vignon, Pauline Girard, Samuel Pineau, Clément Nicolas, Alexandre Kabil, Frédéric Monge, Rémi Pineau, Pierre Chatelain et Morgan Le Chénéchal et les étudiants ingénieur Laurent Bonnet, Tristan Le Bouffant et Aurélien Le Gentil, et enfin tous les étudiants que j'ai pu encadrés au cours de stages d'été.

Merci également aux membres de ma famille, et plus particulièrement mes parents et mes frères qui ont pu voir la "suite" de mes aventures huit ans après ma soutenance de thèse. Un très grand merci à mes parents pour leur soutien et leur présence depuis toutes ces années. Merci d'avoir été présents à ma soutenance, ainsi qu'Olivier et Jean-Claude. Enfin, j'ai également une pensée pour mes amis qui suivent mes périples à travers le monde depuis de nombreuses années et qui me permettent de m'échapper du fabuleux monde de la recherche (de temps en temps!).

Mes derniers remerciements vont à ma "petite" famille. Je pense très fort à Hugo et Arthur pour la joie qu'ils m'apportent au quotidien. J'ai passé de nombreuses heures en face de mon ordinateur, heureusement les lapins et les cochons qui se cassent ou la fabrication des crêpes permettent d'illustrer un métier un peu (très?) obscur pour les tout petits :-). Enfin et surtout, je remercie mon mari Mathieu pour son soutien inconditionnel au quotidien, depuis mes débuts dans le monde si captivant (dans tous les sens du terme!) de la recherche.



Part I

Introduction

Introduction

The virtual as a reality

More than two decades ago, Jaron Lanier was describing *Virtual Reality* with the following words:

"As babies, each of us has an astonishing liquid infinity of imagination on the inside; that butts up against the stark reality of the physical world. That the baby's imagination cannot be realized is a fundamental indignity that we only learn to live with when we decide to call ourselves adults. With virtual reality you have a world with many of the qualities of the physical world, but it doesn't resist us. It releases us from the taboo against infinite possibilities. That's the reason virtual reality electrifies people so much." (Jaron Lanier, Omni magazine, January 1991).

Jaron Lanier expressed the growing interest for the Virtual Reality (VR) field in the 1990s, especially for the general audience. The process of designing a virtual world with various behaviors compared to the real world was already explored since 1965 when Ivan Sutherland envisioned what he called the "Ultimate Display" [Sutherland 65]. This device, "a room within which the computer can control the existence of matter", exposed users to wireframe interiors, aiming at a virtual world that "gives us a chance to gain familiarity with concepts not realizable in the physical world". Since Sutherland's innovations, the industry will have had disorienting cycles of ups-and-downs for VR technologies. The main part of the equipment that was built during this period made technological leaps but never be faced a consumer. In the late 1980s, the development of high-performance computers starts the design of consumer-available virtual reality hardware. Interactivity was no more wishful thinking as visualization and then haptic technologies begun to be more accessible.

Since almost three decades, the virtual has become a huge field of exploration for researchers: it could assist the surgeon, help the prototyping of industrial objects, simulate natural phenomena, be a fantastic time machine or entertain users through games or films. Far beyond the only visual rendering of the virtual environment, the Virtual Reality aims at -literally- immersing the user in the virtual world. VR technologies simulate digital environments with which users can interact and, as a result, perceive through different modalities the effects of their actions in real time. The challenges were and are still huge: the user's motions need to be perceived and to have an immediate impact on the virtual world by modifying the objects in real-time. In addition, the targeted immersion of the user is not only visual: auditory or haptic feedback need to be taken into account, merging all the sensorial modalities of the user into a multimodal answer.

In the 1990s, there was mostly no direct pathway for VR between lab innovation and consumers' homes. Since that time, computer processing power doubled many times. Powerful devices and accurate sensors are now commonplace, not only for PC but also for smartphones and tablets. VR has the inherent capacity to realistically provide and simulate specific virtual environments (VE), even before these environments are actually used or even built in real life. Furthermore, VR is not limited to copying and imitating real world scenarios and behaviors: it allows the creation and simulation of any sort of VE, limited only by the imagination of the designer and the capabilities of the system. As a consequence, VR starts nowadays to be found in different applied domains outside of the many research labs devoted to this field, opening novel perspectives to move the end-user closer to the virtual world.

The complexity of the real world, the perception of the virtual world

Nowadays, many VR applications attempt to imitate or to be inspired by the processes of the real world. The complexity of the real world leads to increasing complexity of the virtual one these last decades. For instance, first real-time medical simulations with haptic rendering were made possible two decades ago [Cotin 96] while we are now able to simulate complex medical environments, taking into account geometry, physical and even physiological properties [Pernod 11], as illustrated in Figure 1.

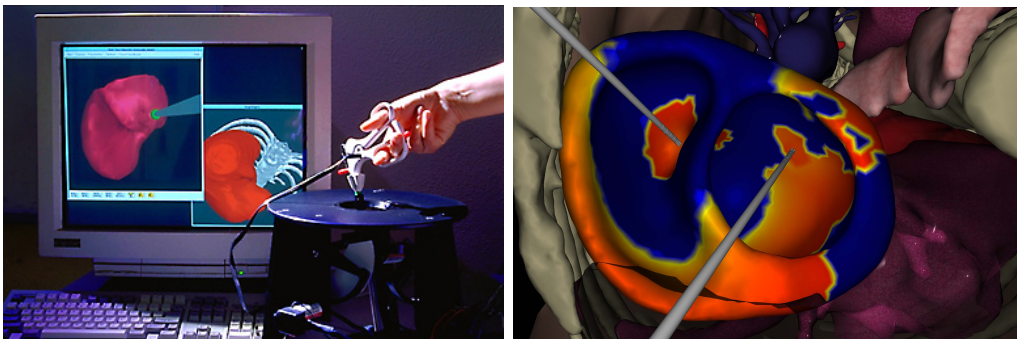

Figure 1 – Increasing complexity for medical virtual environments: (a) one of the first real-time medical simulation for the hepatic surgery [Cotin 96], (b) simulation of ventricular tachycardia ablation: two catheters are used to perform the gestures in a complex anatomical environment where colored surfaces represent the electrophysiological wave propagation simulated [Pernod 11].

There are many ways in which a VE can become complex: the large size of the objects or the scenes, the high number of objects or polygons, the concave or intricate shapes of the objects or the landscape, the physically-based behavior of the media or the large dynamic components are some examples that can increase the complexity of a VE. Behaviors of real world objects exhibit multiple sources of complexity, especially for mechanical effects such as non-linearity, anisotropy, heterogeneity or topology modifications. These effects are generally reproduced or enhanced in the virtual world with a given amount of complexity. In this manuscript, the word complex will generally refer to a higher demand in the characteristics of the VE and/or its objects.

As complex environments actually represent most real-life scenarios, virtual reality applications imply that users should be able to interact with them. The main limiting factors for interaction range from the available computational power to the limited technology, as

well as the inherently complex nature of physical phenomena. In fact, most situations that we live in our (real) life cannot be simulated in a faithful manner. Existing VR applications in the literature propose solutions that generally incorporate the latest hardware and software solutions to achieve the simulation of virtual scenarios. Thus, besides reproducing multiple real-life objects with physical realism, interactivity represents a key issue in VR applications. For instance, if various physically-based models of mechanical phenomena have been proposed in other disciplines such as physics, mathematics or engineering fields, these models have made their way through virtual reality because of algorithms that are geared to obtaining the desired perceptual stimuli but also most of the time incurring in a trade-off between physical realism and interactivity. Temporal constraints play a major role in the design of VR applications, and require to consider the interactivity of the simulation - inherently correlated to the complexity of the virtual environment -, but also for instance the latency of the interaction from both hardware and software points of view.

The user's perception of the virtual world generally represents the key indicator of the degree of interactivity that the virtual environment can generate. The more believable the interaction and its feedback, the more it makes the user unconsciously shift his reality from the real to the virtual environment, developing a true sense of presence, as defined by the "sense of being there" by Slater [Slater 95], an illusion of being located inside the VE depicted by the VR system. Thus, interaction significantly contributes in making VR such a powerful and immersive tool.

Research challenges

In this manuscript, we define the research context of our work for 3D interaction with virtual environments based on three characteristics illustrated in the 3D interaction loop in Figure 2 :

- **Physically-based modeling.** Users expect the VE to behave like in the real world, except for specific scenarios. Objects are supposed to fall, collide, deform, flow and should respond to user's actions with realistic behavior. Thus, they have to follow the different laws of physics, at least from a macroscopic point of view. Doing this geometrically or by predefined animation keys only works for specific, precomputed, and therefore limited scenarios. For full interaction possibilities with different VE, the behavior has to be described by physically-based models of the different objects populating the scene.
- **Multimodal feedback.** In real life, we interact with our surrounding environment with our five senses. Each sense provides complementary cues for a wider and more accurate perception. Ideally, it should be the same in a VR simulation. It should be safe to state that, for most tasks, humans rely on vision, hearing and touch. Thus, we believe that these three modalities should be simulated and rendered to the user in VR applications.
- **Body-based 3D interaction.** Each of us uses all our body possibilities to interact with our environment. If VR was limited to specific hardware using mainly hand or head motions one decade ago, there have been these last years increasing novel hardware setups tracking and measuring full-body motions and feedback. Following these improved hardware devices, 3D interaction techniques have to adapt their properties to propose novel interaction metaphors exploiting similar body inputs and outputs as in the real world.

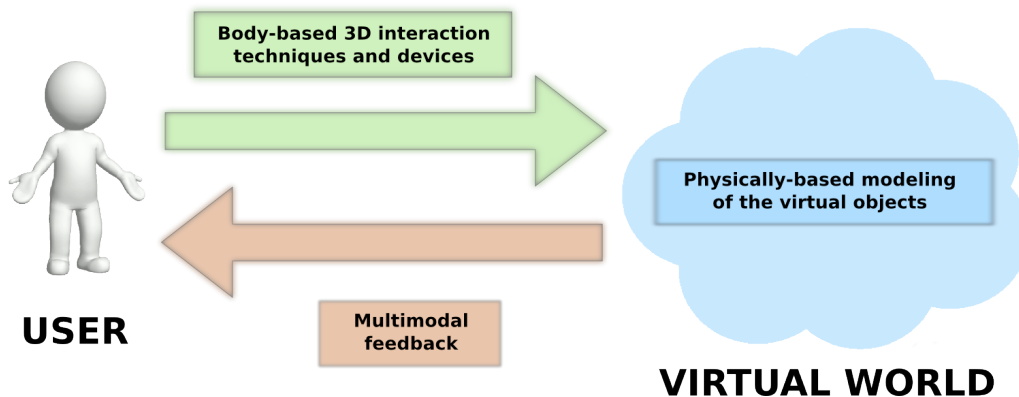

Figure 2 – Illustration of our research context through the 3D interaction loop. VR approaches share common characteristics: the physically-based **modeling** of the virtual world to take into account the complexity of the objects and their interactions, the user multi-modal **feedback** to merge all the sensorial modalities into a global answer from the virtual world to the user and the 3D **interaction** techniques and devices to establish essential links between the user and the virtual world to fully 3D multimodal and physically-based experience.

Thus, 3D interaction with complex virtual environments inherently pose **modeling**, **feedback** and **interaction challenges**. In this manuscript, we summarize our research work within these three research challenges. Designing complex environments raises different conceptual and technical issues according to each of these three main challenges. Therefore, more specific objectives could be formulated under each research challenge, as detailed below:

1. Modeling physically-based virtual objects in interaction with their environment:

When interacting with 3D virtual environments, virtual objects are commonly described and perceptually identified by their shape and behavior. In the latest years, many advances have been made in the fields of Virtual Reality and Computer Graphics to capture and reconstruct the 3D physical behavior of a wide range of complex objects with various media such as fluid [Bridson 08], solid [Bender 14] or deformable objects [Nealen 06]. **Connecting the 3D geometry**, which intrinsically encodes the effect of the surrounding environment, **to the mechanical properties** of the underlying object, remains an important challenge, especially for objects featuring an intricate shape or with highly deformable material, or undergoing topology modifications, such as fracture or tearing phenomena. Important progress have been achieved to obtain realistic behavior, especially for applications in the medical field where the proximity to real data remains essential. For that reason, the **validation step** is a key issue that needs to be addressed, both to verify the numerical model behavior and to compare it with real data.

In addition to the modeling of physically-based virtual objects, the simulation of their interactions represents a key step, especially in VR applications where the user generally plays a major role. For that reason, approaches have been proposed in the literature to simulate the interactions between objects but also through instruments guided by the user himself. Physically-based interactive gestures with virtual environments remain however under-covered since the trade-off between realism and interactivity is still an issue for **complex interactions with highly-specialized objects or a virtual hand** itself.

2. Rendering multimodal feedback using the different user sensorial modalities:

Touching, feeling objects when interacting with them is in our very nature, as virtually all tasks we accomplish in real life involve bodily interaction with the environment. It is in fact quite likely that a higher sense of presence could be generated in a VR simulation by adding force feedback to an existing visual or auditory VR setup, than by improving one particular modality such as the visual display alone [Srinivasan 97]. Besides, the addition of force feedback to VR simulations has been shown to improve user's immersion and performance [Adams 01, Lee 08] when accomplishing some specific tasks in the VE. The main challenge behind simulating any phenomenon through different modalities is the need to simulate its dynamics at different temporal and spatial scales. Haptic feedback, for example, can require 1kHz signals for feeling brief contacts between rigid bodies [Colgate 95]. Conversely, visual feedback requires an update rate within a range between 30Hz to 200Hz with potentially discarded small details in large virtual environments. Therefore, one main challenge for the virtual reality domain is the ability to **simulate any combination of sensory modalities into a multimodal answer**, depending on the scale of the chosen application.

In order to favor a better synchronization between modalities by generating all feedback from the same physical data, physically-based approaches present advantages over geometrical or pre-recorded techniques for feedback generation since they automate and often improve the feedback quality. If physical models are still mainly addressed in the literature in order to produce realistic visual results, other sensory modalities, such as haptic channel, could however benefit also from new physical models of interactive virtual objects. With the increase of computational power, physically-based multi-sensory rendering has already received increased attention in recent years for either acoustic rendering, vibrotactile rendering, or kinesthetic rendering. The challenge under physically-based feedback is to **design and propose appropriate models for all the sensorial channels**. These models should be able to produce in a physically-plausible manner the outputs of the virtual world. The intrinsic challenge is to **evaluate these feedbacks** to better explore the best weighted combination of sensorial modalities within a given VR application.

3. Designing 3D interaction techniques and devices using user's body skills:

When the user interacts with the virtual world, the first step consists in translating his actions into an explicit command for the virtual environment [Bowman 04]. As defined by Hinckley *et al.* [Hinckley 04], "*an interaction technique is the fusion of input and output, consisting of all software and hardware elements, that provides a way for the user to accomplish a task*". From Bowman *et al.* [Bowman 04] seminal taxonomy of VR tasks, four different tasks could be distinguished: navigating the virtual world, selecting a virtual object, manipulating it, or controlling the application. The addition of a third dimension, the use of stereoscopic rendering and the use of advanced VR interfaces make however inappropriate many techniques that proved efficient in 2D, and make it necessary to **design specific interaction techniques and adapted devices** and tools.

With the last improvements on setups and tracking systems which measure positions and actions of the user, the entire user body can be used to interact with a virtual

environment. If classical measured motions were the hands and the head, novel motion measurements could now be envisaged such as the feet, the full-body or at a smaller scale the fingers. This implies the **design of novel interaction techniques and devices that exploit all the user's body skills**.

Due to new 3D input devices becoming widely available even for the general public, research in new 3D user interfaces is more relevant than ever [Bowman 08]. With 2D applications, people would generally use a 2D mouse and a keyboard whilst high-level VR applications propose motion tracking systems for 3D tracking or haptic devices for example. In this domain, the challenge for **novel interfaces** is to try **to involve the body or to increase the user capacities**. This new type of interface should allow 3D interaction in virtual worlds using novel body skill interaction.

Besides the need for novel interfaces, novel interaction techniques are also required for involving all the body skills. For manipulating virtual objects, many approaches have been proposed, mainly for one hand manipulation. However in our daily lives, we commonly use other parts of our body to manipulate objects. A straightforward example is the use of our two hands to perform all sorts of tasks such as holding a bottle with one hand and opening it with the other or simply writing a letter with one hand while holding it with the other. In contrast, when it comes to 3D interaction with virtual environments, until recently the interaction happened mostly through one hand only, generally the one referred to as the dominant hand. Considering the importance of using two hands in real life, it raises the need for **manipulation techniques that better integrate different body parts**, such as the two hands but also such as multi-finger interaction to better translate the physical properties of the virtual world and thus increase our sense of presence.

Among the other fundamental tasks in VR, a growing interest has also namely been observed this last decade for navigation interaction techniques. The recent development of large virtual environment as well as the improvement of hardware interfaces led to the design of novel interaction metaphors for improved locomotions in VE. One objective is to **obtain natural walking in a virtual environment**, implying new devices dedicated to the feet [Visell 10] or novel interaction techniques.

Approach and contributions

Our global objective is to improve 3D interaction with complex virtual environments by proposing **novel approaches for physically-based and multimodal interaction**. When conducting our research, we particularly paid attention to the **validation process of our contributions**. This implies that we have conducted experiments to compare our approaches both to real data and to users' perception. This approach remains essential in our work and more generally for our design of VR applications.

In order to present our research work, we have focused our attention in this manuscript on three research axes, corresponding to the physically-based and multimodal interaction with complex VE. These axes are summarized in Figure 3 through the 3D interaction loop.

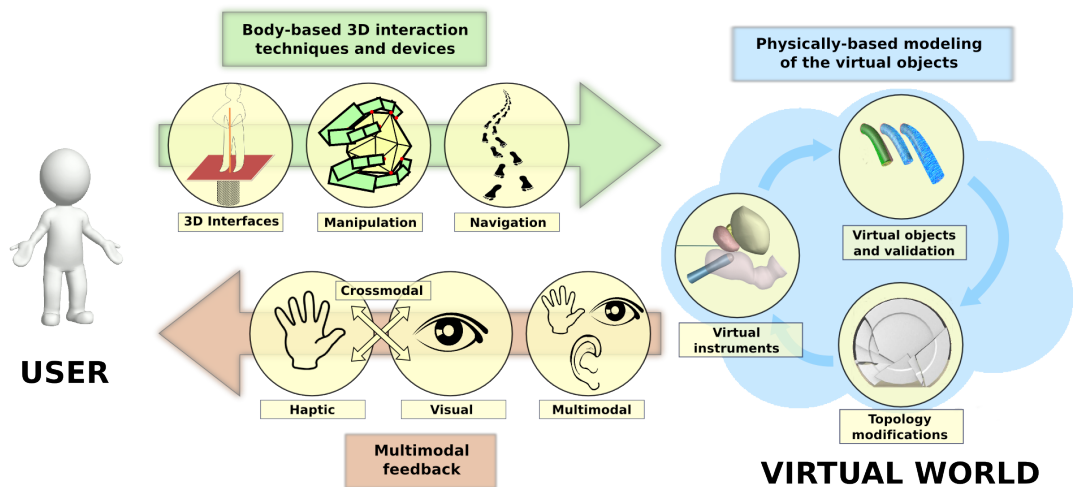

Figure 3 – Summary of our contributions through the 3D interaction loop. The contributions categories are represented with yellow color. The physically-based **modeling** of the virtual world takes into account the complexity of the virtual object behavior, their topology modifications and their interactions (Axis #1). The multimodal **feedback** combines all sensorial modalities into a global answer from the virtual world to the user (Axis #2). The 3D **interaction** techniques and devices establish essential links between the user and the virtual world to fully 3D multimodal and physically-based experience (Axis #3).

Axis 1 - Physically-based Modeling of Complex Virtual Objects and their Interactions

Based on our initial work on soft tissue modeling in their environment for the simulation of medical gestures [Marchal 06], our contributions in this research axis were mainly focused in a medical context. This applicative area owns challenging issues that we then extended to other applications. Our main research activity remains the simulation of deformable material, representing soft tissues in a medical context. While many advances have been made, especially in the computer graphics area, to model various physical properties, the simulation of deformable objects does not still today cover all the physical behaviors, as soft tissues could be inhomogeneous, anisotropic, highly-deformable or even hyperelastic, or owning visco-elastic properties. For that reason, we introduce in a systematic manner a validation process in our contributions. Our **validation methodology** is particularly composed of comparisons of our deformable models with real data, through the design of phantoms. Interactions between objects imply also collision detection and for some materials, **topology modifications**. We mainly focused our effort on brittle fracture simulation, with preliminary results on soft tissue tearing. When introducing the user in the interaction loop, we usually have the need of simulating **virtual instruments** or even a **virtual hand** itself. We worked specifically on thin and deformable virtual instruments, in interaction with deformable material in a medical context. We also recently proposed to handle the simulation of a virtual deformable hand, incorporating virtually the user in the virtual environment.

Axis 2 - Multimodal Feedback with Complex Virtual Environments

Our contributions on multimodal feedback with complex virtual environments are mainly targeted to the physically-based **haptic feedback of the interactions** with virtual environments. We aim at rendering haptic sensations to the user at an interactive rate and when the virtual scenes are complex, both in terms of physical behavior and number of objects or contacts. To achieve this objective, we mainly targeted our effort on kinesthetic feedback, with contributions focused on designing novel physically-based coupling schemes between the virtual world and the haptic devices. Besides the haptic feedback, we are also interested in providing an efficient visual feedback to the user, with appropriate rendering of physical behavior of the virtual environments through the use of VR technologies. We particularly focused our attention to the design of **visual feedback for complex virtual environments** that own specific properties such as a wide field-of-view or the need for highly-realistic representations of physical phenomena. As of today, VR applications require the design of multimodal feedback for the user. In our work, we tried to gather different technologies to build use cases of potential multimodal experience. In these use cases, our objective was to enhance the virtual environments through the combination of novel physically-based methods and 3D user interfaces. Our main efforts were focused on **designing appropriate models for synchronizing all the sensorial modalities** in a global answer. If the haptic, visual and acoustic feedbacks are generally combined in VR applications to obtain a multimodal answer, VR technologies sometimes suffer from hardware components, notably haptic devices. We focused our attention on **crossmodal approaches** to overcome the limitations of VR hardware devices, especially for introducing haptic sensations through the use of the visual and the auditory modalities.

Axis 3 - 3D Interaction Techniques with Complex Virtual Environments using Body Skills

Our research activity is focused on enhancing the 3D interaction techniques and devices through the use of our body skills. For that purpose, we are particularly interested, among the fundamental tasks in VR, in the **manipulation of virtual objects and the navigation in virtual environments**. For manipulating virtual objects, we focus our efforts on the design of interaction techniques that better integrate different body parts, such as the two hands but also such as multi-finger interaction. Our main objective is to overcome the limitations of current interaction techniques with an increasing **use of the hand motions and feedback possibilities**. Concerning the navigation task, our main goal is to obtain **natural walking** in a virtual environment, through the use of hardware interfaces dedicated to the feet. We thus proposed novel metaphors easing the walking in complex scenarios such as very large virtual environments or with different types of trajectories. We particularly used different body information such as the head orientation or the combination of hands and feet motions. Besides the design of novel metaphors for 3D interaction with complex virtual environments, we were also interested in our research to build **novel 3D interfaces for enhancing the body skills**. We particularly designed two interfaces, the *Joyman* aiming at preserving equilibrioception in order to improve the feeling of immersion during virtual locomotion tasks and the *FlyVIZ* increasing the human field-of-view for better manipulation and navigation in virtual environments.

Overview

This manuscript presents my research activities since 2007 in order to address the objectives mentioned above. The main contributions of my work are presented in Figure 3. The manuscript is naturally divided in three parts, each following a research axis:

- Part II describes our contributions on **physically-based modeling of complex virtual objects and their interactions**. It is composed of 3 chapters, following the modeling process of the virtual world. Chapter 1 describes our validation methodology, mainly for the simulation of deformable models in a medical context. When different objects interact in the virtual environments, they can undergo topology modifications. Chapter 2 presents our contributions on this topic, mainly for brittle fracture and soft tissue tearing. Finally, the user interactions are generally simulated in the virtual environment through the use of virtual instruments or a virtual hand itself, as detailed in chapter 3.
- Part III describes novel approaches for **multimodal feedback with complex virtual environments**. Our contributions explore the different sensorial modalities as well as their combinations. Chapter 4 details the methods we proposed to enhance the haptic rendering of complex virtual environments. Chapter 5 describes our approaches for improving visual feedback through the user of augmented or adapted visual skills. Chapter 6 gathers some examples of our multimodal approaches for virtual environments while chapter 7 highlights novel crossmodal methods we proposed for enhancing the rendering of a user sensorial modality.
- Part IV describes novel **3D interaction techniques with complex virtual environments using body skills**. The design of novel interfaces taking into account body information and increasing user's skills are detailed in chapter 8. Concerning the interaction techniques, we were mainly interesting in two fundamental tasks: the manipulation of virtual objects presented in chapter 9 and the navigation techniques described in chapter 10.
- Part V concludes the summary of my contributions and gives some perspectives on my future research activities.

All the contributions described in this manuscript have been achieved during my two post-doctoral positions (2007-2008) and my associate professor position (since 2008). During this period, I have been particularly honored to supervise PhD students that have greatly contributed to my research activities: Dr. Gabriel Cirio (2008-2011), Dr. Loeiz Glondu (2009-2012) and Dr. Léo Terziman. (2009-2012). The work of on-going PhD students is partly mentioned in this manuscript: Anthony Talvas (2011-), Jérôme Ardouin (2011-), Merwan Achibet (2012-), Jonathan Mercier-Ganady (2012-) and Lucas Royer (2013-). I have also collaborated with different researchers and their names will be mentioned in the appropriate sections of this manuscript.

Part II

Physically-based Modeling of Complex Virtual Objects and their Interactions

Our research work on **physically-based modeling of complex virtual objects and their interactions** is reported in the following chapters. We decompose our contributions in 3 different chapters, following our general scheme detailed in Figure 4.

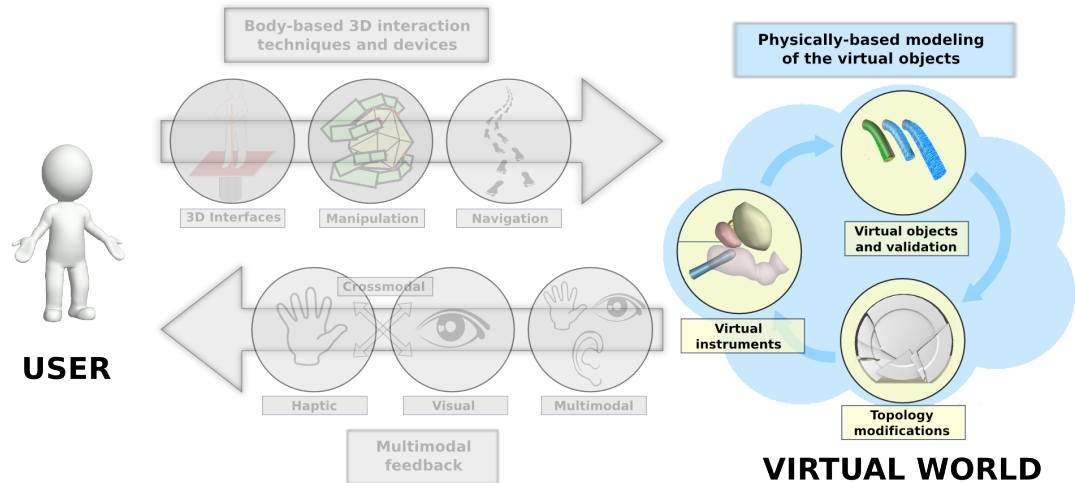

Figure 4 – Our first research axis is focused on the physically-based modeling of the virtual world to take into account the complexity of the objects and their interactions. The axis is decomposed in three parts. (1) We were first interested in simulating various physical properties for the objects populating the virtual world. The design of a validation methodology for physically-based models remains essential, both to verify the numerical model behavior and to compare it with real data. It will be detailed in chapter 1. (2) In addition to the modeling of physically-based virtual objects, the simulation of their interactions represents a key step, especially in VR applications where the user generally plays a major role. Interactions between objects imply collision detection and for some material, topology modifications, addressed in chapter 2. (3) When introducing the user in the interaction loop, we usually have the need of simulating virtual instruments or even a virtual hand itself, as we proposed in chapter 3.

Outline

When populating the virtual environment with objects with physically-based behavior, we face the choice of the appropriate physical models. Various physical properties have already been simulated, going from fluid to rigid bodies, through several different deformable properties. Depending on the targeted application, the model should generally be compared to other approaches in the literature or to real data. Part of our research work is thus focused on **proposing benchmarks and validation methodology for comparing physically-based models**. Chapter 1 is dedicated to the description of these contributions.

In addition to the wide range of complex objects with various physical properties, the **physically-based modeling of objects undergoing topology modifications** remains an issue, especially when we aim at interactive and realistic virtual environments. Both the simulation of the physical process and the managing of the various interactively-created objects are the key challenges of the models dedicated to the description of fracture or tearing phenomena. In our work, we were interested in the interactive simulation of these complex mechanical behaviors, with the underlying objective of taking into account the real data specificities. We focused our contributions on two particular topology modifica-

tions: the brittle fracture and the tearing of fiber-based deformable objects, illustrated in chapter 2.

The simulation of the interactions of a user with a virtual environment represents a key challenge for the user's perception of the virtual worlds. The interaction occurs generally through a virtual instrument manipulated by the user. Physically-based behavior of these instruments in interaction with the virtual objects is essential to provide to the user the resulting information of his gestures. If rigid objects remain the most used material for the virtual instruments, novel approaches can nowadays be envisaged to get **interactive simulation of deformable instruments**. In the first part of chapter 3, we present our contributions on the simulation of deformable instruments in a medical context. For that reason, we have specifically focused our attention on the validation of our simulations against real data.

In some cases, the **simulation of a realistic virtual hand** is well-appropriate for interacting with the virtual objects. However, the interactive simulation of an articulated hand with deformable phalanges faces computational challenges. In the second part of chapter 3 we present our recent work on that topic.

Deformable objects modeling and validation methodology

1

Contents

2.1 Novel models for real-time simulation of brittle fracture	35
2.1.1 Context, challenges and main contributions	35
2.1.2 Modeling the fracture state of a brittle body and the crack propagations	36
2.1.3 Modeling impact-based fractures	37
2.1.4 Efficient collision handling for brittle fracture	40
2.1.5 Preliminary validation of the impact-based fracture model based on real data	41
2.2 Fiber-based fracture model for simulating soft tissue tearing	42
2.3 Conclusion	44

Many advances have been made these last two decades in the fields of Virtual Reality and Computer Graphics to capture and reconstruct the 3D physical behavior of various complex objects, going from fluid to rigid bodies, through several different deformable properties. Connecting the 3D geometry to the mechanical properties requires to choose the appropriate physical models. Depending on the targeted application, the model should generally be compared to other approaches in the literature or to real data. The validation step is particularly essential for medical applications where the proximity to real data is often required. Part of our research work is thus focused on **proposing benchmarks and validation methodology for comparing physically-based models**. This chapter is dedicated to the description of these contributions. Our contributions are decomposed in two main parts: first we present our propositions on validation methodology and then our comparisons with real data. Validation methodology in the context of medical applications is especially underlined in our contributions.

1.1 Validation methodology

The section gathers our attempt to propose tools for comparing physically-based models. Thus, we first propose a framework for validating deformable models in the context of medical simulation. Then, we also present our work on evaluating physical libraries for contacts between rigid bodies. We targeted two application examples with specific requirements: the medical simulation where the validation step is a key challenge before applying the simulation to patients, and the haptic rendering where the frame rate is essential to obtain haptic feedback.

1.1.1 Towards a framework for assessing deformable models in medical simulation

Context

Accurate and interactive simulations of medical environment offer new alternatives and potential helpful tools for the realization of the physician gestures. Thus, deformable models can provide information on the global behavior of soft biological materials, even for locations where it may be difficult to obtain experimental data. In addition, ongoing improvements of computational power make it possible to use more complex models and produce more realistic representations of medical environment. While these motivations have been a driving force for the rapid growth of deformable models, they have also triggered the development of the field of interactive medical simulation. However, in both contexts, a certain level of validation must be established before physicians can use such simulations, whether it is for planning a complex procedure or for learning basic surgical skills. The overall objective of a validation process is to guarantee that: (i) the numerical approximation of the mathematical equations chosen for governing the model is acceptable and (ii) the model provides an accurate representation of the physical behavior of the problem of interest within a given computation time. Both assumptions need to be verified within an assessment of error in the model predictions and their achievement relies on a combination of methodologies and experimental data.

A review on verification, validation and sensitivity studies was proposed in the context of computational biomechanics [Anderson 07]. In their paper, the authors present the concepts of verification and validation of biomechanical models and introduce a guide to realize such studies. In the context of medical simulation, only some papers have namely proposed solutions to test, compare and quantify the results of different modeling methods, in particular deformable models for soft biological material simulations. Alterovitz et al. [Alterovitz 02] suggested accuracy metrics and benchmarks for comparing different algorithms based on the Finite Element Method (FEM). Real data can also be used as reference models and experiment results have already been presented in the context of medical simulation. Among them, the Truth Cube experiment [Kerdok 03] or experiments on cylinders [Leskowsky 06] offer quantitative results, allowing the comparisons of modeling methods with real three-dimensional data. A comparison of FEM simulations with medical images was also proposed in [Chabanas 04].

All these papers aim at providing reference solutions for either verifying the numerical behavior of models with analytical solutions or validating them against real data. However, the proposed experiments are rarely shared and a methodology based on a combination of a protocol and associated measurements has never been defined before.

Approach

In [Marchal 08], we proposed a methodology and a framework for assessing deformable models. The methodology is a combination of analytical models and experimental reference objects that can test the ability of various algorithms to capture a particular deformable behavior. In addition, different metrics are proposed to quantitatively assess the accuracy of algorithms, as well as their computational efficiency. The proposed framework is based on an open source simulation environment where several algorithms are already implemented, thus making it a more consistent basis for comparing algorithms against each other and for validating them against reference models.

Methodology: verification and validation protocol Based on the guide proposed in [Anderson 07], the protocol for analyzing the performances of a deformable model can be decomposed in two main parts. The first part concerns the verification process of the modeling method. It aims at determining if the model implementation provides a correct description and a solution of the chosen modeling method theory. In this part of the protocol, the benchmarks used to analyze the performances of the model are mainly analytical solutions of well-known problems. Such comparisons have already been proposed in the literature, for example by [Alterovitz 02]. In a second stage called validation, the ability of the already verified model to bring a correct simulation of a real world object has to be guaranteed. In this validation part, computational predictions are compared to experimental data as a gold standard.

For both parts of the verification and validation protocol, different types of errors can be identified. The first type concerns numerical errors introduced by computational solving of intractable mathematical equations, among those discretization or convergence errors are very common. This type of error is mainly identified through the verification process. The second type of error can be called modeling error and is related to assumptions and approximations in the mathematical representation of the physical problem of interest. Such errors mainly come from geometry representation, boundary condition specifications, material properties or the choice of the governing constitutive equations. They can mainly be measured through the validation process.

Measurements and metrics In medical simulators, two types of objectives can be differentiated. A simulator can be dedicated either for a learning task or for the planning of a medical procedure. To validate a deformable model used for the simulation of a medical environment, different performances criteria have to be defined. In the context of medical simulation, we focus on two specific criteria: computational time and accuracy. These criteria allow the evaluation of both the interactivity and the precision offered by a modeling method.

To measure accuracy performances of the different modeling methods, two different types of metrics are proposed, depending on the type of available reference data. For both types, the error can be an absolute value, taking into account the displacement value or a relative value independent of the displacement of the simulated object. The first type of error metric is used if reference data contain markers (the mesh of an analytical solution or solid markers inside a phantom for example). The metric we proposed is a relative value called the relative energy norm error. This metric is commonly used in the FEM literature [Zienkiewicz 00]. Let \mathbf{u} be a vector containing the displacement of each point of a discretization of the reference solution and $\hat{\mathbf{u}}$ be a vector containing the simulated displacements of each point of a model (like nodes on a FEM model for example). The relative energy norm error η is defined as:

$$\eta = \|e\|/\|\mathbf{u}\| \quad (1.1)$$

where $\|e\|$ is the energy norm for the error between the two displacements \mathbf{u} and $\hat{\mathbf{u}}$: $\|e\| = \sqrt{(\hat{\mathbf{u}} - \mathbf{u})^T(\hat{\mathbf{u}} - \mathbf{u})}$.

If reference data do not contain any marker but give information about their global shape (curve, surface, etc), an other error metric based on a measurement of the distance between the reference and the simulated shapes has to be defined. Research works on image registration can provide good metrics. In this paper, we propose a simple distance as a first step for a metric framework. The measured distance corresponds to the minimal distance between the simulated points sampled on the surface of the simulated model and

the surface of the reference data along the normal. This distance can also be normalized by the simulated displacement for each point. The obtained value is realistic only for small errors between the simulated and the reference displacements. This second metric preferentially gives information on the surface of the simulated objects while the first metric provides measurements on the entire volume.

Computational efficiency is also an essential parameter to consider for the assessment of interactive medical simulations. When dealing with dynamic or kinematic systems, a first measure consists in determining if the algorithm can achieve true real-time computation, i.e. the computation time t_{comp} required for a given time step is less or equal to the time step dt used in the time integration scheme of the algorithm: $t_{comp} \leq dt$. Now, to guarantee interactivity, we also must verify that $dt \leq 1/F_c$ where F_c is a critical frequency (typically 25Hz when only visual feedback is considered, and hundreds of Hertz when haptic feedback is needed). With static or quasi-static equations, the real-time criterion $t_{comp} \leq dt$ is irrelevant as the simulation only consists of a sequence of equilibrium states which are independent of the time sampling. However, the second criterion remains necessary, even if defined differently as: $t_{comp} \leq 1/F_c$. Based on these criteria, the definition of a metric could be a combination of measures of these values, pondered by the simulation objectives. Of course, these criteria and metrics are not the only possible means of evaluating computational efficiency, as many factors influence the overall computation time of soft tissue deformation algorithms. Elements such as the integration scheme, the static or dynamic state of the resolution algorithm and furthermore the computer used to solve the simulations (with the use of a GPU based algorithm for example) can lead to variations in computational performances. However, measuring such computational performance can only make sense if it is performed within a common framework, to ensure a better impartiality in the measurements, as they are often used comparatively against other algorithms or methods.

Validation framework We introduced a framework in order to gather both reference models and metrics for assessing a given deformable model behavior. The chosen framework is an open source simulation environment SOFA where several algorithms are already implemented [Allard 07]. A validation environment was added to this framework, allowing to share different reference models (which are either analytical solutions or experimental data) and different solutions from existing modeling methods.

Results

We illustrated the use of the methodology with an example combining analytical solution, real data and different modeling methods. The chosen experiment was an elastic beam under gravity, fixed on one side. We compared the analytical solution, real data experiments and different deformable models. The experimental reference model is a cylindrical beam made of silicone gel. To obtain a material with nearly linear elastic properties, we used a silicon rubber called ECOFLEX (Ecoflex0030). The estimated Young modulus E is equal to 60,000 Pa and the Poisson ratio has a value of 0.49, as the material is considered as nearly incompressible. The beam was glued on one extremity to an inverted T-shaped vertical support made of plexiglas, and submitted to its own weight. It was then scanned in a helical CT scanner. Figure 1.1 illustrates the comparison between the experimental data and five different algorithms: (a) a linear FEM algorithm with a tetrahedral mesh, (b) a co-rotational FEM algorithm also with a tetrahedral mesh [Müller 04a], (c) a co-rotational FEM algorithm with a hexahedral mesh, (d) an algorithm based on 6 Degrees of Freedom Beams, (e) a mass-spring network.

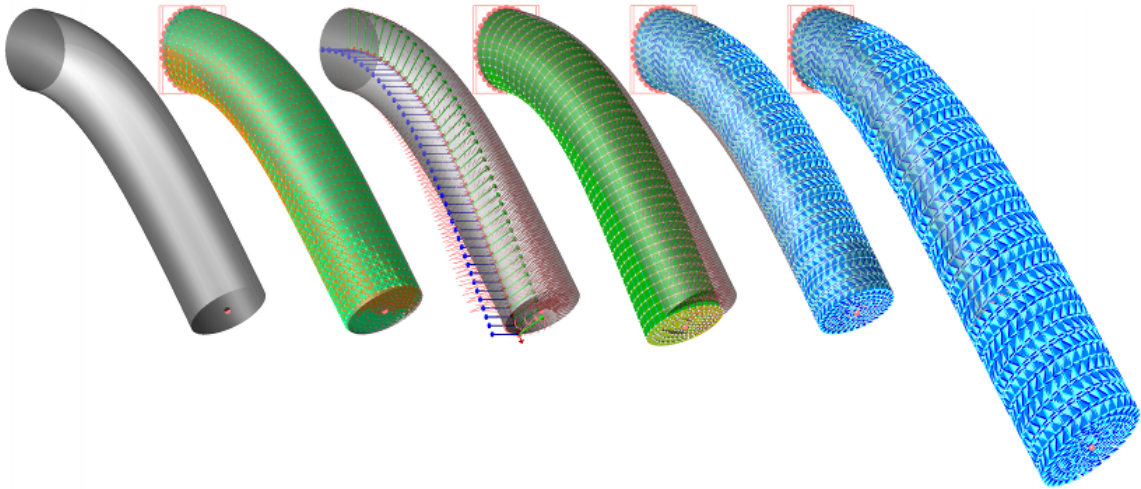

Figure 1.1 – Simulation results for the different modeling methods. From left to right: the experimental solution, the mass-spring network, the 6-DOF beam, the FEM Hexahedra, the FEM corotational Tetrahedra and the linear FEM Tetrahedra solutions.

The results confirm, through quantitative measurements, important points about soft tissue modeling algorithms. First, if the underlying model is not appropriate, it is impossible to capture the deformation of the reference model, no matter the choice of parameters. This is well illustrated with the case of the linear elastic FEM model which cannot handle large displacements. On the other hand, our examples also show that it is possible to obtain rather good approximations of a given behavior using different methods (mass-spring model, co-rotational FEM, beam model) all within a range of computation times compatible with interactive simulations. We can also see that even an ideal, analytical model will not give the exact same result as an experiment, some of these differences coming from errors on the various measurements done on the experimental model.

1.1.2 Evaluation of physical simulation libraries for haptic rendering of contacts between rigid bodies

Context

Building an application with an accurate haptic feedback is still challenging, especially for interactions between rigid bodies, where stiff contacts can only be displayed with a high simulation frequency. In [Glondou 10], we presented the evaluation of four physical simulation libraries with respect to haptic rendering quality criteria, based on their behavior in four discriminant test cases. The objective of the evaluation was to determine whether popular real-time dynamic engines are well-suited for haptic rendering, and to highlight their limits. The list of dynamic engines evaluated below is not exhaustive, but we tried to choose the dynamic engines that seemed the most promising to us. Moreover, we defined an environment for our experiments that was modular enough to be able to integrate any physical simulation library.

- Havok physics (<http://www.havok.com>).
- NVidia PhysX (<http://www.nvidia.com/>).
- Bullet physics (<http://bulletphysics.org/>).
- Open Tissue (<http://www.opentissue.org/>).

Approach

The four dynamic engines were evaluated following three performance criteria, and through four test cases. Two physical parameters were tested.

Performance Criteria We designed our experiments in order to measure the quality of haptic rendering through the three following performance criteria:

- **Computation time.** A stable and realistic haptic rendering needs high refreshment updates (see *e.g.* [Colgate 95]). It is commonly admitted that a haptic display that renders contacts and impacts between rigid bodies should be performed at about 1kHz.
- **Stability.** The stability of the simulation indirectly measures how laws of physics such as energy conservation are respected. Passivity of a virtual world [Colgate 95] (*i.e.* the fact that the world only dissipates energy) is a sufficient condition for ensuring its stability. Therefore, we made measurements of the variations of the total world energy to conclude on its stability.
- **Accuracy.** The accuracy indicates how well the physical phenomena (such as dry or sliding friction, bouncing, etc.) are reproduced in the virtual world. To give a mark for spatial accuracy, we performed spatial measurements of penetrations distances (using Euclidean distance between bodies centers as metric). We also visually appreciated the results based on reference simulations of the real world.

For each test case, we measured the average and maximum computation times, the sum of the total energy of all the bodies of the world, and we give a mark on the visually appreciated end state.

Tests Cases We used four discriminant test cases for the measurements of our performance criteria (the words in *italic* facing the name of the tests indicate which main criterion is measured through the test):

1. **Pile of 50 cubes** – *stability*. The classical pile of cube test (Figure 1.2a) is a challenging structure because of its contact disposition: naive iterative solvers have a very slow convergence rate in order to propagate the non penetration constraints [Milenkovic 01]. Also, this test measures the efficiency of the error correction due to interpenetration occurring.
2. **Seven-stages card house** – *friction accuracy*. The card house (composed of 89 cards, Figure 1.2b) is a structure that fully depends on an accurate simulation of friction phenomena [Kaufman 08]. If the friction is too much approximated or enforces penetrations, the card house is destabilized and collapses.
3. **8,000 cubes in a basin** – *computation time*. In order to check the scalability of the libraries, the third test consists in dropping 8,000 cubes in a basin (Figure 1.2c). A lot of objects are put in a high contact configuration (8 contacts per body in average), measuring the evolution of the timings of the solvers when the numbers of bodies and contact increase.
4. **Heavy block on a light block** – *efficiency of solvers*. This test puts Gauss-Seidel like solvers into slow convergence rate. If not enough iterations are used, or the correction methods are inappropriate, the upper heavy block penetrates the light one, and the system becomes unstable.

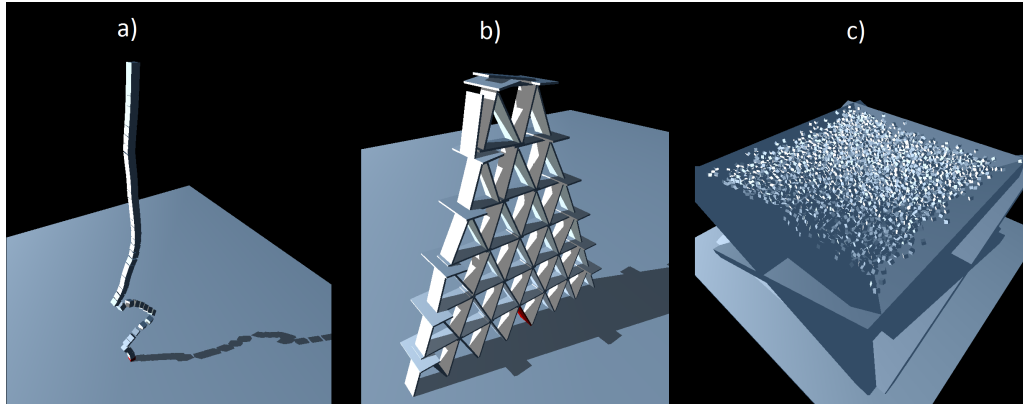

Figure 1.2 – Three test cases: (a) a pile of 50 cubes, (b) a card house composed of 89 cards, (c) 8,000 cubes in a basin.

Test Parameters Since our tests are related to rigid body simulation, we retained two physical parameters:

- **The coefficient of friction.** According to the Coulomb model of friction, the coefficient of friction μ tells that the maximum tangential force that can be applied to oppose tangential motion at a contact point between two rigid bodies, is $\mu \times f$, f being the magnitude of the normal force acting at the contact point to prevent interpenetration. We tested variations of the coefficient of friction from 0 (no friction) to 1 (high friction) for each test case in order to see its influence on the obtained results, and how well the dynamic engines handle it.
- **The coefficient of restitution.** The coefficient of restitution indicates what percentage of energy is conserved and dissipated during an impact between two rigid bodies (0 means a total inelastic impact, while 1 means a perfect elastic and bouncy impact). In contact resolution between rigid bodies, resting contacts are often separated from collision events and are treated using different algorithms. To decide whenever a resting contact or a collision occurs, the relative velocity between colliding bodies at contact point is often considered. Since the restitution coefficient has an influence on how relative velocities are modified, we chose to study the influence of the restitution coefficient on the simulation results.

Results

Concerning our results obtained for each of our performance criteria, for the four test cases previously defined, we believe that the collision detection system of OpenTissue slows down the simulation times drastically, and noticed that the stability of the simulation is lower than the other libraries. Therefore, we do not present the results obtained with OpenTissue since they are not comparable to the results obtained with the other dynamic engines.

Pile of cubes Havok physics brought the best results for the simulation of the pile of cubes. We obtained the best average computation times, and the best stability. It is possible to make the pile to stand up for time step going up to 1/60s. With NVidia PhysX, we noticed a visible penetration between cubes at the beginning of the simulation, followed by a counter reaction that destabilizes the pile which breaks before 5 seconds of simulation if a time step over 1/100s is used. Using tiny time steps (less than 1/800s), it is possible to make the pile to hold, but it never reaches a stable state, and small oscillations can be

observed. Bullet physics brought not as good computation time results as its competitors, and had similar results to NVidia PhysX for the stability criterion (we did not manage to make the pile hold more than 4 seconds of simulation for time steps over 1/100s). Using a null coefficient of friction, none of the engine enabled to make the pile hold. However, in this case, we obtained the best results with Havok physics that maintains the pile for more than 4 seconds of simulation against 1.5 seconds for NVidia PhysX, and less than 1 second for Bullet physics.

Card house Havok physics enabled to simulate the card house in a visually realistic manner, and with the best computation times. With a time step of 1/100s, and a friction coefficient of 1, even the top most stage of the card house remains in place. NVidia PhysX showed the same phenomenon as for the pile of cubes: after a penetration between the cards, a counter reaction occurs and the card house is destabilized. However, although the card house is maintained for a long time, it never reaches a stable state before the card house is almost completely broken (after more than 50 seconds of simulation). Bullet physics shows a weakness on this test case: its default solver can not handle properly dry friction. Indeed, whatever the coefficient of friction used, the cards slide and the whole house is broken at the beginning of the simulation.

8,000 cubes in a basin On this test case, we mainly measured the average and maximum computation times. For this simulation, we saw that Havok physics and NVidia PhysX brought very similar results. We noted however a slightly greater maximum computation time for Havok physics when the coefficient of friction is zero. Bullet physics is on the third place, with the highest computation times.

Heavy block on a light block None of the dynamic engines has been able to simulate visually plausible results for this test whenever the mass ratio between the two bodies is above 500 (see Figure 1.3, white body is heavy while the dark one is light). Actually, using a time step of 1/1000s and masses equal to 1 and 500, it is possible to reach a stable state with Havok physics where the heavy cube is resting on the light one, after several unnatural bounces. We did not achieve to have the same state using NVidia PhysX or Bullet physics with this mass factor. NVidia PhysX has a different behavior, allowing the heavy cube to penetrate the light one (see Figure 1.3b, middle). This makes the light cube in red becoming unstable, being randomly shook until it is ejected away from the heavy cube that does not move. With Havok or Bullet physics, the interpenetration is corrected in such a manner that the heavy cube (and the light one for Havok) bounces abnormally over the light one, until both cubes are separated by tangential forces. Using a bigger time step (1/60s), the heavy cube penetrates the light one, and the latter is pushed away horizontally.

Summary of the evaluation

We performed four discriminant tests, each of them was designed to measure one of the performance criterion. Figure 1.4 sums up the average timings for each of the three first test cases.

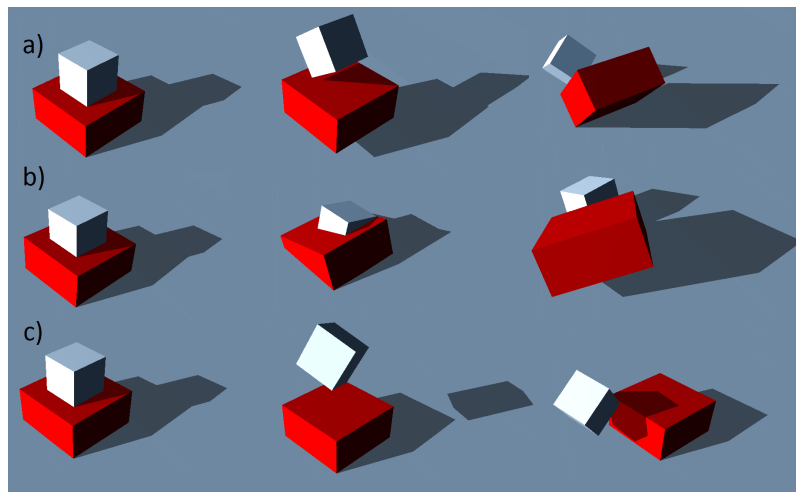

Figure 1.3 – Fourth test case. A heavy cube (white) is dropped on a light one (dark red), with a scale factor of 1000 on masses. (a) Results with Havok Physics. (b) Results with NVidia PhysX. (c) Results with Bullet Physics. Time step = $1/800$ s, Friction coefficient = 0.5, Restitution coefficient = 0.4.

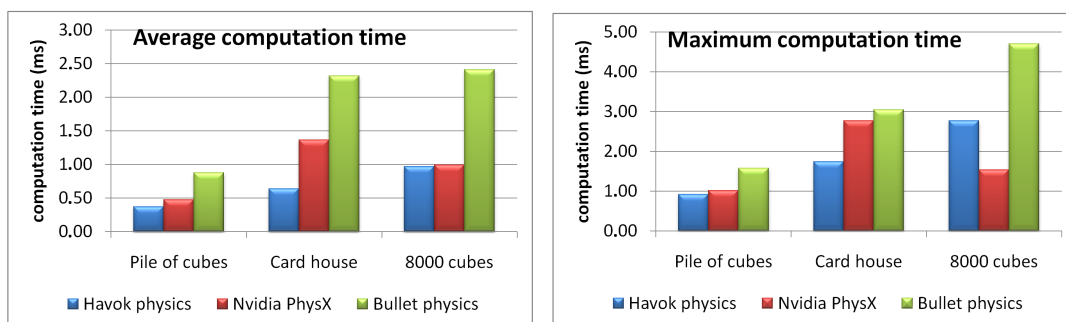

Figure 1.4 – Average and maximum processing times for the three first test cases.

We noticed that Havok physics has a small advance on computation time performance on NVidia PhysX, while Bullet seems to be less optimized. In average, we measured that it takes about 0.012 ms to solve for one cube in a contact configuration of 8 contacts per cube for Havok physics or NVidia PhysX, with our hardware configuration. Concerning the accuracy conclusion, we noticed that Havok leads to the more stable and accurate simulation, allowing to simulate the pile of cubes and the card house successfully. NVidia PhysX shows some weaknesses on those challenging structures, allowing an initial interpenetration that destabilizes the simulation further. Bullet physics does not seem to handle properly dry friction, making structure such as the card house impossible to be correctly simulated.

1.2 Design of phantoms

Since the validation of deformable models is crucial, especially when simulating soft tissues in the context of medical simulation, we especially focused our effort on designing phantoms to validate physically-based deformable models against real data. The second part of this chapter describes our contributions. Our work on a brain phantom is detailed while other phantom designs are briefly mentioned.

1.2.1 An anthropomorphic brain phantom

Context

In [Chen 10, Chen 12], we proposed a method for the design of an anatomically and mechanically realistic brain phantom from polyvinyl alcohol cryogel (PVA-C) for validation of image processing methods for segmentation, reconstruction, registration, and denoising. The human cerebrum is a topologically complex organ with deep fissures and sulci over its lateral and medial surfaces, as well as fluid filled ventricles of complex shape and form in its interior. The creation of a physical model capable of depicting the form of the cerebrum is not trivial due in part to these deep structures. Previous works in creating brain phantoms have either reduced the depth of the sulci [Surry 04], or only recreated the brain's form superficially with dessert gelatin molds [Reinertsen 06]. Although these phantoms bear a cursory resemblance to the human cerebrum, they do not accurately depict the gross anatomy of the brain. Registering these phantoms to their acquired multi-modality images may also not be straight-forward since the landmarks on the phantom are not easy to find or image. This may be due to the structures being smaller than the imaging resolution or having insufficient contrast of the markers in respect to the surrounding tissues. The objective of our work was to create a triple modality human brain phantom containing anatomically realistic structures and physically realistic texture.

Method

We proposed a method for the creation of an anthropomorphic brain phantom from polyvinyl alcohol cryogel (PVA-C). PVA-C is a material widely used in medical imaging phantoms for its mechanical similarities to soft tissues. The phantom was cast in a mold designed using the left hemisphere of the Colin27 brain dataset [Holmes 98] and contains deep sulci, a complete insular region, and an anatomically accurate left ventricle. The Figure 1.5 represents the PVA-C phantom casted from the Colin27 based brain phantom mold.

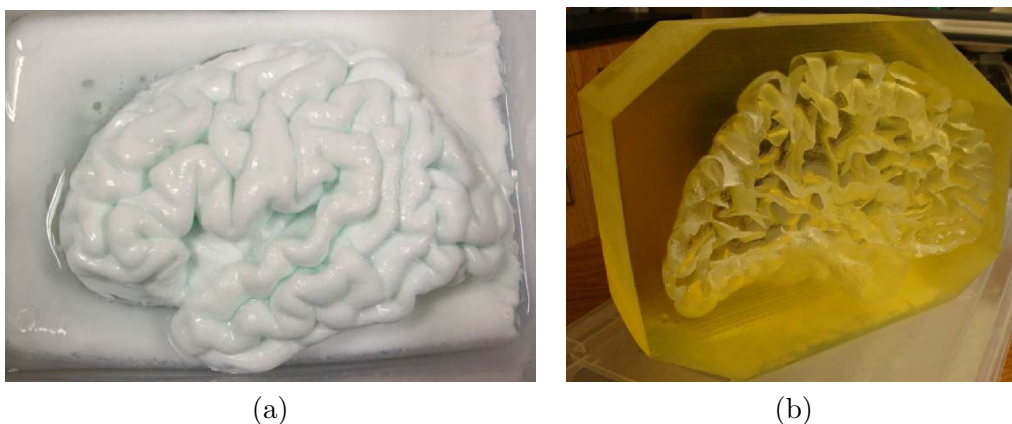

Figure 1.5 – (a) The PVA-C phantom casted from the Colin27 based brain phantom mold using our PVA solution. The deep sulci as well as the insular regions are represented in the phantom. (b) The flexible mold used for obtaining the phantom.

Recipes of PVA-C with textures most similar to human cerebral tissues were determined through the feedback of multiple neurosurgeons who know the tactility of the human brain and tumor tissues. PVA-C formulations that can be imaged effectively with good

contrast in Computed Tomography (CT), Ultrasound (US) and Magnetic Resonance (MR) imaging are used to construct the phantom and its implants. Marker spheres and inflatable catheters were also implanted to enable good registration and simulate tissue deformations, respectively.

Results

Three sets of images were acquired for relaxometry of the phantom tissues, for super-resolution image processing, and for imaging deformations in MR, CT, and US modalities. Examples of the phantom images are illustrated in Figure 1.6.

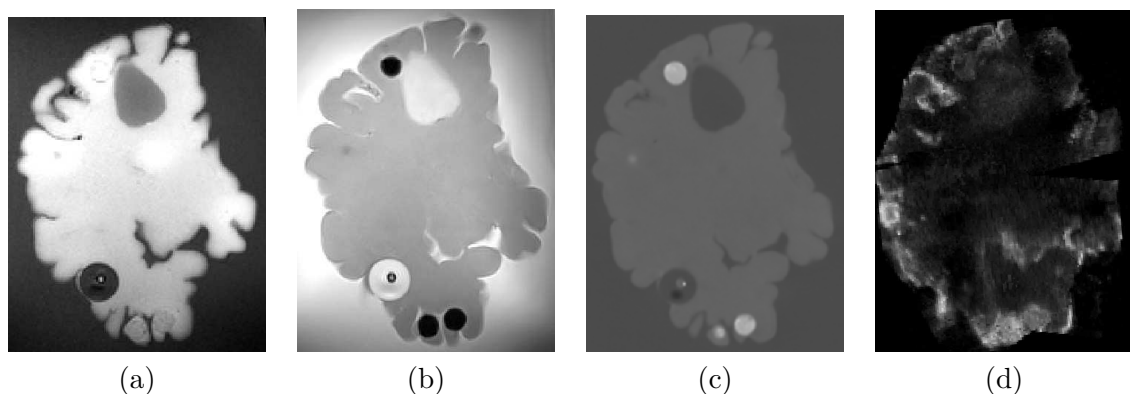

Figure 1.6 – A selection of PVA-C brain phantom images acquired using (a) MR T1-weighted gradient-echo, (b) MR T2-weighted, (c) CT and (d) reconstructed US.

After a series of imaging was acquired for the the modalities mentioned, the phantom is then deformed and the series of imaging is repeated. Deformation is done by inflating each of the two implanted urinary catheters in the phantom. The Figure 1.7 shows the phantom deformations at different inflations.

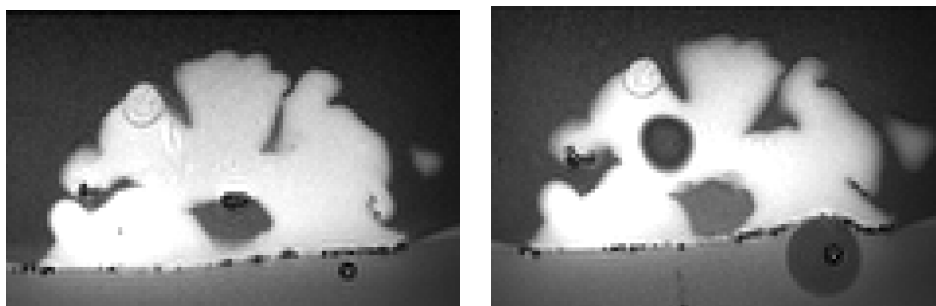

Figure 1.7 – The brain phantom is imaged with T1-weighted gradient-echo at different inflations.

The images acquired from this phantom are then made publically available to the larger image processing community (<http://pvabrain.inria.fr>). The acquired multi-modal images can now be used for validation of many image processing techniques such as segmentation, superresolution, image reconstruction, linear or non-linear registration, and denoising algorithms, using images acquired from one modality to act as the ground truth of another.

Aside from image processing, the formulation of the phantom material to approximate live cerebral brain tissue can be invaluable for improving implantation for deep-brain stimulators and simulating biopsy needle insertions. The accurate anatomy and texture

of the brain phantom as well as the low price of the starting materials can also make the phantom a useful educational tool in training medical professionals.

1.2.2 Other contributions on the design of phantoms

Since 2007, I have worked on the design of several phantoms. All of them are used for medical validation purposes. The different experimental protocols will be detailed in the following chapters. Some examples of phantoms are illustrated in Figure 1.8. The targeted medical gestures were: prostate medical gestures (biopsy and brachytherapy) [Dehghan 07a, Dehghan 07b, Dehghan 08], needle detection and tracking [Chatelain 13] and coil deployment [Dequidt 08].

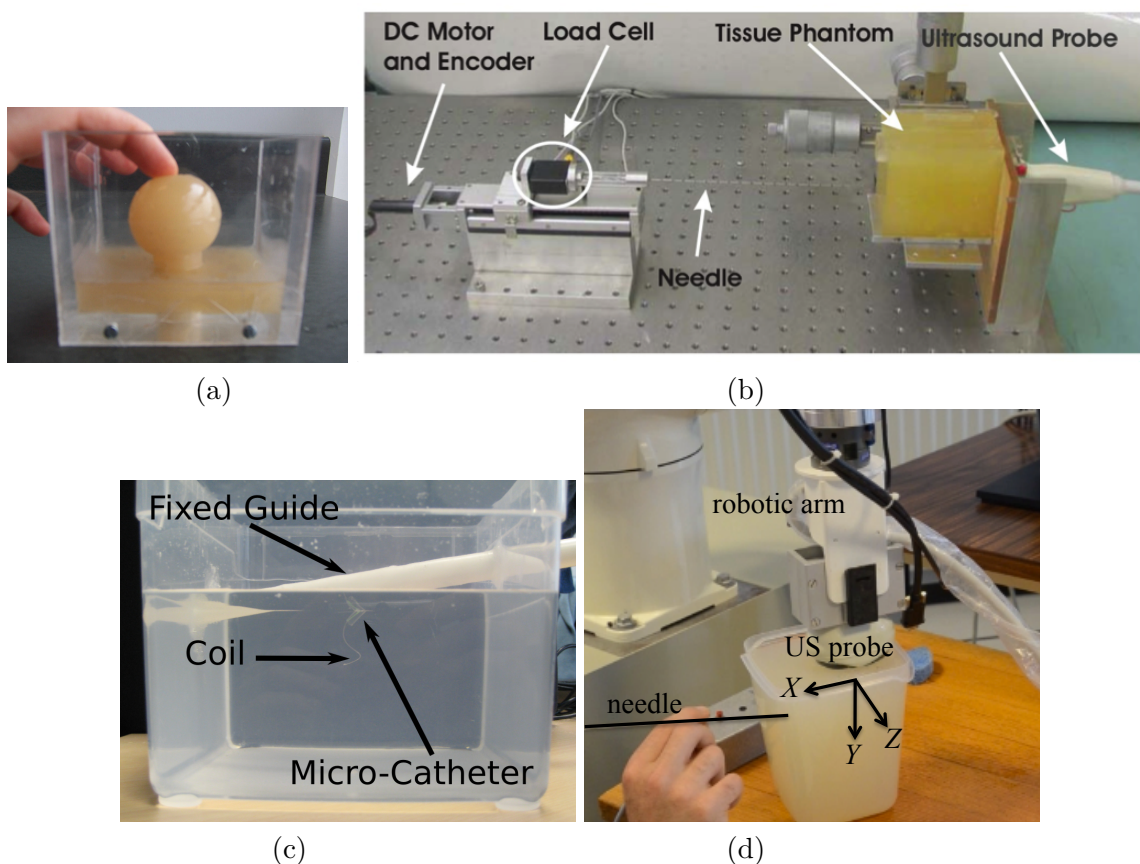

Figure 1.8 – A selection of phantoms designed during the last years: (a) prostate phantom [Dehghan 07a], (b) needle detection and tracking [Chatelain 13], (c) coil deployment [Dequidt 08] and (d) prostate brachytherapy [Dehghan 07b, Dehghan 08].

1.3 Conclusion

In this chapter, we have presented our research activities focused on proposing benchmarks and validation methodology for comparing physically-based models. The choice of the appropriate physically-based models to populate a virtual environment is highly dependent on the targeted applications, and therefore the validation is also intrinsically linked to the dedicated application. To be evaluated in a particular context, the model should generally be compared to other approaches in the literature or to real data.

Our contributions on this topic are decomposed in two main parts: we have first presented our propositions on validation methodology and then our comparisons with real data. The validation, through the introduction of metrics and benchmarks is the first key step of the validation process. Depending on the application, the performance criteria should be properly defined to perform valuable comparisons between physically-based models, analytical solutions and real data. The design of phantoms remains an essential challenge, especially in a medical simulation context. The phantoms should represent an appropriate geometry while its rheological properties should be carefully measured. Our contributions illustrate our attempt to generalize a validation step in our modeling work. This step is generally time-consuming and could be fastidious but rewards the modeling process through the comparison between the real world and the virtual one.

The work on a validation methodology for deformable models was a collaboration with Dr. S. Cotin, Dr. C. Duriez and Dr. J. Allard (Inria Lille). The comparison between rigid bodies physics engine was performed during the PhD of L. Glondu (co-supervised with Dr. G. Dumont). The brain phantom was achieved in collaboration with S. Chen and Pr. D.L. Collins (Univ. of McGill, Canada), Dr. P. Hellier (Inria Rennes), Pr. J-Y. Gauvrit and Pr. X. Morandi (CHU Rennes).

Topology modifications of virtual objects

2

Contents

3.1 Model and simulation of needle insertion	46
3.1.1 Medical context: prostate brachytherapy	46
3.1.2 Approach	46
3.2 Model and simulation of coil deployment	49
3.2.1 Medical context: coil embolization	49
3.2.2 Approach	51
3.3 Towards interactions through virtual deformable hands	53
3.3.1 Motivations for an interactive and physically-based deformable hand	53
3.3.2 An approach based on aggregate constraints	53
3.4 Conclusion	59

When simulating interaction between virtual objects with various physical properties, these objects generally collide and might undergo topology modifications. If we aim at interactive and realistic virtual environments, the simulations of these modifications need to face both computational and mechanical challenges. Both the simulation of the physical process and the managing of the various interactively-created objects are the key challenges of the models dedicated to the description of **topology modifications phenomena such as fracture or tearing**. In our work, we were interested in the **interactive simulation of these complex mechanical behaviors**, with the underlying objective of taking into account the real data specificities. We focused our contributions on two particular topology modifications: the brittle fracture and the tearing of fiber-based deformable objects, detailed in this chapter.

2.1 Novel models for real-time simulation of brittle fracture

As interactions between objects imply collision detection and topology modifications, we focused our efforts on both the design of real-time physically-based models and the management of the multiple newly-created objects in the virtual environments. In this section, our contributions rely mainly on the real-time simulation of brittle fracture.

2.1.1 Context, challenges and main contributions

Brittle fracture refers to stiff materials that undergo generally small and only elastic deformations before they fracture. Typical brittle materials are glass, ceramics, most concretes

or stone. One characteristic of brittle fracture is that the cracks propagations are very brief (cracks propagate at about 5,100 meters per second in common glass), and cannot be observed by a human eye. This fast propagation is due to the stiffness and the elastic properties of brittle materials.

Simulating brittle fracture in real-time on a physical basis has two main challenges that were not addressed before. The first challenge is the **modeling of fracture**, which must support several features. First, the deformation of the material due to impacts should be simulated, since it is the deformation of the material that will cause the cracks to propagate. Brittle materials such as glass or ceramics are stiff (common glass has a Young's modulus of 90GPa), and small time steps (in the order of the microsecond) have to be used to simulate a detailed deformation. However, the smaller the time step, the bigger the computational cost, which makes small time steps rarely compatible with real-time simulations. Therefore, there was no real-time method that proposes computing the dynamics of the deformations generated by impacts. Second, in order to reproduce the star crack pattern observed on a tile, the simulation model must handle non-constrained propagation of the cracks. However, existing real-time methods did not allow free crack propagation because of the computational and memory cost required by the current remeshing approaches.

The second challenge concerns the **efficiency of the simulations** for interactive applications. Aiming at real-time performances allows the simulation to be used in any interactive applications, especially with multi-sensory feedbacks. Also, the dynamic fracture of the bodies present unique challenges for the handling of the collision detection between dynamically generated fragments. Indeed, in fracture simulations, new bodies with unpredictable shapes are created at run-time, which reduces the chances for efficient collision pruning or prevents from any pre computation process.

Following these challenges, we introduced three main contributions to the real-time simulation of brittle fracture. The first contribution is the **definition of a fracture state model** that is designed to store the fracture information of the body. The design of this independent model allowed us to define an efficient propagation algorithm, with non-constrained crack direction, as well as an efficient meshing method for rendering [Glondu 13]. The second contribution is a **simulation method based on modal analysis** for the simulation of impact-based brittle fracture, allowing us to simulate the deformation of the brittle bodies in real-time [Glondu 13]. We also showed how age-based cracking can be efficiently simulated using our model [Glondu 12a]. Our third contribution concerns the introduction of **novel algorithms and data structures for collision detection** in real-time brittle fracture simulations [Glondu 12b, Glondu 14].

2.1.2 Modeling the fracture state of a brittle body and the crack propagations

In [Glondu 13], we proposed a model that stores the fracture state of a body based on three components: a damage state stored in the elements of a volumetric mesh, a fracture surface sampling stored in the edges of the same volumetric mesh, and a fragment identifier stored at each node of the mesh. The design of this model allows to have an accurate representation of the fracture state of a body, as well as defining the modifications of the fracture state due to fracture events. A propagation algorithm that updates the fracture state model based on an implicit surface definition of the fracture paths was also presented. The complexity of this algorithm is linear in the number of cut elements. An energy stop criterion based on the strain energy has also been proposed to stop the crack propagation and generates partial fractures. Figure 2.1 illustrates this feature and shows

the influence of the fracture toughness on the fracture propagation. We also described an efficient meshing algorithm that converts the fracture state into a set of surface meshes (one per fragments) ready to be displayed with classical 3D hardware. This results in an efficient representation of the fracture without constraining the fracture surfaces to follow predefined boundaries.

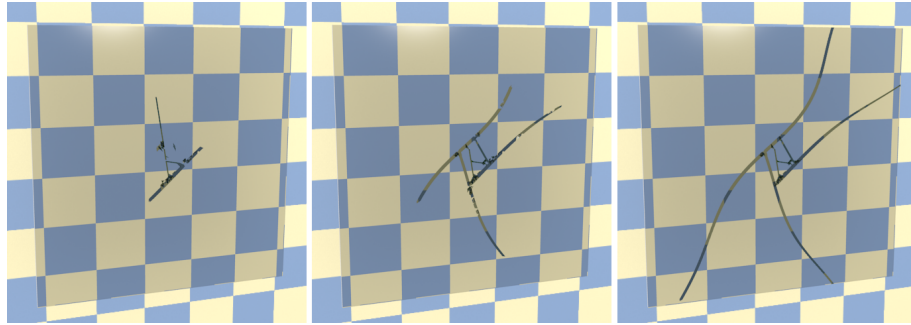

Figure 2.1 – Illustration of the energy-based criterion to stop the crack propagation using three glass slabs broken with different fracture toughness (the fracture paths have been highlighted during the rendering). The left slab has a toughness of 150 J.m^{-2} , the middle slab has a toughness of 90 J.m^{-2} , while the right slab has a toughness of 60 J.m^{-2} .

2.1.3 Modeling impact-based fractures

Approach

For the impact-based fracture, we presented in [Glondou 13] a new method based on modal analysis capable of estimating the contact durations, choosing adaptive time steps, and simulating efficiently the deformations of impacted bodies, taking into account dynamic effects such as inertia and damping.

Our brittle fracture simulation algorithm is the following: once a contact is processed between a pair of body, their deformations due to this impact is computed. Since we need to simulate small deformations of stiff bodies, we proposed to use a modal analysis to simulate efficiently the deformations. Therefore, prior to the simulation, a modal analysis is performed on each body that can fracture. Because the contact duration influences the fracture simulation, we propose to estimate it using the vibrational properties of the highest excited deformation modes of the body. Our contact estimation is an extension of Hertz’s model formulation of sphere-sphere contacts, using modal analysis:

$$t_d = c. \left(\left(\frac{2\pi}{Im(\omega_{max})} \right)^2 \cdot \frac{1}{v_{rel}} \right)^{1/5} \quad (2.1)$$

This formulation relates the contact duration t_d , the velocity of approach v_{rel} of the two bodies at the time of impact (c being a constant scalar) and $Im(\omega_{max})$ ($Im(x)$ is the imaginary part of the complex number x) the natural frequency of the mode max , the most excited mode of deformation. We choose the most excited mode because this is the one that will involve the greatest displacements during the impact. The frequencies $Im(\omega_i)$ of each mode depend on the stiffness (*i.e.* the material elastic properties), the mass, and the geometry of the body. Figure 2.2 illustrates our contact duration estimation method for a piggy bank with different stiffnesses.

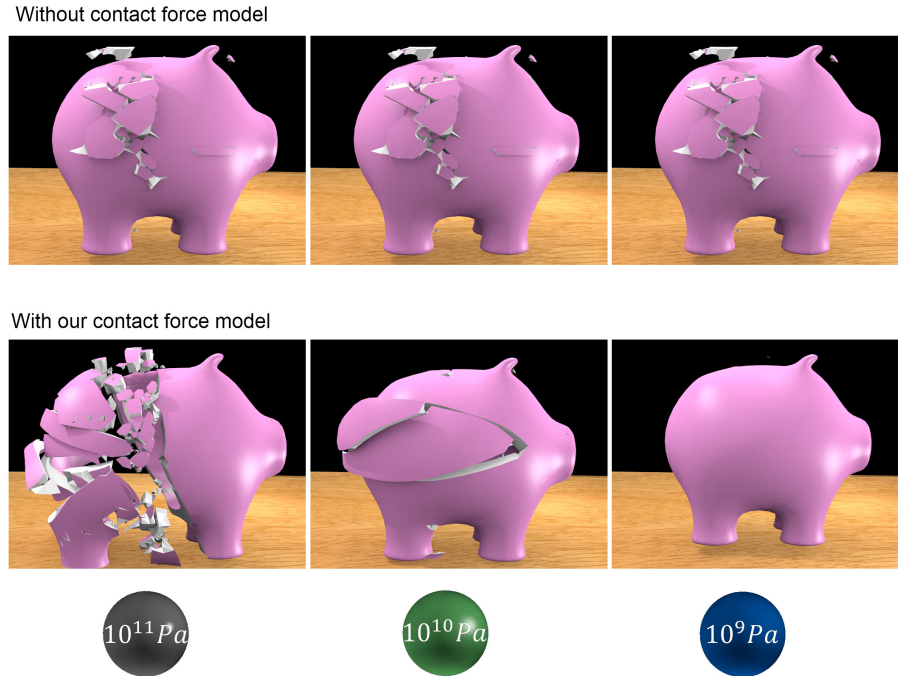

Figure 2.2 – Illustration of the advantages of our contact duration estimation method [Glondu 13]. A piggy bank is hit by balls of different stiffness. Top: no contact force model is applied. We use a quasistatic approach to model a single deformation state of the piggy bank from the rigid body impulse. The fracture is not influenced by the ball stiffness. Bottom: the contact duration approximation of our contact force model leads to higher local stresses when the ball has a higher stiffness. With a softer ball, the contact will last longer and the energy of the ball will be damped without generating any fracture. In that case, the fracture is influenced by the ball stiffness as expected.

We also choose an appropriate time step using the Shannon-Nyquist sampling theorem applied on the highest frequency modes in order to capture the main deformations of the body due to the impact. Results showed that our method has computational requirements compatible with interactive applications, and is able to reproduce dynamic effects of fracture that were not possible to simulate in real-time previously. Figure 2.3 illustrates these features and shows that our method is capable of simulating inertia and damping effects that influence the fracture simulation.

An extension to an age-based cracking algorithm

Impacts are not the only cause of the fracture of brittle materials. In natural environments and in cities, cracked stones or buildings are observed. These cracking phenomena are due to the modification of the material properties over time, and to external loading forces. In [Glondu 12a], we proposed an extension of previous aging methods to build a more efficient but still physically-based aging simulation of brittle fracture. Our method is based on a stress map that evolves over time. We also introduced an approximate stress relaxation technique that allows simulating stress relaxation around cracks fast enough to provide interactive simulations. Results demonstrate that our method produces visually realistic patterns that are applied at interactive rates on large scenes. Figure 2.4 shows an example of the state of a road experiencing a loading force at four different ages. It also illustrates our stress relaxation method that generates privileged cracking direction.

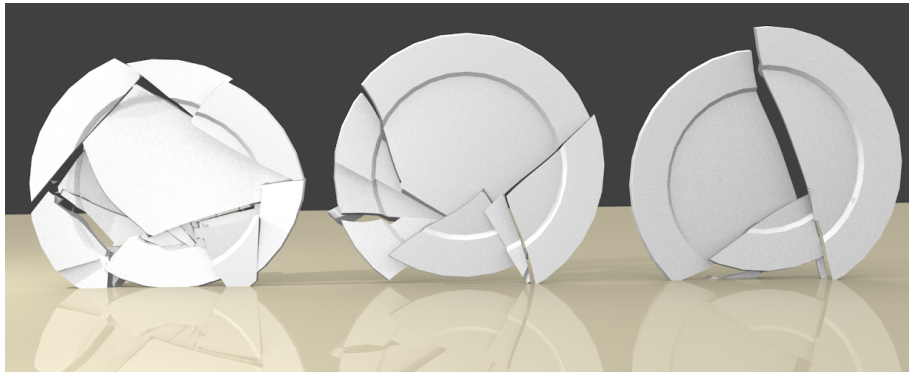

Figure 2.3 – Effect of damping on the fracture simulation. Our contact force model with modal analysis [Glondu 13] enables to model the inertia and damping of the plate. The left plate has the lowest damping value, letting high frequency modes to propagate and generate many small fragments. The right plate has the highest damping value, generating less fragments.



Figure 2.4 – From left to right and top to bottom: road model showing fracture propagation, simulating the course of time with our physically-based aging simulation of brittle fracture [Glondu 12a]. The inset is a photograph of a real road.

A database approach for fragment physics

One limitation of the modal analysis approach is the handling of fragments, for which no precomputation is possible. We addressed this problem with an approach based on a database of precomputed physical data [Glöndu 11]. Modal analysis is precomputed for a range of parametrized shapes, and stored in a database, labeled with mesh descriptors. When new fragments are created at runtime, their mesh descriptors are computed and a quick search is performed into the database to find the entry of the database that matches the geometry of the fragments. We showed that the database approach can be applied in real-time, and produces visually credible visual feedback, as illustrated in Figure 2.5.

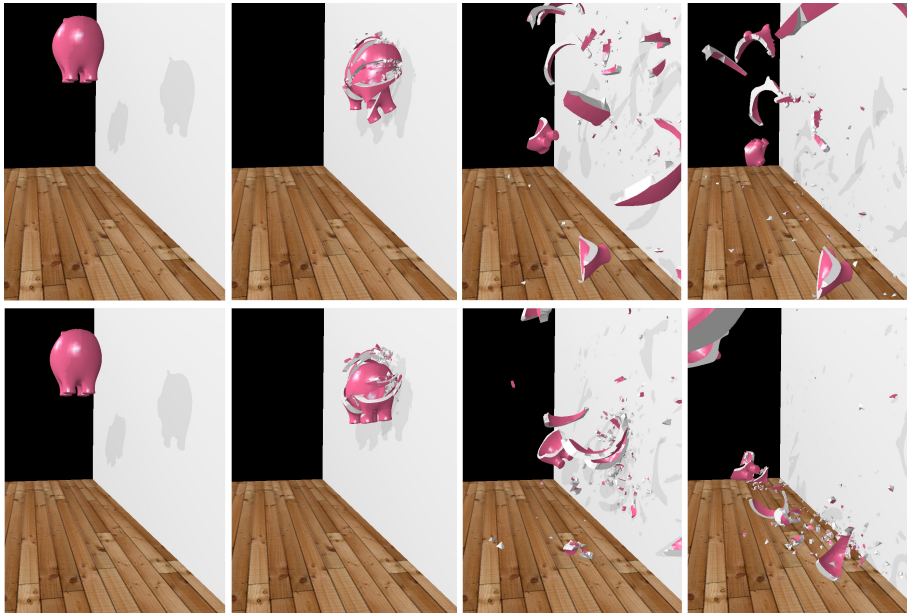

Figure 2.5 – Snapshots of a simulation of brittle fracture with modal analysis performed without (top) and with (bottom) our database method. Note the recursive fracture of the fragments generated from the first impact on the bottom animation that are not computed in the top animation.

2.1.4 Efficient collision handling for brittle fracture

In [Glöndu 12b, Glöndu 14], we proposed novel algorithms and data structures for collision detection in real-time brittle fracture simulations. As multiple object fragments collide and pile up when objects fracture, fracture simulations are indeed extremely collision intensive. There are mainly two major challenges on collision handling during fracture simulation. First, acceleration data structures for collision detection need to be created and/or updated at runtime, due to topology changes. Second, the newly created crack surfaces arise in parallel close proximity, which constitutes a worst case scenario for collision detection and response, with many surface primitives in contact, less chances for high-level culling, and no temporal coherence. Offline animations may afford spikes in the computational cost at fracture events, with the cost being amortized over the length of the simulation. But in interactive applications, simulation must comply with a maximum computational budget per time step, calling for efficient solutions at all simulation frames, particularly at fracture events.

In [Glöndu 12b, Glöndu 14], we presented an efficient solution for collision detection among stiff objects undergoing brittle fracture. A first major observation for our solution is

that, with very stiff objects, deformations are visually imperceptible. Therefore, for collision handling purposes, the objects can be treated as rigid bodies between fracture events. Hence, our approach to collision detection relies on well-known efficient acceleration data structures for rigid body contact, namely distance fields and sphere trees.

However, distance fields and sphere trees typically rely as well on constant topology, and suffer a heavy preprocessing cost. A second major observation for our solution is that brittle fracture can be considered to be instantaneous. Therefore, collision detection data structures may be updated only at fracture events. In our work, we proposed novel algorithms for fast reconfigurable distance fields and sphere trees. We presented a novel method to compute an approximate interior distance field for fracture fragments. Our method exploits features of fracture simulation and collision response algorithms to optimize its storage and computational cost. We presented an augmented sphere tree data structure, well suited for fast updates under fracture events.

The third major observation for our solution is that, at fracture events, the majority of the contacting primitives defines redundant contact constraints. We proposed a design of the sphere tree that lays the foundation for a simple self-adapting collision detection algorithm at runtime. It is executed as a part of hierarchical collision detection, not as a postprocess, thus enabling high-level pruning, and reducing the cost of both collision detection and response. Even though we apply our adaptive sphere tree in the context of fracture simulations, it is also applicable to more general simulations involving either rigid or deformable bodies.

Our results showed that good computation time performances are achieved with this method, and that scenes composed of non-convex objects and thousands of triangles can be handled in real-time, as shown in Figure 2.6. Our algorithms demonstrate also high performance in realtime user manipulation of fracturing objects.

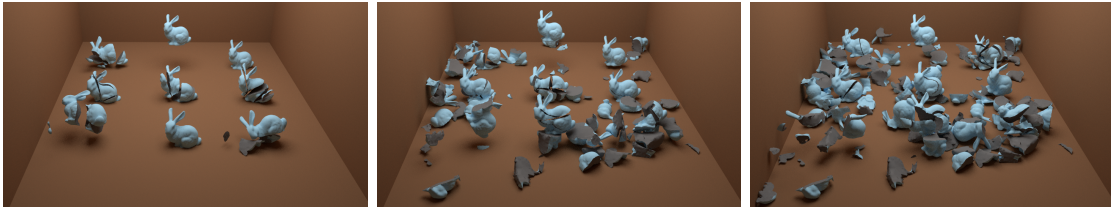

Figure 2.6 – Bunnies are dropped in three batches and fractured into 166 fragments and 435K triangles. The complete simulation runs at 24.5ms per time step on average, with a maximum of 81.5ms.

2.1.5 Preliminary validation of the impact-based fracture model based on real data

Finally, we proposed to validate the impact-based model for the simulation of brittle fracture with real experiments. We designed a benchmark where ceramic tiles and glass slabs were broken under different conditions. We measured the elastic properties and the resistance to fracture of ceramic tiles, and performed various breaking tests designed to validate individual aspects of the simulation (see Figure 2.7 for an example of a test benchmark). On the ceramic tiles, we observed statistically similar results between the tiles broken under the same conditions. The experimentations on the glass slabs were subject to noise introduced by weaknesses on the border of the slabs that made them break differently. We explored five different impact conditions to reduce this noise, and found that a flat support seemed to cancel the noise introduced by the borders, opening

perspectives for further exploration and experiments. Finally, we compared the results obtained in these experiments with its virtual version simulated using our impact-based model. We found that the star patterns observed in the experiments are also present in the simulation with a factor on the contact duration estimation. We also found artifacts present in the simulation that were not present in the real-life tests. These preliminary validation results were encouraging and helped us to understand better the strengths and weaknesses of our model.



Figure 2.7 – One of the test benchmark we designed for our validation experiments. Left: overview of the bench, a ball is dropped in the tube to fall on a tile set up on its support. Right: zoom on the aluminum support of the tile. To design a 4 punctual contacts test, 4 metallic balls were fixed on the top of the aluminum support.

2.2 Fiber-based fracture model for simulating soft tissue tearing

Medical context

Soft tissues behavior is often influenced by the presence of fibers. These fibers influence the deformation by introducing anisotropy, and impact the direction of propagation for the fracture during tearing. Our work was motivated by a medical application: the cataract surgery. A cataract is an opacity in the natural lens of the eye which represents an important cause of visual impairment, sometimes leading to blindness if not treated. The best treatment for this pathology remains surgery. Novel training simulation systems for cataract surgery have been recently developed. The main objectives of the simulators are to reproduce with great accuracy the three main steps of cataract surgery: capsulorhexis, phacoemulsification and implantation of an intraocular lens. In this work, we focused on capsulorhexis, the technique used to create a circular opening in the lens capsule, which relies essentially on the application of shear and stretch forces to propagate a fracture throughout the membrane.

Approach

In [Allard 09], we proposed a novel approach for simulating soft tissue tearing, using a model that takes into account the existence of fibers within the tissue. The approach relies on a continuous model based on elasticity theory for which specific fiber directions can be defined. The underlying finite element model (FEM) can handle geometrically non-linear anisotropic deformations at interactive rates. It is used in combination with an implicit integration scheme to enforce robustness of the deformation process. As many biological soft tissues are composite fibrous materials, additional information needs to

be introduced to enable realistic tearing: the principal direction of fibers within the soft tissue. Indeed, the orientation of these fibers highly influences the direction of propagation of the tear in the tissue. It also introduces anisotropy in the model. The proposed model for describing deformation and tearing of thin soft tissue such as membranes or capsules relies on a transversely isotropic FEM formulation using triangular elements, in which a specific fiber direction can be defined on each element.

During deformation of the tissue, the stress directions on each element are used to determine the tearing initiation. With an isotropic model, tearing within an element generally occurs when a threshold is reached. This threshold is the same in every direction, and a fracture criterion can be determined using an eigenvalue decomposition of the stress tensor in each element. If the largest eigenvalue is above the given threshold, the element is then fractured along a direction perpendicular to the eigenvector associated to the principal stress direction. This is however not applicable in the case of anisotropic materials, as the presence of fibers leads to preferred fracture directions. Also, the stress threshold is generally not identical along the fiber and transverse directions. Thus, we proposed a formulation of the fracture criteria based on the stress threshold in all directions of the stress tensor. In this formulation, we took into account two stress thresholds, one in the direction of the fibers and the other in the transverse direction.

Once an element has been selected as the candidate for tearing initiation, we introduce a criterion for computing the tearing direction. Fiber direction as well as the selected principal stress direction are used for the criterion computation. Since tearing tends to propagate from an already fractured location, we also account for the history of tear location and direction in the overall computation of the current tear direction. Thus, the fracture can be propagated along existing edges of the topology or across existing faces by using a remeshing algorithm.

Preliminary results

Figure 2.8 shows a preliminary simulation of capsulorhexis, illustrating the relevance of using an anisotropic model to support realistic soft tissue deformation and tearing. The membrane of the lens capsule is modeled as an anisotropic material and a co-rotational finite element formulation to allow for large displacements. Concentric fiber orientations are defined on the mesh to describe the actual structure of the lens capsule. An implicit integration scheme is used to enforce robustness of the deformation process. With this approach, realistic deformations can be computed in real-time, and tearing of the membrane can be simulated.

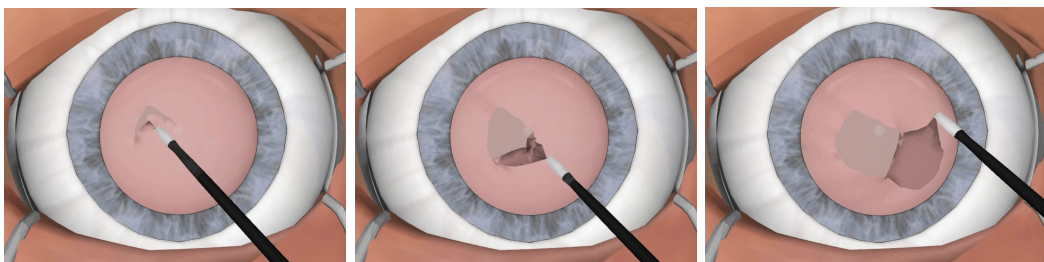

Figure 2.8 – Simulation of capsulorhexis during cataract surgery. The membrane of the lens capsule is teared by the medical instrument. Concentric fiber orientations have an influence on the tearing direction.

2.3 Conclusion

In this chapter, we have presented our contributions on topology modifications of virtual objects. Both computational challenges and physically-based behavior have been taken into account for proposing our novel models, focused on brittle fracture and soft tissue tearing simulations. The physically-based and interactive simulation of the topology modifications as well as the managing of the interactively-created objects are the key challenges of the models. In our work, we have particularly tried to introduce in our models real data characteristics, such as the mechanical properties. It thus opens a large range of interactive applications such as haptic or medical simulators where the comparison with the real world is essential. We have also recently started the validation of these models for different scenarios, with promising results. The validation methodology remains particularly challenging for the simulation of topology modifications since the fracture path can be evaluated at different perception levels: a macroscopic point-of-view with a global direction similar between two simulations or a microscopic point-of-view with very small geometrical details that need to be quantified. Our contributions illustrate our modeling as well as our validation efforts to obtain interactive and physically-based simulations that could be controlled through real data characteristics and parameter optimization process.

The contributions on brittle fracture are mainly related to the PhD of L. Glondu (co-supervised with Dr. G. Dumont). The work on soft tissue tearing is a collaboration with Dr. J. Allard and Dr. S. Cotin (Inria Lille).

Interactions through deformable instruments and hands

3

Contents

4.1	6 DoF haptic interaction with the different states of the matter	66
4.1.1	6 DoF haptic rendering of fluids	66
4.1.2	A unified approach for the manipulation of media with force feedback	67
4.2	Haptic sub-world: a coupling scheme for a high number of rigid bodies interaction	70
4.2.1	Context and motivations	70
4.2.2	Approach	71
4.3	The God-finger method for emulating a contact area during 6 DoF haptic interaction	73
4.3.1	Context and motivations	73
4.3.2	Approach	73
4.4	Conclusion	76

When designing VR applications, the simulation of the interactions of a user with a virtual environment represents a key challenge of the user's perception. The user generally interacts with the virtual world through a virtual instrument. Physically-based behavior of these instruments in interaction with the virtual objects is essential to provide to the users the resulting information of their gestures. If rigid objects remain the most used material for the virtual instruments, novel approaches can nowadays be envisaged to get **interactive simulation of deformable instruments**. In this chapter, we present our contributions on the simulation of deformable instruments in a medical context. For that reason, we have specifically focused our attention on the validation of our simulations against real data. We mainly worked on the modeling and the simulation of two specific medical instruments: the needle and the coil. These two instruments share common properties, both in their physical behavior and in the medical challenges of the user manipulating them. In terms of geometry, both instruments are indeed very thin and deformable. The main modeling challenge concerns the interaction with the soft tissue environment, which plays a key role for the planning of a medical procedure. To obtain an accurate simulation, we focused our effort in our contributions on estimating the model parameters using real data. For that purpose, we carefully performed validation protocols using phantoms and optimization methodology. In this chapter, we summarize the main characteristics of our modeling approach and our validation methodology through two medical applications: the needle insertion for brachytherapy and the coil deployment for coil embolization.

When interacting with virtual environments, the simulation of a realistic virtual hand is sometimes also well-appropriate for manipulating the virtual objects. However, as for the interactions with highly-specialized objects, the interactive simulation of a deformable hand faces computational challenges. The trade-off between realism and interactivity remains the main issue for the simulation. The hand model needs to be both physically-based and interactive to ensure sensorial feedback of the user. The last section of this chapter introduces our recent contributions to the **physically-based simulation of a virtual deformable hand** dedicated to grasping scenarios.

3.1 Model and simulation of needle insertion

3.1.1 Medical context: prostate brachytherapy

Prostate brachytherapy is a form of radiation therapy used to treat prostate cancer. It involves placing radioactive capsules inside the prostate and the surrounding tissue using a long needle with visual guidance from trans-rectal ultrasound and real-time X-ray fluoroscopy. The success of brachytherapy relies on the accuracy of the needle placement inside the tissue. However, due to prostate deformation and rotation, targeting errors are still common in brachytherapy and can result in under-dosed and over-dosed regions that can lead to repeated treatments or complications, such as impotence or urinary incontinence. Since visual feedback is limited, significant skill is required to compensate for tissue deformation and decrease targeting errors. Brachytherapy simulators and path planners represent new alternatives to train physicians and provide pre-operative planning. The modeling of needle-tissue interaction has already been proposed in previous work, like for example: [Alterovitz 03, DiMaio 03, Okamura 04, Crouch 05, Goksel 06, Hing 07]. The main novelty of our approach is to use the ultrasound imaging for tissue deformation measurement as well as the estimation of the model parameters.

3.1.2 Approach

In [Dehghan 07a, Dehghan 07b, Dehghan 08], we proposed a new experimental method in order to model needle insertion into soft tissues. The method consists of measuring tissue displacements with ultrasound radio-frequency (RF) data, measuring needle base forces, and using a deformation simulation model to identify the parameters of a needle-tissue interaction model. In our work, the model parameters were adjusted using the measurements of force-displacement data recorded during insertion of a needle into a non-homogeneous PVC phantom. The use of ultrasound imaging for tissue deformation measurement has several advantages: it is non-invasive and safe, it is the main imaging modality during many image-guided procedures such as prostate brachytherapy, and it does not require fiducial markers.

Experimental setup

An experiment was conducted to measure both the forces applied on a needle during its insertion into soft tissue and the resulting tissue displacements. The apparatus consists of a needle insertion device, allowing controlled insertion of a needle into a phantom, and an ultrasound machine used to track the tissue displacements (see Figure 3.1).

A non-homogeneous phantom composed of a harder inclusion surrounded by a softer tissue has been constructed for the experiments. The harder inclusion of the phantom -

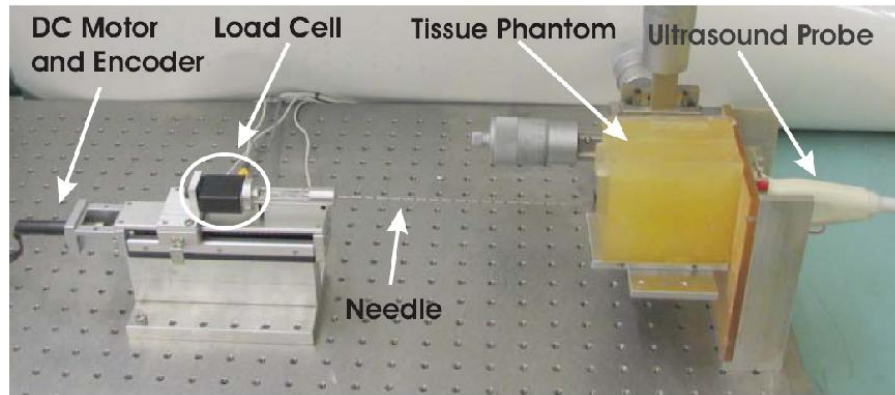

Figure 3.1 – The experimental setup: A brachytherapy needle is mounted on a translational lead-screw stage powered by a DC motor with an optical encoder. A proportional controller was used to control the speed of the heavily geared drive motor. The needle was mounted on a load cell (to measure the insertion and retraction forces applied on it). The non-homogeneous phantom is composed of a harder inclusion, mimicking the prostate, surrounded by a softer tissue.

designed to mimic the prostate - is a cylinder with two hemispheres at the two ends. This inclusion was made from polyvinyl chloride (PVC) plasticizer (M-F Manufacturing Co., Inc. Fort Worth, TX, USA). The inclusion was connected to the base with a cylinder of the same material to mimic the rotation of the prostate around the pubic bone. Cellulose (Sigma-Aldrich Inc., St. Louis, MO, USA) was added to the two parts as scattering particles. A cylindrical hole through the phantom represents the rectum. A stiff cylinder made of hard plastic was inserted into this hole to simulate the rectal probe and its effects on the motion of the prostate.

Both B-mode ultrasound images and digitized RF signals were acquired simultaneously with an ultrasound machine. The machine was synchronized with the computer, which controlled the insertion device and recorded the force data. The Time-Domain Cross-Correlation with Prior Estimates (TDPE) [ZahiriAzar 06] was used to estimate the tissue displacements from ultrasound RF signals. This method has the ability to estimate the displacements in real-time (see Figure 3.3.b). The RF correlation approach has demonstrated high resolution in elastography, hence high accuracy can be expected.

Force and displacement measurements

The needle was inserted with a controlled position. Figure 3.2 illustrates the different measurements achieved using our experimental setup. The insertion line was 5 mm out of the ultrasound field of view to avoid the deteriorating effects of a metallic object on the US images and to increase the accuracy of the tracking algorithm. The tissue phantom was meshed using tetrahedral elements to be used in a model based on the finite element method (FEM) (see Figure 3.3.a). Some of the mesh nodes were located in the ultrasound field of view. The axial and lateral displacements of these nodes were measured during the experiment. Due to the higher accuracy and resolution in the axial direction, only axial displacement estimations were used for modeling.

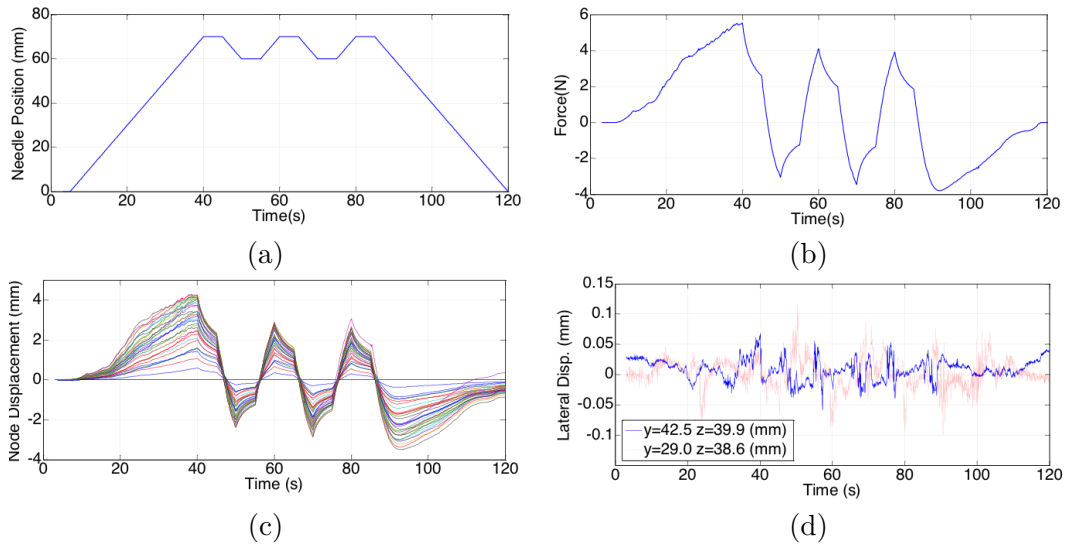

Figure 3.2 – (a) Needle tip position, (b) Measured insertion force, (c) Axial and (d) Lateral displacements of two sample nodes located in the ultrasound field of view. The legends show the initial location of the nodes. The needle was partially retracted and inserted again after the main insertion. Since in the second and third insertions the needle was inserted in the same path as the first insertion, no cutting occurred. Therefore, the second and third peak forces ($t=60$ and $80s$) are smaller than the first one ($t=40s$).

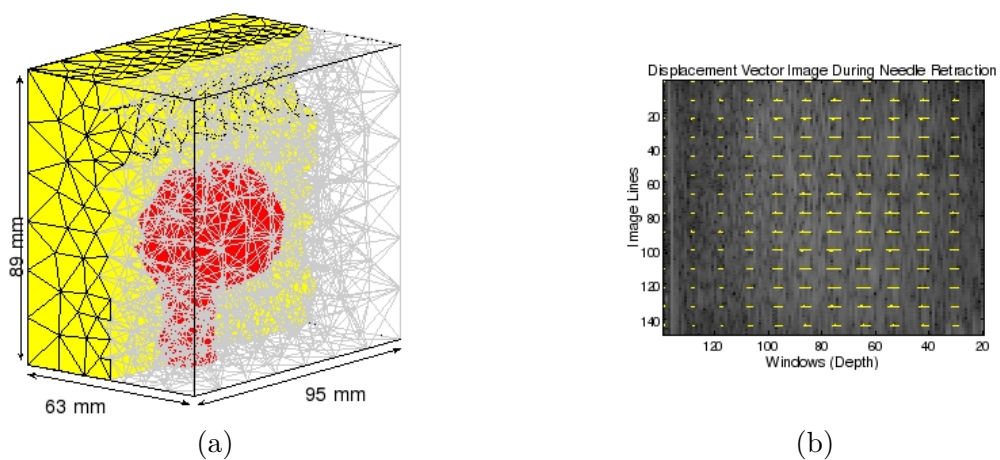

Figure 3.3 – (a) Tissue phantom meshed with tetrahedral elements and (b) estimation of tissue displacements using elastography.

Parameter identification of the needle-tissue interaction model

The objective of our experimental setup was to obtain force and displacement values to be able to identify the parameter values of the needle-tissue interaction model. To do so, we chose a force distribution to model the needle-tissue interaction. The parameter values of this model were identified using the force and displacement measurements recorded during insertion of a needle into the non-homogeneous PVC phantom. A FEM based simulation was used with the tissue phantom mesh previously generated to adjust the parameters and fit the simulated and measured forces (see Figure 3.4).

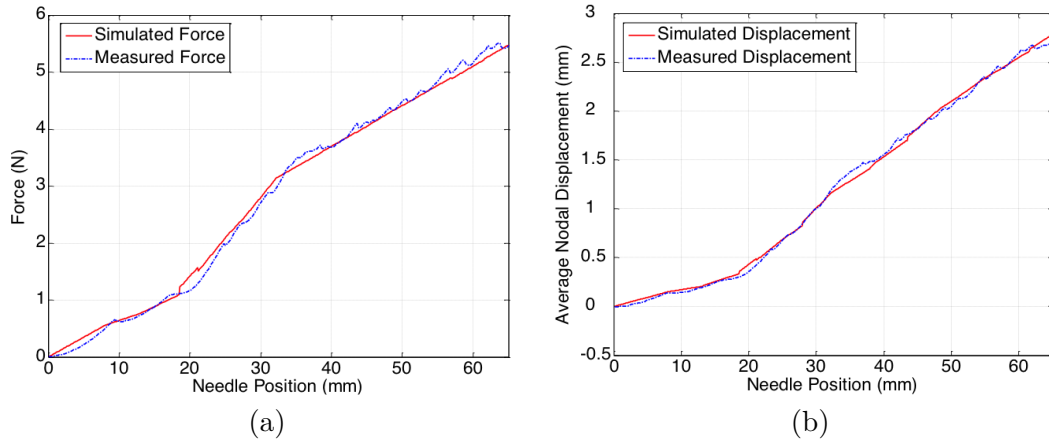

Figure 3.4 – (a) Simulated and measured insertion forces, (b) Simulated and measured average of nodal displacement in the axial direction. Only axial displacements are shown and were considered in identifying the model parameters.

In addition, the Young’s moduli of the tissues were adjusted to fit the simulated axial displacements to the measured axial displacements. The identified force profile and the elastic properties can then be used to construct an FEM simulator to simulate the needle insertion process. Our simulator is thus able to simulate in real-time the needle-tissue interactions. The main novelty of our approach is the use of ultrasound imaging for measuring tissue deformation. As it has the advantage of being safe and non-invasive, it could thus be envisaged to use it for measuring parameter values on patients.

3.2 Model and simulation of coil deployment

3.2.1 Medical context: coil embolization

Coil embolization offers a new approach to treat aneurysms and other blood vessel malformations in the body. This medical procedure is namely less invasive than an open-surgery as it relies on the deployment of a very thin platinum-based wire within the aneurysm through the arteries. The interventional radiologist starts by inserting a catheter (a long, thin and flexible tube) into the femoral artery. This catheter is then manipulated through the arterial system until the aneurysm location is reached. Once in position, the physician places one or more small coils through the catheter into the aneurysm. The body responds by forming a blood clot around the coil, thus blocking off the aneurysm and considerably reducing the risk of rupture.

When performed intracranially, this procedure must be particularly accurate and therefore carefully planned and performed by experienced radiologists. Yet, even in the case of

a successfully performed procedure, the choice of the coil (shape, length, diameter) plays a key role in the long term success of the procedure. In this context, the development of training systems or interactive planning systems, where the physician could select different coils and test their behavior in a patient-specific environment, could be very helpful.

Previous work in the area of real-time or near real-time simulation for interventional radiology has mainly focused on training. For instance, Nowinski *et al.* [Nowinski 01], Hofer *et al.* [Hofer 02], Alderliesten *et al.* [Alderliesten 04], or Duriez *et al.* [Duriez 06] have proposed different approaches for modeling either catheter deformation and more generally catheter navigation in vascular networks. However, besides [Alderliesten 04] none of these methods had been validated, and no real-time simulation of coils had been proposed nor validated.

3.2.2 Approach

In [Dequidt 08], we proposed an original modeling approach for interactively and accurately simulating very thin and flexible devices such as coils.

Real-time coil simulation

The coil model is based on a non-linear formulation to take into account the geometric nonlinearities and uses a shape memory formulation to describe its complex geometry. To model the deformation of the coil, a representation based on three-dimensional beam theory [Duriez 06], [Przemieniecki 68] is used. As the coil undergoes large displacements, we need to discretize it as a series of beam elements to ensure that each beam deformation will remain small. Since coils exhibit an important dynamic behavior during their deployment, we additionally added a dynamic formulation of the model. For the entire structure, the global stiffness matrix is recomputed, at each time step, by summing the contributions of each beam element, through its elementary stiffness matrix. The elementary stiffness matrix is a symmetric matrix that relates spatial and angular positions of each end of a beam element to the forces and torques applied to it. Boundary conditions are specified by imposing particular translation or rotation to the first node (base node), which is the way the surgeon interacts with the tool (by pushing and twisting the wire). An implicit integration scheme is used for the simulation.

Coils are not subject to elongation but mainly bending and twisting. They are also characterized by their rest shape which plays a key role in the delivery of the therapy. To simulate a coil being deployed from a micro-catheter, we avoid computing the complex interactions that take place between the coil and the micro-catheter. Instead we propose to simulate this behavior by using a composite model. The model is based on a geometric combination of the characteristic rest shapes of each beam model.

Parameter identification

Exact mechanical properties of coils are difficult to obtain since they are not shared by device manufacturers. The rest shape is one of the decisive parameter we need to identify because this feature is very important for embolization coils. An optimization algorithm was used to determine the Young modulus, Poisson ratio and to adapt the rest shape of the coil given some datasets of a real coil.

To do so, series of volumetric angiographic datasets of a coil deployment were used for an experimental validation (see Figure 3.5). A coil was released in contact-free environment with known boundary conditions. The coil was only subject to gravity. 3D shape of the deformed coil could be reconstructed from the analysis of 3D X-ray angiography images. Then, simulations of a coil submitted to the same forces and constraints were computed and compared to the actual coil data (see Figure 3.6). The error metric used to validate

the coil simulation is the relative energy norm error introduced in chapter 1. The error was small and exhibits that our simulation was close to real data.

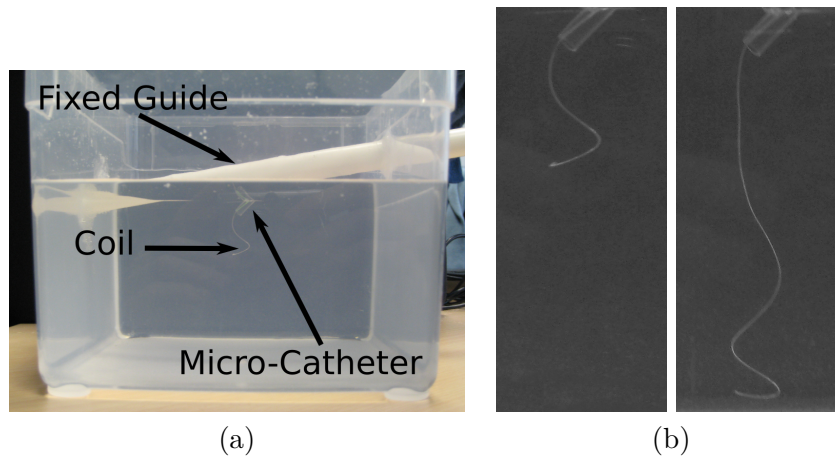

Figure 3.5 – (a) Experimental setup: the coil is deployed in a contact-free environment. The setup consists of a box filled with water and a transversal fixed guide, defining the path for the catheter. The catheter is first introduced, followed by the helical coil as in the real procedure. (b) Volumetric data is obtained by CT scan and a marching cube is performed to get a mesh of the real coil.

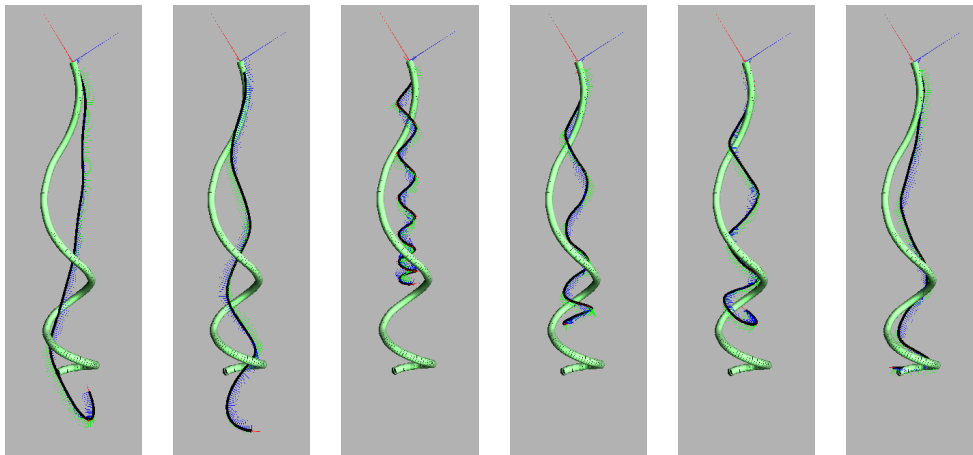

Figure 3.6 – Illustration of the optimization process to recover rest shape parameters of the coil. The real data are in green while the simulation data are in blue.

Thus, the experimental validation against real data and the errors measured proved the accuracy of the model. It offers a computationally efficient simulation of surgical microcoils. As the model is generic, we are also able to simulate other types of coils as the rest-shape formulation allows an easy way to generate complex geometric shapes.

3.3 Towards interactions through virtual deformable hands

3.3.1 Motivations for an interactive and physically-based deformable hand

One of the most natural and immersive ways of interacting with physically-based virtual environments in real time is the use of virtual hands that mimic the behavior of our own hands. But dexterous virtual object manipulation is a complex task that requires appropriate models of hand and contact mechanics to be simulated in real time. A common approach in virtual grasping is to model the hand as an articulated body made of rigid phalanges [Borst 05, Jacobs 12]. However, the human fingerpad is naturally soft, and produces large contact areas even when applying small forces, thus increasing grasping stability. Rigid fingerpad models complicate grasping due to small contact areas, notably when picking objects from sharp edges, and also require larger forces, often leading to sticking friction artifacts.

Modeling deformable fingerpads offer a solution to better reproduce friction between a hand model and virtual objects, but simulating soft fingers has its own difficulties as well. The softness of the fingerpads leads to a fast expansion of the contact surface at initial contact, which makes the resulting grasping more stable, but also increases the number of contact points, making computation more intensive. Moreover, precise friction models need to be computed at each contact point, which further increases the complexity of the system to solve. Unfortunately, solvers for frictional contact mechanics with deformable objects scale poorly with the resolution of the objects and the number of contacts.

Allard *et al.* introduced volume contact constraints for improving the performance of contact handling with deformable objects [Allard 10]. The method used volumetric collision detection in order to formulate contact constraints as penetration volumes between objects instead of penetration distances over several contact points. In addition, the number of constraints was not dependent on the resolution of the collision meshes, but instead on a regular grid which determined how the penetration volumes were divided. Despite its benefits in terms of efficiency, this approach suffers from two important limitations for grasping simulation. The first one is that pressure is uniform at all contact points aggregated into the same volume constraint, ignoring differences between contact against a flat surface, a curved surface, or a sharp edge. The second one is that friction acts only on linear velocities, not accounting for twists over the contact surface. In order to retain some pressure distribution as well as torsional friction between objects, the number of volume constraints needs to be increased, which in turn decreases the efficiency of the method.

3.3.2 An approach based on aggregate constraints

In [Talvas 15], we introduce novel aggregate constraints for the simulation of dexterous grasping. We formulate aggregate constraints for each phalanx, but we augment the volume contact constraint formulation introduced by Allard *et al.* in multiple ways, aimed at improving the computation of hand and contact mechanics during grasping, while maintaining efficient resolution of penetrations and realistic friction. Thus, we first introduced a method to compute a non-uniform pressure distribution within aggregate volume contact constraints. This non-uniform pressure distribution adapts to the local geometry of the objects in contact, hence it captures the grasping differences between flat and sharp surfaces. By doing so, we remove the need to divide the contact volumes to obtain the same results and thus further reduce the number of constraints involved to a total of 4 per

phalanx. The number of constraints is also independent from the discretization of collision meshes. We added torsional friction to aggregate volume contact constraints, with a minimal added computational cost. Our formulation is based on the Coulomb-Contensou friction model, and it allows dissipation of twist velocities between objects in contact, subject to maximum dissipation constraints. The different constraints are detailed below.

Volume-based separation constraints

The first constraint defined is a separation constraint, which ensures that no penetration occurs between bodies in contact, following Signorini's law. Usually, one separation constraint would be defined per contact point, leaving the solver to handle as many constraints as there are contact points given by collision detection. Here, we define the separation constraint as a single volume constraint for the entire contact surface instead.

In previous work, penetration volumes between each pair of bodies were provided directly by collision detection. Here we use more classical collision detection methods, which provide a set of contact points \mathbf{q}_i with penetration distances $\delta_{n,i}^f$ and penetration distance gradients (*i.e.* transpose of contact normals): $\mathbf{n}_i^T = \partial\delta_{n,i}^f/\partial\mathbf{q}_i$. We thus need to define a penetration volume from these contact points. To do so, we first compute for each vertex \mathbf{q}_i of the phalanx surface an area for the vertex: $S_i = 1/3 \times \sum_j S_{T_j}$ where S_{T_j} defines the associated area to neighboring triangle T_j . These vertex areas can then be summed to obtain an area for the entire contact surface: $S = \sum S_i$. We can obtain, for each contact i , contact volumes and contact volume gradients by using this area:

$$\begin{aligned} V_i &= S_i \delta_{n,i}^f, \\ J_{V_i} &= \partial V_i / \partial \mathbf{q}_i = S_i \mathbf{n}_i^T. \end{aligned} \quad (3.1)$$

These individual volumes and volume gradients are then summed to formulate a single volume constraint for both contacting bodies: $V = \sum V_i$ and $J_V = \sum J_{V_i}$ (Figure 3.7). The contact constraint is added to the constraint matrix. Signorini's law is then formulated as a complementarity relation. When solving in velocity, this means that the constraint force must be repulsive or null, that the volume must not increase, and that the constraint applies a pressure if and only if the penetration volume is null. The addition of this condition to the system leads to a mixed linear complementarity problem, which is then solved using an iterative method. For post-stabilization, the constraint ensures that any penetration volume is removed.

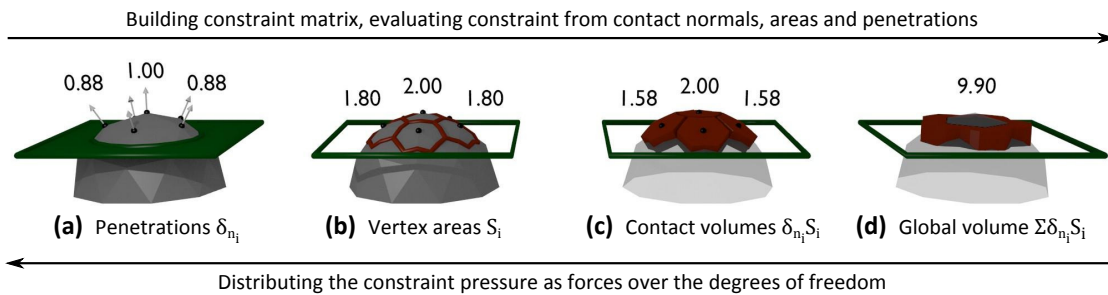

Figure 3.7 – Formulation of separation contact constraints as a volume constraint. (a) Two bodies in contact with penetrations evaluated w.r.t. contact normals. (b) Areas computed for every contact point from the local geometry. (c) Formulation of contacts as penetration volumes. (d) Summing these volumes to formulate a single constraint, which results to a corrective pressure upon solving.

Non-uniform pressure distribution

Using the aforementioned method, assuming meshes with sufficiently even topologies, the same force is distributed to all the points on the contact surface. However, an expected behavior would be that contact points with deeper penetrations would receive a higher force than others, as illustrated in Figure 3.8. This non-uniform distribution of forces can be re-established on volume contact constraints by weighting each contact point i in the formulation of the constraint by a factor w_i proportional to its penetration distance:

$$w_i = n_j \delta_{n,i}^f / \sum_{j=1}^{n_j} \delta_{n,j}^f. \quad (3.2)$$

where the contact point i with penetration distance $\delta_{n,i}^f$ belongs to a volume composed of n_j contact points.

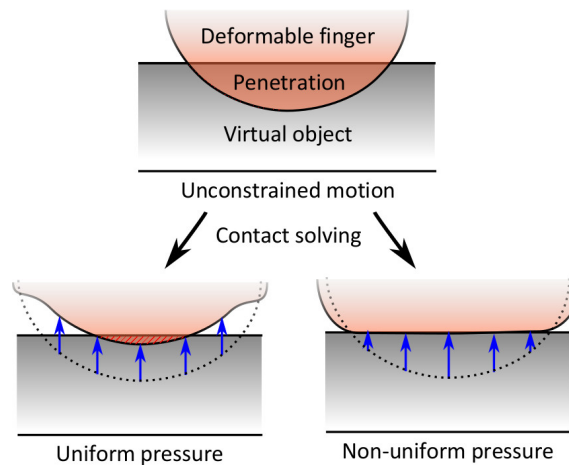

Figure 3.8 – Differences in contact solving with volume contact constraints using uniform and non-uniform pressure distribution.

Friction constraints

When an object is grasped with two fingers, torsional friction between the fingerpads and the object plays a key role in maintaining grasping stability. Using point contact constraints is sufficient to model regular tangential friction, and torsional friction is naturally obtained by accumulating all forces. With volume constraints, on the other hand, a naïve application of point-like friction constraints ignores all torsional friction.

We propose to incorporate an aggregate torsional friction constraint to each aggregate volume constraint, in way similar to regular tangential friction constraints, using the Coulomb-Contensou friction model [Contensou 63, Leine 03]. For simple deformable tissue such as finger phalanges, this allows to apply both tangential and torsional friction using a single set of 3 constraints per phalanx. The aggregation of torsional friction constraints is depicted in an example in Figure 3.9.

Regular Coulomb friction ensures that sliding velocity is either null or outside a friction cone defined by a friction coefficient and the normal force applied by separation constraints. Coulomb-Contensou friction extends this principle by taking into account the relationship between tangential and torsional friction: the faster an object slides along a surface, the less inclined it will be to rotate around the contact normal, and vice versa. This relationship

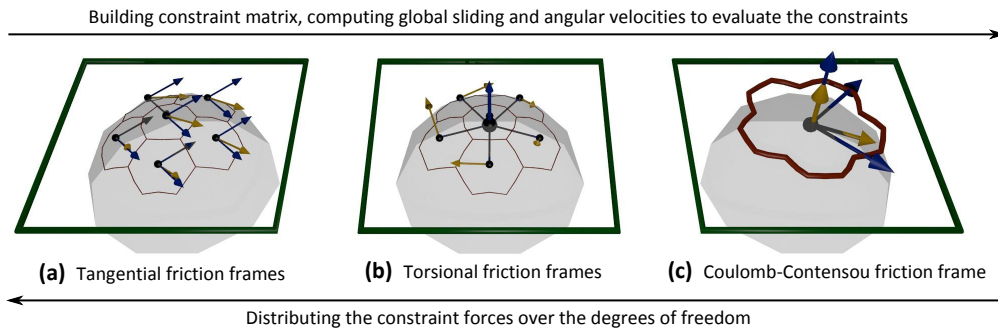

Figure 3.9 – Formulation of Coulomb-Contensou friction for the contact surface with our approach. (a) Individual Coulomb friction frames with sliding velocities at each contact point. (b) Torsional velocities evaluated from vectors orthogonal to the contact surface normal and lever arms between the contact points and their barycenter. (c) Summing these individual frames to evaluate linear and angular velocities for the contact surface.

is modeled by evaluating simultaneously the sliding and angular velocity over the contact surface against derivatives of a velocity potential [Leine 03].

Coulomb-Contensou friction constraints are defined as a complementarity condition, similarly to separation constraints. For tangential friction, either the friction force is strictly included inside the friction cone defined by the velocity potential derivative, in which case objects stick together, otherwise the objects slip tangentially and the force is on the border of the cone, along the direction of motion. For the friction torque, the condition is formulated in a similar manner, with either torsional sticking when the friction torque is within admissible values, or slipping otherwise.

Hand model

We propose a deformable hand model that leverages our aggregate constraint method for interactive grasping and dexterous manipulation of virtual objects. The hand model consists of 5 interconnected layers: tracked hand data, reduced coordinates model, mapped rigid body skeleton, deformable phalanges and surface collision/visual model as illustrated in Figure 3.10.

The tracked data is first stored as angular values at all joints of the hand, considering two degrees of freedom at the base of each finger (flexion and abduction) and one degree of freedom for both joints of each finger. The position and orientation of the palm are stored as well, to account for motions of the hand as a whole. The simulated hand is also first modeled in reduced coordinates, with 20 finger joint values and a 6 Degrees-of-Freedom base value. Stiff springs are used on each joint to make this hand model follow the tracked hand as closely as possible. Unilateral springs are used in absence of haptic feedback, but bilateral springs can also be used as a virtual coupling scheme if haptic feedback is provided to the hand and/or fingers. Joints are also assigned minimum and maximum angular limits, which are enforced using stiff springs once either of these values are exceeded.

A mapping function is then used to determine the position of the palm and phalanges of the hand skeleton from the reduced coordinates model. Forces and constraints can be mapped both ways using Jacobians and transpose Jacobians, as described in [Duriez 08]. This model thus serves as a proxy between the reduced coordinates model and 3D space. The deformable phalanges are modeled as coarse tetrahedral meshes, and simulated using linear corotational FEM [Müller 04a]. Nodes whose positions match the anatomical position of bones are linked to the mapped rigid body skeleton using bilateral springs.

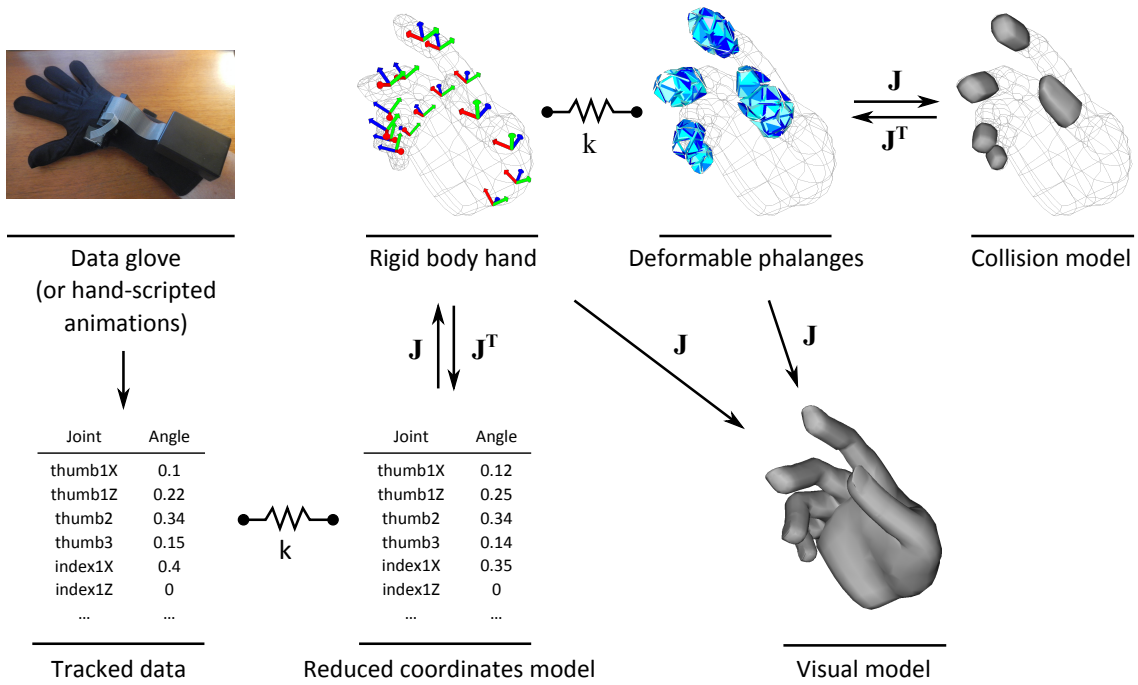

Figure 3.10 – Different layers of our proposed hand model. The reduced coordinates model follows the tracked data with springs, while the rigid body hand is mapped to it. The deformable phalanges are linked to the rigid hand with springs, and the collision models are mapped to them. The visual model is skinned from the rigid body hand and deformable phalanges.

The collision model is made of surface meshes for each phalanx, which are mapped to their respective deformable phalanges. Similarly to the mapping between reduced coordinates model and rigid body model, the use of transpose Jacobians allows to map contacts defined at skin level to the outer nodes of the underlying deformable model. The visual model also uses the same mapping function for the phalanges, and additionally uses regular skinning with linear blending for parts of the hand which are not given a collision model.

Illustrative results

Grasping a cube from its edges is a typical scenario showing the need for deformable fingers, as rigid fingers are unable to perform such a task due to the lack of a contact surface usually due to the deformation of finger pads. This scenario also showcases the importance of pressure distribution in our contact model (Figure 3.11.a). Uniform pressure over the contact surface is shown not to allow grasping of the cube from its edges, in a similar manner to rigid fingers. However, the weighting of contact points within the aggregate constraint restores the pressure distribution that would be expected with point contact constraints, and allows the cube to be lifted.

The Coulomb-Contensou friction model accurately represents both the friction forces and torques at fingers in contact, as shown when grasping a long object from one of its ends with two fingers (Figure 3.11.b). The object stays in a horizontal position as long as the fingers apply a sufficient force, and good control of rotations around the grasping axis is provided as well.

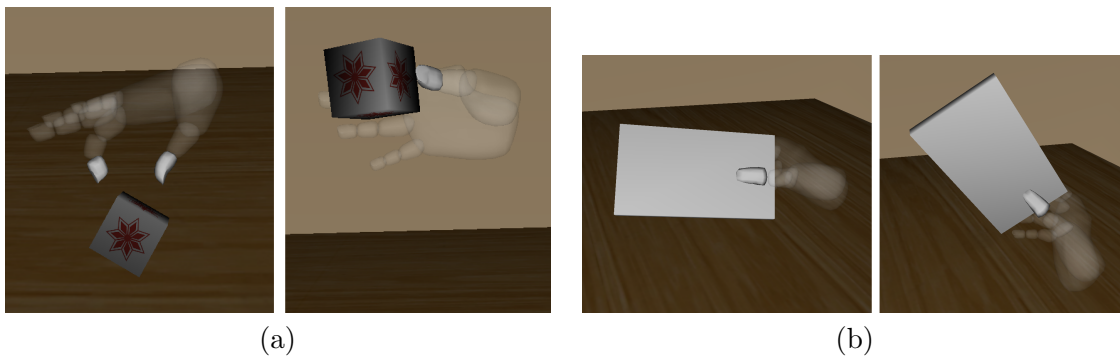

Figure 3.11 – (a) Grasping a cube from the edges with our approach: (left) uniform pressure distribution is not sufficient to lift the object, (right) non-uniform pressure distribution allows grasping. (b) Example of Coulomb-Contensou friction with our approach based on volume contact constraints. The fingers resist to moments around the grasping axis, and allow to rotate objects around that axis.

Our method is suitable for simulating more complex interaction scenarios as well, such as a rigid ball grasping scene with a full set of deformable fingers for one hand (Figure 3.12.a), or a dumbbell lifting scene with two hands (Figure 3.12.b), which are both scenes with a high number of degrees of freedom and contact constraints. More dexterous manipulation is also possible, as demonstrated by a pencil spinning scene (Figure 3.13): the pencil is picked from the table and rotated by almost half a turn by pushing it with the middle finger and thumb. Finally, our method is suitable for real-time interaction with data gloves, such as a full-hand interaction scenario with a deformable ball (Figure 3.12.c).

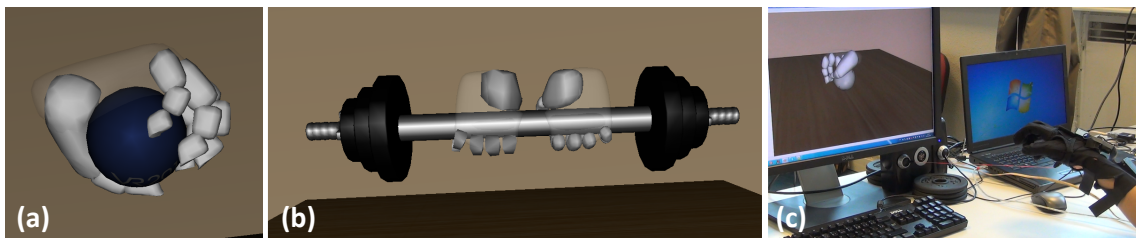

Figure 3.12 – Some object manipulation scenarios with our method. (a) Grasping a rigid ball with all fingers deformable. (b) Lifting a dumbbell with two fully deformable hands. (c) Manipulating a deformable ball using a data glove.

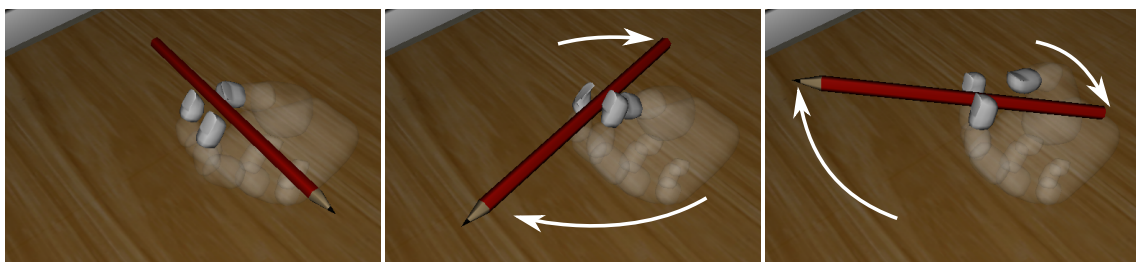

Figure 3.13 – Illustration of our aggregate constraint approach for dexterous manipulation of a pen using soft fingers. The pen is picked and spun with the hand modeled with soft fingerpads.

3.4 Conclusion

In this chapter, we have presented a summary of our contributions on the modeling of the interactions with virtual environments through virtual instruments or virtual hands. The simulation of the user's interactions represents a key challenge of the user's perception of the virtual worlds. Physically-based behavior of these instruments in interaction with the virtual objects is essential to provide to the user the resulting information of his gestures. It is particularly challenging in a medical context where the simulators should be conscientiously validated before their use for medical applications. In this context, we have proposed two contributions on the simulation of deformable instruments through two specific medical instruments: a needle and a coil. These two instruments share common properties, both in their physical behavior (thin and flexible instruments) and in the medical challenges of the user manipulating them. For both cases, we have specifically focused our attention on the validation of our simulations against real data, namely through the identification of the model parameters. Thus, we have carefully performed validation protocols using phantoms and optimization methodology. We have particularly paid attention to the use of non-invasive approaches for the measurements on real data, allowing potential future applications of the methodology for real patients.

If user's interactions with virtual environments are generally achieved through the use of virtual instruments, mainly for the ease of the modeling process, the simulation of a realistic virtual hand is sometimes also well-appropriate for manipulating the virtual objects. As for the interactions with highly-specialized deformable objects like the needle or the coil, the interactive simulation of a deformable hand faces computational challenges. In the last section of this chapter, we introduced our preliminary contributions to the physically-based simulation of a virtual deformable hand dedicated to grasping scenarios. Our novel model based on a formulation with aggregate constraints allows the manipulation of virtual objects that was not possible before, mainly because of the lack of interactive deformable modeling of the hand. It opens novel perspectives for real-time scenarios using complex virtual objects but also for the rendering of multimodal feedback to the user, as we will detail in the next part of this manuscript.

The contributions on needle insertion were mainly achieved during my post-doctoral position at University of British Columbia in the team of Pr. S.E. Salcudean. The work on coil deployment was realized during my post-doctoral position at Inria Lille. The virtual hand model is related to the PhD of A. Talvas, in collaboration with Dr. M. Otaduy (URJC Madrid, Spain) and Dr. C. Duriez (Inria Lille).

Part III

Multimodal Feedback with Complex Virtual Environments

Our research work on **multimodal feedback with complex virtual environments** is reported in the following chapters. We decomposed our contributions on 4 different chapters, following the global 3D interaction loop, as illustrated in Figure 3.14.

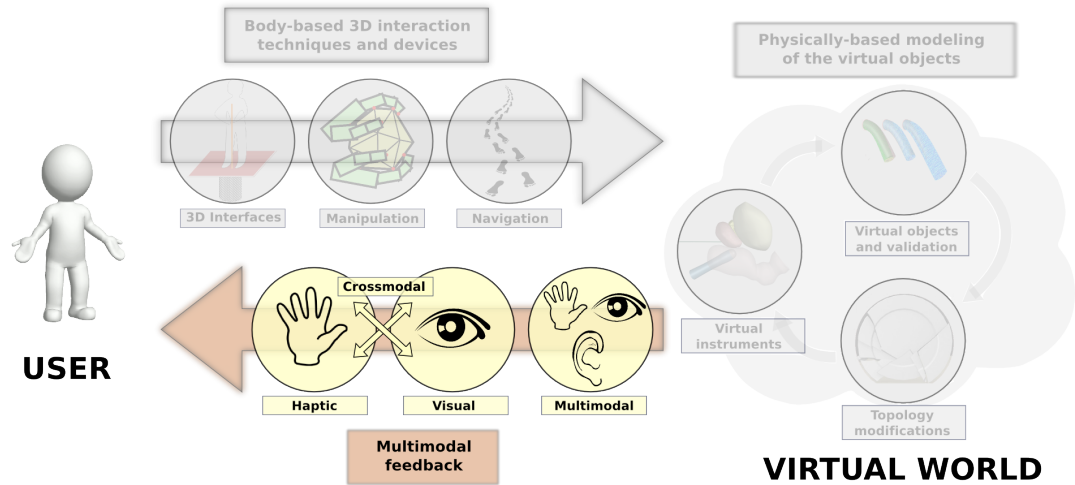

Figure 3.14 – Our second research axis is focused on the multimodal feedback of complex virtual environments. The axis is decomposed in four parts. (1) We were mainly interested in the haptic feedback. We aimed at rendering physically-based haptic sensations of complex virtual environments to the user, as detailed in chapter 4. (2) Besides the haptic feedback, the visual feedback remains the most used sensorial modality for rendering the interactions with the virtual environments. We describe in chapter 5 our contributions to the design of visual rendering of complex virtual environments, either through their size or their appearance. (3) Combining the sensorial modalities remains essential for VR applications. We present in chapter 6 our contributions on the design of appropriate models for synchronizing all the sensorial modalities. (4) VR applications could sometimes suffer from non-available hardware components. An alternative to multimodal feedback could be the use of crossmodal approaches, as detailed in chapter 7.

Outline

Touching or feeling objects when manipulating them is in our very nature, as virtually all tasks we accomplish in real life involve bodily interaction with the environment. When interacting with the virtual world instead of the real one, the addition of the haptic modality has also been proved to increase the user’s sense of presence. But to obtain realistic haptic feedback, we need to face computational and accuracy challenges. The rendering should both be interactive with a high frequency rate and rely on physically-based behavior to translate the mechanical properties of the virtual objects. In chapter 4, we describe our contributions on **physically-based haptic feedback of complex virtual scenes** such as different mechanical properties combined together, a high number of bodies in the virtual environment or multiple contacts through the user interaction.

Besides the haptic feedback, the visual feedback remains the most used sensorial modality for rendering the interactions with the virtual environment. If nowadays almost all VR applications have a visual feedback, there are complex scenarios where the rendering of the virtual environment remains challenging. If it especially the case if the virtual scene owns specific properties that could not be classically rendered. In chapter 5, we detail our contributions on **visual feedback for complex virtual environments**, such as wide field-of-view scenes or with highly-realistic representations of physical phenomena.

Most of the current VR applications require the design of multimodal feedback for the user. The main challenge behind simulating any virtual environment through different modalities is the need to simulate its dynamics at different temporal and spatial scales. Any combination of sensorial modalities requires both computational performances but also appropriate models for synchronizing all the modalities, depending on the scale of the chosen application. In chapter 6, we tried to gather different technologies to build **use cases of multimodal experience in complex scenarios**. In these use cases, we combined physically-based methods with 3D user interfaces to design multimodal VR applications for novel user experience such as the beach simulation or the walking on rugged landscapes. We have also particularly paid attention to the evaluation process through user studies in our examples.

If the haptic, visual and acoustic feedback are generally combined in VR applications to obtain a multimodal answer, VR technologies sometimes suffer from non-available hardware components, notably haptic devices. In chapter 7, we proposed alternative to classical multimodal approaches with the use of **crossmodal approaches**. Our objective was to overcome the limitations of VR hardware devices, in our case especially for introducing haptic sensations through the use of the visual and the auditory modalities. We illustrate our approaches with applications to both manipulation and navigation scenarios in a virtual environment.

Haptic feedback

4

Contents

5.1 Example-based fracture appearance	78
5.1.1 Context and motivations	78
5.1.2 Approach	78
5.2 Stereoscopic rendering of virtual environments with wide field-of-views .	82
5.2.1 Context and motivations	82
5.2.2 Approach	82
5.3 Conclusion	84

Introducing haptic feedback in our interactions with the virtual world opens novel simulation possibilities but also brings computational and accuracy challenges. The haptic rendering should both be interactive with a high frequency rate and rely on physically-based behavior to translate the mechanical properties of the virtual objects. In this chapter, we describe our contributions on **6 Degrees of Freedom (DoF) haptic rendering of complex virtual environments**. For each contribution, we focus our efforts on proposing novel approaches that propose both models providing physically-based behaviors of the interaction with virtual objects and solutions to obtain high rates compatible with haptic feedback. We also tried to tackle the issues related to virtual environments for which the complexity has made haptic feedback almost impossible to be implemented before. Thus, we propose to illustrate our approach through three contributions in this chapter. All the contributions are dedicated to 6 DoF haptic rendering. The first contribution is the **6 DoF haptic interaction with the different states of the matter**. Most current haptic simulations involve only rigid or deformable bodies. The introduction of fluid haptic feedback has been scarcely studied, as well as the haptic rendering of the different states of the matter in the same virtual environment. The complexity relies on the management of different physically-based models at the same time with an haptic rate. The second contribution deals with the design of an **haptic coupling scheme for a virtual world with a high number of rigid bodies interaction**. We propose a multi-resolution approach called *the haptic sub-world* to dynamically extract a subset of the global virtual world that can be simulated at a higher frequency into the haptic process. This approach allows to obtain the same haptic frequency for scenes with a highest number of rigid bodies, thus increasing the complexity of the virtual world that can be simulated. Our third contribution is called *the God-finger*. This approach computes a contact area from the collision information of a single contact point. The method aims at **simulating a fingerpad interaction** without using a complex deformable body simulation and thus better suited to achieve haptic rates. The approach allows 6 DoF haptic interaction with virtual objects with either point or complex virtual proxies. It also handles contact with deformable objects as well as with irregular surfaces. For the three contributions presented in this chapter, we first give a brief context and our motivations before describing our approach.

4.1 6 DoF haptic interaction with the different states of the matter

In this section, we first present our contribution on 6 FoF haptic rendering of fluids before extending it to the haptic rendering of the different states of the matter.

4.1.1 6 DoF haptic rendering of fluids

Context and motivations

Most current haptic simulations involve only rigid or deformable bodies. Fluids, on the other hand, have been scarcely studied, while being broadly present in our daily life, either through tools such as when holding a glass of water or directly with our body when we swim or we wash our hands. Fluids are also found in many applications such as for industrial or medical manipulations, involving for instance blood flow and natural liquids. Enabling haptic feedback in the interaction with fluids, besides allowing more realistic simulations, would enable a wide range of novel simulation scenarios and applications. However, achieving realistic, stable and real-time force feedback from fluids is particularly challenging. To simulate interactions between fluids and rigid bodies within haptic rendering, previous studies have proposed precomputed ad-hoc algorithms [Dobashi 06], approaches featuring only 3DoF and non-viscous fluids [Yang 09], or implementations restricted to simple object shapes and small amounts of fluid [Baxter 04]. Thus, as for today, there is a lack of models and rendering techniques handling complex 6DoF haptic interactions with viscous fluids in real-time.

Approach

In [Cirio 11b], we proposed the first approach to enable real-time 6DoF haptic interaction with viscous fluids through arbitrary shaped rigid bodies and 6DoF haptic devices. This represents a significant leap forward in interaction possibilities compared to previous work on haptic interaction with fluids. With previous approaches, real-time haptic interaction was restricted to simply “swiping” the surface of a fluid volume with simple objects, dramatically reducing the interaction possibilities when compared to real-life scenarios. Our fluid haptic rendering technique is based on Smoothed-Particle Hydrodynamics (SPH) [Monaghan 92] for haptic and fluid simulation [Müller 03]. SPH were introduced in the graphics community by Stam and Fiume [Stam 95] for gaseous phenomena, and Desbrun and Cani [Desbrun 96] for highly deformable bodies. Müller *et al.* [Müller 03] proposed the first approach for fluid simulation using SPH. Our approach is the first attempt to bring the SPH model to the haptic fluid realm.

The SPH fluid simulation is based on particles carrying different physical properties, such as mass and viscosity, discretizing the fluid volume. These particles have a smoothing radius, a spatial distance defining a neighborhood around them. Physical quantities, such as density and interaction forces, can be computed for each particle through the weighted sum of the relevant properties or quantities of the particles inside its neighborhood. The weight of the contributions of a neighbor particle depends on its distance to the treated particle, and is defined in a function called smoothing kernel. In our approach, the forces generated when an external particle is inside the Smoothing Volume of an entity are SPH haptic forces, as illustrated in Figure 4.1.

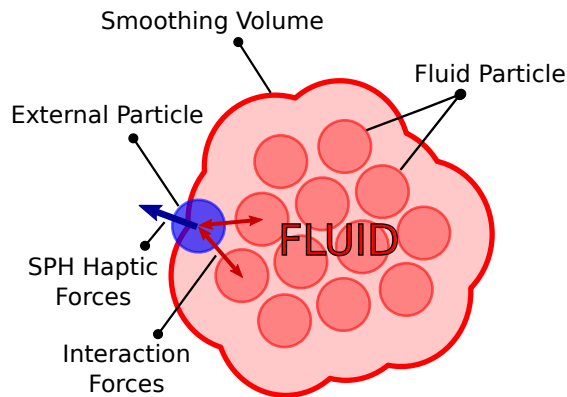

Figure 4.1 – Smoothing Volume and SPH haptic forces. The Smoothing Volume of a volume of fluid is defined by the sum of the smoothing volumes of each particle belonging to the fluid. When an external particle enters the Smoothing Volume, SPH haptic forces are seamlessly computed between the external particle and the fluid particles whose smoothing volume contains the external particle.

Our haptic rendering technique uses also a new haptic coupling scheme and a unified particle model allowing the use of arbitrary-shaped rigid bodies. Rigid bodies can be simply and efficiently modeled with the same SPH particles used in the fluid simulation. This allows to use the SPH model for the computation of forces between fluid and rigid body particles, removing the need of additional collision detection algorithms. In addition, since interactions are computed between particles, the overall shape of the rigid body is not important. Hence, the unified particle model allows the seamless use of arbitrary-shaped rigid bodies, including concave objects. Particularly, fluid containers can be created to hold fluid and hence transmit to the user force feedback coming from fluid stirring, pouring, shaking and scooping, to name a few. Figure 4.2 illustrates the unified model and the computation of the rigid body dynamics. We proposed also the GPU acceleration of the underlying fluid and rigid body model to achieve real-time speeds. In addition, we adapted an existing visual rendering algorithm to meet the frame rate requirements of the haptic algorithms.

Illustrative use case

We designed different example scenarios to illustrate and evaluate some of the interaction possibilities offered by our approach. One of this scenario is illustrated in Figure 4.3. We showed how many rich and complex fluid manipulations are now easily achieved, with stable force and torque outputs. Interaction is no longer limited to 3 degrees of freedom, with torque feedback playing a major role in providing a compelling feeling of realism. Among these are the use of concave containers to hold fluid and hence transmit to the user force feedback coming, for example, from fluid stirring, pouring, shaking and scooping, as well as the inertia of the fluid inside the container.

4.1.2 A unified approach for the manipulation of media with force feedback

Context and motivations

Complex VE are not restricted to only one type of media. Generally speaking, they usually involve simulating several types of media at the same time. In the graphics and simulation realm, media can be defined by three states of matter: rigid bodies, deformable bodies

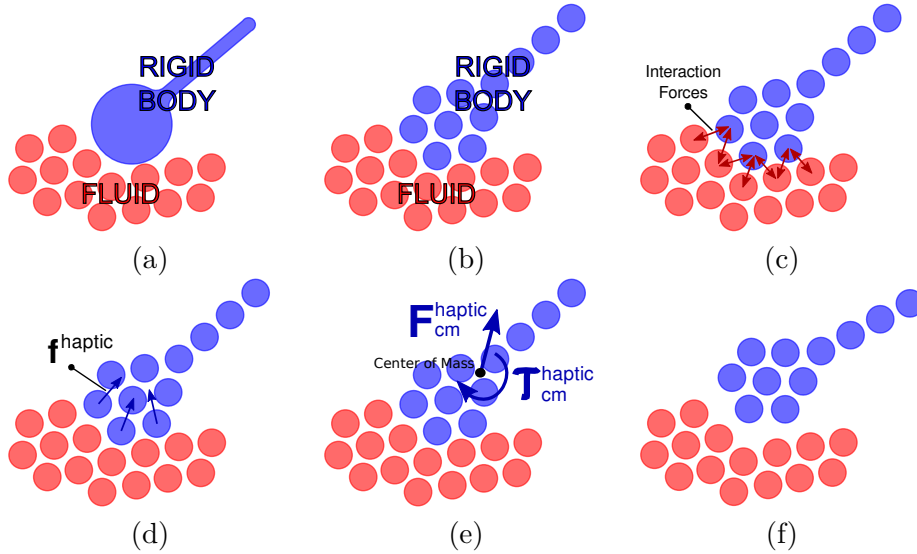

Figure 4.2 – Illustration of the computation of forces acting on a rigid body. A spoon and volume of fluid (a) are modeled with SPH particles (b). Fluid particles act on the spoon particles (c), generating an SPH haptic force f^{haptic} per spoon particle (d). These forces are summed resulting in a total force and a total torque applied at the center of mass of the spoon (e). Spoon particles are updated according to the new position and velocity of the spoon (f).

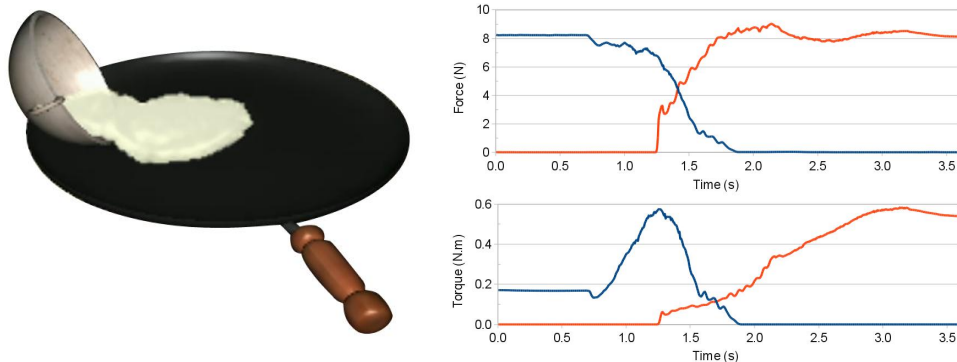

Figure 4.3 – An illustrative scenario featuring our 6 DoF haptic rendering with fluids. (a) A bowl and a pan, each coupled to a 6 DoF haptic device, are used as containers: fluid is being poured from the bowl into the pan, making the fluid mass shift between both rigid body containers. (b) Plot of the force (top) and the torque (bottom) of the bowl (in blue/dark) and the pan (in red/light) during the pouring motion of some fluid.

and fluids. Current physically based haptic techniques only focus on two states at most, thus limiting the interaction possibilities with complex VE. Furthermore, having the three states in the same haptic simulation poses several challenges, in terms of computational demand and coupling mechanisms: specific haptic rendering approaches are used for each media, and specific interaction mechanisms are required between different media.

Recent work on physically based simulations has shown that the SPH framework is general enough to encompass the equations of continuum mechanics. However, update rates are usually not real-time, or fall short for haptic interaction. In [Müller 04b], deformable bodies are modeled in real-time with SPH and the Moving Least Squares (MLS) algorithm to compute the elastic forces. The approach is improved in [Keiser 05], allowing solid, deformable and fluid animation and interaction in a unified approach. A fully SPH-based approach is presented in [Solenthaler 07], later corrected in [Becker 09] for a rotationally invariant formulation.

In [Cirio 11a, Cirio 13b], we introduced the first approach that provides physically based haptic feedback for fluid, deformable and rigid states of matter in the same simulation. We conducted a perceptual experiment to evaluate our approach by assessing the capability of users to recognize the different states of matter they interact with. Results showed a high recognition rate, even when providing only haptic feedback, and the increased appreciation of users when combining haptic and visual cues [Cirio 11a].

Approach

Our approach extends our SPH haptic fluid interaction approach for the inclusion of deformable bodies alongside fluids and rigid bodies, thus providing a generic haptic coupling and rendering mechanism for 6 DoF haptic devices. Based on the SPH model for all three types of media, our method avoids the complexity of dealing with different algorithms and their coupling. The approach is enhanced with state change mechanisms, friction forces and multistate proxies. Thus, the proxy object, coupled to the haptic device, can be of different states, while inducing and undergoing state changes. Haptic rates are achieved through a dual GPU implementation, using separate GPUs for haptic and visual rendering tasks, thus reaching the frequency thresholds for a good haptic perception. The physically-based simulation of the virtual world is governed by fluid and elasticity theories. An scenario illustrating a cooking simulator is shown in Figure 4.4.

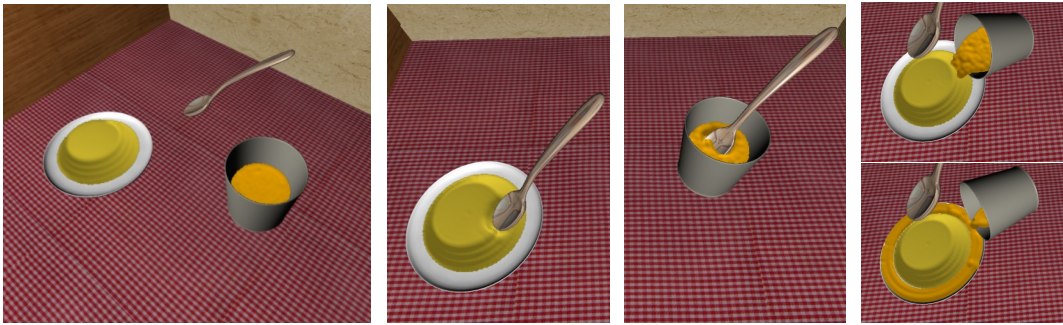

Figure 4.4 – Scenario illustrating a cooking simulator. The user, through a spoon coupled to the 6DoF haptic device, can touch and play with a custard tart, a glass and its liquid content. Haptic feedback is seamlessly computed for the three states of matter simultaneously.

Illustrative use-case

To showcase the main features of our approach, we developed a complete use-case: a virtual cooking simulator [Cirio 11c]. It is a training and entertaining 2-handed interactive application that simulates the preparation process of a crepe. The user holds two virtual objects, a bowl and a pan, through two 6DoF Virtuouse haptic devices from Haption, as shown in Figure 4.5. The simulation guides the user through all the steps required to prepare a crepe: from the stirring and pouring of the batter to the spreading of different toppings on top of the crepe. By preparing virtual crepes, users can experience 6DoF haptic interaction with fluids of varying viscosity, and also with deformable and rigid bodies.



Figure 4.5 – The virtual crepe preparation simulator: the user pours some batter (a high viscosity fluid) from the bowl and into the pan. The user can feel the forces and torques from the pouring movement, as well as the weight shifting between his hands as the batter goes from the bowl to the pan. Maple syrup could also be poured on the crepe.

4.2 Haptic sub-world: a coupling scheme for a high number of rigid bodies interaction

4.2.1 Context and motivations

For an accurate and realistic haptic feedback, the haptic device must receive orders at high frequencies, especially to render stiff contacts between rigid bodies [Colgate 95]. Therefore, it is often considered to create two processes in haptic rendering applications: one for the physical simulation, and another one for the haptic rendering. The simulation process extracts at its rate a so-called intermediate representation [Adachi 95] from the virtual

world. This intermediate representation is a simplified and local model of the world that is exploited by the haptic process to generate orders at frequencies allowing good haptic rendering quality. It remains however challenging to connect the two processes, especially when a high number of objects in contact populates the scene.

In [Glondou 09], we presented a multi-resolution approach for haptic rendering between rigid bodies. The main idea of our new coupling scheme is to dynamically extract a subset of the global world and to build a second physical world as an intermediate model. We call this second physical world the *haptic sub-world*. The haptic sub-world is built from a limited number of carefully selected bodies, and can therefore be simulated at a higher frequency into the haptic process, as depicted in Figure 4.6.

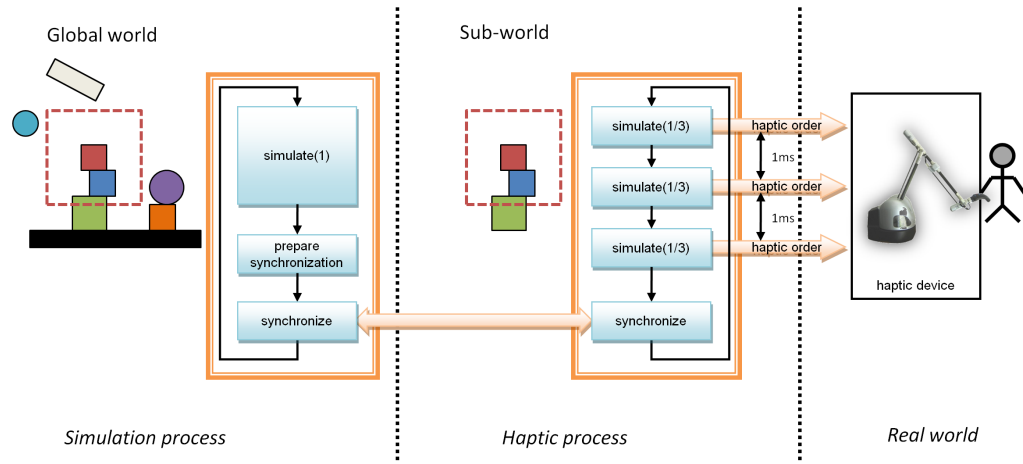

Figure 4.6 – Haptic-sub world main algorithm. The simulation process simulates the global world once with a time step of dt , while the haptic process simulates for example 3 times its haptic sub-world using a time step of $1/3 \times dt$. At the end of the haptic cycle, the two worlds are synchronized, exchanging bodies positions and efforts information.

4.2.2 Approach

Principle of the haptic sub-world

We define the haptic sub-world as a subset of the bodies of the world that is simulated at a frequency allowing a good haptic rendering. The haptic sub-world is computed based on the graph of contacts between the bodies [Glondou 09]. Let us define β , the set of bodies of the global world and $p \in \beta$ represents the proxy (the body linked to the haptic device). If we suppose that we have a function called $contact : \beta \times \beta \rightarrow \mathbb{R}$ that provides the number of contacts occurring between a pair of bodies, then we can define the graph $\mathcal{G} = (\beta, \mathcal{V})$, where an edge $v = (b_1, b_2)$ from the edges set $\mathcal{V} \subset \beta \times \beta$ exists only if there is a direct contact between b_1 and b_2 , i.e.:

$$\forall b_1, b_2 \in \beta, contact(b_1, b_2) \geq 1 \Rightarrow (b_1, b_2) \in \mathcal{V} \quad (4.1)$$

From the graph \mathcal{G} , we define $\mathcal{H} = (\beta_h, \mathcal{V}_h), \beta_h \subset \beta, \mathcal{V}_h \subset \mathcal{V}$ as the connected subgraph of \mathcal{G} that contains p (the proxy). Figure 4.7 shows an example of how the graph \mathcal{H} is obtained. In practice, we only need the graph \mathcal{H} (the connectivity information of the other bodies in \mathcal{G} is useless for our purpose). Therefore, we designed an algorithm that progressively builds the graph \mathcal{H} over the simulations, starting from the proxy and the bodies that are directly in contact with it.

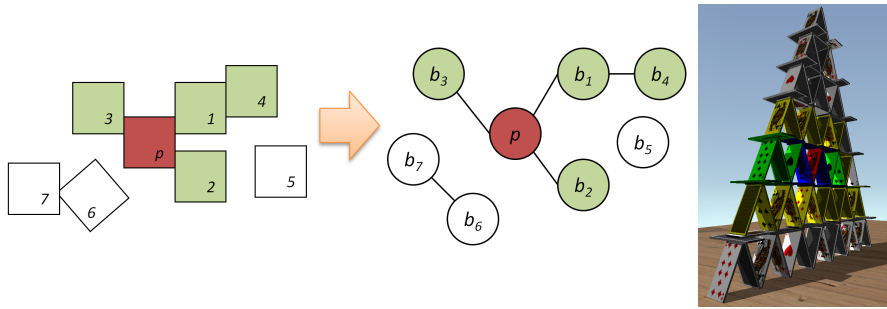

Figure 4.7 – Graph-based haptic sub-world. The graph \mathcal{G} (middle, containing all nodes) defines the contact configuration of the bodies of the global world. The colored connected components of the graph containing the proxy (in red) form the graph \mathcal{H} (containing only colored nodes) of the bodies that compose the haptic sub-world. The card house (right) illustrates the haptic sub-world composed of colored cards extracted from the proxy (red card).

From this definition, a body can belong to the haptic sub-world only if it has a (direct or not) contact with the proxy. However, a haptic cycle is needed before a body is added to the sub-world. Therefore, we anticipate all potential contacts by bringing bodies close to the proxy even if there is no contact with it. Also, we must limit the complexity of the haptic sub-world to preserve the haptic frequency, as illustrated in Figure 4.7 for the card house example. However, if the graph is limited, it may remain contacts between the two worlds. Therefore, we defined an interface that manages the energy exchanges between the global world and the haptic sub-world when the graph is limited, thus avoiding the loss of physical plausibility.

Results

Our approach mainly allows to obtain the same haptic frequency for scenes with a highest number of rigid bodies, thus increasing the complexity of the global world. For example, we have been able to perform with our coupling scheme 1kHz and satisfying haptic rendering in scenes containing more than 700 cubes with many contacts. We performed also accuracy measurements based on the velocity of the bodies on scenes containing up to 250 bodies and about 2,000 contacts. We measured that the sub-world method generates a loss of energy of 6% in the worst case compared to the simulation without sub-world, using a simulation time-step of $1/8$ for the sub-world. We experienced that there was no perceptible alteration of the haptic display.

We implemented and compared the haptic feedback obtained with our method to other coupling schemes between the physical simulation and haptic rendering: the direct coupling, the interpolation of position and a static sub-world coupling. With a direct coupling, a stable and accurate haptic rendering is obtained, but the complexity of the virtual world is limited. With the interpolation method, the efforts returned by the haptic device are stored during the haptic cycle, and are then applied all at a time during synchronization. This behavior produces artifacts and decreases the stability of the haptic feedback. Using a static sub-world, we no longer simulate the haptic sub-world: it is frozen and all objects are fixed. The position of the proxy is imposed into the simulation process at each synchronization. This produces a stable simulation, but the late integration of the action of the proxy produces annoying vibrations artifacts. Using our sub-world method, we can increase the complexity of the virtual world while avoiding the artifacts produced using the interpolation or the static sub-world methods.

4.3 The God-finger method for emulating a contact area during 6 DoF haptic interaction

4.3.1 Context and motivations

Real life interaction using our hands involves the ability of our fingers to deform in order to generate a contact surface with the objects we touch. In contrast, haptic interaction with physically-based virtual objects often involves the use of rigid proxies. The god-object method [Zilles 95] was one of the earliest methods for haptic interaction with virtual objects, and allows 3DoF interaction through a single point. This point, called the god-object, follows the position of the haptic interface, while remaining constrained at the surface of virtual objects when a contact occurs. Several works focused on adding static and dynamic Coulomb friction to contact with god-objects [Ruspini 97, Harwin 02, Melder 04], by only moving the god-object on the surface of the virtual object when it leaves a friction cone defined by the friction coefficient of the object. The method was later extended to 6 DoF interaction, using rigid bodies with complex surface meshes as proxies, allowing any number of contact points with virtual objects [Ortega 07]. Multiple god-objects were also considered, notably handling the translation and rotation of virtual objects contacted with multiple god-objects or proxies [Melder 03, Holz 08], or taking into account the mutual interdependencies between multiple god-objects in the context of a god-hand model [Jacobs 12].

However, points and rigid bodies lack the ability to deform to match the shape of touched objects. Thus the collisions with those objects happen through a limited number of contact points. As a result, there is almost no representation of the surface of contact that would be expected between the user's fingertips and virtual objects. A computationally efficient way of simulating contact areas is the use of soft finger models. Barbagli et al. studied human fingertips to derive a model that simulates the resistance to moments around the contact normals [Barbagli 04], later extended to account for the coupling between tangential and torsional friction forces [Frisoli 06]. These models make the strong assumption that the finger is hemispherical and that the contact surfaces are locally planar, thus another model was proposed that approximates the local geometry of the finger and object in contact [Ciocarlie 07]. However, this improved model still assumes that the geometry is locally smooth. In order to handle all kinds of contacting objects without making any assumptions on their shape, deformable hand models were proposed. These methods allow realistic handling of friction over the contact surfaces, as shown in chapter 3. The deformable body simulation can however be hard to implement and calibrate, and it also leads to a higher computational load.

4.3.2 Approach

The God-finger principle

In [Talvas 13], we proposed "the God-finger method" that computes a contact area from the collision information of a single contact point, as illustrated in Figure 4.8.

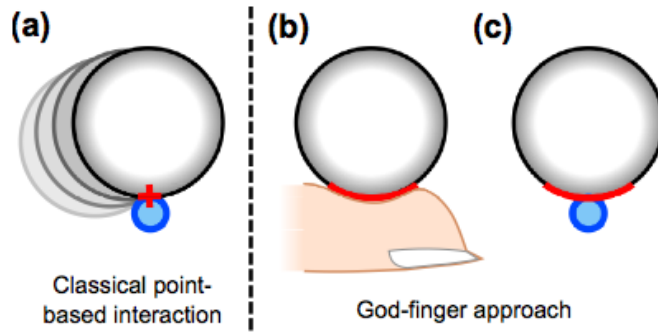

Figure 4.8 – Concept of the God-finger method. (a) Contacts in virtual environments are represented by points. Lifting a virtual object that way causes it to fall. (b) In real life, human fingers generate a contact area with objects through deformation. (c) The god-finger method simulates that contact area from a single contact point. It is now possible to lift the object without it falling, thanks to the contact area.

The area is simulated by additional contact points determined from the normal force applied and the geometry of the touched object. The different steps of the approach are summarized in Figure 4.9. First, a flat fingerprint is generated on the tangent plane to the contact, representing the contact surface that would be expected on a flat surface. It is represented by vectors stemming from the contact point and spanning the surface of the fingerprint. The second step is the projection of this flat fingerprint onto the colliding object, in order to get the actual contact surface. This is done by performing a local geometry scan around the contact point. This scan can get prematurely stopped in order to prevent from having excessive bumps on the surface, and thus keep the surface analogous to a fingerpad contact. Finally, the points resulting from this scan, called *sub-god-objects*, become new contacts between both objects that define the whole contact surface.

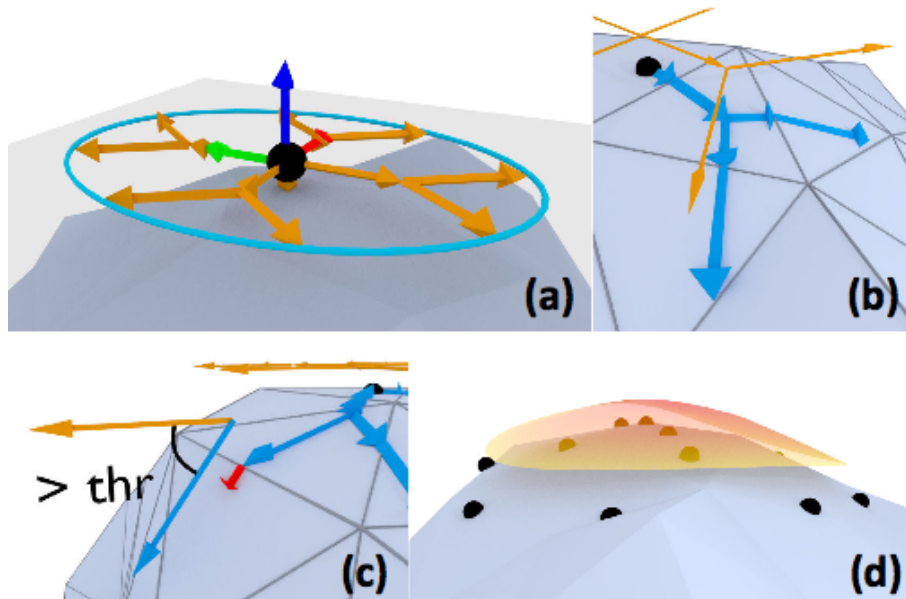

Figure 4.9 – Steps of the God-finger method. (a) A finger-print is generated as if the object was planar. (b) The contact area is then fit to the geometry of the object. (c) Bumps on the surface are prevented by stopping the scan at sharp edges. (d) The result of the scan is fed back to contact points which describe the contact surface.

The God-finger approach makes the method less expensive than deformable body simulation and better suited to achieve haptic rates. Our approach allows 6 DoF haptic interaction with virtual objects with either point or complex virtual proxies. The method also handles contact with deformable objects as well as with irregular surfaces. The slight deformations of the finger itself during contact are also simulated using a specific friction algorithm. Finally, the visual feedback is improved using concentric curves spanning the contact surface.

Illustrative results

Without the God-finger method, simply making a spherical object slide and rotate on a flat surface with a single interface can be a tedious task. Notably, the object has a strong tendency to roll as soon as any force is applied, hence simply translating it while keeping the rolling minimal is near impossible. It also tends to amplify the rotations applied to it, making it also difficult to apply small rotations to it. The God-finger method allows to better constrain the object, limiting the amount of erratic rolling while still allowing to perform controlled large rotations, and also makes it easier to let it slide along a surface (see Figure 4.10).

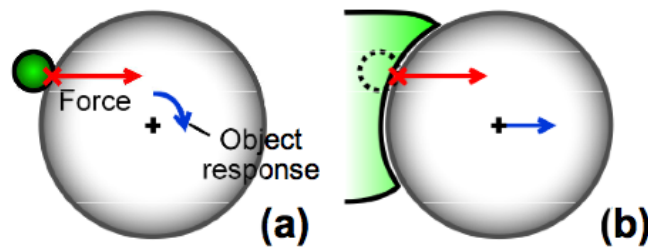

Figure 4.10 – Responses of a virtual object with the regular god-object method (a) and with our novel God-finger method (b). (a) God-object case, the object rolls. (b) God-finger case, the object slides.

Another task made possible only with the God-finger method is that of lifting objects with only one interface, when the contact area is sufficiently large compared to the size of the object (see Figure 4.11.a). Objects can be lifted with two interfaces as well with the God-finger method (see Figure 4.11.b). The use of God-finger instead of regular god-objects allows to restrain the torques around the contact normals, thus allowing to pick an object up easier without resorting to unnaturally high friction values.

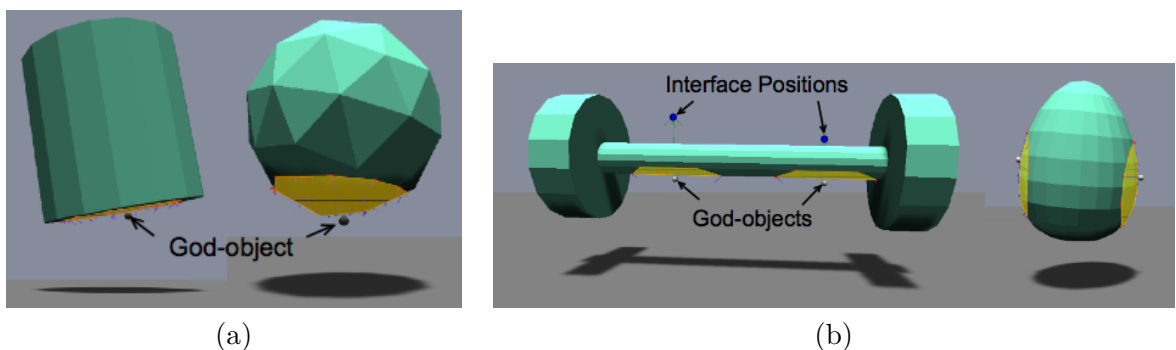

Figure 4.11 – (a) Lifting of virtual objects using only (a) one God-finger or (b) two God-fingers. The contact areas are represented in yellow.

4.4 Conclusion

In this chapter, we have presented a summary of our contributions on the haptic feedback with virtual environments. When introducing 6 DoF haptic rendering with the virtual world, we need to face computational and accuracy challenges. In our work, we chose to handle the haptic rendering of virtual environments with increased complexity such as a combination of different states of the matter or a high number of rigid bodies in interaction. We chose also to render 6 Degrees of Freedom haptic interaction in order to increase the feedback to the user in terms of shape or motion sensations. Thus, we focus on the interaction with objects having complex shape or with specific physical properties. We were also interested in simulating the contact with the objects in a physically-plausible manner, introducing the simulation of a contact surface, reproducing the fingerpad deformation for instance. We illustrate our contributions through three examples: (1) the 6DoF haptic rendering with the different states of the matter, (2) the haptic sub-world approach and (3) the God-finger method. We could also mention that we designed other haptic feedback approaches, for example in the context of the fracture simulation [Glondu 13] or for medical instrument simulation [Duriez 09]. For all our contributions, we aimed at increasing the haptic sensations of the user through the use of appropriate physically-based models. If many of these models are for most of them already used for the visual rendering of the virtual environments, the main challenge in our contributions was to design models that could be synchronized with the other sensorial modalities while providing realistic haptic sensations to the user. Such models open novel possibilities as they could then be used in other scenarios or combined for specific VR applications.

The contributions of this chapter are respectively related to the PhD of G. Cirio (co-supervised with Dr. A Lécuyer), the PhD of L. Glondu (co-supervised with Dr. G. Dumont) and the PhD of A. Talvas (co-supervised with Dr. A Lécuyer).

Visual feedback

5

Contents

6.1 Multimodal rendering of fluids	88
6.1.1 Context and motivations	88
6.1.2 Approach	88
6.2 King-Kong Effects: improving sensation of walking with multimodal vibrations at each step	91
6.2.1 Context and motivations	91
6.2.2 Approach	91
6.3 Toward adaptive VR simulators combining visual, haptic, and brain-computer interfaces	93
6.3.1 Context and motivations	93
6.3.2 Approach	94
6.3.3 Toward medical simulators exploiting passive BCIs	95
6.4 Conclusion	97

Besides the haptic feedback, the visual feedback remains the most used sensorial modality for rendering the interactions with the virtual environment. However, there are complex scenarios where the rendering of the virtual environment remains challenging, especially if the virtual scene owns specific properties that could not be classically rendered. In this chapter, we detail our research work on **visual feedback for complex virtual environments**. We present two of our contributions to illustrate our approach. The first contribution deals with the **visual rendering of physical phenomena**. We tackle the challenge of reproducing similar fracture patterns to real world photographs. Since it remains almost unfeasible to measure the exact geometries of real fracture path, we propose a Bayesian approach that estimate parameters by matching statistics that were previously extracted from a user study. Complex physical phenomena encountered in the real world such as fracture patterns could then be reproduced to obtain similar patterns in the virtual world -in terms of user perception-. Our second contribution deals with the **stereoscopic rendering of wide field-of-view**. As VR applications often require stereoscopic rendering, we need to design specific visual feedback taking into account this characteristic. In addition, a large field of view (i.e. up to 360 degrees) of virtual environments enables to scan the surroundings and access visual information more rapidly. Thus, we were particularly interested in the stereoscopic rendering of such field-of-view. The complexity of this rendering relies on non-planar projections discontinuity encountered by the rendering methods. Our approach proposes an algorithm for removing these discontinuities issues while preserving stereoscopic rendering.

5.1 Example-based fracture appearance

5.1.1 Context and motivations

Cracks and fractures are important visual effects which we encounter in everyday life. Pavements and roads suffer degradation over time, and often have many cracks, sometimes resulting in fragments being detached. Similarly, tiles are often sensitive to a strong impact and are frequently fractured. Various simulation methods exist that can reproduce the physical fracture process [O'Brien 02, Iben 06, Müller 04a]. These methods are controlled by a set of physical parameters and the choice of these parameters determines the visual appearance of the degraded surface. It is however hard to find the correct values to achieve a desired visual effect.

Our objective is to extract fracture simulation parameters from a photograph of cracks with a specific visual appearance and rapidly allow application of *similar* fracture patterns on other objects. To do this, we first need a way to determine whether two fracture patterns are similar, and a method to reproduce this similarity via fracture simulation. As opposed to recent approaches on example-based simulation [Bosch 11], we propose a new approach that estimates parameters by matching *statistics* rather than matching exact patterns. We perform a user study to determine which statistics form a valid metric for visual similarity. We use the metric in an optimization to find simulation parameters. This approach thus facilitates the generation of similar looking, but not identical, fractures.

5.1.2 Approach

Principle

In [Glondou 12a], we proposed a novel approach for reproducing from real world photographs fracture patterns in virtual environments. Our method starts with an input photograph of a given crack pattern. We extract statistics of the fractures, using a set of features similar to [Shin 10], such as fragment area, crack edge length, orientation or straightness. The various statistics extracted have different levels of influence on the resulting visual similarity to the exemplar. To investigate this effect we performed a user study to determine whether these statistics are correlated to visual similarity and the relative importance of the different statistics. The results of the perceptual study allow us to choose the appropriate statistics to use for our optimization.

Our main goal is to fit parameters of a fracture simulation using the extracted statistics. This is achieved through a Bayesian optimization process, which refines the parameters trying to match the statistics between the simulated and input models, as illustrated in Figure 5.1. We notably introduce a new fracture similarity metric based on the statistics previously evaluated in the user study. We use a real-time fracture model specially tailored for this (see chapter 2), combining both physically-based properties with parameters that are effectively fitted within this process.

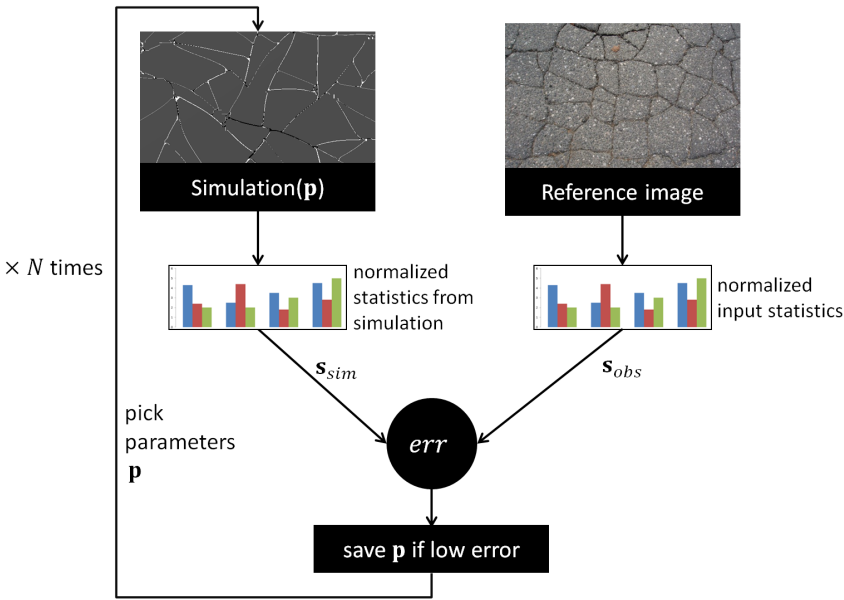

Figure 5.1 – Overview of the optimization process. Parameter vector \mathbf{p} is optimized iteratively. After each simulation, the statistics of the simulation are compared to the statistics of the reference image. The err function is our metric.

Once the simulation parameters have been estimated, we generate similar patterns on new scenes. We proposed an interactive modeller where fracture patterns can easily be created, edited and finally propagated into similar objects, which facilitates the modeling task on large scale scenes (see Figure 5.2). The speed of the underlying simulation allows us to use our results for interactive fracture modeling. The modeller can choose the parameters associated with an exemplar from a library and apply them to different objects in a scene. The user can then request the system to automatically propagate to all objects with the same material.

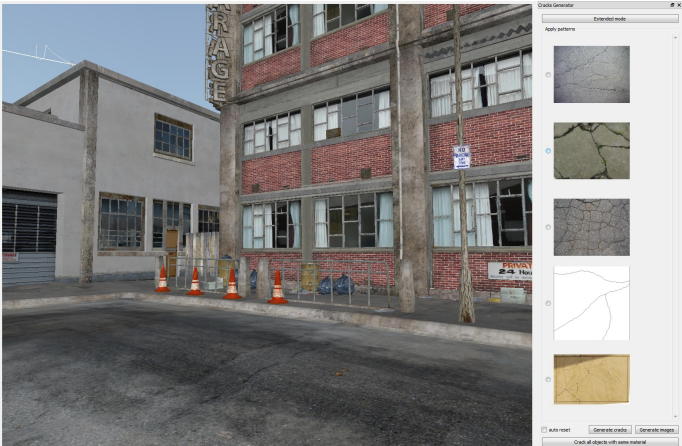

Figure 5.2 – Snapshot of our interface. The user chooses a material from the menu (right); they are subsequently applied to all objects sharing the same material description.

Illustrative results

The speed of our approach makes our method applicable to large-scale models, and provides an interactive fracture modeling interface to apply fractures to various models based on examples from photographs. We illustrate this process on different scenes e.g., a city neighborhood or interior scenes, as shown in Figure 5.3. By using a true volumetric simulation, we can simulate changes in the geometry due to the weathering effect, as well as surface patterns.



Figure 5.3 – Application of our example-based fracturing method on different scenes. Photographs of input fracture patterns are shown in the insets. Left to right: (1) a bathroom tile has been broken, and each fragment can be manipulated separately. (2) Fracture pattern obtained from a ground tile photograph applied on a basin. (3) Sidewalk and curb from an urban scene fractured

Although the geometries of the simulated objects are very different, the visual features of the input fracture patterns are correctly reproduced. Figure 5.4 illustrates the global process with the different steps of our approach using different real photographs.

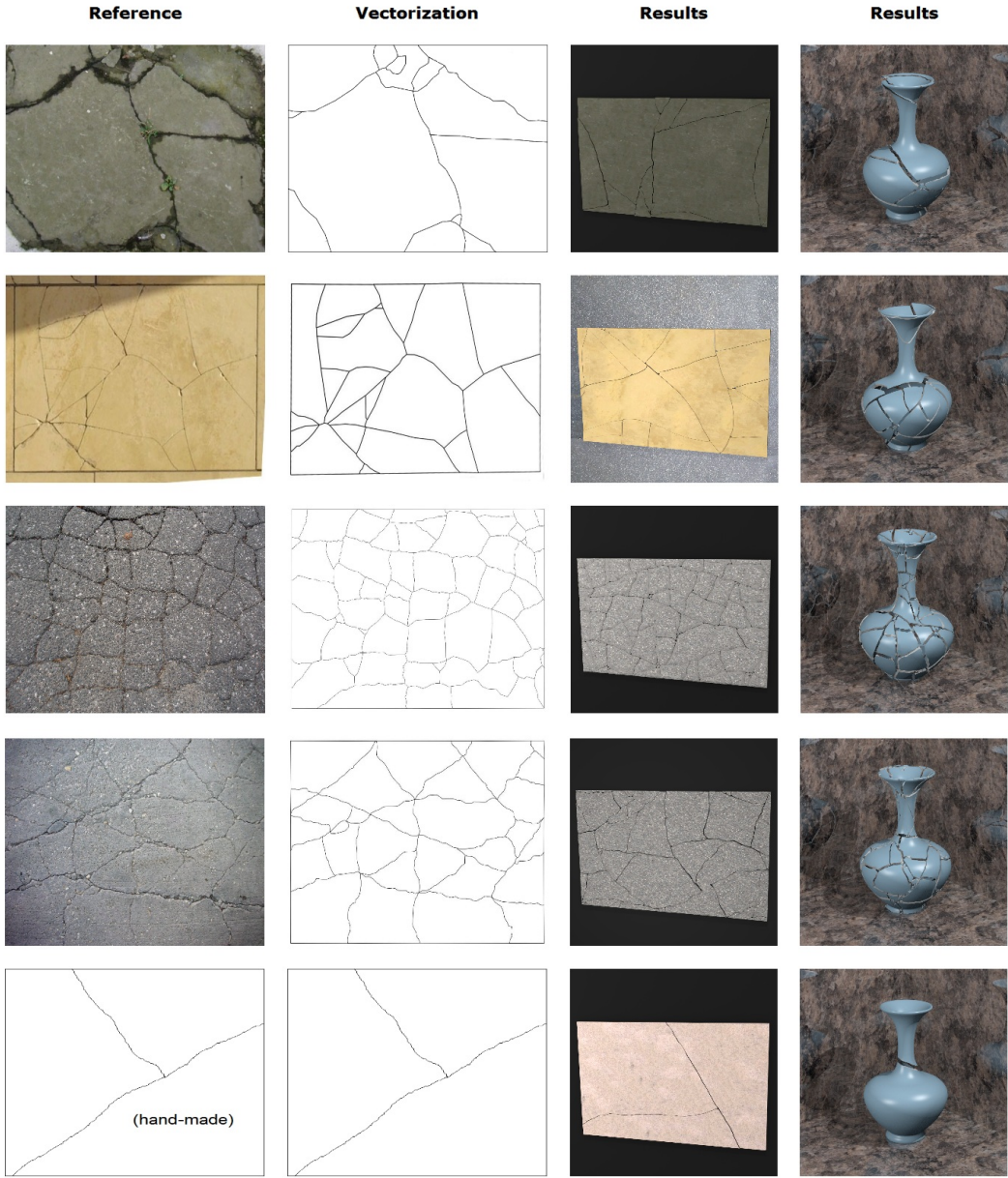

Figure 5.4 – Fracture patterns applied on different objects. The left column represents the real photograph. Image processing allows the extraction of statistical measurements. Physically-based simulations are then computed, after an optimization approach to identify the simulation parameters. The results could then be applied to different types of objects of the virtual environment.

5.2 Stereoscopic rendering of virtual environments with wide field-of-views

5.2.1 Context and motivations

Many virtual reality applications require a wide Field-of-View (FoV). In almost all cases, visual information of the user's surroundings is accessed sequentially. To do so, either a head tracker is considered to pan the view within an Head-Mounted-Display or several planar screens are used to surround the user (CAVEs) [CruzNeira 93]. A large field of view (i.e. up to 360 degrees) of virtual environments enables to scan the surroundings and access visual information more rapidly. This was even found to improve significantly the performance of users during a search and navigate task in desktop VE [Ardouin 13].

If a wide FoV visualization is required on a constrained surface, the rendering method has to rely on non-planar projections, mapping the space directions to the final viewport. To comply with the specificities of non-planar projection, real-time rendering software should use either image or geometry-based rendering methods [Trapp 09]. These methods often fail at being at the same time: stereo-compatible, GPU-friendly, and free of non-planar projections discontinuity problems [Petkov 12].

Geometry-based methods can be split into two groups: the former approximates the non-planar projection with several perspective projections, the latter computes the non-planar projection equation per vertex, referred as Per Vertex Projection Evaluation (PVPE). PVPE seems to be a compelling technique because of its simplicity and compatibility with the standard rasterization pipeline. From a technical point of view, a geometric PVPE approach for wide FoV rendering involves two main steps. First, the geometry is projected into the unit cube: for large FoV, a non planar projection is mandatory. Second, the transformed primitives are rasterized through scan conversion, ie. transformation of vectorial data to bitmaps: for performance issues, the hardware accelerated rasterization pipeline has to be considered, alongside with its restrictions. The non-planar projection induces two major issues. First, the projection does not preserve shapes anymore, leading to important post projection errors for a geometry with low tessellation level. Second, the projection includes discontinuities: if a triangle spans across a discontinuity, it is not properly rasterized. These issues are illustrated through the example of an equirectangular projection in Figure 5.5.

5.2.2 Approach

Principle

In [Ardouin 14], we proposed a novel geometric method for the stereoscopic rendering of VEs with large FoVs (i.e. above 120° and up to 360°). Our method evaluates the non-planar projection equation per vertex, and includes an innovative pre-clip approach in order to solve the problems occurring with polygons spanning across the projection discontinuities.

The standard clipping algorithm is indeed unable to detect problems that arise for triangles spanning across a discontinuity of the projection. To be correctly rasterized, these triangles need to be specifically processed before applying the projection. For FoV less than 180 degrees, the problem can be avoided by culling polygons behind the center of projection (so no rendered triangle can span across a discontinuity) but current implemen-

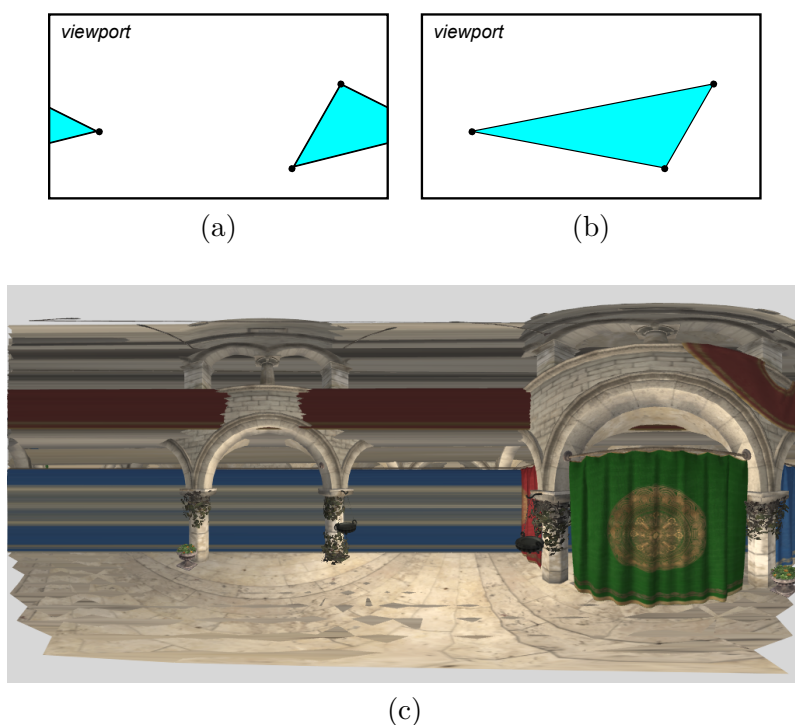

Figure 5.5 – Rasterization of a triangle projected from rear fails when using an equirectangular projection. Surface (a) is desired but (b) is generated. (c): the problem on a real scene: triangles composing the red and blue drape on the very right are rasterized across the whole viewport.

tations targeting FoV above 180 degrees simply drop the rendering of this kind of triangles [Petkov 12]. Thus, clipping them smartly to make them fit the graphic pipeline is clearly an attractive challenge. Considering an equirectangular projection, the additional clipping step has to prevent situations where a primitive is wrongly rasterized due to a span across the projection discontinuity.

Our approach consists in splitting the primitive in sub-parts that do not span across a discontinuity. The guideline for the algorithm is to first detect if a triangle needs to be clipped. If so, its edges are processed sequentially to detect if one crosses the discontinuity. New vertices are generated on the discontinuity, and their attributes are computed using barycentric interpolation. If needed, the coordinates of the newly generated vertices are slightly corrected to guarantee that the vertex keeps a coherent position after been projected. The overall approach can fit any non-planar projection, but the pre-clipping step has to be tuned for the discontinuities of the chosen projection.

Illustrative results

Our method is able to perform real-time stereoscopic rendering with FoVs up to 360°, as illustrated in Figure 5.7. Figure 5.6 illustrates the different stereoscopic images obtained (anaglyph images requiring red/cyan glasses to be viewed). Figure 5.6.a represents a top view of the VE. In this particular case, the understanding of the resulting view is not trivial. Distortions in the final rendering and the unusual point of view can mislead the viewer. The addition of stereoscopy seems to ease the perception of the structure of the VE.

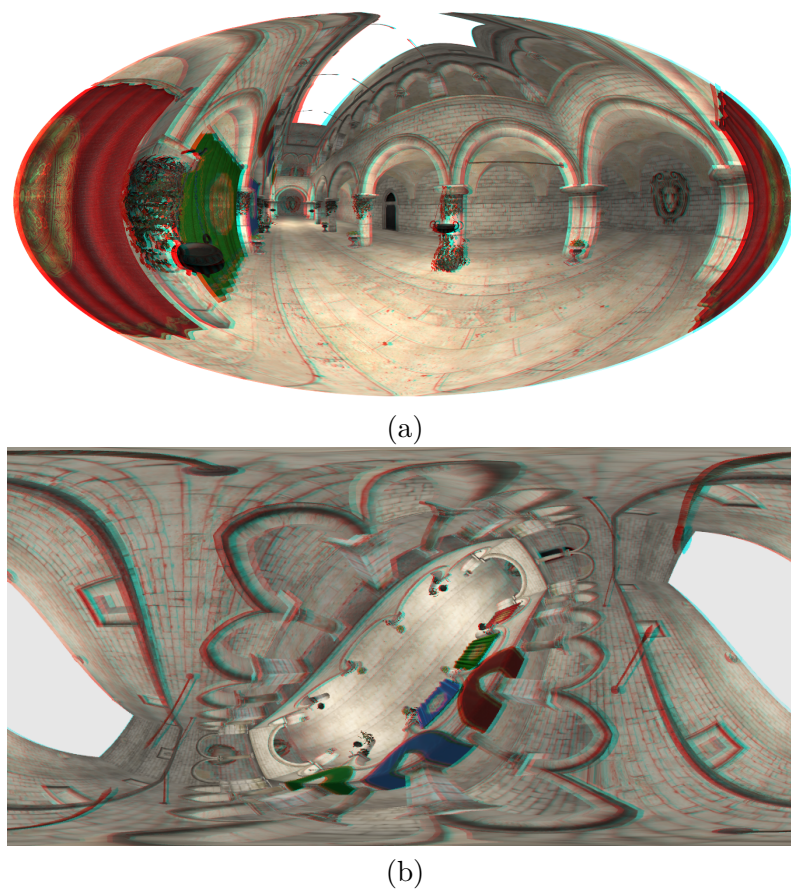

Figure 5.6 – Stereoscopic (anaglyph for reader convenience) rendering of 360° view using (a) a Hammer projection and (b) an equirectangular projection. The images are computed at real-time framerate.

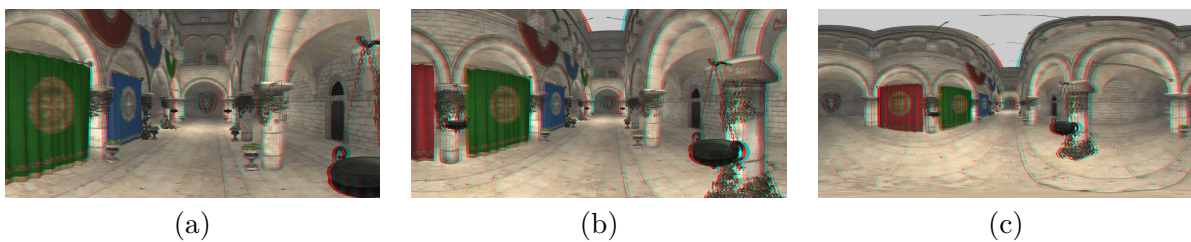

Figure 5.7 – Stereoscopic equirectangular rendering with different FoV: (a) 120°, (b) 180°, (c) 360°.

5.3 Conclusion

In this chapter, we have described two of our contributions on visual feedback for complex virtual environments. The first contribution aims at reproducing similar fracture patterns to real world photographs. We proposed an original Bayesian approach that could estimate simulation parameters by matching statistics of fracture patterns that were previously extracted from a user study. We were able to obtain similar *in terms of user's perception* virtual patterns as the fracture patterns observed in the real world. Our approach opens novel possibilities for visually reproducing patterns of complex physical phenomena where classical distance metrics could not be used in an optimization process. Our second contri-

bution proposes a method for the stereoscopic rendering of wide field-of-view. We described an algorithm for removing the discontinuities issues linked to the non-planar projection process. Our results showed the real-time stereoscopic rendering of wide field-of-view up to 360°. Our approach provides an efficient tool that could be applied in numerous VR applications where larger field-of-view could be of interest. We could also be able to enlarge our field-of-view more than the real one.

For both contributions, we mainly tried to improve the user's perception of the virtual world by providing him an "adapted" visual feedback. Thus, we incorporate in our first contribution a user study to find appropriate parameters in terms of user's perception. We could also mention some other experiments we performed to evaluate the perception of visual feedback, such as the affordances of virtual grounds for example [RegiaCorte 13]. Visual feedback remains the main sensorial modality in VR applications and is already mostly used in all of them. Thus, we aim with our contributions at improving it through the use of the user's perception. Real data and rendering methods could then be intricately linked for the design of novel rendering approaches, leading for instance to highly-realistic virtual worlds or with larger field-of-view compared to the real world.

The contributions of example-based fracture appearance are related to the PhD of L. Glondu (co-supervised with Dr. G. Dumont), with a collaboration with Dr. G. Drettakis (Inria Sophia-Antipolis), Dr. C. Bosch (Univ. Girona, Spain) and Pr. H. Rushmeier (Yale University, United-States). The contribution on stereoscopic rendering is related to the PhD of J. Ardouin (co-supervised with Dr. A Lécuyer and Dr. E. Marchand).

Multimodal feedback

6

Contents

7.1 Pseudo-haptic walking	99
7.1.1 Context and motivations	99
7.1.2 Approach	100
7.2 Elastic images	103
7.2.1 Context and motivations	103
7.2.2 Approach	103
7.3 Conclusion	104

Introducing multimodal feedback in VR applications requires to simulate the virtual environment dynamics at different temporal and spatial scales, according to the different sensorial modalities. Any combination of sensory feedback needs both computational performances but also appropriate models for synchronizing all the modalities, depending on the scale of the chosen application. In this chapter, we present our contributions on **multimodal feedback**, gathering different technologies around **use cases of complex scenarios**. In these use cases, we combined physically-based approaches with 3D user interfaces to design multimodal VR applications. We have also particularly paid attention to the evaluation process through user studies in our contributions. The first contribution is related to the **multimodal rendering of fluids**. We proposed an approach combining visual, acoustic and vibrotactile feedback for simulating user's interaction with fluids such as walking through puddles or splashing on the beach. For that purpose, we introduced a vibrotactile model based on sound generation mechanisms, motivated by the fact that acoustic and tactile feedback are both vibrations that share a common physical source. The complexity of the multimodal rendering relies on the real-time synchronization of the different feedback, achieved through a physically-based method. We illustrate our approach through different scenarios, either for manipulating objects interacting with fluids or for navigating on grounds with fluids. Our second contribution proposes to enhance the user's sensations of walking within virtual environments through the generation of **multimodal vibrations at each step** of the navigation task. Our approach called *King Kong Effects* produces visual and tactile vibrations simulating the feet touching the ground at each step. Auditory feedback is also generated at the same time. The complexity of the multimodal rendering relies on the generation of physically-plausible steps. We used a biomechanical model that we evaluated through a set of experiments, especially in a multimodal context. Our third contribution combines a **multimodal approach with a novel concept of user-adapted simulator** for the different sensorial modalities. Thus, we introduced a project that adapts in real-time a guidance system's feedbacks to the user's mental workload. We first designed a VR setup that adapts haptic feedback according to the user's brain waves in real-time. Then, we proposed a first application

of our approach with a medical training simulator that provides virtual assistance that adapts to the trainee's mental activity.

6.1 Multimodal rendering of fluids

6.1.1 Context and motivations

When aiming at a multimodal VR system, force and visual feedback are not the only modalities to convey important cues. Vibrotactile and acoustic feedback can provide crucial information to the user when interacting with a VE. Vibrotactile feedback can generate higher-frequency components that are not captured by the kinesthetic modality, providing, for instance, texture and transient cues. Acoustic feedback allows even wider frequency ranges, conveying information about material type, impact magnitude and distance. Both modalities can be displayed through cheap and off-the-shelf devices, making them a very attractive addition to VR setups.

Some common materials with which we interact on a daily basis can be simulated and displayed through the vibrotactile modality, such as wood, metal [Kuchenbecker 06, Nordahl 10] and aggregates like gravel and snow [Visell 08], leading to compelling multimodal VR scenarios [Visell 10]. However, fluids have again been largely ignored in this context. For VR simulations of real world environments, the inability to include interaction with fluids is a significant limitation. Therefore, we proposed an approach [Cirio 13a] to remedy this, motivated by our interest in supporting multimodal VR simulations such as walking through puddles or splashing on the beach.

6.1.2 Approach

In this section, we first describe our vibrotactile method before presenting our multimodal rendering of fluids.

Vibrotactile rendering of fluids

When an object vibrates under an applied force, a pressure wave is generated at its surface, traveling to the subject's ears and mechanoreceptors. We motivate our vibrotactile approach, based on sound generation mechanisms, on the fact that acoustic and tactile feedback are both vibrations that share a common physical source.

By comparing film frames with the air-borne generated sound, Richardson [Richardson 55] provides an explanation for the process of a projectile impacting and entering a fluid volume. The impact produces a "slap" and projects droplets, while the object penetration creates a cavity that is filled with air. The cavity is then sealed at the surface, creating an air bubble that vibrates due to pressure changes. Smaller bubbles can spawn from the fragmentation of the main cavity, as well as from the movement of the fluid-air interface, such as when the droplets return to the fluid volume.

Our vibrotactile model is therefore divided in three components, following the physical processes that generate sound during solid-fluid interaction: (1) the initial high frequency impact, (2) the small bubble harmonics, and (3) the main cavity oscillation (see Figure 6.1). As a consequence, it is highly dependent on the efficient generation and simulation of air bubbles within the fluid. Hence, a real-time fluid simulator enhanced with bubble synthesis is required on the physical simulation side. We use the SPH model for both fluids and rigid bodies (see chapter 4), and a full GPU implementation for real-time speeds. The

physical simulator automatically detects the solid-fluid impacts and the creation of air bubbles caused by interaction between a solid (such as a foot, a hand or an object) and the fluid volume. For each of these events, it sends the corresponding message to the vibrotactile model, which synthesizes a vibrotactile signal according to the simulation parameters. The signal is then output through a specific vibrotactile device, such as an actuated tile for foot-fluid interaction, or a hand-held vibrator for hand-fluid interaction. The vibrotactile model has the ability to simulate bubbles creation and deletion events in a physically-based way. Different synthesis and control algorithms are designed to generate a vibrotactile signal for each of the three components of the vibrotactile model.

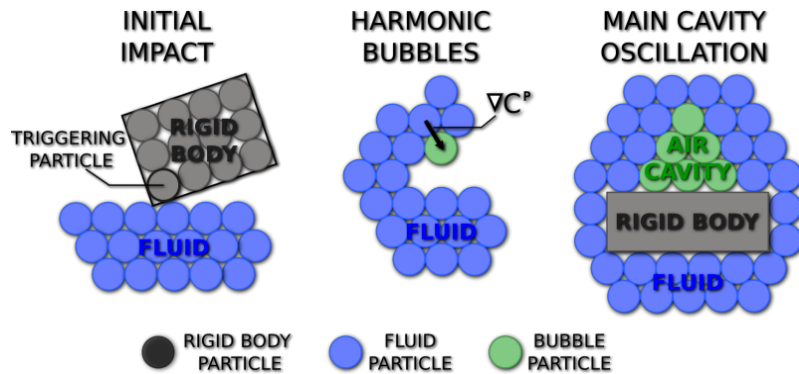

Figure 6.1 – The three components of our vibrotactile model: the initial high frequency impact, the small bubble harmonics and the main cavity oscillation.

Illustrative results with multimodal scenarios

We designed different scenarios representing possible multimodal interaction conditions. Since our vibrotactile model is built from sound generation mechanisms, we are able to produce acoustic feedback using the same model, by displaying the signal through a speaker and in the 12 Hz - 20 kHz range. Since the sound synthesis is coupled to a physically-based fluid simulator, it enables fully multimodal interactions.

Active foot-water interaction (shallow pool). Our approach is particularly suited for foot-floor interaction, where the floor renders the vibrotactile feedback to the user's feet through appropriate vibrotactile transducers. We used a floor consisting of a square array of thirty-six 30.5×30.5 cm rigid vibrating tiles [Visell 08], rendering in the 20-750 Hz range. The VE consisted of a virtual pool with a water depth of 20 cm filling the floor. The user's feet were modeled as parallelepiped rigid bodies and tracked through the floor pressure sensors. The user could walk about, splashing water as he stepped on the pool as seen in Figure 6.2 (left, top). In this scenario, the virtual environment was composed of 15,000 particles (1% bubbles) and was simulated at a frame rate of 152Hz.

Passive foot-water interaction (beach shore). Using the same hardware setup as the previous scenario, we designed a VE in which the user stands still and experiences waves washing up on a sandy beach, as shown in Figure 6.2. The virtual scene was composed of 15,000 particles (6% bubbles) and was simulated at a frame rate of 147Hz.

Active hand-water interaction (water basin). The user can interact with fluids with his hands using a hand-held vibrotactile transducer (see Figure 6.2 (right, top)). In this scenario, a small vibrator was attached to one of the user's hands. The hand was tracked by a motion capture system, and modeled in the VE as a parallelepiped rigid body. The user could feel the water sensations by plunging his hand into a cubic volume of fluid. There were 7,000 particles (6% bubbles) composing the volume and the frame rate was 240Hz. Kinesthetic feedback can also be rendered through a suitable haptic device, such as a multiple degrees-of-freedom force-feedback manipulator. This is illustrated in Figure 6.2 (right, bottom), which shows a pool of fluid with a rigid body coupled to a Virtuouse 6DoF force-feedback device from Haption. The user can interact with the fluid through the rigid body while receiving kinesthetic feedback.

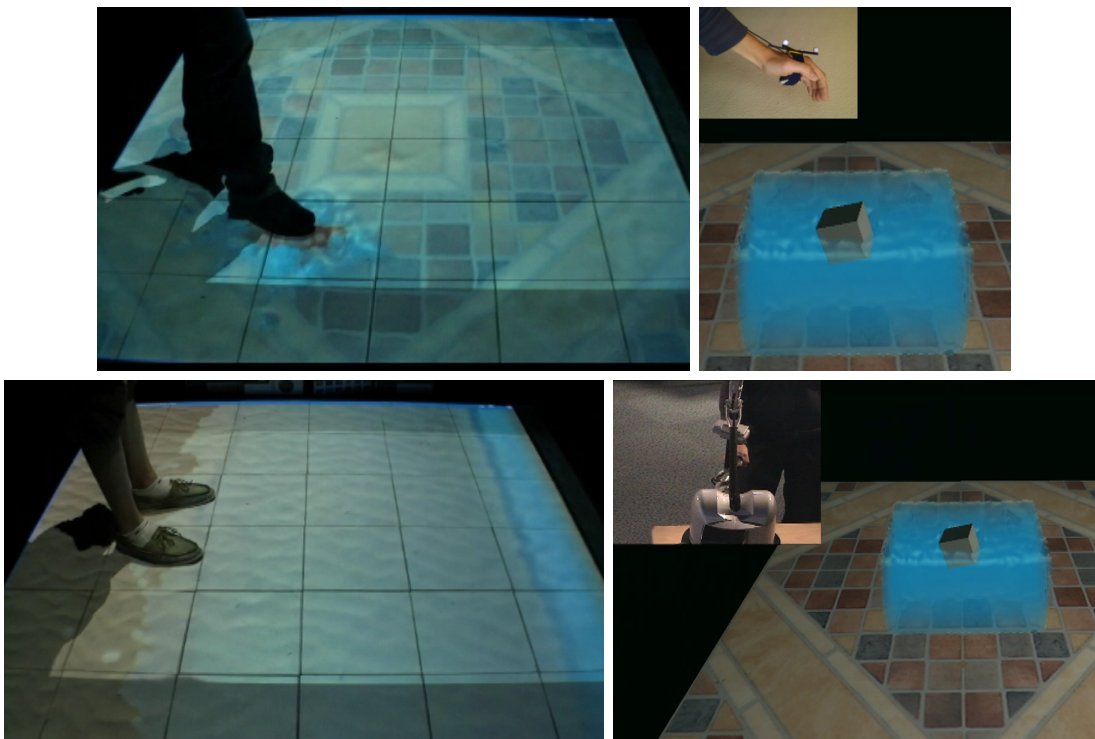

Figure 6.2 – Interaction examples using different body parts and rendering devices: a foot-water pool scenario using actuated tiles (left, top), a user feeling the water under his feet as a wave washes up on the beach using actuated tiles (left, bottom), and a hand-water basin scenario using a small vibrator (right, top) or a 6DoF haptic device (right, bottom).

6.2 King-Kong Effects: improving sensation of walking with multimodal vibrations at each step

6.2.1 Context and motivations

For navigation tasks in VE, researchers have developed numerous kinds of sensory feedbacks to improve immersion. For example, Lécuyer et al. [Lécuyer 06] proposed to use Camera Motions (CM) to reproduce the walking oscillations of the user's point of view during navigation in VR. The point of view oscillates in the VE to generate the visual flow that would be produced by a real walk. They demonstrated that their approach not only improves the user's sensation of walking in VE, but also his immersion. In [Terziman 12], we proposed to extend the visual feedback of camera motions to a multimodal answer for walking tasks in VR. Our objective is to render step sensations using different sensorial modalities combined together: visual, auditory and vibrotactile.

6.2.2 Approach

Principle

In [Terziman 12], we proposed a new technique to enhance the sensation of walking in VE inspired by special effects in Hollywood movies. The King Kong Effects (KKE) provide a new kind of sensory feedback that simulates the feet touching the ground at each step by producing visual and tactile vibrations. The KKE concept is illustrated in Figure 6.3. Our technique can be used in static position, such as when seated or standing, whereas the user controls the virtual walk with any input device (joystick, keyboard, etc.). We designed different vibration patterns based on physical and metaphorical models.

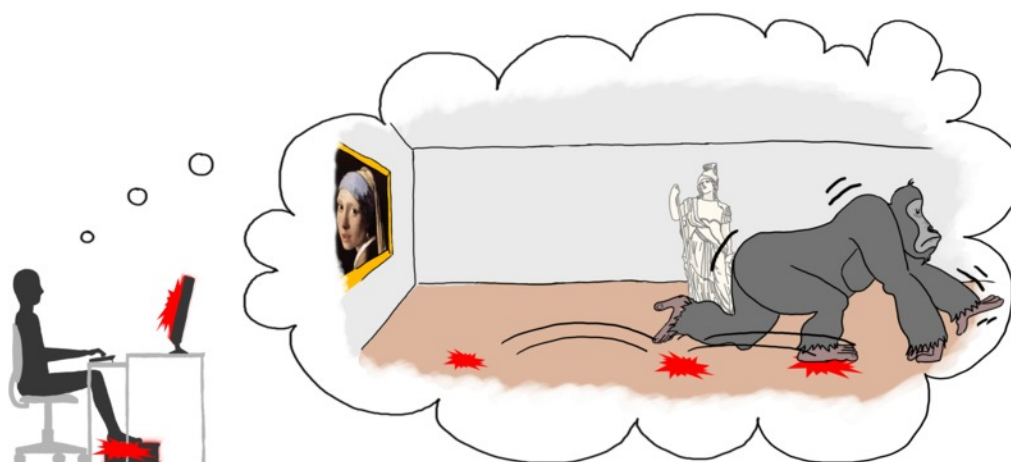

Figure 6.3 – Concept of the King Kong Effects: visual and tactile vibrations inspired by special effects in movies enhance the sensation of walking in VE. Visual and tactile feedbacks are generated at each step made in the VE.

The software architecture behind KKE is composed of three parts. The *step simulator* is designed to compute footstep events based on a simple biomechanical model. Then, two different sensory feedback components corresponding to the visual and vibrotactile modalities have been developed to enhance the walk in the VE based on the generated footstep events. We introduced the use of visual vibration patterns which simulate the

contact of the feet with the ground at each step. Moreover, we simulate both the contacts of heel and toe. We propose and study vibration patterns along either vertical or horizontal directions. We also introduced new vibrotactile feedbacks generated under the feet of the user to reproduce the step sensation. Again, we simulate both the contacts of the heel and toe. Moreover, we proposed two different vibration pattern metaphors: a physically based metaphor and a metaphor where the stimulation is proportional to the force pressure applied by the feet on the ground. The KKE can be implemented on any kind of computer, requiring only the tiles for the vibrotactile rendering.

Evaluation

We conducted a set of experiments to evaluate the different components of the KKE and to determine the best combination among modalities and effects. We detail the fifth experiment that tested the participants' preference for the KKE in a multimodal context.

Experimental apparatus For this experiment, we introduced audio feedback of prerecorded footsteps to the KKE. The footstep sounds were synchronized with the other KKE by the step simulator. We used audio, visual and vibrotactile modalities individually or all together (see Figure 6.4 for the experimental setup). Ten participants (9 males and 1 female) aged from 21 to 27 (Mean $M = 24.1$, Standard Deviation $SD = 2.2$) performed the experiment. None of the participants had any known perception disorder. All participants were used to VEs but were naïve with respect to the proposed techniques, as well as to the experimental setup.

We used a within subject design where the participants could freely navigate on a museum scene as shown in Figure 6.4. They had the possibility to switch at will from one condition to the others. All the possible combinations of these 3 modalities were available, from one modality alone to the 3 combined together, resulting in the following conditions: V , H , A , VH , VA , HA and VHA . The experiment lasted approximately 15 min.



Figure 6.4 – (a) Museum scene of the experiment. (b) Setup of the experiment.

Concerning the collected data, the participants had to grade from 1 (very bad) to 7 (very good) the different conditions based on the following criteria: (1) Presence, (2) Sensation of walking, (3) Realism of the walk, (4) Fun and (5) Global appreciation.

Results Concerning the subjective questionnaires, we performed a Friedman test. The reported p-values were adjusted for multiple comparisons. We found a significant effect for all criteria: Fun ($\chi^2 = 4.49$, $p < 0.001$), Global appreciation ($\chi^2 = 2.97$, $p = 0.047$), Presence ($\chi^2 = 4.90$, $p < 0.001$), Realism ($\chi^2 = 5.29$, $p < 0.001$) and Walking sensation

($\chi^2 = 4.90$, $p < 0.001$). Post-hoc analysis showed particularly that *VHA* was preferred to *V*, *H* and *A* for Presence, Realism, and Walking sensation. *VHA* was significantly better rated than *VH* for Realism and Walking sensation. *VHA* was significantly better rated than *VA* for Realism. *VHA* was significantly better rated than *HA* for Fun.

The multimodal evaluation of the KKE showed that the effects produced by each modality are reinforced when used in conjunction with the other modalities. In particular, conjunctions of two modalities scored higher on the fun criteria. Finally, the combination of the three modalities resulted in higher grades for presence, realism and walking sensation compared to each modalities taken alone or by two. Thus, our results suggest that a multimodal approach for the perception of the walk in the VE is preferred by the participants. The results of the questionnaire are displayed in Figure 6.5.

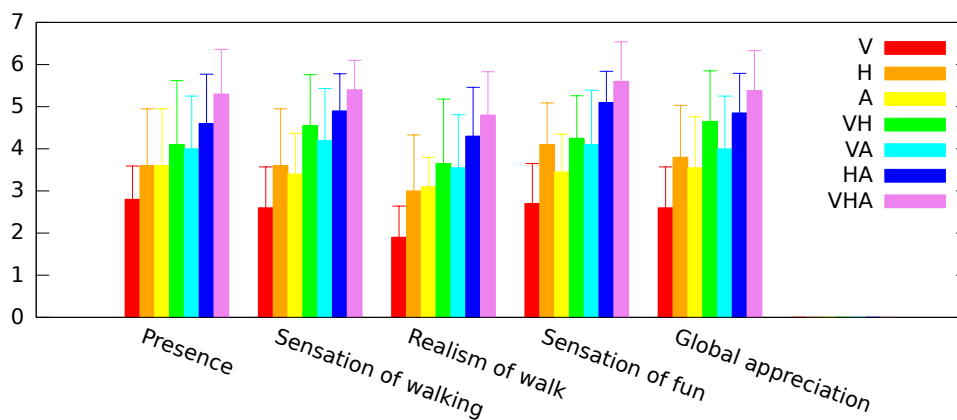

Figure 6.5 – Results of the subjective questionnaire for the King-Kong effect. For each of the criteria, the mean and standard deviation for each condition are represented (*V* for visual, *A* for auditory, *H* for vibrotactile).

6.3 Toward adaptive VR simulators combining visual, haptic, and brain-computer interfaces

6.3.1 Context and motivations

If current VR approaches try to improve the multimodal feedback of VE, we could also expect novel systems that adapt the feedback depending on the user. In [George 12, Lécuyer 13], we presented a project that adapts a guidance system’s force feedback to the user’s mental workload in real time. To illustrate our approach, we proposed a first application with a medical training simulator that provides virtual assistance that adapts to the trainee’s mental activity. User’s mental activity could particularly be measured through Brain-Computer Interfaces (BCIs) [Wolpaw 02]. In our work, we looked at this technology, using examples from our research. In particular, we examined how we could combine visual and haptic feedback, and passive BCIs to improve interaction with VEs. An approach called "passive BCI" aims at using brain activity information to adapt and enhance the current application without the need for the user to voluntarily control her brain activity [Zander 11]. Haptic feedback has already been used in BCI systems [Cincotti 07, Chatterjee 07]. However, BCI had never been used for adapting haptic feedback yet.

6.3.2 Approach

Principle

In [George 12], we designed a VR setup that adapts haptic feedback according to the user’s brain waves in real time. An EEG-based passive-BCI system computes an online index related to the user’s mental workload. The aim of the system is to provide haptic assistance only when the user’s brain activity reflects a high mental workload: if the index indicates a high workload, the system activates haptic assistance; if the workload is low, guidance is deactivated. This guidance should reduce the task difficulty and decrease the mental workload.

Proof-of-concept system

This novel approach is illustrated within a proof-of-concept system: haptic guides are toggled during a path-following task thanks to a mental workload index provided by a BCI. While moving the cursor through the maze, the participants had to avoid collisions with the maze walls. This task evokes the dexterous manipulations involved in industrial-maintenance simulations or surgical simulators, for instance. The maze had two parts (see Figure 6.6). The first part had numerous turns and was difficult; the second part presented fewer possible collisions and was thus less difficult. The system performed collision detection and computed contact forces in real time, using Bullet, an open source physical engine. For haptic assistance, the system added a repulsive force inversely proportional to the cursor’s distance from the nearest wall. This assistance aimed to help the user by sliding the cursor along the walls and avoiding collisions. We computed the mental-workload index using OpenViBE software and signal-processing techniques we had designed and tested. To train the signal-processing pipeline, we used a dataset comprising two minutes of EEG activity: one minute of performing a simple control task and one minute of moving the cursor through a complex spiral maze while avoiding collisions. So, in this context, we expected the mental-workload index to correlate with the manipulation task’s complexity.

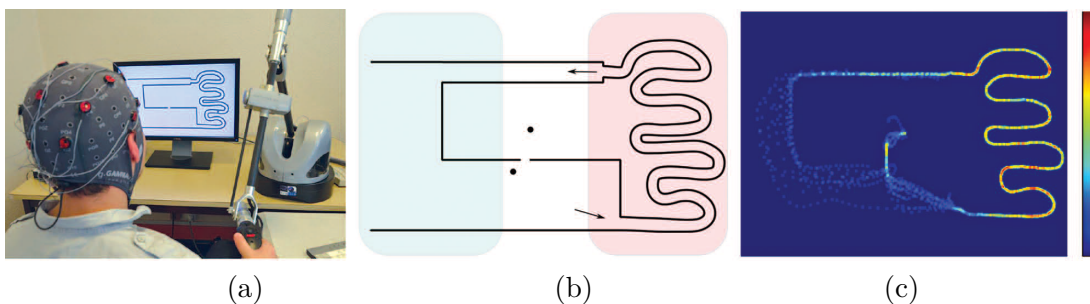

Figure 6.6 – A passive-BCI system that adapts haptic feedback. (a) In real time, the system adapts force feedback to the user’s mental activity, as measured with an electroencephalograph (EEG) headset. (b) During a path-following task in a 2D maze, the system activated haptic assistance when the user’s brain activity indicated a high mental workload. The assistance caused the cursor to slide rapidly on the maze wall, thus avoiding collisions with the wall. (c) The right part of the maze, with numerous shorts turns, exhibited more activations, as the yellow and red dots indicate.

Evaluation

We evaluated our system through a user study. The experiment had two goals: (1) to test operability of a system that adapts force-feedback based on mental workload measurement; (2) to evaluate the influence of such a system on task performance. We evaluated three conditions: (1) no haptic assistance, (2) workload-based haptic assistance, and (3) continual haptic assistance. Figure 6.7.a displays the number of collisions for each condition. These results suggest that the system helped users achieve the task. Workload-based haptic assistance indeed increased performance by significantly reducing the number of collisions. Actually, we observed no significant performance differences between workload-based and continual assistance. So, we suspect that a well-tuned passive BCI could perform almost as well as continual assistance, but with guidance activated only when the user actually needs it.

Workload-based haptic assistance also significantly decreased the mental-workload index (see Figure 6.7.b). The workload was also significantly higher in part 1 of the maze (see Figure 6.6.c). This suggests that our system measures a mental-workload index that correlates well with the task’s difficulty. Our participants’ answers to a subjective questionnaire appear to confirm this belief. They reported a high correlation (above 70 percent) between the computed index and their perceived mental workload. Our passive-BCI system thus seems to provide a convincing measurement of mental workload.

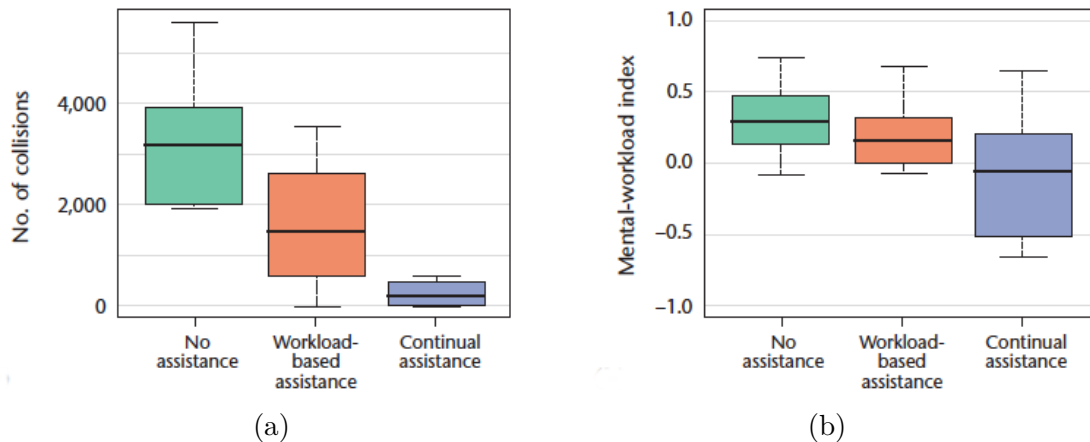

Figure 6.7 – Experimental results obtained with our proof-of-concept setup. (a) Workload-based haptic assistance significantly reduced the number of collisions. (b) It also significantly decreased the mean mental-workload index.

This exploratory study suggests that our proof-of-concept system is operational and exploitable. The haptic assistance was activated in the most difficult part of the path-following task. Moreover, this approach increased task performance by more than 53 percent, while activating assistance only 59 percent of the time. These results suggest that such passive-BCI systems could be used to determine when users need assistance and to activate that assistance accordingly.

6.3.3 Toward medical simulators exploiting passive BCIs

In [Lécuyer 13], we described how we applied this approach to a medical simulator. Our simulator recreates a tumor biopsy in the liver. The user manipulates a virtual needle and must perforate the liver to reach the tumor. The tumor’s position in the liver is randomized. Figure 6.8 displays our prototype. An EEG headset acquires signals from

16 electrodes, similarly to the configuration we described in the previous paragraph. For needle manipulation, the system employs a Phantom Omni haptic device. The simulator presents the 3D scene on a standard laptop screen. A mass-spring model represents the deformable liver, a thin cylinder represents the rigid needle, and a rigid sphere represents the tumor.

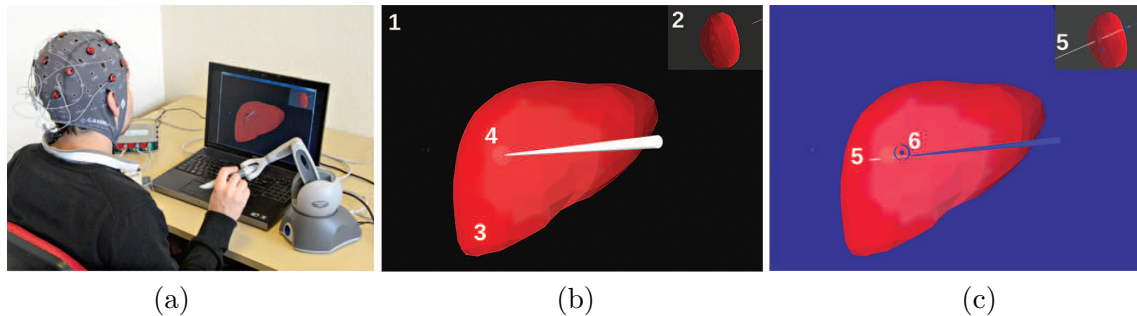

Figure 6.8 – A medical simulator in which the user inserts a needle into the liver to reach the tumor. (a) The setup, with an EEG headset, a display and a haptic device. (b) The 3D scene when visual and haptic assistance is not activated. (c) The scene when the simulator detects a high mental workload and activates assistance. The numbers indicate visual cues: 1 is the main view, 2 is a lateral view, 3 is the deformable liver, 4 is the tumor, 5 is a laser ray (pointing in the needle direction) and 6 is the best insertion point.

The simulator replicates two kinds of haptic interaction: the liver’s resistance to the needle’s penetration and stick-slip interaction when the user inserts the needle. When the needle touches the liver, the simulator computes the contact, using penalty-based methods. The simulator then redistributes the contact forces on the liver nodes, using a kernel function. If the force on the needle exceeds a given threshold, the needle penetrates the liver, which activates the second interaction mode. To replicate stick-slip interaction, the simulator first measures the needle’s insertion velocity. If the velocity exceeds a certain threshold, the simulator applies a viscous force. If the velocity is under this threshold, the simulator applies a resistance force. Finally, when the user reaches the tumor, the simulator also computes a reaction force.

The system provides visual and haptic assistance to help users better perceive the 3D scene and find the best penetration point and to guide them toward the tumor (see Figure 6.8.c). First, the simulator presents an infinite laser ray pointing in the needle direction so that users can better perceive the needle orientation. Then, it adds a blue target at the level of the best location for perforating the liver. The scene background switches from black to blue to indicate that visual assistance is active. The haptic assistance consists of a virtual force attracting the needle to the best insertion point. This force is proportional to the needle distance from that point. The passive BCI aims to identify two mental activities corresponding to high and low mental workloads. We used the machine-learning process we described before to differentiate between the two mental states. We trained the system with two initial tasks: a simple 3D manipulation and a difficult one. For the simple task, users touched very large 3D spheres with the haptic device. For the difficult task, they touched very small spheres in the same environment. The classifier provided online values (-1 for a low mental workload, indicating low manipulation difficulty, and $+1$ for a high mental workload, indicating high manipulation difficulty). The system smoothed these values and generated the median of the last 20 values every two seconds. The system directly used this index to toggle visual and haptic assistance. We preliminarily tested the simulator with 12 participants. We found it to be operational, and it worked with standard Input/Output devices.

6.4 Conclusion

In this chapter, we have presented our contributions on multimodal feedback, through the examples of different VR applications. We first introduced the multimodal feedback of fluids, showcased through scenarios such as walking through puddles or splashing on the beach. Our approach combines visual, auditory and vibrotactile feedbacks and uses a physically-based model for simulating user's interactions with fluids. We specifically proposed a vibrotactile model based on sound generation mechanisms, motivated by the fact that acoustic and tactile feedback are both vibrations that share a common physical source. Our illustrative scenarios showed that our approach could be suitable for both manipulating objects interacting with fluids and walking on grounds with fluids. We then proposed a second contribution called *King Kong Effects* that produces in a physically-plausible manner visual and tactile vibrations simulating the feet touching the ground at each step. Combined with acoustic feedback, our approach aims at improving the user's sensations of walking within virtual environments. Our multimodal approach was preferred to a single sensorial modality by the participants of our user study. Our third contribution was related to a project that adapts in real-time a guidance system's feedbacks to the user's mental workload. Thus, we designed and evaluated a VR setup that adapts haptic feedback according to the user's brain waves in real-time. We used passive BCIs to measure the user's brain activity. Our results suggested that such passive-BCI systems could be used to determine when users need assistance and to activate that assistance accordingly. We also proposed a first application of our approach with a medical training simulator that provides virtual assistance that adapts to the trainee's mental activity.

Through our two first contributions, we illustrated our approach of combining physically-based approaches with the use of 3D user interfaces to design multimodal VR setups enhancing the user's sensations. The main issue tackled through our work was the combination of the different sensorial modalities in real-time and in a physically-plausible manner. Our third contribution introduces a novel concept of user-adapted VR simulator that we proposed first through an haptic guidance system with adapted force feedback and then a medical simulator. Our results are promising and pave the way to VR systems that will automatically reconfigure and adapt their feedback to their users' mental states and cognitive processes.

The contributions of this chapter are respectively related to the PhD of G. Cirio (co-supervised with Dr. A. Lécuyer) and the PhD of L. Terziman (co-supervised with Dr. A. Lécuyer and Pr. B. Arnaldi). The work on adaptive VR simulators is a collaboration with L. George and Dr. A. Lécuyer (Inria Rennes).

Crossmodal feedback

7

Contents

8.1 Joyman: a human-scale joystick for navigating in virtual environments	111
8.1.1 Context and motivations	111
8.1.2 Approach	112
8.2 FlyVIZ: a display device to provide humans with 360° vision	114
8.2.1 Context and motivations	114
8.2.2 Approach	115
8.3 Conclusion	116

If we have presented in the previous chapters contributions where haptic, visual and acoustic feedback are combined in VR applications to obtain a multimodal answer, VR technologies sometimes suffer from non-available hardware components, notably haptic devices. In this chapter, we proposed **alternatives to classical multimodal approaches with the use of crossmodal approaches**. Our objective is to overcome the limitations of VR hardware devices, in our case especially for introducing haptic sensations through the use of the visual and the auditory modalities. Thus, we could introduce additional feedback to virtual environments that are limited to one sensorial modality, and increase the user's sensations. We illustrate our two contributions with applications to either navigation or manipulation scenarios in a virtual environment. Our first contribution proposes the **simulation of the sensation of walking up and down** in immersive virtual worlds based on visual feedback only. Our approach is an extension of the concept of pseudo-haptic feedback for the feet, with an application to navigation scenarios with uneven grounds in virtual environments. The main challenge of our approach relies on its use within immersive VR setup when physically walking, and thus the introduction of pseudo-haptic dedicated to the feet. Our second contribution introduces a novel pseudo-haptic feedback technique, called *Elastic Images* which enables the **perception of the local elasticity of images** without the need of any haptic device. The proposed approach focus on whether visual feedback is able to induce a sensation of stiffness when the user interacts with an image using a standard mouse. The main challenge of our work was to create a pseudo-haptic effect of stiffness when interacting with 2D content without the need of dedicated hardware.

7.1 Pseudo-haptic walking

7.1.1 Context and motivations

Surprisingly, most current virtual reality (VR) setups restrict users to walk on flat workspaces. Whilst this might seem appropriate for walking inside virtual buildings or virtual streets,

which are often flat, it becomes rapidly counter-immersive and inappropriate for any outdoor walking experience, such as when exploring a natural landscape. A main reason lies in the current difficulty to simulate, in the physical workspace, uneven grounds by means of mechanically actuated interfaces. As for today, few achievements have been reported on the design of devices that can render uneven grounds such as locomotion interfaces [Hollerbach 03, Iwata 01]. These interfaces remain costly, cumbersome and difficult to spread at the moment.

In order to simulate haptic sensations without haptic interfaces, other solutions have thus been proposed such as sensory substitution and pseudo-haptic feedback [Lécuyer 09]. Pseudo-haptic feedback was notably studied through the modification of the speed of a mouse cursor according to the “height” of a texture [Lécuyer 04]. As the mouse cursor explored an image representing a top view of a texture, an acceleration (or deceleration) of the cursor indicated a negative (or positive) slope of the texture. Experimental evaluations showed that participants could successfully identify macroscopic textures such as bumps and holes, by simply using the variations of the motion of the cursor. Approaches using camera movements were also proposed in order to modify the locomotion sensations in virtual environments. For instance, Steinicke et al. [Steinicke 09] used redirected walking techniques in order to modify the trajectory orientation of the user in the real environment. Camera oscillations could also be used to improve the sensation of walking in VE [Terziman 12]. However, these approaches are not dedicated to walking sensations on uneven grounds.

In some “first-person view” videogames, the camera velocity is progressively scaled up or down whether the avatar is going up or down a hill, providing a slope information. This effect could be considered as a straight transposition of the aforementioned pseudo-haptic texture. However, to our best knowledge there had been no study of the influence of such visual effects on the user’s perception of heights and slopes in virtual environments, and these effects have never been implemented within an immersive VR setup when physically walking. In our work, we proposed an extension of the concept of pseudo-haptic feedback for the feet. We also extended the concept to auditory feedback.

7.1.2 Approach

Principle

In [Marchal 10, Marchal 12], we studied the use of pseudo-haptic feedback for the feet to simulate uneven terrains. Our approach allows the simulation of the sensation of walking up and down in immersive virtual worlds based on visual feedback only. Our method consists in modifying the motion of the virtual subjective camera while the user is really walking in an immersive virtual environment. The modification of the virtual viewpoint is a function of the variations in the height of the virtual ground. Three effects are proposed: (1) a straightforward modification of the camera’s height, (2) a modification of the camera’s navigation velocity, (3) a modification of the camera’s orientation, as illustrated in Figure 7.1. The variations of the camera motion are used here to transpose the perception of climbing or descending a slope. The amplitude of the different effects is computed using the height information of the 3D virtual environment. Thus, the techniques can be used to simulate any uneven 3D terrain, assuming that we know its height map. The implemented algorithm computes an iterative solution (depending on the user motion) for the modification of the camera motion. When the user is moving in the VE, a theoretical displacement is measured and the amount of the camera motion is computed using this measurement. Then, the new position of the user is computed and transmitted to the

camera position and/or orientation. The visual techniques described here recall the ones used in videogames. However, unlike most gaming situations, our intention is to use them when the user is actually walking, i.e. superimposed to the visual feedback of the virtual scene.

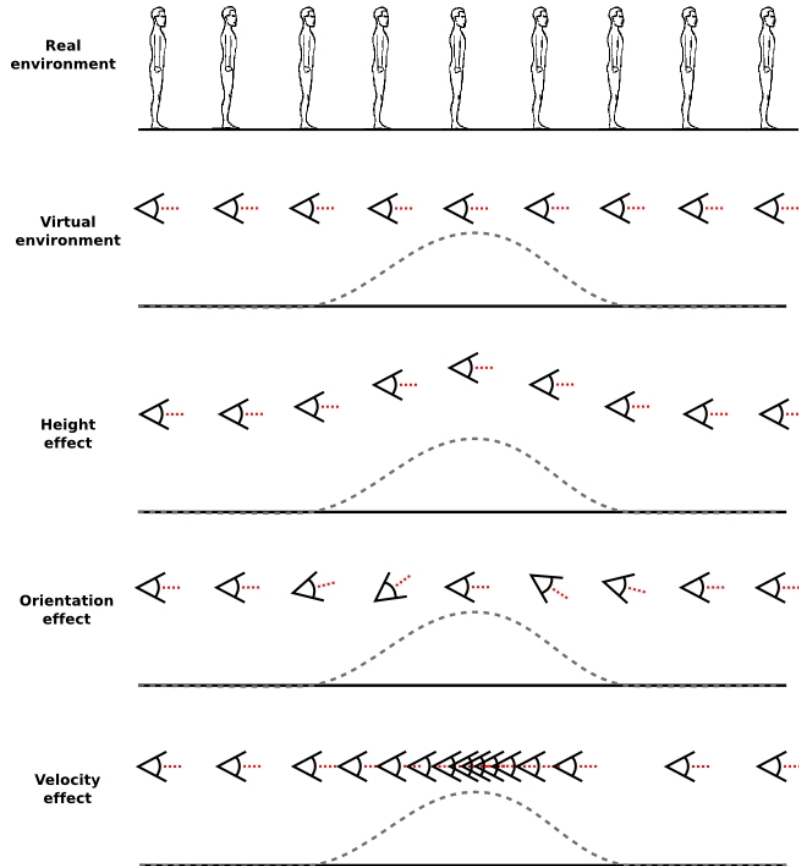

Figure 7.1 – Principle of the three different effects: the user is walking on a flat environment while the VE is composed of a bump. The camera motion is modified in three different ways: height variation (the camera moves with a constant orientation and a constant distance to the virtual ground surface), orientation variation (the camera is oriented following the curvature of the slope), velocity variation (the camera velocity decreases as the user is going up a virtual bump and increases as the user is going down with a run up at the end of the bump).

Evaluation

Our effects were tested in an immersive virtual reality setup in which the user is really walking while visual feedback of an Head-Mounted Display (HMD) is automatically modified by superimposing one or more of the aforementioned visual effects. A Desktop configuration where the user is seated and controls input devices was also tested and compared to the real walking configuration. In the experiment, our goal was to evaluate and compare the three different effects (Height, Orientation and Velocity) for the simulation of two canonical shapes: bumps and holes located on the surface ground of an immersive virtual environment. We also evaluated a fourth effect which is a combination of the three effects. Thus, we used: three different profiles (bump, hole and plane), two different types of walking locomotion (forward and backward movements) and four visual effects

(H: Height, O: Orientation, V: Velocity and HOV: combination of the three effects).

The experiment consists in testing each of the four visual effects (216 trials in total). The subject has to go forward and then backward in a virtual corridor. At the end of each movement (either forward or backward), the participant can give his answer concerning the identified shape (hole, bump, or plane). We performed an ANOVA accounting for the four different effects: it revealed a significant dependency between the effect and the probability of giving a correct answer for all the configurations. The results concerning the percentage of correct answers for the different shapes identified (i.e. Hole, Plane and Bump) are reported in Figure 7.2 for HMD and Desktop configurations, and detailed for forward and backward movements.

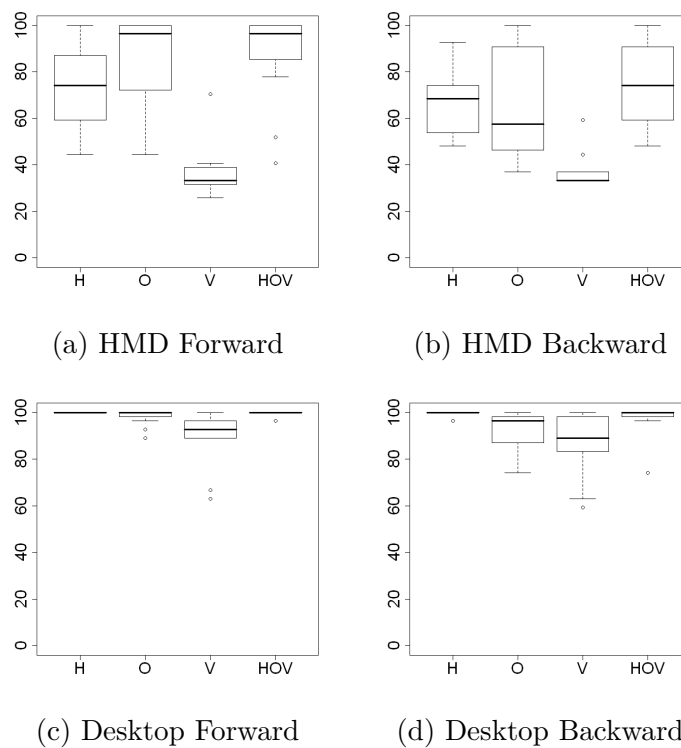

Figure 7.2 – Results: Percentage of correct answers for HMD configuration ((a) and (b) boxplots) or Desktop configuration ((c) and (d) boxplots). (a) and (c) represent the results for Forward movements, (b) and (d) represent the results for Backward movements. The 4 different effects are represented on each picture: Height (H), Orientation (O), Velocity (V) and the combination of the three previous effects (HOV). Each boxplot is delimited by the quartile (25% quantile and 75% quantile) of the distribution of the effect over the individuals. The median is also represented for each effect.

Experimental results show that our visual techniques are very efficient for the simulation of two canonical shapes: bumps and holes located on the ground. Interestingly, a strong "orientation-height illusion" is found, as changes in pitch viewing orientation produce perception of height changes (although camera's height remains strictly the same in this case). This was confirmed by subjective questionnaire in which participants estimated a higher amplitude for bumps and holes simulated with orientation technique.

Finally, the use of other modalities such as auditory feedback could also be envisaged with our approach, as we investigated in [Turchet 10].

7.2 Elastic images

7.2.1 Context and motivations

Stiffness perception of real and virtual objects has been widely studied in the haptics community. The most common study is to measure the capacity of humans to perceive different levels of stiffness using a dedicated haptic device. However, stiffness perception can be biased due to additional feedback. For example, as demonstrated by [Srinivasan 96] when a conflict between haptic and visual feedback appears, there is a visual dominance for stiffness perception. This visual dominance allows the simulation of a wider amount of stiffness levels by the combination of haptic and visual feedback. Pseudo-haptic feedback is able to simulate haptic sensations using visual feedback and properties of human visuo-haptic perception. In this context, the technique has been applied to simulate different sensations such as stiffness, friction or the mass of virtual objects. In the context of the interaction with 2D content, it has been used for the perception of relief of 2D images and textures using mouse based input [Lécuyer 04]. The main challenge of our work was to create a pseudo-haptic effect of stiffness when interacting with 2D content without the need of dedicated hardware.

7.2.2 Approach

In [Argelaguet 13], we aimed at further physicalizing the interaction with 2D content through the perceptual simulation of the physical properties of images, precisely we focus on stiffness simulation. We introduced the *Elastic Images*, a novel pseudo-haptic feedback technique which enables the perception of the local elasticity of images without the need of any haptic device. The proposed approach focus on whether visual feedback is able to induce a sensation of stiffness when the user interacts with an image using a standard mouse. The user, when clicking on a Elastic Image, is able to deform it locally according to its elastic properties. To reinforce the effect, we also propose the generation of procedural shadows and creases to simulate the compressibility of the image and several mouse cursors replacements to enhance pressure and stiffness perception.

The effect of pressing an image towards the screen is achieved by displacing the pixels towards the mouse cursor. Once the user presses the image, a smooth animation at pixel level is generated. We proposed an image-based algorithm where the amount of the displacement for each pixel depends on the distance between the mouse cursor and the pixel. As we are not using any pressure or haptic device, we chose to determine the force exerted by the user through the press time of the "virtual pressure". To increase the realism of the deformation, we proposed a method to generate shadows by modifying the luminance of the area being deformed. We also simulated the deformation of materials having a non-uniform deformation. An illustration of elastic image is provided in Figure 7.3.

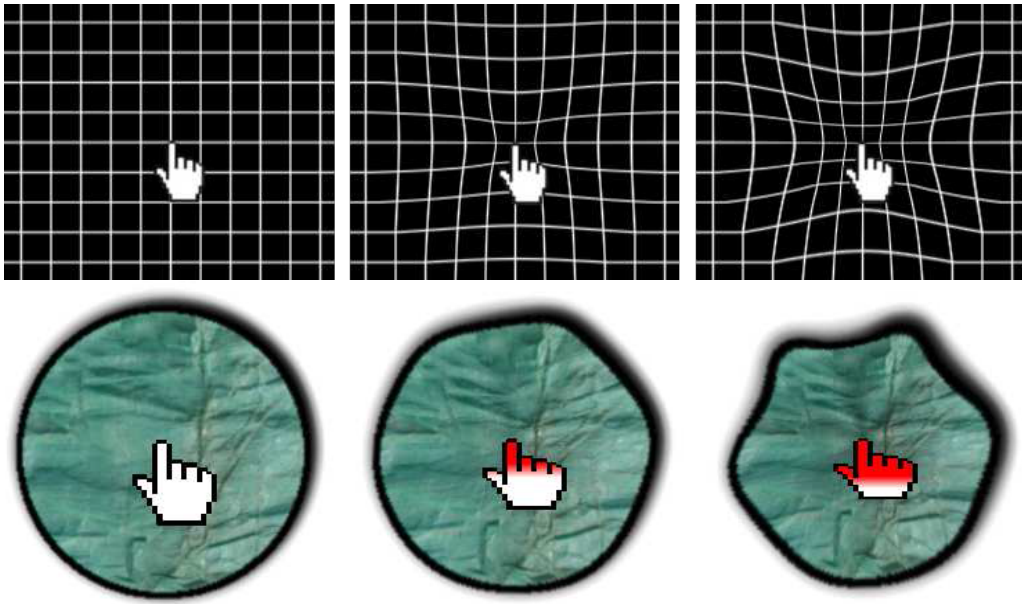

Figure 7.3 – Elastic image simulation. (Top) animation steps for the proposed image-based deformation as the virtual pressure exerted by the user increases. (Bottom) animation steps of the simulation of an elastic image with additional visual feedback.

A psychophysical experiment was conducted to quantify this novel pseudo-haptic perception and determine its perceptual threshold (or its Just Noticeable Difference). The results showed that users were able to recognize up to eight different stiffness values with our proposed method and confirmed that it provides a perceivable and exploitable sensation of elasticity. Users were particularly able to determine which image was stiffer, not only that there was a difference in the deformation, as illustrated with an image from our experiment in Figure 7.4.



Figure 7.4 – Example of the deformation of the sponge texture using the approach of Elastic Image.

7.3 Conclusion

In this chapter, we have proposed alternatives to classical multimodal approaches with the use of crossmodal approaches. Our objective was to overcome the limitations of VR hardware devices, in our case especially for introducing haptic sensations through the use of the visual and the auditory modalities. We introduced two contributions with applications to either navigation or manipulation scenarios in a virtual environment. With our

first contribution, we proposed the simulation of the sensation of walking up and down in immersive virtual worlds based on visual feedback only. We presented an approach that could be used within immersive VR setup when physically walking, thus introducing the concept of pseudo-haptic feedback for the feet. Experimental results showed that our visual techniques were very efficient for the simulation of two canonical shapes: bumps and holes, suggesting that our approach could be applied to navigation scenarios with uneven grounds in virtual environments. Thus, various VR applications such as urban or architectural project reviews or training, as well as video games could be envisaged. We also found through our evaluation an "orientation-height illusion" that opens challenging questions in terms of human perception and challenges our interpretations. With our second contribution, we introduced a novel pseudo-haptic feedback technique, called *Elastic Images* which enables the perception of the local elasticity of images without the need of any haptic device. Our approach proposed to induce a sensation of stiffness when the user interacts with an image using a standard mouse. Through the evaluation process, we showed that users were able to recognize up to eight different stiffness values with our proposed method and confirmed that it provides a perceivable and exploitable sensation of elasticity. The potential applications of the proposed approach range from pressure sensing in product catalogs and games, or its usage in graphical user interfaces for increasing the expressiveness of widgets.

In all of our contributions in this chapter, our objective was to overcome the limitations of VR hardware devices, in our case especially for introducing haptic sensations through the use of the visual and the auditory modalities. Thus, we were able to introduce additional feedback to virtual environments that are limited to one sensorial modality, and increase the user's sensations. We could also mention that we proposed other pseudo-haptic approaches combined with 3D interaction techniques, as we will describe in the next part. Crossmodal approaches bring interesting solutions when specific hardware devices are missing in VR applications, and open novel and challenging questions in terms of user's perception when navigating or manipulating objects within virtual environments.

The work on elastic images was a collaboration with Dr. F. Argelaguet, Dr. D. Gomez Jauregui and Dr. A. Lécuyer (Inria Rennes).

Part IV

3D Interaction Techniques with Complex Virtual Environments using Body Skills

Our research work on **3D interaction techniques with complex virtual environments** is reported in the following chapters. We decompose our contributions in 3 different chapters, following our general scheme detailed in Figure 7.5.

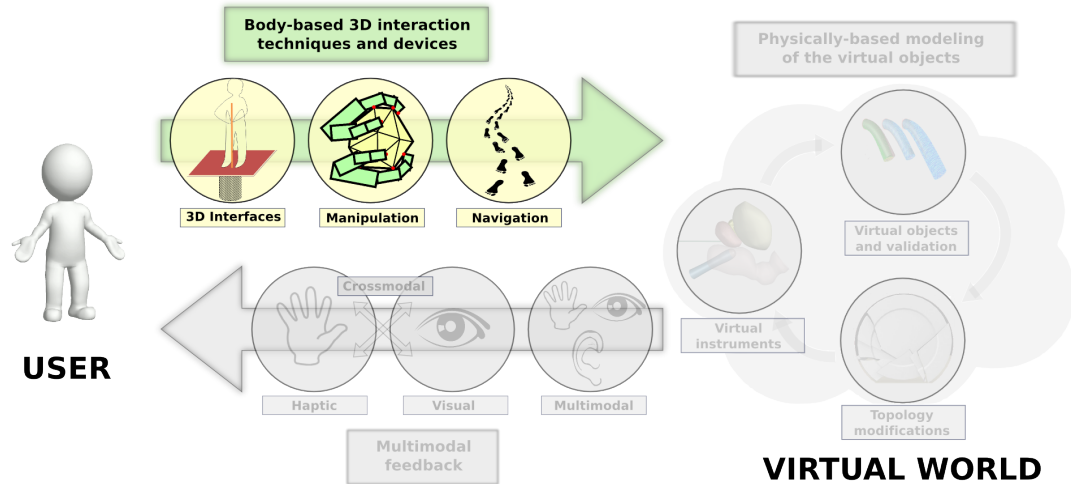

Figure 7.5 – Our third research axis is focused on the design of 3D interaction techniques and devices using our body skills for the interaction with complex virtual environments. The axis is decomposed in three parts. (1) We were first interested in the design of novel 3D interfaces for enhancing the body skills, as it will be addressed in chapter 8. (2) Besides the design of 3D interfaces, we were also interested in the manipulation of virtual objects. We focused our efforts on the design of interaction techniques with an increasing use of the hand motions and feedback possibilities, as we will detail in chapter 9. (3) We focused also our efforts on the navigation tasks in virtual environments. We proposed novel metaphors for natural walking in a VE, as we will describe in chapter 10.

Outline

When interacting with the virtual world, the user actions are generally translated into a command in the virtual environment through the use of interaction techniques and devices. The choice of the appropriate 3D user interfaces remains a key issue to translate the right information and thus increase the user’s immersion. One of the challenges for novel interfaces is to involve the body or to increase the user’s capacities. In chapter 8, we describe our contributions on the **design and evaluation of novel 3D interfaces for enhancing the body skills**. We particularly designed two interfaces, one aiming at preserving equilibrioception in order to improve the feeling of immersion during virtual locomotion tasks and the second increasing the human field-of-view for better manipulation and navigation in virtual environments.

Besides the design of novel interaction devices, the choice for appropriate interaction techniques plays a key role for enhancing the 3D interaction with the virtual world. Thus, techniques dedicated to specific body skills are of interest for improving the different tasks of the user. Among the fundamental tasks in VR, the manipulation of virtual objects has already been explored through several approaches, mainly for one hand manipulation often referred as the dominant one. However in our daily lives, we commonly use other parts of our body to manipulate objects, such as our two hands simultaneously for example. The last improvements on hardware setups made now possible novel motion measurements for different body parts or with a higher accuracy, such as the fingers for instance. Thus, the

design of manipulation techniques that better integrate different body skills could now be envisaged. In chapter 9, we present some of our contributions on **3D interaction techniques for manipulating virtual objects**. Among the body skills that we explored in our approach, we were particularly interested in the use of the two hands of a user through bimanual tasks but also multi-finger interaction.

Besides the manipulation techniques, a growing interest has been observed this last decade for navigation interaction techniques. The recent development of large VR setups as well as the improvement of hardware interfaces led to the design of novel interaction metaphors for improved locomotion in VE. One objective is to obtain natural walking in a virtual environment. This objective raises technical issues when hardware interfaces are missing or the VR setups are not large enough to allow for a large range of steps of the user. In chapter 10, we propose our contributions on navigations techniques through **novel metaphors easing the walking** in complex scenarios such as very large virtual environments or with different types of trajectories. We particularly used different body information such as the head orientation or the combination of hands and feet motions.

3D interaction devices

8

Contents

9.1 Virtual Mitten: an interaction paradigm for visuo-haptic manipulation of objects using grip force	120
9.1.1 Context and motivations	120
9.1.2 Approach	120
9.2 Bimanual interaction techniques	122
9.2.1 Context and motivations	122
9.2.2 Approach	123
9.3 Conclusion	126

With the novel 3D input devices becoming widely available even for the general public, research in new 3D user interfaces is more relevant than ever. With 2D applications, people would generally use a 2D mouse and a keyboard whilst high-level VR applications propose motion capture systems for 3D tracking or haptic devices for example. In this domain, one of the challenges for novel interfaces is to try to involve the body or to increase the user’s capacities. This new type of interface should allow 3D interaction in virtual worlds using novel body skill interaction. In this chapter, we describe our contributions on the **design of novel 3D interfaces for enhancing the body skills**. Our first contribution is a novel interface called **Joyman**. The interface is based on the metaphor of a human-scale joystick and is designed for navigating in virtual environments. The Joyman aims at preserving equilibrioception in order to improve the feeling of immersion during virtual locomotion tasks. Thus, it explores the feasibility of an interface that uses all the user’s body for navigating in the virtual world. Our second contribution is a novel display device called **FlyVIZ**. The FlyVIZ system aims at increasing the human field-of-view for better manipulation and navigation in virtual environments. The display device enables humans to experience a real-time 360° vision of their surroundings, opening novel possibilities in terms of user’s perception. Both contributions are proofs of concept of novel 3D interfaces involving novel body skills or increasing the user’s capacities.

8.1 Joyman: a human-scale joystick for navigating in virtual environments

8.1.1 Context and motivations

When navigating in virtual environments, the possibility to walk inside the VE is necessary in many VR applications such as for virtual visits (review of architectural and urban projects), training tasks or videogames. However, it is still a challenge to allow a user endlessly walking a virtual world in an immersive manner when the physical real workspace

is limited. The difference between the dimensions of the real and virtual worlds prevent from tracking users and directly transposing the walking motion into the virtual world.

In order to provide VR users with realistic sensations of walking while keeping them in their limited workspace, numerous types of VR interfaces have been proposed so far. Thus, several types of peripheral devices have been proposed. Simple manual devices such as keyboards, mices or joysticks are widely available. They allow users to indicate their locomotion wills into the virtual world but only involve the users' hands and arms whereas real locomotion involves all of the human limbs. Thus, they cannot be satisfactory used in the frame of immersive applications. Locomotion interfaces made of sophisticated treadmills and tracking systems have been designed to improve the walking sensations in VR [Iwata 01, Stanney 02]. They enable users to endlessly walk while their global displacement is mechanically compensated. Such systems remain however highly expensive and cumbersome and necessarily distort the vestibular sensory feedback *i.e.*, equilibrioception, due to motion compensation. Finally, software solutions have been proposed to enhance the sensations of walking in VR. Some techniques [Pausch 95, Razzaque 01, Cirio 09] allows the user to really walk in the real workspace without reaching its limits but do not prevent break of immersion or need a big real workspace. Other techniques such as the Walking-In-Place paradigm [Slater 95] preserve both the immersion and the real somatosensory feedback as users virtually walk by performing real walking motions. But the absence of real global displacement neglect equilibrioception for the benefit of proprioception.

Thus, we proposed to explore the use of an interface that aims at preserving equilibrioception in place of proprioception in order to improve the feeling of immersion during virtual locomotion tasks. It is often said that walking is constantly falling ahead. It is also known that head trajectory precedes the global locomotion trajectory. This justifies our work direction towards the design of a device involving the vestibular system that stands in the human head. Our second objective is to study affordable devices and propose a new interface that does not involve either active mechanical devices or complex tracking systems.

8.1.2 Approach

In [Marchal 11], we proposed a novel interface called Joyman, designed for immersive locomotion in virtual environments. The concept of our interface is illustrated in Figure 8.1.

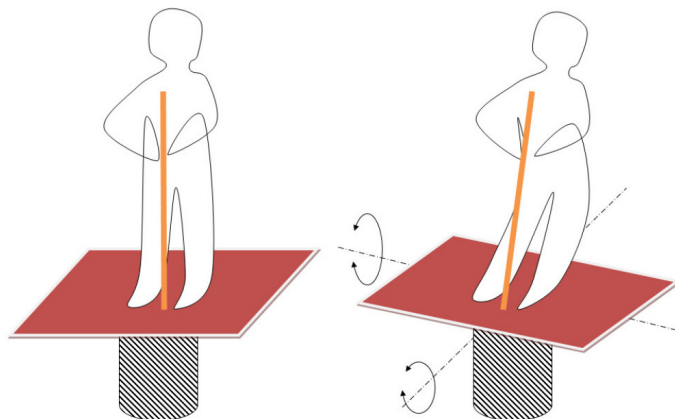

Figure 8.1 – Principle of the Joyman interface for walking into virtual worlds. Following the example of joystick and standing on an articulated platform, users indicates their desired walking direction by leaning.

The device has a simple mechanical design that allows a user to indicate his virtual navigation intentions by leaning accordingly. The design mainly consists of a board upon which the user stands. The inclination of this board can be changed by the user. Thus, the user indicates the desired locomotion direction by tilting the platform in the corresponding direction. The mechanical design of the platform allows the user to change the platform inclination by leaning and prevents him from falling, whereas repelling forces tend to maintain the platform horizontal. The design meets the requirements of the limited real workspace while preserving the locomotion sensations. It does not involve either active mechanical devices or complex tracking systems. An inertial sensor allows to acquire the current orientation of the board. The Joyman interface is illustrated in Figure 8.2.

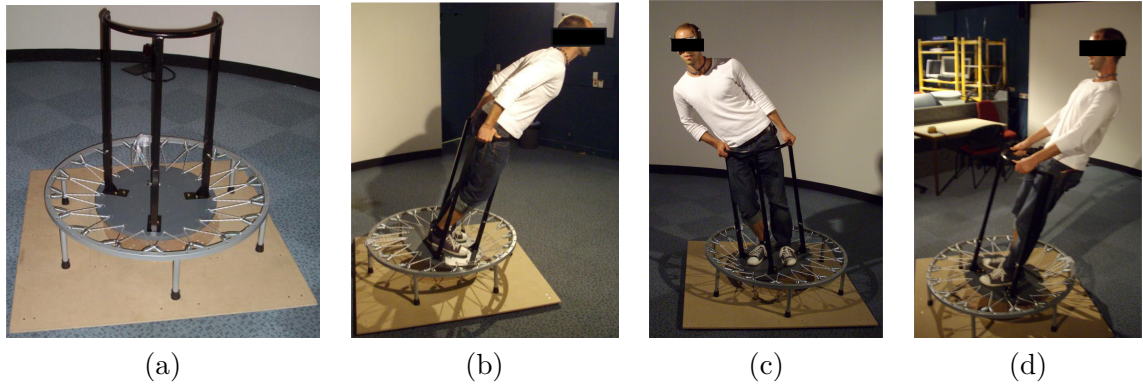

Figure 8.2 – Illustration of the peripheral device. (a) the device is composed of a basis, a board to support the user and a safeguard. (b, c, d) When using the Joyman, users can stand straight on the board, repelling forces make easy keeping the platform inclination. Users have to lean to start locomotion in virtual worlds. All the leaning directions are possible.

In addition of the interface, we proposed a virtual locomotion control to translate the user's motions into a virtual trajectory. The main steps of this control are summarized in Figure 8.3. The virtual motion is velocity controlled. We assume the virtual trajectory is non-holonomic, which means that the velocity vector orientation and the body orientation are always identical.

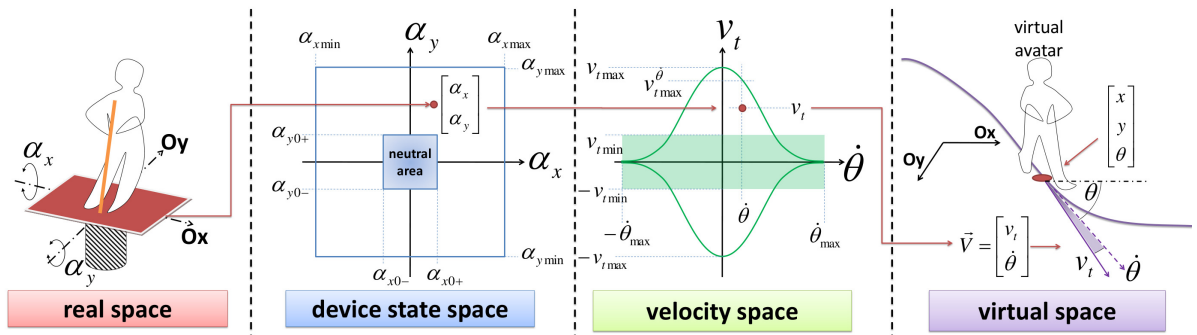

Figure 8.3 – Summary of the different steps for the virtual locomotion control. From the position and orientation of the Joyman, we can compute the virtual velocity vector by using the locomotion model and control law that we proposed. The control law allows users to modify the virtual velocity vector V by standing on the device and leaning. The modification of the platform orientation affects the state of the device. The virtual velocity vector is deduced from the state of the device at each time step, following our control law.

Our control law is inspired by the biomechanics of the human locomotion to transform the measured leaning angle into a walking direction and speed *i.e.*, a virtual velocity vector. This law express attainable turning velocities as a function of the tangential one: it has been observed that the faster the walk the lower the attainable turning speed.

We performed an evaluation in order to evaluate the advantages and drawbacks of the proposed interface compared to the joystick, a classical peripheral often used in VR applications. We obtained promising results as the users enjoyed the navigation with our new interface. Presence and realism in the virtual rotations were also underlined. The evaluation also opened several future work directions to improve and extend our interface. The Joyman was shown during demos such as Siggraph Asia Emerging Technologies and we have recently built a second version, in collaboration with CL Corporation company, as illustrated in Figure 8.4.

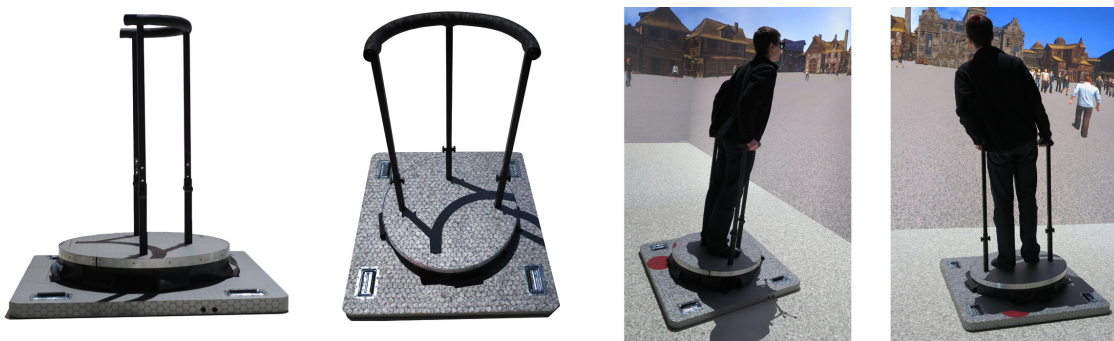

Figure 8.4 – Illustration of the second version of the Joyman.

8.2 FlyVIZ: a display device to provide humans with 360° vision

8.2.1 Context and motivations

The distortion or extension of human vision has been investigated in several scientific fields such as Neuroscience (e.g., for studying visual perception and brain adaptation using prisms [Harris 65]), or Augmented Reality (e.g. by superimposing artificial information onto the naturally perceived images [Barfield 00]). In the artistic domain, some performers have also developed systems that can extend human vision, such as the 3RDI project presented by the artist Wafaa Bilal. However, there is no work that proposes a display to experience full 360° vision of one's surroundings in real-time.

The human field of view (FoV) is limited to 180 degrees horizontally and 110 degrees vertically. Increasing the natural FoV is actually very difficult to achieve with traditional optical devices. In our work, we proposed to combine a Head-Mounted Display (HMD) with a panoramic image acquisition system to increase the FoV. The typical horizontal FoV of research or commercial HMDs ranges from 24° to 187°, even if efforts are regularly made to extend the FoV of HMDs. Concerning the combination of HMDs with panoramic cameras, it has been scarcely studied up to now. Few examples exist in the teleoperation field. However, the image displayed in the HMD is not a panoramic image [Nagahara 03]. Enhancing the natural human FoV up to 360° in real-time fulfills a dream of humans: to be able to "see behind their back" or see like some animals, such as flies, with a wider FoV, even reaching a fully panoramic vision.

8.2.2 Approach

In [Ardouin 12], we presented a novel display device called FlyVIZ which enables humans to experience a real-time 360° vision of their surroundings. To do so, we combined a panoramic image acquisition system (positioned on top of the user's head) with a HMD. The omnidirectional images are transformed to fit the characteristics of HMD screens. As a result, the user can see her surroundings, in real-time, with 360° images mapped into the HMD field-of-view.

The device illustrated in Figure 8.5 is based on three components: (1) an acquisition system (e.g., a catadioptric sensor for capturing 360° images), (2) a Head-Mounted Display (HMD) to display the processed images to the end-user in real-time, and (3) a computer vision algorithm to map the captured 360° images to the shape and dimensions of HMD screen.



Figure 8.5 – Illustration of the FlyVIZ prototype.

The image acquisition is performed with a catadioptric sensor, e.g. the combination of a camera with a mirror. We used a hyperbolic mirror and a traditional 6mm-lens mounted on a CCD camera in our first prototype. The image acquisition system is mechanically attached on a helmet. An example of an image acquired by the system is given in Figure 8.6.a. Then the acquired image is transformed into an image that can be displayed in the HMD (see Figure 8.6.b). The image transformation is achieved in two successive steps, which correspond to two different projections: (1) projection between a location on the final displayed image and a direction of the space, (2) projection between a direction of the space and its respective location in the acquired image. For the first projection, we used an equirectangular projection. The second projection corresponds to the calibration of our optical system. The equations map a 3D space vector to its corresponding location in the acquired image. The projections are computed in real-time thanks to our software implementation that benefits from parallel processing power provided by modern GPUs.

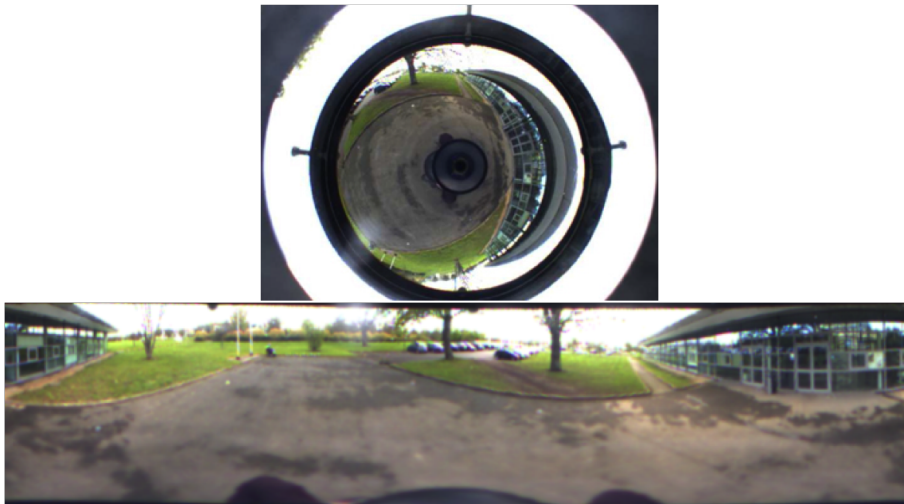

Figure 8.6 – (Top) Image provided by the catadioptric system. (Bottom) Image displayed in the HMD after its modification.

The FlyVIZ system proved to be fully operational and has been tested by multiple users and in different conditions (e.g., indoor or outdoor), even when driving a car (see Figure 8.7).



Figure 8.7 – Illustrative example: driving a car on a parking lot (HMD view).

The unbalanced weight of the headset (helmet, camera and optics) has been improved in a second version currently used for our demos in wide-audience events. There are different application fields that could benefit from an enhanced FoV. In safety and security applications, soldiers, policemen or firemen could benefit from omnidirectional vision to avoid potential dangers or locate targets more rapidly. In less critical situations, some surveillance applications with a high visual workload, in all directions of space for instance, could also be concerned, such as for traffic regulation. Considering the novel perceptual experience proposed, FlyVIZ could also be transformed into entertaining applications and devices, as well as experimental materials for new perception and neuroscience studies.

8.3 Conclusion

In this chapter, we have presented our contributions on the design of novel 3D interfaces for enhancing the body skills through two contributions. Our first contribution called Joy-man proposes a proof-of-concept of an interface that preserves equilibrioception in order to improve the feeling of immersion during virtual locomotion tasks. The interface was built on the metaphor of a human-scale joystick dedicated to the navigation in virtual environments. We also proposed a control law inspired by the biomechanics of the human locomotion to transform the measured leaning angle of the interface into a walking direction and speed in the virtual world. The interface was evaluated and showcased in different

venues, with various potential applications, either for virtual visits, video games or rehabilitation. Our second contribution called FlyVIZ extends the human field-of-view for better manipulation and navigation in virtual environments. The display device enables humans to experience a real-time 360° vision of their surroundings. A specific projection algorithm is proposed to transform the image acquired with a catadioptric system to a HMD screen. Illustrative scenarios showed the feasibility of the approach and, as for the Joyman, the FlyVIZ was showcased in different venues with general audience. Furthermore, the device opens novel possibilities in terms of user's perception and could be used in neuroscience studies. Potential applications are in different fields where augmented human capacity could benefit, such as surveillance, security or entertainment.

Both contributions are proofs of concept of novel 3D interfaces involving novel body skills or increasing the user's capacities. Other body skills could be explored but also the brain activity. Thus, we could mention one of our recent contributions for novel 3D interfaces called the Mind-Mirror and that allows the user to see her brain in action using a brain-computer interface and an augmented reality system [MercierGanady 14]. The improvements and the wide availability of 3D VR setups open the possibility of many novel 3D interfaces that can now involve the body. Besides the design of the appropriate 3D interfaces, the interaction techniques that are used together should also be designed with appropriate properties to fully exploit the possibilities of the novel 3D interfaces. In the next two chapters, we will detail some of our contributions for the design of such 3D interaction techniques.

The Joyman interface is issued from a collaboration with Dr. J. Pettré and Dr. A. Lécuyer (Inria Rennes). The FlyVIZ is related to the PhD of J. Ardouin (co-supervised with Dr. A. Lécuyer and Dr. E. Marchand).

3D manipulation techniques

9

Contents

10.1 Navigation in large virtual environments within restricted real workspaces	128
10.1.1 Context and motivations	128
10.1.2 Approach	128
10.2 Shake-Your-Head: a navigation technique revisiting walking-in-place	131
10.2.1 Context and motivations	131
10.2.2 Approach	132
10.3 Conclusion	134

For enhancing the 3D interaction with the virtual world, the choice of appropriate interaction techniques that exploit at best the user's inputs plays a key role in the user's perception. Novel motion measurements for different body parts are nowadays possible with the last improvements on hardware setups. Thus, the design of interaction techniques that better integrate different body skills could now be envisaged. It is particularly the case for the manipulation of virtual objects, one of the fundamental tasks in VR, that has already been explored through several approaches in the literature. In our daily lives, we commonly use our two hands to manipulate objects. The interaction techniques for manipulating virtual objects are however generally restricted to one hand manipulation often referred as the dominant one. Two hands manipulation or finger interaction are scarcely studied. In this chapter, we present some of our contributions on **3D interaction techniques for manipulating virtual objects**. Our objective is to better explore the hands' specificities during the manipulation tasks in virtual environments. Our first contribution called the Virtual Mitten relies on the **manipulation of virtual objects through grasping** actions. Our interaction paradigm aims at providing haptic sensations to naturally grasp and manipulate objects through the use of a passive haptic device. Thus, the objective is to enhance the virtual hand skills during the manipulation tasks in the VE. Our second contribution proposes novel **3D interaction techniques for bimanual tasks**. These techniques propose to tackle the issues related to the manipulation of objects using the two hands and bring improvements for navigation and grasping scenarios. Both contributions attempt to improve 3D interaction techniques through the use of body skills and could then be applied in various scenarios.

9.1 Virtual Mitten: an interaction paradigm for visuo-haptic manipulation of objects using grip force

9.1.1 Context and motivations

As object manipulation is a fundamental task in virtual reality applications, several methods have already been proposed to grab and manipulate virtual objects by moving hands in 3D space [Moehring 11, Borst 05, Jacobs 12]. These techniques may rely on optical tracking [Schlattman 07] but the anatomical complexity of the human hand makes the accurate tracking of manual gestures a difficult task. In addition haptic feedback is often missing, although it is an important cue for manipulating virtual objects. Haptic devices enable to manipulate virtual objects and generate interaction forces towards the user but generally require specific interaction metaphors that do not always reproduce the natural dynamics of grasping. Active hand-mounted devices enable to accurately track the hand and to feel virtual objects with the fingers [Bouzit 02] but they remain rather complex and costly. Although alternative means of haptic stimulation have been proposed (e.g. vibrotactile feedback or passive haptic feedback), they seem currently limited for providing a convincing haptic perception in the context of manipulation tasks, especially for grasping.

9.1.2 Approach

In [Achibet 14], we proposed a novel interaction paradigm called the *Virtual Mitten* to naturally grasp and manipulate virtual objects with haptic sensations. This paradigm is based on a handheld elastic device that maps the motion of the user's hand to a virtual mitten capable of interacting with virtual objects. Figure 9.1 illustrates the concept of the Virtual Mitten. The visual metaphor -a mitten with a generic folding animation- provides a natural mapping between real and virtual environments.



Figure 9.1 – Illustration of the Virtual Mitten. Each hand holds an elastic device to control a corresponding virtual mitten (in gray) and to grasp virtual objects in a bimanual scenario. The grip force applied by the user is measured to generate pseudo-haptic feedback.

The grasping of an object and the following interaction depends on the grip force applied on the elastic device. Due to its internal elasticity, our device provides a passive force feedback and enables the perception of efforts in the context of manipulation tasks occurring within the virtual environment. The elastic device used is simple in nature as well as low-cost. Nevertheless, it effectively provides relative haptic sensations enhancing grip-based interaction with virtual objects. We engineered the device so that it could be

coupled with an optical tracking system in order to retrieve its position and orientation in 3D space (6DoF) as well as its compression (1DoF), as illustrated in Figure 9.2. Moreover, its small dimensions and its low weight preserve the freedom of movement of users within the virtual environment.

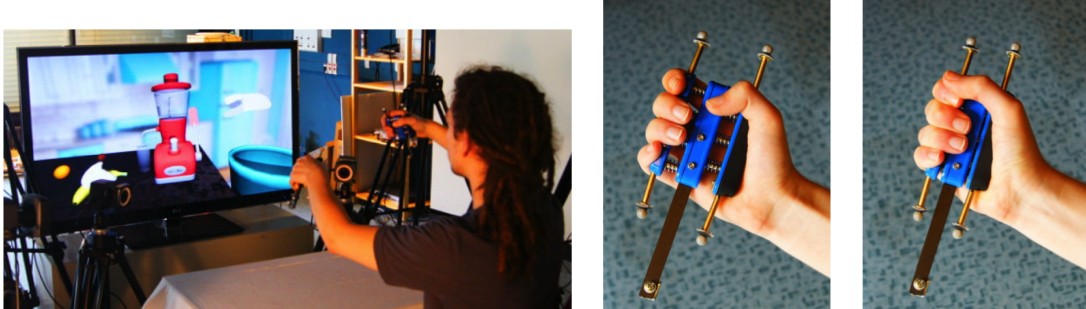

Figure 9.2 – Our elastic input device is a consumer-grade hand exerciser equipped with markers for optical tracking: (Middle) the device is fully relaxed while (Right) it is fully compressed.

The Virtual Mitten is associated to a control scheme that allows users to control mittens representing their own hands (both unimanual and bimanual scenarios are possible). This control scheme allows us to operate mittens in a unified manner that is truthful to the real dynamics of grasping: first, mittens are moved in space, then fingers come into contact with targeted objects. We proposed a naturalistic approach to reproduce the true dynamics of grasping. To select an object for further interaction, the mitten has to be placed in a valid grasping configuration around the targeted object, that is, there must be at least one contact between thumb and object and at least one contact between merged fingers and object. To validate this condition and bring the digits of the mitten closer to an object, the user has control over the clenching of the mitten. A finger folding animation is triggered when a slight compression of the device is detected (the compression ratio of the device is superior to a threshold $r_{folding}$). Once an object is selected, users have to apply a sufficient amount of force on the elastic device to grasp the targeted object securely and not let it slip. We introduced another threshold $r_{grasping}$ to formalize the grasping condition. In addition, we introduced a pseudo-haptic feedback in order to allow the perception of different levels of effort, as illustrated in Figure 9.3.

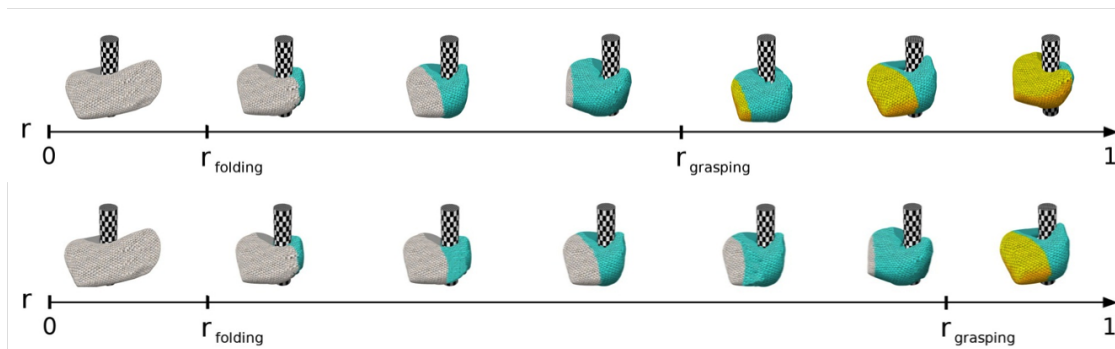

Figure 9.3 – Our pseudo-haptic approach with the evolution of the grip force when grasping a virtual cylinder. The $r_{folding}$ threshold is fixed while the $r_{grasping}$ threshold varies in order to accommodate our pseudo-haptic effect. A progressive visual feedback composed of different colors informs the user about the different thresholds.

The general principle of our pseudo-haptic approach is that the higher the magnitude of the simulated haptic property is, the higher the $r_{grasping}$ threshold that has to be reached is. This pseudo-haptic feedback thus replaces the unique $r_{grasping}$ with object-specific $r_{grasping}$ thresholds that associate a haptic property with a required grip-force.

We proposed different scenarios to illustrate the Virtual Mitten approach. One of our scenarios is called the Fruit-o-Matic and involves a series of primitive manipulation tasks, as illustrated in Figure 9.4. The goal is to prepare fruit juice with a blender. Users are provided with two elastic devices so that both of their hands can interact with the virtual environment. Various virtual objects can be grabbed and moved around with the mitten: fruits, the lid of the blender or a glass. Fruits can be squeezed above the blender to extract their juice. Each fruit has a different internal stiffness and requires a different amount of effort to be pressed. A dial has to be turned to mix the juices. Finally, a lever must be pulled to pour the mixed juice into the glass.



Figure 9.4 – The "Fruit-o-Matic", an entertaining use-case with the Virtual Mitten. The preparation of a fruit juice involves sub-tasks such as grabbing objects, squeezing fruits, rotating a dial to operate the blender and pulling a lever to pour the juice.

We also performed a user study to assess the acceptance of our novel interaction paradigm by naïve participants and the perception of the pseudo-haptic feedback. The results suggested first that the Virtual Mitten allows us to reliably manipulate virtual objects in various primitive manipulation tasks (pulling a drawer, pulling a pin, screwing a cylinder, pulling a lever). A psychophysical test showed that four different levels of effort could be successfully perceived in a basic screwing task.

9.2 Bimanual interaction techniques

9.2.1 Context and motivations

Single-point haptic devices are commonplace, and an efficient way to interact with virtual environments two-handedly with rigid proxies. Due to the simplicity of those models as well as the low number of contact points generated by such proxies, haptic rates can be more easily achieved using them. However, some issues arise when interacting with a VE using those interfaces, which are two-fold. Firstly, most of these interfaces are grounded and have very limited workspaces, which is problematic when attempting to navigate

within a large VE. Workspace extension techniques such as clutching, rate control or scaling factors tend to be either unintuitive or unpractical for such scenarios. Secondly, the low number of interaction points leads to more difficult manipulation of virtual objects with simple proxies. Picking a virtual object two-handedly with single-point devices is similar to picking a real object with only one fingertip of each hand, which is undoubtedly challenging. This is especially the case with 3DOF interfaces, as the proxies can no longer be oriented to approach an object to be grasped from an optimal angle.

9.2.2 Approach

In [Talvas 12, Talvas 13], we proposed bimanual haptic interaction techniques that address the issues related to bimanual interaction with dual single-point haptic interfaces, and take into account hand asymmetry as well. These techniques include a bimanual navigation technique, a method to improve navigation during grasping, a grasping detection method, and a two-handed haptic manipulation technique.

The double bubble technique for bimanual navigation

The *double bubble* technique allows free motion with both hands in a VE, with a viewport adaptation method that maintains both virtual proxies within the field of view. The technique is inspired from the bubble technique [Dominjon 05] where precise manipulation is achieved by using position control within certain spherical boundaries delimited by a bubble. When reaching outside of the bubble, the control scheme switches to rate control, in which the bubble moves within the VE at a constant velocity depending on the distance from the interface to the boundaries of the bubble.

In the double bubble technique, both devices have their own bubble, divided into two areas associated to a control model. For each device, an inner area controls directly the position of the proxy, and an outer area moves the corresponding bubble in velocity within the VE, as illustrated in Figure 9.5. Additionally to the haptic feedback of the original bubble technique provided during rate control, a visual feedback is also added in the form of a motion trail behind the proxy. The method can be used with devices that have non-spherical workspaces, by fitting the physical workspaces with the boundaries of the bubble. We also proposed a method to adapt the viewpoint so as to keep both proxies visible.

The joint control technique for navigation during grasping

The *joint control* facilitates the exploration of a large VE while manipulating objects by ensuring control modes and velocities are the same when interacting with the same object. The technique prevents from some issues related to a difference in control modes for the two bubbles. A grasping detection method allows to determine when a user attempts to effectively pick an object between two rigid proxies. The joint control technique enforces a common control scheme for both bubbles, meaning that both bubbles enter rate control as soon as at least one device reaches its boundaries. It also enforces a common velocity during rate control, which is the average of both velocities. This technique thus allows easier exploration of a VE while holding an object between rigid proxies, as illustrated in Figure 9.6.

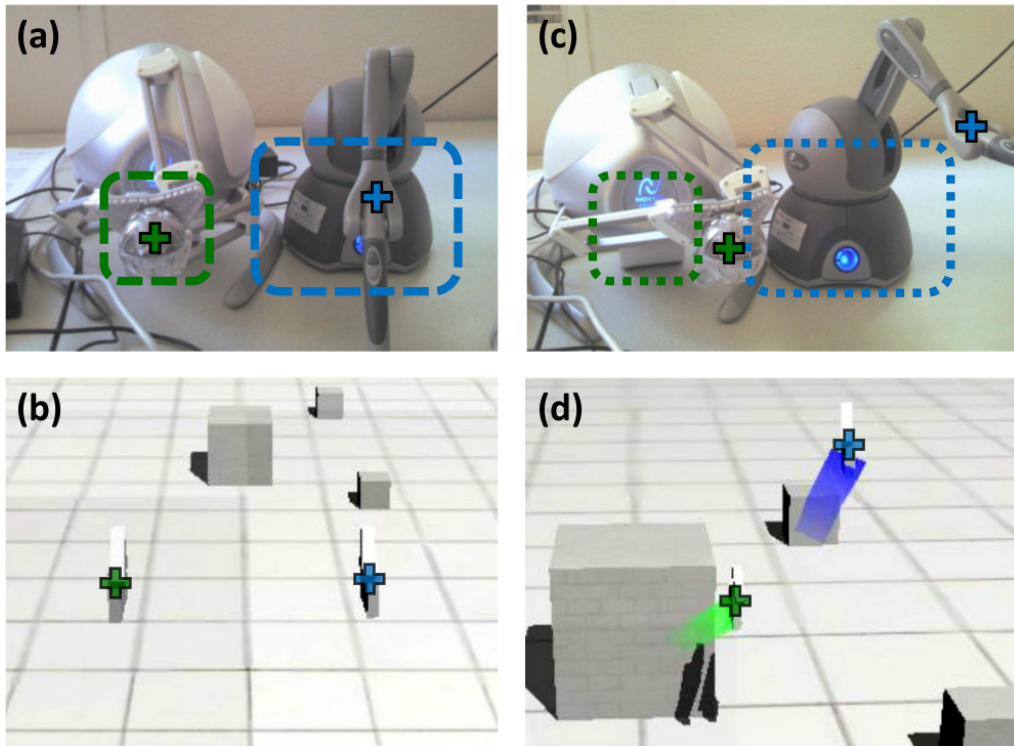

Figure 9.5 – Control modes of the double bubble. (a-b) Devices inside the bubbles: position control mode. (c-d) Devices outside the bubbles: rate control mode, indicated by colored trails.

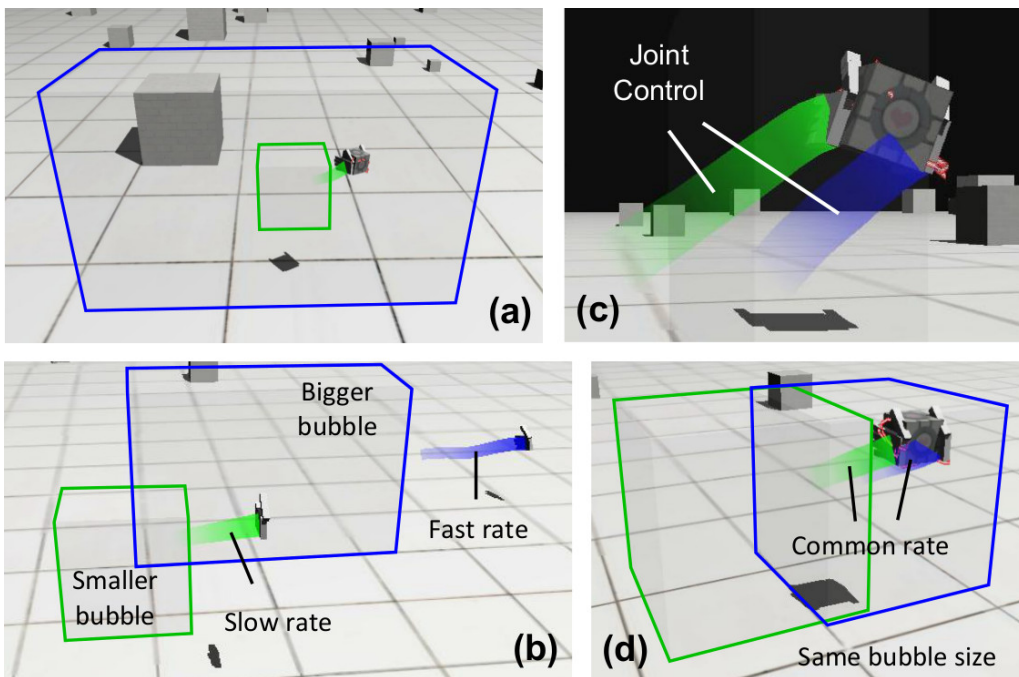

Figure 9.6 – Illustration of the joint control technique. (a) Carrying an object without joint control; case where the smaller bubble (left) is in rate control and not the bigger bubble (right). (b) Difference in bubble size and workspace translation speed without joint control. (c-d) Carrying an object with joint control.

The magnetic pinch for grasping objects

Grasping with single-point interfaces is a challenging task, as rigid proxies provide a small amount of contact points that is often insufficient to perform stable grasping. Objects tend to be dropped unintentionally while attempting to move them, which raises the need for manipulation techniques to keep objects attached to the proxies. This, in turn, requires grasping detection techniques, in order to know when to activate and deactivate these manipulation techniques.

A grasping detection method is required in order to detect when a user is actually attempting to pick an object and not simply touching it. We consider three conditions to determine whether both hands are grasping an object or not, according to the contact normals, the contact forces, and the relative position of both hands (see Figure 9.7).

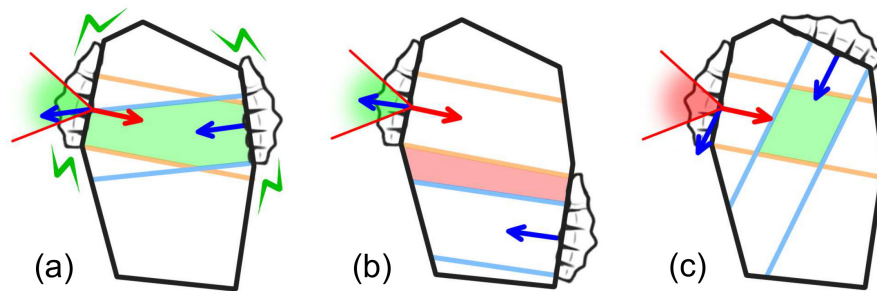

Figure 9.7 – Different cases of dual contact with a virtual object, case (a) being appropriate for grasping and cases (b-c) not being as such: (a) Normals nearly colinear and hands face-to-face, (b) Hands not in front of each other, (c) Normals far from colinearity.

Once a grasping situation is detected, the *magnetic pinch* takes effect, which "magnetizes" both hands to the picked object to prevent unintentional drops from happening. A visual feedback is also added to the haptic feedback in the form of red bolts, emphasizing the activation of the technique to the user, as illustrated in Figure 9.8. The magnetic pinch uses either springs or constraints to keep the virtual proxies from unintentionally dropping an object grasped with both hands.

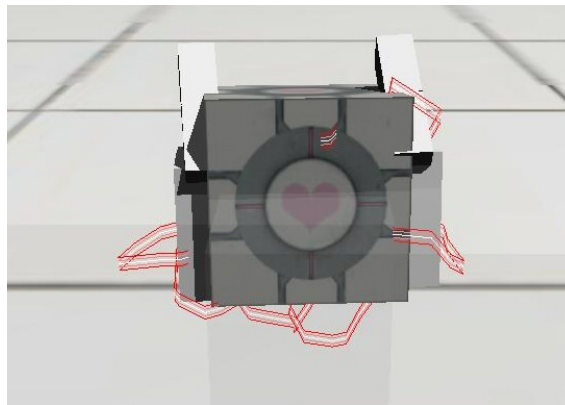

Figure 9.8 – Visual feedback of the magnetic pinch, symbolized by red bolts between virtual proxies and picked object.

Evaluation

The techniques were evaluated against state of the art navigation and manipulation techniques, in terms of speed, accuracy, and user appreciation. The user experiment showed that the manipulation techniques could lead to faster completion of a pick-and-place task, with less undesired drops of the object and overall better user appreciation compared to conditions that did not use them, such as the clutching technique for instance. The proposed techniques are thus efficient for simplifying the picking and carrying of an object. The double bubble, when used jointly with these techniques using joint control, reduced even further the time needed to complete the task, outperforming the clutching technique. Overall, the combination of all of these techniques was shown to be very efficient for extending the workspaces of different haptic interfaces and allowing bimanual manipulation of objects with single-point interfaces in large VEs.

9.3 Conclusion

In this chapter, we have presented some of our contributions on 3D interaction techniques for manipulating virtual objects. Our first contribution called the Virtual Mitten is dedicated to the manipulation of virtual objects through grasping actions. Our interaction paradigm aims at providing haptic sensations to naturally grasp and manipulate objects through the use of a passive haptic device. Thus, we introduced a low-cost handheld input device that generates elastic feedback related to grip force and preserves freedom of movement within the virtual environment due to its low weight and small size. We also proposed an interaction metaphor that takes the form of a mitten bound to a control scheme that allows users to manipulate virtual objects through natural grasping motions and grip forces. Finally, we presented a novel pseudo-haptic approach based on grip force to vary the perceived effort when performing object manipulation tasks. Our second contribution proposes a set of novel 3D interaction techniques dedicated to bimanual tasks. The techniques bring improvements for navigation and grasping scenarios where the two hands of the user are involved simultaneously. We first presented the double bubble technique to ease the navigation in virtual environments when the two hands have separated tasks. Then, we described the joint control technique for enhancing the bimanual manipulation of objects. We finally presented the magnetic pinch technique dedicated to grasping scenarios where the two hands are involved.

For both contributions, we performed user studies to evaluate our interaction techniques and compare them to previous existing approaches. Our results suggested that our novel interaction paradigms could be applied to various manipulation cases as they enhance the manipulation skills of the user. Multiple virtual reality applications could be envisaged. For the Virtual Mitten technique, any application in which a simple haptic information is needed such as for virtual prototyping, sport training, rehabilitation procedures or video games could take advantage of our approach. On their side, the bimanual techniques open novel bimanual scenario possibilities without the need of any additional hardware device. In this chapter, we summarized some of our contributions dedicated to the improvement of manipulation tasks in VE. These techniques particularly explore how the hand skills could be further enhanced, especially for manipulating virtual objects. However, other body parts could also be involved, as illustrated in the next chapter.

The contributions of this chapter are respectively related to the PhD of M. Achibet and the PhD of A. Talvas (co-supervised with Dr. A. Lécuyer).

3D navigation techniques

Contents

There is a wide range of devices and metaphors that have been proposed this last decade for the navigation of virtual environments. The recent development of large VR setups as well as the improvement of hardware interfaces call to design novel interaction techniques for improved locomotions in VE. Instead of relying on computationally expensive artificially generated sensory feedback, we tried in our work to simply focus on techniques that use directly our body skills to navigate in a VE. For that reason, we focus our work on natural walking as the core of the navigation interface. Indeed, using natural walking in a VE inherently matches vestibular and proprioceptive cues from the real movement, but with the visual feedback from the virtual movement. Natural walking also naturally produces vibrotactile and acoustic feedback when stepping on the real ground. Thus, natural walking in a VE produces an accurate multi-sensory perception of navigation, hard to match with simulated approaches. It also provides the most natural, intuitive and direct way of controlling one's position.

In this chapter, we present some of our contributions on **novel interaction techniques dedicated to the navigation in virtual environments**. We tried to design techniques that take advantage of the user's body skills for naturally navigating in the virtual world. Our first contribution allows the **navigation in large virtual environments when real workspaces are restricted**. We introduced different navigation metaphors such as the *Magic Barrier Tape* or the *Virtual Companion* that keep the user safe from the real world boundaries while navigating in a potentially infinite VE. With such objective, the challenge is to design interaction techniques that both allow users to walk for real while being in restricted real workspaces and provide enjoyable and ecological paradigms compared to traditional approaches. Some VR configurations such as Desktop setups do not allow real walking for the user. In that case, we also want to provide **navigation techniques that reproduce the walking sensations** within the virtual world. Our second contribution proposes to the user to interact with the virtual environment by means of head movements. Our approach called *Shake-Your-Head* introduced a locomotion model to transform the head motions of the user into virtual motions in the VE, and visual feedback to further emphasize the perception of walking in the VE. The main challenge is to provide the user walking sensations that could allow him to navigate in the virtual environment while not walking at all in the real world. Both contributions were evaluated through user studies and compared with other navigation approaches. They also both attempt to use body skills of the user to navigate in virtual environments with increased

walking sensations.

10.1 Navigation in large virtual environments within restricted real workspaces

10.1.1 Context and motivations

Virtual environments span from small rooms where everything is accessible under one’s arm reach, to complex very large environments representing, for instance, outdoor scenes. Even infinitely large scenes, although non-existent in real life but relatively easy to implement, are virtually possible. Although the design of a large environment is not necessarily complex (it actually depends on how it is populated), navigating it does pose many challenges: the VE might be very large or even infinite, but the real physical workspace is not. In most cases, the space in which the user moves is significantly smaller than the simulated environment. This is the case for CAVE-like setups where the 4 screens represent the boundaries of the workspace, but it also applies to HMD setups since workspaces are bounded by the range of tracking systems. There are also boundaries rotation-wise in CAVE-like setups, where one screen (the “back” screen) is missing. In any case, walking users eventually reach the boundaries of the workspace, leading to breaks of immersion, blocking situations and safety problems. Providing an immersive and safe walking metaphor for navigating in infinite VE within the confines of restricted workspaces thus remains a challenging task. There are hardware and software-based approaches to overcome these issues: locomotion interfaces [Hollerbach 02] such as treadmills often have major limitations that restrict their widespread use (huge size and weight, high cost, lack of accuracy), while existing navigation techniques [Slater 95, LaViola 01, Williams 07, Razzaque 01] often fail at providing a simple, intuitive and immersive interaction.

In our work, we simply focus on natural walking as the core of the navigation interface. Several studies have shown the benefits of using natural walking for the navigation of VE, in terms of task performance, presence and naturalness [Usoh 99, Ruddle 09, Heintz 09, Zanbaka 05]. Besides, natural walking is, after all, the locomotion interface that we use in our everyday life. Our goal is to address the limitations of immersive displays, namely 1) keep the user “safe” from reaching translational and rotational limits, 2) provide more enjoyable and ecological paradigms compared to other navigation techniques, such as traditional wand-based navigation techniques and 3) increase the amount of real walking compared to traditional techniques. Developing navigation metaphors achieving these goals can be surprisingly hard. There has been a significant body of work on walking in VE, most notably, for CAVE-like spaces, techniques such as “Walking in Place” [Templeman 99] have been proposed; however they do not involve true physical walking. Several approaches have been developed for modifying the walking path (e.g., “Redirected walking” [Razzaque 01]), but they usually require a space which is larger than a typical cube-like display. The few that address the rotation boundary issue do not provide a convincing solution.

10.1.2 Approach

The Magic Barrier Tape

In [Cirio 09], we introduced a novel interaction metaphor called the Magic Barrier Tape, which allows a user to navigate in a potentially infinite VE while confined to walking workspaces restricted in translation. Head-Mounted Displays (HMD) with limited track-

ing range are examples of such workspaces. The technique relies on the barrier tape metaphor and its “do not cross” implicit message by surrounding the walking workspace with a virtual barrier tape in the VE. Therefore, the technique informs the user about the boundaries of his walking workspace, providing an environment safe from collisions and tracking problems. It uses a hybrid position/rate control mechanism to enable natural walking inside the workspace and rate control navigation to move beyond the boundaries by “pushing” on the virtual barrier tape, as illustrated in Figure 10.1. The boundaries of the workspace are represented by a virtual barrier at mid body height textured with slanted black and yellow stripes, evoking the use of barrier tape.

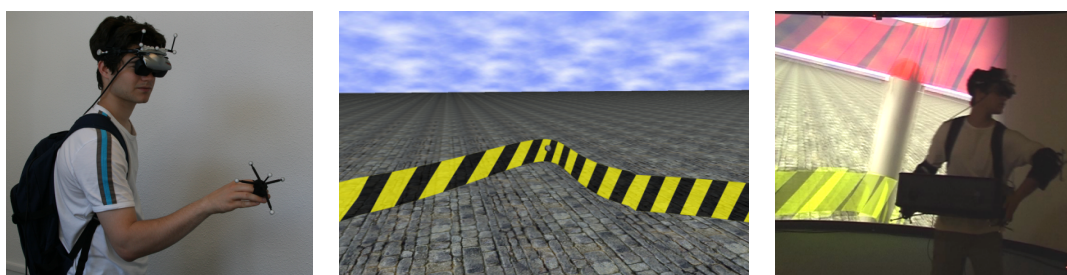

Figure 10.1 – The Magic Barrier Tape displays the boundaries of the real workspace as a virtual barrier tape, and uses a hybrid position/rate control to travel in the VE. The user (left) “pushes” on the Magic Barrier Tape (center) to move inside the VE when he reaches the workspace boundaries. Any tracked body part can be used to trigger the Magic Barrier Tape (right).

The real workspace, delimited by the physical boundaries, is mapped to a virtual workspace inside the VE, delimited by the virtual barrier tape. Inside the workspace, we use position control: the user can freely walk, and objects inside the virtual workspace can be reached and manipulated through natural walking and real life movements. When reaching the boundaries of the workspace, we switch to rate control: the user can move farther in the VE by “pushing” on the virtual barrier tape, hence translating the virtual workspace in the VE. He can then perform a task inside the virtual workspace at the new location.

The Magic Barrier Tape concept is not subject to a specific technology. It can be implemented in many different VR systems. Any object or body part can be used as an actuator for the virtual barrier tape, depending on the application, and the rate control law can be fitted to specific behavioral needs. The metaphor provides an easy, intuitive and safe way of navigating in a VE, without break of immersion. Two experiments were conducted in order to evaluate the Magic Barrier Tape by comparing it to two navigation techniques sharing the same objectives, also called resetting techniques [Williams 07]. Results showed that the Magic Barrier Tape was faster and more appreciated than the compared techniques, while being more natural and less tiring.

Walking in a Cube

The issue of reaching the boundaries of the workspace appears not only when the user moves towards the boundaries in translation: it can also happen when the user moves in rotation. Some VR setups, such as CAVE-like environments, present additional workspace restrictions. Indeed, in these setups users are not immersed in 360°: there are missing screens, leading to breaks of immersion when noticed by the user while turning. Hence, some workspaces are limited in translation *and* rotation.

In [Cirio 12], we presented three new techniques (the *Constrained Wand and Signs*,

the *extended Magic Barrier Tape*, and the *Virtual Companion*) that deal with translation and rotation issues through common metaphors. These techniques provide a navigation metaphor that keeps the user safe from the boundaries, without breaking immersion. They all incorporate a navigation technique which enables displacement to out-of-reach locations using a rate-control paradigm. These three techniques were developed in a continuum, from less to more ecological: each technique is progressively more integrated with the VE. They are illustrated in Figure 10.2.

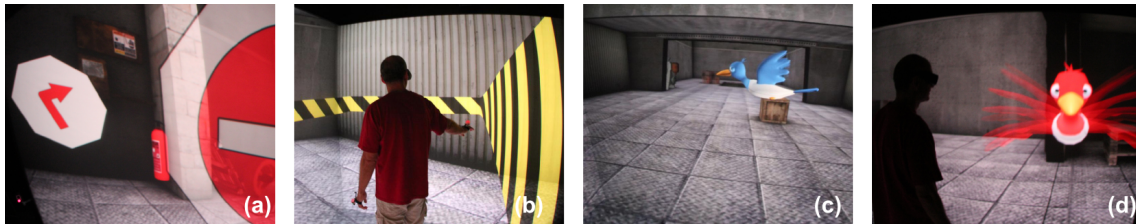

Figure 10.2 – Screenshots illustrating the three techniques. From left to right: (a) Constrained wand and signs: The “no-way” and “turn right” signs. (b) Extended MBT: the tape and blinders. (c,d) Virtual Companion: the bird in “rest mode” (c) and “protection mode” (d).

The first metaphor extends the basic and well-known wand paradigm by adding virtual warning signs. The user is forced to walk to the cube limits before the wand is activated. At the limits, warning signs are presented before collisions (translation) or when turning the head too far (rotation), as illustrated in Figure 10.2.a. At this point the wand can be used as usual. This metaphor both encourages walking and keeps the user safe.

The second metaphor extends the Magic Barrier Tape by adding virtual walls that prevent the user from looking at the missing screen. Thus, it protects the user with the tape for translation, and introduces "virtual blinders" for rotation (see Figure 10.2.b and Figure 10.3.a). The user can move beyond the physical space by pushing the barrier with his hands. By construction, the barrier only appears when approaching the walls or rotating too far. As a result this metaphor also encourages walking, keeps the user safe and removes the need for the wand.

The third metaphor introduces a *Virtual Companion* in the form of a bird to guide and protect the user within the VE. The bird serves two purposes: it protects the user at the limits by becoming red and flying close to the user’s face (see Figure 10.2.c and Figure 10.2.d), and can be "tethered" with virtual reins, thus serving as a navigation interface (see Figure 10.3.b). This approach protects the user, leaves their hands free and is the most ecological of the three. However, it only slightly encourages walking, by forcing users to step backwards when they are too close to the screens or have turned too far.

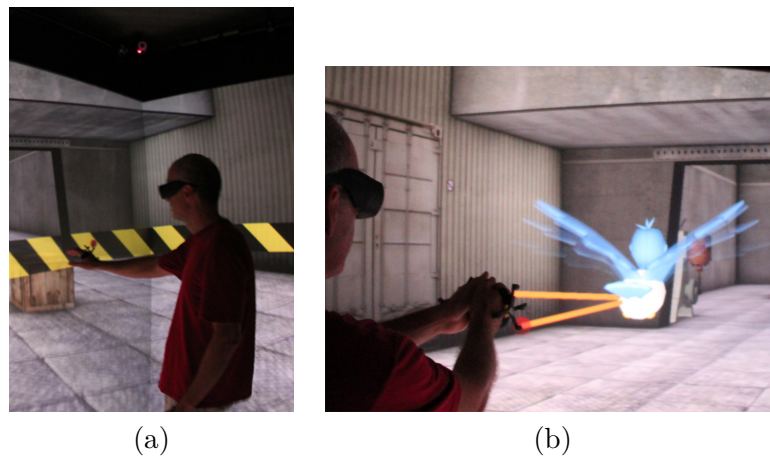

Figure 10.3 – (a) The extended Magic Barrier Tape. (b) The virtual reins when using the Virtual Companion.

We have evaluated the three techniques by comparing them first to a base wand condition, typically used for navigation in CAVE-like setups. We used two experimental methods to compare the techniques. First, we collected tracking data and analyzed quantities such as walking distance and speed. Second, we used Likert-scale questionnaires to evaluate the impression of users in terms of accuracy, walking sensation, and other subjective criteria. The study provided insight into the relative strengths of each new technique, while showing that they can efficiently address the issues of navigation in large VE within restricted workspaces. The Virtual Companion outperforms all other techniques in terms of staying in the "safety zone". Inevitably, this comes at the price of lower physical walking distance. The extended Magic Barrier Tape induces the largest amount of physical walking, meeting our initial goal of proposing new metaphors allowing users to walk in restricted real workspaces.

10.2 Shake-Your-Head: a navigation technique revisiting walking-in-place

10.2.1 Context and motivations

The navigation techniques presented in the last section could not always be applied when navigating in large virtual environments with restricted real workspaces. Specific techniques could then be introduced, especially when the user is not able to walk for real, such as in a Desktop VR configuration. The Walking-In-Place (WIP) technique has been introduced to enable a real physical walking movement and an efficient navigation technique in 3D virtual environments [Slater 95]. The user has to consciously walk in place while motions of his body are tracked and analyzed. The tracked Walking-In-Place motion is used as input for the locomotion simulation inside the VE. First implementations of WIP were all based on the processing of head positions using a neural network. More recent models track the positions of the heels or knees of the user to compute the resulting virtual locomotion [Feasel 08, Wendt 10]. However, all existing WIP techniques require the user to stand up, and they focus on immersive VR applications based on sophisticated tracking devices and head-mounted-displays or CAVE setups.

10.2.2 Approach

In [Terziman 10], we proposed a novel approach to the WIP technique. Our intention is to extend it to match a larger set of configurations, by notably applying it to desktop setups. Our technique is called *Shake-Your-Head* as the user interacts with the virtual environments by means of head movements, as illustrated in Figure 10.4. The user can stand or sit, such as in traditional video games or desktop VR configurations. These head movements can be captured using different tracking interfaces, but we insist on the use of low-cost optical tracking with standard webcams. Then, we proposed a locomotion simulation to compute a virtual walking motion. The user can also turn, jump or crawl, in addition to walk motions. As a result, the user can perceive the locomotion in the virtual world by means of integrated virtual camera motions on the three axes of motion, to further enhance the sensation of walking.



Figure 10.4 – Illustration of the Shake-Your-Head technique with a slalom navigation in a virtual environment.

Description of the Shake-Your-Head technique

The main concept of our method is to exploit the head oscillations as a transposition of the one observed during natural walking. While walking, the head of the user oscillates along the lateral, vertical and forward axes. The oscillations are strongly correlated to gait events and foot steps. Moreover, these oscillations also occur while walking in place. Our approach is based on the measurement of those oscillations to control the navigation. The head motions are classically retrieved in the existing WIP techniques thanks to the use of regular position trackers. In our method, we propose the use of a video camera system to handle the tracking of the user head. Thus, our interaction technique can be deployed on a large scale at low cost for training purpose or video games for example. In our method, we propose to use 3 Degrees of Freedom that can be easily accessed in the image frame provided by the webcam, as illustrated in Figure 10.5.

We introduced a locomotion model to translate the inputs of the user, i.e. head motions, into virtual motions in the VE. We implemented different locomotion states: walking, turning, jumping and crawling. All the states are managed through a state automaton.

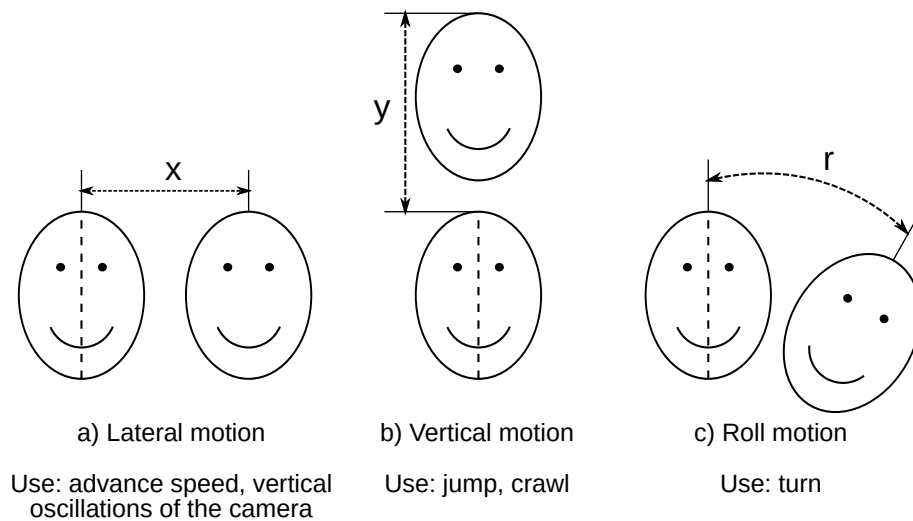

Figure 10.5 – Extracted head motions: (a) lateral motion, (b) vertical motion, (c) roll motion. The different motions could then be translated in different actions in the virtual environment.

To further emphasize the perception of walking in the VE, we extended the visual rendering of the WIP using camera motions driven by the user’s head oscillations. We introduced a new model of camera motions adapted to the user’s head motions. The camera oscillations along the different axes must follow the user in real time to maintain the coherency of the system. Thus we have implemented a novel visual feedback with camera motions along the vertical, lateral and advance axes.

Evaluation

We evaluated our approach using a comparison with classical techniques in Desktop VR. We chose keyboard and joystick peripherals for seated and standing positions respectively as they are often used in Desktop VR context. The experiments were conducted using 3D VE displayed on a screen and we investigated the effectiveness of our technique to travel complex paths composed of different gates placed in the VE. Our results suggested that the Shake-Your-Head technique can allow efficient navigation even compared with standard and well-known input devices such as keyboards and gamepads. The participants could sometimes go even faster, without any strong loss in precision. The interaction seems also fast to learn, after only a couple of trials. The technique is well appreciated and perceived as more immersive and more fun than classical configurations.

In [Terziman 11], we also proposed to evaluate quantitatively the navigations produced with the SYH. We analyzed and compared the trajectories produced by the SYH with ones produced by joystick on slalom paths. We namely observed strong differences between trajectories produced by the SYH and the joystick, especially in terms of curvature. The participants had more difficulty to anticipate their trajectory with the SYH. We also found that the speed during the turns decreased and the user modulated their speed more precisely with the SYH technique. The trajectories produced by the SYH had more jerk than those produced by the joystick and thus were less likely to feel natural for the users. However, the SYH provided a better control of advance speed while the joystick was more precise for controlling direction.

10.3 Conclusion

In this chapter, we have presented some of our contributions on interaction techniques dedicated to the navigation in virtual environments. Our first contribution consists of a set of metaphors that allow the navigation in large virtual environments when real walking workspaces are restricted. We introduced first the *Magic Barrier Tape* technique and its "do not cross" implicit message by surrounding the walking workspace with virtual barrier tape in the VE. The technique naturally informs the user about the boundaries of his walking workspace, providing a walking environment safe from collisions and tracking problems. Some VR setups have additional boundary constraints if the visual display does not entirely surround the user. This is the case for CAVE-like setups, where there is one or several missing screens. These constraints in rotation arise when the user turns and faces the missing screens, thus breaking user immersion. We addressed this additional constraint by extending the Magic Barrier Tape and designing two other novel techniques called *Constrained wand and signs* and the *Virtual Companion*. The challenge was to design interaction techniques that both allow users to walk for real while being in restricted real workspaces and provide enjoyable and ecological paradigms compared to traditional approaches. The *Constrained wand and signs* extends the basic and well-known wand paradigm by adding virtual warning signs while the *Virtual Companion* protects the user by accompanying him during the navigation. All the techniques were evaluated through a user study and a comparison with previous approaches. The results showed that the proposed techniques meet our initial goal of proposing new metaphors allowing users to walk in restricted real workspaces.

Our second contribution brings a novel interaction for VR configurations such as Desktop setups where real walking is not possible for the user. The proposed approach called *Shake-Your-Head* aims at reproducing walking sensations even if the user is not walking for real. For that purpose, the Shake-Your-Head technique proposes to the user to interact with the virtual environment with as sole input his head movements. The technique can be used in a desktop configuration with the possibility for the user to sit down and to navigate in the VE through small screens and standard input devices such as a basic webcam for tracking. We also introduced a locomotion model to transform the head motions of the user into virtual motions in the VE, and visual feedbacks to further emphasize the perception of walking in the VE. We implemented various motions such as turning, jumping and crawling in the locomotion simulation. Evaluation and extended analysis of the trajectories showed that the technique could allow efficient navigation and was well appreciated and perceived as more immersive and more fun than classical configurations.

Both contributions attempt to use body skills of the user to navigate in virtual environments with increased walking sensations. We showed through our approaches that the user's body information could be directly used for navigating in virtual environments. We believe that our metaphors could be implemented in various VR applications and adapted to different VR setups, especially for general audience. It opens novel navigation possibilities as trajectories with various shapes could be envisaged as well as arbitrary-shapes and dynamic workspaces.

The contributions of this chapter are respectively related to the PhD of G. Cirio and the PhD of L. Terziman (co-supervised with Dr. A. Lécuyer). The contributions related to walking in a cube were achieved in collaboration with Dr. G. Drettakis and Dr. P. Vangorp (Inria Sophia-Antipolis).

Part V
Conclusion

Conclusion and perspectives

When Sutherland proposed in 1965 his "Ultimate Display", he mused over the options available to the engineer to display computer data, to create "a looking glass" into what he described as a "mathematical wonderland". It seemed reasonable for him to suggest that "The Ultimate Display" would represent this data in three-dimensional form, allowing the construction of entirely believable three-dimensional, computer controlled, virtual worlds. However, like Heilig before him with his "cinema of the future", Sutherland took this suggestion one step further as he imagined that the display could present realities heretofore only imagined, as if seen through Alice's looking glass.

Almost 50 years after Sutherland's suggestions, 3D virtual environments are now commonplace, and 3D contents are nowadays widely diffused to a general audience. These virtual worlds aim at multiple application areas, from medical gestures training to industrial objects prototyping, as well as a massive use for entertainment through video games or films. Far beyond the only visual rendering of the virtual environments, 3D interaction with them remains one of the key challenge of this last decade. VR technologies have opened possibilities for the real-time simulation of digital environments with which the user can interact and perceive through different sensorial modalities. Thus, 3D interaction with virtual environments inherently pose modeling, feedback and interaction challenges. In this manuscript, we have summarized our research activities within these three challenges. We have laid the foundations of our work on designing the interactions with complex virtual worlds, referring to a higher demand in the characteristics of the virtual environments. Thus, our contributions could be further formulated within three research axes: (1) the **physically-based modeling** of the virtual world to take into account the complexity of the virtual object behavior, their topology modifications as well as their interactions, (2) the **multimodal feedback** for combining the sensorial modalities into a global answer from the virtual world to the user and (3) the **body-based 3D interaction** techniques and devices for establishing the interfaces between the user and the virtual world.

All these contributions could be gathered in a general framework within the 3D interaction loop. By improving all the components of this framework, we aim at proposing approaches that could be used in future virtual reality applications but also more generally in other application areas with which we were involved in our projects, such as medical simulation, gesture training, prototyping for automobile industry, robotics or web contents. In this manuscript, we summarized and highlighted some of our contributions in the different components of our general scheme. However, there remain challenging questions that we would like to answer in the next years as well as interesting perspectives that we could explore. In the remainder of this chapter, we will propose some of our interests for potential future work in each of our three axis before concluding with our research perspectives.

The complexity of the real world, the simplicity of the virtual world

In our first research axis, we aimed at proposing contributions that introduce the simulation of complex virtual objects in a physically-plausible manner. We introduced physically-based models of complex dynamic phenomena such as topology modifications or interaction of deformable instruments with the virtual environment. We particularly paid attention to our validation methodology through the use of benchmarks and comparisons against real data. Future work and perspectives concerning our activity on physically-based modeling of the virtual world are: (1) to comfort our validation methodology through the use of real data, (2) to reinforce our approach for designing calibration methods using appropriate and efficient parameter estimation and (3) to introduce adaptive physically-based simulation driven by the user's perception. These perspectives are detailed in the following paragraphs.

- **Validation and real data collection.** As stated along all the manuscript, we particularly focused our effort on the validation process of our contributions. For designing appropriate physically-based models to populate a virtual environment, the validation is a key step highly dependent on the targeted application. To be evaluated in a particular context, the model should generally first be compared to other approaches, as illustrated in this manuscript. But it also has to be compared with real data. This step is generally time-consuming and could be fastidious but rewards the modeling process through the comparison between the real world and the virtual one. The **ability to generate relevant measurements from real data** in order to first characterize the properties of the real objects and second to estimate and evaluate the physically-based simulations of these objects remains however challenging. This requires as first step the organization of experimental setups to record in real-time the behaviors of real objects in controlled conditions. Relevant elements should be identified and carefully quantified during all the process. The second step is the analysis of the recorded data to extract relevant properties of the objects and obtain complete summary information.

Data capture must be designed with the purpose of obtaining a sufficient representation of an object's range of motions in addition to force information and mechanical properties. Mechanical data collection is performed since a long time in research fields such as physics, mechanical engineering or even biology at the microscopic level. In the context of computer graphics and more specifically physically-based simulation, the researchers have mainly used values already in the literature for their simulations (stiffness coefficient like the Young Modulus or friction coefficient for the contact between objects are classical examples). The last five years have seen the emergence of data-driven models in the computer graphics community [Otaduy 12]. These models use pre-recorded data to build a constitutive model that improve the performance and/or realism of dynamic simulations with applications to cloth or faces for example [Bickel 09, Wang 11, Miguel 12]. These methods have combined traditional reconstruction algorithms with novel capture techniques designed for physically-based computer animation. They have opened novel perspectives for **fitting physically-based simulations to observed real data**.

However, the complexity of the physical phenomena could sometimes prevent from the use of traditional metrics. This is the case for instance for topology modifica-

tions where Euclidian metrics could not always reflect the user's perception of the similarity between two fracture paths. In that context, the challenge relies on the design, in addition to the classical approaches, of **novel and relevant metrics of the perceived behavior** of a virtual environment.

- **From parameter identification to inverse dynamics.** Physically-based models are incorporated in many VR applications to replicate or predict the outcome of mechanical processes and events. When introducing these models, the identification of their parameters is a key challenge to lead the simulations to the desired behavior. We have described in this manuscript some of our contributions for novel approaches of parameter identification, for instance based on real images such as ultrasound data [Dehghan 08] or photographs [Glondou 12a]. Data-driven models have also been increasingly proposed these last years for calibrating the simulations. However, the widespread applications of physically-based models is generally accompanied by a widespread concern about quantifying the uncertainties prevailing in their use. The sources of uncertainty are various: parameter uncertainty, model inadequacy, residual variability in the resulting simulations, parametric variability, observation error or code uncertainty [Kennedy 01]. Ad-hoc methods are the traditional way of estimating unknown parameters search for the best fitting values. To **quantify the uncertainty about the distribution of the unknown parameters**, one alternative methodology could be to rely on computational statistical methods.

Thus, one of the current challenges remains the ability to formalize and build a calibration approach in order to estimate the parameters whatever the physically-based model is. The approach should be **as generic as possible** to be potentially applied to various physical models reproducing a given mechanical phenomenon. Besides the design of the calibration approach, an other issue related to parameter estimation is the computation time performance of the parameter identification. To be used in interactive applications, the method should necessarily be **computationally efficient**, requiring the interactive solving of inverse problems. Thus, **achieving inverse dynamics methodology** remains still very challenging but is a key step of the next generation of physically-based virtual worlds reproducing real mechanical phenomena.

- **Towards perceptually-adaptive physically-based simulations.** To achieve the best user's perception, the tendency in the last two decades for the design of virtual worlds has been to match as closely as possible the physics of the real world, especially for virtual training applications. For that reason, physically-based simulations of the virtual scenes are nowadays commonly used. However, it is the human sensorial system that receives and interprets the visual, haptic or auditory cues from the surrounding environment, and it ultimately determines what we perceive. Thus, in virtual reality applications, it cannot be predicted in advance how a user will perceive the behavior of the entities in a virtual world and in return will interact with them. The interaction must therefore be computed in real-time. These types of interaction schemes bring a new level of complexity in terms of generic physical simulation of potential interactions, and a challenging trade-off between performance and realism. In this context, one interesting perspective relies on the **reduction of perceived inaccuracy** both by taking perceptual factors into account and by attaching more importance to certain objects in the virtual scene. The use of multi-scale physically-based simulations for rendering 3D interactions with virtual environments could be a solution. If existing approaches in the literature generally try to simplify the

interactions to decrease computation time performance, we could also **drive the multi-scale approach with user's perception**. The main challenge is then to propose a strategy for decomposing the physically-based simulations of the virtual environments into different level-of-details for improving the 3D interaction performances. The greatest issue will be to select level-of-details to progressively simplify the simulations in an imperceptible but efficient manner. Thus, the user's perception will be the main criterion for evaluating the realism of the resulting physically-based interactions.

Given the complexity of the real world processes, existing VR approaches are commonly based on simplified physically-based models. Far beyond a negative analysis of the current approaches, the user's perception of these VR applications is one of the best proof that these approaches can reach the interactivity and immersion required. An elegant way of qualifying the VR solutions could be to qualify them as simplex, a terminology introduced by Berthoz [Berthoz 12]: *"Simplex solutions are not just ways of reformulating or summarizing a problem. Put another way, they enable actions that are more elegant, faster and more efficient. They also give priority to the senses, even if it means making a detour"*. These simplex solutions would thus avoid the world's complexity by imposing their own rules and functions. If the simplicity of the virtual world is an answer to the complexity of the real world, the user's perception remains the key factor of the efforts of our research to design the most appropriate virtual world given the real world characteristics.

From multimodal to user-specific feedback

In our second research axis, we aimed at designing approaches for generating multimodal feedback to the user. Our contributions are mainly focused on enhancing the sensorial feedback of the user during the interactions with virtual environments. We particularly tackled the issue of complex virtual scenes like for instance with a large number of objects in interaction, complex shapes and intricate contact computation or a wide field-of-view. Future work and perspectives concerning our activity on multimodal feedback could be stressed through different challenges: (1) to emphasize the user's natural gestures for designing haptic feedback, (2) to further explore multimodal feedback through the use of perception-based approaches and (3) to introduce the use of physiological measurements in combination with the multimodal rendering of the virtual world. The challenges are detailed in the following paragraphs.

- **Natural gestures and haptic rendering.** In our contributions, we particularly aimed at increasing the haptic sensations of the user through the use of appropriate physically-based models. If many of these models are for most of them already used for the visual rendering of the virtual environments, the main challenge in our contributions was to design models that could be synchronized with the other sensorial modalities while providing realistic haptic sensations to the user. There are still many other mechanical properties that could be explored in terms of haptic coupling schemes. The main issue remains however to **keep our gestures as natural as possible** while using sometimes inappropriate haptic interfaces. Enhancing the user's sensations through haptic feedback relies first on exploring the user's perception and experience through his natural gestures in virtual world, and then on proposing approaches that could **translate and not necessarily reproduce** them in the virtual world.

Besides the preservation of our natural gestures when interacting with the virtual world, we could particularly experience in our work that our interactions with the surrounding world could convey enactive information that manifests itself particularly through haptic cues. Either with our hands or with our feet, the ecological information we obtain from haptic interaction allows us to perform everyday tasks in unfamiliar virtual environments, by means of the invariant ecological meaning that we have learned through prior experience of the tasks. In that case, vision could be regarded as playing an integrative role linking motion to obstacle avoidance, object mechanical properties and the understanding of details occurring at the contact surface. Thus, one of the perspectives for haptic rendering is to develop approaches that could **better explore our ecological information** from our natural gestures and motions.

These approaches would be complementary to the design of dedicated haptic interfaces. These novel haptic devices could notably exploit our natural motions through a wide range of haptic illusions [Hayward 08], like for example some illusions that depend on unusual features of cutaneous or proprioceptive haptic perception, and others simulate ecologically-based phenomena, such as the rolling of a stone along a manipulated rod [Yao 06] for instance.

- **From multimodal to perception-based approaches.** In this manuscript, we illustrated some of our multimodal approaches with use-cases describing the combination of different sensorial modalities for enhancing the user's sensations. In a large number of VR applications, these sensations are limited by hardware devices that could decrease or cancel one sensorial modality. An interesting alternative to classical multimodal approaches is thus the use of crossmodal approaches. In our case, we especially introduced haptic sensations through the use of the visual and the auditory modalities, for both manipulation and navigation purposes. But other combinations remain to be explored for producing unfamiliar effects that are capable of thrusting users into paradoxical situations, such as for the phenomenon of "pseudo-haptic feedback". **Combining proprioception** or equilibrioception **with the classical sensorial modalities** could be further explored in VR applications for enhancing given user's gestures with multimodal feedback. Beyond the use of crossmodal feedback alone, its **combination with 3D interaction techniques** appears also to be a promising way of improvement of 3D interaction, mixing together the components of our global framework. It also open novel and challenging questions in terms of user's perception when navigating or manipulating objects within virtual environments. Systematic psychophysical measurements and validation through experiments will indicate an incremental step along the current baseline for Virtual Reality.

Besides the exploration of crossmodal approaches, the key role of any sensorial feedback is to provide users with appropriate sensations of the virtual world they are interacting with. In our contributions, we proposed to adapt the visual feedback to the user's perception through the use of an experimental user-study combined with a parameter optimization approach in the context of similarity between fracture paths [Glondou 12a]. Such approaches open novel perspectives as the **feedback could be adapted to the users' perception**. Many visual rendering of complex scenes could be designed through the use of perceptive information. Haptic and auditory feedback represent a natural extension to this type of approach, opening the way for multimodal approaches adapted to the users' perception.

- **Enhancing multimodal feedback through physiological measurements.** Besides the perspective of multimodal feedback adapted to the users' perception, we introduced in this manuscript a novel concept of user-adapted VR simulator that we proposed first through an haptic guidance system with adapted force feedback and then through a medical simulator [George 12]. Our project adapts in real-time the feedbacks of a guidance system to the user's mental workload, using a brain-computer interface for measuring the user's brain activity. Such approach paves the way to VR systems that will automatically reconfigure and adapt their feedback to their users' mental states and cognitive processes. Beyond the adaptation of the feedback to a group of users for which the perception has been measured, the challenge in such approach is to **obtain a feedback specific to each user**. The use of physiological measurements such as heart rate or brain activity has been introduced since a decade in the design of 3D interfaces and one sensorial modality. It is however rarely correlated to the design of multimodal feedback where the data need to be exploited for multiple sensory channels. If one of our main challenges in our research activity remains the synchronization of models between different sensorial modalities, one perspective would be to **add physiological measurements** in addition to physical measurements in our applications. The main issues would be to acquire the ability to **process in real-time and in a physically and physiologically-plausible manner the huge amount of data** that could be generated both by the acquisition devices and the virtual environments. However, such systems could leverage a novel generation of VR setups where the feedback would be specific to each user, opening novel perspectives in multiple application areas such as medical rehabilitation or gestures training.

Given the challenges behind the combination of different sensorial modalities, a lot of work is still required in order to achieve seamless multimodal interaction with any kind of virtual environments. As VR interaction benefits from technology improvements in devices and computational power, the next decades will certainly witness tremendous advances in the field and, at the same time, will open the way for new and exciting research challenges. Adapting the feedback to the user will be a key step for the design of the most appropriate multimodal feedback but will at the same time require the integration of a huge amount of data, calling for novel approaches for processing interactively these data.

The physicality of 3D interactions with virtual environments

In our third research axis, we aimed at designing 3D interaction devices and techniques involving novel body skills or increasing user's capacities. Both for our hardware and software contributions, we particularly focused our effort on exploring the user's body skills for enhancing the physicality of the 3D interactions with the virtual world. Future work and perspectives concerning our research activity on 3D interaction devices and techniques could be: (1) to further exploit the body through a unified answer for the design of 3D interaction devices and techniques and (2) to introduce dynamic interaction metaphors for better personalizing the link between the user and the virtual world. These perspectives are detailed in the following paragraphs.

- **Rising the body as a core interface.** The improvements and the wider availability of 3D VR setups open the possibility of many novel 3D interfaces that can now involve the body. Thus, there is an increasing number of devices available on the consumer market that already proposes to exploit the user's body skills. Microsoft Kinect, a tracking interface designed to allow users to interact with the system through their bodies, enhances vestibular and proprioceptive cues during interaction. Stereoscopic vision displays (TV screens, video projectors, portable gaming consoles) can be bought off-the-shelf and are found in many homes, while affordable surround sound systems have been around for many years now. Other modalities gain also the attention of industrials and consumers. All major gaming systems include vibrotactile transducers inside their controllers. Novint Falcon 3DoF device shows that force-feedback devices, which have always been expensive interfaces, are now being commercialized in the mass market at affordable prices. The rendering capabilities of these devices are however still limited. One of the challenges for the next generation of 3D interfaces will be to **integrate into a unified answer in the 3D interaction loop both input and output information from the user's body**. Innovative 3D interaction devices capturing body's information on the input side and multimodal models allowing the simulation of phenomena and their rendering through many different sensory channels on the output side, should thus be combined through 3D interfaces rising the body as a fundamental basis.

Besides the design of the 3D interfaces, the interaction techniques that are used together should also own appropriate properties to fully exploit the possibilities of the novel 3D interfaces. One challenge is the ability of the novel techniques to both translate the user's body information to the virtual world and to enhance the user's sensations in return. One issue relies on the spatial distribution of the information: the acquisition devices measure body's information while the feedback devices provide information to the user's body not necessarily collocated with the part of the body where the measurements were performed. The data exchanges should be processed by **considering the body as a whole**. The improvements of the physicality of our interactions with virtual worlds should thus take into account the body's physical, biomechanical and physiological properties. Evaluation should also remain a crucial step and novel experimental setups should be envisaged to measure the performances of such novel VR systems combining multiple sources of body's information.

- **Towards dynamic metaphors for virtual tasks.** The introduction of appropriate interaction metaphors plays a key role in the 3D interaction of the user with the virtual world. Through our contributions illustrated in this manuscript, we showed that our metaphors could enhance the user's grasping or walking sensations, either through manipulation or navigation tasks. One interesting characteristic of the interaction paradigms is their ability to adapt to the user's behaviors and thus to propose the better translation of user's information to the virtual world. One step further would be the **ability for the metaphors to dynamically modify the virtual environment** and not only the interaction, in adequacy with the user's behaviors. We could thus envisage for instance the dynamic modification of the workspaces or the creation of a dynamic map of the real environment. Far beyond the integration of predicting algorithms or context-dependent knowledge, the challenge relies on the design of metaphors that could be dynamically parameterized to integrate the user's physical and physiological information. It will require finding first appropriate pa-

rameters for translating the huge amount of data coming from the user, and then appropriate calibration approaches for dynamically adapting the parameter values to the user's information. Such metaphors could open novel perspectives for VR applications where the interaction could be user-specific, personalizing the link between the human and the virtual world.

Given the current improvements in VR technologies, the user's body is a fundamental basis for the design of 3D devices and interaction techniques. Integrating the data coming from the user remains the key step to create appropriate 3D interfaces that could at best translate the user's behaviors to dedicated motions in the virtual worlds. The step further would be to dynamically process the data, leading to spatially and temporally adaptive 3D interfaces that could fully explore the physicality of 3D interactions.

Towards the plasticity of virtual environments

Following our global framework illustrated through the 3D interaction loop, we aim at improving all its components individually. When looking at the above perspectives, we could however observe that the different components of our framework could be intrinsically combined. The main challenges that we aim at working on are composed of a perceptually-adaptive virtual world, combined with a user-specific feedback and enhanced through physical 3D interactions. The user remains the central element of the 3D interaction loop. We commonly think that it has to be the user who needs to adapt himself to the virtual environment, given a 3D interface and a virtual world. However, what about a virtual world that could adapt to the user? The phenotypic plasticity, in biology, describes the ability of an organism to change its phenotype in response to changes in the environment. The neuroplasticity, in neurosciences, defines how entire brain structures can change from experience. As well as these two definitions of the word "plasticity", we could imagine to **introduce the plasticity of the virtual world**.

As VR is getting more and more outside the labs and industries with an increased availability of low-cost devices and home-made setups, next generation of VR applications need to become accessible to a general audience. If users will always have to get used to any VR setups they will encounter, we could also think of the design of virtual worlds that could be able to change in response to the user's information. The user data could be multiple, ranging from simple motion velocities to force estimation, as well as mental state activity or physiological information. The plasticity of the virtual environment would allow to dynamically specify the 3D interaction but also to create an infinite number of virtual worlds.

Bibliography

- [Achibet 14] M. Achibet, M. Marchal, F. Argelaguet, A. Lécuyer. – The virtual mitten: A novel interaction paradigm for visuo-haptic manipulation of objects using grip force. – *Proc. of IEEE Symposium on 3D User Interfaces*, pp. 59–66, 2014. [120](#)
- [Adachi 95] Y. Adachi, T. Kumano, K. Ogino. – Intermediate representation for stiff virtual objects. – *Proc. of the Virtual Reality Annual International Symposium*, 1995. [70](#)
- [Adams 01] R.J. Adams, D. Klowden, B. Hannaford. – Virtual training for a manual assembly task. *Haptics-e, The Electronic Journal of Haptics Research*, 2, 2001. [11](#)
- [Alderliesten 04] T. Alderliesten. – *Simulation of Minimally-Invasive Vascular Interventions for Training Purposes*. – PhD dissertation, Utrecht University, 2004. [51](#)
- [Allard 07] J. Allard, S. Cotin, F. Faure, P-J. Bensoussan, F. Poyer, C. Duriez, H. Delingette, L. Grisoni. – Sofa - an open source framework for medical simulation. – *Proc. of Medicine Meets Virtual Reality*, pp. 13–18, 2007. [24](#)
- [Allard 09] J. Allard, M. Marchal, S. Cotin. – Fiber-based fracture model for simulating soft tissue tearing. – *Proc. of Medicine Meet Virtual Reality*, 2009. [42](#)
- [Allard 10] J. Allard, F. Faure, H. Courtecuisse, F. Falipou, C. Duriez, P.G. Kry. – Volume contact constraints at arbitrary resolution. *ACM Trans. on Graphics*, 29(4):82:1–82:10, 2010. [53](#)
- [Alterovitz 02] R. Alterovitz, K. Goldberg. – *Comparing Algorithms for Soft Tissue Deformation: Accuracy Metrics and Benchmarks*. – Rapport de recherche, UC Berkeley, 2002. [22](#), [23](#)
- [Alterovitz 03] R. Alterovitz, J. Pouliot, R. Taschereau, I. C. Hsu, K. Goldberg. – Needle insertion and radioactive seed implantation in human tissue: Simulation and sensitivity analysis. – *Proc. of IEEE ICRA*, pp. 1793–1799, 2003. [46](#)
- [Anderson 07] A. Anderson, B. Ellis, J. Weiss. – Verification, validation and sensitivity studies in computational biomechanics. *Computer Methods in Biomechanics and Biomedical Engineering*, 10:171–184, 2007. [22](#), [23](#)

- [Ardouin 12] J. Ardouin, A. Lécuyer, M. Marchal, C. Riant, E. Marchand. – Flyviz: A novel display device to provide humans with 360° vision by coupling catadioptric camera with hmd. – *Proc. of the ACM Symposium on VRST*, pp. 41–44, 2012. [115](#)
- [Ardouin 13] J. Ardouin, A. Lécuyer, M. Marchal, E. Marchand. – Navigating in Virtual Environments with 360° Omnidirectional Rendering. – *Proc. of IEEE Symposium on 3D User Interfaces*, pp. 95–98, 2013. [82](#)
- [Ardouin 14] J. Ardouin, A. Lécuyer, M. Marchal, E. Marchand. – Stereoscopic Rendering of Virtual Environments with Wide Field-of-Views up to 360°. – *Proc. of IEEE Virtual Reality Conference*, pp. 3–8, 2014. [82](#)
- [Argelaguet 13] F. Argelaguet, D.A. Gomez Jauregui, M. Marchal, A. Lécuyer. – Elastic images: Perceiving local elasticity of images through a novel pseudo-haptic deformation effect. *ACM Trans. on Applied Perception*, 10(3):17:1–17:14, 2013. [103](#)
- [Barbagli 04] F. Barbagli, A. Frisoli, K. Salisbury, M. Bergamasco. – Simulating human fingers: a soft finger proxy model and algorithm. – *Proc. of 12th International Symposium on Haptic Interfaces for Virtual Environment and Teleoperator Systems*, pp. 9 – 17, 2004. [73](#)
- [Barfield 00] W. Barfield, T. Caudell. – *Fundamentals of Wearable Computers and Augmented Reality*. – Lawrence Erlbaum Associates, 2000. [114](#)
- [Baxter 04] W. Baxter, M. C. Lin. – Haptic interaction with fluid media. – *Proc. of Graphics Interface*, pp. 81–88, 2004. [66](#)
- [Becker 09] M. Becker, M. Ihmsen, M. Teschner. – Corotated sph for deformable solids. – *Proc. of Eurographics Workshop on Natural Phenomena*, pp. 27–34, 2009. [69](#)
- [Bender 14] J. Bender, K. Erleben, J. Trinkle, E. Coumans. – Interactive simulation of rigid body dynamics in computer graphics. *Computer Graphics Forum*, 33:246–270, 2014. [10](#)
- [Berthoz 12] A. Berthoz. – *Simplexity. Simplifying principles for a complex world*. – Odile Jacob, 2012. [140](#)
- [Bickel 09] B. Bickel, M. Bäcker, M.A. Otaduy, W. Matusik, H. Pfister, M. Gross. – Capture and modeling of non-linear heterogeneous soft tissue. *ACM Trans. on Graphics*, 28(3):89:1–89:9, 2009. [138](#)
- [Borst 05] C.W. Borst, A.P. Indugula. – Realistic virtual grasping. – *Proc. of IEEE Virtual Reality Conference*, pp. 91–98, 2005. [53](#), [120](#)
- [Bosch 11] C. Bosch, P-Y. Laffont, H. Rushmeier, J. Dorsey, G. Drettakis. – Image-guided weathering: A new approach applied to flow phenomena. *ACM Trans. on Graphics*, 30:20:1–20:13, 2011. [78](#)
- [Bouzit 02] M. Bouzit, G.V. Popescu, G.C. Burdea, R. F. Boian. – The rutgers master ii-nd force feedback glove. – *Proc. of HAPTICS*, pp. 145–152, 2002. [120](#)

- [Bowman 04] D.A. Bowman, E. Kruijff, J. LaViola, I. Poupyrev. – *3D User Interfaces: Theory and Practice*. – Addison-Wesley Professional, 2004. [11](#)
- [Bowman 08] D.A Bowman, S. Coquillart, B. Froehlich, M. Hirose, Y. Kitamura, K. Kiyokawa, W. Stuerzlinger. – 3d user interfaces: New directions and perspectives. *IEEE Computer Graphics and Applications*, 28(6):20–36, 2008. [12](#)
- [Bridson 08] R. Bridson. – *Fluid Simulation for Computer Graphics*. – A.K. Peters, 2008. [10](#)
- [Chabanas 04] M. Chabanas, Y. Payan, C. Marescaux, P. Swider, F. Boutault. – Comparison of linear and non-linear soft tissue models with post-operative ct scan in maxillofacial surgery. – *Proc. of International Symposium on Medical Simulation*, pp. 19–27, 2004. [22](#)
- [Chatelain 13] P. Chatelain, A. Krupa, M. Marchal. – Real-time needle detection and tracking using a visually servoed ultrasound probe. – *Proc. of IEEE International Conference on Robotics and Automation*, pp. 1668–1673, 2013. [32](#)
- [Chatterjee 07] A. Chatterjee, V. Aggarwal, A. Ramos, S. Acharya, N.Thakor. – A brain-computer interface with vibrotactile biofeedback for haptic information. *Journal of NeuroEngineering and Rehabilitation*, 4, 2007. [93](#)
- [Chen 10] S.J-S. Chen, P. Hellier, J-Y. Gauvrit, M. Marchal, X. Morandi, D.L. Collins. – An anthropomorphic polyvinyl alcohol triple-modality brain phantom based on colin27. – *Proc. of MICCAI*, pp. 92–100, 2010. [30](#)
- [Chen 12] S. J-S. Chen, P.Hellier, M. Marchal, J-Y. Gauvrit, R. Carpentier, X. Morandi, D. L. Collins. – An anthropomorphic polyvinyl alcohol brain phantom based on colin27 for use in multimodal imaging. *Medical Physics*, 39:554–561, 2012. [30](#)
- [Cincotti 07] F. Cincotti, L. Kauhanen, F. Aloise, T. Palomäki, N. Caporusso, P. Jylänki, D. Mattia, F. Babiloni, G. Vanacker, M. Nuttin, M.G. Marciani, J. del R. Millán. – Vibrotactile feedback for brain-computer interface operation. *Computational Intelligence and Neuroscience*, 2007:7–7, 2007. [93](#)
- [Ciocarlie 07] M. Ciocarlie, C. Lackner, P. Allen. – Soft finger model with adaptive contact geometry for grasping and manipulation tasks. – *Proc. of World Haptics Conference*, pp. 219–224, 2007. [73](#)
- [Cirio 09] G. Cirio, M. Marchal, T. Regia-Corte, A. Lécuyer. – The magic barrier tape: a novel metaphor for infinite navigation in virtual worlds with a restricted walking workspace. – *Proc. of the ACM Symposium on VRST*, pp. 155–162, 2009. [112](#), [128](#)

- [Cirio 11a] G. Cirio, M. Marchal, A. Le Gentil, A. Lécuyer. – "tap, squeeze and stir" the virtual world: Touching the different states of matter through 6 dof haptic interaction. – *Proc. of IEEE Virtual Reality Conference*, pp. 123–126, 2011. [69](#)
- [Cirio 11b] G. Cirio, M. Marchal, S. Hillaire, A. Lécuyer. – Six degrees-of-freedom haptic interaction with fluids. *IEEE Trans. on Visualization and Computer Graphics*, 17(11):1714–1727, 2011. [66](#)
- [Cirio 11c] G. Cirio, M. Marchal, S. Hillaire, A. Lécuyer. – The virtual crepe factory: 6dof haptic interaction with fluids. – *ACM SIGGRAPH Emerging Technologies*, 2011. [70](#)
- [Cirio 12] G. Cirio, P. Vangorp, E. Chapoulie, M. Marchal, A. Lécuyer, G. Dretakis. – Walking in a cube: Novel metaphors for safely navigating large virtual environments in restricted real workspaces. *IEEE Trans. on Visualization and Computer Graphics*, 18(4):546–554, 2012. [129](#)
- [Cirio 13a] G. Cirio, M. Marchal, A. Lécuyer, J.R. Cooperstock. – Vibrotactile rendering of splashing fluids. *IEEE Trans. on Haptics*, 6:117–122, 2013. [88](#)
- [Cirio 13b] G. Cirio, M. Marchal, M.A. Otaduy, A. Lécuyer. – Six-dof haptic interaction with fluids, solids, and their transitions. – *Proc. of IEEE World Haptics*, 2013. [69](#)
- [Colgate 95] J.E. Colgate, M.C. Stanley, J.M. Brown. – Issues in the haptic display of tool use. – *Proc. of IEEE/RSJ International Conference on Intelligent Robots and Systems*, pp. 140–144, 1995. [11](#), [26](#), [70](#)
- [Contensou 63] P. Contensou. – Couplage entre frottement de glissement et frottement de pivotement dans la théorie de la toupie. *Kreiselprobleme / Gyrodynamics*, pp. 201–216. – Springer Berlin Heidelberg, 1963. [55](#)
- [Cotin 96] S. Cotin, H. Delingette, N. Ayache. – Real-time volumetric deformable models for surgery simulation. – *Proc. of Visualization in Biomedical Computing*, pp. 535–540, 1996. [8](#)
- [Crouch 05] J.R. Crouch, C.M. Schneider, J. Wainer, A.M. Okamura. – A velocity-dependent model for needle insertion in soft tissue. – *Proc. of MICCAI*, pp. 624–632, 2005. [46](#)
- [CruzNeira 93] C. Cruz-Neira, D.J. Sandin, T.A. DeFanti. – Surround-screen projection-based virtual reality: the design and implementation of the cave. – *Proc. of SIGGRAPH*, pp. 135–142, 1993. [82](#)
- [Dehghan 07a] E. Dehghan, X. Wen, R. Zahiri-Azar, M. Marchal, S. Salcudean. – Needle insertion force modeling using ultrasound displacement measurement. – *Proc. of MICCAI*, pp. 709–716, 2007. [32](#), [46](#)
- [Dehghan 07b] E. Dehghan, X. Wen, R. Zahiri-Azar, M. Marchal, S. Salcudean. – Parameter identification for a needle-tissue interaction model. – *Proc. of IEEE EMBS Conference*, pp. 190–193, 2007. [32](#), [46](#)

- [Dehghan 08] E. Dehghan, X. Wen, R. Zahiri-Azar, M. Marchal, S.E. Salcudean. – Needle-tissue interaction modeling using ultrasound-based motion estimation: Phantom study. *Computer Aided Surgery*, 13:265–280, 2008. [32](#), [46](#), [139](#)
- [Dequidt 08] J. Dequidt, M. Marchal, E. Kerrien, C. Duriez, S. Cotin. – Interactive simulation of embolization coils: Modeling and experimental validation. – *Proc. of MICCAI*, pp. 695–702, 2008. [32](#), [51](#)
- [Desbrun 96] M. Desbrun, M-P. Cani. – Smoothed particles: a new paradigm for animating highly deformable bodies. – *Proc. of the Eurographics workshop on Computer animation and simulation*, pp. 61–76, 1996. [66](#)
- [DiMaio 03] S.P. DiMaio, S.E. Salcudean. – Needle insertion modeling and simulation. *IEEE Trans. on Robotics and Automation*, 19:864–875, 2003. [46](#)
- [Dobashi 06] Y. Dobashi, M. Sato, S. Hasegawa, T. Yamamoto, M. Katoand, T. Nishita. – A fluid resistance map method for real-time haptic interaction with fluids. – *Proc. of ACM Symposium on Virtual Reality Software and Technology*, 2006. [66](#)
- [Dominjon 05] L. Dominjon, A. Lécuyer, J.-M. Burkhardt, G. Andrade-Barroso, S. Richir. – The "bubble" technique: Interacting with large virtual environments using haptic devices with limited workspace. – *Proc. of Worldhaptics conference*, pp. 639–640, 2005. [123](#)
- [Duriez 06] C. Duriez, F. Dubois, A. Kheddar, C. Andriot. – Realistic haptic rendering of interacting deformable objects in virtual environments. *IEEE Trans. on Visualization and Computer Graphics*, 12:36–47, 2006. [51](#)
- [Duriez 08] C. Duriez, H. Courtecuisse, J. Alcalde, P. Bensoussan. – Contact skinning. – *Proc. of Eurographics*, vol. 27, pp. 313–320, 2008. [56](#)
- [Duriez 09] C. Duriez, C. Guébert, M. Marchal, S. Cotin, L. Grisoni. – Interactive simulation of flexible needle insertions based on constraint models. – *Proc. of MICCAI*, pp. 291–299, 2009. [76](#)
- [Feasel 08] J. Feasel, M.C. Whitton, J.D. Wendt. – Llcm-wip: Low-latency, continuous-motion walking-in-place. – *Proc. of IEEE Symposium on 3D User Interfaces*, pp. 97–104, 2008. [131](#)
- [Frisoli 06] A. Frisoli, F. Barbagli, E. Ruffaldi, K. Salisbury, M. Bergamasco. – A limit-curve based soft finger god-object algorithm. – *Proc. of Symposium on Haptic Interfaces for Virtual Environment and Teleoperator Systems*, pp. 217–223, 2006. [73](#)
- [George 12] L. George, M. Marchal, L. Glondu, A. Lécuyer. – Combining brain-computer interfaces and haptics: Detecting mental workload to adapt haptic assistance. – *Proc. of Eurohaptics*, pp. 124–135, 2012. [93](#), [94](#), [142](#)

- [Glondou 09] L. Glondou, M. Marchal, G. Dumont. – A sub-world coupling scheme for haptic rendering of physically-based rigid bodies simulation. – *Proc. of VRIPHYS*, pp. 67–76, 2009. [71](#)
- [Glondou 10] L. Glondou, M. Marchal, G. Dumont. – Evaluation of physical simulation libraries for haptic rendering of contacts between rigid bodies. – *Proc. of ASME World Conference on Innovative Virtual Reality*, 2010. [25](#)
- [Glondou 11] L. Glondou, B. Le Gouis, M. Marchal, G. Dumont. – Precomputed shape database for real-time physically-based simulation. – *Proc. of the Eurographics Workshop in Virtual Reality, Interactions and Physical Simulations*, pp. 47–54, 2011. [40](#)
- [Glondou 12a] L. Glondou, L. Muguercia, M. Marchal, C. Bosch, H. Rushmeier, G. Dumont, G. Drettakis. – Example-based fractured appearance. *Computer Graphics Forum*, 31:1547–1556, 2012. [36](#), [38](#), [39](#), [78](#), [139](#), [141](#)
- [Glondou 12b] L. Glondou, S.C. Schvartzman, M. Marchal, G. Dumont, M.A. Otaduy. – Efficient collision handling for brittle fracture. – *Proc. of the ACM SIGGRAPH/Eurographics Symposium on Computer Animation*, pp. 285–294, 2012. [36](#), [40](#)
- [Glondou 13] L. Glondou, M. Marchal, G. Dumont. – Real-time simulation of brittle fracture using modal analysis. *IEEE Trans. on Visualization and Computer Graphics*, 19:201–209, 2013. [36](#), [37](#), [38](#), [39](#), [76](#)
- [Glondou 14] L. Glondou, S.C. Schvartzman, M. Marchal, G. Dumont, M.A. Otaduy. – Fast collision detection for fracturing rigid bodies. *IEEE Trans. on Visualization and Computer Graphics*, 20:30–41, 2014. [36](#), [40](#)
- [Goksel 06] O. Goksel, S.E. Salcudean, S. P. DiMaio. – 3d simulation of needle-tissue interaction with application to prostate brachytherapy. *Computer Aided Surgery*, 11(6):279–288, 2006. [46](#)
- [Harris 65] C.S. Harris. – Perceptual adaptation to inverted, reversed, and displaced vision. *Psychological Review*, 72(6):419–444, 1965. [114](#)
- [Harwin 02] W.S. Harwin, N. Melder. – Improved haptic rendering for multi-finger manipulation using friction cone based god-objects. – *Proc. of Eurohaptics*, 2002. [73](#)
- [Hayward 08] V. Hayward. – Physically-based haptic synthesis. *Haptic Rendering: Foundations, Algorithms and Applications*, éd. par M. Lin, M. Otaduy, pp. 237–309. – A.J. Peters, 2008. [141](#)
- [Heintz 09] M. Heintz. – Real walking in virtual learning environments: Beyond the advantage of naturalness. *Learning in the Synergy of Multiple Disciplines*, éd. par U. Cress, V. Dimitrova, M. Spech, pp. 584–595. – Springer Berlin Heidelberg, 2009. [128](#)

- [Hinckley 04] K. Hinckley, R.J.K. Jacob, C. Ware. – *Computer Science Handbook*, chap. Input/Output Devices and Interaction Techniques. – Chapman and Hall/CRC, 2004. [11](#)
- [Hing 07] J.T. Hing, A. D. Brokks, J.P. Desai. – A biplanar fluoroscopic approach for the measurement, modeling, and simulation of needle and soft-tissue interaction. *Medical Image Analysis*, 11:62–78, 2007. [46](#)
- [Hoefler 02] U. Hoefler, T. Langen, J. Nziki, F. Zeitler, J. Hesser, U. Mueller, W. Voelker, R. Maenner. – Cathi - catheter instruction system. – *Proc. of Computer Assisted Radiology and Surgery*, pp. 101 – 06, Paris, France, 2002. [51](#)
- [Hollerbach 02] J. Hollerbach. – Locomotion interfaces. *Handbook of Virtual Environments*, éd. par Kay M. Stanney, p. 1232. – CRC Press, 2002. [128](#)
- [Hollerbach 03] J. Hollerbach, D. Checcacci, H. Noma, Y. Yanagida, N. Tetsutani. – Simulating side slopes on locomotion interfaces using torso forces. – *Proc. of International Symposium on Haptic Interfaces for Virtual Environment and Teleoperator Systems*, p. 91, 2003. [100](#)
- [Holmes 98] C. Holmes, R. Hoge, L. Collins, R. Woods, A. Toga, A. Evans. – Enhancement of mr images using registration for signal averaging. *Journal of Computer Assisted Tomography*, 22:324, 1998. [30](#)
- [Holz 08] D. Holz, S. Ullrich, M. Wolter, T. Kühlen. – Multi-contact grasp interaction for virtual environments. *Journal of Virtual Reality and Broadcasting*, 5(7), 2008. [73](#)
- [Iben 06] H.N. Iben, J.F. O'Brien. – Generating surface crack patterns. – *Proc. of SIGGRAPH/Eurographics Symposium on Computer Animation*, pp. 177–185, 2006. [78](#)
- [Iwata 01] H. Iwata, H. Yano, F. Nakaizumi. – Gait master: A versatile locomotion interface for uneven virtual terrain. – *Proc. of IEEE Virtual Reality Conference*, pp. 131–137, 2001. [100](#), [112](#)
- [Jacobs 12] J. Jacobs, M. Stengel, B. Froehlich. – A generalized god-object method for plausible finger-based interactions in virtual environments. – *Proc. of IEEE Symposium on 3D User Interfaces*, pp. 43–51, 2012. [53](#), [73](#), [120](#)
- [Kaufman 08] D.M. Kaufman, S. Sueda, D.L. James, D.K. Pai. – Staggered projections for frictional contact in multibody systems. *ACM Trans. on Graphics*, 27:164:1–164:11, 2008. [26](#)
- [Keiser 05] R. Keiser, B. Adams, D. Gasser, P. Bazzi. – A unified lagrangian approach to solid-fluid animation. – *Proc. of Eurographics/IEEE Symposium on Point-Based Graphics*, pp. 125–148, 2005. [69](#)
- [Kennedy 01] M. Kennedy, A. O'Hagan. – Bayesian calibration of computer models. *Journal of the Royal Statistical Society, Series B*. 53:425–464, 2001. [139](#)

- [Kerdok 03] A. Kerdok, S. Cotin, M. Ottensmeyer, A. Galea, R. Howe, S. Dawson. – Truthcube : Establishing physical standards for real time soft tissue simulation. *Medical Image Analysis*, 7:283–291, 2003. [22](#)
- [Kuchenbecker 06] K.J. Kuchenbecker, J. Fiene, G. Niemeyer. – Improving contact realism through event-based haptic feedback. *IEEE Trans. on Visualization and Computer Graphics*, 12(2):219–230, 2006. [88](#)
- [LaViola 01] J.J. LaViola, D.A. Feliz, D.F. Keefe, R.C. Zeleznik. – Hands-free multi-scale navigation in virtual environments. – *Proc. of the ACM symposium on Interactive 3D graphics*, pp. 9–15, 2001. [128](#)
- [Lécuyer 04] A. Lécuyer, J-M. Burkhardt, L. Etienne. – Feeling bumps and holes without a haptic interface: the perception of pseudo-haptic textures. – *Proc. of SIGCHI Conference on Human factors in computing systems*, pp. 239–246, 2004. [100](#), [103](#)
- [Lécuyer 06] A. Lécuyer, J-M. Burkhardt, J-M. Henaff, S. Donikian. – Camera motions improve the sensation of walking in virtual environments. – *Proc. of IEEE Virtual Reality Conference*, pp. 11–18, 2006. [91](#)
- [Lécuyer 09] A. Lécuyer. – Simulating haptic feedback using vision: a survey of research and applications of pseudo-haptic feedback. *Presence: Teleoperators and Virtual Environments*, 18(1):39–53, 2009. [100](#)
- [Lécuyer 13] A. Lécuyer, L. George, M. Marchal. – Toward adaptive vr simulators combining visual, haptic, and brain-computer interface. *IEEE Computer Graphics and Applications*, 33(5):18–23, 2013. [93](#), [95](#)
- [Lee 08] S. Lee, G. Kim. – Effects of haptic feedback, stereoscopy, and image resolution on performance and presence in remote navigation. *International Journal of Human-Computer Studies*, 66:701–717, 2008. [11](#)
- [Leine 03] R.I. Leine, C. Glocker. – A set-valued force law for spatial coulomb-contensou friction. *European Journal of Mechanics - A/Solids*, 22(2):193 – 216, 2003. [55](#), [56](#)
- [Leskowsky 06] R. Leskowsky, M. Cooke, M. Ernst, M. Harders. – Using multidimensional scaling to quantify the fidelity of haptic rendering of deformable objects. – *Proc. of EuroHaptics*, pp. 289–295, 2006. [22](#)
- [Marchal 06] M. Marchal. – *Modélisation des tissus mous dans leur environnement pour l'aide aux gestes médico-chirurgicaux*. – PhD. Thesis, Université Joseph Fourier, 2006. [13](#)
- [Marchal 08] M. Marchal, J. Allard, C. Duriez, S. Cotin. – Towards a framework for assessing deformable models in medical simulation. – *Proc. of International Symposium on Computational Models for Biomedical Simulation*, pp. 176–184, 2008. [22](#)
- [Marchal 10] M. Marchal, A. Lécuyer, G. Cirio, L. Bonnet, M. Emily. – Walking up and down in immersive virtual worlds: Novel interactive techniques based on visual feedback. – *Proc. of IEEE Symposium on 3D User Interfaces*, pp. 19–26, 2010. [100](#)

-
- [Marchal 11] M. Marchal, J. Pettré, A. Lécuyer. – Joyman: a human-scale joystick for navigating in virtual worlds. – *Proc. of IEEE Symposium on 3D User Interfaces*, pp. 19–26, 2011. [112](#)
- [Marchal 12] M. Marchal, A. Lécuyer, G. Cirio, L. Bonnet, M. Emily. – *Walking with the Senses*, chap. Pseudo-haptic walking. – Logos Verlag, 2012. [100](#)
- [Melder 03] N. Melder, W.S. Harwin. – Translation and rotation of multi-point contacted virtual objects. – *Proc. of Eurohaptics*, 2003. [73](#)
- [Melder 04] N. Melder, W.S. Harwin. – Extending the friction cone algorithm for arbitrary polygon based haptic objects. – *Proc. of HAPTICS*, pp. 234–241, 2004. [73](#)
- [MercierGanady 14] J. Mercier-Ganady, F. Lotte, E. Loup-Escande, M. Marchal, A. Lécuyer. – The mind-mirror: See your brain in action in your head using eeg and augmented reality. – *Proc. of IEEE Virtual Reality Conference*, pp. 33–38, 2014. [117](#)
- [Miguel 12] E. Miguel, D. Bradley, B. Thomaszewski, B. Bickel, W. Matusik, M.A. Otaduy, S. Marschner. – Data-driven estimation of cloth simulation models. *Computer Graphics Forum*, 31(2):519–528, 2012. [138](#)
- [Milenkovic 01] V.J. Milenkovic, H. Schmidl. – Optimization based animation. – *Proc. of SIGGRAPH*, pp. 37–46, 2001. [26](#)
- [Moehring 11] M. Moehring, B. Froehlich. – Effective manipulation of virtual objects within arm’s reach. – *Proc. of IEEE Virtual Reality Conference*, pp. 131–138, 2011. [120](#)
- [Monaghan 92] J. J. Monaghan. – Smoothed particle hydrodynamics. *Annual Review of Astronomy and Astrophysics*, 30(1):543–574, 1992. [66](#)
- [Müller 03] M. Müller, D. Charypar, M. Gross. – Particle-based fluid simulation for interactive applications. – *Proc. of the ACM SIGGRAPH/Eurographics Symposium on Computer animation*, pp. 154–159, 2003. [66](#)
- [Müller 04a] M. Müller, M. Gross. – Interactive virtual materials. – *Proc. of Graphics Interface*, pp. 239–246, 2004. [24](#), [56](#), [78](#)
- [Müller 04b] M. Müller, S. Schirm, M. Teschner, B. Heidelberger, M. Gross. – Interaction of fluids with deformable solids. *Computer Animation and Virtual Worlds*, 15:159–171, 2004. [69](#)
- [Nagahara 03] H. Nagahara, Y. Yagi, M. Yachida. – Wide field of view head mounted display for tele-presence with an omnidirectional image sensor. – *Proc. of Int. Conf. on Computer Vision and Pattern Recognition Workshop*, p. 86, 2003. [114](#)
- [Nealen 06] A. Nealen, M. Müller, R. Keiser, E. Boxerman, M. Carlson. – Physically based deformable models in computer graphics. *Computer Graphics Forum*, 25:809–836, 2006. [10](#)

- [Nordahl 10] R. Nordahl, A. Berrezag, S. Dimitrov, L. Turchet, V. Hayward, S. Serafin. – Preliminary experiment combining virtual reality haptic shoes and audio synthesis. – *Proc. of Eurohaptics*, pp. 123–129, 2010. [88](#)
- [Nowinski 01] W.L. Nowinski, C.K. Chui. – Simulation of interventional neuroradiology procedures. – *Proc. of MIAR*, pp. 87 – 94, 2001. [51](#)
- [O’Brien 02] J.F. O’Brien, A.W. Bargteil, J.K. Hodgins. – Graphical modeling and animation of ductile fracture. *ACM Trans. on Graphics*, 21(3):291–294, 2002. [78](#)
- [Okamura 04] A. Okamura, C. Simone, M. O’Leary. – Force modeling for needle insertion into soft tissue. *IEEE Trans. on Biomedical Engineering*, 51:1707–1716, 2004. [46](#)
- [Ortega 07] M. Ortega, S. Redon, S. Coquillart. – A six degree-of-freedom god-object method for haptic display of rigid bodies with surface properties. *IEEE Trans. on Visualization and Computer Graphics*, 13(3):458–469, 2007. [73](#)
- [Otaduy 12] M.A. Otaduy, B. Bickel, D. Bradley, H. Wang. – Data-driven simulation methods in computer graphics: Cloth, tissue and faces. – *ACM Siggraph Courses*, 2012. [138](#)
- [Pausch 95] R. Pausch, T. Burnette, D. Brockway, M.I E. Weiblen. – Navigation and locomotion in virtual worlds via flight into hand-held miniatures. – *Proc. of SIGGRAPH*, pp. 399–400, 1995. [112](#)
- [Pernod 11] E. Pernod, M. Sermesant, E. Konukoglu, J. Relan, H. Delingette, N. Ayache. – A multi-front eikonal model of cardiac electrophysiology for interactive simulation of radio-frequency ablation. *Computers and Graphics*, 35:431–440, 2011. [8](#)
- [Petkov 12] K. Petkov, C. Papadopoulos, M. Zhang, A.E. Kaufman, X. Gu. – Interactive visibility retargeting in vr using conformal visualization. *IEEE Trans. on Visualization and Computer Graphics*, 18(7):1027–1040, 2012. [82](#), [83](#)
- [Przemieniecki 68] J.S. Przemieniecki. – *Theory of Matrix Structural Analysis*. – McGraw-Hill, 1968. [51](#)
- [Razzaque 01] Sharif Razzaque, Zachariah Kohn, Mary C. Whitton. – Redirected walking. – *Proc. of Eurographics*, 2001. [112](#), [128](#)
- [RegiaCorte 13] T. Regia-Corte, M. Marchal, G. Cirio, A. Lécuyer. – Perceiving affordances in virtual reality: influence of person and environmental properties in perception of standing on virtual grounds. *Virtual Reality*, 17(1), 2013. [85](#)
- [Reinertsen 06] I. Reinertsen, D. L. Collins. – A realistic phantom for brain-shift simulations. *Medical Physics*, 33:3234–3240, 2006. [30](#)
- [Richardson 55] E.G. Richardson. – The sounds of impact of a solid on a liquid surface. *Proceedings of the Physical Society. Section B*, 68(8):541–547, 1955. [88](#)

- [Ruddle 09] R.A. Ruddle, S. Lessels. – The benefits of using a walking interface to navigate virtual environments. *ACM Trans. Computer-Human Interaction*, 16(1):1–18, 2009. [128](#)
- [Ruspini 97] D.C. Ruspini, K. Kolarov, O. Khatib. – The haptic display of complex graphical environments. – *Proc. of SIGGRAPH*, pp. 345–352, 1997. [73](#)
- [Schlattman 07] M. Schlattman, R. Klein. – Simultaneous 4 gestures 6 dof realtime two-hand tracking without any markers. – *Proc. of ACM VRST*, pp. 39–42, 2007. [120](#)
- [Shin 10] H. Shin, C. Doumas, T. Funkhouser, S. Rusinkiewicz, K. Steiglitz, A. Vlachopoulos, T. Weyrich. – Analyzing fracture patterns in Theran wall paintings. – *Proc. of VAST*, 2010. [78](#)
- [Slater 95] Mel Slater, Martin Usoh, Anthony Steed. – Taking steps: The influence of a walking technique on presence in virtual reality. *ACM Trans. on Computer-Human Interaction*, 2(3):201–219, 1995. [9](#), [112](#), [128](#), [131](#)
- [Solenthaler 07] B. Solenthaler, J. Schläfli, R. Pajarola. – A unified particle model for fluid-solid interactions. *Computer Animation and Virtual Worlds*, 18:69–82, 2007. [69](#)
- [Srinivasan 96] M.A. Srinivasan, G.L. Beauregard, D.L. Brock. – The impact of visual information on the haptic perception of stiffness in virtual environments. – *Proc. of ASME Dynamics Systems and Control Division*, pp. 555–559, 1996. [103](#)
- [Srinivasan 97] M.A. Srinivasan, C. Basdogan. – Haptics in virtual environments: Taxonomy, research status, and challenges. *Computers & Graphics*, 21(4):393–404, 1997. [11](#)
- [Stam 95] J. Stam, E. Fiume. – Depicting fire and other gaseous phenomena using diffusion processes. – *Proc. of SIGGRAPH*, pp. 129–136. ACM Press, 1995. [66](#)
- [Stanney 02] K.M. Stanney. – *Handbook of Virtual Environments: Design, Implementation, and Applications*. – Lawrence Erlbaum Associates, 2002. [112](#)
- [Steinicke 09] F. Steinicke, G. Bruder, J. Jerald, H. Frenz, M. Lapp. – Estimation of detection thresholds for redirected walking techniques. *IEEE Trans. on Visualization and Computer Graphics*, 16(1):17–27, 2009. [100](#)
- [Surry 04] K. J. M. Surry, H. J. B. Austin, A. Fenster, T. M. Peters. – Poly(vinyl alcohol) cryogel phantoms for use in ultrasound and mr imaging. *Physics in Medicine and Biology*, 49:5529–5546, 2004. [30](#)
- [Sutherland 65] E. Sutherland. – The ultimate display. – *Proc. of IFIP Congress*, pp. 506–508, 1965. [7](#)

- [Talvas 12] A. Talvas, M. Marchal, C. Nicolas, G. Cirio, M. Emily, A. Lécuyer. – Novel interactive techniques for bimanual manipulation of 3d objects with two 3dof haptic interfaces. – *Proc. of Eurohaptics*, pp. 552–563, 2012. [123](#)
- [Talvas 13] A. Talvas, M. Marchal, A. Lécuyer. – The god-finger method for improving 3d interaction with virtual objects through simulation of contact area. – *Proc. of IEEE Symposium on 3D User Interfaces*, pp. 111–114, 2013. [73](#), [123](#)
- [Talvas 15] A. Talvas, M. Marchal, C. Duriez, M.A. Otaduy. – Aggregate constraints for virtual manipulation with soft fingers. – *Submitted*, 2015. [53](#)
- [Templeman 99] J.N. Templeman, P.S. Denbrook, L.E. Sibert. – Virtual locomotion: Walking in place through virtual environments. *Presence: Teleoperators and Virtual Environments*, 8(6):598–617, 1999. [128](#)
- [Terziman 10] L. Terziman, M. Marchal, M. Emily, F. Multon, B. Arnaldi, A. Lécuyer. – Shake-your-head: Revisiting walking-in-place for desktop virtual reality. – *Proc. of the ACM Symposium on on Virtual Reality Software and Technology*, pp. 27–34, 2010. [132](#)
- [Terziman 11] L. Terziman, M. Marchal, F. Multon, B. Arnaldi, A. Lécuyer. – Comparing virtual trajectories made in slalom using walking-in-place and joystick techniques. – *Proc. of the Eurographics Symposium on Virtual Environments-Euro VR Conference*, pp. 55–58, 2011. [133](#)
- [Terziman 12] L. Terziman, M. Marchal, F. Multon, B. Arnaldi, A. Lécuyer. – The king-kong effects: Improving sensation of walking in vr with visual and tactile vibrations at each step. – *Proc. of IEEE Virtual Reality Conference*, pp. 19–26, 2012. [91](#), [100](#)
- [Trapp 09] M. Trapp, H. Lorenz, J. Döllner. – Interactive stereo rendering for non-planar projections of 3d virtual environments. – *Proc. of GRAPP*, pp. 199–204, 2009. [82](#)
- [Turchet 10] L. Turchet, M. Marchal, A. Lécuyer, S. Serafin, R. Nordahl. – Influence of visual feedback for perceiving walking over bumps and holes in desktop vr. – *Proc. of 17th ACM Symposium on Virtual Reality Software and Technology*, pp. 139–142, 2010. [102](#)
- [Usoh 99] M. Usoh, K. Arthur, M.C. Whitton, R. Bastos, A. Steed, M. Slater, F.P. Brooks Jr. – Walking > walking-in-place > flying, in virtual environments. – *Proc. of the 26th annual conference on Computer graphics and interactive techniques*, pp. 359–364, 1999. [128](#)
- [Visell 08] Y. Visell, J. Cooperstock, B. Giordano, K. Franinovic, A. Law, S. McAdams, K. Jathal, F. Fontana. – A vibrotactile device for display of virtual ground materials in walking. – *Proc. of Eurohaptics*, pp. 420–426, 2008. [88](#), [89](#)

-
- [Visell 10] Y. Visell, A. Law, J. Ip, S. Smith, J. Cooperstock. – Interaction capture in immersive virtual environments via an intelligent floor surface. – *Proc. of IEEE Virtual Reality*, pp. 313–314, 2010. [12](#), [88](#)
- [Wang 11] H. Wang, R. Ramamoorthi, J. O’Brien. – Data-driven elastic models for cloth: Modeling and measurement. *ACM Trans. on Graphics*, 30(4):71:1–71:11, 2011. [138](#)
- [Wendt 10] J.D. Wendt, M.C. Whitton, F.P. Brooks Jr. – Gud wip: Gait-understanding-driven walking-in-place. – *Proc. of the IEEE Conference on Virtual Reality*, pp. 51–58, 2010. [131](#)
- [Williams 07] B. Williams, G. Narasimham, B. Rump, T. P. McNamara, T.H. Carr, J. Rieser, B. Bodenheimer. – Exploring large virtual environments with an HMD when physical space is limited. – *Proc. of the ACM symposium on Applied perception in graphics and visualization*, pp. 41–48, 2007. [128](#), [129](#)
- [Wolpaw 02] J.R. Wolpaw, N. Birbaumer, D.J. McFarland, G. Pfurtscheller, T.M. Vaughan. – Brain-computer interfaces for communication and control. *Clinical Neurophysiology*, 113(6):767–791, 2002. [93](#)
- [Yang 09] M. Yang, J. Lu, Z. Zhou, A. Safonova, , K. Kuchenbecker. – A gpu-based approach for real-time haptic rendering of 3d fluids. – *Proc. of SIGGRAPH Asia Sketches*, 2009. [66](#)
- [Yao 06] H.Y. Yao, V. Hayward. – An experiment on length perception with a virtual rolling stone. – *Proc. of Eurohaptics*, pp. 325–330, 2006. [141](#)
- [ZahiriAzar 06] R. Zahiri-Azar, S.E. Salcudean. – Motion estimation in ultrasound images using time domain cross correlation with prior estimates. *IEEE Trans. on Biomedical Engineering*, 53(10):1990–2000, 2006. [47](#)
- [Zanbaka 05] C.A. Zanbaka, B.C. Lok, S.V. Babu, A.C. Ulinski, L.F. Hodges. – Comparison of path visualizations and cognitive measures relative to travel technique in a virtual environment. *IEEE Trans. on Visualization and Computer Graphics*, 11(6):694–705, 2005. [128](#)
- [Zander 11] T.O. Zander, C. Kothe. – Towards passive brain-computer interfaces: applying brain-computer interface technology to human-machine systems in general. *Journal of Neural Engineering*, 8(2), 2011. [93](#)
- [Zienkiewicz 00] O.C. Zienkiewicz, R.L. Taylor. – *The Finite Element Method*. – Fifth Edition. Butterworth-Heinemann, 2000. [23](#)
- [Zilles 95] C.B. Zilles, J.K. Salisbury. – A constraint-based god-object method for haptic display. – *Proc. of IROS*, pp. 146–151, 1995. [73](#)

List of Figures

1	Medical virtual environments	8
2	3D interaction loop	10
3	3D interaction loop - Contributions	13
4	Interaction loop - Part 1	19
1.1	Comparison of deformable models.	25
1.2	Comparison of rigid body engines. Test cases	27
1.3	Comparison of rigid body engines. Fourth test case.	29
1.4	Comparison of rigid body engines. Results	29
1.5	Brain phantom.	30
1.6	Brain phantom images.	31
1.7	Brain phantom deformations.	31
1.8	Selection of phantoms designed these last years.	32
2.1	Illustration of the energy-based criterion.	37
2.2	Contact duration method for brittle fracture.	38
2.3	Effect of damping on the fracture simulation.	39
2.4	Fracture propagation on a road.	39
2.5	Database approach for fracture fragments.	40
2.6	Collision detection for fracture fragments.	41
2.7	Benchmark for fracture simulation.	42
2.8	Simulation of capsulorhexis during cataract surgery.	43
3.1	Experimental setup for needle insertion.	47
3.2	Needle measurements.	48
3.3	Needle phantom.	48
3.4	Parameter identifications for the needle-tissue model.	49
3.5	Experimental setup for coil deployment.	52
3.6	Parameter identification for coil deployment.	52
3.7	Formulation of separation contact constraints as a volume constraint.	54
3.8	Uniform vs. non-uniform pressure distribution.	55
3.9	Coulomb-Contensou formulation for the aggregate constraint approach.	56
3.10	Hand model.	57
3.11	Manipulation scenarios with the deformable hand (2).	58
3.12	Manipulation scenarios with the deformable hand.	58
3.13	Pen example with the deformable hand.	58
3.14	Interaction loop - Part 2	63
4.1	Smoothing volume and SPH haptic forces.	67
4.2	Rigid-fluid interaction.	68
4.3	6 DoF haptic rendering with fluids: illustrative scenario.	68

4.4	Scenario illustrating a cooking simulator	70
4.5	Virtual Crepe Factory.	70
4.6	Haptic-sub world main algorithm	71
4.7	Graph-based haptic sub-world	72
4.8	Concept of the God-finger method.	74
4.9	Steps of the God-finger method.	74
4.10	Illustrative results with the God-finger.	75
4.11	Illustrative results with the God-finger.	75
5.1	Overview of the optimization process	79
5.2	Snapshot of fracture modeller interface	79
5.3	Application of our example-based fracturing method on different scenes	80
5.4	Fracture patterns applied on different objects	81
5.5	Illustration of rasterization issues.	83
5.6	Stereoscopic rendering of 360° view.	84
5.7	Stereoscopic rendering with different FoV.	84
6.1	The three components of our vibrotactile model	89
6.2	Interaction examples for the vibrotactile rendering of fluids	90
6.3	Concept of the King Kong Effects.	91
6.4	Experimental setup - King Kong effects.	92
6.5	Results of the questionnaires for the KKE experiment.	93
6.6	Passive BCI system that adapts haptic feedback.	94
6.7	Experimental setups. Passive BCI setup and force feedback.	95
6.8	Illustration of the medical simulation with user-adapted guidance.	96
7.1	Pseudo-haptic walking. The different effects.	101
7.2	Pseudo-haptic walking results.	102
7.3	Elastic image simulation	104
7.4	Elastic image simulation: sponge	104
7.5	Interaction loop - Part 3	109
8.1	Principle of the Joyman.	112
8.2	Joyman illustrative images	113
8.3	Joyman virtual locomotion control	113
8.4	Joyman version 2	114
8.5	Flyviz illustration	115
8.6	Flyviz image processing	116
8.7	Flyviz illustration	116
9.1	Illustration of the Virtual Mitten.	120
9.2	Elastic device for the Virtual Mitten.	121
9.3	Pseudo-haptic approach for the Virtual Mitten.	121
9.4	Fruit-o-Matic with the Virtual Mitten.	122
9.5	Double bubble technique.	124
9.6	Joint control for bimanual grasping.	124
9.7	Bimanual grasping scenarios.	125
9.8	Magnetic pinch.	125
10.1	The Magic Barrier Tape	129
10.2	Screenshots illustrating the three techniques	130

10.3 Virtual Companion	131
10.4 Concept Shake-Your-Head.	132
10.5 Extracted head motions with SYH.	133

Résumé

Le virtuel est devenu un vaste champ d'exploration pour la recherche et offre de nos jours de nombreuses possibilités : assister le chirurgien, réaliser des prototypes de pièces industrielles, simuler des phénomènes naturels, remonter dans le temps ou proposer des applications ludiques aux utilisateurs au travers de jeux ou de films. Bien plus que le rendu purement visuel d'environnement virtuel, la réalité virtuelle aspire à -littéralement- immerger l'utilisateur dans le monde virtuel. L'utilisateur peut ainsi interagir avec le contenu numérique et percevoir les effets de ses actions au travers de différents retours sensoriels. Permettre une véritable immersion de l'utilisateur dans des environnements virtuels de plus en plus complexes confronte la recherche en réalité virtuelle à des défis importants: les gestes de l'utilisateur doivent être capturés puis directement transmis au monde virtuel afin de le modifier en temps-réel. Les retours sensoriels ne sont pas uniquement visuels mais doivent être combinés avec les retours auditifs ou haptiques dans une réponse globale multimodale. L'objectif principal de mes activités de recherche consiste à améliorer l'interaction 3D avec des environnements virtuels complexes en proposant de nouvelles approches utilisant la simulation physique et exploitant au mieux les différentes modalités sensorielles. Dans mes travaux, je m'intéresse tout particulièrement à concevoir des interactions avec des mondes virtuels complexes. Mon approche peut être décrite au travers de trois axes principaux de recherche: (1) la modélisation dans les mondes virtuels d'environnements physiques plausibles où les objets réagissent de manière naturelle, même lorsque leur topologie est modifiée ou lorsqu'ils sont en interaction avec d'autres objets, (2) la mise en place de retours sensoriels multimodaux vers l'utilisateur intégrant des composantes visuelles, haptiques et/ou sonores, (3) la prise en compte de l'interaction physique de l'utilisateur avec le monde virtuel dans toute sa richesse : mouvements de la tête, des deux mains, des doigts, des jambes, voire de tout le corps, en concevant de nouveaux dispositifs ou de nouvelles techniques d'interactions 3D. Les différentes contributions que j'ai proposées dans chacun de ces trois axes peuvent être regroupées au sein d'un cadre plus général englobant toute la boucle d'interaction 3D avec les environnements virtuels. Elles ouvrent des perspectives pour de futures applications en réalité virtuelle mais également plus généralement dans d'autres domaines tels que la simulation médicale, l'apprentissage de gestes, la robotique, le prototypage virtuel pour l'industrie ou bien les contenus web.

Abstract

The virtual has become a huge field of exploration for researchers: it could assist the surgeon, help the prototyping of industrial objects, simulate natural phenomena, be a fantastic time machine or entertain users through games or movies. Far beyond the only visual rendering of the virtual environment, the Virtual Reality aims at -literally- immersing the user in the virtual world. VR technologies simulate digital environments with which users can interact and, as a result, perceive through different modalities the effects of their actions in real time. The challenges are huge: the user's motions need to be perceived and to have an immediate impact on the virtual world by modifying the objects in real-time. In addition, the targeted immersion of the user is not only visual: auditory or haptic feedback needs to be taken into account, merging all the sensory modalities of the user into a multimodal answer. The global objective of my research activities is to improve 3D interaction with complex virtual environments by proposing novel approaches for physically-based and multimodal interaction. I have laid the foundations of my work on designing the interactions with complex virtual worlds, referring to a higher demand in the characteristics of the virtual environments. My research could be described within three main research axes inherent to the 3D interaction loop: (1) the physically-based modeling of the virtual world to take into account the complexity of the virtual object behavior, their topology modifications as well as their interactions, (2) the multimodal feedback for combining the sensory modalities into a global answer from the virtual world to the user and (3) the design of body-based 3D interaction techniques and devices for establishing the interfaces between the user and the virtual world. All these contributions could be gathered in a general framework within the 3D interaction loop. By improving all the components of this framework, I aim at proposing approaches that could be used in future virtual reality applications but also more generally in other areas such as medical simulation, gesture training, robotics, virtual prototyping for the industry or web contents.