



**HAL**  
open science

# Energy-aware wireless networked control using radio-mode management in the case of a finite horizon

Matthew Fitch, Nicolas Cardoso de Castro, Federica Garin

► **To cite this version:**

Matthew Fitch, Nicolas Cardoso de Castro, Federica Garin. Energy-aware wireless networked control using radio-mode management in the case of a finite horizon. [Internship report] 2012. inria-00613598

**HAL Id: inria-00613598**

**<https://inria.hal.science/inria-00613598v1>**

Submitted on 5 Aug 2012

**HAL** is a multi-disciplinary open access archive for the deposit and dissemination of scientific research documents, whether they are published or not. The documents may come from teaching and research institutions in France or abroad, or from public or private research centers.

L'archive ouverte pluridisciplinaire **HAL**, est destinée au dépôt et à la diffusion de documents scientifiques de niveau recherche, publiés ou non, émanant des établissements d'enseignement et de recherche français ou étrangers, des laboratoires publics ou privés.

# Energy-aware wireless networked control using radio-mode management in the case of a finite horizon

Matthew Fitch, Nicolas Cardoso De Castro, Federica Garin

**Abstract**—Energy efficiency is one of the main issues in wireless Networked Control Systems. The control community has already shown large interest in the topics of intermittent estimation and control, allowing to turn off the radio of the nodes which is the main energy consumer. While the existing literature only addresses policies using two radio-modes (ON/OFF), this paper considers intermediate radio-modes (*e.g.* IDLE), which consume less energy than the ON mode and offer better reactivity than the OFF mode, but introduce transition costs. The objective of the paper is to discuss the relevance and benefit to use low consuming radio-modes and to propose a mode switching policy to perform a trade-off between energy savings and performance of the control application in the case where we have a finite horizon. We propose two possible algorithms which solve this using dynamic programming, and then test them with an example of an application.

**Index Terms**—Networked Control Systems, radio-mode management, dynamic programming, switched systems.

## I. INTRODUCTION

Networked Control Systems (NCS) are systems in which the sensors or/and the actuators communicate with the controller through a network. Energy saving and robustness to data loss are major challenges in wireless control, addressed by both communication and control communities. The survey paper [3] draws the conclusion that the radio chip is the main energy consumer in a node and that communication and control co-design is essential to save large amounts of energy. Authors in [8] also point out that co-design increases control performance in delayed and lossy environments.

Deep interest has been devoted to intermittent estimation and control, *i.e.* estimation or control problems where the measurements may not be available at some undetermined time because the sensor node switches off to save energy. Authors in : [1], [4], [7], [5], [6], [9], [10], [11] consider such setups. However, in some, only two modes were considered while optimising. Others concentrate on saving energy by turning off entire features of the node, where time is the main issue. However, our approach consists in investigating how to save energy at the application level, where we consider the radio-mode transitions as instantaneous, since the transition delays are negligible with respect to the sampling time of our control application. Energy issue is then our main motivation. Indeed, although intermediate modes consume less energy, the energy needed to switch between modes may result in more wastes than savings. Deriving a switching policy that ensures good control performance and energy savings is not trivial.

On the one hand, works considering mode management (*e.g.* [9], [1]) do not address control problems, and on the other

hand, works dealing with intermittent control only assume that the radio is either awake or asleep. Finally, [2] does exactly the same as this paper except that it is done when there are an infinite number of steps rather than a finite number, as will be done in this paper. The main contribution of this paper is to consider intermediate radio-modes and their energy transition costs in a control problem which lasts only a finite number of steps. Not only the sensor node should decide whether transmitting or not, but also when not transmitting, it should decide which of the low consuming modes to switch to.

A switched linear system taking into account several radio-modes and the control application is derived in Section II. An optimal switching policy, computed using Dynamic Programming, is presented in Section III. Simulation results are provided in Section IV and Section V concludes the paper and gives future directions.

## II. PROBLEM FORMULATION

### A. Setup description

We consider a wireless networked control problem composed of two nodes, as depicted in Fig. 1 and described hereafter. The first node is in charge of sensing the plant's output and deciding whether or not to send its measurement to the second node, in charge of controlling the plant. The aim of this paper is to save energy at the sensor's radio chip level when the quality of the feedback control is good enough. The radio chip is switched to low consuming modes (*e.g.* Idle, OFF) to save energy. We are not interested here in the consumption of the second node as we assume that it is co-located with the actuator, and then it has access to an unlimited energy source. Also, the channel is considered as perfect in the model, even though we show in simulation that our solution is robust to measurement drop-outs.

We define  $N$  as the number of radio-modes. The switching decision is denoted by  $v_t \in \{1, 2, \dots, m\}$ , where  $v_t = i$  means that the radio-mode is switched to mode  $i$  at time  $t$ .

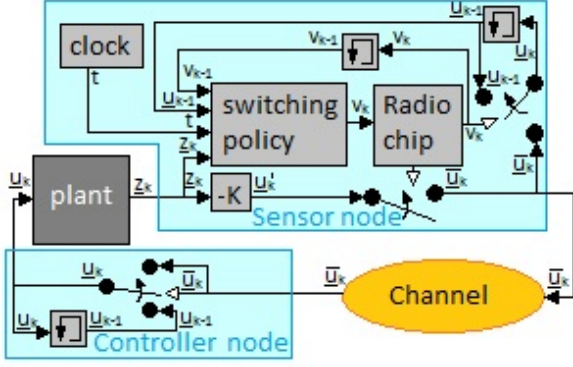

Fig. 1. Block diagram of the problem setup. The sensor node measures the state  $z_t$  from the plant and decides whether to send it or not to the controller node.  $\bar{z}_t$  is equal to  $z_t$  when a transmission occurs, or to  $\emptyset$  otherwise. The controller is then able to determine if a transmission has occurred or not.

1) *Plant model*: The plant we control is a linear unstable discrete-time observable system, described by Eq. (1).

$$z_{t+1} = Az_t + Bu_t, \quad z_t \in \mathbb{R}^n, \quad u_t \in \mathbb{R}^p. \quad (1)$$

2) *Control law*: The control input applied to the plant depends on the measurement arrivals, as described in Eq. (2). If the sensor decides to send the plant state, then the control law is a state feedback with gain  $K$ . This gain is chosen so that the system  $z_{t+1} = (A - BK)z_t$  is stable. Otherwise, the control input is held to its previous value as long as no new measure is received from the sensor.

$$u_t = \begin{cases} -Kz_t & \text{if } z_t \text{ is available,} \\ u_{t-1} & \text{otherwise.} \end{cases} \quad (2)$$

3) *Radio chip model*: The radio chip is characterised by the number of radio-modes,  $N$ , and the associated costs to stay in a given mode or to switch from a mode to another. We do not consider mode transition delay, assuming that the time scale of the control application is slow enough with respect to the transition delays.

The first radio-mode (generally called the ON mode) is the only one allowing transmission/reception, and the most consuming one. The other modes are intermediate modes where only some components of the radio are turned off, consuming less energy than the ON mode. The last radio-mode (called the OFF mode) consumes no or little energy (less than any other mode), but more time and/or energy are needed to switch to the ON mode from the OFF mode than from the intermediate modes. We define  $\theta_{i,j}$  as the energy needed to switch from the  $i^{\text{th}}$  mode to the  $j^{\text{th}}$  one, and  $\theta_{i,i}$  as the energy to stay in the  $i^{\text{th}}$  mode. This is illustrated on Fig. 2 in the case where  $N = 3$ .

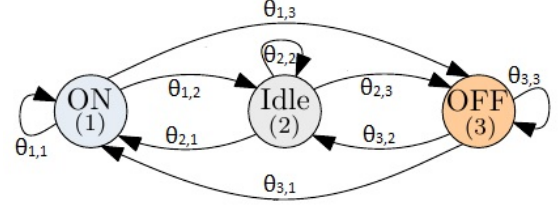

Fig. 2. Illustration of the transitions costs. Idle represents an intermediate mode between ON and OFF. The  $\theta_{i,j}$  represent the energy costs associated to the transition from mode  $i$  to mode  $j$  and  $\theta_{i,i}$  the cost to stay in mode  $i$ .

The state of the radio chip is the mode at time  $t$ ,  $v_t$ :

$$v_t \in \mathbb{M} := \left\{ \underbrace{1}_{\text{ON}}, \underbrace{2, \dots, N}_{\text{intermediate}}, \underbrace{N}_{\text{OFF}} \right\},$$

and we define  $\mathbb{M}^* := \{2, 3, \dots, N\}$ .

The consumption of the radio chip at each sampling time depends on the previous radio-mode  $v_{t-1}$  and on the switching decision  $v_t$ . The amount of energy  $E$  consumed since the commissioning (where  $E_0 = 0$ ) can be computed as follows:

$$E_{t+1} = E_t + \theta_{v_t, v_{t+1}}.$$

4) *Sensor model*: The sensor node embeds a switching policy  $\eta$  (whose design is the goal of this paper) to assign the radio-mode. The decision to switch between modes is based on the actual plant output  $z_t$ , the last control input  $u_{t-1}$ , the previous mode  $v_{t-1}$  and the time  $t$ : the switching decision is  $v_t = \eta(z_t, u_{t-1}, v_{t-1}, t)$ .

Note that the sensor node must have access to the last control input. One way to achieve this, as depicted in Fig. 1, is to embed in the sensor node the control law, which will then be sent to controller (if we have indeed decided to send the information).

## B. Switched system formulation and optimisation problem

We formulate the evolution of the plant under the different choices of radio-modes as a switched linear system, with as many systems as the number of modes  $N$ . The evolution of the switched system depends on  $z_t$ , the state of the plant, on  $u_{t-1}$ , the last applied control input, and on  $v_{t-1}$  the previous mode of the radio chip. We define  $\zeta_t$  as the plant state augmented with the control memory:  $\zeta_t = \begin{bmatrix} z_t \\ u_{t-1} \end{bmatrix} \in \mathbb{R}^{n+p}$ . The state of the switched system is then  $(\zeta_t, v_{t-1}, t) \in \mathbb{R}^{n+p} \times \mathbb{M} \times \mathbb{N}$ .

The evolution of the plant given in Eq. (1) and the control law described in Eq. (2), together with the radio-mode update law  $\eta$ , give rise to the following switched system:

$$\begin{aligned} \zeta_{t+1} &= f_{v_t}(\zeta_t) \\ v_t &= \eta(\zeta_t, v_{t-1}, t), \end{aligned} \quad (3)$$

where the function  $f_v$  is defined as:

$$f_{v_t}(\underline{\zeta}_t) = \begin{cases} \phi_{\underline{\zeta}_t} = \begin{bmatrix} A - BK & 0 \\ -K & 0 \end{bmatrix} \underline{\zeta}_t & \text{if } v_t = 1 \\ \phi'_{\underline{\zeta}_t} = \begin{bmatrix} A & B \\ 0 & I \end{bmatrix} \underline{\zeta}_t & \text{if } v_t \neq 1 \end{cases} \quad (4)$$

Our goal is to find a suitable switching policy  $\eta$ , in order to obtain a good trade-off between the control performance and the energy consumption. To this aim, we define an optimisation problem: Find a policy  $\eta^*(\underline{\zeta}, v, t)$  such that

$$J(\underline{\zeta}_t, v_t, t, \eta^*) = \min_{\eta} J(\underline{\zeta}_t, v_t, t, \eta).$$

where the cost function  $J$  takes into account these two criteria:

$$J(\underline{\zeta}_t, v_t, t, \eta) = \underline{u}_\tau^T \bar{R} \underline{u}_\tau + \sum_{k=t}^{\tau} \ell(\underline{\zeta}_k) + \theta_{v_{k-1}, v_k} \quad (5)$$

where  $v_k = \eta(\underline{\zeta}, v_{t-1}, t)$  and  $\underline{\zeta}_{t+1} = f_{v_t}(\underline{\zeta}_t)$ . Here  $\ell(\underline{\zeta}_t)$  is the cost-to-go, designed as follows:

$$\ell(\underline{\zeta}_t) = \underbrace{\underline{z}_t^T \bar{Q} \underline{z}_t}_{\text{performance}} + \underbrace{\underline{u}_{t-1}^T \bar{R} \underline{u}_{t-1}}_{\text{control energy}} \quad (6)$$

for some symmetric, positive definite matrices  $\bar{Q}$  and  $\bar{R}$ . The optimisation problem is summarised as follows.

**Problem.**

Find a policy  $\eta^*(\underline{\zeta}, v, t)$  such that

$$J(\underline{\zeta}_t, v_t, t, \eta^*) = \min_{\eta} J(\underline{\zeta}_t, v_t, t, \eta).$$

The cost is defined as

$$J(\underline{\zeta}_t, v_t, t, \eta^*) = \underline{u}_\tau^T \bar{R} \underline{u}_\tau + \sum_{k=t}^{\tau} \ell(\underline{\zeta}_k) + \theta_{v_{k-1}, v_k}$$

where  $v_k = \eta(\underline{\zeta}_t, v_t, t)$ ,  $\underline{\zeta}_{t+1} = f_{v_t}(\underline{\zeta}_t)$  as defined in Eq.s (3), (4) and  $\ell(\underline{\zeta}_t)$  is the cost-to-go described by Eq.s (5), (6)

*Remarks:*

- Choosing the switching policy at time  $t$  is equivalent to choosing the radio-mode.
- We are interested in solving this problem under the following assumptions: the plant described by Eq. (1) is not stable, with some of the eigenvalues of  $A$  greater or equal to 1; the initial state is not zero,  $\underline{z}_0 \neq \mathbf{0}$ ; the matrix  $A - BK$  is not nilpotent; and transmissions have a non-zero cost whatever the previous mode, *i.e.*,  $\theta_{i1} > 0 \forall i$ .
- $\bar{Q}$  and  $\bar{R}$  are design parameters. The cost function weights  $\bar{Q}$  and  $\bar{R}$  can be tuned to give different trade-offs between control performance and energy consumption; it is natural to take them to be a scalar value times the identity matrix.

### III. SOLUTION OF THE OPTIMISATION PROBLEM BY DYNAMIC PROGRAMMING

#### A. Standard grid algorithm

The optimisation problem described in section II can be solved by dynamic programming which is based on Belman's principle of optimality. This principle tells us that

$$J(\underline{\zeta}, v, t) = \min_{w \in \mathbb{M}} \{J(f_w(\underline{\zeta}), w, t+1) + \theta_{v,w} + \ell(\underline{\zeta})\} \quad (7)$$

and that

$$\eta^*(\underline{\zeta}, v, t) = \arg \min_{w \in \mathbb{M}} \{J(f_w(\underline{\zeta}), w, t+1) + \theta_{v,w} + \ell(\underline{\zeta})\} \quad (8)$$

We will solve the problem by applying this several times using induction while approximating each point to a point on a grid.

We have chosen our grid to be centred and focused around the origin: it is the set of points  $\{\underline{\zeta} : \forall i \in \{1, 2, \dots, n + p\}, ((abs(\zeta_i / gridsize_i))^{1/\alpha_i} sign(\zeta_i) \in \{-1, (3 - gridnumber_i)/(1 - gridnumber_i), (5 - gridnumber_i)/(1 - gridnumber_i), \dots, 1\}\}$  where  $gridsize$  is the vector denoting the size of the grid in each direction and  $gridnumber$  is vector denoting the number of points in each direction.  $\alpha_i$  is a vector which denotes how focused the grid is around the origin in each direction

We note that for  $t = \tau + 1$ , we have  $J(\underline{\zeta}, v, \tau + 1) = \underline{u}_\tau^T \bar{R} \underline{u}_\tau$ .

For  $t \in \{1, 2, \dots, \tau\}$ , what we do, is for our time  $t$  starting at the end ( $t = \tau$ ) going backwards one step at a time until  $t = 1$ , for every position  $\underline{\zeta}$  on the grid, we calculate where we can go at each step  $f_1(\underline{\zeta}), f_2(\underline{\zeta}), \dots, f_m(\underline{\zeta})$ , followed by an approximation of all these points to points on the grid. We then get an approximation to  $J(f_w(\underline{\zeta}), w, t+1)$  for all  $w$  on  $\mathbb{M}$ <sup>1</sup>. If there were points on the grid, we can then find  $J(\underline{\zeta}, v, t) = \min_{w \in \mathbb{M}} \{J(f_w(\underline{\zeta}), w, t+1) + \theta_{v,w} + \ell(\underline{\zeta})\}$

We continue in this manner by induction until we have found every point on the grid for every (positive) timestep under our maximum time  $\tau$ .

Online or offline (depending on how fast you need things) we can do exactly the same thing except that we are finding  $\eta(\underline{\zeta}, v, t)$  instead of  $J(\underline{\zeta}, v, t)$  so we simply replace the min with argmin:  $\eta^*(\underline{\zeta}, v, t) = \arg \min_{w \in \mathbb{M}} \{J(f_w(\underline{\zeta}), w, t+1) + \theta_{v,w} + \ell(\underline{\zeta})\}$ . If all points we can go to turn out to be outside

<sup>1</sup>if we find we are going to a value outside our grid we will ignore it as we are supposing that the grid is large enough that going outside means the cost will be far larger than the minimum cost. If all values are outside the grid, we will note  $J(\underline{\zeta}, v, t) = \infty$  to indicate that any moves which lead to this position will have to eventually lead to a point outside the grid, and are hence not minimal

the grid, we will turn the radio ON to try and get back inside the grid. <sup>2</sup>

### B. The 'jumping' algorithm

We propose an alternative method of solving this problem, which also uses dynamic programming. Note that this algorithm does require a couple of conditions on  $\theta$  to work but both are reasonable. It relies on the following observation: if we do not pass by the mode ON in a certain interval of time of length  $k$ , then the cost only depends on the modes we pass by:  $v_1, v_2, \dots, v_{k-1}$ . Indeed, if we do not pass by ON, then  $\zeta_{i+1} = f_2(\zeta_i) = f_3(\zeta_i) = \dots = f_m(\zeta_i)$ . Hence  $\arg \min_{v \in \mathbb{M}^{*k-1}} \{ \sum_{i=1}^k \ell(\zeta_i) + \theta_{v_{i-1}, v_i} \} = \arg \min_{v \in \mathbb{M}^{*k-1}} \{ \sum_{i=1}^k \theta_{v_{i-1}, v_i} \}$

Hence we propose to find for all  $k$  and  $v_0$ , the minimum of  $\sum_{i=1}^k \{ \theta_{v_{i-1}, v_i} \}$  whilst never having  $v_i = 1$ , and also the corresponding first move. There are  $N$  possibilities for  $v_0$  so this is fine; however, we have lots of possibilities for  $k$  so we will require the following lemma to limit them:

#### Lemma 1 .

Assume:

- a) cycles of more than one non-transmitting state do not help reduce costs [ formally,  $\theta_{v_1, v_2} + \theta_{v_2, v_3} + \theta_{v_3, v_4} + \dots + \theta_{v_i, v_1} \geq i * \min_{j \leq i} \{ \theta_{v_j, v_j} \}$  ]
- b) WLOG assume  $\theta_{N, N} = \min_k \{ \theta_{k, k} \}$  [OFF Mode]. Then for all  $k \neq 1$ ,  $2 * \theta_{k, k} \geq \theta_{N, k} + \theta_{k, N}$  .

Then if everything works perfectly (IE: no noise or imprecisions), starting from  $v = 1$ , we will either pass by  $v = 1$  again in the next  $2N - 3$  steps, or we can pass by  $v = N$  at step  $N - 1$  while still being minimal.

Proof:

Suppose for a contradiction that we do not pass by  $v = 1$  or by  $v = N$  during steps 1 to  $2N - 3$ . Then we have  $2N - 3$  steps and  $N - 2$  modes so by the pigeon hole principle, there is a mode we pass by 3 times. Call it  $k$ . Also call  $u = \arg \min \{ \theta_{i, i} : \text{we pass by mode } i \}$  .

Then consider the two sequences of modes (possibly empty) that lie between the three times we pass by mode  $k$  ( there are possibly more than two such sequences but we only need two). If neither or both of them contain  $u$ , pick one at random. Otherwise, pick the one not containing  $u$ . The contribution from the sequence is (with  $v_1 = k$ ):  $\theta_{v_1, v_2} + \theta_{v_2, v_3} + \theta_{v_3, v_4} + \dots + \theta_{v_i, v_1} \geq i * \min_{j \leq i} \{ \theta_{v_j, v_j} \} \geq i * \theta_{u, u}$

Hence we can delete this sequence (the start and finish are the same so everything else is unchanged) and add in an alternative sequence made of  $i$  'u's in a row at the position

<sup>2</sup>If done offline this move will again be calculated for all  $\zeta$  on the grid; otherwise it will be calculated for the  $\zeta$  we have currently

where  $u$  already is.

$i \geq 1$  so we thus have at least 2 modes 'u's in a row. Repeat this once more, and we get 3 modes 'u's in a row Then  $\theta_{u, u} + \theta_{u, u} \geq \theta_{u, N} + \theta_{N, u}$  so we can replace the  $u$  in the middle by mode  $N$ . Hence we can pass by mode  $N$  as required.

Now we will prove that we can pass by mode  $N$  at step  $N - 1$ . Suppose for a contradiction that we do not pass by mode  $N$  at step  $N - 1$ , but we pass at step  $k > N - 1$  [we must pass at some point by what we just proved]. If we also pass before  $N - 1$ , then the sequence between the two costs (with  $v_1 = N$ ):  $\theta_{v_1, v_2} + \theta_{v_2, v_3} + \theta_{v_3, v_4} + \dots + \theta_{v_i, v_1} \geq i * \min_{j \leq i} \{ \theta_{v_j, v_j} \} \geq i * \theta_{N, N}$  so we can suppose the sequence stays constant at mode  $m$  and thus we pass by mode  $N$  at step  $N - 1$ .

Otherwise, if we do not pass by mode  $N$  before the point  $k$ , then the sequence going from 1 to  $N$  has at most  $N - 2$  modes in at least  $N - 1$  steps so by the pigeon hole principle, there is a mode we go to twice. Applying the same method as above, we can add a sequence of 'N's at the end, so we can replace  $k$  by something smaller:  $k' < k$ . Also there will be a sequence at 'N's in between  $k$  and  $k'$ . Continue by induction until  $k' < N$ . Then we do go to mode  $N$  at step  $N - 1$ .

If we turn OFF at a step earlier than  $N - 1$ , then it is more than  $N - 1$  steps before the end [since the end takes at least  $2N - 2$  steps to reach] so by the same method reflected, we also have that we turn OFF at step  $N - 1$ .

Hence, starting from mode ON, we will either pass by mode ON again in the next  $2N - 3$  steps, or we can pass by mode OFF at step  $N - 1$  while still being minimal. ■

Note: we will also pass by mode  $N$   $N - 1$  steps before the end by a similar proof, and in between these two points, the sequence will be constant at mode  $N$ .

: If for all  $i, j$ ,  $\max \{ \theta_{i, i}, \theta_{i, i} \} \geq \theta_{i, j} \geq \min \{ \theta_{i, i}, \theta_{i, i} \}$ , then conditions a) and b) hold so the lemma holds. Proof:

- a)  $\theta_{v_1, v_2} + \theta_{v_2, v_3} + \theta_{v_3, v_4} + \dots + \theta_{v_i, v_1} \geq \min \{ \theta_{v_1, v_1}, \theta_{v_2, v_2} \} + \min \{ \theta_{v_2, v_2}, \theta_{v_3, v_3} \} + \min \{ \theta_{v_3, v_3}, \theta_{v_4, v_4} \} + \dots + \min \{ \theta_{v_i, v_i}, \theta_{v_1, v_1} \} \geq i * \min_{j \leq i} \{ \theta_{v_j, v_j} \}$
- b)  $\theta_{k, k} \geq \theta_{k, N} \geq \theta_{N, N}$  since  $\theta_{k, k} \geq \theta_{N, N}$  . Similarly,  $\theta_{k, k} \geq \theta_{N, k} \geq \theta_{N, N}$ . Hence  $2 * \theta_{k, k} \geq \theta_{N, k} + \theta_{k, N}$ . ■

Also note that if  $\theta_{N, N} \neq 0$ , if we replace  $\theta_{i, j}$  with  $\theta_{i, j} - \theta_{N, N}$ , we will have changed the cost at each step by  $\theta_{N, N}$  so the total cost at the end will be modified by  $T * \theta_{N, N}$ . This is independent of our choices for  $\eta$  so this does not change  $\eta^*$  so this is allowed.

## 2) Computation

This method is quite similar to the first. An obvious change is that with this algorithm, we will only have to store values of  $J(\underline{\zeta}, 1, t)$  and  $J(\underline{\zeta}, N, t)$  instead of  $J(\underline{\zeta}, v, t)$  for all  $v$ .

First, we calculate for all  $v_0 \in \mathbb{M}$  and for all  $k \in \{1, \dots, 2N - 2\}$  the minimum cost of going from the mode  $v_0$  to the mode ON in exactly  $k$  steps, and the corresponding first move. Since we cannot have any influence on  $\underline{\zeta}$  by choosing these  $v_i$ , we can ignore  $\underline{\zeta}$ . We do so by simple dynamic programming similar to part A:

For  $k = 1$ ,  $\text{mincost}(v, 1) = \theta_{v,1}$  since we must go directly to the mode ON. Also,  $\text{minmove}(v, 1) = 1$  since we decided we would turn ON.

For  $k$  going from 2 to  $2N - 2$ , for all  $v$ , we know that  $\text{mincost}(v, k) = \min_{w \in \mathbb{M}^*} \{\text{mincost}(w, k - 1) + \theta_{v,w}\}$ . Hence we can calculate this and find  $\text{mincost}$  everywhere we are interested in.  $\text{minmove}(v, k) = \arg \min_{w \in \mathbb{M}^*} \{\text{mincost}(w, k - 1) + \theta_{v,w}\}$ .

If  $k$  is smaller than  $N - 1$ , we also calculate the minimal cost and corresponding first move for going to the end in exactly  $k$  moves starting from mode  $v_0$ ; this is exactly the same computation except that the same method except that the start is at  $k = 0$ , and it is  $\text{mincostend}(v, 0) = 0$ ;  $\text{minmoveend}$  is not important at  $k = 0$  and is hence ignored at this stage.

Now we have the following equation for  $t$  far enough from the end:

$$J(\underline{\zeta}, v, t) = \min_k \{ J(\phi * (\phi')^{k-1} * \underline{\zeta}, 1, t - k) + \sum_{i=0}^{k-1} \ell((\phi')^i * \underline{\zeta}) + \text{mincost}(v, k) \} \quad (9)$$

We now note that if  $k \geq 2N - 2$ , then by our lemma, we will pass by mode OFF after  $N - 1$  moves. By Belman's principle of optimality, the cost of going from ON to OFF in  $N - 1$  moves [ignoring  $\underline{\zeta}$ ] is thus  $\text{mincost}(1, 2N - 2) - \text{mincost}(N, N - 1)$ .

Hence  $\min_{k \geq 2N - 2} \{ J(\phi * (\phi')^{k-1} * \underline{\zeta}, 1, t - k) + \sum_{i=0}^{k-1} \ell((\phi')^i * \underline{\zeta}) + \text{mincost}(v, k) \} = J((\phi')^{k-1}, m, t - N + 1) + \sum_{i=0}^{N-2} \ell((\phi')^i * \underline{\zeta}) + \text{mincost}(1, 2N - 2) - \text{mincost}(N, N - 1)$  and  $\eta(\underline{\zeta}, v, t)$  will be  $\text{minmove}(v, 2N - 2)$  if the minimum does indeed have  $k \geq 2N - 2$ .

Therefore, we need only compare values of  $k$  between 1 and  $2N - 3$ , and then to compare with any  $k$  larger, we simply use the value of  $J((\phi')^{N-1} * \underline{\zeta}, N, t - N + 1)$ . Hence we can find both the minimum cost and the corresponding

move when far away from the end.

$$J(\underline{\zeta}, v, t) = \min_{k \leq 2N - 3} \{ J(\phi * (\phi')^{k-1} * \underline{\zeta}, 1, t - k) + \sum_{i=0}^{k-1} \ell((\phi')^i * \underline{\zeta}) + \text{mincost}(v, k), \\ J((\phi')^{N-1}, N, t - N + 1) + \sum_{i=0}^{N-2} \ell((\phi')^i * \underline{\zeta}) + \text{mincost}(1, 2N - 2) - \text{mincost}(N, N - 1) \} \quad (10)$$

If we are close to the end (ie: within  $2N - 3$ ), then things go slightly differently: as well as comparing the values of  $k$  going from 1 to  $\tau - t$ , we must also consider the possibility of not going to the end without passing by ON. We see that the minimum cost of this is  $J((\phi')^{\tau-t} * \underline{\zeta}, N, \tau) + \sum_{i=0}^{\tau-t-1} \ell((\phi')^i * \underline{\zeta}) + \text{mincostend}(v, \tau - t)$ <sup>3</sup> The corresponding move is  $\text{minmoveend}(v, \tau - t)$ . We can then compare this to the values we already have and pick it if it is smaller.

$$J(\underline{\zeta}, v, t) = \min_{k \leq \tau - t} \{ J(\phi * (\phi')^{k-1} \underline{\zeta}, 1, t - k) + \sum_{i=0}^{k-1} \ell((\phi')^i \underline{\zeta}) + \text{mincost}(v, k), \\ J((\phi')^{\tau-t} \underline{\zeta}, N, \tau) + \sum_{i=0}^{\tau-t-1} \ell((\phi')^i \underline{\zeta}) + \text{mincostend}(v, \tau - t) \} \quad (11)$$

Note: if  $\tau - t \geq 2N - 3$ , then we will either pass by ON or by OFF in the intervening time by our lemma.

The finished algorithm goes like this:

- First of all, set  $J(\underline{\zeta}_{\tau+1}, 1, \tau + 1) = J(\underline{\zeta}_{\tau+1}, N, \tau + 1) = u_{\tau}^T \bar{R} u_{\tau}$
- For  $t$  going from  $\tau$  to 1, for all  $\underline{\zeta}$ , we can find  $J(\underline{\zeta}, 1, t)$  and  $J(\underline{\zeta}, N, t)$  by doing a minimisation on number of possibilities smaller than  $2N - 2$ , using solely values of  $J(\underline{\zeta}', 1, t + k)$  and  $J(\underline{\zeta}', N, t + k)$ . Hence by induction, we can find the cost for all  $\underline{\zeta}, t$  of  $J(\underline{\zeta}, 1, t)$  and  $J(\underline{\zeta}, N, t)$ .
- When online, for any position mode and time, you can do a similar minimisation using  $J(\underline{\zeta}', 1, t + k)$  and  $J(\underline{\zeta}', N, t + k)$ , except that you output the mode required to do so instead of the cost.

Notes:

- as in the first algorithm, we use a grid to approximate points whenever we want to check the value of  $J(\underline{\zeta}, v, t)$ . Whenever we are heading outside the grid, the cost will be marked as  $\infty$  so as to try and prevent this from happening, as in the first algorithm.
- Although  $\sum_{i=0}^{k-1} \ell((\phi')^i * \underline{\zeta})$  seems like it will take a long time to calculate, this can be sped up considerably

<sup>3</sup>the  $N$  can in fact be replaced by any mode since the cost at time  $T$  is independent of the previous mode.  $N$  was chosen arbitrarily

by keeping the previous values of  $\sum_{i=0}^{k-2} \{\ell((\phi')^i * \zeta)\}$  and  $(\phi')^{k-2} * \zeta$  in memory (we calculated them the previous step).

#### IV. SIMULATION RESULTS

##### A. the plant

We will test our optimal mode management on an inverted pendulum on a track. We aim to keep the pendulum upright or near upright for a given length of time. We can act on the system by exerting a force on the bottom of the pendulum which goes along the tracks. The variables are thus:  $x$  the position of the bottom of the pendulum,  $\rho$  the angle of the pendulum,  $\dot{x}$  the velocity of the bottom of the pendulum, and  $\dot{\rho}$ , the derivative of the angle with respect to time. Our control,  $u$ , is the force we exert on the bottom of the pendulum. We take  $g = 9.81m.s^{-1}$ , the mass of the base of the pendulum to be  $2kg$ , the mass at the end of the pendulum to be  $0.1kg$  and the length of the pendulum to be  $0.5m$ .

About the equilibrium point, we have thus  $\underline{z} = [x; \rho; \dot{x}; \dot{\rho}]$  and

$$\dot{\underline{z}} = \begin{pmatrix} 0 & 0 & 1 & 0 \\ 0 & 0 & 0 & 1 \\ 0 & -0.49 & 0 & 0 \\ 0 & 21 & 0 & 0 \end{pmatrix} \underline{z} + \begin{pmatrix} 0 \\ 0 \\ 0.5 \\ -1 \end{pmatrix} u$$

By discretising this equation, we get:

$$\underline{z}_{t+\delta} = (I + \delta \bar{A}) \underline{z}_t + \delta \bar{B} u_t$$

where  $\bar{A}$  and  $\bar{B}$  are the matrices above, and  $\delta$  is a small time. Hence  $A = (I + \delta \bar{A})$  and  $B = \delta \bar{B}$ .

The radio we will use has  $N = 3$  main modes and the following transition costs:

$$\theta = \begin{pmatrix} 897 & 97.75 & \infty \\ 110 & 96 & 0.024 \\ \infty & 98.97 & 0.024 \end{pmatrix}$$

with  $\infty$  meaning the transition is impossible. The time  $\delta$  will be  $20ms$

Our cost functions will be chosen to be  $\bar{R} = 5$  and

$$\bar{Q} = \begin{pmatrix} 0 & 0 & 0 & 0 \\ 0 & 1000 & 0 & 0 \\ 0 & 0 & 1 & 0 \\ 0 & 0 & 0 & 0 \end{pmatrix}$$

##### B. Comparison of both algorithms

We set  $gridnumber = [2; 31; 5; 31; 31]$  and  $gridsize = [10000; 4; 50; 20; 1000]$  so as to ignore position, and get more accurate readings on the others. The simulation runs for 5 seconds, and starts at  $\zeta = [0; 1; 0; 0; 0]$ ,  $v = 2$  (IDLE). Also, we set  $\alpha = [2; 2; 2; 2; 2]$ .

The offline calculation took about 4800 seconds for the normal algorithm, but only 1900 for the 'jumping' algorithm. The online results for the normal algorithm were:

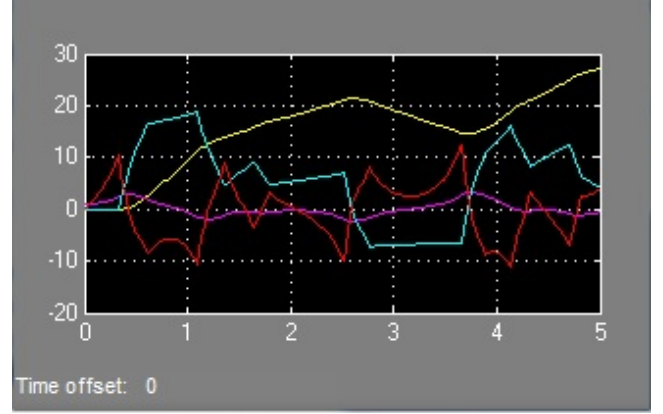

Fig. 3. State of the system; yellow is position of the base, blue is velocity of the base, pink is angle and red is the angle's derivative.

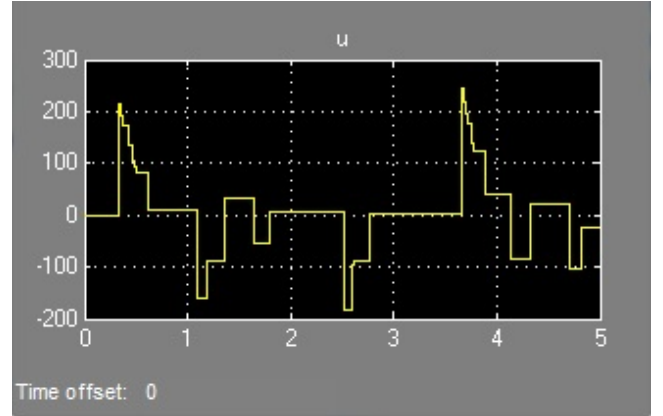

Fig. 4. The force on the base of the pendulum

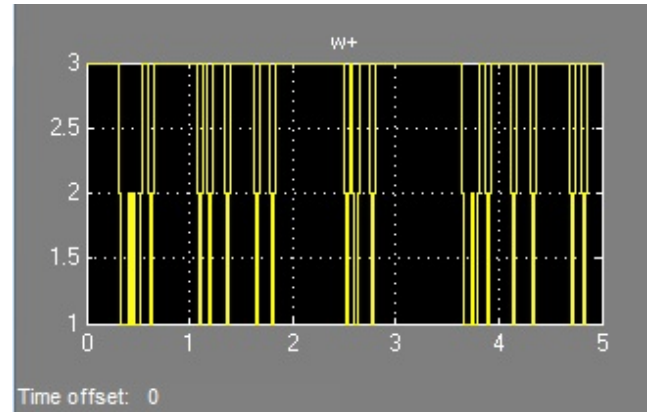

Fig. 5. Which mode the radio is in

This achieved a total cost of 13608 at the end. The online results for the 'jumping' algorithm were:

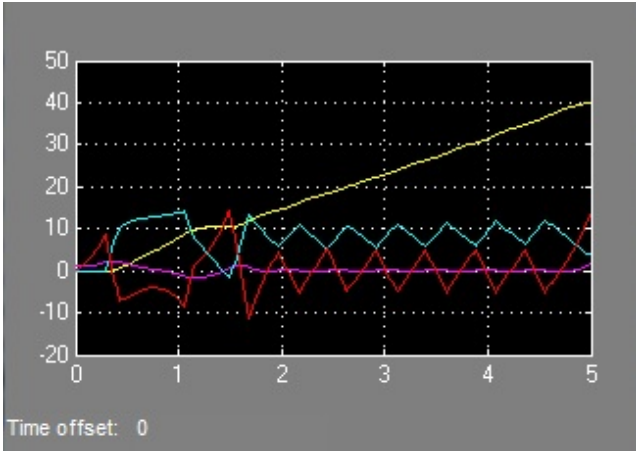

Fig. 6. State of the system; yellow is position of the base, blue is velocity of the base, pink is angle and red is the angle's derivative.

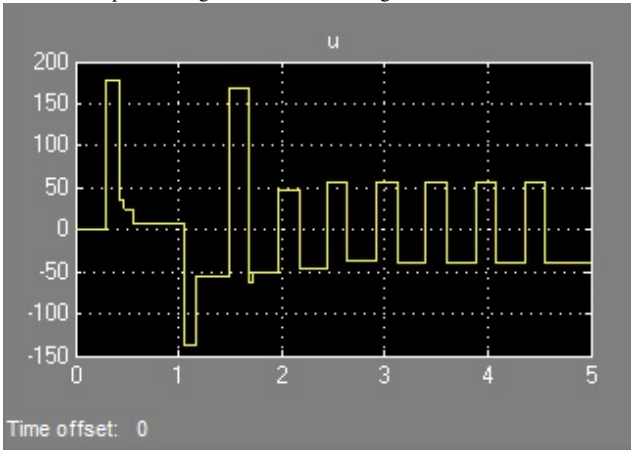

Fig. 7. The force on the base of the pendulum

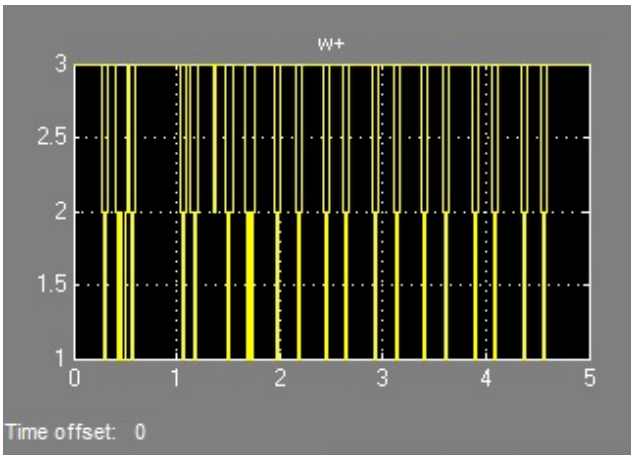

Fig. 8. Which mode the radio is in

This achieved a total cost of 10742 at the end. This is 80 % of the cost the normal algorithm got, and furthermore it got it 2.5 times faster. If we compare the two, we should theoretically get a time difference of  $O(N)$  in favour of the jumping algorithm, so with more than 3 modes, the jumping algorithm will get even better compared to the normal algorithm. We can also see that in both cases,

the radio spends most of its time in OFF mode, only turning ON to do minor adjustments (going via IDLE mode each time). If it needs to be ON for a longer time, it tends to oscillate between IDLE and ON instead (since it is indeed far cheaper). In both cases, the angle is stable near 0 for most of the duration, although at the end the radio switches itself OFF until the end, while the angle starts moving away from equilibrium.

### C. Resistance to data loss

Note: for the rest of this paper, we will be using the 'jumping algorithm' since it appears to be better. We introduce a probability of 30 % that the data sent to the controller will get lost along the way. The results we get are:

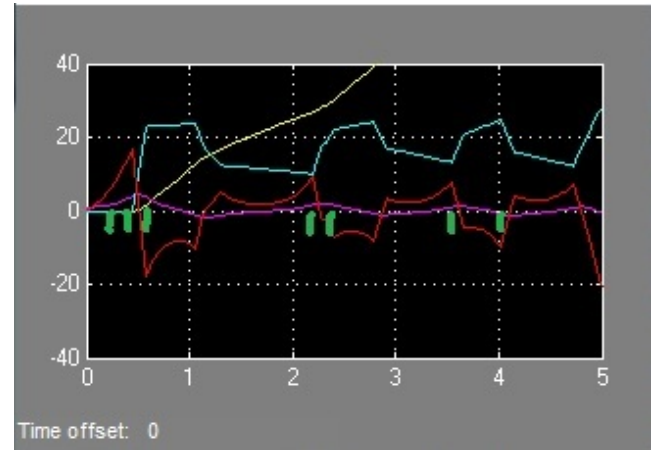

Fig. 9. state of the system; same colours as before; green indicates data loss

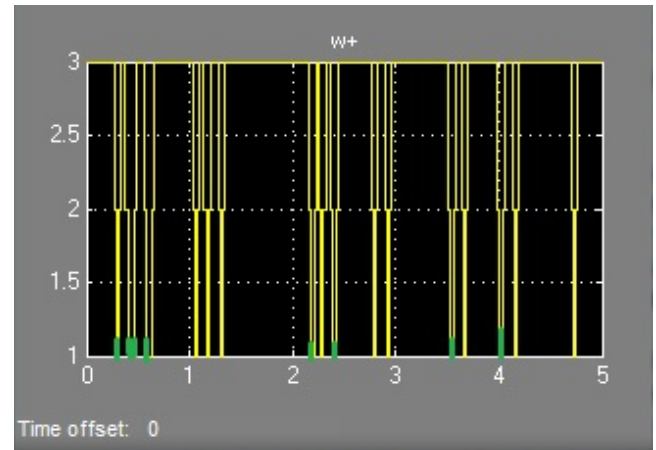

Fig. 10. Which mode the radio is in; green means failure to send

We can see that even with data loss, the pendulum remains near 0. After suffering data loss, the radio usually either stays in ON or switches rapidly to IDLE before going back ON (to not use up the large amount of energy required to stay ON).



#### D. Resistance to noise

We introduce some independent Gaussian noise, which for each variable, has variance 1 tenth of the maximum that that variable reaches. The results we get are:

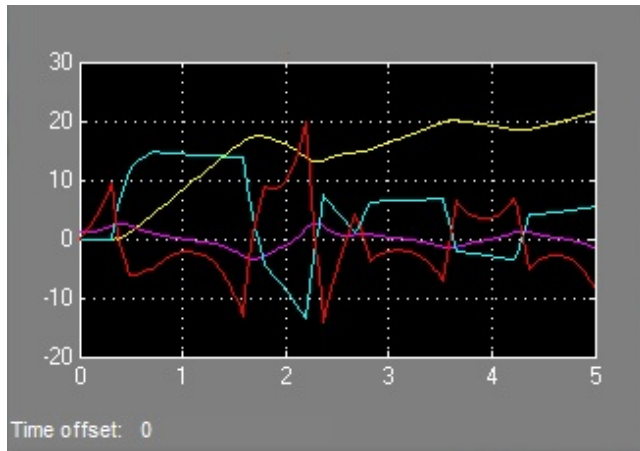

Fig. 11. state of the system; same colours as before

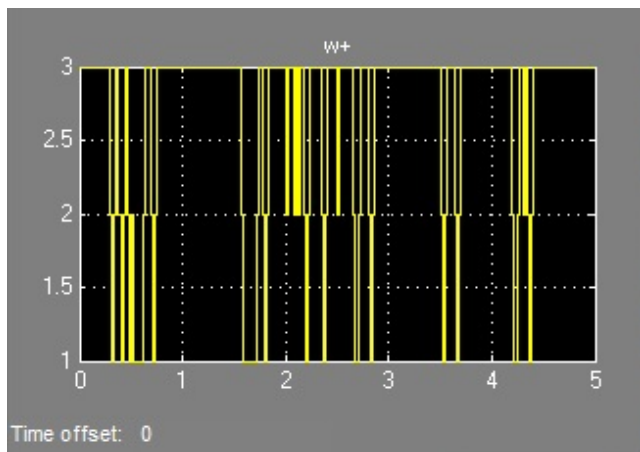

Fig. 12. Which mode the radio is in

We can see that the output remains near 0 and the controller still spends quite a bit of time in OFF mode. It occasionally makes the mistake of going to IDLE and then OFF again, presumably because it was mistaken as to the state of the pendulum.

#### V. CONCLUSION AND POSSIBLE FUTURE WORK

In this paper, we have studied the optimal management of the radio-chip mode of wireless sensor in a network control problem. Indeed, a rich literature from the communications community indicates that, in order to reduce the energy consumption, it is essential to wisely choose the mode of the radio chip between ON, OFF and some intermediate modes. The novelty of this paper is that we consider the case of a finite horizon rather than an infinite one. We have considered a simple application of this with the inverted pendulum, with

a single sensor whose transmissions to the controller have to be performed with an optimal choice of radio mode. For this problem, we have defined a suitable cost function, which describes the trade off between the control performance and the energy consumption, and whose minimum can be computed using dynamic programming. Although we don't have proof that it is stable with data loss or with noise, in the simulations done it was quite robust.

We have considered two ways of implementing this: one by directly applying the rules of dynamic programming, the other (the 'jumping algorithm') does similarly but manages to skip a few steps at a time instead of 1 step at a time. We have tested both these algorithms on a real life example (the inverted pendulum) and found that the 'jumping' algorithm is far superior, both in terms of results, and in terms of computing time needed.

This work is the first step in the direction of understanding the advantages of radio-mode management in more general networked control problems. A natural extension of this work is to consider an optimisation that involves not only the radio mode, but also the feedback control law for those times where the sensor is transmitting.

A much more challenging goal will be the extension to sensors/controllers networks with more than two nodes. The general scenario is of great interest for applications, but requires a whole new theory to be developed: on the one hand, even with only two radio-modes there isn't yet a clear notion of optimal event based sampling for a distributed multi-sensor multi-controller network; on the other hand, the coordination of multiple sensors might require them to be on an active ON mode also with the purpose of receiving messages in addition to sending them, and this should also be taken into account when computing the energy consumption, thus complicating the picture.

#### REFERENCES

- [1] M.I. Brownfield, A.S. Fayed, T.M. Nelson, and N. Davis. Cross-layer wireless sensor network radio power management. In *IEEE Wireless Communications and Networking Conference, WCNC'06*, volume 2, pages 1160–1165, April 2006.
- [2] Nicolas Cardoso de Castro, Carlos Canudas de Wit, and Federica Garin. Energy-aware wireless networked control using radio-mode management. In *Under revision, submitted to ACC'12*, 2012.
- [3] Nicolas Cardoso de Castro, Carlos Canudas de Wit, and Karl Henrik Johansson. On energy-aware communication and control co-design in wireless network controlled systems. In *2nd IFAC Workshop on Estimation and Control of Networked Systems, NecSys'10*, Annecy France, 2010.
- [4] R. Cogill. Event-based control using quadratic approximate value functions. In *Proceedings of the 48th IEEE Conference on Decision and Control, CDC'09*, pages 5883–5888, 2009.
- [5] R. Cogill, S. Lall, and J.P. Hespanha. A constant factor approximation algorithm for event-based sampling. In *American Control Conference, 2007. ACC '07*, pages 305–311, 9-13 2007.
- [6] O.C. Imer and T. Basar. Optimal estimation with limited measurements. In *44th IEEE Conference on Decision and Control, 2005 and 2005 European Control Conference, CDC-ECC'05*, pages 1029–1034, 2005.
- [7] O.C. Imer and T. Basar. To measure or to control: optimal control with scheduled measurements and controls. In *American Control Conference, ACC'06*, 2006.
- [8] Xiangheng Liu and A. Goldsmith. Wireless network design for distributed control. In *43rd IEEE Conference on Decision and Control, CDC'04*, volume 3, pages 2823–2829, 2004.

- [9] A. Sinha and A. Chandrakasan. Dynamic power management in wireless sensor networks. *Design & Test of Computers, IEEE*, 18(2):62–74, Mar/Apr 2001.
- [10] B. Sinopoli, L. Schenato, M. Franceschetti, K. Poolla, M.I. Jordan, and S.S. Sastry. Kalman filtering with intermittent observations. *IEEE Transactions on Automatic Control*, 49(9):1453 – 1464, sept. 2004.
- [11] Yonggang Xu and J.P. Hespanha. Estimation under uncontrolled and controlled communications in networked control systems. In *44th IEEE Conference on Decision and Control, 2005 and 2005 European Control Conference. CDC-ECC '05*, pages 842 – 847, 2005.