



HAL
open science

Hardware-in-the-loop test-bed of an Unmanned Aerial Vehicle using Orccad

Daniel Simon

► **To cite this version:**

Daniel Simon. Hardware-in-the-loop test-bed of an Unmanned Aerial Vehicle using Orccad. CAR 2011 - 6th National Conference on Control Architectures of Robots, INRIA Grenoble Rhône-Alpes, May 2011, Grenoble, France. 14 p. inria-00599685

HAL Id: inria-00599685

<https://inria.hal.science/inria-00599685v1>

Submitted on 10 Jun 2011

HAL is a multi-disciplinary open access archive for the deposit and dissemination of scientific research documents, whether they are published or not. The documents may come from teaching and research institutions in France or abroad, or from public or private research centers.

L'archive ouverte pluridisciplinaire **HAL**, est destinée au dépôt et à la diffusion de documents scientifiques de niveau recherche, publiés ou non, émanant des établissements d'enseignement et de recherche français ou étrangers, des laboratoires publics ou privés.

Hardware-in-the-loop test-bed of an Unmanned Aerial Vehicle using Orccad

Daniel Simon
INRIA Rhône-Alpes
Inovallée, 655 avenue de l Europe, Montbonnot
38334 ST ISMIER Cedex, FRANCE
<http://orccad.gforge.inria.fr>

Abstract

During the development of control systems, hardware-in-the-loop (HIL) takes place between design level simulations and costly experiments with the real plant. In this particular experiment the controller is designed under Orccad, as a set of multi-rate tasks, allowing for testing weakly hard scheduling schemes. The controller is embedded on a microcontroller synchronized via a CAN bus to a mini-drone simulator. Observing the simulation traces helps to tune the control design, and avoid crashing down the real system in early testing.

1 From control design to real-time experiments

To develop effective and safe real-time control for complex applications (e.g. automotive, aerospace...), it is not enough to provide theoretic control laws and leave programmers and real-time systems engineers just do their best to implement the controllers. Complex systems are implemented using digital chips and processors, they are more and more distributed over networks, where sensors, actuators and processors are spread over a naturally asynchronous architecture. For efficiency reasons a given processor is often shared between several computing activities under control of a real-time operating system (RTOS). The control performance and robustness of such system can be very far from expected if implementation induced disturbances are not taken into account. However the detailed understanding of such complex hybrid systems is up-to-now out of the range of purely theoretic analysis.

Analyzing, prototyping, simulating and guaranteeing the safety of these systems are very challenging topics. Models are needed for the mechatronic continuous system, for the discrete controllers and diagnosers, and for network behavior. Real-time properties (task response times) and the network Quality of Service (QoS) influence the controlled system properties (Quality of Control, QoC).

Safety critical real-time systems must obey stringent constraints on resource usage such as memory, processing power and communication, which must all be verified during the design stage. A hard real-time approach is traditionally used because it guarantees that all timing constraints are verified. However, it generally results in oversizing the computing power and networking bandwidth, which is not always compatible with embedded applications. Thus a soft real-time approach is preferred, since it tolerates timing deviations such as occasionally missed deadlines. However, to keep confidence in the system safety, the interactions between the computing system and the control system must be carefully designed and observed whenever the soft real-time approach is used.

Understanding and modeling the influence of an implementation (support system) on the QoC (Quality of control) is a challenging objective in control/computing co-design. Mainly based on case studies several results exist, e.g. [7], to study the influence of an implementation on the performances of a control system. However real-life size problems, involving non-linear systems and uncertain components, still escape from a purely theoretic framework. Hence the design of an embedded real-time control application needs to be progressively developed along the use of several tools ranging from classic simulation up-to the implementation of run-time code on the target.

The approach is illustrated through the development of a quadrotor mini-drone which was used as a test-bed in the SafeNecs ANR project [5]. The main development phases (summarized in Figure 1) are :

Continuous time simulation A first step is the choice of a control structure, based on a model of the plant and on the control objective. The control toolbox now contains many tools to state and solve a large variety of control problems

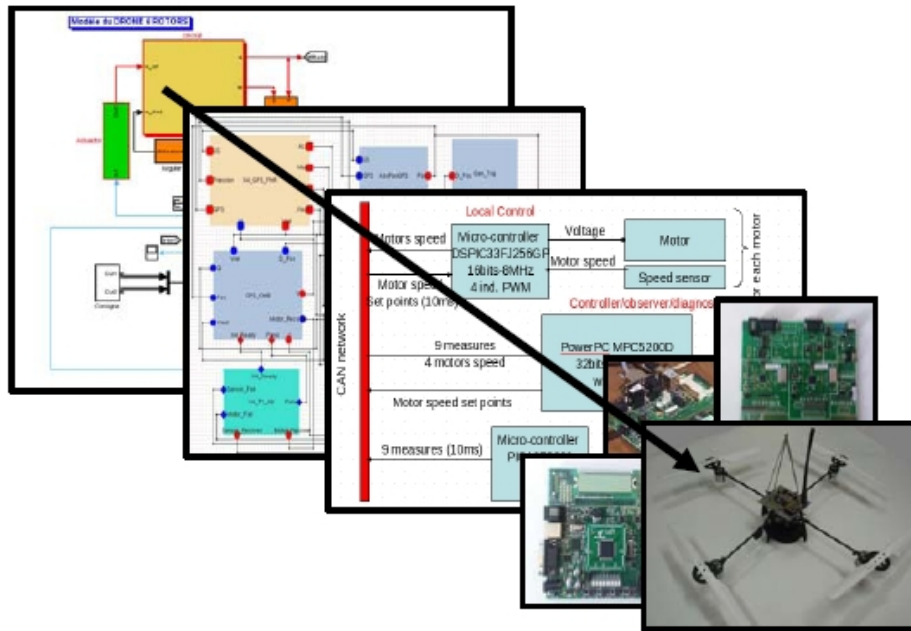

Figure 1: Design flow.

applied to various plants. Besides control theory, preliminary design and tests often rely on simulation tools such as Matlab/Simulink or Scilab/Scicos. Control design usually needs two different models of the plant. The control algorithm design is based on a simplified **control design model**, which goal is to capture the essential aspects of the plant dynamics and behavior. This abstraction must be simple enough to derive a closed-loop controller, e.g. it can be a linearized model of the plant leading to a LQ controller. Then the robustness of the design w.r.t. the realistic plant should be assessed via simulations handling a complete **simulation models** of the plant, including its known non-linearities together with a model of the uncertain parameters. The aforementioned simulation tools handle some modeling capabilities, e.g. the Matlab physical modeling toolbox. These models can also be generated from external tools and languages, e.g. Siconos and Modelica for models of mechanical systems and robotics.

These preliminary simulations are able to rough out the choice of the control algorithm and firstly evaluate its adequation with the plant structure and control objectives. They are often carried out in the framework of continuous time, as non-linear control is also often designed in continuous time. When done, the evaluation of digital control and discretization consequences is basic, e.g. modeled via a single numerical loop sampled at a fixed rate.

Simulation including the real-time architecture Further to these preliminary simulation, modeling and simulating the implementation platform, i.e. the real-time tasks and scheduler inside the control nodes, and the network between the nodes, allows for a new step towards the design and evaluation of the embedded system. Among others the TRUETIME free toolbox is a Matlab/Simulink-based simulator for real-time control systems [11]. TrueTime eases the co-simulation of controller task execution in real-time kernels, network transmissions, and continuous plant dynamics. With this toolbox the real-time operating systems and networks features are handled by high level abstractions, contrarily to other tools such as SimEvent, or as Opnet [12], which allows users to simulate the network in a more detailed (and costly) way. TRUETIME allows users to simulate several types of networks (Ethernet, CAN, Round Robin, TDMA, FDMA, Switched Ethernet and WLAN or ZigBee Wireless networks) and new models can be added.

Hardware-in-the-loop simulation Even with a specialized toolbox like TRUETIME, the previous step remains simulations still far from reality. In particular the models of the real-time components (RTOS and network) must be kept simple (high-level) to avoid prohibitive simulation times, and execution or transmission times are based on assumptions and worst cases analysis. Before experiments using the real system a useful next step is to implement

the so-called *hardware-in-the-loop* test-bench. In this case, the plant is still simulated (numerical integration of the non-linear plant model), but now the control algorithms and real-time software are executed on the embedded target as real-time tasks communicating through the real network.

Experiments Finally, once the real-time simulations made the designers confident enough in both the control algorithm and its implementation, experiments with the real plant controlled by the embedded hardware and software can begin while minimizing the risk of early failure. Experiments results can be further used to update the simulation models or even to come back on the choice or dimensioning of some of the system's components.

2 Hardware-in-the-loop setup

The utilization of Matlab/Simulink together with TRUETIME remains pure simulation. To provide more realistic results on the influence of the real-time tasks and network on the system, a hardware-in-the-loop experiment has been set up (Figure 2). In the particular case of the quadrotor, hardware-in-the-loop experiments provide a safe environment for the validation of all algorithms and software, prior to any experiments with a real - and very fragile - quadrotor (Figure 3).

2.1 Real hardware

The main goal of the quadrotor setup is to develop and evaluate control loops distributed over a networked control system. Therefore the control hardware is spread over several boards connected by a CAN bus :

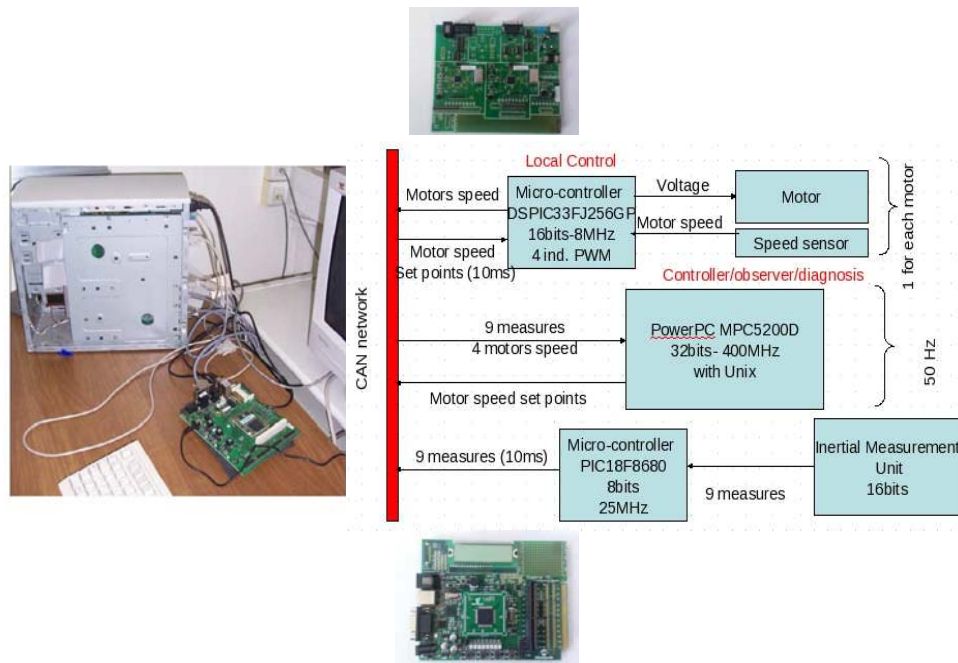

Figure 2: Real hardware.

Main control board The control, observation and diagnostic algorithms are implemented on a Phycore MPC5200B-tiny¹ embedded board running Linux on a Freescale MPC603e 400 MHz CPU. To ease the software debug and deployment the tiny board is plugged on a development board which can be connected to the host PC via a serial link, Ethernet and a CAN bus.

Motor control board The drone is equipped with 4 vertical screw propellers, each of them with a speed sensor. The DC motors can be independently controlled, the velocity control loops are implemented on a 16 bits/8MHz Microchip dsPIC. This board is connected via the CAN bus with the main board.

¹<http://www.phytec.com/>

Sensing board The drone's attitude components are measured thanks to an Inertial Measurement Unit (IMU). The IMU consists of three rate gyros (g_1, g_2, g_3), a tri-axis accelerometer (a_1, a_2, a_3), and a tri-axis magnetometer (m_1, m_2, m_3). The raw measurements are collected, filtered, packed in CAN messages and periodically sent to the main control board via the CAN bus by another dsPIC chip.

Host PC The host PC under Linux is used for off-line control software development, debug and downloading, and for post-experiments data post-processing.

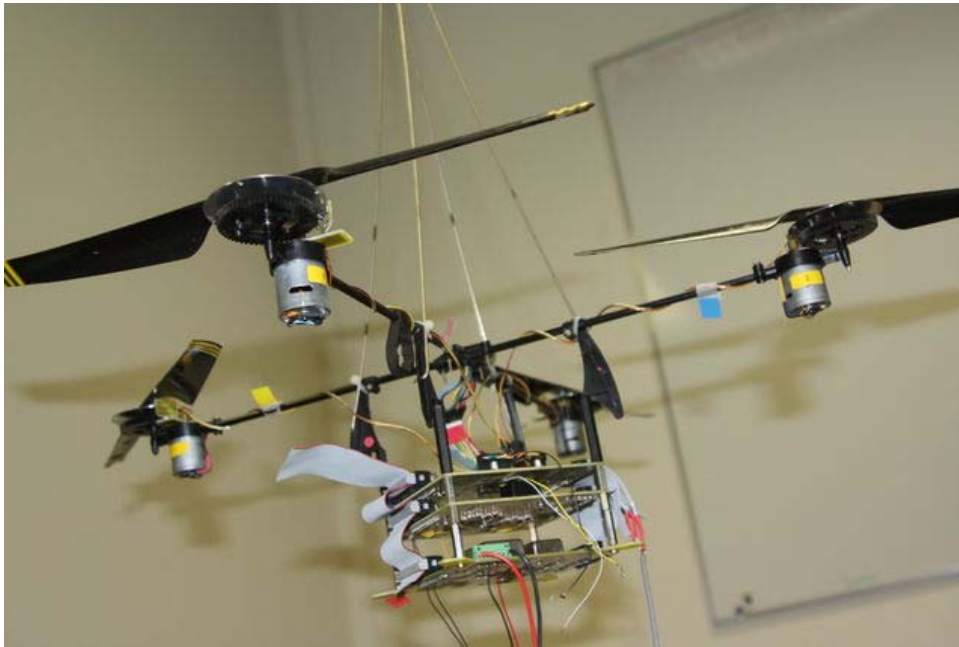

Figure 3: The quadrotor benchtest.

2.2 Hardware-in-the-loop architecture

The goal of the HIL setup consists in realistic assessment of the real control hardware and software (main controller distributed over a network) without using the real drone, i.e. mechanical hardware, motors and sensors. It allows for final checks of the control parameters tuning under real time/bandwidth constraints and environmental disturbances without the risk of breaking the real plant. As the real-time simulator can be run before the real process is finished, it may be used also to refine the dimensioning of some components. It can be also used to assess radically new control algorithms such as control under weakly-hard timing constraints. As far as fault tolerant control and safety are concerned, failures can be artificially injected in any parts of the system's component to evaluate the diagnosis algorithms and corresponding recovery handlers.

Therefore the HIL architecture connects the main control board and real-time control system to a fake system built to mimic the dynamics and behavior of the real drone (Figure 4). The fake process runs on a standard Linux system as a set of Posix pthreads :

Integration This is the core of the simulated process. The quadrotor dynamic non-linear model is handled by a numerical integrator running on top of Linux as a real-time, high priority thread. The model gathers the drone dynamics in 3D space, the motors internal dynamics and a model of the IMU sensors.

The integration must be fast enough to run the simulated model faster than real-time, and to make negligible the disturbances induced by the computing and networking delays.

Motor control This thread receives the motors velocity set-points from the main controller, the measured actual velocity and periodically computes the voltage to be applied to the motors coils (using the same control law and sampling frequency as the one used on the real dsPIC controller).

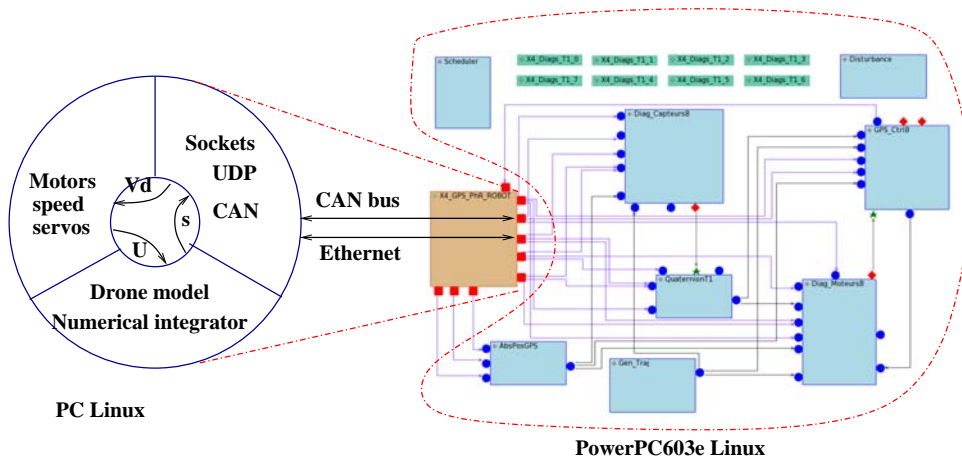

Figure 4: Hardware-in-the-loop .

Communication This thread handles the communications between the main control board and the simulated physical process. As in the real experiments the communication link can be either a CAN bus or an Ethernet link, thus two interfaces have developed based on CAN sockets and UDP sockets libraries (which thanks to the socket abstraction are very similar). This thread handles data packaging and big/little endian conversions.

2.3 Choice of the Numerical Integrator

The non-linear model of a robot (or of most mechatronic systems involving mechanical and electrical components) is usually described by a set of ordinary differential equations (ODEs) (or sometimes by a set of differential-algebraic equations (DAEs)) [2]. There already exist a broad family of algorithms and corresponding software used to numerically solve such a set of ODEs.

To summarize the methods at hand, finding a numerical approximation of the state $X(t)$ of a system of ODEs $\frac{dX}{dt} = f(X, t)$ can be done iteratively with a time step $h_n = t_n - t_{n-1}$ using :

explicit methods X_n is computed only from the last value X_{n-1} (single step) of past values X_{n-1}, \dots, X_{n-k} of the solution. Explicit methods are fast but are only conditionally stable (according to the integration step) for linear systems.

implicit methods need to solve an equation $X_n = \mathcal{F}(X_n, X_{n-1}, \dots, X_{n-k})$ to find the current solution at time n . They involve more computations than explicit methods (and are slower for a given step value) but they are unconditionally stable for linear systems.

For non-linear systems, no-one is unconditionally stable but implicit methods are more robust than the explicit ones, and diverge slower from the theoretic solution, especially when the system to be integrated is stiff. In both cases, the precision of the solution is mainly based on the order of the algorithm, i.e. the degree of the neglected terms of the Taylor's expansion involved in the computation : higher the order better the precision and higher the computing cost.

Another factor that influences the stability, the precision and the computing cost of the integration algorithm is the integration step. Indeed stability and precision depends both of the step size and of the time constants of the system. Systems with fast dynamics requires smaller step size and hence higher computation costs. Adaptive step algorithms allows to dynamically adapt the step size to the current system's dynamic which may vary with time and state space location. In that case the computation cost is high only when necessary, but the number of step to perform the integration for a given horizon becomes unpredictable.

With most existing integration packages, the end-user's choice can be :

- set the value of a fixed-step integrator, leading to a predictable number of steps and computing time, but the precision cannot be controlled and may lead to false results;
- specify the precision of the integration and delegate the adaptive step management to the integrator, but in that case the computing time cannot be predicted.

A possible way to provide a predictable and safe simulation time would be using a fixed step, implicit method integrator providing unconditional stability [3]. In that case the integration step should be set at a value small enough to insure the required accuracy all along the system's trajectory. Choosing a larger step may lead to poor precision and, for non-linear plants, instability or convergence towards a false result, e.g. a local minimum far to the real solution.

Conversely, with an adaptive step integration method the controlled variable is the precision (or more exactly the estimate of the integration error). The lsoda package we have elected [1] for this experiment uses a variable step, variable number of steps algorithm to improve simulation speed and avoid possible numerical instability.

For a given integration accuracy the simulation speed relies upon the fastest time constant of the model and the simulation speed cannot be guaranteed to be real-time (but the user is warned in case of deadline miss). The software uses two integration methods: an explicit Adams method is used at starting time and when the system is considered to be non-stiff. The software automatically switches to an implicit (Backward Differentiation Formula) when an on-line test estimates that the system becomes stiff and thus that the implicit integration method becomes faster than the explicit one (and switches back conversely). The variable step method speeds up the integration by increasing the step when possible, e.g. when the system exhibits slow transients. Finally the explicit method is chosen when it is faster than the implicit method.

Benchmarks and comparisons with renowned methods, e.g. Runge-Kutta 4-5, have shown that despite the complexity of the integration package, the starting overhead is quite small and largely compensated by the efficiency of the method as far as the integration horizon is large enough. Therefore, we can consider that this software implements a method which is almost always faster than the potentially predictable fixed step implicit method, and that this choice consists in the best effort to run the simulation as fast as possible **given a required precision**.

2.4 Numerical integrator synchronization

The integration thread is triggered by data requests or arrivals from/to either the network (real system) or the other threads of the fake system. At each triggering event the integrator is first run from the last event to the current time to update the state of the drone, then it delivers the new state or accept new inputs.

Therefore even if the integration is always performed late w.r.t. real-time, the whole simulation process is driven by the events coming from the main real-time controller or by the other real-time threads of the fake system, so that it is globally synchronized with real time.

The system works pretty well provided that the computation time needed to integrate from the last event is kept small, and in particular the integration step should be completed before the occurrence of the next request. The distortions from reality come from the added delay between a state observation request and the answer delayed by the integrator computing time. This delay depends upon the model's fastest time constant, on the integration algorithm and on the host computer speed.

In practice, for the current set-up the simulation very easily runs comfortably faster than real-time, and the bottleneck comes from the low bandwidth of the CAN bus (which is not simulated, this limitation exists both in the HIL set-up and in the real system, there is no distortion here). Note that computation times and overruns can be easily checked and reported to provide information and warnings about the timing behavior and quality of the simulation.

For some cases, it could be interesting (or even necessary) to drive the integrator from events coming from the process model itself rather than from external triggers such as real-time clocks. For example, when simulating gas engines, events of interest are the ignition instants which are linked to the crank position, i.e. the process state, rather than to time. This could be also the case for incremental encoders for robot arms links. In that case a *root finding* capability should be used to cleanly stop the integration at the point of interest. Such capability could be also be used to integrate in advance w.r.t real-time, thus reducing the risk for overruns.

Finally, if real-time simulation cannot be achieved, or if it is wanted that the simulation runs "as fast as possible" without reference to real-time, another synchronization scheme could be considered. Rather than synchronize the integrator by the real-time controller, the control software could be triggered by the "end-of-integration" events, thus minimizing the processors idle time. However care should be taken to run and synchronize all the simulation components on a coherent time scale.

3 Controller design

3.1 The ORCCAD approach

ORCCAD is a model-based software environment dedicated to the design, the verification and the implementation of real-time control systems². In addition to control law design, the specification and validation of complex missions involving the logical and temporal cooperation of various controllers along the life of a control application [6, 15] can be achieved.

The ORCCAD methodology is bottom-up, starting from the design of control laws by control engineers, to the design of more complex missions.

The first step in designing a control application is to identify all the necessary elementary tasks involved. Then, for each of the tasks, various issues are considered, both with an automatic control viewpoint (such as regulation problem definition, control law design, choice of relevant events, specification of recovery behaviors, etc.) or with an implementation viewpoint (such as the decomposition of the control law into real-time tasks, and selection of timing parameters). Finally, all the real-time tasks are mapped on a target architecture. During this design, the control engineer may take advantage of many degrees of freedom to meet the end-user requirements, and ORCCAD aims at allowing the designer to safely exploit these degrees of freedom through guided design.

ORCCAD proposes a controller architecture which is naturally open, since the access to every level by different users is allowed: the application layer is accessed by the end-user (mission specialist), the control layer is used by the control expert, and the system layer is accessed by the system engineer. ORCCAD provides formalized control structures, which are coordinated using the synchronous paradigm, specifically using the Esterel language: while the control laws are often periodic (or more generally cyclic) and programmed using real-time tasks under control of a real-time scheduler, the discrete-event controller manages the set of control laws and handles exceptions and mode switching. Both activities run under the control of a real-time operating system (RTOS).

The main entities used in the ORCCAD framework are:

- Algorithmic Modules (MA) which represent functions (e.g. controllers, filters, etc.), encoded as pieces of C code;
- Temporal Constraints (TC), the real-time tasks which implement modules (several modules can be gathered in a single TC);
- Robot Tasks (RT), the control tasks representing basic control actions encapsulated by a discrete-event controller;
- Robot Procedures (RP), a hierarchical composition of already existing RTs and RPs, to incrementally build more complex structures, from elementary executable actions to the full control application.

The RTs characterize continuous-time closed-loop control laws, along with their temporal features and the management of associated events. From the application perspective, the RT set of signals and associated behavior represent the external view of the RTs, hiding all specification and implementation details of the control laws. The RPs, which are more complex actions, can then be composed from RTs and other RPs in a hierarchical fashion leading to structures of increasing complexity. At the top level, RPs are used to describe and implement a full mission specification. At mid-level, they can be used to fulfill a single basic goal through several potential solutions, e.g. a nominal controller supplemented by the recovery substitutions associated with Fault Detection and Diagnosis.

Once a control application has been entirely designed, and for some parts formally verified, a run-time code can be automatically generated for various real-time operating systems, such as Linux in the present case. It is assumed that the underlying RTOS supports preemption and fixed priorities, so that the run-time can be fast ported on others Posix systems, and on systems relying on the same abstractions, as already done for Xenomai.

3.2 Quadrotor multi-rate controller

3.2.1 Structure

Figure 5 describes the control and diagnostic setup used for testing networked control systems fault-tolerant control, diagnosis and weakly-hard scheduling policies.

This block-diagram represents one Robot-Task, i.e. one control algorithm whose components are executed repetitively during the RT execution.

²<http://orccad.gforge.inria.fr>

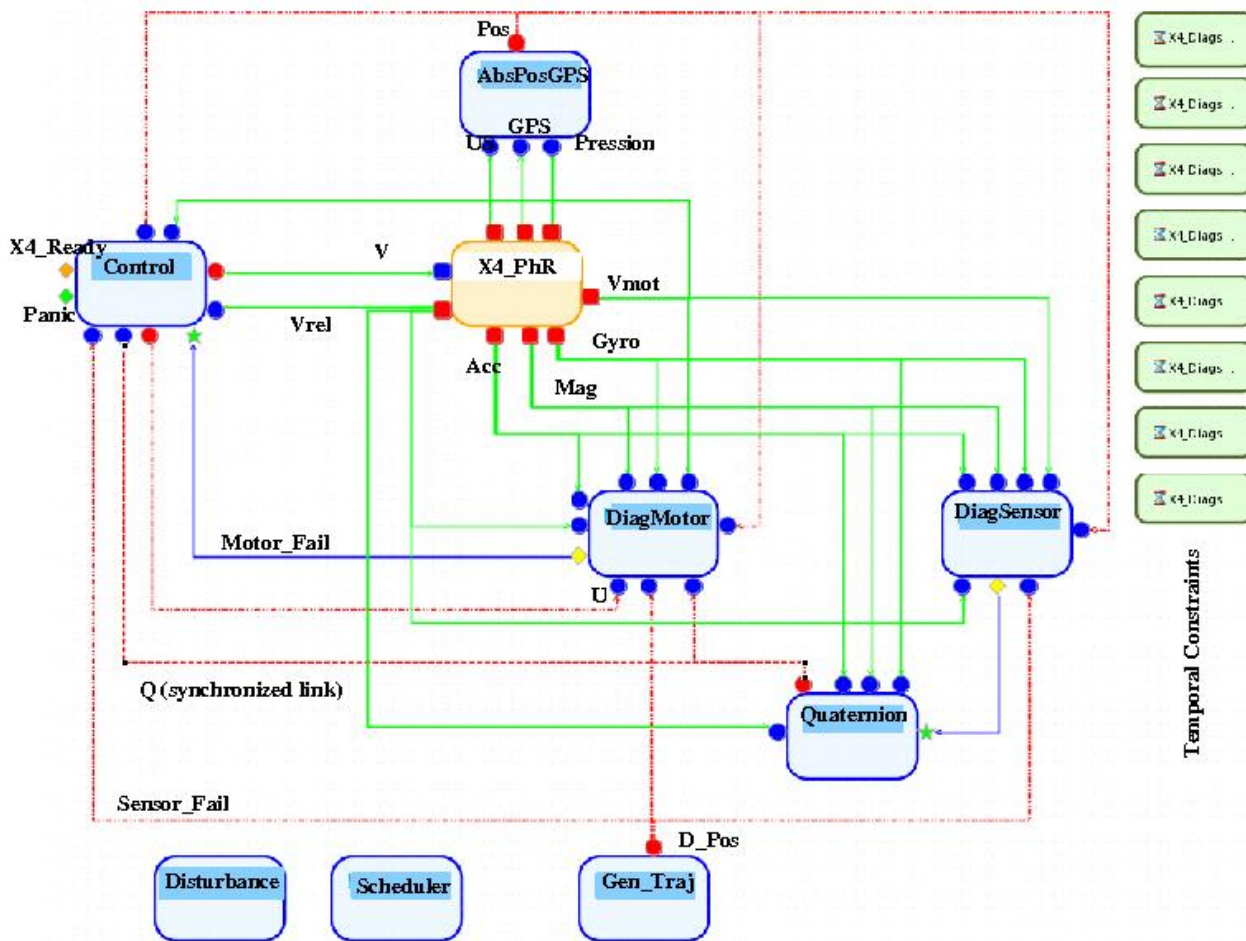

Figure 5: Control and diagnosis block-diagram.

The blue boxes represent user-provided algorithmic modules (MA) interconnected by their input/output ports. Each module implements a user defined function encoded in C, such as a controllers, filters, ... MA are made of three functions (Figure 6) :

init(...) is executed once when the RT is started. It is used to perform various initialization, e.g. memory allocation or initial values measurement. It can emit events, e.g. a T2 exception to signal a bad or timed-out initialization or a pre-condition to signal a successful completion.

compute(...) repetitively executes the code of the function. It can emit various kind of exceptions to signal particular values of the state of the system, e.g. threshold crossing, or a post-condition to signal a normal termination.

end() is executed once at the end of the RT to cleanly close the function.

The input parameters (signature) of the **init(...)** and **compute(...)** functions correspond with the input ports of the module. The function may also receive or update parameters on its parameters ports. Events ports are used to specify the logical events (exceptions and conditions) which can be reported by the module during its execution.

A physical resource module (PhR in yellow) represents the physical process to which the controller is connected. It is in fact a gateway to the physical components of the robotic system (actuators and sensors), and its ports allow to call the drivers to connect with the robots.

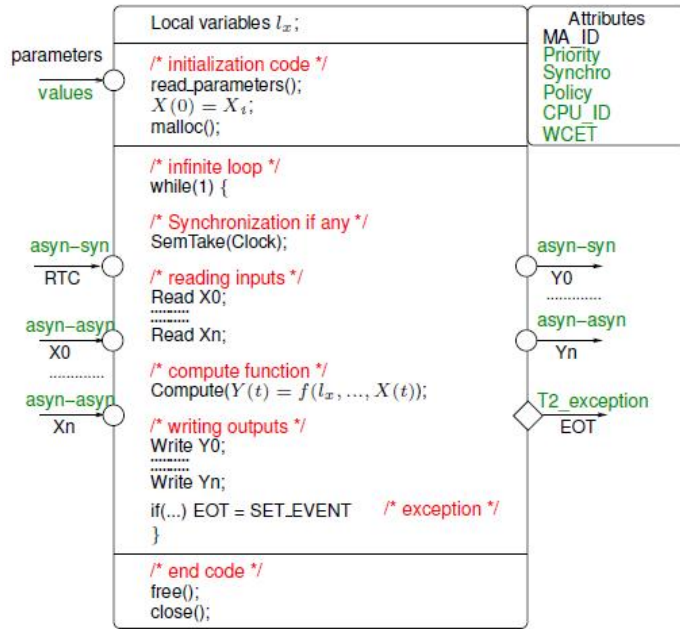

Figure 6: Algorithmic module structure.

3.2.2 Real-time features

From the real-time point of view, each module is own by a TC, i.e. by a real-time thread with a mandatory synchronization input. Each TC may have its own programmable clock.

For simple real-time schemes all the MAs of a controller may share a single TC, thus run in sequence at the same rate. In more complex run-time schemes a one-to-one mapping between MAs and TCs allows every module to be run asynchronously at its own (and possibly varying) sampling frequency. For real-time efficiency several MAs, e.g. which have a strong dependence, can be gathered in the same TC. Also, besides clock triggering, some TC execution ordering can be enforced using synchronization between an output port of a TC and the connected input port of the next TC in the control path.

The TC priorities are set according to their relative importance. Data integrity between asynchronous modules is provided by asynchronous lock-free buffers [14] which are automatically inserted at code generation time.

It is well known that software execution usually show duration variations which are difficult to accurately predict. Moreover systems dimensioned according to worst-cases execution times are over-sized and over-constrained. On the other hand systems setting based on more realistic average execution times lead to occasional overruns and deadlines miss. An Execution Flag is set to every TC to control the behavior of the real-time thread in case of overrun according to a pre-defined exception policy. For example the “SKIP” policy leave the running thread to run to completion but skips its next execution.

3.2.3 Control path

The attitude control path starts from the drivers of the quadrotor sensors (accelerometers Acc, rate gyros Gyr and magnetometers Mag), which are the outputs of the interface module X_{PhR} . The box $X4_{PhR}$ (where PhR stands for Physical Resource) is the interface between the controller and the device to control : sending or reading data on its ports actually calls the drivers, i.e. the functions used to interface the real-time controller with the real hardware, or with the real-time simulator.

The raw measurements are used by the Quaternion module *Quaternion* to estimate the drone attitude using a non-linear observer [8]. The estimated attitude quaternion Q is forwarded to the *Control* module to perform the attitude control. The computed motor desired velocities are then sent to the quadrotor via the V driver port.

Provision is given for future enhancements of the sensor set, since a GPS-like position sensor and ultra-sonic sensors

were expected to be integrated in an enhanced version. Therefore, a trajectory generator module *GEN_Traj* and a position estimator module *AbsPosGPS* are integrated in the control architecture to evaluate position control.

As this control path is critical for the attitude control stability, it is necessary to minimize the loop latency between the raw sensors measurements and the application of the corresponding control to the actuators. Therefore the *Quaternion* and *Control* modules are synchronized via the Q data link. In that case both threads have the same priority, and the *Control* thread has no real-time clock, it inherits the Quaternion thread execution rate thanks to the synchronization.

3.2.4 Diagnosis and fault tolerant control

To implement diagnosis and fault-tolerant control the drone controller uses the weak exception mechanism (T1) provided by the ORCCAD model to modify the behavior of an algorithmic module (e.g. via a conditional jump in the function code) without switching for a new RT.

The *Diag_Capteurs* module runs the diagnostic algorithm that isolates sensors failures. A failure is signaled by the *Sensor_Fail* weak (T1) exception which is forwarded (with a numerical value to precisely identify the failure) to the *Quaternion* module on a parameter port, so that the quaternion estimation algorithm can be adapted according to the reported failure.

Similarly, the *Diag_Motors* module forwards motor failures signaled by the *Motor_Fail* event to a parameter port of the *Control* module, leading to switch for a pre-defined control degraded mode.

3.2.5 Scheduling controller

The ORCCAD run-time API and library provides some user-level functions to observe and manage on-line the system scheduling parameters. For example, *SetSampleTime()* resets on-the-fly the sampling interval of the clocks used to trigger TCs, and *MTgetExecTime()* records the execution time (cycles) used by a given TC since the RT started³.

Using this API, the *Scheduler* module performs on-line management of the scheduling policies used to execute the controller, for example to implement and test feedback schedulers : it monitors the controller's real-time activity and may react by setting on-the-fly the task-scheduling parameters, e.g. their firing intervals. For example, such *Feedback Schedulers* can be used to implement a (m,k)-firm dropping policy [9], to dynamically adapt the priorities of messages on the CAN bus [10] or to implement varying sampling control as in [13].

3.2.6 Disturbance daemon

A *Disturbance* task allows users to generate extra loads with controlled characteristics either on the CPU or on the CAN bus, specific data corruption on the CAN or Ethernet drivers, and faulty behavior on the sensors or actuators, e.g. to assess the effectiveness of the diagnosis and fault isolation capabilities of the control system.

3.2.7 Socket libraries

The embedded and host computers may communicate via a CAN bus or an Ethernet connection. Two interface functions using sockets libraries have been implemented, so that the driver ports located in the *X4_PhR* interface send and receive data using either the Socket-CAN protocol⁴ or UDP sockets on Ethernet.

4 Hardware-in-the loop experiment

This set-up has been used by some partners of the Safenecs ANR project, some of the following results are taken from [5].

4.1 Basic scenario

The attitude control is observed for several networking configurations and real-time control parameters. To minimize the attitude control loop latency the *Quaternion* and *Control* modules are synchronized by the Q data link. In both cases the

³the precise semantics and precision of such statement is highly dependent on the underlying RTOS capabilities

⁴<http://developer.berlios.de/projects/socketcan/>

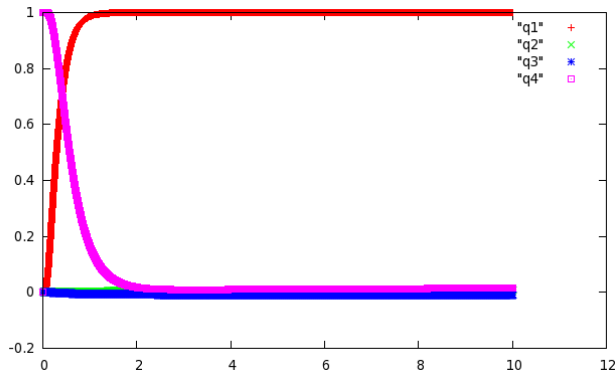

Figure 7: Attitude quaternion, reference: period = 5 msecs, local loop

initial quaternion is $[0.0, 0.0, 0.0, 1.0]$ and the desired quaternion is $[1.0, 0.0, 0.0, 0.0]$, i.e. the local frame must be aligned with the inertial frame. The “SKIP” policy is chosen to handle possible overruns.

In the reference case (Figure 4.1) the controller and numerical integrator are both executed on the same host, they communicate using UDP sockets on the local loop (127.0.0.1) thus minimizing the loop latency. The control period is set to 0.005 sec, the observed average loop latency is about 61μ sec and not overruns are observed.

In the picture the scheduling parameters are the same, but now the controller runs on the PowerPC board linked via the of ce s Ethernet link with the simulator. Important degradations can be observed : indeed due to unpredictable traf c on the communication link and increased loop latency, many instances of the control loop cannot be nished on time and are skipped.

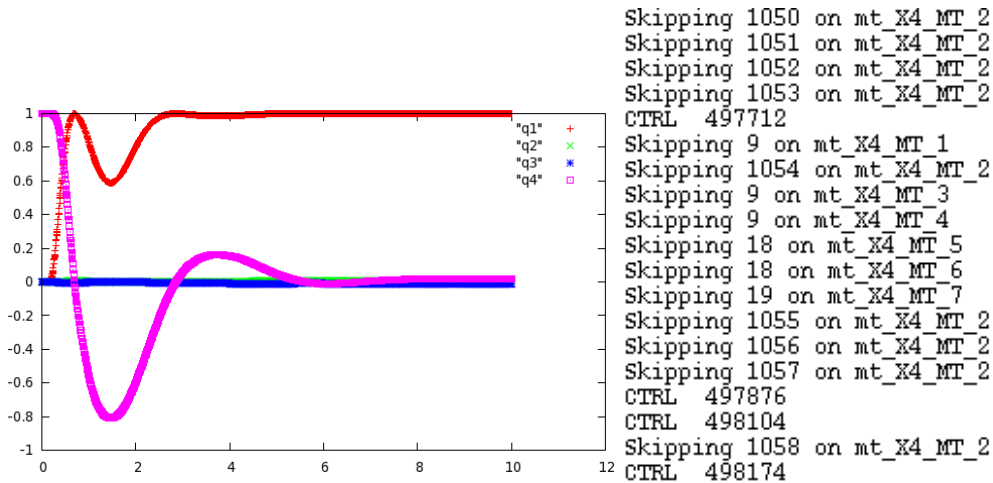

Figure 8: UDP link, period = 5 msecs

It can be observed (Figure 4.1) that lowering the requested control frequency to 50 msecs allows to almost recover the original performance level : in that case the smaller control traf c on the network leads to avoid overruns and greatly compensates for the control interval increase.

Finally, using the CAN bus introduces even more disturbances, in particular due to its rather low bandwidth used in this experiment (250 kbps). Using this bus, trials with a 5 msecs control period lead to so many overruns that the attitude stability cannot be achieved.

The real-time simulator can be used to update or calibrate the models used in the earlier phases of the project. For example the response of the system can be compared to the one obtained with Matlab/Simulink and TRUETIME (Figure 11, right). Here the initial attitude is $[120^\circ; -10^\circ; 50^\circ]$. The system s response are quite similar, showing that the CAN network model integrated in the TRUETIME package is close to the real behavior.

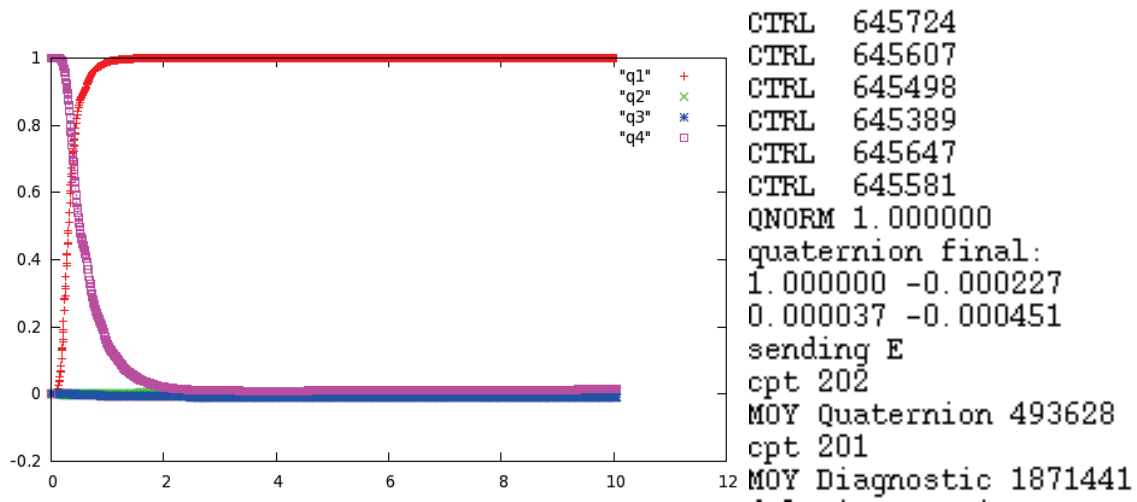

Figure 9: UDP link, period = 50

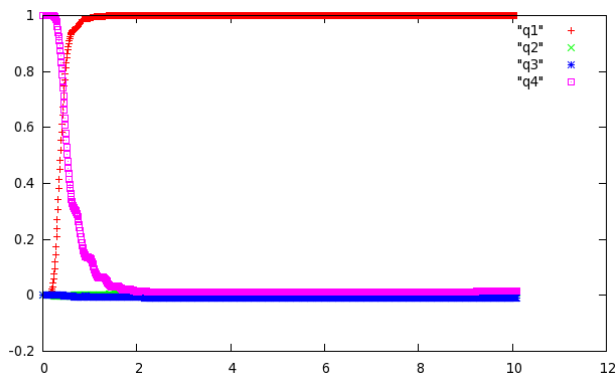

Figure 10: CAN link, 250 kbps baud-rate, period = 50

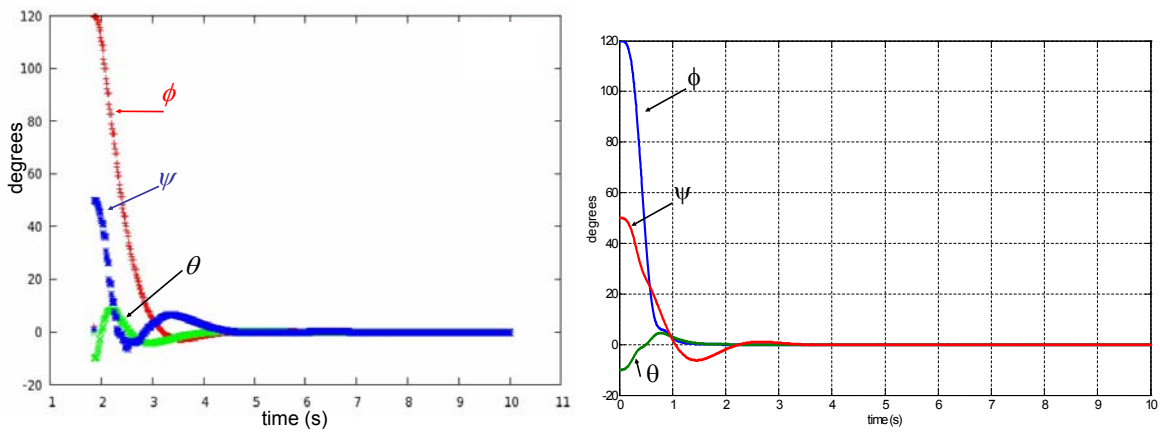

Figure 11: Hardware-in-the-loop (left) – Matlab/Simulink TRUETIME (right).

4.2 Packet loss sensitivity

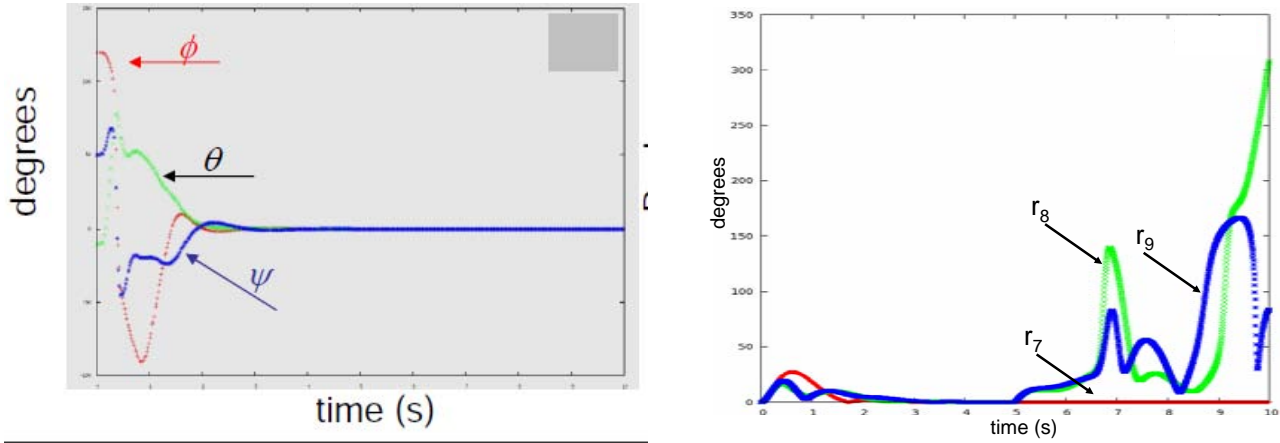

Figure 12: attitude with a 10% packet loss – residuals after packets loss

Here the objective is to study the influence of specified packet losses on the system's behavior. A 10% loss in packets is generated on the Acc_1 channel. A fault indicator $r_{network}$ [4] is used to sort sensor faults and packets loss. When a data is lost at $t = (kh)$, the quaternion $\hat{q}(kh)$ is not computed and the control algorithm holds the previous value ω_{Mi}^{ref} , computed at time $t = (k-1)h$. The results are shown in Figure 12. Small differences can be noted with respect to Figure 11 but it can be seen that the control law is robust to a 10% in packet losses on this sensor. Several other simulations have been made with other packet loss scenarios, and the results are quite similar.

4.3 Sensor failure diagnosis

In this scenario (Figure 12) right, a bias failure in the rate gyro ω_{g1} is introduced at time $t = 5$ seconds. Before the fault appearance, all the residuals are close to zero. After $t = 5$ seconds, residuals r_i ($i = 8, 9$) are sensitive to the fault and residual r_7 , computed with the observer that discards this sensor value, still stands at zero.

This kind of experiment has been very precious for the evaluation of fault-tolerant control in networked control systems, as it appears that diagnosis and fault isolation algorithms are by far more sensitive to data loss, timing inconsistencies and desynchronization than feedback control loops.

5 Summary

The development of a mechatronic embedded system has been handled by following a progressive approach to gradually integrate control, computing and networking features and constraints using the appropriate tools.

As usual the control design process starts with the modeling of the physical devices. Note that dependability and safety concerns can be considered from this very early design stage: for example, the choice of quaternions to model the quadrotor's attitude allows for the bypassing of a number of singularity problems, which later will avoid unpleasant run-time issues. The complexity and the feasibility of the control laws and estimation algorithms on an embedded low-power platform also need to be taken into account in the early stages.

As far as the control algorithms are concerned, discretization, scheduling and networking must be studied altogether, because traditional simulation tools are no longer appropriate. To this end, the TRUETIME toolbox not only handles models of real-time scheduling policies and of some standard networks such as CAN and switched Ethernet, but it also allows us to simulate the execution of control laws on the modeled real-time platform.

The next step before experimentation uses a "hardware-in-the-loop" real-time simulation concept; the real-time software runs on the real target, and the network is no longer simulated, whereas the physical controlled process still is. The development of the run-time software was made easier using ORCCAD, a model-based development environment dedicated to control design and code generation. Therefore, the coupling interaction between the control algorithms and the real-time execution can be examined and fine-tuned at no risk for the real plant, and even before the real plant is

completed. This integration approach allowed to progressively and safely develop, implement and evaluate most of the control, FDI and FTC methods which have been applied on a the challenging quadrotor test-bed.

References

- [1] C. A. Addison, W. H. Enright, P. W. Gaffney, I. Gladwell, and P. M. Hanson. Algorithm 687: a decision tree for the numerical solution of initial value ordinary differential equations. *ACM Transactions on Mathematical Software*, 17(1), 1991.
- [2] M. Arnold, B. Burgermeister, C. Führer, G. Hippmann, and G. Rill. Numerical methods in vehicle system dynamics: State of the art and current developments. *Vehicle System Dynamics*, 2011.
- [3] U.M. Ascher and L.R. Petzold. *Computer Methods for Ordinary Differential Equations and Differential-Algebraic Equations*. SIAM, ISBN 0-89871-412-5, 1998.
- [4] C. Berbra, S. Gentil, S. Lesecq, and J.-M. Thiriet. Co-design for a safe networked control dc motor. In *3rd IFAC Workshop on networked control systems tolerant to faults Necst*, Nancy, France, june 2007.
- [5] Cédric Berbra, Sylviane Gentil, Suzanne Lesecq, and Daniel Simon. Control and diagnosis for an unmanned aerial vehicle. In *Co-design approaches for dependable networked control systems*. ISTE Wiley, 2010.
- [6] J.-J. Borrelly, E. Coste-Maniere, B. Espiau, K. Kapellos, R. Pissard-Gibollet, D. Simon, and N. Turro. The ORCCAD architecture. *International Journal of Robotics Research*, 17(4):338–359, april 1998.
- [7] A. Cervin. *Integrated Control and Real-Time Scheduling*. PhD thesis, Department of Automatic Control, Lund Institute of Technology, Sweden, April 2003.
- [8] J.-F. Guerrero-Castellanos. *Estimation de l'attitude et commande bornée en attitude d'un corps rigide: Application à un mini hélicoptère à quatre rotors*. PhD thesis, Université Joseph Fourier-Grenoble I, France, 2008. (in French).
- [9] N. Jia, Y.-Q. Song, and F. Simonot-Lion. Graceful degradation of the quality of control through data drop policy. In *European Control Conference, ECC'07*, Kos, Greece, july 2007.
- [10] G. Juanole, G. Mouney, and C. Calmettes. On different priority schemes for the message scheduling in networked control systems. In *16th Mediterranean Conference on Control and Automation*, Ajaccio, France, july 2008.
- [11] Martin Ohlin, Dan Henriksson, and Anton Cervin. *TrueTime 1.5—Reference Manual*, january 2007.
- [12] Opnet Technologies Inc. OPNET. <http://www.opnet.com/>.
- [13] D. Simon, D. Robert, and O. Senname. Robust control/scheduling co-design: application to robot control. In *RTAS'05 IEEE Real-Time and Embedded Technology and Applications Symposium*, San Francisco, march 2005.
- [14] H.-R. Simpson. Multireader and multiwriter asynchronous communication mechanisms. *IEE Proceedings-Computer and Digital Techniques*, 144(4):241–244, 1997.
- [15] Martin Törngren, Dan Henriksson, Ola Redell, Christoph Kirsch, Jad El-Khoury, Daniel Simon, Yves Sorel, Hanzalek Zdenek, and Karl-Erik Arzén. Co-design of control systems and their real-time implementation - a tool survey. Technical Report TRITA - MMK 2006:11, Royal Institute of Technology, KTH, Stockolm, Sweden, 2006.