



HAL
open science

Using Bayesian networks for decision in the simultaneous faults case

Sylvain Verron, Philippe Weber, Didier Theilliol, Teodor Tiplica, Abdessamad Kobi, Christophe Aubrun

► **To cite this version:**

Sylvain Verron, Philippe Weber, Didier Theilliol, Teodor Tiplica, Abdessamad Kobi, et al.. Using Bayesian networks for decision in the simultaneous faults case. Workshop on Advanced Control and Diagnosis (ACD'08), 2008, Coventry, United Kingdom. pp.43-48. inria-00517096

HAL Id: inria-00517096

<https://inria.hal.science/inria-00517096v1>

Submitted on 13 Sep 2010

HAL is a multi-disciplinary open access archive for the deposit and dissemination of scientific research documents, whether they are published or not. The documents may come from teaching and research institutions in France or abroad, or from public or private research centers.

L'archive ouverte pluridisciplinaire **HAL**, est destinée au dépôt et à la diffusion de documents scientifiques de niveau recherche, publiés ou non, émanant des établissements d'enseignement et de recherche français ou étrangers, des laboratoires publics ou privés.

Using Bayesian networks for decision in the simultaneous faults case

Sylvain Verron* Philippe Weber** Didier Theilliol**
Teodor Tiplica* Abdessamad Kobi* Christophe Aubrun**

* *LASQUO/ISTIA, 49000 Angers, France (Tel: (33) 241 226 533; e-mail: {sylvain.verron, teodor.tilplica, abdessamad.kobi}@univ-angers.fr).*

** *Centre de Recherche en Automatique de Nancy (CRAN), 54506 Vandoeuvre, France (Tel: (33) 383 684 465; e-mail: {philippe.weber, didier.theilliol, christophe.aubrun}@cran.uhp-nancy.fr)*

Abstract: The purpose of this article is to present a new method for process diagnosis with Bayesian network. The interest of this method is to propose a new structure of Bayesian network allowing to diagnose a system with the model-based framework or with the data-driven framework. A particular interest of the proposed approach is the use of continuous nodes in the network in order to evaluate the status of the process. The effectiveness and performances of the method are illustrated on a heating water process corrupted by various faults.

1. INTRODUCTION

Nowadays, industrial processes are more and more complex (lots of sensors and actuators). Consequently, an important amount of data can be obtained from a process. A process dealing with many variables can be named multivariate process. But, the monitoring of a multivariate process cannot be reduced to the monitoring of each process variable because the correlations between the variables have to be taken into account. Process monitoring is an essential task. The final goal of the process monitoring is to reduce variability, and so, to improve the quality of the product (Montgomery (1997)). The process monitoring comprises four procedures: fault detection (decide if the process is under normal condition or out-of-control); fault identification (identify the variables implicated in an observed out-of-control status); fault diagnosis (find the root cause of the disturbance); process recovery (return the process to a normal status).

Three major kinds of approaches exist for process monitoring (Chiang et al. (2001)): data-driven, model-based and knowledge-based. Theoretically, the best method is the model-based one because this method constructs mathematic models of the process. But, for large systems (lots of inputs, outputs and states), obtaining detailed and reliable models is very difficult. In the knowledge-based category are placed methods based on qualitative models like fault tree, FMECA, expert systems (Venkatasubramanian et al. (2003)). Finally, data-driven methods are techniques based on rigorous statistical development of process data.

The purpose of this article is to present a new method for the diagnosis of faults in industrial systems. This method is based on Bayesian networks. The major interest of this method is the diagnosis of the system when multiple faults occurred simultaneously. Moreover, this method is general enough in order to be applicable for model-based fault diagnosis and for data-driven fault diagnosis.

The article is structured in the following manner. In section 2, we introduce the fault diagnosis framework, and briefly detail the model-based fault diagnosis approach, the data-driven fault diagnosis approach, and give some links between these two approaches. The section 3 presents some previous works about the use of Bayesian networks for both approaches of fault diagnosis (model-based and data-driven). In section 4, we propose a new method for fault diagnosis using Bayesian networks, and evaluate it on an heating water process in section 5. Finally, section 6 concludes on interests and limitations of this method, and presents some perspectives of the fault diagnosis with Bayesian networks.

2. FAULT DIAGNOSIS FRAMEWORK

2.1 Model-based fault diagnosis

In the model-based fault diagnosis, an analytical model of the process is exploited. For each sample instant, the model gives the normal (fault free) value of each sensors or variables of the system. At this step, residuals are generated. Residuals are defined as the difference between a measurement and the corresponding reference value estimated with the model of the fault-free system (Fig. 1).

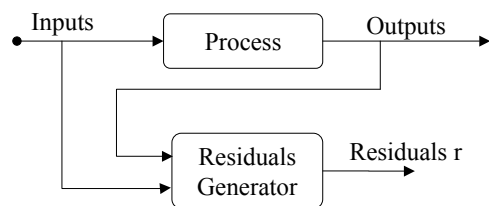

Fig. 1. Illustration of residuals generator

While a single residual is sufficient to detect a fault, a set of residuals is required for fault isolation. Several methods

have been proposed in the literature to generate structured residuals and to perform the fault diagnosis (Isermann and Ball (1996)). One of the most popular methods is the observer-based design (Frank (1990), Patton et al. (2000)). The causal knowledge-based addressed in (Montmain and Gentil (2000)) deals with the complexity of large scale systems. Another way to generate structured residuals is to develop models having an appropriate structure. The structured residuals may be generated by parity equations from the input-output model, or balance equations (chapters 6 and 9, Gertler (1998)). The objective is to decouple the faulty effects from each residual. Each residual is designed so that it is sensitive to different faults or subsets of faults.

Once the residuals generated, the fault diagnosis is based on their evaluations. A classical assumption is that the model of the process is defined in such a way that each residual, in the fault-free case, follows a Gaussian distribution. So, statistical hypotheses tests are generally used in order to decide if a residual is significant (fault in the process) or not (no fault in the process):

- H_0 : the residual is not affected by a fault;
- H_1 : the residual is corrupted by a fault.

This statistical test implicates two possible errors: α (error of the first kind) giving false alarm rate of the test; and β (error of the second kind) giving the missed detection rate (Basseville and Nikiforov (1997)) of the test. An illustration of the test and the associated errors are given on the Fig. 2.

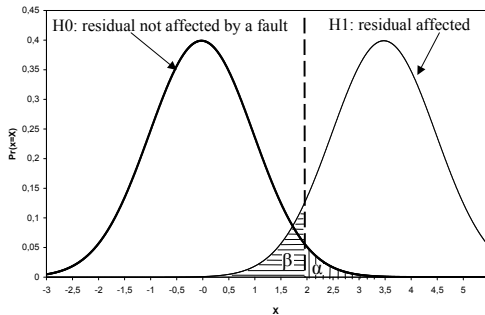

Fig. 2. Illustration of the error of the first kind α and error of the second kind β

For a given residual, u_j represents the status of the residuals (symptoms): u_j is equal to "0" when the residual signal is closer to zero in some sense and equal to "1" otherwise.

Several approaches have been proposed to generate structured residuals and consequently to generate the incidence matrix (Frank (1990)). Let us consider the following example where three different faults (F_1 , F_2 and F_3) can be isolated by designing three symptoms u_1 , u_2 and u_3 (Table 1).

	F_1	F_2	F_3
u_1	0	1	0
u_2	1	0	0
u_3	1	0	1

Table 1. Incidence matrix

In the Table 1, a "1" denotes that a symptom u_j is sensitive to a fault (F_1 , F_2 or F_3), while a "0" denotes insensitivity to a fault. This table is called an incidence matrix and can be considered as an a priori knowledge. Each column of the incidence matrix represents a fault signature: the vector $[0 \ 1 \ 1]^T$ corresponds to the signature of the faulty element F_1 .

2.2 Data-driven fault diagnosis

In the data-driven fault diagnosis, the diagnosis procedure can be seen as a classification task (Chiang et al. (2001)). Indeed, today's processes give many measurements. These measurements can be stored in a database when the process is in fault-free case, but also in the case of identified fault. Assuming that the number of types of fault (classes) and that the belonging class of each observation is in the database (learning sample), the fault diagnosis can be viewed as a supervised classification task whose objective is to class new observations to one of the existing classes Denoeux et al. (1997).

For example, given a learning sample of a bivariate system with three different known fault as illustrated in the Fig. 3, we can easily use supervised classification to classify a new faulty observation.

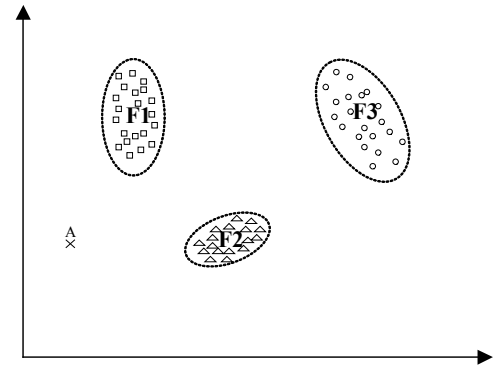

Fig. 3. Bivariate system with three different known faults

Many classifiers have been developed, we can cite FDA (Fisher Discriminant Analysis) (Duda et al. (2001)), SVM (Support Vector Machine) (Vapnik (1995)), kNN (k-nearest neighborhood) (Cover and Hart (1967)), ANN (Artificial Neural Networks) (Duda et al. (2001)) and Bayesian classifiers (Friedman et al. (1997)).

One of the major problem of the classification techniques for the fault diagnosis is the assumption that only one fault can occur simultaneously. This is a problem because, in many situations, multiple faults can occurred at the same time. A possibility to obtain a diagnosis taking into account multiple faults occurrence is to use statistical tests like T^2 control chart (Hotelling (1947)) on each classes of known fault (Verron et al. (2008)). But, for this case, a lot of data is needed.

2.3 Linkings

As we have seen in previous sections, data-driven or model-based diagnosis use hypotheses tests in order to decide if a symptom is present in the process. Knowing

the different symptoms of the process, a decision can be made with the help of the incidence matrix. In the data-driven approach, inputs of the statistical tests are directly the variables of the process or computed features from the variables (like principal component analysis (Jackson (1985))). In the case of the model-based fault diagnosis, inputs of the statistical tests are the residuals obtained from the residuals generator. However, in each case, an assumption is made on the data (the residuals or directly the variables). This assumption is that the data follows normal (Gaussian) distribution. So, in the two approaches, statistical tests implicating Gaussian variables is needed.

Gaussian variables are continuous variables, but symptoms and decisions are discrete variables. An interesting tool allowing to treat these two kinds of variables is the Bayesian network. Moreover, some approaches for the fault diagnosis using Bayesian networks (model-based and data-driven approaches) have already been developed.

A Bayesian Network (BN) (Jensen (1996)) is an acyclic graph where each variable is a node (that can be continuous or discrete). Edges of the graph represent dependences between linked nodes. A formal definition is given here:

A Bayesian network is a triplet $\{\mathbf{G}, \mathbf{E}, \mathbf{D}\}$ where:

$\{\mathbf{G}\}$ is a directed acyclic graph, $\mathbf{G} = (V, A)$, with V the ensemble of nodes of \mathbf{G} , and A the ensemble of edges of \mathbf{G} ,

$\{\mathbf{E}\}$ is a finite probabilistic space (Ω, Z, p) , with Ω a non-empty space, Z a collection of subspace of Ω , and p a probability measure on Z with $p(\Omega) = 1$,

$\{\mathbf{D}\}$ is an ensemble of random variables associated to the nodes of \mathbf{G} and defined on \mathbf{E} such as:

$$p(V_1, V_2, \dots, V_n) = \prod_{i=1}^n p(V_i | C(V_i)) \quad (1)$$

with $C(V_i)$ the ensemble of causes (parents) of V_i in the graph \mathbf{G} .

3. PREVIOUS WORKS WITH BAYESIAN NETWORKS

3.1 Model-based fault diagnosis

In (Weber et al. (2006)), authors propose a Bayesian network in order to model the incidence matrix and the associated decision given the different symptoms of the system. Before to expose this method, we define Bayesian network. The relationship between symptoms and faults are represented by a graph. Obviously a fault can be considered as the cause of the residual deviation. Therefore, some connections can be established from the fault to the symptoms in order to define the relation of causality between fault occurrence and the symptom states. Whereupon, a Bayesian network can define directly an incidence matrix $D(n, j)$. Let us consider two incidence matrices that represent two different cases of possible isolability conditions (Fig. 4). The modelling of the incidence matrices with Bayesian networks is given under the two incidence matrices.

The proposed structure is interesting. But, this technique implicates a loss of information (Dougherty et al. (1995)).

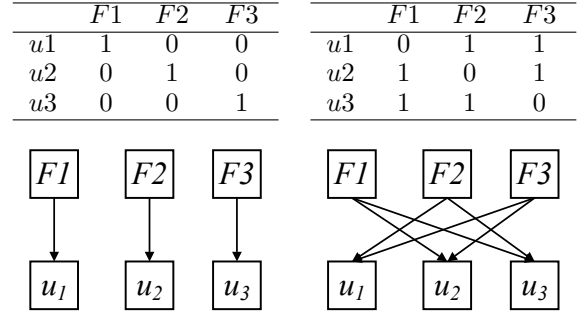

Fig. 4. Modelling of incidence matrices with BN

Indeed, inputs of the networks are not the residuals (continuous values), but the symptoms (discrete values obtained from the results of statistical tests).

3.2 Data-driven fault diagnosis

In (Verron et al. (2007)), authors have demonstrated that a T^2 control chart (Hotelling (1947)) could be modelled with a Bayesian network. For that, two nodes are used: a Gaussian multivariate node \mathbf{X} representing the data and a bimodal node F representing the state of the process. The bimodal node F has the following modalities: IC for in control and OC for out-of-control. Assuming that $\boldsymbol{\mu}$ and $\boldsymbol{\Sigma}$ are respectively the mean vector and the variance-covariance matrix of the process, the process can be monitored with the following rule: if $P(IC|x) < P(OC|x)$ then the process is out-of-control (a fault has occurred in the process). This Bayesian network is represented on the Fig. 5, where the conditional probabilities tables for each node are given.

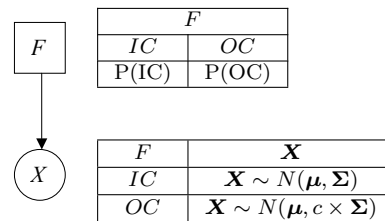

Fig. 5. Control chart with Bayesian network

The coefficient c implicated in the modelling of the control chart by Bayesian network (Fig. 5) is the root (different of 1) of the following equation (Verron et al. (2007)):

$$1 - c + \frac{pc}{LC} \ln(c) = 0 \quad (2)$$

where p is the dimension (number of variables) of the system to monitor, and CL is the control limit of the equivalent T^2 control chart. Very often, CL is equal to $\chi_{\alpha, p}^2$, the quantile at the value α of the distribution of the χ^2 with p degree of freedom (Montgomery (1997)). So, α allows to tune the false alarm rate of the control chart.

4. THE PROPOSED APPROACH

In this section, we propose a new structure of Bayesian network for the fault diagnosis of systems. This new structure is based on the association of the two previous works presented in the last section.

As we have already described, the approach of (Weber et al. (2006)) uses the symptoms (results of hypotheses tests) as observations for the network. But, as the symptoms is discretized (a continuous measure is transformed in "0" or "1"), this method loses some information from the process. So, a more interesting technique is to treat the continuous values (values of the residuals) directly in the network. This procedure has two advantages. Firstly, as we have said before, no information is lost. Secondly, the task of hypotheses tests is directly made in the network, and so the evaluation of residuals is transparent.

For this approach, we can use the modelling of control chart in a Bayesian network. Indeed, as demonstrated in (Montgomery (1997)), a control chart is a suite of hypotheses tests. The control chart previously presented is a multivariate control chart (taking into account multivariate data). However, the univariate case is simply a specific case of the multivariate control chart. So, the following structure (Fig. 6) is proposed in order to deal directly with the residuals of the analytical model. This is the structure of the right incidence matrix of the Fig. 4.

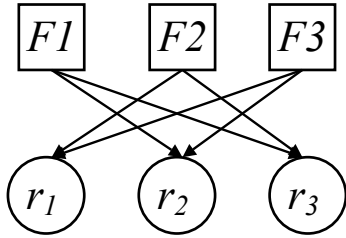

Fig. 6. The proposed structure

The Conditional Probabilities Table (CPT) of the two different types of nodes (discrete and continuous) are given in Tables 2 and 3.

F_i	
IC	OC
$P(IC)$	$P(OC)$

Table 2. CPT of the discrete nodes

F_k	F_{k+1}	r_i
IC	IC	$r3 \sim \mathcal{N}(\mu_{ri}, \sigma_{ri}^2)$
IC	OC	$r3 \sim \mathcal{N}(\mu_{ri}, c_{\alpha\%} \times \sigma_{ri}^2)$
OC	IC	$r3 \sim \mathcal{N}(\mu_{ri}, c_{\alpha\%} \times \sigma_{ri}^2)$
OC	OC	$r3 \sim \mathcal{N}(\mu_{ri}, c_{\alpha\%} \times \sigma_{ri}^2)$

Table 3. CPT of the continuous nodes

In Table 3, μ_{ri} and σ_{ri} are respectively the mean and the standard deviation of the residual r_i for the free-fault conditions. We also precise that $c_{\alpha\%}$ is the coefficient c (equation 2) for a false alarm rate of α percent. Values of $c_{\alpha\%}$ for different α are given in Table 4.

α	0.1	0.05	0.02	0.01	0.005	0.0027
$c_{\alpha\%}$	11.93	42.57	218.58	754.54	2634.50	8092.96

Table 4. Values of $c_{\alpha\%}$ for different α

An other interesting aspect of the proposed approach is the fact that we can use this model for both: model-based fault diagnosis, and also data-driven fault diagnosis. Indeed, instead to input the residuals into the network, we can input directly the measurement of the process. But, in

this data-driven case, continuous variables can have correlations between them. So, in this case, correlations will be represented as edges between the correlated variables. One commonly used data-driven algorithm for this structure learning is called PC (Spirtes et al. (1993)), which uses a series of statistical significance tests of conditional independence. For Gaussian nodes, PC uses the tests of partial correlation with Fisher's z-transform (Kalisch and Buhlmann (2007)).

5. APPLICATION

5.1 Process description

To illustrate our approach, we proposed to consider a simulation example: a heating water process. The process is presented in Fig. 7.

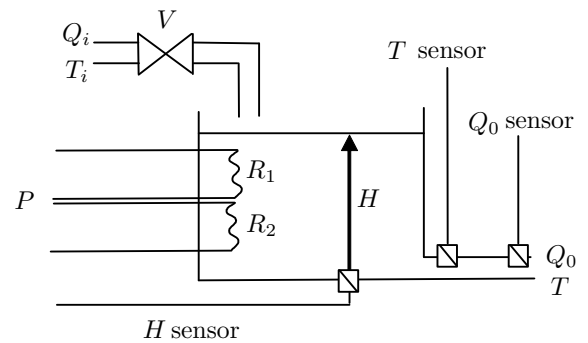

Fig. 7. The studied system: a heating water process

It is composed of a tank equipped with two heating resistors R_1 and R_2 . The inputs are the water flow rate Q_i , the water temperature T_i and the heater electric power P . The outputs are the water flow rate Q_0 and the temperature T which is regulated around an operating point. The temperature of the water T_i is assumed to be constant. The objective of the thermal process is to assure a constant water flow rate with a given temperature. In this analysis only sensor and components failures are considered: level sensor H , output temperature sensor T and output flow rate sensor Q_0 . The detailed mathematical model of the simulated system can be found in (Weber et al. (2008)). From model-based fault diagnosis, a classical observer scheme approach is considered. Based on a state space representation of the system around an operating condition where output vector is equal to $[H \ T]^T$ and input vector $[Q_i \ P]^T$, structured residual are generated and evaluated in order to detect when H level sensor or T temperature sensor faults occur. Moreover according to the physical equation between output flow rate Q_0 and liquid level H , other residual could be established, the fault incidence matrix is defined in Table 5.

	H	Q_0	T
$u1$	0	0	1
$u2$	1	0	0
$u3$	1	1	0

Table 5. Incidence matrix of the heating water process

5.2 Construction of the bayesian network

Based on the incidence matrix of the process (Table 5), the structure of the bayesian network for the diagnosis of the heating water process is constructed (Fig. 8). We precise that in both cases (model-based fault diagnosis and data-driven fault diagnosis) the incidence matrix is the same.

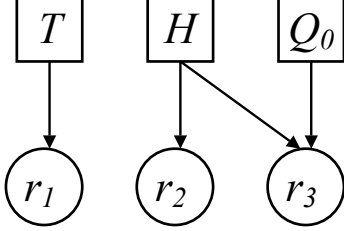

Fig. 8. Bayesian network for the fault diagnosis of the heating water process

We define the different conditional probabilities tables (CPT) as indicated in Tables 6, 7 and 8. We precise that for each discrete node (the different faults), we have decided to place the a priori probabilities to 0.5. So, it signifies that if an a posteriori probability of a fault is greater than 0.5, then this fault is detected in the process. Concerning the continuous node, we have decided that in the case of a sole conditional fault under the residual, we adopt an α of 2%, but in the case of more faults, we adopt 1% (see Table 8).

T, H & Q_0	
IC	OC
0.5	0.5

Table 6. CPT of the nodes T, H and Q_0

T or H	r_1 or r_2
IC	$r_i \sim \mathcal{N}(\mu_{r_i}, \sigma_{r_i}^2)$
OC	$r_i \sim \mathcal{N}(\mu_{r_i}, c_{2\%} \times \sigma_{r_i}^2)$

Table 7. CPT of the nodes r_1 and r_2

H	Q_0	r_3
IC	IC	$r_3 \sim \mathcal{N}(\mu_{r_3}, \sigma_{r_3}^2)$
IC	OC	$r_3 \sim \mathcal{N}(\mu_{r_3}, c_{2\%} \times \sigma_{r_3}^2)$
OC	IC	$r_3 \sim \mathcal{N}(\mu_{r_3}, c_{2\%} \times \sigma_{r_3}^2)$
OC	OC	$r_3 \sim \mathcal{N}(\mu_{r_3}, c_{1\%} \times \sigma_{r_3}^2)$

Table 8. CPT of the node r_3

In the case of the data-driven fault diagnosis, we have exactly the same structure and conditional probabilities tables, except that parameters μ_{r_i} and σ_{r_i} are replaced by μ_{x_i} and σ_{x_i} for $i = 1, 2, 3$.

We have simulated the process under the following scenario:

- Samples 1 to 9: the system is in a fault-free case.
- Samples 10 to 14: a bias on the sensor Q_0 is assumed to occur after sample $k=9$ and to vanish after sample $k=14$.
- Samples 15 to 27: the system is in a fault-free case.
- Samples 28 to 40: T and H sensors faults are supposed to occur simultaneously after sample $k=27$.

All the simulations have been made with Matlab/Simulink and the BNT (BayesNet Toolbox) developed by Murphy (Murphy (2001)).

5.3 Results

The results of the simulation are given on the following graphs (Fig. 9). These graphs represent the respective a posteriori probabilities of each fault, given the observations (r or x). For a given observation instant and a given fault, if the a posteriori probability of the fault is greater than the a priori probability of the fault (here, fixed to 0.5), then we can say that the fault has occurred in the process.

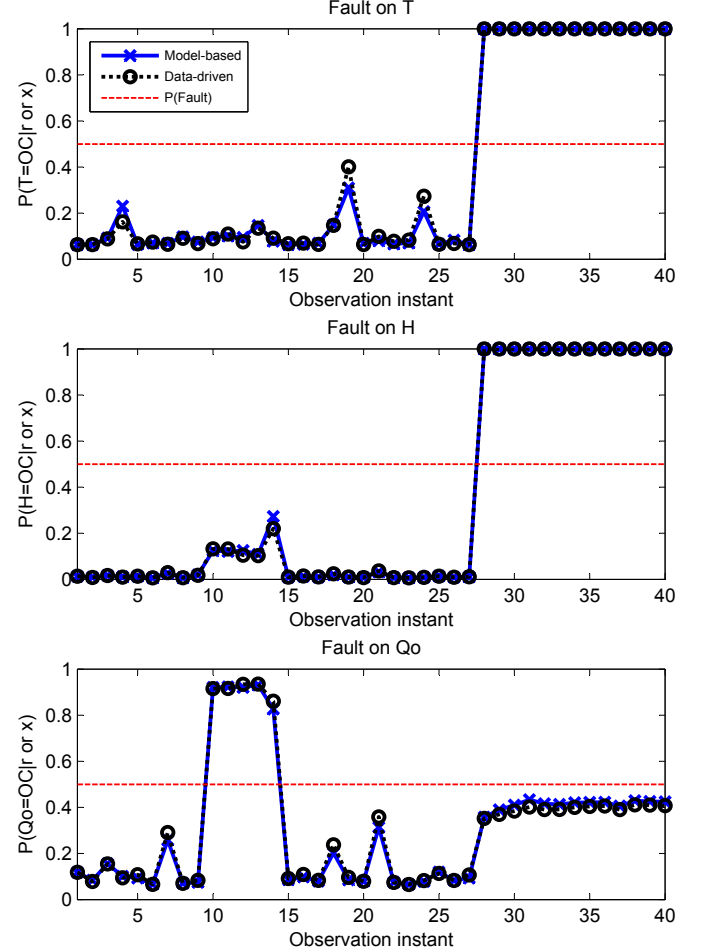

Fig. 9. Results of the simulation

On the Fig. 9, on each graphs, straight lines represents the fixed a priori probabilities of each fault. So, these lines can be named decision limits. The first interesting remark is to view that there are very low variations between the model-based and the data-driven approaches. These variations are very low because faults of this system are very significant in the both cases (high steps on the residuals and on the variables). A detailed analysis is given here for each part of the simulation:

- Samples 1 to 9: no fault is diagnosed.
- Samples 10 to 14: the residual r_3 (and variable x_3) is affected. So, a fault is declared on Q_0 . We can see that the probability of fault on H grows up (due to the relation between r_3 (or x_3) and the fault H), but as the residual r_2 (or variable x_2) is not affected, this fault is not declared.
- Samples 15 to 27: no fault is diagnosed.

- Samples 28 to 40: all the residuals (and variables) are affected. So, firstly, fault T is declared. Secondly, we can view that only the fault H is declared. Indeed, as r_2 and r_3 (and x_2 and x_3) are affected it is most probable that the fault H appeared (sensible to r_2 and r_3) than the fault Q_0 (only sensible to r_3).

So, we can say that the proposed method performs well because for each scenario instant, the correct decision is made by the Bayesian network, and notably when there are multiple faults in the process (samples 28 to 40).

6. CONCLUSIONS

The main interest of this article is the presentation of a new method for the fault diagnosis of industrial processes. This method is based on Bayesian networks. We have proposed a particular structure of network, using discrete and continuous (Gaussian) nodes. This structure allows the fault diagnosis of systems for the model-based framework and the data-driven framework. In the first case, residuals are used as inputs of the network, and in the second case, inputs are directly the variables (supposed Gaussians) of the system. This method is particularly interesting because it allows the case of multiple faults occurred in the process. The proposed method has been tested on a heating water process, where the two approaches (model-based and data-driven) had given similar good results.

Outlooks of this work would be the application of the proposed method to a more complex process like the Tennessee Eastman Process (Downs and Vogel (1993)). A second outlook of the proposed approach is the extension to the Gaussian models mixture in order to take into account some non Gaussian data. Finally, the more interesting perspective is to use a Bayesian network to diagnose one or multiple faults with a combination of data from the model-based approach and from the data-driven approach.

REFERENCES

- Basseville, M. and Nikiforov, I. (1997). *Detection of abrupt changes: theory and application*. Prentice Hall Information and System Sciences series.
- Chiang, L.H., Russell, E.L., and Braatz, R.D. (2001). *Fault detection and diagnosis in industrial systems*. New York: Springer-Verlag.
- Cover, T. and Hart, P. (1967). Nearest neighbor pattern classification. *IEEE Transactions on Information Theory*, 13, 21–27.
- Denoeux, T., Masson, M., and Dubuisson, B. (1997). Advanced pattern recognition techniques for system monitoring and diagnosis : A survey. *Journal European des Systemes Automatises*, 31(9-10), 1509–1539.
- Dougherty, J., Kohavi, R., and Sahami, M. (1995). Supervised and unsupervised discretization of continuous features. In *Proceedings of the 12th International Conference on Machine Learning*.
- Downs, J. and Vogel, E. (1993). Plant-wide industrial process control problem. *Computers and Chemical Engineering*, 17(3), 245–255.
- Duda, R.O., Hart, P.E., and Stork, D.G. (2001). *Pattern Classification 2nd edition*. Wiley.
- Frank, P. (1990). Fault diagnosis in dynamic systems using analytical and knowledge-based redundancy. a survey and some new results. *Automatica*, 26(3), 459–474.
- Friedman, N., Geiger, D., and Goldszmidt, M. (1997). Bayesian network classifiers. *Machine Learning*, 29(2-3), 131–163.
- Gertler, J. (1998). *Fault detection and diagnosis in engineering systems*. Marcel Dekker, Inc. New York.
- Hotelling, H. (1947). Multivariate quality control. *Techniques of Statistical Analysis*, , 111–184.
- Isermann, R. and Ball, P. (1996). Trends in the application of model based fault detection and diagnosis of technical processes. In *World IFAC Congress*, 1–12. San Francisco, USA.
- Jackson, E.J. (1985). Multivariate quality control. *Communication Statistics - Theory and Methods*, 14, 2657 – 2688.
- Jensen, F.V. (1996). *An introduction to Bayesian Networks*. Taylor and Francis, London, United Kingdom.
- Kalisch, M. and Buhlmann, P. (2007). Estimating high-dimensional directed acyclic graphs with the pc-algorithm. *Journal of Machine Learning Research*, 8, 613–636.
- Montgomery, D.C. (1997). *Introduction to Statistical Quality Control, Third Edition*. John Wiley and Sons.
- Montmain, J. and Gentil, S. (2000). Dynamic causal model diagnostic reasoning for on-line technical process supervision. *Automatica*, 36, 1137–1152.
- Murphy, K.P. (2001). The bayes net toolbox for matlab. In *In Computing Science and Statistics : Proceedings of Interface*.
- Patton, R.J., Frank, P.M., and Clark, R.N. (2000). *Issues of Fault Diagnosis for Dynamic Systems*. Springer.
- Spirtes, P., Glymour, C., and Scheines, R. (1993). *Causation, prediction, and search*. Springer-Verlag.
- Vapnik, V.N. (1995). *The Nature of Statistical Learning Theory*. Springer.
- Venkatasubramanian, V., Rengaswamy, R., and Kavuri, S. (2003). A review of process fault detection and diagnosis part ii: Qualitative models and search strategies. *Computers and Chemical Engineering*, 27(3), 313–326.
- Verron, S., Tiplica, T., and Kobi, A. (2007). Multivariate control charts with a bayesian network. In *4th International Conference on Informatics in Control, Automation and Robotics (ICINCO)*, 228–233.
- Verron, S., Tiplica, T., and Kobi, A. (2008). Distance rejection in a bayesian network for fault diagnosis of industrial systems. In *16th Mediterranean Conference on Control and Automation, MED'08*. Ajaccio, France.
- Weber, P., Theilliol, D., and Aubrun, C. (2008). Component reliability in fault diagnosis decision-making based on dynamic bayesian networks. *Journal of Risk and Reliability*.
- Weber, P., Theilliol, D., Aubrun, C., and Evsukoff, A. (2006). Increasing effectiveness of model-based fault diagnosis: A dynamic bayesian network design for decision making. In *6th IFAC Symposium on Fault Detection, Supervision and Safety of technical processes*.