



**HAL**  
open science

## Exploring the Virtual Infrastructures as a Service concept with HIPerNET

Pascale Primet Vicat-Blanc, Guilherme Koslovski, Fabienne Anhalt, Tram  
Truong Huu, Johan Montagnat

► **To cite this version:**

Pascale Primet Vicat-Blanc, Guilherme Koslovski, Fabienne Anhalt, Tram Truong Huu, Johan Montagnat. Exploring the Virtual Infrastructures as a Service concept with HIPerNET. [Research Report] RR-7185, INRIA. 2010, pp.36. inria-00450409v2

**HAL Id: inria-00450409**

**<https://inria.hal.science/inria-00450409v2>**

Submitted on 21 Jun 2010

**HAL** is a multi-disciplinary open access archive for the deposit and dissemination of scientific research documents, whether they are published or not. The documents may come from teaching and research institutions in France or abroad, or from public or private research centers.

L'archive ouverte pluridisciplinaire **HAL**, est destinée au dépôt et à la diffusion de documents scientifiques de niveau recherche, publiés ou non, émanant des établissements d'enseignement et de recherche français ou étrangers, des laboratoires publics ou privés.



INSTITUT NATIONAL DE RECHERCHE EN INFORMATIQUE ET EN AUTOMATIQUE

*Exploration du concept d'Infrastructures en tant que  
Services avec HIPerNET*

Pascale Vicat-Blanc Primet — Guilherme Koslovski — Fabienne Anhalt — Tram Truong  
Huu — Johan Montagnat

**N° 7185**

January 2010

Domaine 3



*R*  
*apport*  
*de recherche*



## Exploration du concept d'Infrastructures en tant que Services avec HIPerNET

Pascale Vicat-Blanc Primet, Guilherme Koslovski , Fabienne  
Anhalt , Tram Truong Huu , Johan Montagnat

Domaine : Réseaux, systèmes et services, calcul distribué  
Équipe-Projet ANR CIS 06 HIPCAL 005

Rapport de recherche n° 7185 — January 2010 — 32 pages

**Résumé :** Dans le contexte de l'expansion et de la convergence du calcul et des communications, l'approvisionnement dynamique d'infrastructures distribuées personnalisables et la virtualisation des ressources sont des concepts et des technologies prometteurs. Pour permettre aux utilisateurs de créer et d'apprécier de telles infrastructures virtuelles, de nouveaux modèles et outils sont nécessaires. Ce rapport de recherche présente le framework HIPerNET que nous concevons et développons pour créer, gérer et contrôler des infrastructures virtuelles dans le contexte de l'Internet haut-débit. L'idée clé de cette proposition est la combinaison de la virtualisation du réseau et du système, associées à la réservation des ressources. Les motivations et les principes de conception d'HIPerNET sont présentés. Puis, nous introduisons le concept des infrastructures virtuelles, appelées *Virtual Private eXecution Infrastructures (VPXI)*. Pour aider à spécifier des infrastructures isolées et personnalisées, HIPerNET se base sur VXDL, un langage pour la description et la modélisation de VPXI, qui prend en compte ces ressources d'extrémité ainsi que la topologie réseau virtuelle les interconnectant. Nous illustrons la spécification, l'allocation et l'exécution de VPXI en utilisant de réelles applications médicales distribuées à grande échelle. Les résultats expérimentaux obtenus dans la plateforme Grid'5000 sont présentés et analysés.

**Mots-clés :** HIPerNET, Infrastructures virtuelles, IaaS, Virtualisation Réseau, VXDL, VPXI, Provisionnement, Isolation

## Exploring the Virtual Infrastructures as a Service concept with HIPerNET

**Abstract:** With the expansion and convergence of communication and computing, dynamic provisioning of customized networking and processing infrastructures, as well as resource virtualization, are appealing concepts and technologies. Therefore, new models and tools are needed to allow users to create, trust and enjoy such on-demand virtual infrastructures within a wide area context. This research report presents the HIPerNET framework that we are designing and developing for creating, managing and controlling virtual infrastructures in the context of high-speed Internet. The key idea of this proposal is the combination of network- and system-virtualization associated with controlled resource reservation to provide fully isolated environments. HIPerNET's motivations and design principles are presented. We then examine specifically how this framework handles the virtual infrastructures, called Virtual Private eXecution Infrastructures (VPXI). To help specifying customized isolated infrastructures, HIPerNET relies on VXDL, a language for VPXI description and modeling which considers end-host resource as well as the virtual network topology interconnecting them, including virtual routers. We exemplify the VPXI specification, allocation and execution using a real large-scale distributed medical application. Experimental results obtained within the Grid'5000 testbed are presented and analyzed.

**Key-words:** HIPerNET, Virtual Infrastructures, IaaS, Network Virtualization, VXDL, VPXI, Provisioning, Isolation

## 1 Introduction

The expansion and convergence of computing and communication paint a new vision of the Internet : it is not only a black box providing pipes between edge machines, but becomes a world-wide reservoir increasingly embedding computational and storage resources to meet the requirement of emerging applications[1]. Consequently, the promising vision of grid computing—to bring together geographically distributed resources to build very large-scale computing environments for data- or computing-intensive applications—along with the service wave led naturally to the "Infrastructure as a Service" paradigm[2].

High-end applications present new challenges—e.g., the amount of data to process, the distribution of the data (wide-spreading of data sources over the territory), the heterogeneity of the data (lack of well-established standards), confidentiality—which results in high communication, storage, and computation requirements. Intensive data-processing applications require an access to infrastructures with high-performance data-movement facilities coordinated with computational resources. However, current grid or cloud computing solutions[3, 4] built over traditional TCP/IP technology do not provide the performance isolation and predictability required by these users. Other applications need interconnections of large-scale instruments with high-performance computing platforms. The proposed best-effort approaches often result in user dissatisfaction and/or resource under-utilization. Moreover, system and middleware heterogeneity and complexity posed barriers to application portability. We expect future Internet applications will be more and more demanding in terms of security, performance and quality of service. New technologies such as machine, links or router virtualization are now envisioned as solutions to these issues. Future applications may highly benefit from these innovations.

In this report, we argue that the extension of the *Infrastructure as a Service* paradigm to network resources is promising and powerful. We show how it can be implemented through the Virtual Private eXecution Infrastructure (VPXI) concept. Seen as a fundamental building block, VPXIs could mark a step forward in transforming the Internet into a huge, shared computing and communication facility. Any entity (individual user, community, government, corporate customer, high-level service provider) would dynamically rent the IT resources combined with the networking resources it needs to solve its specific problem. Based on this vision, this report presents HIPerNET, a framework to create, manage and control confined Virtual Private eXecution Infrastructures (VPXI) in a large-scale distributed environment.

In Section 2 we present the Virtual Private eXecution Infrastructure concept and the HIPerNET framework, highlighting the originalities of its design. Section 3 discusses the specification and allocation process of VPXIs based on the VXDL, a language for virtual-infrastructure specification and modeling which considers end-host resources as well as virtual network topology, including virtual routers and timeline. In Section 4 we highlight the configuration step. The configuration of a VPXI is based on the instantiation of virtual entities as well as the configuration of various embedded mechanisms. Section 5 details the process for mapping an application on physical resources in a virtualized-infrastructure context. We illustrate application mapping through an example with the Bronze Standard workflow. In Section 6 we give experimental results obtained on the

Grid'5000 testbed. Related works are in Section 7 while conclusion and perspectives are developed in Section 8.

## 2 HIPerNET Concepts

### 2.1 Combining OS and Network Virtualization

The virtualization concept[5, 6, 7] enables an efficient separation between services or applications and physical resources. The virtual-machines paradigm is becoming a key feature of servers, distributed systems and grids as it provides a powerful abstraction. It has the potential to simplify resource management and to offer a great flexibility in resource usage. Each Virtual Machine (VM) a) provides a confined environment where non-trusted applications can be run, b) allows establishing limits in hardware-resource access and usage, through isolation techniques, c) allows adapting the runtime environment to the application instead of porting the application to the runtime environment (this enhances application portability), d) allows using dedicated or optimized OS mechanisms (scheduler, virtual memory management, network protocol) for each application, e) enables applications and processes running within a VM to be managed as a whole.

A virtual private network is classically provisioned over a public network infrastructure to provide dedicated connectivity to a closed group of users. Resource-guaranteed VPNs[8] can be obtained from a carrier but are generally static and require complex service level agreements (SLAs) and overheads. Tunneled VPNs [9] such as those in use over the Internet are more lightweight but offer low performance and no assured quality of service. The functionality required for the automating dynamic provisioning of lightpath or virtual private network capacities is emerging[10].

We propose here to combine and apply the concepts to both the IT resources and the network to enable the creation of multiple, isolated and protected virtual aggregates on the same set of physical resources by sharing them in time and space. These aggregations of virtual resources organized with virtual interconnections are called Virtual Private eXecution Infrastructures (VPXI). Moreover, virtualizing routers and switching equipments opens an interesting door for the customization of packet routing, packet scheduling and traffic engineering for each virtual interconnection network. Router-function customization as well as data-plane virtualization offers a high flexibility for each infrastructure. Therefore, conceptually, the virtual infrastructures are logically isolated by virtualization and enable the deployment of independant and customized bandwidth provisioning, channel encryption, addressing strategies. The isolation could also provide a high security level for each infrastructure. However, obtaining full performance and security isolation remains a key technical issue and most of the proposed virtual infrastructure frameworks do not address it properly.

## 2.2 HIPerNET and Virtual Private Execution Infrastructures concept

### 2.2.1 Design principles of the HIPerNET framework.

The HIPerNET framework combines system and networking virtualization technologies with crypto-based-security, bandwidth sharing and advance reservation mechanisms to offer dynamic networking and computing infrastructures as services. This framework is transparent to all types of upper layers : upper layer protocols (e.g., TCP, UDP), APIs (e.g., sockets), middlewares (e.g., Globus [3], Diet [11]), applications, services and users. It helps end users with intensive-application deployment, execution and debugging, by providing an environment to run them on scalable, controlled, distributed and high-capacity platforms. HIPerNET is also mostly agnostic of lower layers and can be deployed over IP as well as lambda networks.

The HIPerNET framework is responsible for the creation, management and control of dynamic entities called VPXIs, as defined in the next section, providing a generalized infrastructure service. It supervises VPXIs during their whole lifetime. The key principle is to have operations realized automatically. For this, HIPerNET defines and activates mechanisms to automatically control the VPXIs as well as the status of the underlying exposed substrate called HIPerSpace. HIPerNET integrates classical FACPS (fault-tolerance, accounting, configuration, performance and security) management functions to these dematerialized entities. In the context of this report, we focus on two critical aspects of the virtualisation context : network configuration and performance isolation. Neither the security mechanisms—which are other key points of this framework [12]—relying on SPKI and the HIP protocol, nor the advance reservation algorithms or the migration mechanisms for fault-tolerance, are described in this report.

Figure 1 illustrates two virtual execution infrastructures (*VPXI A* and *VPXI B*) allocated on a global exposed infrastructure (HIPerSpace) using the HIPerNET framework <sup>1</sup>.

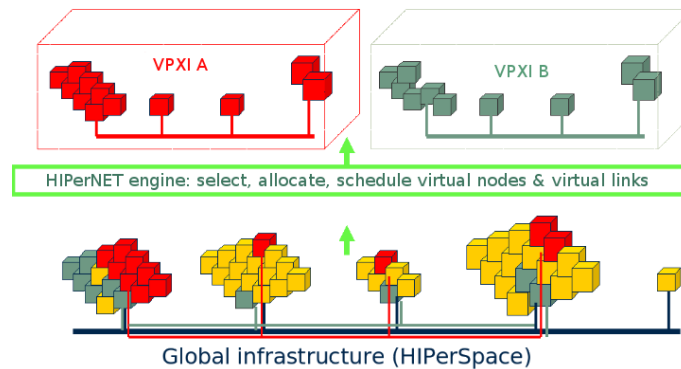

FIG. 1 – Example of a VPXI allocation on a distributed and virtualized HIPerSpace.

<sup>1</sup>The HIPerNET software is under development within the ANR HIPCAL project [13]



At the lower level, the HIPerNET framework accesses and controls a part of the physical infrastructure which is virtualized and called the HIPerSpace. Enrolled physical resources are then registered to the HIPerNET registrar and can be allocated to VPXIs. Once the resources have been exposed, HIPerNET gets full control over it. This set of exposed virtualized resources composes the substrate hosting the VPXIs. At run-time, the HIPerNET manager communicates with the nodes of the HIPerSpace to deploy virtual nodes, monitor their status and configure control tools to supervise the resource usage.

In this fully-virtualized scenario, HIPerNET interacts with multiple resource providers to plan, monitor and control them. Functions such as fault management, load balancing, bandwidth management and performance control are handled taking both network- and resource-virtualization techniques into account.

The current HIPerNET software implements virtual links at layer 3 of the OSI model (using IPsec and the HIP protocol [14]) enabling multiple virtual overlay networks to cohabit on a shared communication infrastructure. An overlay network has an ideal vantage point to monitor and control the underlying physical network and the applications running on the VMs. All network overlays and virtual end hosts are kept isolated both at the network and OS level to ensure security, performance control and adaptability. We also study the implementation of these virtual links at lower level (layer 2 or layer 1) within the CARRIOCAS project[10], [15].

### 2.2.2 Virtual Private Execution Infrastructure concept.

We define the *Virtual Private eXecution Infrastructure (VPXI)* concept as the HIPerNET's management unit. VPXIs are an organized aggregation of virtual computing resources interconnected by a virtual private overlay network for a defined time period. Ideally, any user of a VPXI has the illusion that he is using his own dedicated system, while he really is using multiple systems, part of the global distributed infrastructure. The resulting virtual instances are kept isolated from each others and the members of a VPXI have a consistent view of a single private TCP/IP overlay, independently from the underlying physical topology. A VPXI can span multiple networks belonging to disparate administrative domains. In virtual infrastructures, a user can join from any location and use the same applications he was using on the Internet or its intranet.

Each VPXI is specified according to the user requirements. The specification is interpreted, allocated and configured using basic entities, which are building blocks composing the virtual execution infrastructures, as *VXNodes* : *virtual end hosts*, *VXRouters* : *virtual routers*, and *VXLinks* : *virtual links*.

**VXNodes : Virtual end hosts.** VXNodes or virtual end hosts are personalized virtual machines that are allocated in physical hosts, and managed by HIPerNET to make sure they share the physical resources among them in a confined, secured and isolated way. Developed in accordance with the specifications of users and applications, each virtual end host can be parameterized (e.g., CPU, RAM memory, storage) and configured (e.g., operating system, communication tools) respecting the key set of parameters informed during their specification. Otherwise, end hosts can be organized individually or in groups, recursively. Basically, a VPXI represents a complex infrastructure, composed by individual end hosts that interact with groups (clusters or grids). Groups allow HIPerNET

to manage a set of virtual end hosts with the same characteristics all together, thus avoid unnecessary complex topologies and configuration scenarios.

**VXRouters : Virtual routers.** Within the VPXI design, virtual routers, which we call *VXRouters*, are fully-personalizable components of the VPXIs. For example, these VXRouters, instantiated within physical Linux routers, will run inside isolated virtual machine instances. In our approach, all traditional network planes (data, control and management) are virtualized. Therefore, users can use any protocol and control mechanism on their allocated virtual router, and within the virtual interconnection network. HIPerNET implements a default routing mechanism on the virtual routers, but users can reconfigure it. They can deploy customized routing protocols, and configure the packet-queuing disciplines, packet filtering and monitoring mechanisms they want. HIPerNET only manages the physical substrate and the resources attribution to each VXRouter. Also, VXRouters represent strategic points of the network for rate control as they concentrate aggregated VPXI traffic. By limiting the rate and policing the traffic of the different VXRouters, the traffic of VPXIs can be controlled and the user is provided with a fully isolated execution infrastructure. The control is implemented in the substrate, hence its implementation and management is transparent to the user. The advantage of having controlled environments is twofold : users have strong guarantees, while the network provider can better exploit the network by sharing it efficiently but differently between users.

**VXLinks : Virtual links.** Virtual execution infrastructures can be composed by several VXNodes, groups of them, and VXRouters. All these components are interconnected using VXLinks or virtual links. Each VXLink is a temporary path allocated among multiple physical channels. As in a real infrastructure, each link can be parameterized with different metrics according to the applications' requirements. Metrics such as bandwidth, latency and direction can be valued for each virtual link. Using the source-destination definition, it is possible to organize the model of the virtual infrastructure, defining and asking for specific configurations in critical paths, that can interfere with the execution of applications.

HIPerNET comprises a module to specify virtual infrastructures. This module relies on the VXDL [16] language and provides users with a large flexibility in VPXI design as illustrated in the next section.

## 3 VXDL : Specifying and modeling Virtual Private Execution Infrastructures

### 3.1 Needs for a specific language

Users need to define the virtual private execution infrastructures they request according to the applications' requirements. This process requires a specific language to describe virtual resources and networks. Existing languages are used in different areas of networks or IT resources management. The Common Information Model Specification (CIM) [17] provides a common set of objects and

relationship among them. The CIM architecture is based on the UML concept and provides language CQL (CIM Query Language) to select sets of properties from CIM-object instances. CQL is a subset of SQL-92 with some extensions specific to CIM. In this case, CQL allows queries asking for a set of resources with certain configurations, but does not have parameters to interact with the allocation system, for example informing the basic location of a component. An other common example is the Network Description Language (NDL) [18]. NDL is a collection of schemas (topology, layer, capability, domain and physical) used to represent a network infrastructure at different levels. This language is guided by the Resource Description Framework (RDF) [19], a general-purpose language for representing information on the Web. Basically, RDF (and NDL) explores a graph data model composed by a set of RDF triples (a *subject*, an *object* and a *predicate (property)*). The triple concept is difficult to adapt to recursive description, like groups or aggregates found in virtual infrastructures. A descriptive language dedicated to virtual infrastructures description must be more adaptive than conventional solutions and needs to combine the space and temporal aspects of virtual infrastructures. During the specification process, new challenges coming from virtualization techniques have to complement the management, configuration and execution features of classical languages. We identify some desirable aspects that must be explored for descriptive languages : a) recursive representation of individual resources and groups ; b) each resource must be characterized using an extensible list of descriptive parameters to represent the necessary configuration—e.g., RAM memory, CPU speed, storage capability ; c) considering the configuration and deployment is also necessary to describe the software (e.g., operating systems) and tools (e.g., communication and programming tools) that must be used in VPXI ; d) each component (individually or in group) should be characterized as its elementary function, for example to describe a set of *computing* nodes or *storage* nodes ; e) it must be possible to express the composition of virtual network topology, detailing each virtual link. On the other hand, parameters should enable an abstract description, for example, informing a virtual link description that must be used to interconnect a group of resources ; f) the executing timeline of the infrastructure (this parameter should help in resources reservation and co-scheduling) ; g) security attributes for each resource element (access control, confidentiality level) ; h) commercial attributes for each resource element (maximum cost) ; and i) temporal attributes for each resource element (time window for provisioning).

Within a given time slot, a VPXI can be formally represented as a graph— $G(V, E)$ —where  $V$  is a set of vertices and  $E$  represents a set of edges. A vertex is in charge of active data processing functions and an edge is in charge of moving data between vertices. Figure 2 illustrates this concept, representing a virtual infrastructure composed by the aggregation of virtual machines interconnected via virtual channels. It shows two VXRouters (vertices  $r_v A$  and  $r_v B$ ) which are used to interconnect and perform the network control functions among the other virtual resources (vertices  $r_v 1$  to 8). These virtual routers can independently forward the traffic of the different virtual infrastructures sharing the same physical network. Each edge represents a virtual link used to interconnect a pair of virtual resources, which contains different configurations, as  $l_v 1$  and  $l_v 2$ . Note that at the next time slot, the configuration may be different.

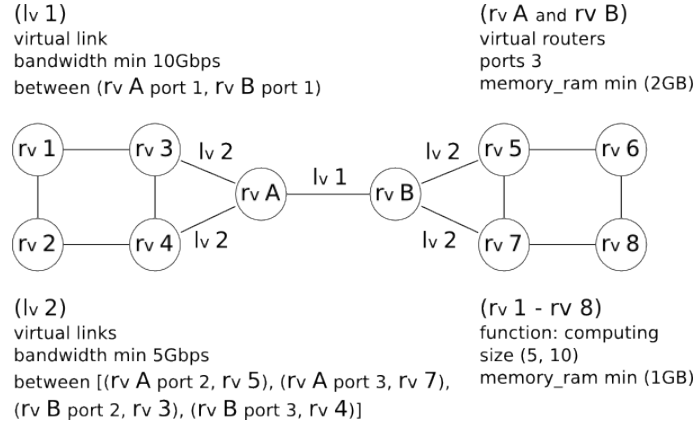

FIG. 2 – Example of a VPXI composition using graph notation.

To specify a virtual execution infrastructure we introduce VXDL (Virtual Resources and Interconnection Networks Description Language), a language that besides allowing end-resource description lets users describe the desired virtual network topology (using the same grammar), including virtual routers and timeline representation<sup>2</sup>. Implemented with the XML standard, VXDL helps users and applications to create or change VPXI specifications. The VXDL grammar is divided into *Virtual Resources description*, *Virtual Network Topology description* and *Virtual Timeline description* [16]. A new key aspect of this language is that all these basic descriptions are optional : it is possible to specify a simple communication infrastructure, or a simple end-ressource aggregate.

### 3.2 Virtual resources description

The key point explored in this part of the VXDL grammar is enabling users and applications to describe in a simple and objective way all the necessary end hosts, and groups of them. The parameters proposed in VXDL are directly related to virtual infrastructures, and besides allowing basic resource parameterization (e.g., maximum and minimum values acceptable to RAM memory and CPU frequency), VXDL lets users directly interact with management frameworks (such as HIPerNET). For this reason, VXDL suggests the definition of parameters such as *anchor*, *number of virtual machines allocated per physical host*, and *key components*.

The *anchor* parameters act in the physical allocation of a VPXI. We know that in a virtualized substrate the VPXI can be allocated anywhere, but sometimes it is necessary that a virtual end host (or group) must be positioned in a physical location (e.g., a site or a machine—URL, IP) in accordance with a basic location. Yet, analyzing a virtualized substrate, multiple virtual machines can be allocated in the same physical host, sharing the real resources among them. VXDL enables the definition of a maximum number of virtual machines that must be allocated in a physical host, enabling users to interact directly with the allocation algorithm. The *key* parameter acts in the identification of

<sup>2</sup>More information about VXDL is provided on <http://www.ens-lyon.fr/LIP/RESO/Software/vxdl>

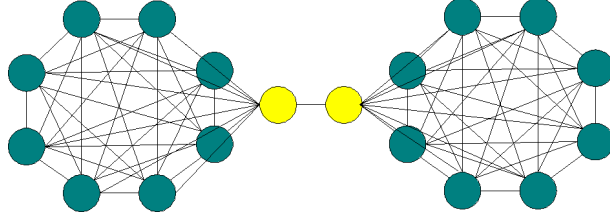

FIG. 3 – A graph representing a network topology.

the most important components of the VPXI. This information will help in the allocation, informing that the component must be allocated in advance.

### 3.3 Virtual network topology description

VXDL improves the network topology description in two key points : I) enabling the specification together with other components, using the same grammar ; II) applying the concept of link organization, which permits a simple and abstract description. Links can define connections between end hosts, between end hosts and groups, inside groups, between groups and VXRouter, and between VXRouter. Using this concept users can model their VPXIs in accordance with their applications. Figure 3 presents a possible VPXI composed by two groups (clusters), each with 8 nodes interconnected using 2 VXRouter.

In VXDL grammar, the definition of *source-destination pairs* for each link is proposed. A single link can be applied to different pairs, simplifying the specification of complex infrastructures. For example, links used to interconnect a homogeneous group, such as a cluster, can all be defined in a same link description. Each link can receive a parameterization involving latency, bandwidth and direction. To latency and bandwidth, the maximum and minimum values are applied.

### 3.4 Virtual timeline description

Any VPXI can be permanent, semi-permanent or temporary. The VPXIs are allocated for defined lifetime in time slots. Time slots are configurable parameters and are specific to the HIPerSpace. Often the VPXI components are not used simultaneously or all along the VPXI's lifetime. Thus, the specification of an internal timeline for each VPXI can help the middleware in the allocation, scheduling and provisioning processes. Periods can be defined in function of their usages, as data transfer or computation, delimited by temporal marks. A period can start after the end of another period or after an event. Looking at figure 4 we can observe three execution stages of an application. This VPXI is composed by one data storage cluster, three computation clusters and one visualization cluster, all interconnected through virtual links. In stage I, it is necessary to perform a data transfer between the storage cluster and the computation clusters. During this transfer, a high-bandwidth configuration is required, which is not necessary in the others stages. As early as in stage II, the three computation clusters execute an application, possibly requesting links with a low latency in communication to the substrate framework. Finally, stage III asks for a high bandwidth again to perform the data transfer and results visualization. In this

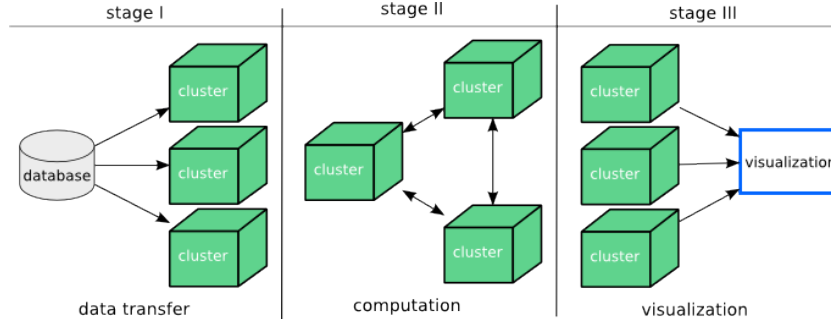

FIG. 4 – Example of a virtual timeline definition.

example, the periods between stages I and II or stages II and III can be defined in a relative way : after the data transfer, in stage II, computation starts and the low latency on the intra-cluster links is implemented. VXDL explores the relative definitions using common parameters as *start*, *after* and *until*.

## 4 Deployment and provisioning of VPXIs

In a typical scenario, HIPerNET receives a user’s VPXI request, specified in VXDL. The software interprets it, then checks its feasibility and potentially negotiates security, performance, planning and price with the customer or its representative. When an agreement has been found, a VPXI instance is allocated and scheduled as proposed in [20]. The VPXI is then provisionned according to the schedule. Finally, the deployment of a VPXI consists in instantiating and configuring the specified virtual entities (VXNodes, VXRouters and VXLlinks) on top of the physical substrate. First, all the virtual nodes (end hosts and routers) are deployed, then the virtual links and routes are set up. Routes are configured individually in all the VXNodes and VXRouters. During the VPXI’s lifetime, its allocation may change as described in section 3.4. In this case, if the topology changes, new VXLlinks are deployed if necessary and the routes are reconfigured in all the VXNodes and VXRouters to reconnect the topology. Below, we describe the mechanisms that are deployed to virtualize the network resources.

### 4.1 VPXI network resource provisioning

Virtual infrastructures share a physical substrate network. To ensure VPXI isolation, the resource sharing between different virtual infrastructures needs to be finely controlled. To achieve this, a set of control mechanisms residing inside the physical substrate nodes are set up. They are in charge of supervising, at runtime, how the physical capacity is allocated to the virtual nodes and links. After the VPXI allocation and scheduling process, virtual capacities are assigned to each virtual node and link. Then, these capacities are reserved and provisionned in the physical substrate. During the deployment phase, the control tools are invoked at each involved substrate node, in order to enforce allocations during the VPXI lifetime. At runtime, the control tool’s actions can

be reconfigured when the VPXI's requirements change. This happens for example when the execution moves from one stage to the next. At that moment, HIPerNET updates the configuration of the deployment according to the allocation corresponding to the new stage. Thus, it reconfigures the control tools, in order to change the resource attribution. The control tools have three main features : they manage the bandwidth, CPU and memory sharing among the virtual domains, so that they offer the user provisionned VPXIs according to his requirements.

During the negotiation, a VPXI user can specify a desired bandwidth per virtual link, associated to one of the following services :

- **Guaranteed minimum** : the minimum rate that has to be available on the virtual link at any moment ;
- **Allowed maximum** : the maximum capacity the virtual link must allow at any moment ;
- **Static reservation** : in this case, the guaranteed minimum is equal to the allowed maximum.

The user can use one of these services to specify its application's requirements. A user who wants to execute, for example, a distributed application communicating with MPI will specify a guaranteed minimum rate which can not be decreased during negotiation. If the user specifies an allowed maximum, the negotiation will result in a bandwidth equal or below this maximum. This link is shared in a best-effort way with other traffic. Specifying a static rate gives the user the impression that he works in a dedicated physical network whose links have the specified capacity. He will be able to obtain the specified bandwidth at any moment but can never exceed it. This kind of service allows no negotiation and could for example help with conducting reproducible experiments where link availability should not vary.

According to these user specifications and the free capacity on the physical substrate, a static bandwidth reservation is made. Then, HIPerNET's control mechanism allocates the maximum bandwidth for each virtual link in order to guarantee the negotiated bandwidth. The configuration takes place on both ends of the virtual link configuring the physical interfaces.

Let's consider two users of two VPXIs who specified different rates for the different virtual links. The user of VPXI 1 desires a bandwidth of 100 Mb/s on virtual link A (VL A) and a bandwidth of 200 Mb/s on VL B connected to VXRrouter (VXR) 1. The user of VPXI 2 wants both virtual links connected to VXRrouter 2, VL C and VL D, to allow 400 Mb/s. Figure 5 shows the specified virtual network configurations of VPXI 1 and VPXI 2. HIPerNET configures the virtual link rates to these values during the deployment of VPXI 1 and VPXI 2.

Users can also specify a maximum percentage of the physical CPU a virtual node of a VPXI should be allowed to use. This quantity of CPU is allocated in the available CPU of the physical machine. The available quantity of CPU corresponds to the CPU of the physical machine minus the part of the CPU in use for the machine's host system, or domain 0 (dom0) in the Xen terminology.

$$CPU_{available} = CPU_{machine} - CPU_{dom0}$$

Dom0 consumes a small part of CPU time for the control mechanisms and a considerable part for networking as it is in charge of forwarding the packets of all the virtual machines, or domains U (domUs).

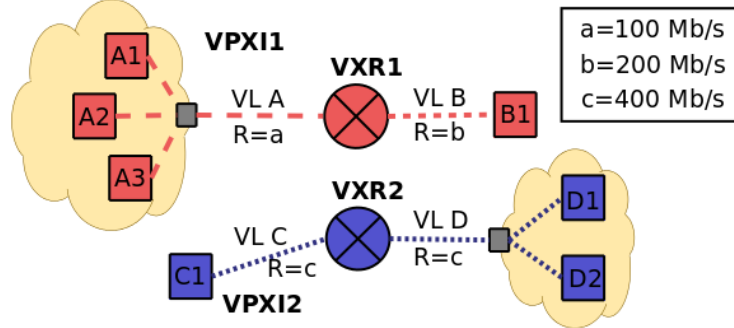

FIG. 5 – User bandwidth specification for two VPXIs.

$CPU_{dom0} = CPU_{control} + CPU_{networking}$  and  $CPU_{control} \ll CPU_{networking}$   
 So  $CPU_{dom0}$  can be established according to the sum of the maximum rates specified by all the domUs hosted on the considered physical machine. In Section 6.3, this relationship is evaluated on virtual routers.

The next section gives more details on the VXRouter.

## 4.2 Implementation of VXRouter

In the current HIPerNET implementation, the VXRouter consist in software routers implemented inside virtual machines. These VXRouter are hosted by network-aware servers. We call them *HPSRouters* (High Performance Software routers) as they are commodity servers with the required hardware to support high-performance networking (several network interface cards, several CPUs and a huge amount of memory) used as Linux routers. Current commercial virtual or logical routers do not support the full virtualization of the router data planes. The performance impact of the data-plane virtualization is indeed an issue. However, recent analysis have demonstrated that modern virtualization techniques are improving rapidly, making our VXRouter approach interesting and promising [21]. Figure 6 shows an example of a physical router hosting two VXRouter. These virtual routers have to share the physical resources of the machine and additional processing is necessary.

Customized routing and traffic-engineering functions can be set up on the VXRouter. A VPXI user can, for example, choose to adapt the routing in order to satisfy specific Quality of Service requirements, as illustrated in Figure 7.

In this example, latency-sensitive traffic and bandwidth-aware traffic are routed on different paths. 1 Gb/s links are allocated between each one of the three VXRouter to transmit latency sensitive traffic. All high-throughput traffic, which can be pipelined, is redirected over Site 2. The advantage of this routing scheme is that the user needs to provision only 2 links with 5 Gb/s instead of 3. As presented in [22], this is an example of efficient channel provisioning combining routing and traffic engineering.



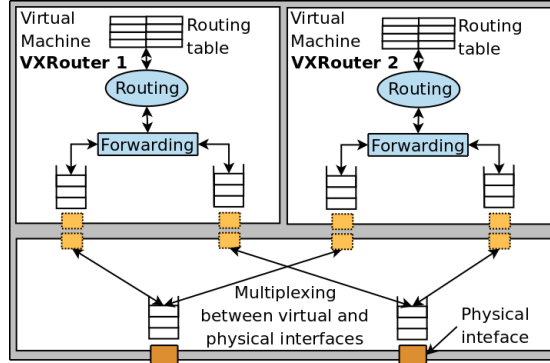

FIG. 6 – Model of a physical router hosting VX Routers.

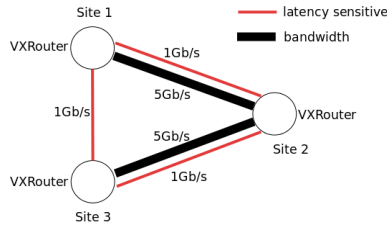

FIG. 7 – Example of bandwidth allocation for latency-sensitive and high-bandwidth flows.

## 5 Executing distributed applications on virtualized infrastructures

Programming applications on large-scale distributed environments is difficult. Defining the optimal infrastructure to execute them is another issue. The flexibility offered by virtual infrastructures could make the problem even more complex. Promising work on workflow has been done in the area of application development to optimize their usage of distributed environments. We propose to explore how this work can also benefit to the composition of virtual infrastructures.

In our model, the application-mapping process is separated in three steps :

*I) workflow generation* : the workflow is generated using information extracted from the application, such as benchmarks results, data input description, data transfer in each module, and the number of nodes required to perform a satisfactory execution.

*II) workflow translation into VXDL* : taking into account the application's requirements (RAM configuration, CPU speed, and storage size), users can develop a VXDL description, asking for the desirable configuration of the VPXI. At this point users can also declare that some components must be allocated in a specific location as well as define the virtual network topology specifying the proximity (latency configuration) of the components and the needed bandwidth.

*III) VPXI allocation* : in this step VPXI management framework will allocate the virtual components respecting the configuration expressed by the user

(such as parametrizations and time periods organization). In a second phase, the software configuration (OS, programming and communication tools), extracted directly from the application and described using VXDL, will be deployed within the virtual machines that compose the VPXI.

## 5.1 Workflow language

Complex applications able to exploit large scale distributed environments are generally described with workflows. These workflows are interpreted by engines that convert the description of work in execution scripts. Several workflow languages have been proposed in the literature. On grid-based infrastructures, Directed Acyclic Graph (DAG)-based languages such as the MA-DAG language, part of the DIET middleware [11], have often been used. They provide an explicit, static graph of all computing tasks to be performed. To ease definition of grid applications with a complex logic to be represented, more abstract languages have been introduced. For instance, Scuff was introduced within the myGrid project<sup>3</sup> to present data flows enacted through the Taverna workflow engine [23]. It is one of the first grid-oriented data flow languages that focuses on the application data flow rather than on the generated graph of tasks. The *GWENDIA* language<sup>4</sup> considered in this paper is a data-flow oriented language that aims at easing the description of the complex application data flows from a user point of view while ensuring good application performances and grid resources usage. An example of a graphic representation of workflow description is given in figure 8. In this figure *Floating* and *Reference* are representing data unit to be processed and *CrestLines*, *CrestMatch*, *PFMatchICP*, *PFRegister*, *Yasmina* and *Baladin* are processing units. *Floating* and *Reference* represent groups of data items to be processed : processing units will be invoked as many times as needed to process all data items received. The user describing the application focuses on the data processing logic rather than on the execution schedule. The structural application workflow is transformed into an execution schedule dynamically, while the workflow engine is being executed.

GWENDIA is represented in XML using the tags and syntax defined below :

**Types :** values flowing through the workflow are typed. Basic types are `integer`, `double`, `string` and `file`.

**Processors :** a `processor` is a data production unit. A regular processor invokes a service through a known interface. Special processors are workflow `input` (a processor with no inbound connectivity, delivering a list of externally defined data values), `sink` (a processor with no outbound connectivity, receiving some workflow output) and `constant` (a processor delivering a single, constant value).

**Processor ports :** processor input and output ports are named and declared. A port may be an input (`<in>` tag), an output (`<out>` tag) or both an input/output value (`<inout>` tag). The input ports also define iteration strategies that control the number of invocation of the processor as a function of its inputs.

**Data link :** a data link is a simple connection between a processor output port and a processor input port.

---

<sup>3</sup>myGrid UK e-Science project : [www.mygrid.org](http://www.mygrid.org)

<sup>4</sup>GWENDIA is defined in the context of the ANR-06-MDCA-009 GWENDIA project : <http://gwendia.polytech.unice.fr>

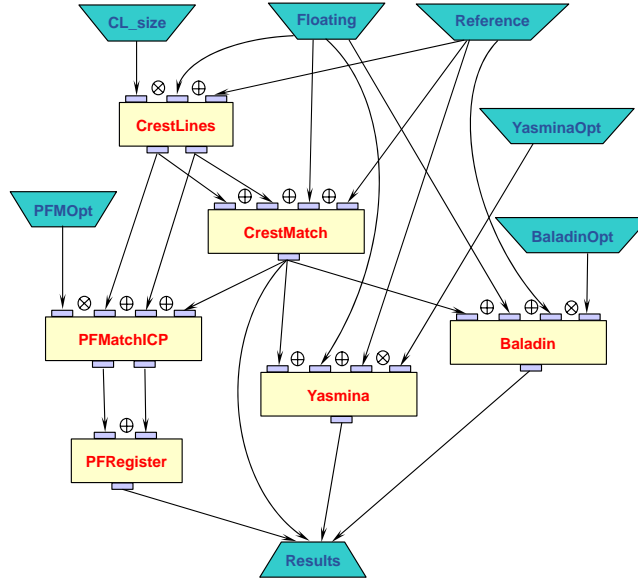

FIG. 8 – Bronze Standard workflow

Workflow managers are associated with these workflow language and are in charge of optimizing the execution of workflows. For example, MOTEUR [24] is a data-intensive grid-interfaced workflow manager. MOTEUR can enact a workflow represented in Scuff language or in GWENDIA language and submits the workflow tasks to a grid infrastructure. To optimize the execution, it enables three levels of parallelism : workflow parallelism, data parallelism and pipelining.

## 5.2 Workflow translation into VXDL

A workflow description represents the input/output data, the processors (a data-processing module), and the relationship between an application's processors. In our model, the workflow description will be translated in a VPXI description, specified in VXDL. Generally, to execute a complex application in a virtualized infrastructure, one has to consider that a middleware has to supervise the execution of the different tasks. In our example, the workflow engine (MOTEUR) and a specific task scheduler are executed for every application on independent computing resources. Input data and the intermediate results also require the presence of a file server. Therefore the VXDL description of any VPXI executing an application controlled by the MOTEUR engine will contain a *generic* part describing these 3 nodes.

The *variable* part of the VPXI description directly depends on the information extracted from the workflow such as input data, the number of processors, and the links between the processors. The computation time, the data volume and the number of invocations of each module is another information that can be extracted from the workflow. Given  $p$  the number of processors (modules) of an application, the user can naively request  $n$  virtual computing resource and evenly split the set of resources among the workflow processors. Each module therefore has  $n/p$  resources. This will of course be sub-optimal since the proces-

sors have different execution times. A first variant of this naive strategy could take into account extra information on the benchmarked execution time of each module.

### 5.3 Medical application example

Let us illustrate this VPXI description and embedding problem through a complex, real-scale medical-image analysis application known as *bronze standard*.

The bronze standard [25] technique tackles the difficult problem of validating procedures for medical-image analysis. As there is usually no reference, or *gold standard*, to validate the result of the computation in the field of medical-image processing, it is very difficult to objectively assess the results' quality. The statistical analysis of images enables the quantitative measurement of computation errors. The bronze standard technique statistically quantifies the maximal error resulting from widely used *image registration algorithms*. The larger the sample image database and the number of registration algorithms to compare with, the most accurate the method. This procedure is therefore very scalable and it requires to compose a complex application workflow including different registration-computation services with data transfer inter-dependencies.

Bronze standard's workflow is enacted with the data-intensive grid-interfaced MOTEUR workflow manager [24] designed to optimize the execution of data-parallel flows. It submits the workflow tasks to the VPXI infrastructure through the DIET middleware [11], a scalable grid scheduler based on a hierarchy of agents communicating through CORBA.

The estimated algorithm performance is valid for a typical database image. In the experiments reported below, we use a clinical database of 32 pairs of patient images to be registered by the different algorithms involved in the workflow. For each run, the processing of the complete image database results in the generation of approximately 200 computing tasks. As illustrated in figure 8, the workflow of the application has a completely deterministic pattern. All processors of this application have the same number of invocations. The execution time and the data volume transferred of each processor have been measured in initial microbenchmarks reported in table 1.

Module	Execution time	Data volume
CrestLines	35s	32MB
CrestMatch	4s	36MB
PFMatchICP	14s	10MB
PFRegister	1s	0.5MB
Yasmina	62s	22MB
Baladin	250s	25MB

TAB. 1 – Execution time and processed data volume for each module of bronze standard.

Let us now consider a request for a VPXI composed of 35 nodes to execute Bronze Standard's workflow. Three nodes will be dedicated to the *generic* part : 1 node for MOTEUR, 1 node for the middleware server and 1 node for the database server. The 32 nodes left are distributed and allocated proportionally

to the execution time of the workflow processors : 3 nodes for CrestLines, 1 node for CrestMatch, 1 node for PFMatchIP, 1 node for PFRegister, 22 nodes for Baladin, and 4 nodes for Yasmina. Then, for this same computing-resources set, several variants of VPXI descriptions with different network topologies can be expressed. We exemplify developing two different VPXI descriptions. The listing below presents a VXD description of a virtual node (MOTEUR) and a computing cluster (Baladin).

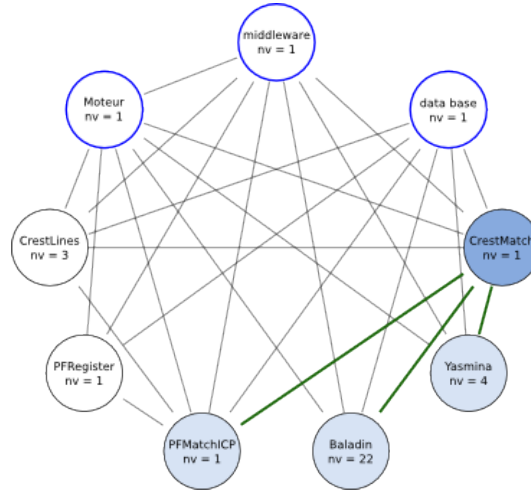

FIG. 9 – VPXI description of the bronze standard's workflow.

Figure 9 illustrates the description of a VPXI using graphs. All components and network links required to execute bronze standard's workflow are represented. We developed two descriptions considering this scenario : in **VPXI 1** the network is composed by two links type, one with low latency intra cluster and the other one with a maximum latency of 10 ms to interconnect the clusters. In **VPXI 2** the network comprises three virtual links : one with a low intra-cluster latency (maximum latency of 0.200 ms), another one with a latency of 10 ms interconnecting the components except one asking for a maximum latency of 0.200 ms to interconnect CrestMatch (dark blue) with the components PFMatchICP, Yasmina and Baladin (blue in the figure).

Let us now illustrate how each VPXI description can be embedded in a physical substrate. We propose two different solutions for both VPXI, which correspond to four different physical allocations as represented in figure 10. In this example, *Site 1* and *Site 2* represent two geographically-distributed-resources sets.

In **VPXI 1 - Allocation I**, intra-cluster link specification enables the allocation of loosely connected resources. In this embedding solution, 1 virtual machine per each physical node is allocated.

In **VPXI 1 - Allocation II** each physical node in clusters CrestMatch, PFRegister, Yasmina, and Baladin are allocated 2 virtual machines.

The **VPXI 2 - Allocation III** respects the required interconnection allocating corresponding resources in the same physical set of resources (such as

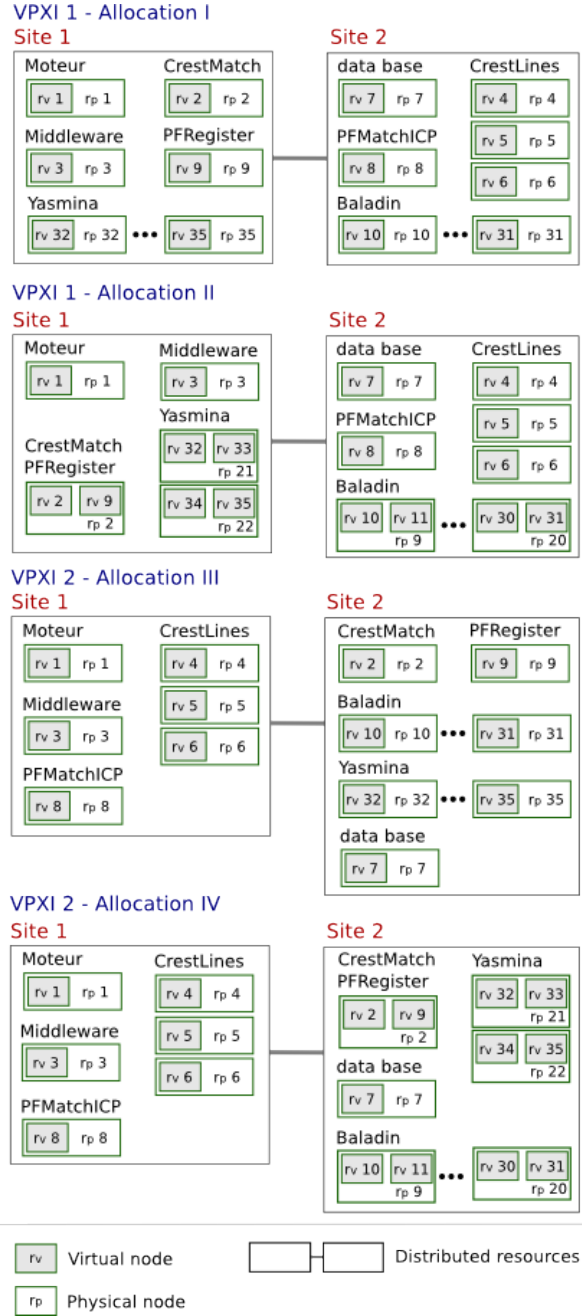

FIG. 10 – Allocations of descriptions VPXI-1 and VPXI-2.

a site in a grid). This embedding solution explores the allocation of 1 virtual machine per physical node.

**VPXI 2 - Allocation IV** explores the same physical components as *Allocation III* but allocates 2 virtual machines per physical node in the CrestMatch, PFRRegister, Yasmina, and Baladin clusters.

## 6 Experiments

This section presents experimental results of the current implementation of network virtualisation in HIPerNET. Rate control for bandwidth provisioning, performance isolation and the CPU cost of bandwidth are investigated. To instantiate virtual end hosts and virtual routers, we chose to use the Xen [6] technology because of the offered flexibility : distinct operating systems with distinct kernels can run in each virtual machine and the user is provided with full configurability to implement individual virtual networks. All the experiments are executed within the Grid'5000 [26] platform, using Xen 3.2 and IBM Opteron servers with one 1 Gb/s physical interface. The machines have two CPUs (one core each).

### 6.1 Context : Adaptation to Grid'5000

The HIPerNET software is currently being adapted to Grid'5000 [26], the national experimental shared facility, to enable reproducible experiments on customizable topologies. Figure 11 represents the Grid'5000 testbed with its nine

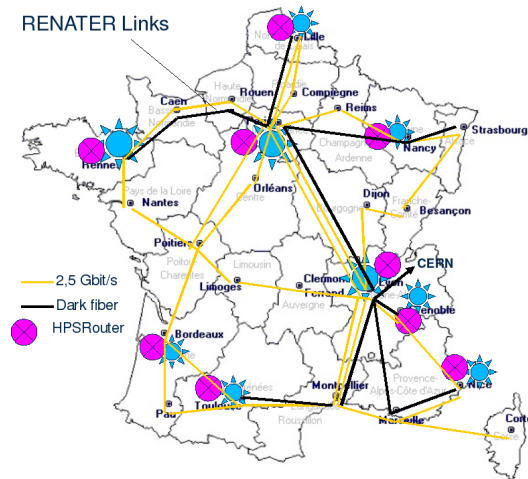

FIG. 11 – Grid'5000 infrastructure with HPSRouters.

sites interconnected with 10 Gb/s dedicated lambdas. An HPSRouter is inserted on each site. These machines host VPXI's VPXRouters to support diverse routing strategies and innovative transport protocols. Another goal is to control the bandwidth-sharing of the physical inter-site links for isolated, controlled, and reproducible experiments. VPXIs can be reserved and deployed over several geographically distributed sites. Figure 12 represents an example of three VPXIs, extended over three distinct sites. Each site is provided with a HPSRouter hosting one VPXRouter per VPXI. Those virtual routers are gateways, forwarding all the traffic of a VPXI between the site's LAN and the interconnection network. With this model, the VPXRouters are able to control the traffic of the VPXIs and their bandwidth sharing of the physical links over the backbone network. The VPXRouters are interconnected over the backbone across several hops via IP-tunnels giving the VPXI user the illusion that the different parts of

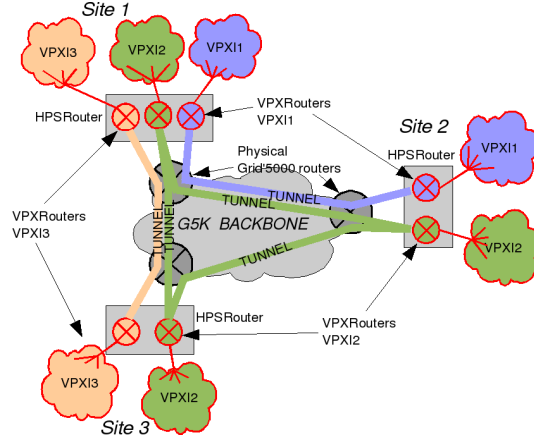

FIG. 12 – Allocation of 3 VPXIs in the Grid'5000 infrastructure.

his VPXI are directly interconnected by a single router, even though they are in reality located on distant physical locations.

To face scalability issues, we assume that at a given time, only a limited number of experiments will request for a confined VPXI and a dedicated channel (for example, 10%=1 Gb/s). The others, which are considered not "communication sensitive", will run without any network control in the classical and fully-transparent best effort mode. The aggregated bandwidth allocated to the VPXI is limited to a configurable percentage of the access link's capacity. The shaped VPXI-traffic leaving the physical routers hosting the VPXRouters is fully isolated from the remaining best-effort traffic of Grid'5000. To guarantee this, the switch where the VPXRouter-traffic and the Grid'5000 best-effort traffic come together distinguishes the two traffics and gives a strict priority to the VPXRouter-traffic. The background traffic, i.e. all the traffic that does not require specific treatment, is forwarded through the classical best effort path.

## 6.2 Rate control and performance isolation experiment

The goal of this experiment is to evaluate the isolation between VXRouters when their are mapped on the same physical router.

### 6.2.1 Experimental setup

Two VXRouters called VXR1 and VXR2 share one physical machine to forward the traffic of two VPXIs (VPXI 1 and VPXI 2). Each virtual router has two virtual interfaces connected to two virtual links as represented on Figure 13. These links are configured to allow a maximum bandwidth  $R$  of respectively  $R_{VLA} = R_{VLB} = 150Mb/s$  and  $R_{VLC} = R_{VLD} = 300Mb/s$ . Figure 13 represents this setup.

Three cases of user traffic can be distinguished by

1. *in-profile* traffic : the sum of the traffic on virtual link X is smaller than the allowed maximum rate  $R_{VLX}$  ;
2. *limit* traffic : the sum of the traffic on virtual link X is equal to the allowed maximum rate ;



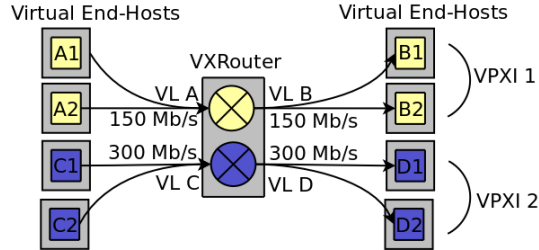

FIG. 13 – Experimental setup with 2 VPXIs with different bandwidth requirements.

3. *out-of-profile* traffic : the sum of the traffic on virtual link X exceeds the allowed maximum rate.

This experiment aims at determining if the traffic-control techniques limit the traffic to the desired rate and if isolation is guaranteed. Isolation means that limit or out-of-profile traffic should have no impact on the available bandwidth on the physical link, and thus none on the available bandwidth of concurrent virtual links.

Table 2 lists four testcases to validate our implementation. In this experiment, we suppose a congestion factor (CF) of 0.8 for *in-profile* traffic which means that traffic is sent at 80% of the maximum allowed speed. *Limit* traffic has a CF of 1 and for *out-of-profile* traffic, a CF of 1.2 is chosen.

	VPXI 1	VPXI 2
Case 1	in profile	in profile
Case 2	limit	limit
Case 3	in profile	limit
Case 4	in profile	out of profile

TAB. 2 – User traffic for different test cases.

One flow is sent from virtual end hosts  $A_i$  and  $C_i$  to the corresponding virtual end hosts  $B_i$  and  $D_i$ , respectively. The flows are sent in the different cases so that their sum on each VXRouter corresponds to the profile specified in Table 2.

### 6.2.2 Results

The results of these experiments show that the desired rate on each virtual link can be obtained with our configuration and that *out-of-profile* traffic does not impact other traffic sharing the same physical link.

In case 1, where all the traffic is *in profile*, requiring less bandwidth than allowed, each flow gets its desired bandwidth and no packet loss is detected with UDP. For case 2, the flows try to get 100% of the maximum available bandwidth. This causes some sporadic packet losses which cause some instantaneous throughput decreases in TCP as illustrated in Figure 14. The overall throughput still reaches the allowed maximum value.

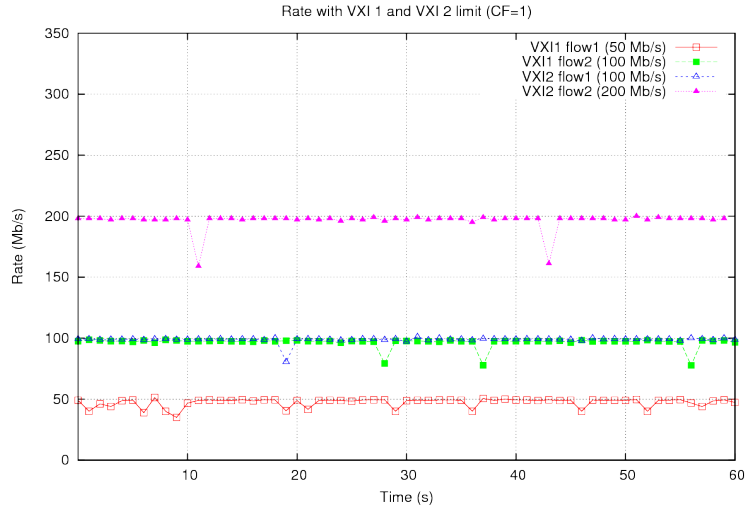

FIG. 14 – Test case 2 : TCP Rate with VPXI 1 and 2 being at the *limit* rate (with a congestion factor(CF) of 1).

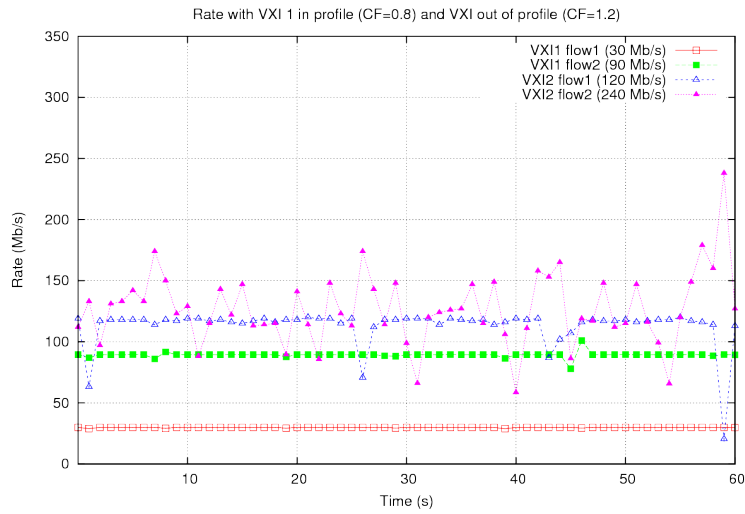

FIG. 15 – Test case 4 : TCP Rate with VPXI 1 being *in profile* and VPXI 2 out of profile (with a congestion factor(CF) of 1.2).

Figures 15 and 16 show respectively the results with TCP and UDP flows in testcase 4 where the two flows of VPXI 1 are in profile, their sum  $30 + 90 = 120\text{Mb/s}$  does not exceed the maximum allowed value of  $150\text{Mb/s}$ . With TCP and UDP, both flows attempt their desired rate and with UDP, no loss is detected. The two flows of VPXI 2 try to exceed the allowed value of  $300\text{Mb/s}$  by sending at  $120 + 240 = 360\text{Mb/s}$ . As a result, they see some of their packets dropped at the incoming interface of the physical router. TCP reacts in a sensitive way to this packet drop. It tries to share the available bandwidth by

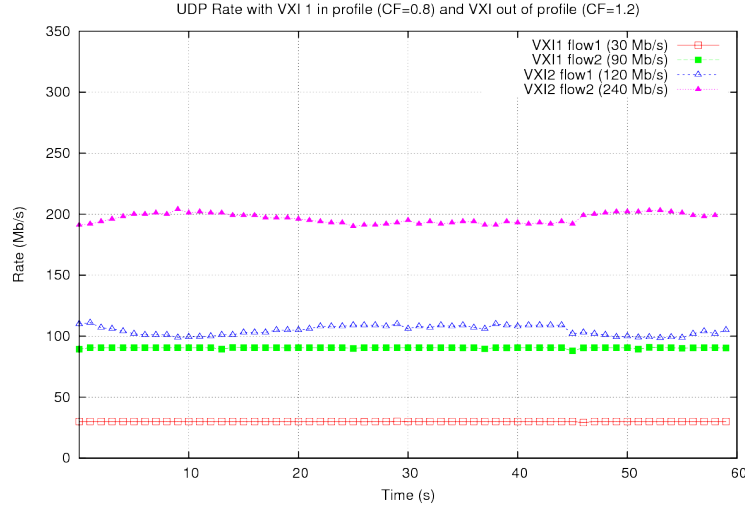

FIG. 16 – Test case 4 : UDP Rate with VPXI 1 being *in profile* and VPXI 2 *out of profile* (with a congestion factor(CF) of 1.2).

the two flows. So flow 1 gets generally the 120Mb/s as it is less than half of the available 300Mb/s. Flow 2 requiring 240Mb/s varies a lot to get also an average throughput of about half of the 300Mb/s.

With UDP (Figure 16), the packet drop of the flows of VPXI 2 causes a regular decrease of the bandwidth. Flow 1 loses an average 13% of its packets and flow 2 an average of 18% of its packets. The average of these two values is slightly smaller than the percentage of exceeding packets ( $1 - (1/1.2) = 16.6\%$ ) implied by the congestion factor of 1.2.

These results show that only flows which try to exceed the fixed limit bandwidth are penalized in this configuration. *In profile* and even *limit* flows are not impacted. In this way, individual rate sharing is efficient in this model and isolation is guaranteed.

### 6.3 CPU cost of bandwidth

To find out how much CPU is needed to forward flows in domain U, making use of data-plane virtualization, and how this value depends on the forwarding rate, this experiment measures the CPU usage of Xen during forwarding on VXRouter with different rates. This experiment is executed with 1, 2 and 4 concurrent VXRouter on a single physical router, each one forwarding a single UDP flow with different rates. The rate of each flow is incremented every 60 seconds so that the aggregate rate on the set of virtual routers increments by 10 Mb/s. During each interval, the CPU use of the physical router is measured with the `xentop` tool. Figure 17 shows the CPU utilization of dom0 of the physical router in the different cases. It increases with the increasing aggregate forwarding rate in the VXRouter. Surprisingly, this overhead does not significantly vary with different numbers of VXRouter. It is even almost identical when 2, 4 or 8 VXRouter are forwarding simultaneously flows.

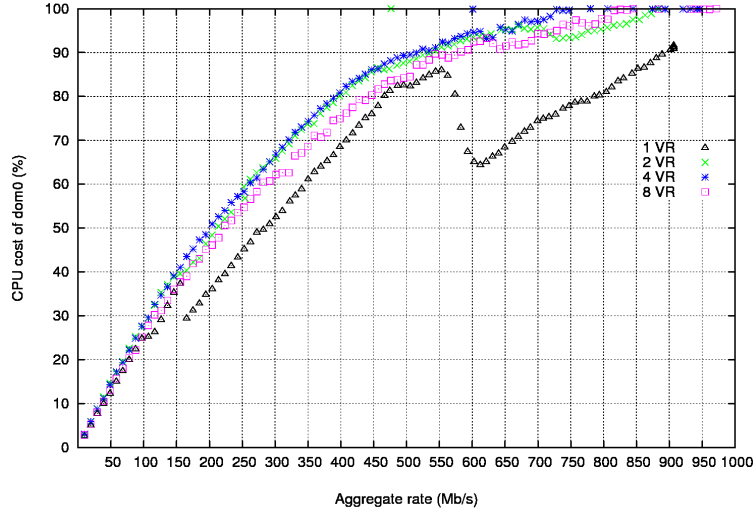

FIG. 17 – Dom0 CPU use with 1, 2, 4 or 8 concurrent VXRouter forwarding UDP flows.

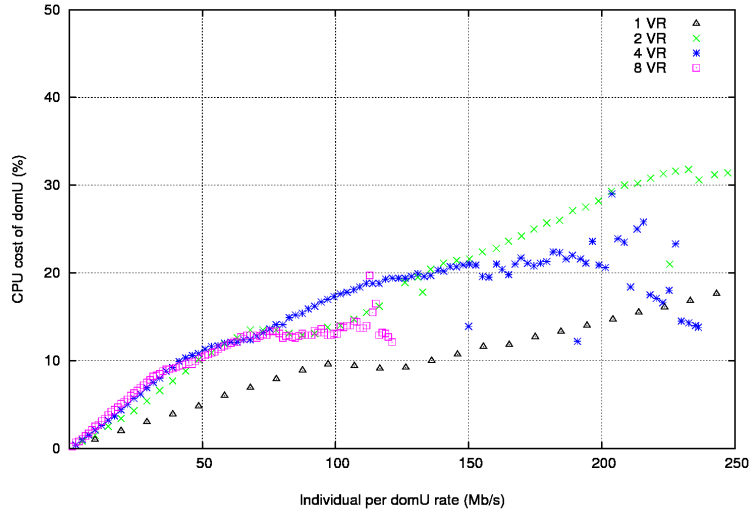

FIG. 18 – DomU CPU use with 1, 2, 4 or 8 concurrent VXRouter forwarding UDP flows.

The corresponding CPU utilization of a domU during the same experiments is represented on Figure 18. The overhead increases with the forwarding rate, but in the case of dom0, it does not increase with the number of concurrent VXRouter. Only the cost of a single VXRouter represents an exception.

This means that the CPU cost of a physical router hosting VXRouter depends strictly on the aggregate forwarding rate and not on the number of VXRouter it hosts.

## 6.4 Medical imaging application deployment on the testbed

For testing VPXIs, a system image containing the operating system based on a standard Linux distribution Debian *Etch* with a kernel version 2.6.18-8 for *AMD64*, the domain-specific image processing services and the middleware components (MOTEUR and DIET) was created. The experiments on the VPXIs described in the section 5.3 were performed. In each experiment, we repeated the application 10 times to measure the average and standard deviation of the application makespan, the data transfer and task execution time. The physical infrastructure is reserved on the Grid'5000 clusters : *capricorne* (Lyon), *bordemer* (Bordeaux) and *azur* (Sophia) which CPUs are 2.0 GHz dual-cores Opterons. The distance between clusters is 500km and they are connected through 10Gbps links. Each VPXI is composed of 35 nodes divided in *generic* and *variable* part : 3 nodes are dedicated to *generic* part (MOTEUR, DIET, file server) using 1 CPU per node and the remaining 32 nodes of the *variable* part are allocated dependently on the VPXIs (*VPXI 1 - Allocation I* and *VPXI 2 - Allocation III* used 1 CPU per node while *VPXI 1 - Allocation II* and *VPXI 2 - Allocation IV* used 1 CPU core per node).

**Coallocating resources on one grid site :** the application's makespan on the *VPXI 2 - Allocation III* and *VPXI 2 - Allocation IV* is 11min 44s ( $\pm 49$ s) and 12min 3s ( $\pm 50$ s) respectively. This corresponds to a +3.8% makespan increase, due to the execution overhead when there are two virtual machines collocated on the same physical resource. Indeed, we present in the table 3 the average execution time of application services on the *VPXI 2 - Allocations III and IV*. We can observe that the average execution overhead is 5.17% (10.53% in the worst case and 1.28% in the best case).

Services	Allocation III	Allocation IV	variation
CrestLines	34.12 $\pm$ 0.34	36.84 $\pm$ 5.78	+7.97%
CrestMatch	3.61 $\pm$ 0.48	3.99 $\pm$ 0.63	+10.53%
PFMatchICP	11.93 $\pm$ 2.76	12.75 $\pm$ 5.35	+6.87%
PFRegister	0.78 $\pm$ 0.18	0.79 $\pm$ 0.18	+1.28%
Yasmina	59.72 $\pm$ 14.08	61.53 $\pm$ 13.98	+3.03%
Baladin	244.68 $\pm$ 16.68	247.99 $\pm$ 19.51	+1.35%

TAB. 3 – Execution time on VPXI 2 - Allocations III and IV

**Resources distributed over 2 sites :** when porting the application from a local infrastructure to a large scale infrastructure, the data transfer increases. Table 4 presents the data transfer time (s) of the application services on *VPXI 2 - Allocation IV* (local) and *VPXI 1 - Allocation II* (distributed over 2 sites). The measured overhead is 150% in the worst case. Conversely, some local transfers may be slightly reduced. In the case of our application however, this overhead has little impact on the application makespan since it is compensated for by the parallel data transfer and computations. Indeed, the makespan is 12min ( $\pm 12$ s) and 12min 11s ( $\pm 20$ s) on *VPXI 1 - Allocation I* and *VPXI 1 - Allocation II* respectively, very similar to the performance of *VPXI 2 - Allocation IV*.

**Resources distributed over 3 sites :** further distributing computational resources causes an additional increase of the data-transfer overheads. An additional experiment with *VPXI 1 - Allocation II* the *generic* part of which is

Services	Allocation IV	Allocation II	variation
CrestLines	$2 \pm 0.45$	$3.01 \pm 1.6$	+50.5%
CrestMatch	$1.99 \pm 0.34$	$1.83 \pm 0.36$	-8.04%
PFMatchICP	$1.3 \pm 0.4$	$3.25 \pm 0.13$	+150%
PFRegister	$0.51 \pm 0.23$	$0.43 \pm 0.09$	-15.69%
Yasmina	$1.19 \pm 0.27$	$1.16 \pm 0.21$	-2.52%
Baladin	$1.17 \pm 0.38$	$1.81 \pm 1.03$	+54.7%

TAB. 4 – Data transfer time on the local VPXI 2 - Allocation IV and large scale VPXI 1 - Allocation II infrastructure

located in Lyon while the *variable* part is randomly distributed in Lyon, Bordeaux and Sophia leads to a makespan of 12min 13s ( $\pm 30$ s) with a data-transfer overhead of 176% in the worst case.

## 7 Related work

Infrastructure virtualization is a hot topic studied in several projects [27, 28, 29]. In [27], the authors propose VINI, a virtual network infrastructure that allows several virtual networks to share a single physical infrastructure, similarly to HIPerNET. Researchers can run experiments in virtual network slices with XORP routing software, running inside UML instances. They can configure it and choose a protocol among the available ones. HIPerNET pushes this facility a step further adding data-plane virtualization and allowing users to chose the operating system and install any routing software. This also provides full isolation between virtual nodes and controlled resource sharing. VINI has dedicated IP address blocks, HIPerNET interposes a HIP-layer between the network and the application levels, that provides each resource with a unique identifier (HIT).

Trellis [30] is a network-hosting platform deployed on the VINI facility. Like HIPerNET, it is a virtual-network substrate that can run on commodity hardware. It is implemented using VServer’s [31] container-based virtualization because of its networking performance. For the reasons described before, we use the Xen hypervisor which has become promising in terms of its growing network performance in its recent versions.

VINI and Trellis are evaluated on PlanetLab [32] which provides users with slices of virtual ressources distributed among its overlay infrastructure. Those virtual resources are VServers providing generally end-host functionalities. In HIPerNET, we chose to integrate the resource "virtual router" too, allowing users to custom the routing. HIPerNET is evaluated in a confined large-scale experimental facility.

In the GENI design [28] the users are provided with slices like in VINI, but these slices are composed of resources which can be either virtual machines or just partitions of physical resources. GENI’s goal is to provide users with multiple shareable types of resources. The HIPerNET approach is compatible with GENI. Our goal in HIPerNET is to prove the concept by implementing it in a real testbed. The presented early results are promising

The idea to decouple services from the infrastructure with virtualization is also

described in CABO [29]. CABO's argument is to give Internet service providers end-to-end control while using the physical equipments of different physical-infrastructure providers. HIPerNET combines network virtualization with end-host virtualization to provide users with virtual computing infrastructures, interconnected by an end-to-end controlable virtual network.

The main difference between these projects and HIPerNET is that HIPerNET provides users with *full configurability*. HIPerNET gives users root access to the virtual nodes. This means that users can deploy any operating system they choose on the node, and so have full configuration ability. It is then always possible to restrict configurability features for unexperimented users.

Resource sharing in terms of bandwidth in virtual networks has been treated by DaVinci [33], a design and mathematical model of dynamic adaptation of virtual networks to their performance objectives. While DaVinci's design enables optimal physical-link utilization through monitoring, HIPerNET's implementation focuses on giving strong performance guarantees and isolation to users, avoiding interferences if a virtual-network user tries to exceed his allocated rate.

Previous research on virtual routers has concluded that they have lower performance with Xen's data-plane virtualization than with control-plane virtualization only [34]. But as HIPerNET focuses on full configurability including OS choice, Xen's data-plane virtualization meets its requirements. In particular, Xen's data-plane virtualization performance has already been growing with the successive versions, now achieving Linux-like throughput, at least for big packets [21]. Moreover, major promising network improvements are expected in the next version [35].

Current hardware solutions like Juniper's TX Matrix Plus routers<sup>5</sup> allow running up to 16 routing instances. By virtualizing the control-plane, they intend to offer a gain in routing capacity and reduce power consumption, a goal they share with server consolidation. Even though these routers do have very good performance, they are not as easily deployable at a very large scale and for experimentation purpose as VXRouters. They do not allow the same configuration facility.

An interesting approach using virtual routers is the ability to migrate them over the substrate, to meet the resource requirements at any moment and optimize the overall resource utilization. This concept is described in [36]. In combination with the HIPerNET framework, this type of dynamic allocation would allow optimal resource utilization in accordance with the user-defined specification and is also interesting for fault tolerancy. In addition to the migration, resource utilization on the links between the virtual routers can also be optimized by allocating a virtual path to multiple physical links as suggested in [37]. This allows allocating virtual links which require more capacity than is free on a single physical link. These extensions will be studied for integration in HIPerNET.

Existing commercial products, including Amazon's Elastic Compute Clouds (EC2)<sup>6</sup>, Enomaly's Elastic Computing Platform (ECP)<sup>7</sup> or GOGGRID<sup>8</sup>, like HIPerNET, allow users to reserve a set of resources, choose an OS and cus-

<sup>5</sup>[http://www.juniper.net/products\\_and\\_services/t\\_series\\_core\\_platforms/index.html](http://www.juniper.net/products_and_services/t_series_core_platforms/index.html)

<sup>6</sup><http://aws.amazon.com/ec2>

<sup>7</sup><http://www.enomaly.com>

<sup>8</sup><http://www.gogrid.com>

tomize it. Others are less configurable, like 3tera's AppLogic<sup>9</sup> which has no OS choice and b-hive<sup>10</sup> which is data-center oriented. All these clouds middlewares are suitable to perform computation or storage and are not intended to host virtual routers, as no special physical routing machines exist to carry the virtual routers, these would be hosted on an end host like in overlay networks. Moreover these Cloud Computing solutions do not intend to control the network or the communication performance as HIPerNET does.

## 8 Conclusion

The convergence of communication and computing in the Internet encourages a Networking and Computing Infrastructure as a Service (IaaS) approach. In this context, this report puts in perspective the concept of *Virtual Private eExecution Infrastructure* (VPXI), the VXDL language and the HIPerNET software which is developed within the ANR HIPCAL project to create and supervise VPXIs multiplexed in time and space. HIPerNET allows users to submit VPXIs requests, and allows infrastructure owners to virtualize a physical substrate network to share it efficiently and dynamically. We overviewed the VXDL language—which conforms to the XML standard—that we have defined to enable users to dimension VPXIs precisely and to specify their attributes. Once specified, a VPXI request is submitted to the HIPerNET engine which processes it and allocates resources accordingly. HIPerNET is responsible for admission control, resource discovery and allocation, and VPXI management in terms of fault, accounting, performance, configuration and security. This research report concentrated on the network-resource configuration feature of the HIPerNET framework. HIPerNET integrates virtualized software routers, VXRouters, to give users the ability to fully customize networking and routing functions. A validation of the link-control services for managing and sharing bandwidth between the virtual networks has been presented, as well as an evaluation of the data-plane virtualization in terms of CPU overhead. The results showed that, thanks to the HIPerNET mechanisms, *in profile* and *limit* flows are not impacted by non-conforming traffic. In this way, we demonstrated that in our implementation of the HIPerNET model, individual rate control is efficient and isolation is guaranteed. We also showed that the CPU cost of a software router hosting VXRouters depends strictly on the aggregate forwarding rate and not on the number of VXRouters it hosts. We are currently deploying the HIPerNET framework integrating the virtual-routers and virtual-links control in Grid'5000's 10 Gb/s context to isolate VPXIs dedicated to distributed applications experiments. We are also investigating security, resilience and performance aspects with real user applications. We illustrated the execution of a real medical application on a virtual infrastructure. In particular, we presented the process of translating an application's workflow into the VXDL description of a VPXI. Experimental results of the deployment and execution of this application in different virtual infrastructures using the HIPerNET framework within the Grid'5000 substrate assess the pertinence of the VXDL language and of the HIPerNET framework. Based on these promising results, our future works will explore an approach to

---

<sup>9</sup><http://www.3tera.com>

<sup>10</sup><http://www.bhive.net>



automate the translation of the workflow in a VXDL description, with the aim of extracting the expertise of application and workflow developers to ease the embedding process, while improving end-user satisfaction as well as infrastructure usage.

## Acknowledgments

This work has been funded by INRIA and the French ministry of Education and Research via the HIPCAL ANR grant and by the CARRIOCAS pôle System@tic grant. Experiments presented in this paper were carried out using the Grid'5000 experimental testbed, an initiative from the French Ministry of Research through the ACI GRID incentive action, INRIA, CNRS, RENATER and other contributing partners (see <https://www.grid5000.fr>). The authors would like to thank Augustin Ragon for his contribution as well as Olivier Mornard and Jean-Patrick Gelas for their help in the development and validation of the HIPerNet software. The authors would like to thank the anonymous reviewers for their fruitful comments and suggestions.

## Références

- [1] The RESERVOIR Seed Team, “RESERVOIR - An ICT Infrastructure for Reliable and Effective Delivery of Services as Utilities,” Tech. Rep. H-0262, IBM Research Division, Feb. 2008.
- [2] “Evaluation of current network control and management plane for multi-domain network infrastructure.” FEDERICA Deliverable DJRA1.1, July 2008.
- [3] I. Foster and C. Kesselman, “Globus : A metacomputing infrastructure toolkit,” *International Journal of Supercomputer Applications*, vol. 11, pp. 115–128, 1996.
- [4] “EGEE : Enabling Grids for E-scienceE.” <http://www.eu-egee.org>.
- [5] G. J. Popek and R. P. Goldberg, “Formal requirements for virtualizable third generation architectures,” in *SOSP '73 : Proceedings of the fourth ACM symposium on Operating system principles*, (New York, NY, USA), p. 121, ACM, 1973.
- [6] P. Barham, B. Dragovic, K. Fraser, S. Hand, T. Harris, A. Ho, R. Neugebauer, I. Pratt, and A. Warfield, “Xen and the art of virtualization,” in *SOSP '03 : Proceedings of the nineteenth ACM symposium on Operating systems principles*, (New York, NY, USA), pp. 164–177, ACM, 2003.
- [7] J. Sugarman, G. Venkitachalam, and B.-H. Lim, “Virtualizing I/O devices on VMware workstation’s hosted virtual machine monitor,” in *Proc. 2001 Usenix Annual Technical Conference*, pp. 1–14, Usenix Assoc., 2001.
- [8] N. G. Duffield, P. Goyal, A. Greenberg, P. Mishra, K. K. Ramakrishnan, and J. E. van der Merive, “A flexible model for resource management in virtual private networks,” *SIGCOMM Comput. Commun. Rev.*, vol. 29, no. 4, pp. 95–108, 1999.
- [9] M. Finlayson, J. Harrison, and R. Sugarman, “VPN Technologies - A Comparison.” Data Connection Limited, Feb. 2003.

- [10] P. Vicat-Blanc Primet, S. Soudan, and D. Verchère, “Virtualizing and scheduling optical network resource for emerging IT services,” *IEEE OSA Journal of Optical Communications and Networking(JOCN)*, vol. 1, June 2009.
- [11] E. Caron and F. Desprez, “DIET : A Scalable Toolbox to Build Network Enabled Servers on the Grid,” *Int. Journal of High Performance Computing Applications*, vol. 20, no. 3, pp. 335–352, 2006.
- [12] P. Vicat-Blanc Primet, J.-P. Gelas, O. Mornard, G. Koslovski, V. Roca, L. Giraud, J. Montagnat, and T. T. Huu, “A scalable security model for enabling Dynamic Virtual Private Execution Infrastructures on the Internet,” in *IEEE International Conference on Cluster Computing and the Grid CCGrid2009*, (Shanghai), May 2009.
- [13] “HIPCAL Project.” <http://www.ens-lyon.fr/LIP/RESO/Projects/HIPCAL/ProjetsHIPCAL.html>.
- [14] R. Moskowitz and P. Nikander, “Host Identity Protocol (HIP) Architecture,” *IETF Request for Comments, RFC 4423*, May 2006.
- [15] “Calcul Réparti sur Réseau Internet Optique à Capacité Surmultiplée (CARRIOCAS),” 2007. <http://www.carriocas.org>.
- [16] G. Koslovski, P. Vicat-Blanc Primet, and A. S. Charão, “VXDL : Virtual Resources and Interconnection Networks Description Language,” in *Grid-Nets 2008*, Oct. 2008.
- [17] “Common Information Model (CIM) Standards.” <http://www.dmtf.org/standards/cim/>.
- [18] J. van der Ham, F. Dijkstra, F. Travostino, H. Andree, and C. de Laat, “Using RDF to Describe Networks,” *Future Generation Computer Systems, Feature topic iGrid 2005*, Oct. 2006.
- [19] “Resource Description Framework (RDF) / W3C Semantic Web Activity.” <http://www.w3.org/RDF/>.
- [20] G. Koslovski, T. Truong Huu, J. Montagnat, and P. Vicat-Blanc Primet, “Executing distributed applications on virtualized infrastructures specified with the VXDL language and managed by the HIPerNET framework,” in *First International Conference on Cloud Computing (CLOUDCOMP 2009)*, (Munich, Germany), October 2009.
- [21] F. Anhalt and P. Vicat-Blanc Primet, “Analysis and experimental evaluation of data plane virtualization with Xen,” in *ICNS 09 : International Conference on Networking and Services*, (Valencia, Spain), Apr. 2009.
- [22] D. M. Divakaran and P. Vicat-Blanc Primet, “Channel Provisioning in Grid Overlay Networks (short paper),” in *Workshop on IP QoS and Traffic Control*, Dec 2007.
- [23] T. Oinn, P. Li, D. B. Kell, C. Goble, A. Gooderis, M. Greenwood, D. Hull, R. Stevens, D. Turi, and J. Zhao, *Taverna/myGrid : Aligning a Workflow System with the Life Sciences Community*, ch. 19, pp. 300–319. Springer-Verlag, 2007.
- [24] T. Glatard, J. Montagnat, D. Lingrand, and X. Pennec, “Flexible and efficient workflow deployment of data-intensive applications on grids with MOTEUR,” *Int. Journal of High Performance Computing and Applications (IJHPCA)*, vol. 22, pp. 347–360, Aug. 2008.

- [25] T. Glatard, X. Pennec, and J. Montagnat, "Performance evaluation of grid-enabled registration algorithms using bronze-standards," in *Medical Image Computing and Computer-Assisted Intervention (MICCAI'06)*, Oct. 2006.
- [26] F. Cappello, P. Primet et al., "Grid'5000 : A Large Scale and Highly Reconfigurable Grid Experimental Testbed," in *GRID '05 : Proceedings of the 6th IEEE/ACM International Workshop on Grid Computing*, pp. 99–106, IEEE Computer Society, 2005.
- [27] A. Bavier, N. Feamster, M. Huang, L. Peterson, and J. Rexford, "In VINI veritas : realistic and controlled network experimentation," in *SIGCOMM '06 : Proceedings of the 2006 conference on Applications, technologies, architectures, and protocols for computer communications*, pp. 3–14, ACM, 2006.
- [28] "GENI System Overview." The GENI Project Office, September 2008.
- [29] N. Feamster, L. Gao, and J. Rexford, "How to lease the internet in your spare time," *SIGCOMM Comput. Commun. Rev.*, vol. 37, no. 1, pp. 61–64, 2007.
- [30] S. Bhatia, M. Motiwala, W. Muhlbauer, V. Valancius, A. Bavier, N. Feamster, L. Peterson, and J. Rexford, "Hosting Virtual Networks on Commodity Hardware," tech. rep., Georgia Tech Computer Science Technical Report GT-CS-07-10, Jan 2008.
- [31] "Linux VServers Project." <http://linux-vserver.org>.
- [32] A. Bavier, M. Bowman, B. Chun, D. Culler, S. Karlin, S. Muir, L. Peterson, T. Roscoe, T. Spalink, and M. Wawrzoniak, "Operating system support for planetary-scale network services," in *NSDI'04 : Proceedings of the 1st conference on Symposium on Networked Systems Design and Implementation*, (Berkeley, CA, USA), pp. 19–19, USENIX Association, 2004.
- [33] J. He, R. Zhang-Shen, Y. Li, C.-Y. Lee, J. Rexford, and M. Chiang, "DaVinci : Dynamically Adaptive Virtual Networks for a Customized Internet," in *CoNEXT '08 : Proceedings of the 2008 ACM CoNEXT conference*, ACM, 2008.
- [34] N. Egi, A. Greenhalgh, M. Handley, M. Hoerd, F. Huici, and L. Mathy, "Towards high performance virtual routers on commodity hardware," in *CoNEXT '08 : Proceedings of the 2008 ACM CoNEXT conference*, ACM, 2008.
- [35] J. R. Santos, Y. Turner, G. Janakiraman, and I. Pratt, "Bridging the gap between software and hardware techniques for I/O virtualization," in *ATC'08 : USENIX 2008 Annual Technical Conference on Annual Technical Conference*, (Berkeley, CA, USA), pp. 29–42, USENIX Association, 2008.
- [36] Y. Wang, E. Keller, B. Biskeborn, J. van der Merwe, and J. Rexford, "Virtual routers on the move : live router migration as a network-management primitive," *SIGCOMM Comput. Commun. Rev.*, vol. 38, no. 4, pp. 231–242, 2008.
- [37] M. Yu, Y. Yi, J. Rexford, and M. Chiang, "Rethinking virtual network embedding : substrate support for path splitting and migration," *SIGCOMM Comput. Commun. Rev.*, vol. 38, no. 2, pp. 17–29, 2008.



---

Centre de recherche INRIA Grenoble – Rhône-Alpes  
655, avenue de l'Europe - 38334 Montbonnot Saint-Ismier (France)

Centre de recherche INRIA Bordeaux – Sud Ouest : Domaine Universitaire - 351, cours de la Libération - 33405 Talence Cedex  
Centre de recherche INRIA Lille – Nord Europe : Parc Scientifique de la Haute Borne - 40, avenue Halley - 59650 Villeneuve d'Ascq  
Centre de recherche INRIA Nancy – Grand Est : LORIA, Technopôle de Nancy-Brabois - Campus scientifique  
615, rue du Jardin Botanique - BP 101 - 54602 Villers-lès-Nancy Cedex  
Centre de recherche INRIA Paris – Rocquencourt : Domaine de Voluceau - Rocquencourt - BP 105 - 78153 Le Chesnay Cedex  
Centre de recherche INRIA Rennes – Bretagne Atlantique : IRISA, Campus universitaire de Beaulieu - 35042 Rennes Cedex  
Centre de recherche INRIA Saclay – Île-de-France : Parc Orsay Université - ZAC des Vignes : 4, rue Jacques Monod - 91893 Orsay Cedex  
Centre de recherche INRIA Sophia Antipolis – Méditerranée : 2004, route des Lucioles - BP 93 - 06902 Sophia Antipolis Cedex

---

Éditeur  
INRIA - Domaine de Voluceau - Rocquencourt, BP 105 - 78153 Le Chesnay Cedex (France)  
<http://www.inria.fr>  
ISSN 0249-6399