



**HAL**  
open science

# OPTIMISATION OF EXTRUDED POLYMER FOAM BY THE RESIDENT TIME DISTRIBUTION APPROACH

Frédéric Léonardi, Mathieu Larochette, Djamel Nasri, Didier Graebing

► **To cite this version:**

Frédéric Léonardi, Mathieu Larochette, Djamel Nasri, Didier Graebing. OPTIMISATION OF EXTRUDED POLYMER FOAM BY THE RESIDENT TIME DISTRIBUTION APPROACH. the Polymer Processing Society 24th Annual Meeting, Jun 2008, salerno, Italy. inria-00342785

**HAL Id: inria-00342785**

**<https://inria.hal.science/inria-00342785>**

Submitted on 28 Nov 2008

**HAL** is a multi-disciplinary open access archive for the deposit and dissemination of scientific research documents, whether they are published or not. The documents may come from teaching and research institutions in France or abroad, or from public or private research centers.

L'archive ouverte pluridisciplinaire **HAL**, est destinée au dépôt et à la diffusion de documents scientifiques de niveau recherche, publiés ou non, émanant des établissements d'enseignement et de recherche français ou étrangers, des laboratoires publics ou privés.

# OPTIMISATION OF EXTRUDED POLYMER FOAM BY THE RESIDENT TIME DISTRIBUTION APPROACH

Frédéric Leonardi, Mathieu Larochette, Djamel Nasri and Didier Graebing

IPREM/EPCP UMR 5254 Université de Pau et des Pays de l'Adour BP 1155 64013 Pau France

## Abstract

In this work, we used the Residence Time Distribution (RTD) to study the polystyrene foaming during an extrusion process. The extruder associated with a gear pump is simply and quantitatively described by three continuously stirred tank reactors with recycling loops and one plug-flow reactor. The blowing agent used is CO<sub>2</sub> and its obtained by thermal decomposition of a chemical blowing agent (CBA). This approach allows to optimize the density of the foam in accordance with the CBA kinetic of decomposition.

## Introduction

The Resident Time Distribution (RTD) is a theoretical frame for studying complex flow networks and is perfectly adequate for describing the polymer flow through an extruder. For reactive extrusion processes where the reaction time is of the same order of the mean residence time, the RTD is of interest, since the length of time that the material remains in the extruder should be closely coupled to the reaction kinetics. The RTD approach has been proved for its efficiency to simulate the twin-screw extruder<sup>[1] to [11]</sup>.

In this paper, we have studied the processing of polystyrene foam by extrusion in a single screw extruder coupled with a gear pump. The basic principle of foaming is to mix a blowing agent into a polymer melt and induce a thermodynamic instability through a temperature or pressure change to nucleate bubbles of the blowing agent. After nucleation, the bubble growth is controlled by reducing the temperature lower than the glass transition temperature of the polymer<sup>[12]</sup>. The blowing agent used is CO<sub>2</sub> and its obtained by thermal decomposition of an organic molecule called Chemical Blowing Agent (CBA). To obtain an optimal foam, i.e. lower density, the process parameters of the extruder must be adapted to the CBA kinetic of decomposition.

## Theoretical background

Suppose that an inlet particle concentration  $C_i(t)$  is applied to the reactor<sup>[13][14][15]</sup>. Then we want calculate the outlet particle concentration  $C_o(t)$ . The particles are conveyed by a fluid flowing at a volumetric rate  $Q$ . It is assumed that particles do not interact with each other. The number of particles that enter the reactor in the time interval  $(t', t' + dt')$  and leave the reactor in the time interval

$(t, t + dt)$  is  $Q C_i(t') f(t - t') dt'$ . The total outflow during the time interval  $(t, t + dt)$  is  $Q C_o(t) dt$ , and thus:

$$Q C_o(t) dt = Q dt \int_{-\infty}^t C_i(t') f(t - t') dt'$$

$$\Rightarrow \begin{cases} C_o(t) = \int_{-\infty}^t C_i(t') f(t - t') dt' \\ C_o(t) = \int_0^{\infty} C_i(t - t') f(t') dt' \end{cases} \quad (1)$$

$f(t)$  is the residence time density function and it represents the density of probability expressed as probability per unit time. This function depends on the characteristics of the system. In the Laplace domain, the equation 1 becomes:

$$\mathcal{L}\{C_s(t)\} = \mathcal{L}\{C_e(t)\} \times \mathcal{L}\{f(t)\}$$

$$\Rightarrow \mathcal{L}\{f(t)\} = \frac{\mathcal{L}\{C_s(t)\}}{\mathcal{L}\{C_e(t)\}} \quad (2)$$

The function  $\mathcal{L}\{f(t)\}$  is known as the transfer function of the reactor. If the inlet signal is a Dirac delta function, the outlet response of the system is identical to the residence time density function.

The cumulative residence time distribution  $F(t)$  and the mean residence time of the reactor  $\bar{t}$  are defined by the following equations:

$$F(t) = \int_0^t f(t') dt' \quad \bar{t} = \int_0^{\infty} t' f(t') dt' = \frac{V}{Q} \quad (3)$$

where  $V$  is the volume of the reactor and  $Q$  its flow rate.

The complex flow can be described by the association of two kinds of idealized reactors called the Continuously Stirred Tank Reactor or CSTR and the Plug-Flow Reactor or PFR. The residence time density function for each reactor is given by:

$$\text{CSTR : } f(t) = \frac{1}{\bar{t}} e^{-t/\bar{t}} \quad \text{PFR : } f(t) = \delta(t - t_0) \quad (4)$$

In this article, we use a statistic theory instead of a physical model to related the overall RTD in a single extruder to those in appropriately divided elements. We represent a single extruder by addition of three identical CSTR and one PFR in series (Fig. 1).

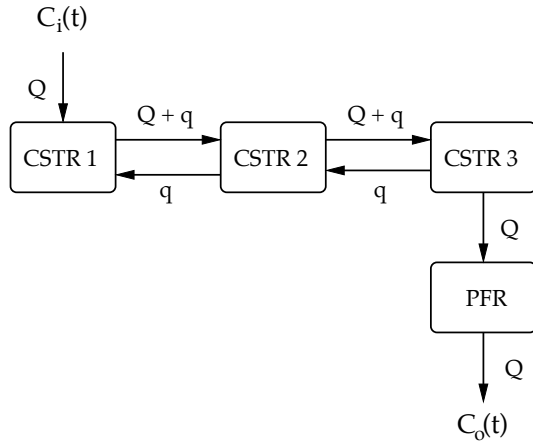

FIG. 1 The RTD vision of extruder.

$Q$  is the volumetric flow rate passing through the system and  $q$  is the recycling volumetric flow rate between two CSTR. We define the recycling parameter  $\alpha$  as the ratio  $q/Q$ . For example, this recycling flow is due to the back pressure existing in the extruder.

The residence time density function of the three identical CSTR with recycling loops is given by the following equation:

$$f(t) = \frac{e^{t/\bar{t}}}{4\alpha\bar{t}} \left( -2 + e^{-\beta t/\bar{t}} + e^{\beta t/\bar{t}} \right) \quad \text{with } \beta = \sqrt{\frac{2\alpha}{1+2\alpha}} \quad (5)$$

where  $\bar{t}$  is the mean time residence of one tank.

The addition of the PFR implies a simple time shift. The residence time density function of the extruder is given by the following equation:

$$f(t) = \frac{e^{(t-t_0)/\bar{t}}}{4\alpha\bar{t}} \left( -2 + e^{-\beta(t-t_0)/\bar{t}} + e^{\beta(t-t_0)/\bar{t}} \right) \Upsilon(t-t_0) \quad (6)$$

where  $t_0$  is the mean residence time of the PFR and  $\Upsilon(t)$  is the Heaviside step function.

Without recycling, the equation 6 becomes:

$$f_0(t) = \lim_{\alpha \rightarrow 0} f(t) = \frac{(t-t_0)^2}{2\bar{t}^3} e^{-(t-t_0)/\bar{t}} \Upsilon(t-t_0) \quad (7)$$

In figure 2, we have shown the behaviour of the system given by the equation 5 for different values of  $\alpha$  and  $\bar{t}$ .

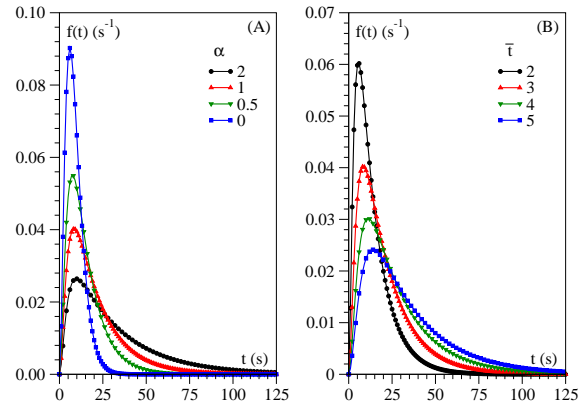

FIG. 2 Theoretical RTD for 3 CSTR in series (Eq. 5). Residence time density function vs. time. A)  $\bar{t} = 3$  s B)  $\alpha = 1$ .

The relationship between  $\bar{t}$  the mean time residence of one CSTR,  $t_0$  the mean time residence of PFR and  $\bar{t}_x$  the mean time residence of the extruder is:

$$\bar{t}_x = \int_0^{\infty} t f(t) dt = (3 + 4\alpha)\bar{t} + t_0 \quad (8)$$

## Experimental section

### Products

The polystyrene PS 1450N was supplied by Total Petrochemicals. Carbon dioxide is produced by thermal decomposition of the chemical blowing agent: Tramaco NCS 175. The thermal decomposition of this agent is obtained in the temperature range of 135 to 220°C. The tracer used is a blue dye for polystyrene referenced M120442 SPC from Elian.

### Process

We used a single Thermo Haake Rheomex 252p extruder with a length to diameter ratio of 25:1. A gear pump MSDP 090/039 supplied by Xaloy (1.2 cm<sup>3</sup>/rpm), was mounted between the die and the end of the extruder. Usually, gear pumps are solely used to generate pressure ahead of the die. In this case, the pressure differential across the pump is positive. To increase the mean residence time, the melt pump was mounted to obtain a negative pressure differential. Our gear pump is correctly lubricated when the pressure differential is between 10 to 350 bars. The mixing capacity of gear pumps is very limited.

The polymer melt is passed through a capillary die, diameter: 2 mm and length: 12 mm, before cooling with four

computer fans. The cold extrudate is analyzed by the RTD system. To control the outflow speed of the extrudate a pelletiser Varicut (Thermo Haake) is modified and is used as a speed control pull system. This speed is adjusted to maintain the extrudate diameter equal to the die diameter.

### RTD measurement

Many in-line methods have been proposed in the literature for RTD measurement<sup>[16] to [19]</sup>. An optical method based on light transmittance was chosen for our experiments. The RTD is measured by transit experiments by injecting a small quantity of an inert tracer at the feed hopper of the extruder. The dye concentration evolution is analyzed continuously in real time. A cold white light is used as light source. The transmitted light intensity is quantified by a photodiode supplied by Vishay Telefunken. An electronic module amplifies and converts the photodiode current in a voltage signal compatible with the analog to digital converter. The signal obtained is directly sent to a computer from the data acquisition system, ADC 212 Pico Technology. The RTD measurements were realized without the foaming agent and 100 mg of blue dye was used for each experiment.

## Results and discussion

### CBA kinetic of decomposition

The CBA decomposition was studied by thermal gravimetry analysis, TA 2950, in the temperature range of 100 to 300°C for three heating rates: 10, 15 and 20°C/min. This blowing agent is characterized by two domains of temperature 135 – 170°C and 190 – 230°C. The observed weight loss remained relatively constant for each heating rate, 15 % for the first domain and 17 % for the second. The residual weight of the samples is due to a mineral compound.

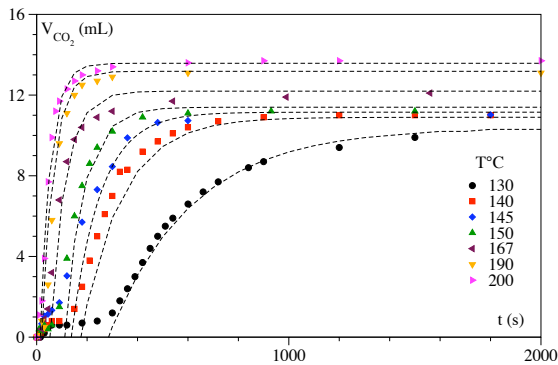

FIG. 3 CBA thermal decomposition. Volume of CO<sub>2</sub> vs. time.

The kinetic experiments was carried out on a tailor-made system. For each temperature, the release volume of CO<sub>2</sub> produced by thermal decomposition of 100 mg of CBA was measured as a function of time. All results are given for the normal pressure, 1.013 10<sup>5</sup> Pa. The thermal decomposition of AIBN (azo bis isobutyronitrile) was used to validate our experimental approach. The rate of degradation was influenced only by the temperature of the sample (Fig. 3).

The CO<sub>2</sub> release volume is given by the following equation:

$$V_{CO_2} = V_{\infty} \left( 1 - \exp \left( -k(t - t_0) \right) \right) \quad (9)$$

where  $V_{\infty}$ ,  $t_0$  and  $k$  are respectively the total volume of CO<sub>2</sub>, the inhibition time and the kinetic constant associated to the decomposition.

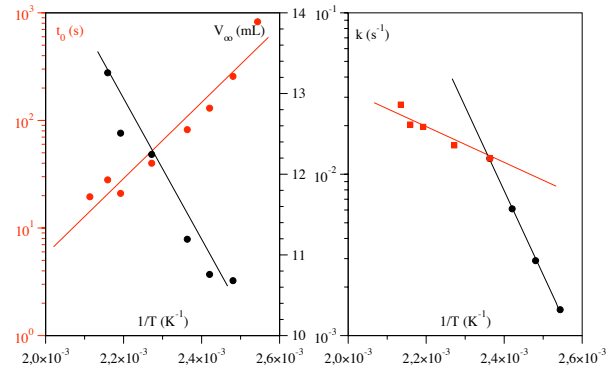

FIG. 4 CBA thermal decomposition. Kinetic parameters vs. reciprocal temperature.

The Fig. 4 show the thermal behavior of these parameters. The thermal variation of the kinetic constant clearly shows the two domains of temperature decomposition. The thermo-dependence of the inhibition time and the kinetic constant is given by an Arrhenius' law:

$$\begin{cases} t_0 = 4.82 \times 10^{-7} \exp \left( \frac{8.14 \times 10^3}{T} \right) \quad (\text{s}) \\ k_{120 \rightarrow 150} = 24.9 \times 10^9 \exp \left( \frac{99.7 \times 10^3}{T} \right) \quad (\text{s}^{-1}) \\ k_{150 \rightarrow 200} = 5.4 \exp \left( \frac{21.2 \times 10^3}{T} \right) \quad (\text{s}^{-1}) \end{cases} \quad (10)$$

The total volume of CO<sub>2</sub> variation is given by the following hyperbolic function of temperature:

$$V_{\infty} = 32.01 - \frac{8.72 \times 10^3}{T} \quad (\text{mL}) \quad (11)$$

The temperature in the extruder was set to a temperature range of 190-200°C. In this case, the time to obtain the total decomposition of CBA is 150 s.

## RTD for extruder

The gear pump mounted between the extruder and the die was used to increase the pressure gradient in the extruder. The appropriate gear pump lubrication is obtained when the operating pressure is higher than 1 MPa. To limit the polymer leak, the maximum operating pressure is fixed at 35 MPa. The range of pressure necessary for an accurate working of the pump strongly limits the domain of screw rotation speed explored (Fig. 5). Moreover, the domain size decreases dramatically with the extrusion temperature.

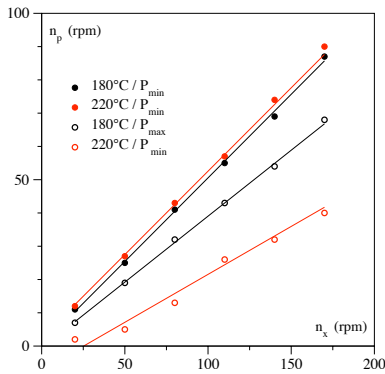

FIG. 5 Working domain in extrusion. Gear pump rotation speeds vs. screw rotation speeds at 180 and 220°C.

In our experiments, the variation of the pressure gradient with the screw rotating speed is similar for all melt pump flow rates studied (Figure 6). The curves are shifted towards the screw rotating speed axis.

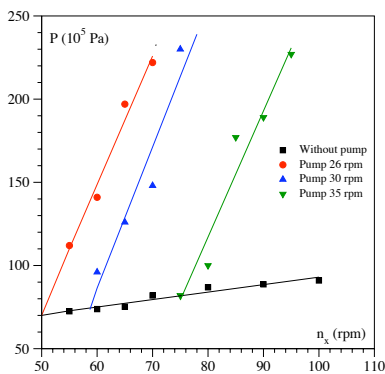

FIG. 6 Pressure vs. screw rotation speeds at 190°C for the extrusion line with and without gear pump.

The residence time density function are shown for the two configurations of the extrusion line: without and with gear pump, and for different screw rotation speeds (Fig. 7 & 8).

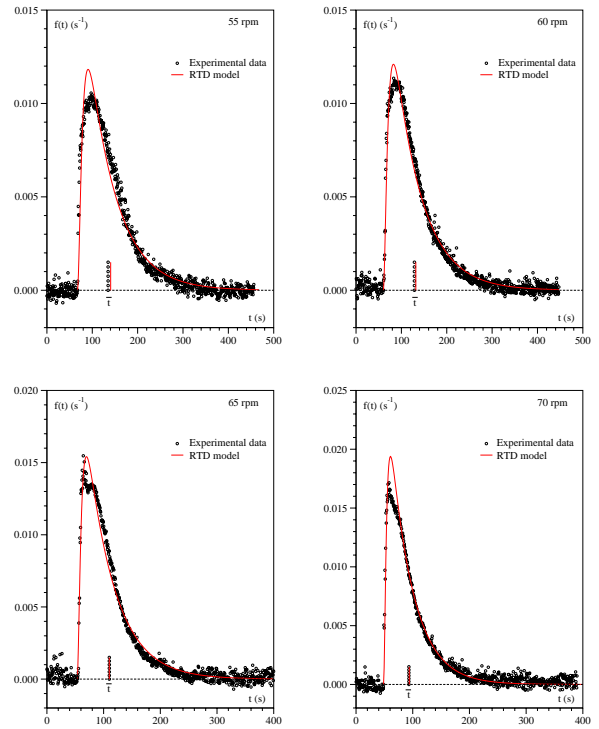

FIG. 7 Experimental and theoretical RTD for a single extruder without gear pump at 190°C.

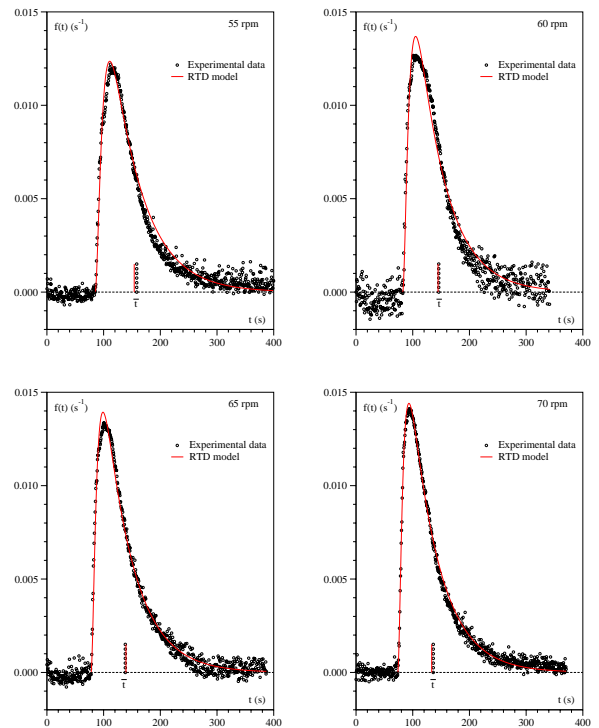

FIG. 8 Experimental and theoretical RTD for a single extruder with gear pump,  $n_p = 26$  rpm at 190°C.

For each experiment, the model parameters were determined by a non-linear least square method with SCILAB<sup>®</sup> (numerical computational package developed by INRIA). In all cases, the standard deviation is less than  $10^{-3}$ . The RTD model (Eq. 6) is in perfect agreement with the experimental data. The theoretical and experimental mean resident times  $\bar{t}_x$  were calculated with the Eq. 8: direct integration for the experimental time and model parameters for the theoretical time. The comparison between experimental data and the model confirms that the RTD approach is able to describe simply and quantitatively the extrusion process.

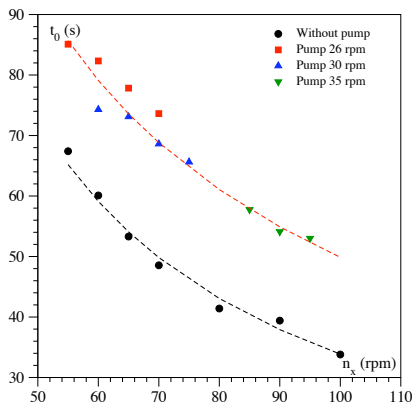

FIG. 9  $t_0$  vs. screw rotation speeds at 190°C for the extrusion line with and without gear pump.

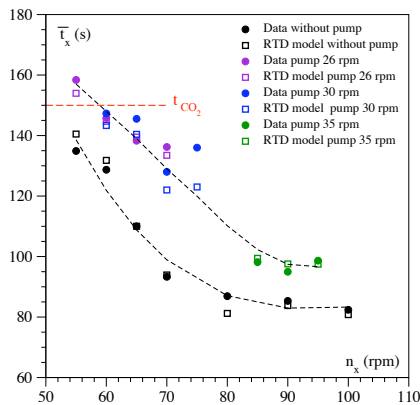

FIG. 10  $\bar{t}_x$  vs. screw rotation speeds at 190°C for the extrusion line with and without gear pump. Comparison between the experimental data and the RTD model.

The results in terms of mean resident times  $t_0$  or  $\bar{t}_x$  shown the efficiency of the pump (FIG. 9 & 10). An increase in pressure gradient in the extruder implies an increase in the mean time residence.

The analysis of the three characteristic parameters of the residence time density function curve:  $t_0$ ,  $\bar{t}$  and  $\alpha$  is not obvious (Figure 11). For the same configuration of the extrusion line, we observe a decrease in the mean time residence and an increase in the recycling parameter with the screw rotating speed of the extruder. The effect of the pressure gradient is clearly shown by the variation of the  $\alpha$  parameter. The mean resident time is defined by the ratio volume of the reactor and its flow rate. In the case of the CSTR with recycling loops the flow rate in the reactor is the sum of the global flow rate  $Q$  and the recycling flow rate  $q$ . Thus, the variation of  $\bar{t}$  can be explained by the increase in the recycling flow while the volume of the reactor is constant. The influence of the addition of the gear pump is not clear. In this case, an increase in the mean resident times and a decrease in the recycling term were obtained.

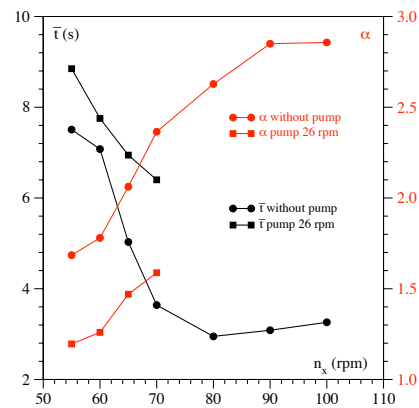

FIG. 11  $\bar{t}$  and  $\alpha$  vs. screw rotation speeds at 190°C for the extrusion line with and without gear pump.

With the foam, the bubbles prevented any light transmission and so the RTD measurements become impossible with our system. The density of the foam provides another way to find the adequate process parameters. The density can be calculated with the mass, the dimensions of the extrudate and the kinetic parameters. The foams were prepared with 0.5 wt % in chemical blowing agent. In the case of the total decomposition of blowing agent, the value of foam density is  $587 \text{ kg/m}^3$ . The TAB. 1 shows the relationship between the density of the foam and the process parameters. The density values given in this table are the 5 samples average.

The pressure at the inlet of the gear pump was decreased in presence of the foaming agent. This effect is due to the solubility of  $\text{CO}_2$  in the polymer matrix and the viscosity is a function of this solubility<sup>[12]</sup>.

Lowest foam density was only obtained at 55 rpm with the gear pump (26 rpm). This value,  $615 \text{ kg/m}^3$ , is close to the optimal density. The mean time residence of the extrusion

line is higher than the time to obtain the total decomposition of CBA. In the absence of the pump, the mean time residence of the line is lower than the *chemical time* and the density foams are too high. The mean time residence of the extrusion line is the critical parameter.

Exp	CBA (% <sub>m</sub> )	$n_x$ (rpm)	$n_p$ (rpm)	P (MPa)	$\bar{t}_x$ (s)	$\rho$ (kg.m <sup>-3</sup> )
0	0	60	-	8,8	<b>129</b>	915
1	0,5	80	-	8,4	<b>90</b>	790
2	0,5	55	-	8,1	<b>135</b>	721
<b>3</b>	<b>0,5</b>	<b>55</b>	<b>26</b>	<b>13</b>	<b>160</b>	<b>615</b>

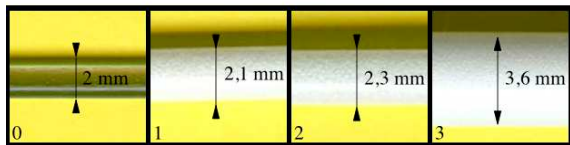

TAB. 1 Density of foams and pictures vs. process parameters.

## Conclusions

The results obtained confirm that the Residence Time Distribution theory is able to describe simply and quantitatively an extrusion process. An association of three continuously stirred tank reactors with recycling loops and one plug-flow reactor was sufficient. In this case, the extrusion line without and with a gear pump could be described by three parameters:  $t_0$  the delay time or the mean time residence of the PFR,  $\bar{t}$  the mean time residence of each CSTR and  $\alpha$  the recycling flow between the CSTR.

In presence of the CBA, the formation of the bubbles does not allow the RTD measurements on the extrudate. A determination of the foam density shows the importance of the correlation between the *chemical time* associated to the blowing agent and the mean time residence of the extrusion line.

## Acknowledgments

The authors are pleased to acknowledge the Communauté d'Agglomération Pau-Pyrénées and the society Knauf Insulation for a financial contribution to this research.

## References

- [1] L. Chen and Z. Pan and G.-H. Hu, *AIChE Journal* **39**, 1455-1464 (1993).

- [2] L. Chen and G.-H. Hu, *AIChE Journal* **39**, 1558-1562 (1993).

- [3] J. Gao and G. C. Walsh and D. Bigio and R. M. Briber and M. D. Wetzel, *AIChE Journal* **45**, 2541-2549 (1999).

- [4] G. Shearer and C. Tzoganakis, *Polymer Engineering and Science* **41**, 2206-2215 (2001).

- [5] G. Yichong and Z. Fuhua, *Polymer Engineering and Science* **43**, 306-316 (2003).

- [6] A. Poulesquen and B. Vergnes, *Polymer Engineering and Science* **43**, 1841-1848 (2003).

- [7] A. Poulesquen and B. Vergnes and Ph. Cassagnau and A. Michel and O. S. Carneiro and J. A. Covas, *Polymer Engineering and Science* **43**, 1849-1862 (2003).

- [8] V. L. Bravo and A. N. Hrymak and J. D. Wright, *Polymer Engineering and Science* **44**, 2004 (2004).

- [9] Ph. Cassagnau and M. Courmont and F. Melis and J.-P. Puaux, *Polymer Engineering and Science* **45**, 926-934 (2005).

- [10] S. Myung Lee and J. C. Park and S. Mook Lee and Y. J. Ahn and J. W. Lee, *Korea-Australia Rheology Journal* **17**, 87-95 (2005).

- [11] P. Elkouss and D. Bigio and M. D. Wetzel and S. R. Raghavan, *AIChE Journal* **52**, 1451-1459 (2006).

- [12] X. Han and K. W. Koelling and D. L. Tomasko and L. J. Lee, *Polymer Engineering and Science* **42**, 2094-2106 (2002).

- [13] O. Levenspiel, *Chemical Reaction Engineering*, John Wiley & Sons, Inc Second Edition (1972).

- [14] O. Levenspiel, *The Chemical Reactor Omnibook*, Corvallis, OR: OSU Bookstores (1989).

- [15] E. B. Nauman and B. A. Buffham, *Mixing in continuous flow systems*, John Wiley & Sons, Inc (1983).

- [16] R. Gendron and L. E. Daigneault and J. Tatibouët and M. M. Dumoulin, *Advanced in Polymer Technology* **15**, 111-125 (1996).

- [17] G.-H. Hu and I. Kadri and C. Picot, *Polymer Engineering and Science* **39**, 930-939 (1999).

- [18] O. S. Carneiro and J. A. Covas and J. A. Ferreira and M. F. Cerqueira, *Polymer Testing* **23**, 925-937 (2004).

- [19] A. Kumar and G. M. Ganjyal and D. D. Jones and M. A. Hanna, *Journal of Food Engineering* **75**, 237-244 (2006).