



**HAL**  
open science

# IoT Based Crop-Field Monitoring and Precise Irrigation System Using Crop Water Requirement

Kanchana Rajaram, R. Sundareswaran

► **To cite this version:**

Kanchana Rajaram, R. Sundareswaran. IoT Based Crop-Field Monitoring and Precise Irrigation System Using Crop Water Requirement. 3rd International Conference on Computational Intelligence in Data Science (ICCIDS), Feb 2020, Chennai, India. pp.291-304, 10.1007/978-3-030-63467-4\_23 . hal-03434795

**HAL Id: hal-03434795**

**<https://inria.hal.science/hal-03434795v1>**

Submitted on 18 Nov 2021

**HAL** is a multi-disciplinary open access archive for the deposit and dissemination of scientific research documents, whether they are published or not. The documents may come from teaching and research institutions in France or abroad, or from public or private research centers.

L'archive ouverte pluridisciplinaire **HAL**, est destinée au dépôt et à la diffusion de documents scientifiques de niveau recherche, publiés ou non, émanant des établissements d'enseignement et de recherche français ou étrangers, des laboratoires publics ou privés.



Distributed under a Creative Commons Attribution 4.0 International License

# IoT based Crop-field Monitoring and Precise Irrigation System Using Crop Water Requirement

Kanchana R and Sundareswaran R

Department of Computer Science and Engineering,  
SSN College of Engineering, Anna University,  
Chennai - 603110. Tamil Nadu, India

rkanch@ssn.edu.in ORCID: 0000-0002-2591-2482

sundareswaran1616@cse.ssn.edu.in ORCID: 0000-0001-5704-6614

**Abstract.** Existing practices of crop irrigation is manual and based on generic traditional recommendations. Crops when provided lesser water, shows reduced growth and reduced uptake of calcium. Excessive irrigation leads to root death and water wastage. Hence, irrigating crops with precise water becomes an important problem. Towards this objective, an IoT based crop field monitoring and precise irrigation system is proposed that monitors crop-field and computes precise crop water requirement based on its life cycle and climatic conditions. Using this computed crop water requirement, a pump motor is operated automatically whenever soil moisture decreases below permanent wilting point. The motor is shut down once the required water is pumped out to crops. The proposed system is installed in a crop-field of brinjal plant and the crop is irrigated for 6 months. It is observed that 53% of water has been saved from wastage.

**Keywords:** We would like to encourage you to list your keywords within the abstract section

## 1 Introduction

The Internet of Things (IoT) is a system of interrelated computing devices, mechanical and digital machines, objects, animals or people that are provided with unique identifiers and the ability to transfer data over a network without requiring human-to-human or human-to-computer interaction. The Internet of Things extends internet connectivity beyond traditional devices like desktop and laptop computers, smart phones and tablets to a diverse range of devices and things that utilize embedded technology to communicate and interact with the external environment, all via the Internet. Examples include connected security systems, thermostats, cars, electronic appliances, lights in household and commercial environments, alarm clocks, speaker systems, vending machines and more.

IoT is the expansion of communication network and internet application, which is a technique to sense the physical world by sensing technology and

the intelligent devices through the interconnection, calculation, processing and knowledge mining. It achieves information exchange and seamless communication among people and objects or among the things. It controls the physical world in real-time enabling accurate management and scientific decision-making.

Smart irrigation refers to the supply of water to the agricultural field by controlling the pump motor automatically by using IoT technique. Excessive irrigation of crops results in wastage of water and human resources leading to water scarcity. Water requirement of a particular crop varies based on soil moisture and climatic parameters such as temperature, humidity and wind speed. In addition, it varies according to the crop's life cycle. None of the existing methods for automated irrigation have attempted to precisely compute water requirement of crops and irrigate them accordingly. Hence, an IoT based system has been proposed that monitors crop-field and automatically irrigates based on crop water requirement.

The rest of this paper is organized as follows: Section II surveys the existing literature and Section III introduces background concepts. Section IV illustrates the proposed IoT framework and Section V explains the tested results of the proposed work. Section VI concludes the work and points out future directions.

## 2 LITERATURE SURVEY

The existing works on automated irrigation have been surveyed and presented below: Nisha et al. [1], Rao et al. [9] and Banumathy et al. [10] have proposed an automated crop-field monitoring and irrigation system using wireless sensor networks and gateways that irrigates plants automatically for fixed duration of time. However, it does not prevent wastage of water. Morais et al. [2] uses TDMA and CSMA protocol to acquire data which results in slowed down communication with frequent disconnections.

Tanveer et al.'s work [3] collects sensed data as and when climatic parameters cross a safety threshold and controls irrigation. Jiao et al. [4] proposed a three layered system for precise irrigation with remote monitoring. These two works have been tested for a controlled environment at green house and not for large natural fields. In Pavithra et al.'s work [5], when the moisture sensor senses low moisture content of the soil, it signals a mobile phone via a micro-controller which activates an alert/buzzer. In this work, bluetooth based communication is proposed. However, bluetooth has a low range of communication and it requires repeaters/routers to send the data precisely. Tensiometric and volumetric techniques proposed in [6], monitors soil moisture and temperature for irrigating crops. However, this work may not provide precise irrigation as other climatic parameters are ignored. Pavankumar et al.'s work [7] considered humidity, temperature and soil moisture to compute water required to irrigate the crops. Verma et al. [8] proposed crop field monitoring system that irrigates crops and administers water-soluble fertilizers. However, the water requirement of crops has been ignored. Bharathi et al.'s work [11] used SCADA and PLC for automated irrigation. This work does not sense any data and focused mainly

on water storage. In summary, none of the automated drip irrigation [13] and automated plant irrigation systems have considered water requirement of crops.

### 3 Background

Computation of Crop Water Requirement (CWR) [15] is based on the following factors:

- The effect of climate on crop water requirements.
- Crop characteristics.
- Local conditions for cultivation and irrigation such as distance, altitude, size of fields, and salinity.

**Evaporation** [14] refers to conversion of water into water vapour directly from surfaces like river, soil etc. **Transpiration** implies conversion of water into water vapour through plant cells and plant tissue. **Evapotranspiration** [15] is a combination of evaporation and transpiration. It can be computed using the following methods:

- Blaney-Criddle Method
- Radiation Method
- Pan Evaporation Method
- Penman Method

**Penman Method** is used for computation of Evapotranspiration ( $ET_o$ ) based on temperature, humidity, windspeed and radiation/sunshine duration. It has been proved that, compared to other methods, Penman method provides better and accurate results [15]. Hence, crop water requirement is computed using Penman method in our work.

### 4 Proposed Work

#### 4.1 Architecture Design

The proposed work consists of soil moisture sensor, temperature sensor, humidity sensor and a wind speed sensor. These sensors collect the real time data and the sensed values are sent to the gateway through RF communication medium as depicted in Fig. 1. From gateway, the values are sent to the amazon's AWS cloud server through GSM communication medium, where the CWR is calculated. The sensed data values are stored in the logger database in MySQL server at the cloud. Based on the sensed data, the pump motor is operated by controlling the relay through the motor controller connected to the gateway via RF communication medium.

The proposed system comprises of the following four modules:

- Setting up of Wireless Sensor Network.
- Sensing and logging of data.
- Computation of CWR.
- Automated control of pump motor.

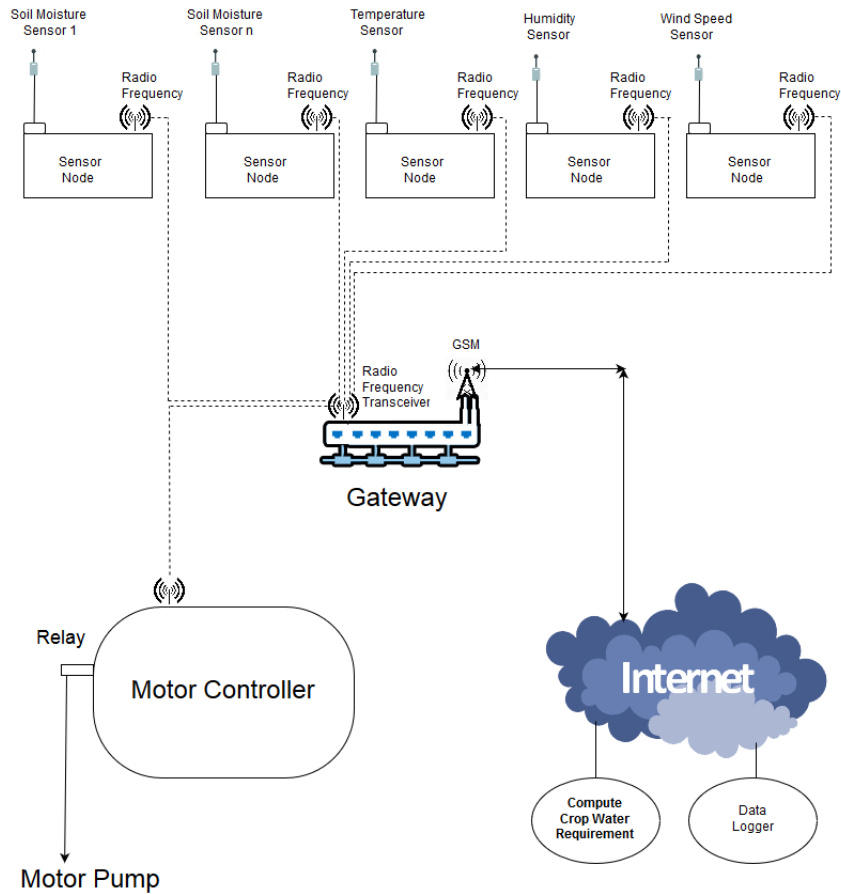

**Fig. 1.** Crop Field Monitoring and Precise Irrigation System - Architecture

#### 4.2 Setting up of Wireless Sensor Network

The soil moisture sensor is connected to a sensor node/mote as shown in Fig. 2. The mote is battery operated and is equipped with zigbee transmitter to transmit the soil moisture values to a gateway. Several motes are installed in the crop-field forming a WSN. The humidity sensor, temperature sensor and windspeed sensor are also connected to the gateway as shown in Fig. 3. The sensed values are communicated to amazon AWS cloud server through GSM module as shown in Fig. 4. A snapshot of AWS server is shown in Fig. 5. The gateway shown in Fig. 4. consists of a relay to control the pump motor, on receiving a signal from CWR computation module in the AWS server. The AWS cloud server consists of an EC2 instance and RDS Database to store and retrieve the sensed values for the calculation of crop water requirement.

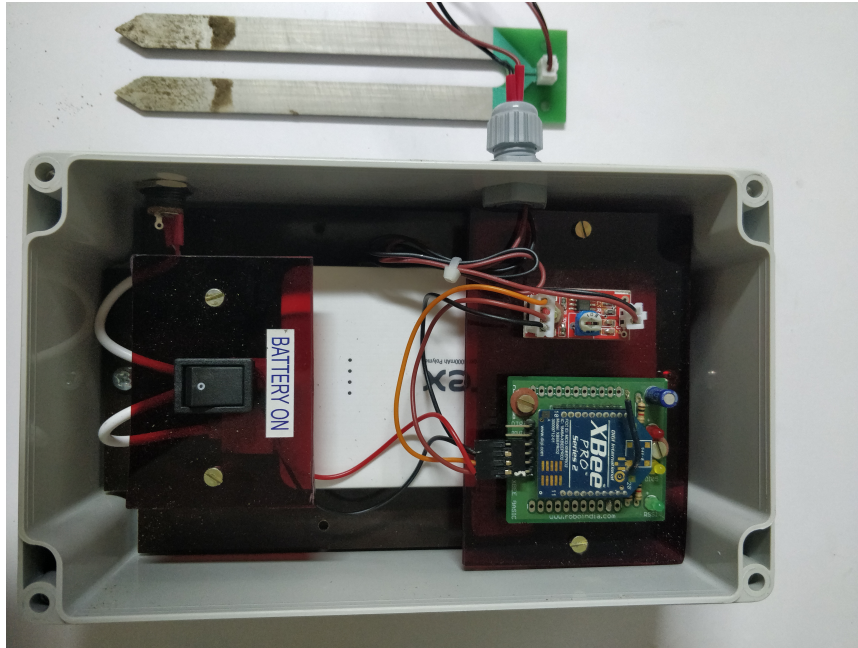

**Fig. 2.** Mote Connected with Soil Moisture Sensor

### 4.3 Sensing and logging of data

The environmental conditions are sensed and logged in the database available in the cloud server.

**Mote for Soil Moisture Sensor** The sensed soil moisture value is in HEX format and it is calibrated into % value for the computation purpose. The following table is used to store the sensed values of different soil moisture sensors in % along with their IDs.

**Table 1.** Schema for Data Logging from Soil Moisture Sensors

Timestamp	Soil Moisture Sensor ID	Soil Moisture (%)
...	...	...

**Mote for Humidity Sensor** The humidity sensor senses the humidity value in the environment. The sensed value is calibrated using DHT.lib in arduino controller and displayed in %. Fig. 6 depicts the DHT11 Humidity sensor that is interfaced in the gateway.

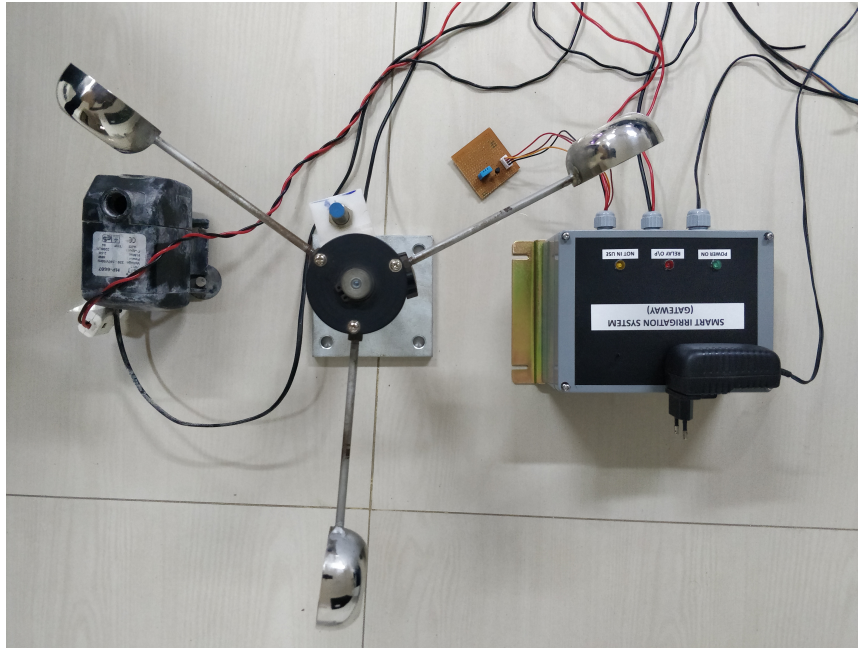

**Fig. 3.** Gateway Connected with Sensors and a Pump Motor

The following table is used to log the humidity value in% along with timestamp.

**Table 2.** Schema for Data Logging from Humidity Sensor

Timestamp	Humidity (%)
...	...

**Note for Temperature Sensor** The temperature sensor senses the temperature value in the environment and displays the output in °C which is calibrated in arduino controller. Fig. 6 depicts the LM35 Temperature sensor that is interfaced with the gateway. The following table is used to store the temperature value in °C along with timestamp.

**Table 3.** Schema for Data Logging from Temperature Sensors

Timestamp	Temperature (°C)
...	...

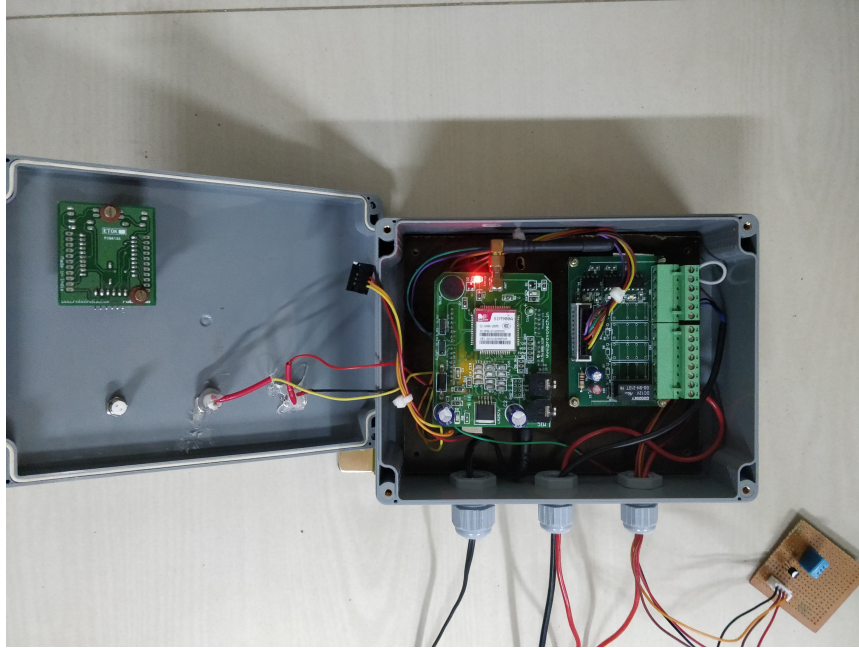

**Fig. 4.** Gateway Comprising GSM Module

**Note for Windspeed Sensor** The windspeed sensor as shown in Fig. 7 senses the speed of the wind in the environment giving the output in pulses that is calibrated into KMPH (Kilometer Per Hour) in arduino controller. This windspeed sensor is connected to the gateway.

The following table shows the schema to store the windspeed value in KMPH along with timestamp.

**Table 4.** Schema for Data Logging from Windspeed Sensor

Timestamp	Windspeed (KMPH)
...	...

#### 4.4 Computation of Crop Water Requirement

The water requirement for a crop depends upon its life cycle and the climatic conditions. Crop Water Requirement ( $ET_{crop}$ ) is calculated as

$$ET_{crop} = K_c \cdot ET_o \text{ mm/day} \quad (1)$$

where,

$K_c$  = Crop Coefficient



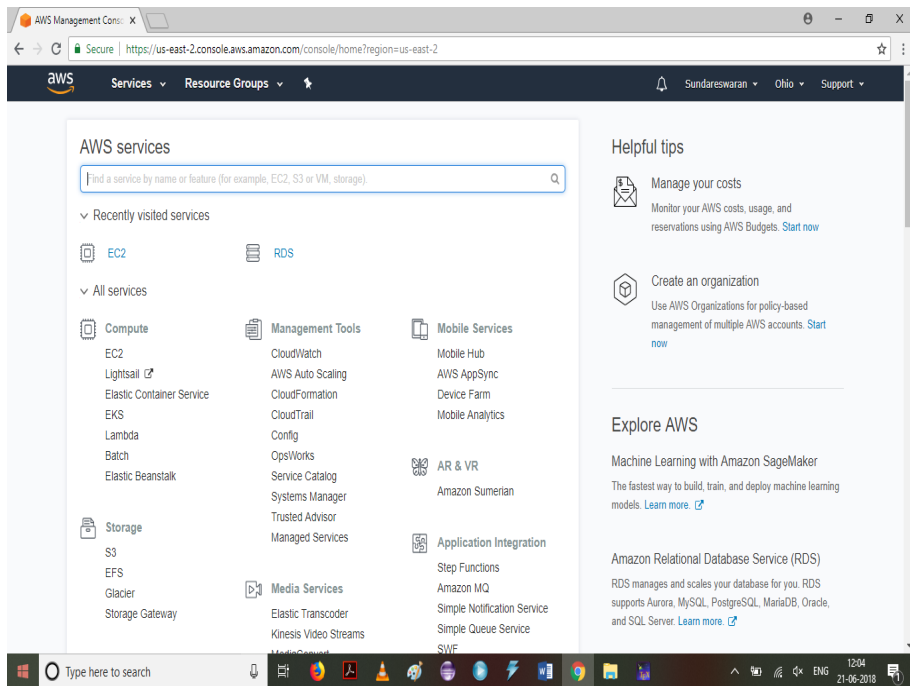

**Fig. 5.** Snapshot of Amazon Web Services (AWS) Server

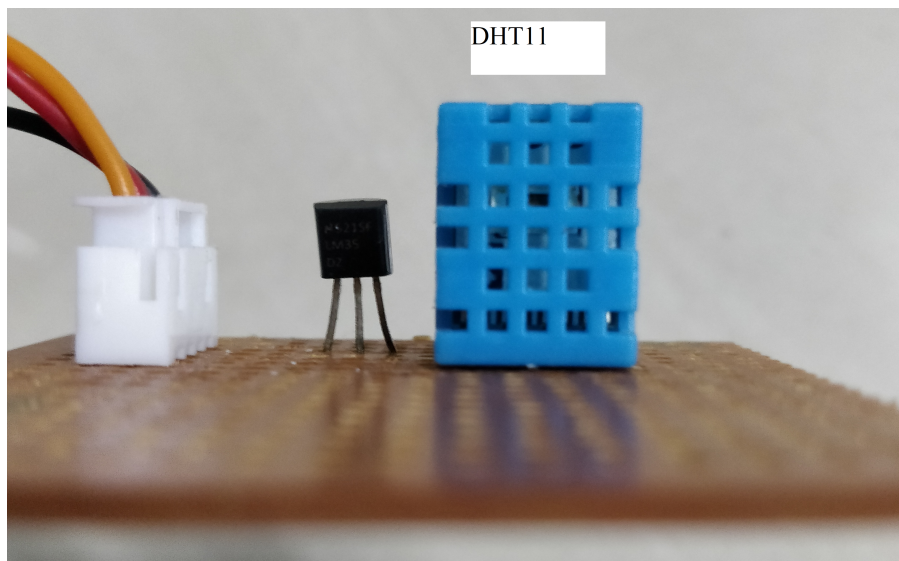

**Fig. 6.** Temperature Sensor Mote



**Fig. 7.** Windspeed Sensor Mote

$ET_o$  = Reference crop evapotranspiration

Evapotranspiration ( $ET_o$ ) is computed using Penman method as given below:

$$ET_o = c[W.R_n + (1 - W).f(u).(e_a - e_d)]mm/day \quad (2)$$

where,

$ET_o$  = reference crop evapotranspiration in mm/day

W = temperature-related weighting factor

$R_n$  = net radiation in equivalent evaporation in mm/day

f(u) = wind-related function

$e_a$  = saturation vapor pressure at daily mean air temperature in millibars

$e_d$  = mean actual vapour pressure of the air, in millibars

c = adjustment factor to compensate for the effect of day and night weather conditions

$ET_o$  is calculated using the sensed values of temperature, humidity and wind speed. The mean of minimum and maximum sensed temperature is used to look-up weighting factor from the table given in [15]. Similarly, according to minimum sensed humidity value and mean temperature values,  $e_a$  is looked up from the table in [15].  $e_d$  is computed using the formula:

$$e_d = e_a * RH_{mean}/100 \quad (3)$$

Wind related function,  $f(u)$  is computed using sensed wind speed value

$$f(u) = 0.27(1 + U/100) \quad (4)$$

where  $U = 24$  hour wind run in km/day.

Adjustment factor  $c$  and radiation values  $R_n$  are looked up from the corresponding tables available in [15].

In the AWS server, the calculated CWR provides the output in mm/day which is converted into litres as follows :

$$CWR = ET_o * A * 1000 \text{ litres} \quad (5)$$

where  $A$  is the area of crop field in square meters.

#### 4.5 Automated control of pump motor

The gateway receives CWR in litres from the CWR computation module residing in AWS cloud server. The time duration for which the pump motor must be operated is calculated from the HP(Horse Power) of the motor. For example, a pump motor of 1HP or 750W, pumps at the rate of 56 liters/minute. The time duration has been calculated in the locally in the gateway for running the motor to pump calculated CWR. The pump motor is operated to supply the calculated CWR by running it for a pre-computed time duration. The relays that are connected to the pump motor are switched ON and OFF by sending RELAY10T and RELAY00T commands through GSM in the gateway.

## 5 EXPERIMENTATION

The proposed system for crop-field monitoring and automated irrigation has been tested in a crop field of Solanum melonjena (Brinjal plant) cultivated in an area of 100m<sup>2</sup> near our college campus. Four nodes that are connected to soil moisture sensors were installed in the crop field as shown in Fig. 8. A gateway connecting these sensors wirelessly is shown in Fig. 9. Other sensors such as temperature, humidity, and windspeed and the pump motor which are also installed in the field and are connected directly to the gateway. The system was observed for a period of 6 months. The microcontroller in the gateway monitored soil moisture 4 times a day. The gateway senses other climatic values when soil moisture falls below permanent wilting point; sends the sensed values to AWS server where CWR is computed; the motor is operated by the gateway for a precomputed time duration based on CWR.

The snapshot of the table shown in Fig. 10 lists CWR values for 6 months, sensed 4 times everyday. In a traditional irrigation system, the farmer of the crop field watered the plants by operating the motor for 30 minutes. Over a period of six months, the amount of water used for irrigating the crops by the farmer



**Fig. 8.** Soil Moisture Sensor Mote placed in the Crop Field

as well as through our proposed system were observed. Total amount of water used by traditional irrigation system over a period of 6 months is 320.193 Liters while with our smart irrigation system is 157.633 Liters. Hence, with our smart irrigation system, 162.56 Liters of water was saved. The graph shown in Fig. 11 shows the comparison of water consumed with the proposed system and the traditional system. It is evident that smart irrigation system saves around 53% of water from wastage.

The overall cost involved in setting up the proposed system in the crop field is approximately Rs.40,000. In order to cover more acres of crop field, the same setup can be used with an addition of six soil moisture sensors per acre. The additional cost incurred for extending the proposed system is only 15% of the initial setup cost. Since the pump motor is switched ON and OFF according to CWR, it is found that the proposed system saves around 30% of electrical energy as compared to the manual irrigation system.

## 6 Conclusion

Soil moisture is monitored using a sensor and when it decreases below permanent wilting point, temperature and humidity sensor readings are obtained and the specific crop water requirement has been computed. The pump motor controller module takes the crop water requirement in litres as input and operates a pump

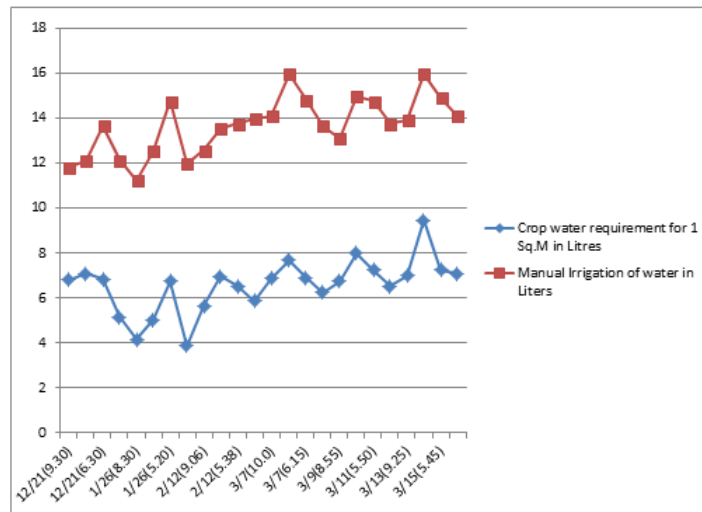

**Fig. 9.** Gateway Connected with Motor and placed in the Crop Field

Date	Timestamp	Temperature in C	Humidity in %	Windspeed in KMPH	Crop water requirement for 1 Sq.M in Litres
21-12-2017	09:30:35	26	60	5	6.814
21-12-2017	02:10:20	28	55	2	7.112
21-12-2017	06:30:42	27	59	4	6.834
21-12-2017	09:45:26	25	65	8	5.165
26-01-2018	08:30:19	22	75	4	4.153
26-01-2018	12:39:52	25	63	7	5.012
26-01-2018	05:20:57	24	66	6	6.741
26-01-2018	08:50:22	21	70	9	3.853
12-02-2018	09:06:35	24	59	8	5.654
12-02-2018	12:58:53	27	55	4	6.952
12-02-2018	05:38:23	25	58	6	6.521
12-02-2018	09:25:39	23	65	7	5.865
07-03-2018	10:00:25	26	60	6	6.842
07-03-2018	01:59:36	29	50	4	7.685
07-03-2018	06:15:43	27	51	3	6.894
07-03-2018	09:55:12	25	53	7	6.231
27-04-2018	08:50:25	27	56	4	6.753
27-04-2018	01:05:35	30	45	2	7.992
27-04-2018	05:50:55	28	48	3	7.234
27-04-2018	09:02:52	25	52	7	6.529
23-05-2018	09:25:24	28	49	4	6.991
23-05-2018	01:45:30	36	40	2	9.451
23-05-2018	05:45:15	30	42	3	7.254
23-05-2018	10:29:39	27	52	7	7.101

**Fig. 10.** CWR for a Brinjal Plant for 6 Months

motor via RF transceiver. It switches off the motor after it runs for a computed time duration to pump the required amount of water.



**Fig. 11.** Smart Irrigation System versus Traditional Irrigation System

A wireless sensor network of the sensors has been set up and the proposed approach has been tested with the prototype setup in the lab. In addition, the proposed smart irrigation system was tested in the crop field of brinjal plant for six months. With the proposed approach for smart irrigation based on CWR and climatic parameters, it is proved that 53% of water can be saved when compared to traditional irrigation methods using generic recommendations. Moreover, this system proves to be cost effective and proficient in conserving water and reducing its wastage.

Scenarios such as dry motor, absence of power supply and shortage of water supply must be considered and are to be developed in future.

## References

1. Nisha, G., Megala, J.: Wireless Sensor Network Based Automated Irrigation And Crop Field Monitoring System. In: Sixth International Conference on Advanced Computing (ICoAC), pp. 189–194, (2014)
2. Morais, R., Valente, A., Serdio, C.: A Wireless Sensor Network for Smart Irrigation and Environmental Monitoring: A Position Article. In: 5th European federation for information technology in agriculture, food and environment and 3rd world congress on computers in agriculture and natural resources (EFITA/WCCA), pp. 845–850, (2005)
3. Tanveer, A., Choudhary, A., Pal, D., Gupta, R., Husain, F.: Automated Farming Using Microcontroller And Sensors, International Journal of Scientific Research and Management Studies (IJSRMS), 2(1), pp. 21–30, (2015)

4. Jiao, J., Ma, H.M., Qiao, Y., Du, Y.L., Kong, W., Wu, Z.C.: Design of Farm Environmental Monitoring System Based on the Internet of Things, *Advance Journal of Food Science and Technology*, 6(3), pp. 368–373, (2014)
5. Pavithra, D.S., Srinath, M.S.: GSM based Automatic Irrigation Control System for Efficient Use of Resources and Crop Planning by Using an Android Mobile, *IOSR Journal of Mechanical and Civil Engineering (IOSR-JMCE)*, 11(4), pp. 49–55, (2014)
6. Darshna, S., Sangavi, T., Mohan, S., Soundharya, A., Desikan, S.: Smart Irrigation System, *IOSR Journal of Electronics and Communication Engineering (IOSR-JECE)*, 10(3), pp. 32–36, (2015)
7. Naik, P., Kumbi, A., Vishwanath Hiregoudar, C.N., Pavitra HK, S.B., Sushmita JH, P.K.: Arduino Based Automatic Irrigation System Using IoT, *International Journal of Scientific Research in Computer Science, Engineering and Information Technology IJSRCSEIT*, 2(3), pp. 881–886, (2017)
8. Kumar Verma, A., K, B., Akhil, V., Singh, A.: Wireless network based smart irrigation system using IOT, *International Journal of Engineering & Technology*, 7(1.1), pp. 342–345, (2018)
9. Rao, R.N., Sridhar, B.: IoT Based Smart Crop-field Monitoring and Automation Irrigation System. In: *Second International Conference on Inventive Systems and Control ICISC*, pp. 478–483, (2018)
10. Banumathi, P., Saravanan, D., Sathiyapriya, M., Saranya, V.: An Android Based Automatic Irrigation System Using Bayesian Network with SMS and Voice Alert, *International Journal of Scientific Research in Computer Science, Engineering and Information Technology IJSRCSEIT*, 2(2), pp. 573–578, (2017)
11. Bharathi, G., Prasunamba, C.G.: Automatic Irrigation System for Smart City Using PLC AND SCADA, *International Journal of Scientific Research in Computer Science, Engineering and Information Technology IJSRCSEIT*, 2(4), pp. 309–314, (2017)
12. Kumar, B.D., Srivastava, P., Agrawal, R., Tiwari, V.: Microcontroller Based Automatic Plant Irrigation System, *International Research Journal of Engineering and Technology (IRJET)*, 4(5), pp. 1436–1439, (2017)
13. Pooja, P., Pranali, D., Asmabi, S., Priyanka, N.: Future Of The Drip Irrigation System: A Proposed Approach, *Multidisciplinary Journal of Research in Engineering and Technology*, 4(1), pp. 1055–1060, (2017)
14. Allen, R.G., Pereira, L.S., Raes, D., Smith, M.: *Crop evapotranspiration-Guidelines for computing crop water requirements-FAO Irrigation and drainage*, International Commission for Irrigation and Drainage, 300(9), (1998)
15. Doorenbos, J. and Pruitt, W.O.: *FAO Irrigation and Drainage*, Food and Agriculture Organization of the United Nations Rome, 1977