



**HAL**  
open science

## GPS-Based Control of a Land Vehicle

Lionel Cordesses, Benoît Thuilot, Philippe Martinet, Michel Berducat

► **To cite this version:**

Lionel Cordesses, Benoît Thuilot, Philippe Martinet, Michel Berducat. GPS-Based Control of a Land Vehicle. 16th International Symposium on Automation and Robotics in Construction, Sep 1999, Madrid, France. 10.22260/ISARC1999/0006 . hal-02465622

**HAL Id: hal-02465622**

**<https://inria.hal.science/hal-02465622v1>**

Submitted on 4 Feb 2020

**HAL** is a multi-disciplinary open access archive for the deposit and dissemination of scientific research documents, whether they are published or not. The documents may come from teaching and research institutions in France or abroad, or from public or private research centers.

L'archive ouverte pluridisciplinaire **HAL**, est destinée au dépôt et à la diffusion de documents scientifiques de niveau recherche, publiés ou non, émanant des établissements d'enseignement et de recherche français ou étrangers, des laboratoires publics ou privés.

## GPS-BASED CONTROL OF A LAND VEHICLE

L. Cordesses<sup>++</sup>, P. Martinet<sup>\*</sup>, B. Thuilot<sup>\*</sup>, M. Berducat<sup>\*\*</sup>

<sup>+</sup> *IEEE Student Member*

<sup>\*</sup> *LASMEA - UMR6602 du CNRS  
24 avenue des Landais 63177 Aubière Cedex, France  
Lionel.Cordesses@lasmea.univ-bpclermont.fr*

<sup>\*\*</sup> *Cemagref - BP50085  
24 avenue des Landais 63172 Aubière Cedex, France  
Michel.Berducat@cemagref.fr*

**Abstract:** An accurate localization system (Carrier Phase differential GPS receiver) allows the design and implementation of an absolute vehicle guidance system. The preliminary work, presented in this paper, was aimed at validating the use of one GPS receiver in a vehicle guidance system, without any orientation sensor. We designed and implemented a non linear control law to perform a line-following task. Real-time experiments have been carried out on a combine harvester.

**Keywords:** GPS sensor, mobile robot, non linear robot control, localization

### 1. INTRODUCTION TO AUTOMATIC FARM VEHICLE GUIDANCE

Most of the agricultural tasks rely on an accurate vehicle guidance, from the seeding to the harvesting of large areas. The driver -a human being- simultaneously trims various implements according to many factors (crop density, humidity...)

The need for automatic vehicle guidance systems seems obvious on a harvester: the driver would only have to finely tune different functions of the machine. The guidance system would achieve a very accurate positioning, thus insuring neither overlapping nor missing areas. Another field of interest for such a system would be the precise positioning of fertilizers on crops. Many situations could be reported. Most of them could be classified as two categories.

The first one is a "previously-recorded" path-following task. The implement or machine must follow a previously recorded three dimensional trajectory.

In the second one, the implement or machine must

follow a new curve. This new reference is computed from the last passage plus an offset (the tool length for instance). We could also mention new possibilities, such as optimal attack point search, or automatic half-turn for driver assistance.

A recent technological development allows accurate three dimensional (3D) positioning of the vehicle in a field without the need for buried cables, field-installed beacons or video sensors: the Global Positioning Systems (GPS). Today, flow control devices are coupled to a GPS to produce a yield map. It allows farmers to adjust seed, pesticide, and fertilizer to each field location. This sensor also allows the design and implementation of an absolute vehicle guidance system with the availability of a very accurate positioning system (about one centimeter standard deviation from the mean). This technology can be used in special operations, in which the vision system is unable to proceed, for instance, in a spraying or fertilizing operation with no visible markers such as boom wheel tracks or foam marks. Researches have been

carried out in this area, using fiber optic gyroscopes (FOG) and GPS [4]. Promising results have been reported where an "all-GPS" solution has been preferred [6].

First of all, we will describe the information required to achieve line following control of a farm vehicle. We will then focus on GPS receivers, and will relate their performances to the control task. After introducing with the kinematic model of the harvester, a non linear control law will be derived. And last, we will discuss the control results gathered during the first experiments carried out on the harvester.

## 2. GPS CONTROL OF FARM VEHICLES.

### 2.1 Overview of the control system

One can describe the pose of the vehicle by its position and its orientation. This means a six dimensional vector (a 3D position and a 3D orientation both lead to three dimensional vectors). A general purpose farm vehicle guidance system would thus be aimed at controlling the vehicle with respect to this reference. We plan to develop a 3D control law in near future. But, in the scope of this paper, we will only consider the case of a two dimensional world. In the sequel, we will describe the position of the farm vehicle by its two coordinates in a horizontal plane. The only attitude parameter will be the heading of the farm vehicle. Further description of the vehicle modeling will be presented in the following sections. The purpose of any closed-loop system is to ensure convergence of one or more parameters. In our case, a path following problem, the reference path is a straight line. The frame  $[W, Z_w, X_w]^T$  has been chosen so that the reference is the axis  $[W, Z_w]$ .

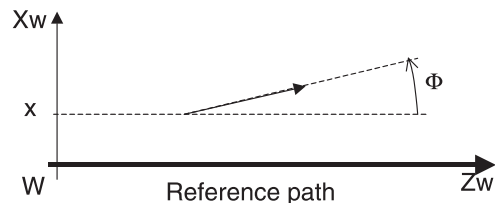

Figure 1. purpose of the vehicle guidance system

The closed-loop system we have developed is therefore aimed at zeroing both the lateral deviation ( $x$ ) and the heading ( $\phi$ ) (see Figure 1). Now, let us consider the physical information needed to proceed.

First of all, one needs the equations of the reference path. This information is up to the user. It can either be a straight line on a map (our current choice) or a curved path following the border of

a field. The accurate position of the vehicle -of a point of the vehicle- is the second information. And last, the servoing scheme makes use of the orientation of the vehicle, the heading previously mentioned.

We are going to present the sensor we have chosen, and explain how we can derive all these information using the GPS receiver as the only<sup>1</sup> exteroceptive sensor.

### 2.2 GPS receiver as the main sensor.

A brief explanation of the Global Positioning System [7] will lead us to choose the so-called Real-Time Kinematic system (RTK). GPS is the acronym for Global Positioning System. It is an American, military localization and time-transfer system. It relies upon a constellation of twenty-four satellites orbiting the Earth. The three dimensional position of an antenna can be estimated thanks to range measurements from satellites simultaneously in view. The accuracy a civil user can expect is about one hundred meters, due to the Department of Defense (DOD) degradation of the civilian ranging signal. Three satellites are needed to solve for equations and get a 3D position. As the local clock offset of the receiver is usually unknown, a fourth satellite is required to determine this parameter. In order to lower the standard deviation from the mean of the 3D estimated position, one can use two receivers and differential measurements. The first receiver is the reference station (often called base station) (Figure 2).

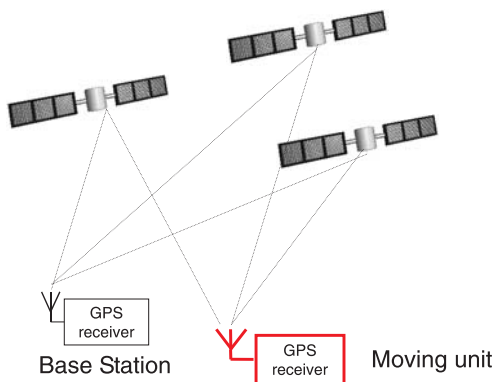

Figure 2. differential GPS

It is either located on Earth at a known location or on a geostationary satellite. The moving unit corrects its own estimated position using updated information from the base station. The average standard deviation from the mean for such a system is about one meter. The accuracy of differential GPS is sufficient for most agricultural mapping applications [1]. And nowadays, many farm

<sup>1</sup> A proprioceptive one is used in the wheels servoing loop.

vehicles are shipped with embedded differential GPS receivers that record yield maps.

Although both systems (absolute GPS and differential GPS) use ranging signals from satellites, another kind of information can be used to increase localization precision. Differential receivers can also take into account for the phase of the received signal, thus allowing a one centimeter differential positioning. As these receivers work in real-time (for instance, at 10 Hz) with a relatively low latency (about 0.1 s), their use in real-time control of farm vehicles is possible. Various implementations of tractor guidance system have been presented in the last years, some relying upon Fiber Optic Gyroscope (FOG) [5] for orientation estimation, other on GPS-based attitude determination systems<sup>2</sup> [3]. We have chosen to use a single GPS to perform closed-loop control of the farm vehicle. Thus, the only information available from the receiver are :

- the 3D position of the antenna
- the 3D velocity vector of the antenna

Thanks to the latter information and an hypothesis on the movement, one can estimate a raw global orientation of the vehicle, or an orientation relative to the reference path. The reference used in our system is a straight line defined in the Lambert II reference coordinates system. Lambert is the French geographic reference coordinates system.

We have designed a control law based upon the kinematic model of the harvester. We are first going to give some results about this kinematic model. And then we will introduce the choices we made to derive the control law.

### 3. NON LINEAR CONTROL LAW DESIGN.

#### 3.1 Kinematic model of the harvester.

We used the kinematic model of the harvester. From a practical point of view, the harvester can be considered as a rear wheel bicycle model. The theoretical description can be found in [2]. The configuration of the harvester can be described without ambiguity by the triplet  $X = (z, x, \phi)^T$ , with :

- $(z, x)$  : coordinates of the vehicle front axle center (denoted as  $O$  on Figure 3) in the reference frame  $[W, Z_w, X_w]$ ,
- $\phi$  : vehicle heading. More precisely,  $\phi$  is defined as the orientation of the vehicle axle with respect to  $[W, Z_w]$ , see also Figure 3.

Two control variables are available, namely  $U = (v, \delta)^T$ , with :

- $v$  : linear velocity at point  $O$  (the control variable is actually the rotation velocity of the front wheels, from which the value of  $v$  can be inferred).
- $\delta$  : orientation of the rear wheels (assumed to be superposed, see Figure 3).

The vehicle kinematic equations are derived according to two assumptions: pure rolling & non-slipping assumptions, and rigid body assumptions. The former imposes that the linear velocity vector at point  $O$  is directed along the vehicle axle. The latter implies that an instantaneous rotation center exists (IRC). Combining these two results, we infer that it is located on the wheels axle. When the vehicle movement is a translation, this IRC moves towards infinity.

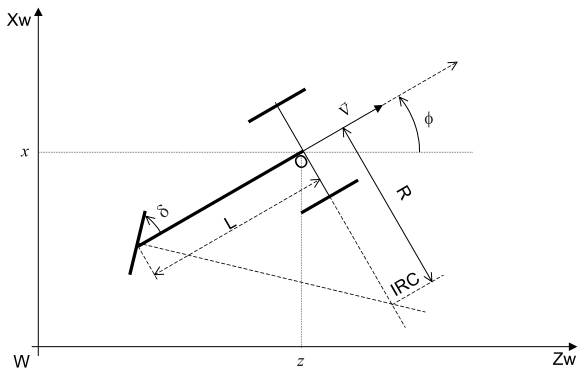

Figure 3. kinematic model of the harvester

One can now derive the kinematic equations of the harvester. One can notice that the kinematic model of the harvester is clearly non linear :

$$\begin{cases} \dot{z} = v \cos \phi \\ \dot{x} = v \sin \phi \\ \dot{\phi} = -\frac{v \tan \delta}{L} \end{cases} \quad (1)$$

#### 3.2 Non linear control law.

The objective of the control law we designed is to achieve path following under the simplifying assumption: the harvester linear velocity  $v$  is assumed to be constant, and the reference path is a straight line, as stated above.

These assumptions are those of our very first experiments, as reported in the next section. Nevertheless, the design of the control law is based upon general results in Automatics, namely chained systems theory, see for instance [8]. So, one can extend the control law presented in this paper to more general path following problem.

Control laws could be derived from first order development of the kinematic model equations. The non linear model is then approximated by

<sup>2</sup> using several GPS antennas.

a linear one, and the linear systems theory can be used to design the control law. This is the tangent linearization approach. Nevertheless, since this control law is derived from an approximation of the system equations, it is therefore valid only locally around the configuration chosen to perform linearization. As, in our case, the initial conditions may be far away from the reference path, tangent linearization cannot be used.

Recent researches deal with obtaining -if possible- state and control variables changes which convert without any approximation non linear systems into linear ones (exact linearization approach). Unfortunately, mobile robots cannot be exactly linearized [10]. However, it has been proved that one can convert these non linear systems in almost linear systems, termed as chained form. We have used this chained form as it allows us to design the control law using, for a large part, linear systems theory. The harvester model (1) can be converted into chained form using the following state diffeomorphism and change of control variables :

$$Y = \begin{pmatrix} y_1 \\ y_2 \\ y_3 \end{pmatrix} = \Theta(X) = \begin{pmatrix} z \\ x \\ \tan \phi \end{pmatrix} \quad (2)$$

$$W = \begin{pmatrix} w_1 \\ w_2 \end{pmatrix} = \Upsilon(U) = \begin{pmatrix} v \cos \phi \\ -\frac{1}{L \cos^2 \phi} v \tan \delta \end{pmatrix} \quad (3)$$

These transformations are invertible as long as  $v \neq 0$ . The harvester chained model writes then as :

$$\begin{cases} \dot{y}_1 = w_1 \\ \dot{y}_2 = y_3 w_1 \\ \dot{y}_3 = w_2 \end{cases} \quad (4)$$

In order to get a velocity independent control law, one can replace the time derivative in (4) by a derivation with respect to  $z$ , the curvilinear abscissa along  $[W, Z_w]$ . The normalized model looks like :

$$\begin{cases} y_1' = 1 \\ y_2' = y_3 \\ y_3' = w_3 \end{cases} \quad \text{with } w_3 = \frac{w_2}{w_1} \quad (5)$$

The lower part of model (5) is completely linear, so it can be brought to zero using the following control law :

$$w_3 = -K_d y_3 - K_p y_2 \quad (K_p, K_d) \in \mathcal{R}^{+2} \quad (6)$$

One can check, reporting (6) in (5), that one has :

$$y_2'' + K_d y_2' + K_p y_2 = 0 \quad (7)$$

which implies that both  $x$  and  $\phi$  converge to zero. As the above error dynamics is expressed with respect to  $z$ , the resulting trajectories are velocity

independent. Reporting (6) in (3), the real control is :

$$\delta = \arctan((K_d \tan \phi + K_p x) L \cos^3 \phi) \quad (8)$$

Unfortunately, this control law did not prevent from actuator saturation. We have therefore saturated  $w_3$  (and thus  $\delta$ ) using a sigmoid. The stability is preserved [9]. The new expression of the control law is:

$$\delta(x, \phi) = \arctan \left( K L \cos^3 \phi \frac{1 - e^{-k(K_d \tan \phi + K_p x)}}{1 + e^{-k(K_d \tan \phi + K_p x)}} \right) \quad (9)$$

This control law can be saturated to any arbitrary  $\delta_{max}$  by tuning  $K$ .

## 4. FIRST RESULTS.

### 4.1 Real-time implementation of the control law on a harvester.

**GPS receiver.** All the trials have been carried out with a Dassault-Sercel, dual-frequency Aquarius 5002 system. This is a real-time kinematic carrier-phase differential GPS. Its short initialization time (lower than 30 seconds), its high performance radio link, allow its use in agricultural vehicles. The system produces measurements at 10 Hz. It also computes the 3D velocity vector thanks to Doppler measurements on both GPS frequencies. The reference station transmits differential corrections every second. The modulation relies upon a Gaussian Mean Shift Keying (GMSK) and the bit rate is 4800 bits/s.

**Hardware controller.** The control law is implemented on a laptop personal computer (PC1). Three dimensional positions and velocities are received through a serial port (9600 baud). The computer performs various tasks :

- coordinates transformation (WGS841 to Lambert II),
- orientation estimation,
- lateral deviation computation,
- control reckoning of the rear wheels angle.

The latter is then transmitted on a serial link to the second computer (PC2) (Figure 4). This hardware (based upon a 486 microprocessor) is totally devoted to the wheels servoing task. The steering valves are controlled thanks to a Pulse Width Modulation (PWM) signal.

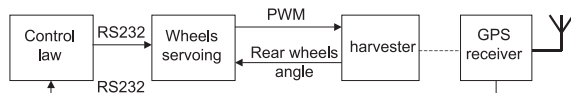

Figure 4. harvester guidance controller

From a control point of view, the whole system is described below (Figure 5).

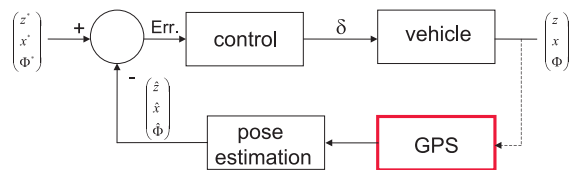

Figure 5. harvester closed-loop system

This system has been implemented and successfully tested on a CLAAS Dominator harvester.

#### 4.2 Experimental results.

Experiments have been carried out on a flat ground. The reference was a straight line. Its geometrical parameters were previously determined using the same GPS.

The vehicle velocity has been set to a constant value of 8 km/h. Once the nominal velocity was reached, the GPS-based controller was switched on. Many tests have been performed, always producing the same kind of results. One example is presented below (Figure 6). The upper curve shows the lateral deviation from the reference path versus time. The lower one plots the estimated orientation as computed from speed data, and as used by the controller. One can notice that this orientation is corrupted by noise...

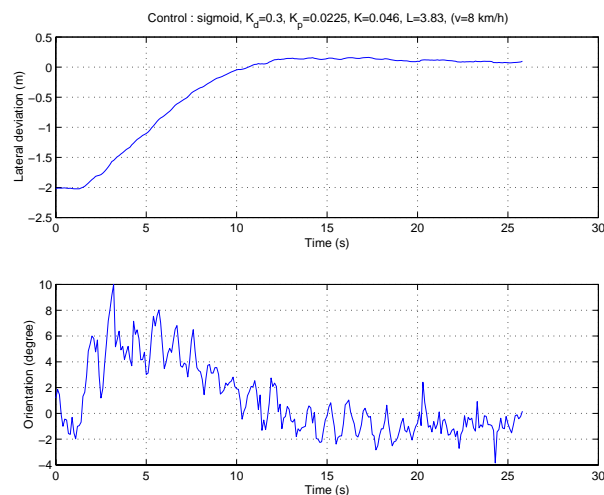

Figure 6. experimental results on the combine harvester

### 5. DISCUSSION.

First of all, data measured by the GPS receiver are the 3D position and velocity of the antenna. The velocity vector is quite noisy. Moreover, although the phase center of the antenna and the control point of the harvester are on the same vertical line, their altitudes are different (Figure 7).

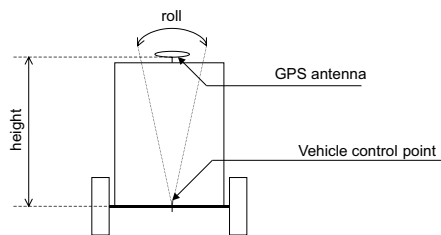

Figure 7. roll effect on the antenna position

A small roll variation produces relatively important velocity and position changes. For the time being, the attitude algorithm does not take into account for this behavior. A thorough study - a statistical and frequency analysis of these vectors - and digital signal processing may reduce this unwanted 'noise'.

Although the lateral deviation decreases, a bias still remains (less than 15 cm). This bias could be explained in a different way. As described earlier (Figure 4), the control system relies upon two closed-loops. The second one -performing the wheel servoing task- has to be finely tuned. Once this setup operation has been realized, a zero control input produces a zero heading ( $\phi=0$ ). A small offset in this loop along with a zero input (control=0) results in a bias in the complete closed-loop system ( $\phi \neq 0$ ). During the experiments, the inner closed-loop tuning may have drift, which may explain that a bias still remains in the rear wheels servoing system. We are now working on the automatic tuning of the inner closed loop.

We previously mentioned our general objective: the control of farm vehicles on an irregular ground. One can think about a more general approach, based upon 3D information instead of a 2D position. New difficulties appear: for instance, one need to accurately define a 3D reference on a 3D ground. This leads to the availability of a three dimensional map of the field.

We tried to produce such 3D maps, thanks to the same GPS receiver. The embedded system, made of a computer and a GPS unit, was set up so as to record the raw positions of the antenna. One can notice that this data recording can be automatically handled by the software, while the vehicle performs agricultural tasks. Moreover, such an approach updates the 3D points, which is an important feature for precision agriculture.

The harvester swept the field many times under various conditions :

- weather
- GPS constellation

The raw data allow sequential access to the  $(x, y, z)^T$  triplets. These information have been resampled at a constant stride to ease random retrieving of the height in an application, for any  $(x, y)$  coordinates. Under the hypothesis of

smooth height changes, one can infer an estimated elevation map without roll measurements. An example of a rough elevation map, produced thanks to the resampled data, is shown below (Figure 8).

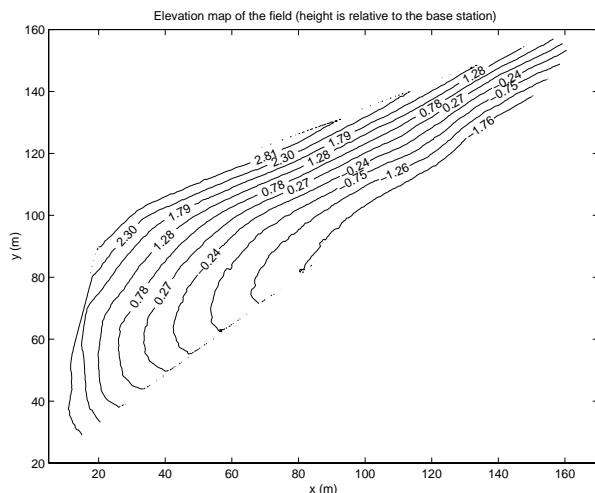

Figure 8. Elevation map of the field

We plan to use such data to simulate a new servoing algorithm, using these 'real world' information.

## 6. CONCLUSION

The aim of this paper was to study and to implement a GPS-based farm vehicle controller, without any orientation sensor. A non linear control law has been developed using the kinematic model of the harvester. This control has been implemented and tested in real-time on a harvester. The very first tests have been conducted on this system on a flat ground, producing promising results, if not perfect ones. Further research has to be done. One can mention digital signal processing of the raw estimated orientation. An extension of the control law to a curved path is also under development. Moreover, we plan to modify the control law to perform servoing tasks on an irregular ground (a 3D world).

### Acknowledgments

The authors would like to thank several groups and individuals who help us during this preliminary work: both teams from Lasmia and Cemagref. We also benefit from technical advice and equipment from F. Peyret at LCPC.

## 7. REFERENCES

- [1] R. L. Clark and R. Lee. "A comparison of rapid GPS techniques for development of topographic maps for precision farming". In *Proceedings of the 9<sup>th</sup> International Technical Meeting of the Satellite Division of the Institute of Navigation ION GPS-96*, volume 1, pages 495–504, Kansas-City, Missouri, USA, September 1996.
- [2] C. Debain. "Lois de commande pour le contrôle et la mobilité de machines agricoles". PhD thesis, Université Blaise-Pascal, Clermont-Ferrand, France, September 1996.
- [3] G. Elkaim, M. O'Connor, T. Bell, and B. Parkinson. "System identification and robust control of farm vehicles using CDGPS". In *Proceedings of the 10<sup>th</sup> International Meeting of the Satellite Division of the Institute of Navigation*, volume 2, pages 1415–1424, Kansas City, Missouri, USA, September 1997. ION-GPS-97.
- [4] Y. Nagasaka, R. Otani, K. Shigeta, and K. Taniwaki. "Automated operation in paddy fields with a fiber optic gyro sensor and GPS". In *Proceedings of the International Workshop on Robotics and Automated Machinery for Bio-Productions, BIO-ROBOTICS'97*, pages 21–26, 1997.
- [5] M. Norihisa and Toshihiro Aono. "Position estimation and path control of an autonomous land vehicle". In *Proceedings of the IEEE/RSJ International Conference on Intelligent Robots and Systems*, volume 2, pages 690–696, 1997.
- [6] M. O'Connor, G. Elkaim, T. Bell, and B. Parkinson. "Automatic steering of a farm vehicle using GPS". In *Proceedings of the International Conference on Precision Agriculture 1996*, volume 3, pages 767–777, 1996.
- [7] B. W. Parkinson. "History and operation of NAVSTAR, the Global Positioning System". *IEEE Transactions on Aerospace and Electronic Systems*, 30(4):1145–1161, October 1994.
- [8] C. Samson. "Control of chained systems Application to path following and time-varying point stabilization of mobile robots". *IEEE Transactions on Automatic Control*, 40(1):64–77, January 1995.
- [9] H. Sussmann, E. Sontag, and Y. Yang. "A general result on the stabilization of linear systems using bounded controls". *IEEE Transactions on Automatic Control*, 39(12):2411–2425, January 1994.
- [10] The Zodiac. *Theory of robot control*. Springer-Verlag Publishers, 1996.

- [1] R. L. Clark and R. Lee. "A comparison of rapid GPS techniques for development of topographic maps for precision farming". In