



**HAL**  
open science

# A DtN approach to the mathematical and numerical analysis in waveguides with periodic outlets at infinity

Sonia Fliss, Patrick Joly, Vincent Lescarret

► **To cite this version:**

Sonia Fliss, Patrick Joly, Vincent Lescarret. A DtN approach to the mathematical and numerical analysis in waveguides with periodic outlets at infinity. *Pure and Applied Analysis*, 2021, 10.2140/paa.2021.3.487 . hal-02444754

**HAL Id: hal-02444754**

**<https://inria.hal.science/hal-02444754>**

Submitted on 29 Sep 2020

**HAL** is a multi-disciplinary open access archive for the deposit and dissemination of scientific research documents, whether they are published or not. The documents may come from teaching and research institutions in France or abroad, or from public or private research centers.

L'archive ouverte pluridisciplinaire **HAL**, est destinée au dépôt et à la diffusion de documents scientifiques de niveau recherche, publiés ou non, émanant des établissements d'enseignement et de recherche français ou étrangers, des laboratoires publics ou privés.

# A DtN approach to the mathematical and numerical analysis in waveguides with periodic outlets at infinity

Sonia Fliss<sup>1,2</sup>, Patrick Joly<sup>1</sup>, and Vincent Lescarret<sup>3</sup>

<sup>1</sup>POEMS (UMR CNRS-INRIA-ENSTA Paris) ENSTA Paris 828 Boulevard des Maréchaux 91762 Palaiseau Cedex

<sup>2</sup>sonia.fliss@ensta-paris.fr

<sup>3</sup>LSS, UMR8506 CNRS-SUPELEC-UPS11, 3, rue Joliot-Curie, 91192 Gif-sur-Yvette Cedex, France.

September 28, 2020

## Abstract

We consider the time harmonic scalar wave equation in junctions of several different periodic half-waveguides. In general this problem is not well posed. Several papers propose radiation conditions, i.e. the prescription of the behaviour of the solution at the infinities. This ensures uniqueness - except for a countable set of frequencies which correspond to the resonances- and yields existence when one is able to apply Fredholm alternative. This solution is called the outgoing solution. However, such radiation conditions are difficult to handle numerically. In this paper, we propose so-called transparent boundary conditions which enables us to characterize the outgoing solution. Moreover, the problem set in a bounded domain containing the junction with this transparent boundary conditions is of Fredholm type. These transparent boundary conditions are based on Dirichlet-to-Neumann operators whose construction is described in the paper. On contrary to the other approaches, the advantage of this approach is that a numerical method can be naturally derived in order to compute the outgoing solution. Numerical results illustrate and validate the method.

**Keywords:** Helmholtz equation, periodic media, waveguides, radiation condition, Dirichlet-to-Neumann maps

**MSC Code:** 35J05, 65N22, 78A50, 78A40,78A45

## 1 Introduction

A waveguide is a structure that guides waves in one direction with minimal loss of energy. A closed waveguide is unbounded in one direction and bounded in the other directions. As important applications, let us mention first the light propagation in optical fibers for the telecommunications industry. One of the challenge is to optimize the junction between optical fibers for instance in order to maximise the transmission between 2 directions of the waveguide or to split modes in different directions. The other application concerns the ultrasonic wave propagation in cables and pipelines for non destructive testing purposes.

Time harmonic scattering problems in unbounded waveguides raise several difficulties of theoretical and numerical nature which are intricately linked. From a theoretical point of view, the difficulty concerns the definition of the physical solution that one would like to define as the unique solution of a well-posed mathematical problem. However, the time harmonic scattering problems in waveguides are in general not well posed in the classical  $L^2$  framework. This is linked to the fact that the physical solution is in general not of finite energy (we mean here finite  $L^2$  norm) since a propagation without attenuation is possible in the direction of the waveguide. On the other hand, in the  $L^2_{\text{loc}}$  framework, an infinity of solutions can be found. Usually radiation conditions which characterize the behaviour at infinity of the physical solution have to be determined and added to the problem in order to recover well-posedness. From a numerical point of view, the domain being unbounded, the difficulty is to compute the physical solution.

These difficulties are well known and solved for homogeneous acoustic waveguides (see for instance [24, 13, 12, 3, 4]). To answer to the theoretical difficulties, radiation conditions expressed thanks to a modal decomposition obtained using separation of variable techniques has been derived. Dirichlet-to-Neumann (DtN) operators, enclosing the radiation conditions, can also be introduced to reduce the problem to a problem set in a bounded domain. This formulation can then be used numerically. Finally the original problem to which is added the radiation condition or equivalently the problem set in a bounded domain with DtN conditions, are shown to be well-posed in the Fredholm sense (see [28] for more details on the Fredholm theory). More precisely, if uniqueness holds (which arises except for a countable set of frequencies, which corresponds in part to the trapped modes, see for example [6, 27]) then existence holds as well. From a numerical point of view, the formulation in a bounded domain with DtN conditions can be used. One can also use the Perfectly Matched Layer (PML) technique (first introduced in [2]) which consists in putting on each side of the computational domain an absorbing layer.

These results cannot be extended directly to periodic waveguides but lots of important contributions have been obtained on this subject the past few years. First, concerning the theoretical difficulties, one classical approach is to use the limiting absorption principle. The problem with a dissipation term (or more or less equivalently a complex frequency) is well posed in a classical setting. The physical solution of the problem without dissipation can then be defined as the limit (if it exists) of the solutions of the problems with dissipation, when the dissipation tends to 0. By studying the behaviour at infinity of this physical solution, radiation conditions can be derived. The problem without dissipation to which is added the radiation condition is shown to be well-posed, except at most for a countable set of frequencies. This approach has been used in [8, 10] for perfectly periodic waveguides using the Floquet-Bloch Transform. In [19], similar radiation conditions were derived by using a singular perturbation method, introduced in [5, Theorem 1.32]. In [15], the author has performed limiting absorption principle for periodic half-waveguides (a radiation condition could also be derived [14]). Finally, in [30, 31], a different approach based on the Kondratiev theory [20] (see also [26, 33, 21, 22]) has been used. All the results are really similar but the last one is probably the most complete in the sense that, by integrating the radiation condition in the functional space and working with spaces with detached asymptotics introduced in [32], the problem is shown to be of Fredholm-type. Nevertheless, even if these studies allow to characterize the physical/outgoing solution, none of them leads to a numerical method in order to compute the solution.

This takes us to the second difficulty: how can one restrict the computation in a bounded region?

It is well-known that PMLs do not work in periodic waveguides. Indeed, the wave interacts with the periodic heterogeneities up to infinity and this cannot be reproduced by an absorbing layer. We investigate in this paper the generalization of the DtN approach to junctions of periodic waveguides.

More precisely, we propose in this paper, through this DtN approach, to answer both to the theoretical and numerical difficulties by

1. constructing a Dirichlet-to-Neumann operator and introducing the problem set in a bounded domain with associated transparent boundary conditions;
2. showing stability (Fredholm) property for this problem;
3. deriving a numerical method to compute this solution.

The construction of the Dirichlet-to-Neumann operator is intricate because, on contrary to homogeneous media, separation of variables can no longer be used and no explicit expression of the operator can be derived in periodic media. In [16, 8], the authors consider the same problem with dissipation and construct associated Dirichlet-to-Neumann operator. The construction is already involved but it is simplified by the fact that the problem is coercive in a classical setting because of the dissipation. In these previous papers, the authors proposed a limiting absorption process without mathematical justification and without making the link with the radiation conditions. In this paper, we consider more general problems and the construction of the DtN operators and the related results are justified rigorously.

## 2 Model problem

### 2.1 Geometry of the propagation domain.

To simplify the presentation, we consider only one periodic outlet at infinity. The extension to several outlets is straightforward (see Figure 1). For instance, numerical results will be shown in Section 5 with two outlets. Let us then consider a half-waveguide which is an open connected

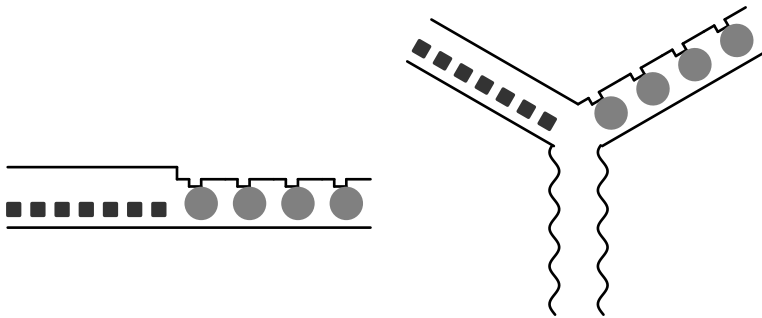

Figure 1: Domains with two or three periodic outlets at infinity

domain, unbounded in one direction and bounded in the other directions  $\Omega \subset S \times (-a, +\infty)$ . A generic point of  $\Omega$  has coordinates  $(\mathbf{x}_s, x_d)$  where  $x_d$  is the coordinate in the infinite direction of the waveguide and  $\mathbf{x}_s \in S \subset \mathbb{R}^{d-1}$  ( $d \geq 2$ ) is the coordinate in the transverse direction. The

semi-infinite part  $\Omega^+ = \Omega \cap \{x_d > 0\}$  is  $L$ -periodic ( $\Omega^+ + L \mathbf{e}_d \subset \Omega^+$ ). We denote  $\mathcal{C}_0$  the periodicity cell of  $\Omega^+$  which is defined by

$$\mathcal{C}_0 = \Omega \cap \{0 < x_d < L\} \quad \text{and} \quad \Omega^+ = \bigcup_{n \in \mathbb{N}} \mathcal{C}_n, \quad \mathcal{C}_n := \mathcal{C}_0 + nL \mathbf{e}_d$$

For the sequel, we also need to define the infinite unperturbed periodic waveguide

$$(1) \quad \Omega^\infty = \bigcup_{n \in \mathbb{Z}} \overline{\mathcal{C}_n}.$$

In an obvious way, all the interfaces  $\Gamma_n$  can be identified to  $\Gamma_0$  and all the cells  $\mathcal{C}_n$  to  $\mathcal{C}_0$ . Accordingly, with an abuse of notation, any function in  $\mathcal{C}_n$  will be identified to a function in  $\mathcal{C}_0$  through  $v(\mathbf{x}_s, x_d) \rightarrow v(\mathbf{x}_s, x_d - nL)$ . This kind of identification and abuse of notation will be systematically used in the sequel, even when not necessarily mentioned.

Let  $\Omega_0 = \Omega \setminus \Omega^+$  be the remaining part of the propagation domain and  $\Gamma_0 = \Omega \cap \{x_d = 0\}$  the interface between  $\Omega_0$  and  $\Omega^+$ . Similarly, we shall denote, for  $n \geq 1$ ,  $\Gamma_n := \Gamma_0 + nL$  the interface between  $\mathcal{C}_n$  and  $\mathcal{C}_{n+1}$ . We assume that  $\Omega$  has piecewise  $C^1$  and Lipschitz continuous boundary. Along  $\partial\Omega$ ,  $\nu$  denotes the unit normal vector, outgoing with respect to  $\Omega$ .

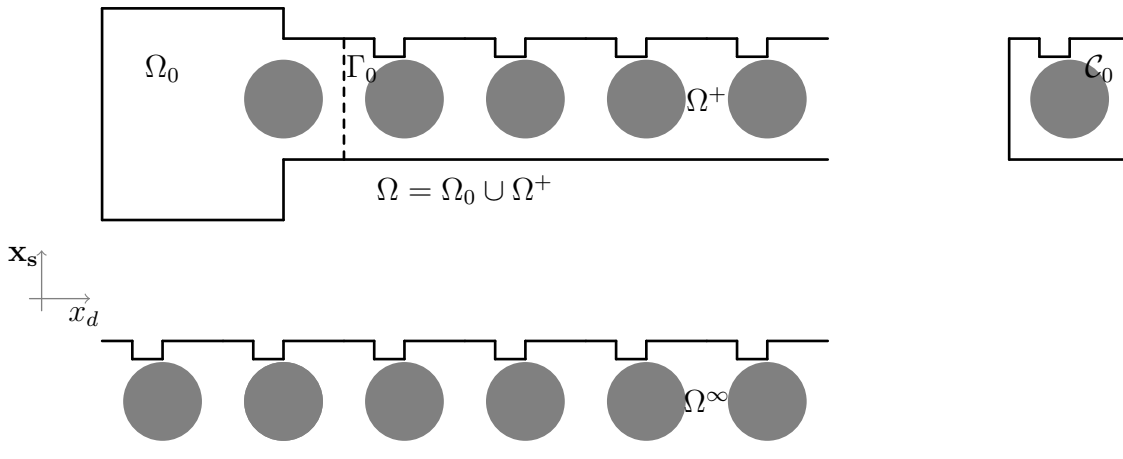

Figure 2: The domains  $\Omega$ ,  $\mathcal{C}_0$  and  $\Omega^\infty$

**Remark 2.1.** *The position of the boundary  $\Gamma_0$ , which will serve later for bounding the computational domain artificially in Section 3, or equivalently the position of the hyperplane  $x_d = 0$ , is of course artificial and can be modified provided that the domain  $\Omega^+ := \Omega \setminus \Omega_0$  coincides with a part of  $\Omega^\infty$ . Note however that changing  $\Gamma_0$  may also change the periodicity cell  $\mathcal{C}_0$ .*

## 2.2 Setting of the problem and related difficulties

We wish to solve the Helmholtz equation

$$(2) \quad \begin{cases} -\nabla \cdot (\mathbb{A} \nabla u) - \omega^2 b u = f & \text{in } \Omega \\ \mathbb{A} \nabla u \cdot \nu = 0 & \text{on } \partial\Omega \end{cases}$$

where the frequency  $\omega$  belongs to  $\mathbb{R}$  and

- the source term  $f$  is in  $L^2(\Omega)$  and has a compact support. Without loss of generalities, we suppose that its support is included in  $\Omega_0$ ;
- the medium is characterized by the anisotropy tensor  $\mathbb{A} \in (L^\infty(\Omega))^{d \times d}$  satisfying

$$\exists 0 < c \leq C, \quad \forall \xi \in \mathbb{R}^d, \quad \text{a. e. } \mathbf{x} \in \Omega, \quad c \|\xi\|^2 \leq (\mathbb{A}(\mathbf{x})\xi, \xi) \leq C \|\xi\|^2,$$

and the coefficient  $b$  that is a  $L^\infty$ -function, positively bounded from below. Both  $\mathbb{A}$  and  $b$  are  $L$ -periodic in  $\Omega^+$ . More precisely

$$\mathbb{A}|_{\Omega^+} = \mathbb{A}_p|_{\Omega^+}, \quad b|_{\Omega^+} = b_p|_{\Omega^+} \quad \text{where } \forall \mathbf{x} \in \Omega^\infty, \quad \mathbb{A}_p(\mathbf{x} + L \mathbf{e}_d) = \mathbb{A}_p(\mathbf{x}), \quad b_p(\mathbf{x} + L \mathbf{e}_d) = b_p(\mathbf{x}).$$

The difficulty for solving (2) (from both mathematical and numerical points of view) comes from frequencies  $\omega$  such that  $\omega^2$  lies in the (purely continuous) spectrum  $\sigma^\infty$  of the unbounded operator  $\mathcal{A}^\infty$  in the space  $L^2(\Omega^\infty)$  defined by

$$(3) \quad \begin{cases} D(\mathcal{A}^\infty) = \{u \in H^1(\Omega^\infty), \nabla \cdot (\mathbb{A}_p \nabla u) \in L^2(\Omega^\infty), \mathbb{A}_p \nabla u \cdot \nu|_{\partial\Omega^\infty} = 0\}, \\ \forall u \in D(\mathcal{A}^\infty), \quad \mathcal{A}^\infty u = -b_p^{-1} \nabla \cdot (\mathbb{A}_p \nabla u), \end{cases}$$

This operator appears naturally when one deals with the propagation of waves in the purely periodic waveguide  $\Omega^\infty$  but it will also play a role in our analysis. The set  $\sigma^\infty$  is a countable union of closed segments of  $\mathbb{R}^+$  that "go to  $\infty$ ". We shall describe it in much more details in Section 2.3, see (9).

The fact is, when  $\omega^2 \notin \sigma^\infty$ , except for exceptional frequencies, called *resonances* corresponding to so-called trapped modes – defined in (28) in Section 2.4 – (2) has a unique solution in  $H^1(\Omega)$  which is moreover nicely exponentially decaying at infinity (cf. the end of Section 2.3). At the contrary, when  $\omega^2 \in \sigma^\infty$ , a solution of (2) cannot be expected to vanish at infinity : one says that waves propagate up to infinity in the waveguide. Furthermore (2) is not sufficient to define  $u$  uniquely. Even if one considers only bounded solutions, the solution, if it exists, is defined up to some finite dimensional kernel. That is why a behaviour at infinity, which is no longer a decay condition, needs to be added : this is the so-called radiation condition. Several radiation conditions can be used to obtain uniqueness (and hopefully existence) but only one of them is physically relevant : the outgoing radiation condition. Such a condition is obtained by imposing that the physical solution should be the one obtained by a *limiting absorption* procedure. We shall not deal with this aspect of the theory in this paper so we refer the reader to [8, 10, 19].

**Remark 2.2.** *We have imposed Neumann boundary conditions on  $\partial\Omega$  but all what we will do can obviously be extended to any other boundary conditions which satisfy the periodicity properties of the problem in  $\Omega^+$ . The framework of our method can be used to deal with Maxwell's or elastodynamic equations or other wave propagation models, up to specific technical difficulties that could appear in the analysis.*

## 2.3 The outgoing radiation condition

As explained in the introduction, the question of the radiation conditions has been addressed by several authors : [10, 19] for periodic waveguides, [15, 8, 19] for periodic half-waveguides , [30, 31] for general domain with periodic outlets at infinity. In all cases, this radiation condition relies on

the notion of Floquet modes.

### Floquet modes.

Propagating Floquet (or Bloch) modes of the periodic waveguide  $\Omega^\infty$  are functions of the form

$$(4) \quad w(\mathbf{x}_s, x_d) = \Phi(\mathbf{x}_s, x_d) e^{ikx_d}, \text{ where } \Phi \in H_{loc}^1, \text{ L-periodic, } \Phi \neq 0, \quad k \in ]-\frac{\pi}{L}, \frac{\pi}{L}]$$

which are non trivial solutions of

$$(5) \quad -b_p^{-1} \nabla \cdot (\mathbb{A}_p \nabla w) = \omega^2 w, \quad \text{in } \Omega^\infty, \quad \mathbb{A}_p \nabla w \cdot \nu = 0, \quad \text{on } \partial\Omega^\infty.$$

Functions of the form (4) are called  $k$ - quasi-periodic. As the reader might anticipate, one cannot expect to find nonzero functions of the form that are solutions of (5) for any value of  $k$ . In fact, only finitely many values of  $k$  are possible. To see that, it is fruitful to exploit, as in [10], the link between the study propagating Floquet modes and the spectral theory of the operator  $\mathcal{A}^\infty$  defined in (3).

In the sequel, given  $\widehat{u} \in L^2(\mathcal{C}_0)$ , we shall denote by  $u \in L_{loc}^2(\Omega^\infty)$  its periodic extension to  $\Omega^\infty$ . Then, we can define the space  $H_{per}^1(\mathcal{C}_0)$  as the closed subspace of  $H^1(\mathcal{C}_0)$  defined by

$$(6) \quad H_{per}^1(\mathcal{C}_0) = \{\widehat{u} \in L^2(\mathcal{C}_0) / \nabla u \in L_{loc}^2(\Omega^\infty)\}$$

In the same way, we can define the closed subspace of  $H(\text{div}, \mathcal{C}_0)$ :

$$(7) \quad H_{per}(\text{div}, \mathcal{C}_0) = \{\widehat{\mathbf{v}} \in L^2(\mathcal{C}_0)^d / \nabla \cdot \mathbf{v} \in L_{loc}^2(\Omega^\infty)\}$$

For simplicity, we shall often use the same notation  $u$  for a function defined in  $\mathcal{C}_0$  and its periodic extension to  $\Omega^\infty$ . In this article, this can be done without any risk of ambiguity.

Next, for any  $k \in ]-\pi/L, \pi/L]$ , we introduce the unbounded operator  $\mathcal{A}^\infty(k)$  in  $L^2(\mathcal{C}_0)$  defined by

$$(8) \quad \left\{ \begin{array}{l} D(\mathcal{A}^\infty(k)) = \{u \in H_{per}^1(\mathcal{C}_0) / \mathbb{A}_p(\nabla - ik \mathbf{e}_d)u \in H_{per}(\text{div}, \mathcal{C}_0), \\ \quad \quad \quad \mathbb{A}_p(\nabla - ik \mathbf{e}_d)u \cdot \nu = 0 \text{ on } \partial\mathcal{C}_0 \cap \partial\Omega^\infty\}, \\ \forall u \in D(\mathcal{A}^\infty(k)), \quad \mathcal{A}^\infty(k)u = -b_p^{-1} (\nabla - ik \mathbf{e}_d) \cdot (\mathbb{A}_p (\nabla - ik \mathbf{e}_d)u), \end{array} \right.$$

As a self-adjoint positive operator with compact resolvent,  $\mathcal{A}^\infty(k)$  has a discrete spectrum

$$\sigma(\mathcal{A}^\infty(k)) = \{\lambda_n(k), n \in \mathbb{N}\} \quad \text{where} \quad \lim_{n \rightarrow +\infty} \lambda_n(k) = +\infty$$

whose associated eigenvectors  $\Phi_n(\cdot; k)$  form an orthonormal basis of  $L^2(\mathcal{C}_0)$ .

The curves in the  $(k, \omega)$  plane with equation  $\omega^2 = \lambda_n(k)$  are called dispersion curves of the infinite periodic waveguide.

Thanks to the Floquet Theory [23], we know that

$$(9) \quad \sigma^\infty = \bigcup_{n \in \mathbb{N}} \lambda_n([-\frac{\pi}{L}, \frac{\pi}{L}]), \quad \lambda_n([-\frac{\pi}{L}, \frac{\pi}{L}]) = [a_n, b_n], \quad a_n \rightarrow +\infty.$$

Is it easy to see that  $w$  defined by (4) is a Floquet mode, i. e. solves (5), if and only if  $\omega^2$  is an eigenvalue of  $\mathcal{A}^\infty(k)$  and  $\Phi$  an associated eigenvector. Thus, Floquet modes can exist if and only if,  $\omega$  is *propagative* frequency that is to say  $\omega^2 \in \sigma^\infty$ . As a consequence, for a propagative frequency  $\omega$ , the only possible wavenumber  $k$  of a Floquet mode must belong to the set of the propagative wavenumbers

$$(10) \quad K(\omega) := \{k \in ]-\pi/L, \pi/L] / \exists n \in \mathbb{N}, \lambda_n(k) = \omega^2\} \quad (\neq \emptyset \text{ by (9)}).$$

It is known that the set  $K(\omega)$  is finite. For  $k \in K(\omega)$  fixed, the Floquet modes at the frequency  $\omega$  which are  $k$ -quasi-periodic, form a finite dimensional vector space, namely

$$(11) \quad \mathcal{F}(\omega, k) := \{w(\mathbf{x}_s, x_d) = \Phi(\mathbf{x}_s, x_d; k) e^{ikx_d}, \Phi(\cdot, k) \in \text{Ker}(\mathcal{A}^\infty(k) - \omega^2)\}.$$

One shows easily that if  $w$  is in  $\mathcal{F}(\omega, k)$  then  $\bar{w}$  is in  $\mathcal{F}(\omega, -k)$  which implies that the set  $K(\omega)$  is symmetric with respect to the origin. Let us now denote  $\mathcal{F}(\omega)$  the space spanned by all the  $k$ -quasi-periodic Floquet modes when  $k$  describes  $K(\omega)$

$$(12) \quad \mathcal{F}(\omega) := \bigoplus_{k \in K(\omega)} \mathcal{F}(\omega, k) \text{ is finite dimensional}$$

By construction, any function in  $\mathcal{F}(\omega)$  solves (5) and if  $w \in \mathcal{F}(\omega)$ ,  $\bar{w} \in \mathcal{F}(\omega)$  too. When  $\omega^2$  is not in the spectrum  $\sigma^\infty$ , there is no propagative mode and we shall set  $\mathcal{F}(\omega) = \{0\}$ .

### Energy flux of Floquet modes : left-going and right-going modes.

The energy flux of a function  $w$  in  $\mathcal{F}(\omega)$  is defined as

$$(13) \quad q(w, w) = \text{Im} \int_{x_d=a} (\mathbb{A}_p \nabla w \cdot \mathbf{e}_d) \bar{w} d\mathbf{x}_s$$

where, as any  $w \in \mathcal{F}(\omega)$  solves (5) the integral is independent of  $a$  (Green's formula). Moreover,

$$(14) \quad \forall w \in \mathcal{F}(\omega), \quad q(\bar{w}, \bar{w}) = -q(w, w).$$

Of course  $w \mapsto q(w, w)$  defines a quadratic form on  $\mathcal{F}(\omega)$  to which we can associate a hermitian sesquilinear form (in the spirit of [32])

$$(15) \quad \forall (w, \tilde{w}) \in \mathcal{F}(\omega)^2, \quad q(w, \tilde{w}) = \frac{1}{2} \text{Im} \int_{x_d=a} \left( (\mathbb{A}_p \nabla w \cdot \mathbf{e}_d) \bar{\tilde{w}} d\mathbf{x}_s + (\mathbb{A}_p \nabla \tilde{w} \cdot \mathbf{e}_d) \bar{w} \right) d\mathbf{x}_s.$$

On the other hand, one easily sees that the  $L^2$ -inner product in  $\mathcal{C}_0$

$$(16) \quad (w, \tilde{w})_{\mathcal{C}_0} := \int_{\mathcal{C}_0} b_p w \bar{\tilde{w}} d\mathbf{x}$$

defines a scalar product in  $\mathcal{F}(\omega)$  and we can introduce the self-adjoint operator  $\mathcal{Q} \in \mathcal{L}(\mathcal{F}(\omega))$  defined by

$$(17) \quad \forall (w, \tilde{w}) \in \mathcal{F}(\omega)^2, \quad (\mathcal{Q}w, \tilde{w}) = q(w, \tilde{w}).$$

Of course,  $\mathcal{Q}$  is diagonalizable in an orthonormal basis of  $\mathcal{F}(\omega)$  and if  $w$  is a normalized eigenvector, the corresponding eigenvalue is  $\lambda = q(w, w)$ . Then, as a consequence of (14), we see that the



number of strictly positive eigenvalues of  $\mathcal{Q}$  equals the number of its strictly negative eigenvalues. Even more, if  $w$  is an eigenvector associated to  $\lambda$ ,  $\bar{w}$  is an eigenvector associated to  $-\lambda$ .

Let us now define the so-called *cut-off frequencies* or *thresholds* as the frequencies for which one of the propagating Floquet mode has a null energy flux. More precisely, this set of frequencies, denoted  $\sigma_{\text{th}}$ , is defined by

$$(18) \quad \sigma_{\text{th}} = \{\omega^2, \exists w \text{ satisfying } (4-5) / q(w, w) = 0\}.$$

In [10], this set is shown to be a discrete subset of  $\sigma^\infty$  : it correspond to the values of  $\lambda_n(k)$  at the points  $k$  where the slope of the dispersion curves  $k \in \mathbb{R} \mapsto \lambda_n(k)$  is horizontal.

If  $\omega^2$  is not in  $\sigma_{\text{th}}$ , we deduce from what precedes that 0 is not an eigenvalue of  $\mathcal{Q}$ . As a consequence, the dimension of  $\mathcal{F}(\omega)$  is  $2N(\omega)$  where  $N(\omega)$  is the number of strictly positive eigenvalues of  $\mathcal{Q}$  and we can write the orthogonal decomposition

$$(19) \quad \mathcal{F}(\omega) = \mathcal{F}^+(\omega) \oplus \mathcal{F}^-(\omega), \quad \mathcal{F}^\pm(\omega) := \text{span} \{w \in \mathcal{F}(\omega), \pm q(w, w) > 0\}$$

We can introduce an orthonormal basis (for the scalar product (16)) of  $\mathcal{F}^+(\omega)$  (resp.  $\mathcal{F}^-(\omega)$ ) made of eigenfunctions of  $\mathcal{Q}$  associated to strictly positive (resp. strictly negative) eigenvalues of  $\mathcal{Q}$

$$(20) \quad \mathcal{F}^\pm(\omega) = \text{span} \{w_1^\pm, \dots, w_{N(\omega)}^\pm\} \quad \text{with } \pm q(w_j^\pm, w_j^\pm) > 0, \text{ and } w_j^+ = \overline{w_j^-}.$$

Let us mention that by the definition (17) of  $\mathcal{Q}$ , the eigenfunctions satisfy the so-called bi-orthogonality relations

$$(21) \quad \forall j \neq \ell, \quad q(w_j^+, w_\ell^+) = 0 \quad \text{and} \quad q(w_j^-, w_\ell^-) = 0.$$

To each  $w_j^\pm \in \mathcal{F}^\pm(\omega)$ , we can associate a wavenumber  $\pm k_j \in K(\omega)$  and an index  $n_j$  such that

$$(22) \quad \lambda_{n_j}(\pm k_j) = \omega^2 \quad \text{and} \quad w_j^\pm = \Phi_{n_j}(\cdot; \pm k_j) e^{\pm i k_j x_d},$$

Moreover, in [10], it is shown that  $q(w_j^\pm, v) = \pm \lambda'_{n_j}(\pm k_j)$ .

The  $w_j^+$  (resp.  $w_j^-$ ) are called the right propagating (resp. left propagating) modes. Finally, for all  $k \in K(\omega)$ , the space  $\mathcal{F}(\omega, k)$  defined in (11) is described by

$$(23) \quad \mathcal{F}(\omega, k) = \text{span}\{w_j^+, k_j = k\} \oplus \text{span}\{w_j^-, -k_j = k\}$$

### The outgoing radiation condition and related boundary value problem.

Let us define now the operator

$$(24) \quad \mathcal{A} = -b^{-1} \nabla \cdot (\mathbb{A} \nabla \cdot), \quad D(\mathcal{A}) = \{u \in H^1(\Omega), \nabla \cdot (\mathbb{A} \nabla \cdot) \in L^2(\Omega), \mathbb{A} \nabla u \cdot \nu|_{\partial\Omega} = 0\}$$

We can now define the radiation condition for Problem (2).

**Definition 2.1.** *A solution  $u$  of (2) satisfies the outgoing radiation condition iff there exist*

- $(w, \alpha) \in H^1(\Omega^+) \times \mathbb{R}_*^+$  such that  $e^{\alpha x_d} w \in H^1(\Omega^+)$ ,
- $N(\omega)$  complex numbers  $\{a_1^+, \dots, a_{N(\omega)}^+\}$  such that

$$(25) \quad u = w + \sum_{j=1}^{N(\omega)} a_j^+ w_j^+ \quad \text{in } \Omega^+$$

The above radiation condition means that, in a certain sense,  $u$  is exponentially close, when  $x_d \rightarrow +\infty$  to a linear combination of outgoing modes

$$\sum_{j=1}^{N(\omega)} a_j^+ w_j^+.$$

For this reason, and for simplicity of the notation, the above radiation condition will be rewritten

$$(26) \quad u \underset{x_d \rightarrow +\infty}{\sim} \sum_{j=1}^{N(\omega)} a_j^+ w_j^+.$$

We can now define the correct version of the problem we wish to investigate which consists in looking for  $u \in H_{loc}^1(\Omega)$  such that

$$(27) \quad \begin{cases} -\nabla \cdot (\mathbb{A} \nabla u) - \omega^2 b u = f & \text{in } \Omega, & (i) \\ \mathbb{A} \nabla u \cdot \nu = 0 & \text{on } \partial\Omega, & (ii) \\ \exists (a_1^+, \dots, a_{N(\omega)}^+) \in \mathbb{C}^{N(\omega)} \text{ such that } u \underset{x_d \rightarrow +\infty}{\sim} \sum_{j=1}^{N(\omega)} a_j^+ w_j^+. & (iii) \end{cases}$$

Note that when  $\omega^2 \notin \sigma_{ess}$ ,  $N(\omega) = 0$  and the condition (27)(iii) is nothing but a condition of exponential decay at infinity.

## 2.4 About the well-posedness of the problem

The problem (27) is well defined for  $\omega^2 \notin \sigma_{th}$ . However, to show its well posedness, one needs to exclude other frequencies called resonances and associated to the possible existence of trapped modes. This set  $\sigma_{res}$  is defined via an eigenvalue problem (the homogeneous version of (2)).

$$(28) \quad \left| \begin{array}{l} \omega^2 \in \sigma_{res} \iff \exists v \neq 0 \in H^1(\Omega) \text{ such that} \\ \begin{cases} -\nabla \cdot (\mathbb{A} \nabla v) - \omega^2 b v = 0 & \text{in } \Omega \\ \mathbb{A} \nabla v \cdot \nu = 0 & \text{on } \partial\Omega \end{cases} \end{array} \right.$$

Roughly speaking, the associated trapped modes  $v$  are confined in a neighborhood of  $\Omega_0$ .

**Remark 2.3.** *By using analytic Fredholm theory (Steinberg's theorem) (mimicking for instance the approach of [15] for the half-waveguide problem), it is possible to show that the set of resonances  $\sigma_{res}$  is discrete in  $\mathbb{R} \setminus \sigma_{th}$ .*

We can now state the uniqueness result for (27).

**Theorem 2.4.** *If  $\omega^2 \notin \sigma_{res} \cup \sigma_{th}$ , the solution of (27) is unique.*

*Proof.* For the ease of the reader, we give the proof of the uniqueness result that exploits the properties of the energy fluxes of the Floquet modes explained in Section 2.3. Let us consider a solution  $u$  of (27) with  $f = 0$ . Multiplying (27)-(i) by  $\bar{u}$ , integrating in  $\Omega_R = \Omega \cap \{x_d < R\}$  for  $R > 0$ , applying twice Green's formula and using that  $\bar{u}$  satisfies also (27)-(i) with  $f = 0$  in  $\Omega_R$ , one gets

$$\int_{x_d=R} \mathbb{A}_p \nabla u \cdot \mathbf{e}_d \bar{u} \, d\mathbf{x}_s = 0$$

As  $u$  satisfies the radiation condition, it can be rewritten as in (25) and we deduce that

$$\begin{aligned} \sum_{j=1}^{N(\omega)} |a_j^+|^2 q(w_j^+) + \sum_{n=1}^{N(\omega)} \operatorname{Im} \int_{x_d=R} \mathbb{A}_p \nabla w \cdot \mathbf{e}_d \overline{a_j^+ w_j^+} \, ds + \sum_{n=1}^{N(\omega)} \operatorname{Im} \int_{x_d=R} \mathbb{A}_p \nabla (a_j^+ w_j^+) \cdot \mathbf{e}_d \bar{w} \, ds \\ + \operatorname{Im} \int_{x_d=R} \mathbb{A}_p \nabla w \cdot \mathbf{e}_d \bar{w} \, ds = 0 \end{aligned}$$

As  $w$  is exponentially decaying at infinity, the three last terms of the equality tend to 0 when  $R$  tends to infinity. We end up with

$$\sum_{n=1}^{N(\omega)} |a_j^+|^2 q(w_j^+) = 0$$

where  $q(w_j^+) > 0$  by definition of the right propagating modes  $w_j^+$ . This implies that  $a_j^+ = 0$  for all  $n$ . So  $u = w \in H^1(\Omega)$  is solution of (27) with  $f = 0$ . As  $\omega^2 \notin \boldsymbol{\sigma}_{\text{res}}$ , this implies that  $u = 0$ .  $\square$

The existence result is not as easy to prove. Thanks to the above uniqueness result, it suffices to prove that the problem is equivalent to (or can be reduced to) a Fredholm type problem. Using the Kondratiev's theory, the framework of weighted Sobolev spaces and Fredholm's alternative, it was proven in [30, 31] that (27) is well posed for  $\omega^2 \notin \boldsymbol{\sigma}_{\text{res}} \cup \boldsymbol{\sigma}_{\text{th}}$ . As this proof is not constructive, one can hardly see how it can lead to a numerical method. The DtN approach that we shall develop in this paper, precisely aims at giving a numerical method and a by-product is that it is an alternative proof of the existence result for (27) : see Theorem 3.8, Section 3.2.

### 3 Reduction to a bounded domain

The objective of the next two sections, which are the main sections of the article is to provide a problem posed in the domain  $\Omega_0$  (cf. Section 2.1 and Figure 2) which is equivalent to the problem in the sense that it provides, under the assumptions of Theorem 2.4 the restriction to  $\Omega_0$  of the solution of (27). The idea is to replace the presence of the half-waveguide  $\Omega^+$  by a boundary condition, called *transparent* condition, on the artificial boundary  $\Gamma_0$ . Moreover, as a by-product, we shall provide a method that allows us to reconstruct the solution in the infinite half-waveguide  $\Omega^+$ .

There are many ways to write a transparent condition. In the spirit of what was done in [16] for the dissipative case we shall look for a transparent condition of DtN form, namely of the form

$$(29) \quad \mathbb{A} \nabla u \cdot \mathbf{e}_d + \Lambda u = 0,$$

where  $\Lambda$  is a Dirichlet-to-Neumann (DtN) operator, that maps  $H^{1/2}(\Gamma_0)$  into  $H^{-1/2}(\Gamma_0)$ , and requires to be appropriately defined.

In the recap on the mathematical analysis of problem (27), we were led to exclude two particular sets of values of the frequency  $\omega$  that correspond to real **physical obstructions** to the existence and uniqueness of the solution of (27), namely

- the *thresholds frequencies*  $\omega^2 \in \sigma_{\text{th}}$ , see (18) that are only related to the purely periodic waveguide  $\Omega^\infty$ . We recall that  $\sigma_{\text{th}}$  is discrete.
- the *resonances* are associated to so-called *trapped modes* which depend on the material and the geometrical properties of  $\Omega$  and more precisely of the bounded region where the perturbed half-waveguide  $\Omega$  differs from the periodic waveguide  $\Omega^\infty$  : these correspond to  $\omega^2 \in \sigma_{\text{res}}$ . This is again a countable set which can be empty and generally expected to be finite (even though we are not aware on mathematical results in this direction).

For the presentation of the DtN method, we shall be led to exclude two additional, but **artificial** set of frequencies, namely, by order of their apparition in the forthcoming section

- the *edge resonances*  $\iff \omega^2 \in \sigma_{\text{edge}}^+$  (see (32, 33)): these are associated to *edge states* which are the equivalent, for the half-waveguide problem with Dirichlet condition on  $\Gamma_0$ , of the resonances for the original problem (2). The set  $\sigma_{\text{edge}}^+$  is again countable and generally expected to be finite.
- the *Dirichlet cell frequencies*  $\iff \omega^2 \in \sigma_{\text{cell}}$  (see (60, 61)). These correspond to the case where  $\omega^2$  coincides with one of the eigenvalues of the "Dirichlet" problem posed in the unit cell  $\mathcal{C}_0$  : they form a sequence tending to  $+\infty$ .

Contrary to  $\sigma_{\text{res}}$  and  $\sigma_{\text{th}}$ , the sets  $\sigma_{\text{edge}}^+$  and  $\sigma_{\text{cell}}$  are artificial in the sense that they do not come from the physics of the original problem but are linked to the method that we have chosen to achieve the reduction to a bounded domain, in our case the DtN method. These are typically the equivalent of the famous interior eigenvalues that appear when one wants to solve a classical obstacle (Dirichlet) scattering problem in a homogeneous medium by an integral equation approach using a single layer potential. To emphasize this fact, we have used the bold letter  $\sigma$  for the two sets  $\sigma_{\text{res}}$  and  $\sigma_{\text{th}}$ .

As it will be seen in Section 3.1, the exclusion of these artificial frequencies is required to develop the rigorous theory but this is not a real problem in practice since one avoids these frequencies when changing the position of the artificial boundary  $\Gamma_0$  (see also Assumption **A**, Section 3.1 and Remark 4.2) .

Alternative solutions are Neumann-to-Dirichlet (NtD) (resp. Robin-to-Robin (RtR)) transparent conditions. In the case of dissipative media, these as presented in [8] for the NtD method and [9] for the RtR one (see also Remark 3.2). Note that the artificial frequencies for the NtD method are a priori different from the ones for the DtN method. They even do not exist anymore if one uses the RtR (Robin to Robin) method (cf. Remark 3.2 again). We have chosen to present the DtN method essentially for the simplicity of its exposition and of its implementation, in particular with respect to the RtR method.

### 3.1 The half-waveguide problem and definition of the DtN operator

Considering the problem (27) and since the source term  $f$  is supported inside  $\Omega_0$ , in order to characterize the restriction to  $\Omega^+$  of the solution  $u$  of (27), it is natural to introduce the following

Dirichlet half-waveguide problem, with data  $\varphi \in H^{1/2}(\Gamma_0)$

$$(30) \quad \begin{cases} -\nabla \cdot (\mathbb{A}_p \nabla u^+) - \omega^2 b_p u^+ = 0 & \text{in } \Omega^+, & (i) \\ \mathbb{A}_p \nabla u^+ \cdot \nu = 0 & \text{on } \partial\Omega^+ \cap \partial\Omega, & (ii) \\ u^+ = \varphi & \text{on } \Gamma_0, & (iii) \\ \exists (a_1^+, \dots, a_{N(\omega)}^+) \in \mathbb{C}^{N(\omega)} \text{ such that } u \underset{x_d \rightarrow +\infty}{\sim} \sum_{n=1}^{N(\omega)} a_n^+ w_n^+. & (iv) \end{cases}$$

Assuming that (30) is well-posed, it is clear that, provided that  $\varphi$  is the trace of  $u$  on  $\Gamma_0$ , *i.e.*  $\varphi = u|_{\Gamma_0}$ , then  $u = u^+(\varphi)$  in  $\Omega^+$ . From the continuity of  $u$  and  $\mathbb{A}_p \nabla u \cdot \mathbf{e}_d$  across  $\Gamma_0$  we deduce that  $u$  satisfies the DtN condition (29) provided that the operator  $\Lambda$  is defined by

$$(31) \quad \forall \varphi \in H^{1/2}(\Gamma_0), \quad \Lambda \varphi := -\mathbb{A} \nabla u^+(\varphi) \cdot \mathbf{e}_d|_{\Gamma_0} \in H^{-1/2}(\Gamma_0).$$

In order that (30) is well posed, we need to exclude a (possibly empty) set of parasitic frequencies, denoted  $\sigma_{\text{edge}}^+$ , which is related to the eigenvalue problem

$$(32) \quad \begin{cases} -\nabla \cdot (\mathbb{A}_p \nabla v^+) - \omega^2 b_p v^+ = 0 & \text{in } \Omega^+, \\ \mathbb{A}_p \nabla v^+ \cdot \nu = 0 & \text{on } \partial\Omega^+ \cap \partial\Omega, \\ v^+ = 0 & \text{on } \Gamma_0. \end{cases}$$

The set  $\sigma_{\text{edge}}^+$  is then defined as

$$(33) \quad \sigma_{\text{edge}}^+ = \{\omega^2 \in \mathbb{R}, \quad \exists v^+ \in H^1(\Omega^+), v^+ \neq 0 \text{ satisfying (32)}\}.$$

In the literature, the set  $\sigma_{\text{edge}}^+$  is often called the set of edge-resonances (see [17, 34] for instance). The associated trapped modes are confined in a neighborhood of the boundary  $\Gamma_0$ . According to [15], the set  $\sigma_{\text{edge}}^+$  is *discrete* in  $\mathbb{R}^+ \setminus \sigma_{\text{th}}$ .

**Remark 3.1.** Assume the periodicity cell satisfies  $\mathbf{x} + \frac{L}{2} \mathbf{e}_d \in \mathcal{C}_0 \Leftrightarrow -\mathbf{x} + \frac{L}{2} \mathbf{e}_d \in \mathcal{C}_0$  and the coefficients  $A_p$  and  $b_p$  have similar symmetry properties :

$$(34) \quad \mathbb{A}_p(\mathbf{x} + \frac{L}{2} \mathbf{e}_d) \mathbb{P} = \mathbb{P} \mathbb{A}_p(-\mathbf{x} + \frac{L}{2} \mathbf{e}_d), \quad \text{and} \quad b_p(\mathbf{x} + \frac{L}{2} \mathbf{e}_d) = b_p(-\mathbf{x} + \frac{L}{2} \mathbf{e}_d)$$

where  $\mathbb{P}$  is the linear involution (symmetry) in  $\mathbb{R}^d$  such that  $\mathbb{P} \mathbf{e}_i = \mathbf{e}_i$  for  $i < d$ ,  $\mathbb{P} \mathbf{e}_d = -\mathbf{e}_d$ . Then using a symmetry argument, it can be shown that the set of edge resonances is empty (this is linked to the absence of the point spectrum of the periodic operator  $\mathcal{A}^\infty$ , proven in [29, 38, 11]). Moreover, in that case, the proof of Theorem 3.3 becomes straightforward thanks to the image principle.

**Remark 3.2.** The assumption  $\omega^2 \notin \sigma_{\text{edge}}$  is exclusively linked to the introduction of the Dirichlet-to-Neumann operator defined thanks to the half-waveguide problem with a Dirichlet boundary condition ( $u^+ = \varphi$ ). This can be avoided by introducing instead Robin-to-Robin transparent boundary conditions that have the form

$$(35) \quad (\mathbb{A}_p \nabla u \cdot \nu + i\alpha u) + \Lambda_r(\mathbb{A}_p \nabla u \cdot \nu - i\alpha u) = 0.$$

with typically  $\alpha = \omega$ . The corresponding half-guide problem is of the same type than before with the Dirichlet boundary condition on  $\Gamma_0$  replaced by a Robin boundary conditions ( $\mathbb{A}_p \nabla u^+ \cdot \nu + i\alpha u^+ = \varphi$ ). For  $\alpha > 0$ , the corresponding operator has no discrete spectrum.

Let us now study the well-posedness of the half-waveguide problem (30). We shall follow the approach of [19], that itself was based on the ideas of [15]. Their result were proven for  $\mathbb{A}_p = 1$  but its extension to  $\mathbb{A}_p$  non constant does not pose any additional difficulty. Both papers conclude to the well-posedness of (30) except for a countable set of frequencies. The result [19] was more precise than the one of [15] in the sense that it identified the set of frequencies to be excluded to the set  $\sigma_{\text{edge}}^+$ . However, by a thorough investigation in the proof of [19], we found a small mistake : correcting this mistake leads to exclude also another set of frequencies, as we explain now.

This leads us to introduce the second half-waveguide  $\Omega^-$  which is the complement of  $\Omega^+$  in the whole periodic domain  $\Omega^\infty$ , unbounded in the direction  $x_d < 0$ :

$$\Omega^- := \{\mathbf{x} \in \Omega^\infty / x_d < 0\} \quad (\text{remember that } \Omega^+ := \{\mathbf{x} \in \Omega^\infty / x_d > 0\})$$

Similarly to  $\sigma_{\text{edge}}^+$ , we introduce the set  $\sigma_{\text{edge}}^-$  associated with the half-waveguide  $\Omega^-$

$$\sigma_{\text{edge}}^- = \{\omega^2 \in \mathbb{R}, \quad \exists v^- \in H^1(\Omega^-), v^- \neq 0 \text{ satisfying (36)}\}$$

$$(36) \quad \begin{cases} -\nabla \cdot (\mathbb{A}_p \nabla v^-) - \omega^2 b_p v^- = 0 & \text{in } \Omega^-, \\ \mathbb{A}_p \nabla v^- \cdot \nu = 0 & \text{on } \partial\Omega^- \cap \partial\Omega^\infty, \\ v^- = 0 & \text{on } \Gamma_0. \end{cases}$$

Again, the set  $\sigma_{\text{edge}}^-$  is *discrete* in  $\mathbb{R}^+ \setminus \sigma_{th}$  ([15]). Note that, except if the symmetry conditions of Remark 3.1 are satisfied, the sets  $\sigma_{\text{edge}}^+$  and  $\sigma_{\text{edge}}^-$  have no reason to coincide !

We can now state a first result about (30). In the following,  $\sigma_{\text{edge}} := \sigma_{\text{edge}}^+ \cup \sigma_{\text{edge}}^-$ .

**Theorem 3.3.** *If  $\omega^2 \notin \sigma_{\text{edge}} \cup \sigma_{th}$ , for any  $\varphi \in H^{1/2}(\Gamma_0)$ , there exists a unique solution  $u^+ = u^+(\varphi)$  in  $H_{loc}^1(\Omega^+)$  of (30). Moreover, for any compactly supported  $C^\infty$  function  $\chi$ , the application  $\varphi \rightarrow \chi u^+(\varphi)$  is continuous from  $H^{1/2}(\Gamma_0)$  in  $H^1(\Omega^+)$ .*

*Proof.* For the uniqueness, the proof is very similar to the one of the Theorem 2.4 and will not be detailed here. Simply note that one has to use that  $\omega^2 \notin \sigma_{\text{edge}}^+$  in order to conclude.

For the existence, the proof, adapted from [15, 19] consists in reducing the resolution to a clever combination of two type of well-posed problems namely

- Homogeneous coercive Dirichlet half-waveguide problems

$$(37) \quad -\nabla \cdot (\mathbb{A}_p \nabla u_1^+) + \omega^2 b_p u_1^+ = 0 \text{ in } \Omega^+, \quad u_1^+ = g \text{ on } \Gamma_0, \quad u_1^+ \in H^1(\Omega^+)$$

for a given  $g \in H^{1/2}(\Gamma_0)$ .

- Non-homogeneous full waveguide time harmonic problems

$$(38) \quad -\nabla \cdot (\mathbb{A}_p \nabla u_2) - \omega^2 b_p u_2 = f \text{ in } \Omega^\infty, \quad u_2 \text{ is outgoing}, \quad u_2 \in H_{loc}^1(\Omega^\infty)$$

for a given  $f \in L_1^2(\Omega^\infty) := \{w \in L_{loc}^2(\Omega^\infty) / (1 + x_d^2)^{\frac{1}{2}} w \in L^2(\Omega^\infty)\}$ .

Here saying that  $u_2$  is outgoing refers to radiation conditions for  $x_d \rightarrow -\infty$  and  $x_d \rightarrow +\infty$  :

$$(39) \quad \exists (a_1^\pm, \dots, a_{N(\omega)}^\pm) \in \mathbb{C}^{N(\omega)} \text{ such that } u \underset{x_d \rightarrow \pm\infty}{\sim} \sum_{j=1}^{N(\omega)} a_j^\pm w_j^\pm.$$

In (37) and (38) and all the problems that appear in this proof, Neumann boundary conditions are imposed on  $\partial\Omega^\infty$ . The idea is then to construct the solution  $u^+$  of (30) as a difference of solutions of such problems :

$$(40) \quad u^+ := u_2|_{\Omega_+} - u_1^+ \in H_{loc}^1(\Omega^+),$$

where the data  $(g, f)$  remain to be specified. We observe that

- (i) Thanks to the (well known) exponential decay of  $u_1^+$  when  $x_d \rightarrow +\infty$ , the function  $u^+$  is automatically outgoing when  $x_d \rightarrow +\infty$ .
- (ii) From (37-38), we see that  $-\nabla \cdot (\mathbb{A}_p \nabla u^+) - \omega^2 b_p u^+ = f - 2\omega^2 b_p u_1^+$  in  $\Omega_+$ . As a consequence, in order that  $u^+$  be solution of (30), we must have

$$(41) \quad f = 2\omega^2 b_p u_1^+ \text{ in } \Omega^+,$$

which is compatible with  $f \in L_1^2(\Omega)$  thanks again to the exponential decay of  $u_1^+$ .

Defining  $f$  in  $\Omega^-$  is somewhat arbitrary and several choices are possible (see Remark 3.4). Let us follow the choice made in [19] that, by symmetry with respect to the construction of  $f$  in  $\Omega^+$ , consists in taking

$$(42) \quad f = 2\omega^2 b_p u_1^- \text{ in } \Omega^-,$$

where  $u_1^-$  solves the homogeneous coercive Dirichlet half-waveguide problem

$$(43) \quad -\nabla \cdot (\mathbb{A}_p \nabla u_1^-) + \omega^2 b_p u_1^- = 0 \text{ in } \Omega^-, \quad u_1^- = g \text{ on } \Gamma_0, \quad u_1^- \in H^1(\Omega^-).$$

- (iii) It remains to play on the boundary data  $g$  in order to ensure the Dirichlet condition which leads to  $u_2 - u_1^+ = \varphi$  on  $\Gamma_0$ . This last step gives us an equation satisfied by  $g$ .

Let us put some formalism around the above description. We denote  $S_1 \in \mathcal{L}(H^{1/2}(\Gamma_0), L_1^2(\Omega^\infty))$  the solution operator associated to (37) in  $\Omega^+$  and to (43) in  $\Omega^-$ , more precisely

$$(44) \quad \forall g \in H^{1/2}(\Gamma_0), \quad S_1 g := u_1^+ \text{ (sol. of (37)) in } \Omega^+, \quad S_1 g := u_1^- \text{ (sol. of (43)) in } \Omega^-.$$

Let  $S_2 \in \mathcal{L}(L_1^2(\Omega^\infty), H_{loc}^1(\Omega^\infty))$  and  $T_2 \in \mathcal{L}(L_1^2(\Omega^\infty), H^{1/2}(\Gamma_0))$  be respectively the solution operator associated to (38) and its composition with the trace operator on  $\Gamma_0$ . In other words

$$(45) \quad \forall f \in L_1^2(\Omega^\infty), \quad S_2 f := u_2, \quad T_2 f := S_2 f|_{\Gamma_0} \text{ where } u_2 \text{ is the solution (38).}$$

Let us recall that the fact that  $S_2$  is well defined follows from known results for the full waveguide problem when  $\omega^2 \notin \sigma_{\text{th}}$  (see for instance [15, 10, 19]). Moreover, for any compactly supported function  $\chi$ , the map  $f \rightarrow \chi S_2 f$  is continuous from  $L_1^2(\Omega^\infty)$  in  $H^1(\Omega^\infty)$ . It also follows from the above references.

Finally, we introduce  $T \in \mathcal{L}(H^{1/2}(\Gamma_0))$  defined by

$$(46) \quad T := T_2 \circ B \circ S_1, \quad \text{where } B \in \mathcal{L}(L_1^2(\Omega^\infty)) \text{ is the operator of multiplication by } -2\omega^2 b_p.$$

a). We now set  $u_1 := S_1 g$ , by (41, 42) and  $u_1|_{\Omega^\pm} = u_1^\pm$ ,  $f = B u_1 = B S_1 g$ . Thus  $u_2 = S_2 f = S_2 B S_1 g$ . Therefore, (iii) means that looking for  $u^+$  in the form (40) leads to solve the problem

$$(47) \quad \text{Find } g \in H^{1/2}(\Gamma_0) \quad \text{such that} \quad g - T g = \varphi$$

b). Reciprocally, reproducing the above approach and calculations in the opposite sense, one easily checks that if  $g$  is solution of (47), then  $u^+ := S_2 B S_1 g|_{\Omega_+} - S_1 g|_{\Omega_+}$  is solution of (30). In other words, the existence of  $g$  yields the existence of  $u^+$ .

The analysis of (47) results from the following next two steps and Fredholm's alternative :

**Step 1 :  $T$  is compact.** Let  $(g_n)_n$  be a bounded sequence in  $H^{1/2}(\Gamma_0)$ . By continuity of the operator  $B S_1$ ,  $v_n := B S_1 g_n$  is bounded in  $L^2_1(\Omega^\infty)$ . Let us introduce the open and bounded subsets of  $\Omega^\infty$ ,  $K_\delta := \Omega^\infty \cap \{-\delta \leq x_d \leq \delta\}$ , which contain  $\Gamma_0$  for any  $\delta > 0$ ,  $S_2 \in \mathcal{L}(L^2_1(\Omega^\infty), H^1_{loc}(\Omega^\infty))$ ,  $w_n := S_2 B S_1 g_n$  is bounded in  $H^1(K_\delta)$ . Let us set  $\mathbf{W}_n = \chi \nabla w_n$  where  $\chi \in C^\infty(\mathbb{R})$  such that  $\chi(x_d) = 1$  for  $|x_d| < \delta/2$  and  $\chi(x_d) = 0$  for  $|x_d| > \delta$ . As  $\nabla \times \mathbf{W}_n = \nabla \chi \times \nabla w_n$ , we deduce that  $(\mathbf{W}_n)_n$  is a bounded sequence in the Hilbert space (implicitly equipped with the natural graph norm)  $\mathbf{H}(\mathbf{rot}, K_\delta) = \{\mathbf{v} \in L^2(K_\delta)^d, \nabla \times \mathbf{v} \in L^2(K_\delta)^d\}$ . Let us also introduce  $\mathbf{H}(\text{div}, \mathbb{A}_p, K_\delta) = \{\mathbf{v} \in L^2(K_\delta)^d, \nabla \cdot (\mathbb{A}_p \mathbf{v}) \in L^2(K_\delta)\}$ , again a Hilbert space for its graph norm. From (38), we deduce that  $(\mathbf{W}_n)_n$  is a bounded sequence of  $\mathbf{H}_0(\text{div}, \mathbb{A}_p, K_\delta) := \{\mathbf{v} \in \mathbf{H}(\text{div}, K_\delta), \mathbb{A}_p(x) \mathbf{v} \cdot \nu = 0 \text{ on } \partial K_\delta\}$ . We can now use a compactness result for vector fields, which is well-known from the theory of Maxwell's equations (see [1, Theorem 8.1.1] for instance): the embedding  $\mathbf{H}(\mathbf{rot}, K_\delta) \cap \mathbf{H}_0(\text{div}, \mathbb{A}_p, K_\delta) \subset L^2(K_\delta)^d$  is compact. Thus, up to the extraction of a subsequence,  $(\mathbf{W}_n)_n$  converges in  $L^2(K_\delta)$  which implies, since  $\chi = 1$  in  $K_{\delta/2}$ , that  $(\nabla w_n)_n$  converges in  $L^2(K_{\delta/2})$ . Up to another subsequence extraction, we conclude that  $(w_n)_n$  converges in  $H^1(K_{\delta/2})$ . Since, by definition of  $T$ ,  $T g_n = w_n|_{\Gamma_0}$ , the convergence of  $(T g_n)_n$  in  $H^{1/2}(\Gamma_0)$  follows from the trace theorem.

**Step 2 : uniqueness for (47).** Suppose that  $g \in H^{1/2}(\Gamma_0)$  is such that  $g - T g = 0$ . Then, as already mentioned, see point b) above,  $u^+ := S_2(B S_1 g)|_{\Omega_+} - S_1 g|_{\Omega_+}$  is solution of (30) with  $u^+|_{\Gamma_0} = 0$ . By uniqueness for (30) (since  $\omega^2 \notin \sigma_{\text{edge}}$ ),  $u^+ = 0$ , thus  $S_2(B S_1 g) = S_1 g$  in  $\Omega_+$ .

Symmetrically (we omit the details)  $u^- = S_2(B S_1 g)|_{\Omega_-} - S_1 g|_{\Omega_-}$  is solution of the "same" problem that (30) but in  $\Omega^-$ : apart from changing  $\Omega^+$  into  $\Omega^-$ , the  $w_j^+$  must be changed into the  $w_j^-$  in the radiation condition (*iv*). Then, because  $\omega^2$  does not belong to  $\sigma_{\text{edge}}^-$  (this is what was omitted in [19]) we can conclude that  $u^- = 0$ , in other words that  $S_2(B S_1 g) = S_1 g$  in  $\Omega_-$ .

Thus, setting  $v := S_2(B S_1 g)$ , we have shown that  $v = S_1 g$ . From the definition (44) of  $S_1$ , we deduce that  $v_\pm = v|_{\Omega^\pm}$  satisfies, cf. (37, 43)

$$(48) \quad -\nabla \cdot (\mathbb{A}_p \nabla v_\pm) + \omega^2 b_p v_\pm = 0 \quad \text{in } \Omega^\pm, \quad v_\pm \in H^1(\Omega^\pm).$$

On the other hand, from the definition (45) of  $S_2$ , we know, see (38), that

$$(49) \quad v \in H^1_{loc}(\Omega^\infty), \quad \nabla \cdot (\mathbb{A}_p \nabla v) \in L^2_{loc}(\Omega^\infty).$$

Joining (48) and (49), we deduce that  $v \in H^1(\Omega^\infty)$  and  $-\nabla \cdot (\mathbb{A}_p \nabla v) + \omega^2 b_p v = 0$  in  $\Omega^\infty$ . Thus  $v = 0$ , then  $S_1 g = 0$  and finally, again by definition of  $S_1$ ,  $g = (S_1 g)|_{\Gamma_0} = 0$ .

The continuity property of  $u^+(\varphi)$  follows from the existence proof (this is left to the reader).  $\square$



**Remark 3.4.** *There are of course infinitely many possible ways for extending  $f$  in such a way that  $f$  still depends linearly on  $g$ , leading to an alternative definition of the operator  $S_1$ . The simplest choice would be, for instance  $f|_{\Omega^-} := S_1 g|_{\Omega^-} = 0$ . The rest of the proof would be the same, the difference concerning only the uniqueness result of Step 2, which would leads values of  $\omega^2$  inside a new set of resonances, a priori different from  $\sigma_{edge}^-$ .*

The result of Theorem 3.3 is somewhat frustrating because, if the exclusion of the set  $\sigma_{edge}^+$  is obviously needed, the set  $\sigma_{edge}^-$  of edge resonances for the half-waveguide  $\Omega^-$  should not have any influence on the existence result for the problem posed in  $\Omega_+$ . Its exclusion is artificial : it is clearly a technical artefact due to the method of proof (see also Remark 3.4).

In the following, we propose an attempt to avoid the exclusion of  $\sigma_{edge}^-$ . The idea is that, if we move the position of the interface between  $\Omega_-$  and  $\Omega_+$ , the corresponding edge resonances should move accordingly, a fact that we could then exploit. To express this in more mathematical terms, let us introduce for  $a \in [0, L)$

$$(50) \quad \Omega_a^- := \{x \in \Omega^\infty / x_d < a\}, \quad \Omega_a^+ := \{x \in \Omega^\infty / x_d > a\},$$

to which we can associate (in an obvious manner that does not need to be detailed) two set of edges resonances  $\sigma_{edge}^\pm(a)$ . Our new result will rely on the following:

**Assumption A** :  $\forall \omega \in \mathbb{R}^+$ , there exists  $a \in [0, L)$  such that  $\omega^2 \notin \sigma_{edge}(a) := \sigma_{edge}^+(a) \cup \sigma_{edge}^-(a)$ .

Even though we did not prove it, we are convinced that the above assumption always holds.

**Conjecture C** : The property of Assumption **A** is always satisfied.

**Theorem 3.5.** *Under assumption **A**, if  $\omega^2 \notin \sigma_{edge}^+ \cup \sigma_{th}$ , for any  $\varphi \in H^{1/2}(\Gamma_0)$ , there exists a unique solution in  $H_{loc}^1(\Omega^+)$  of (30) which depends continuously on  $\varphi$  as in Theorem 3.3.*

*Proof.* The only difference with Theorem 3.3 is that we claim that Problem (30) is also well-posed for  $\omega^2 \in \sigma_{edge}^-$ . Indeed, if  $\omega^2 \in \sigma_{edge}^-$ , from Assumption **A**, we know that there exists  $a \in [0, L)$  such that  $\omega^2 \notin \sigma_{edge}(a)$ . By Theorem 3.3, the half-waveguide problem (30) set in  $\Omega_a^+$  is well posed. In consequence, we can define a corresponding DtN operator that we denote here  $\Lambda_a$ . Then the result will appear as a particular case of Theorem 3.8 (see Remark 3.9).  $\square$

## 3.2 Reduction of the problem in a bounded domain and analysis

In this section, we use the DtN method to analyze the problem (27). Of course, under assumption **A**, without loss of generality, we can assume that the position of  $\Gamma_0$  is chosen in such a way that  $\omega^2 \notin \sigma_{edge}$  so that, according to Theorem 3.5, the DtN operator  $\Lambda$  is well defined by (31). According to the previous section, it is now natural to consider the problem posed in  $\Omega_0$

$$(51) \quad \begin{cases} -\nabla \cdot (\mathbb{A} \nabla u_0) - \omega^2 b u_0 = f & \text{in } \Omega_0, \\ \mathbb{A} \nabla u_0 \cdot \nu = 0 & \text{on } \partial\Omega_0 \setminus \Gamma_0, \\ \mathbb{A} \nabla u_0 \cdot \mathbf{e}_d + \Lambda u_0 = 0 & \text{on } \Gamma_0. \end{cases}$$

The problem (51) is "equivalent" to the original problem (27) in the sense of the following lemma whose (obvious and standard) proof is left to the reader.

**Lemma 3.6.** *If  $u$  is solution of (27), then  $u_0 := u|_{\Omega_0}$  is solution of (51). Reciprocally, if  $u_0 := u|_{\Omega_0}$  is solution of (51) then the function  $u$  defined in  $\Omega$  by:*

$$(52) \quad u|_{\Omega_0} = u_0, \quad u|_{\Omega^+} = u^+(\varphi) \text{ with } \varphi := u_0|_{\Gamma_0},$$

*is solution of (27).*

As a consequence of this lemma, the well posedness of (27) is reduced to the one of (51). The variational formulation of (51) is given by

$$(53) \quad a_0(u_0, v) = \int_{\Omega_0} f \bar{v} \, d\mathbf{x}, \quad \forall v \in H^1(\Omega_0),$$

$$\text{with } a_0(u, v) = \int_{\Omega_0} (\mathbb{A} \nabla u \cdot \nabla \bar{v} - \omega^2 b u \bar{v}) \, dx + \langle \Lambda(u|_{\Gamma_0}), v|_{\Gamma_0} \rangle_{\Gamma_0},$$

where, here and in the rest of the paper,  $\langle \cdot, \cdot \rangle_{\Gamma_0}$  denotes the duality product between  $H^{-1/2}(\Gamma_0)$  and  $H^{1/2}(\Gamma_0)$ . By Riesz theorem, there exists  $\mathcal{A}_0 \in \mathcal{L}(H^1(\Omega_0))$  such that  $a_0(u, v) = (\mathcal{A}_0 u, v)_{H^1}$ , with  $(\cdot, \cdot)_{H^1}$  the usual scalar product in  $H^1(\Omega_0)$ . Thus, the resolution of (51) relies on the invertibility of  $\mathcal{A}_0$ .

**Lemma 3.7.** *The operator  $\mathcal{A}_0 \in \mathcal{L}(H^1(\Omega_0))$  is the sum of a coercive operator  $\mathcal{A}_0^+$  and a compact operator  $\mathcal{K}_0$ .*

*Proof.* Of course, the decomposition of  $\mathcal{A}_0$  relies on the one of  $a_0$ . The only non trivial point is the decomposition of the bilinear form associated to the DtN operator, namely  $\langle \Lambda\varphi, \psi \rangle_{\Gamma_0}$ .

Let  $(\varphi, \psi) \in H^{\frac{1}{2}}(\Gamma_0)^2$ . Let us multiply by  $\chi \overline{u^+(\psi)}$  the equation (30) satisfied by  $u^+(\varphi)$ , where  $\chi(x_d)$  is a smooth positive 1D function with support in  $[0, 1)$  such that  $\chi = 1$  in  $[0, 1/2]$ . Integrating the result over  $\Omega^+$  and using Green's formula, we obtain

$$(54) \quad \begin{aligned} \langle \Lambda\varphi, \psi \rangle_{\Gamma_0} &= \int_{\Omega_+} \chi \nabla u^+(\varphi) \cdot \overline{\nabla u^+(\psi)} \, dx + \int_{\Omega_+} (\nabla \chi \cdot \nabla u^+(\varphi)) \overline{u^+(\psi)} \, dx \\ &\quad - \omega^2 \int_{\Omega_+} \chi b u^+(\varphi) \overline{u^+(\psi)} \, dx \end{aligned}$$

which suggests to decompose  $a_0(u, v) = a_0^+(u, v) + k_0(u, v)$  with

$$\begin{aligned} a_0^+(u, v) &:= \int_{\Omega_0} (\mathbb{A} \nabla u \cdot \nabla \bar{v} + \omega^2 b u \bar{v}) \, dx + \int_{\Omega_+} \chi \nabla u^+(u|_{\Gamma_0}) \cdot \overline{\nabla u^+(v|_{\Gamma_0})} \, dx \\ k_0(u, v) &:= \int_{\Omega_+} (\nabla \chi \cdot \nabla u^+(u|_{\Gamma_0})) \overline{u^+(v|_{\Gamma_0})} \, dx - \omega^2 \int_{\Omega_+} \chi b u^+(u|_{\Gamma_0}) \overline{u^+(v|_{\Gamma_0})} \, dx - 2\omega^2 \int_{\Omega_0} b u \bar{v} \, dx. \end{aligned}$$

Let  $\mathcal{A}_0^+$  and  $\mathcal{K}_0$  the bounded operators in  $H^1(\Omega_0)$  respectively associated to  $a_0^+(u, v)$  and  $k_0(u, v)$  through Riesz theorem. Since  $a_0^+(u, v)$  is coercive,  $\mathcal{A}_0^+$  is coercive.

It remains to prove that  $\mathcal{K}_0$  is compact. It suffices to prove that, if  $(u_n, v_n)$  converge weakly to  $(u, v)$  in  $H^1(\Omega_0)$ , then, up to the extraction of a subsequence,  $k_0(u_n, v_n)$  converges to  $k_0(u, v)$ . Indeed, if  $u_n$  converges weakly to  $u$ , by continuity of  $\mathcal{K}_0$ ,  $v_n := \mathcal{K}_0 u_n$  converges weakly to  $v := \mathcal{K}_0 u$  and

$$\|\mathcal{K}_0(u_n - u)\|_{H^1}^2 = k_0(u_n - u, v_n - v) \longrightarrow 0.$$

Since  $(u_n, v_n)$  are bounded in  $H^1(\Omega_0)$ , by Rellich theorem, we can assume that  $(u_n, v_n)$  converge strongly to  $(u, v)$  in  $L^2(\Omega_0)$ . As a consequence

$$(55) \quad -2\omega^2 \int_{\Omega_0} b u_n \bar{v}_n dx \quad \longrightarrow \quad -2\omega^2 \int_{\Omega_0} b u \bar{v} dx$$

By the trace theorem,  $\varphi_n := u_n|_{\Gamma_0}$  and  $\psi_n := v_n|_{\Gamma_0}$  converge weakly in  $H^{\frac{1}{2}}(\Gamma_0)$  towards  $\varphi := u|_{\Gamma_0}$  and  $\psi := v|_{\Gamma_0}$ . From Theorem 3.5, the map  $\varphi \rightarrow u^+(\varphi)|_{\mathcal{C}_0}$  is continuous from  $H^{1/2}(\Gamma_0)$  in  $H^1(\mathcal{C}_0)$  so that  $u^+(\varphi_n)|_{\mathcal{C}_0}$  and  $u^+(\psi_n)|_{\mathcal{C}_0}$  are bounded in  $H^1(\mathcal{C}_0)$  (as defined in (50)), up to an extraction, we have

$$u^+(\varphi_n)|_{\mathcal{C}_0} \rightarrow u^+(\varphi)|_{\mathcal{C}_0}, \quad u^+(\psi_n)|_{\mathcal{C}_0} \rightarrow u^+(\psi)|_{\mathcal{C}_0}, \quad \text{weakly in } H^1(\mathcal{C}_0) \text{ and strongly in } L^2(\mathcal{C}_0)$$

Since  $\chi$  is adequately compactly supported, by weak-strong convergence arguments,

$$(56) \quad \begin{aligned} \int_{\Omega_+} (\nabla \chi \cdot \nabla u^+(\varphi_n)) u^+(\psi_n) dx &\longrightarrow \int_{\Omega_+} (\nabla \chi \cdot \nabla u^+(\varphi)) u^+(\psi) dx \\ \omega^2 \int_{\Omega_+} \chi b u^+(\varphi_n) u^+(\psi_n) dx &\longrightarrow \omega^2 \int_{\Omega_+} \chi b u^+(\varphi) u^+(\psi) dx \end{aligned}$$

The conclusion easily follows from (55), (56) and the definition of  $k_0(u, v)$ .  $\square$

**Theorem 3.8.** *Under assumption **A**, if  $\omega^2 \notin \sigma_{res} \cup \sigma_{th}$ , the problem (27) admits a unique solution.*

*Proof.* According to Lemma 3.6, we simply need to show the well-posedness of (51), and by Lemma 3.7 and Fredholm's alternative, we simply need to prove the uniqueness of the solution of (51).

Let  $u_0$  be a solution (51) for  $f = 0$ . By Lemma 3.6, the function  $u$  given by (52) is solution of (27) for  $f = 0$ , Thus by the uniqueness theorem 2.4,  $u = 0$ , thus  $u_0 = u|_{\Omega_0} = 0$ .  $\square$

**Remark 3.9.** *The approach of this section (Lemmas 3.6 and 3.7 and Theorem 3.8) can clearly be used for proving Theorem 3.5. Even though it is somewhat paradoxal and fussy, it suffices to see the domain of  $\Omega^+$  as the union of  $\Omega^+ \setminus \bar{\Omega}_a^+$  and the half-waveguide  $\Omega_a^+$ , where  $a$  is such that  $\omega^2 \notin \sigma_{edge}(a)$  so that the DtN operator for  $\Omega_a^+$  is well-defined! More precisely, it suffices to make the substitutions*

$$\Omega_0 \text{ becomes } \Omega^+ \setminus \bar{\Omega}_a^+, \quad \Omega^+ \text{ becomes } \Omega_a^+, \quad \sigma_{res} \text{ becomes } \sigma_{edge}^+.$$

*The only remaining difference is the boundary condition on  $\Gamma_0$  (seen here as a part of  $\partial\Omega^+$ ) which is a non homogeneous Dirichlet condition instead as a homogeneous Neumann condition. However, the reader will easily convince himself that this has no influence on the proof.*

## 4 Construction of the DtN operator

In this section, we use the DtN method to build a numerical method for solving (27). We consider that the artificial boundary  $\Gamma_0$ , hence the domain  $\Omega^+$ , is imposed. Thus we have to assume that

$$(57) \quad \omega^2 \notin \sigma_{edge}^+.$$

## 4.1 Structure of the solution

**Theorem 4.1.** *If  $\omega^2 \notin \sigma_{edge}^+ \cup \sigma_{th}$ , let  $u^+(\varphi)$  be the unique solution of (30) and  $\mathcal{P} \in \mathcal{L}(H^{1/2}(\Gamma_0))$  be the operator defined by*

$$(58) \quad \forall \varphi \in H^{1/2}(\Gamma_0), \quad \mathcal{P} \varphi := u^+(\varphi)|_{\Gamma_1}.$$

where we have identified  $H^{1/2}(\Gamma_1) \equiv H^{1/2}(\Gamma_0)$ . This operator is compact and its spectral radius is less or equal than 1. Moreover,

$$(59) \quad \forall \varphi \in H^{1/2}(\Gamma_0), \quad \forall \mathbf{x} \in \Omega^+, \quad \forall n \in \mathbb{N}, \quad u^+(\varphi)(\mathbf{x} + nL \mathbf{e}_d) = u^+(\mathcal{P}^n \varphi)(\mathbf{x}).$$

*Proof.* Let us first show (59). Let us introduce for  $\varphi \in H^{1/2}(\Gamma_0)$ , the function  $v$  defined by  $v(\mathbf{x}) = u^+(\varphi)(\mathbf{x} + L \mathbf{e}_d)$ . By periodicity of  $\mathbb{A}_p$  and  $b_p$ , it is easy to show that  $v$  satisfies (30)(i) and (ii). By definition of  $\mathcal{P}$ ,  $v$  satisfies the Dirichlet boundary conditions on  $\Gamma_0$

$$v = \mathcal{P} \varphi \quad \text{on } \Gamma_0.$$

As  $u^+(\varphi)$  satisfies the radiation conditions, by Definition 2.1, there exists  $w \in D(\mathcal{A})$  such that  $\exists \alpha > 0$ ,  $e^{\alpha x_d} w \in H^1(\Omega^+)$ ,  $a_1^+, \dots, a_{N(\omega)}^+ \in \mathbb{C}$  such that

$$u = w + \sum_{j=1}^{N(\omega)} a_j^+ w_j^+,$$

where by (22),  $w_j^+$  is  $k_j$ -quasi-periodic. We deduce that

$$v(\mathbf{x}) = w(\mathbf{x} + L \mathbf{e}_d) + \sum_{j=1}^{N(\omega)} a_j^+ e^{ik_j L} w_j^+(\mathbf{x}),$$

in other words  $v$  satisfies also the radiation condition (30)(i). Since  $v = \mathcal{P} \varphi$  on  $\Gamma_0$ , one then deduces (see Theorem 3.5) that  $v = u^+(\mathcal{P} \varphi)$  and thus

$$\forall \varphi \in H^{1/2}(\Gamma_0), \quad \forall \mathbf{x} \in \Omega^+, \quad u^+(\varphi)(\mathbf{x} + L \mathbf{e}_d) = u^+(\mathcal{P} \varphi)(\mathbf{x}).$$

By induction, it is then clear that (59) holds.

Let us now show that  $\mathcal{P} \in \mathcal{L}(H^{1/2}(\Gamma_0))$  is a compact operator. In the case  $\mathbb{A}_p(x) = I$ , this appears as a consequence of an interior elliptic regularity result. In the general case, the proof is a little bit more elaborate but uses the arguments as in the proof of Theorem 3.5 (Step 2). We show that, for any bounded sequence  $(\varphi_n)_n$  of  $H^{1/2}(\Gamma_0)$ , the sequence  $(\mathcal{P} \varphi_n)_n$  admits a converging subsequence in  $H^{1/2}(\Gamma_0)$ . Indeed, for such a sequence,  $u^+(\varphi_n)$  is bounded in  $H^1(K)$  for any open bounded subset  $K$  of  $\Omega^+$ . Let us introduce the open subsets of  $\Omega^+$ ,  $K_\delta^+ := \Omega^+ \cap \{|x_d - L| \leq \delta\}$  which contain  $\Gamma_1$  for any  $\delta$ . Let us set  $\mathbf{W}_n = \chi \nabla u^+(\varphi_n)$  where  $\chi \in \mathcal{C}^\infty(\mathbb{R})$  is a smooth cut-off function such that  $\chi = 1$  for  $|x_d - L| \leq \delta/2$  and  $\chi = 0$  for  $|x_d - L| > \delta$ . By using the same arguments than at the end of the proof of Theorem 3.5, we show that there exists a subsequence of  $(\mathbf{W}_n)_n$ , still denoted  $(\mathbf{W}_n)_n$  for simplicity, which converges in  $L^2(K_\delta^+)$ . In particular  $\nabla u^+(\varphi_n)_n$  converges in  $L^2(K_{\delta/2}^+)$  and up to another subsequence extraction,  $u^+(\varphi_n)$  converges in  $H^1(K_{\delta/2}^+)$ . Then, by trace theorem,  $\mathcal{P} \varphi_n$  converges in  $H^{1/2}(\Gamma_0)$ .

Finally, let us prove that spectral radius of  $\mathcal{P}$  satisfies  $\rho(\mathcal{P}) \leq 1$ . Since  $\mathcal{P}$  is compact, it suffices to show that the modulus of any eigenvalue is less than one. The proof is done by contradiction. Let  $\lambda$  be an eigenvalue of  $\mathcal{P}$  and  $\psi$  an associated eigenvector and suppose that  $|\lambda| > 1$ . Then using (59), for any  $n \in \mathbb{N}$ ,  $u^+(\psi)|_{\mathcal{C}_n} = \lambda^n u^+(\psi)|_{\mathcal{C}_0}$ , so that

$$\int_{\mathcal{C}_n} |u^+(\psi)|^2 = |\lambda|^{2n} \int_{\mathcal{C}_0} |u^+(\psi)|^2 \xrightarrow{n \rightarrow +\infty} +\infty$$

which is in contradiction with the radiation condition.  $\square$

## 4.2 Cell by cell construction of the solution

Once the operator  $\mathcal{P}$  is known, the solution  $u^+(\varphi)$  of (30) can be reconstructed in the whole domain  $\Omega^+$  by solving problems posed in bounded domains only. In order to give an explicit reconstruction, we follow the method proposed in [16], which leads us to assume that, from now on

$$(60) \quad \omega^2 \notin \sigma_{\text{cell}} := \sigma(\mathcal{A}^{\mathcal{C}})$$

where the unbounded operator in  $L^2(\mathcal{C})$ ,  $\mathcal{A}^{\mathcal{C}}$  is defined by

$$(61) \quad \left\{ \begin{array}{l} D(\mathcal{A}^{\mathcal{C}}) = \{u \in H^1(\mathcal{C}_0), \nabla \cdot (\mathbb{A}_p \nabla u) \in L^2(\mathcal{C}_0), u|_{\Gamma_0 \cup \Gamma_1} = 0, \mathbb{A}_p \nabla u \cdot \nu|_{\partial\Omega^\infty \cap \partial\mathcal{C}_0} = 0\}, \\ \forall u \in D(\mathcal{A}^{\mathcal{C}}), \quad \mathcal{A}^{\mathcal{C}} u = -b_p^{-1} \nabla \cdot (\mathbb{A}_p \nabla u), \end{array} \right.$$

When  $\omega^2 \notin \sigma_{\text{cell}}$ , we can consider, for any data  $\varphi$  in  $H^{1/2}(\Gamma_0)$ , the cell problems

$$(62) \quad \left\{ \begin{array}{l} -\nabla \cdot (\mathbb{A}_p \nabla e^\ell) - \omega^2 b_p e^\ell = 0 \quad \text{in } \mathcal{C}_0 \\ \mathbb{A}_p \nabla e^\ell \cdot \nu = 0 \quad \text{on } \partial\Omega^\infty \cap \partial\mathcal{C}_0 \end{array} \right.$$

with the boundary conditions on  $\Gamma_0$  and  $\Gamma_1$

$$(63) \quad \begin{array}{l} e^0(\varphi)|_{\Gamma_0} = \varphi \quad \text{and} \quad e^0(\varphi)|_{\Gamma_1} = 0 \\ e^1(\varphi)|_{\Gamma_0} = 0 \quad \text{and} \quad e^1(\varphi)|_{\Gamma_1} = \varphi. \end{array}$$

Of course, these problems are well posed and there exists a constant  $C(\omega) > 0$  such that

$$(64) \quad \forall \varphi \in H^{1/2}(\Gamma_0), \quad \|e^\ell(\varphi)\|_{H^1(\mathcal{C}_0)} \leq C(\omega) \|\varphi\|_{H^{1/2}(\Gamma_0)}, \quad \ell \in \{0, 1\}.$$

**Remark 4.2.** *Let us remark that we have to exclude the resonances of the Dirichlet cell problem to define the solution of the cell problem without dissipation. Similarly to Remark 3.1 and 3.2, this set of forbidden frequencies has been introduced artificially. If the frequency of interest is in this set, it is possible to move the periodicity cell –which corresponds to move the artificial boundaries on which the DtN conditions is imposed– or by introducing cell problem with Robin boundary conditions instead of Dirichlet boundary conditions.*

From (59) written for  $\mathbf{x} \in \Gamma_0$ , we have

$$\forall n \in \mathbb{N}, \quad u^+(\varphi)|_{\Gamma_n} = \mathcal{P}^n \varphi.$$

By identifying all the cells  $\mathcal{C}_n$  to  $\mathcal{C}_0$ , we have then, if  $\omega^2 \notin \sigma_{\text{cell}}$

$$(65) \quad \forall n \in \mathbb{N}, \quad u^+(\varphi)|_{\mathcal{C}_n} = e^0(\mathcal{P}^n \varphi) + e^1(\mathcal{P}^{n+1} \varphi).$$

The formula (65) is useful if one knows how to compute numerically the operator  $\mathcal{P}$ . That is why we need a more tractable characterization than its definition (58).

### 4.3 Characterization of the propagation operator

Let us define then the local DtN operators for  $\ell, k \in \{0, 1\}$ ,  $\mathcal{T}^{\ell k} \in \mathcal{L}(H^{1/2}(\Gamma_0), H^{-1/2}(\Gamma_0))$

$$(66) \quad \forall \varphi \in H^{1/2}(\Gamma_0), \quad \mathcal{T}^{\ell k} \varphi = (-1)^{k+1} \mathbb{A}_p \nabla e^\ell(\varphi) \cdot \mathbf{e}_d|_{\Gamma_k}$$

where we have identified  $H^{1/2}(\Gamma_1) \equiv H^{1/2}(\Gamma_0)$  and  $H^{-1/2}(\Gamma_1) \equiv H^{-1/2}(\Gamma_0)$ . We have in particular for  $\ell, k \in \{0, 1\}$  and for all  $\varphi, \psi$  in  $H^{1/2}(\Gamma_0)$

$$(67) \quad \langle \mathcal{T}^{\ell k} \varphi, \psi \rangle_{\Gamma_0} = \int_{\mathcal{C}} \mathbb{A}_p \nabla e^\ell(\varphi) \cdot \nabla \overline{e^k(\psi)} - \omega^2 b_p e^\ell(\varphi) \overline{e^k(\psi)}$$

Let us first show the following properties of the local DtN operators  $\mathcal{T}^{\ell k}$ .

**Proposition 4.3.** *We have*

$$(68) \quad [\mathcal{T}^{00}]^* = \mathcal{T}^{00}, \quad [\mathcal{T}^{11}]^* = \mathcal{T}^{11}, \quad [\mathcal{T}^{01}]^* = \mathcal{T}^{10}, \quad [\mathcal{T}^{10}]^* = \mathcal{T}^{01},$$

$$(69) \quad \mathcal{T}^{01} \text{ and } \mathcal{T}^{10} \text{ are compact operators from } H^{1/2}(\Gamma_0) \text{ into } H^{-1/2}(\Gamma_0)$$

and finally

$$(70) \quad \mathcal{T}^{00}, \mathcal{T}^{11} \text{ and } \mathcal{T}^{00} + \mathcal{T}^{11} \text{ are Fredholm operators of index 0.}$$

*Proof.* (68) can be obtained by using simply Green's formulas. Since  $e^0(\varphi)$  and  $e^1(\varphi)$  are solutions of (62-63) for all  $\varphi$  in  $H^{1/2}(\Gamma_0)$ , we have for all  $\ell, k$  in  $\{0, 1\}$

$$\forall \varphi, \psi \in H^{1/2}(\Gamma_0), \quad \langle \mathbb{A}_p \nabla e^\ell(\varphi) \cdot \nu, e^k(\psi) \rangle_{\partial \mathcal{C}_0} = \langle e^\ell(\varphi), \mathbb{A}_p \nabla e^k(\psi) \cdot \nu \rangle_{\partial \mathcal{C}_0}$$

This yields for  $\ell = k = 0$  to

$$\forall \varphi, \psi \in H^{1/2}(\Gamma_0), \quad \langle \mathcal{T}^{00} \varphi, \psi \rangle_{\Gamma_0} = \langle \varphi, \mathcal{T}^{00} \psi \rangle_{\Gamma_0}$$

since  $e^0(\varphi)$  satisfies vanishing Neumann boundary conditions on  $\partial \mathcal{C}_0 \setminus (\Gamma_0 \cup \Gamma_1)$  and similarly for  $\ell = k = 1$ . For  $\ell = 0$  and  $k = 1$ , we obtain

$$\forall \varphi, \psi \in H^{1/2}(\Gamma_0), \quad \langle \mathcal{T}^{01} \varphi, \psi \rangle_{\Gamma_0} = \langle \varphi, \mathcal{T}^{10} \psi \rangle_{\Gamma_0}$$

and similarly for  $\ell = 1$  and  $k = 0$ .

For the proof of the compactness of the operators  $\mathcal{T}^{01}$  and  $\mathcal{T}^{10}$ , it suffices to use the same arguments than the one used for the compactness of the propagation operator  $\mathcal{P}$  (see the proof of Theorem 4.1).

Let us now show that  $\mathcal{T}^{00}$  is a Fredholm operator of index 0, more precisely that it is the sum of a coercive operator and a compact one (the proof for  $\mathcal{T}^{11}$  is similar). By (67), we have

$$\mathcal{T}^{00} = \mathcal{A}^{00} + \mathcal{K}^{00}$$

where  $\mathcal{A}^{00}$  and  $\mathcal{K}^{00}$  are in  $\mathcal{L}(H^{1/2}(\Gamma_0), H^{-1/2}(\Gamma_0))$  and for all  $\varphi, \psi$  in  $H^{1/2}(\Gamma_0)$

$$\langle \mathcal{A}^{00} \varphi, \psi \rangle_{\Gamma_0} = \int_{\mathcal{C}} \mathbb{A}_p \nabla e^0(\varphi) \cdot \nabla \overline{e^0(\psi)} + b_p e^0(\varphi) \overline{e^0(\psi)}, \quad \langle \mathcal{K}^{00} \varphi, \psi \rangle_{\Gamma_0} = - \int_{\mathcal{C}} (\omega^2 + 1) b_p e^0(\varphi) \overline{e^0(\psi)}$$

By continuity of the trace application,  $\mathcal{A}^{00}$  is coercive thus invertible. Due to (64) and the compact embedding of  $H^1(\mathcal{C}_0)$  in  $L^2(\mathcal{C}_0)$ , the map  $\mathcal{K}^{00}$  is compact. Thus, there exists  $C > 0$  such that

$$\forall \varphi \in H^{1/2}(\Gamma_0), \quad C \langle \mathcal{T}^{00} \varphi, \varphi \rangle_{\Gamma_0} \geq \|\varphi\|_{H^{1/2}(\Gamma_0)}^2 - \|e^0(\varphi)\|_{L^2(\mathcal{C}_0)}^2.$$

Since a similar inequality holds with  $\mathcal{T}^{11}$ , and using the Cauchy-Schwarz inequality, we deduce that for all  $\varphi$  in  $H^{1/2}(\Gamma_0)$

$$\|\varphi\|_{H^{1/2}(\Gamma_0)} \leq C (\|(\mathcal{T}^{00} + \mathcal{T}^{11})\varphi\|_{H^{-1/2}(\Gamma_0)} + \|e^0(\varphi)\|_{L^2(\mathcal{C}_0)} + \|e^1(\varphi)\|_{L^2(\mathcal{C}_0)})$$

We can now use Peetre's lemma [35] (see also [25, Lemma 5.1]) to deduce that the operator  $\mathcal{T}^{00} + \mathcal{T}^{11}$  is Fredholm. Since it is self-adjoint, its index is necessarily 0.  $\square$

Given  $P \in \mathcal{L}(H^{1/2}(\Gamma_0))$  and  $\varphi \in H^{1/2}(\Gamma_0)$ , let us define  $u(\varphi) \in L^2_{loc}(\Omega_0)$  by

$$(71) \quad \forall n \in \mathbb{N}, \quad u(\varphi)|_{\mathcal{C}_n} = e^0(P^n \varphi) + e^1(P^{n+1} \varphi).$$

We then have the following lemma (partly a reciproque of (65)). Its proof is a direct consequence of the properties of  $e_0(\varphi)$  and  $e_1(\varphi)$  and is left to the reader.

**Lemma 4.4.** *The function  $u(\varphi)$  given by (71) belongs to  $H^1_{loc}(\Omega^+)$  and satisfies*

$$(72) \quad \forall n \in \mathbb{N}, \quad -\nabla \cdot (\mathbb{A}_p \nabla u) - \omega^2 b_p u = 0 \text{ in } \mathcal{C}_n, \quad (\mathbb{A}_p \nabla u) \cdot \nu = 0 \text{ on } \partial \mathcal{C}_n \cap \partial \Omega^\infty$$

However, the formula (65) is not sufficient to ensure that  $u(\varphi)$  solves the equation in all  $\Omega^+$ . Obtaining such a property is precisely the object of the

**Theorem 4.5** (Stationary Ricatti equation). *The function  $u(\varphi) \in H^1_{loc}(\Omega_0)$  defined by (71) satisfies*

$$(73) \quad -\nabla \cdot (\mathbb{A}_p \nabla u(\varphi)) - \omega^2 b_p u(\varphi) = 0 \text{ in } \Omega^+, \quad (\mathbb{A}_p \nabla u) \cdot \nu = 0 \text{ on } \partial \Omega^+ \setminus \Gamma_0,$$

*if and only if  $P$  is solution of the stationary Ricatti equation*

$$(74) \quad \mathcal{T}(P) = 0, \quad \text{where } \forall X \in \mathcal{L}(H^{1/2}(\Gamma_0)), \quad \mathcal{T}(X) := \mathcal{T}^{10} X^2 + (\mathcal{T}^{00} + \mathcal{T}^{11})X + \mathcal{T}^{01}$$

*Proof.* Thanks to lemma 4.4,  $u(\varphi)$  satisfies (73) if  $\mathbb{A}_p \nabla u(\varphi) \cdot \mathbf{e}_d$  is continuous, in the sense of traces, across each interface  $\Gamma_n$ . From the definition of the local DtN operators (66), and the identification of each  $\mathcal{C}_n$  to  $\mathcal{C}_0$ , one deduces from the expression (71) that this condition is equivalent to

$$(75) \quad \forall n \geq 1, \quad \forall \varphi \in H^{1/2}(\Gamma_0), \quad -\mathcal{T}^{01} P^{n-1} \varphi - \mathcal{T}^{00} P^n \varphi = \mathcal{T}^{10} P^n \varphi + \mathcal{T}^{11} P^{n+1} \varphi.$$

In particular, (75) for  $n = 1$  gives  $-\mathcal{T}^{01} - \mathcal{T}^{00} P = \mathcal{T}^{10} P^2 + \mathcal{T}^{11} P$  that is to say (74). Conversely, if (74) holds, multiplying it by  $P^{n-1}$  (on the right), we get  $-\mathcal{T}^{01} P^{n-1} - \mathcal{T}^{00} P^n = \mathcal{T}^{10} P^n + \mathcal{T}^{11} P^{n+1}$ , that is to say (75).  $\square$

**Corollary 4.6.** *The propagation operator  $\mathcal{P}$  is solution of*

$$(76) \quad \text{Find } P \in \mathcal{L}(H^{1/2}(\Gamma_0)) \quad \text{such that } \mathcal{T}(P) = 0 \text{ and } \rho(P) \leq 1$$

*where  $\mathcal{T}(\cdot)$  is defined by (74).*

This corollary does not characterize uniquely, in general, the propagation operator. To go further, it is necessary to distinguish between propagative and non propagative frequencies. Indeed, when  $\omega$  is *not a propagative frequency*, i. e. when  $\omega^2 \notin \sigma^\infty$ , the corollary admits a reciproque. The key point is that, as already mentioned at the end of Section 2.3 , the radiation condition degenerates and Problem (32) is well-posed in  $H^1(\Omega^+)$ .

Before going further, let us point out a property of any solution of the Ricatti equation (74) .

**Lemma 4.7.** *If  $P$  is a solution of (74), then  $P$  is a compact operator in  $H^{1/2}(\Gamma_0)$ .*

*Proof.* According to Proposition 4.3, we can write  $\mathcal{T}^{00} + \mathcal{T}^{11} = \mathcal{A} + \mathcal{K}$ , where  $\mathcal{A} \in \mathcal{L}(H^{1/2}(\Gamma_0), H^{-1/2}(\Gamma_0))$  is invertible and  $\mathcal{K}$  is compact from  $H^{1/2}(\Gamma_0)$  in  $H^{-1/2}(\Gamma_0)$ . If  $P$  is solution of (74), we can write

$$(\mathcal{A} + \mathcal{K})P = -\mathcal{T}^{10} P^2 - \mathcal{T}^{01}$$

Thus  $P = \mathcal{A}^{-1}(\mathcal{K}P - \mathcal{T}^{10} P^2 - \mathcal{T}^{01})$  and the compactness of  $P$  follows from the ones of  $\mathcal{K}$ ,  $\mathcal{T}^{10}$  and  $\mathcal{T}^{01}$  (see Proposition 4.3).  $\square$

**Theorem 4.8.** *Let  $\omega^2 \notin \sigma_{th} \cup \sigma_{edge}^+ \cup \sigma_{cell}$ . When moreover  $\omega^2 \notin \sigma^\infty$  the problem (76) admits a unique solution and this solution satisfies  $\rho(\mathcal{P}) < 1$ .*

*Proof.* Corollary 4.6 gives that  $\mathcal{P}$  is a solution of (76). Moreover, we can show that  $\rho(\mathcal{P}) < 1$ . Indeed, since  $\mathcal{P}$  is compact, it suffices to show that the modulus of any eigenvalue is strictly less than one. Let  $\lambda$  be an eigenvalue of  $\mathcal{P}$  and  $\varphi$  an associated eigenvector. We have

$$\int_{\Omega^+} |u^+(\varphi)|^2 = \sum_{n \in \mathbb{N}} \int_{\mathcal{C}_n} |u^+(\varphi)|^2 = \sum_{n \in \mathbb{N}} \int_{\mathcal{C}_0} |u^+(\mathcal{P}^n \varphi)|^2 = \sum_{n \in \mathbb{N}} |\lambda|^{2n} \int_{\mathcal{C}_0} |u^+(\varphi)|^2$$

where we have used (59). Since  $u^+(\varphi) \in L^2(\Omega^+)$ ,  $|\lambda| < 1$ . Let us show now that  $\mathcal{P}$  is the only solution of (76). Let  $P$  be a solution of (76) with spectral radius less than one. Let for any  $\varphi \in H^{1/2}(\Gamma_0)$ ,  $u(\varphi)$  be defined by

$$u(\varphi)|_{\mathcal{C}_n} = e^0(P^n \varphi) + e^1(P^{n+1} \varphi).$$

Theorem 4.5 gives that  $u(\varphi)$  satisfies (72) in  $\Omega^+$ . Finally, we know that

$$(77) \quad \lim_{n \rightarrow +\infty} \|P^n\|_{\mathcal{L}(H^{1/2}(\Gamma_0))}^{1/n} = \rho(P),$$

If  $\rho(P) < 1$  this implies that for some  $\alpha' > 0$  such that  $e^{-\alpha'} \in (\rho(P), 1)$  and  $n$  large enough:

$$\|P^n\|_{\mathcal{L}(H^{1/2}(\Gamma_0))} \leq e^{-\alpha' n},$$

so that by definition of  $u(\varphi)$  and by (64)

$$\|u(\varphi)\|_{H^1(\mathcal{C}_n)} \leq C e^{-\alpha' n} \|\varphi\|_{H^{1/2}(\Gamma_0)}.$$

Thus, it is easy to see that for  $0 < \alpha < \alpha'$ ,  $e^{\alpha x_d} u(\varphi) \in H^1(\Omega^+)$  and  $u(\varphi)$  is in particular solution of (30). Thus, by Theorem 3.5,  $u^+(\varphi) = u(\varphi)$  for all  $\varphi$  and  $P = \mathcal{P}$ .

Let us finally show that  $\rho(P) < 1$ . If not, then  $\rho(P) = 1$ . As  $P$  is compact by Lemma 4.7, if



$\rho(P) = 1$  there exists an eigenvalue  $p$  with  $p = e^{ikL}$ . Let  $\varphi \neq 0$  be an associated eigenvector and consider  $u(\varphi) \in L^2_{loc}(\Omega^\infty)$  defined as in (78) (except that  $n$  varies in  $\mathbb{Z}$  instead of  $\mathbb{N}$ ), i. e.

$$(78) \quad \forall n \in \mathbb{Z}, \quad u(\varphi)|_{c_n} = e^0(P^n \varphi) + e^1(P^{n+1} \varphi) \equiv e^{iknL} (e^0(\varphi) + e^{ikL} e^1(P\varphi))$$

From this expression, it is easy to see that

$$(79) \quad \Phi := e^{-ikx_d} u(\varphi) \text{ is } L\text{-periodic.}$$

Moreover, arguing as for Theorem 4.5, we know that  $u(\varphi)$  defined by (71) satisfies

$$(80) \quad -\nabla \cdot (\mathbb{A}_p \nabla u(\varphi)) - \omega^2 b_p u(\varphi) = 0 \text{ in } \Omega^\infty, \quad (\mathbb{A}_p \nabla u) \cdot \nu = 0 \text{ on } \partial\Omega^\infty.$$

From (79) and (80), we deduce that  $u(\varphi)$  is a propagative Floquet mode as defined in (4-5). This is in contradiction with the fact that  $\omega^2 \notin \sigma^\infty$  (see Section 2.3).  $\square$

It remains to treat the more interesting and more delicate case of the *propagative frequencies*. In such a case, the solution defined by (71), with  $P$  a solution of (76), does not necessarily provide a solution of (30) because there is a priori no guarantee that the radiation condition is satisfied. As we shall see, there is no longer uniqueness for solutions of (76). We need to add additional conditions to (76) in order to characterize the operator  $\mathcal{P}$ . These new conditions refer to particular spectral properties of  $\mathcal{P}$  and that is why we study the possible eigenvalues of the operators  $P$  solutions of (76). As a useful preliminary result, let us mention the

**Proposition 4.9.** *Let  $\omega^2 \in \sigma^\infty \setminus (\sigma_{edge}^+ \cup \sigma_{th})$  and let*

$$(81) \quad \varphi_j^\pm := w_j^\pm|_{\Gamma_0} \in H^{1/2}(\Gamma_0), \quad 1 \leq j \leq N(\omega),$$

where the  $w_j^+$ 's are the rightgoing propagating Floquet modes defined by (20-22). Then the set  $\{\varphi_j^+, 1 \leq j \leq N(\omega)\}$  generates a vector space of dimension  $N(\omega)$  and each  $\varphi_j^+$  is an eigenvector of  $\mathcal{P}$  associated with an eigenvalue of modulus 1. More precisely :

$$(82) \quad \forall 1 \leq j \leq N(\omega), \quad \mathcal{P} \varphi_j^+ = e^{ik_j L} \varphi_j^+$$

where  $k_j$  is the wavenumber associated to  $w_j^+$  defined in (22).

*Proof.* The first (obvious) observation is that since  $\omega^2 \notin \sigma_{edge}^+ \cup \sigma_{th}$ , if one takes  $\varphi = \varphi_j^+$ , then the solution  $u^+(\varphi)$  of (30) is nothing but  $w_j^+$ , that is to say

$$(83) \quad u^+(\varphi_j^+) = w_j^+.$$

In other words, by definition (58) of  $\mathcal{P}$  and in view of (4),

$$(84) \quad \mathcal{P} \varphi_j^+ = w_j^+|_{\Gamma_1} = e^{ik_j L} w_j^+|_{\Gamma_0} = e^{ik_j L} \varphi_j^+$$

To conclude that  $\varphi_j^+$  is an eigenvector of  $\mathcal{P}$ , it is thus sufficient to show that  $\varphi_j^+ \neq 0$ . If  $\varphi_j^+$  was equal to 0,  $w_j^+$  would be a non zero solution of (30) with vanishing trace on  $\Gamma_0$  : this is impossible by well-posedness of (30) for  $\omega^2 \notin \sigma_{edge}^+$ .

To conclude that  $\{\varphi_j^+, 1 \leq j \leq N(\omega)\}$  generates a vector space of dimension  $N(\omega)$ , they are linearly independent. Assume that  $\sum \alpha_j \varphi_j^+ = 0$  and consider  $w := \sum \alpha_j w_j^+$ . The function  $w$  satisfies (30) with a vanishing Dirichlet conditions on  $\Gamma_0$ , by well-posedness of this problem (see Theorem 3.5) for  $\omega^2 \notin \sigma_{edge}^+$ , we conclude that  $w = 0$ . Since  $\{w_j^+, 1 \leq j \leq N(\omega)\}$  are linearly independent, we conclude  $\alpha_j = 0$  for all  $j$ .  $\square$

Considering (76), it is natural to introduce the "generalized eigenvalue problem"

$$(85) \quad \text{Find } \lambda \in \mathbb{C} \text{ such that } \text{Ker } \mathcal{T}(\lambda) \neq 0.$$

Corollary 4.6 implies that the eigenvalues of  $\mathcal{P}$  are contained in the set of solutions of (85) :

$$(86) \quad \lambda \in \sigma(\mathcal{P}) \implies \text{Ker } \mathcal{T}(\lambda) \neq 0.$$

and more precisely

$$(87) \quad \mathcal{P} \varphi = \lambda \varphi, \quad \varphi \neq 0 \implies \mathcal{T}(\lambda) \varphi = 0.$$

Our goal is to characterize which subset of the solutions of (85) coincides with the spectrum of  $\mathcal{P}$ . Let us first show that the solutions of (85) naturally come by pairs  $(\lambda, 1/\lambda)$  where, without any loss of generality  $|\lambda| \leq 1$ .

**Proposition 4.10.** *For any  $\lambda \neq 0$ , one has the property:*

$$\text{Ker } \mathcal{T}(\lambda) \neq 0 \iff \text{Ker } \mathcal{T}(1/\lambda) \neq 0.$$

*Proof.* This is linked to the properties of the local DtN operators  $\mathcal{T}^{\ell k}$  given in Proposition 4.3. Indeed, we can deduce from the properties (70) that  $\forall \lambda$ ,  $\mathcal{T}(\lambda)$  is a Fredholm operator and then

$$\text{Ker } \mathcal{T}(\lambda) \neq 0 \iff \text{Ker } \mathcal{T}(\lambda)^* \neq 0$$

From the properties (68), we deduce that for all  $\lambda \neq 0$

$$[\mathcal{T}(\lambda)]^* = \lambda^2 \mathcal{T}^{01} + \lambda (\mathcal{T}^{00} + \mathcal{T}^{11}) + \mathcal{T}^{10} = \lambda^2 \mathcal{T}(1/\lambda).$$

The result follows easily. □

On one hand, when  $(\lambda, 1/\lambda)$  is a pair of solutions of (85) with  $|\lambda| < 1$ , then the following result states that, as expected,  $\lambda$  is an eigenvalue of  $\mathcal{P}$ .

**Proposition 4.11.** *Let  $\omega^2 \notin \sigma_{th} \cup \sigma_{edge}^+ \cup \sigma_{cell}$ . For any  $|\lambda| < 1$ , one has the property:*

$$(88) \quad \text{Ker } \mathcal{T}(\lambda) \neq 0 \implies \lambda \in \sigma(\mathcal{P}).$$

*Proof.* Let  $\varphi \neq 0 \in \text{Ker } \mathcal{T}(\lambda)$  and consider the function  $v(\varphi) \in L_{loc}^2(\Omega^+)$  constructed cell by cell as

$$(89) \quad \forall n \in \mathbb{N}, \quad v(\varphi)|_{\mathcal{C}_n} = \lambda^n e^0(\varphi) + \lambda^{n+1} e^1(\varphi).$$

By construction (and from the definition of  $e^0(\varphi)$  and  $e^1(\varphi)$ ),  $-\nabla \cdot (\mathbb{A}_p \nabla v(\varphi)) - \omega^2 b_p v(\varphi) = 0$  in each cell  $\mathcal{C}_n$  and  $v(\varphi)$  is continuous by definition across each interface  $\Gamma_n$ . Moreover, because  $\mathcal{T}(\lambda)\varphi = 0$ ,  $\mathbb{A}_p \nabla v(\varphi) \cdot \mathbf{e}_d$  is continuous cross each interface  $\Gamma_n$ . Thus

$$-\nabla \cdot (\mathbb{A}_p \nabla v(\varphi)) - \omega^2 b_p v(\varphi) = 0 \text{ in } \Omega^+.$$

Moreover,  $|\lambda| < 1$  implies that  $v(\varphi) \in H^1(\Omega^+)$ . In particular it satisfies the radiation condition given in Definition 2.1 with  $a_j^+ = 0$  for any  $1 \leq j \leq N(\omega)$ . By Theorem 3.5, we have that  $v(\varphi) = u^+(\varphi)$  and thus, by (58), that  $v(\varphi)|_{\Gamma_1} = \mathcal{P}\varphi$ . However, by construction (use (89) for  $n = 0$ ),  $v(\varphi)|_{\Gamma_1} = \lambda \varphi$ . We conclude that  $\mathcal{P}\varphi = \lambda \varphi$ . □

On the other hand, as we are now going to see, when  $\omega$  is a propagative frequency, i.e. when  $\omega^2 \in \sigma^\infty$ , (finitely many) couples  $(\lambda, 1/\lambda)$  of solutions of (85) with  $|\lambda| = 1$  exist, the solution of (76) is not unique. As a matter of fact, it is not easy a priori to know whether  $\lambda$  or  $1/\lambda$  is an eigenvalue of  $\mathcal{P}$ . We shall see below, one and only one of these two values is an eigenvalue of  $\mathcal{P}$  and give a criterion to determine which one.

**Proposition 4.12.** *Let  $\omega^2 \in \sigma^\infty \setminus (\sigma_{th} \cup \sigma_{edge}^+ \cup \sigma_{cell})$ . The generalized eigenvalue problem (85) admits exactly  $N(\omega)$  pairs of solutions  $(\lambda, 1/\lambda)$  with  $|\lambda| = 1$  which are*

$$(90) \quad \{(e^{ik_j L}, e^{-ik_j L}), 1 \leq j \leq N(\omega)\}$$

where the  $k_j$ 's are the rightgoing propagative wavenumbers defined in (22).

$$(91) \quad \forall k = k_j \text{ or } -k_j, \quad \text{Ker } \mathcal{T}(e^{ikL}) = \text{span}\{\varphi_\ell^+ / k_\ell = k\} \oplus \text{span}\{\varphi_\ell^- / k_\ell = -k\}.$$

*Proof. Step 1.* We prove first that  $e^{\pm ik_j L}$  is solution of the generalized eigenvalue problem (85). By definition of the  $k_j$ 's (see (22)),  $w_j^\pm$  is  $\pm k_j$ -quasi-periodic thus

$$w_j^\pm|_{\Gamma_1} = e^{\pm ik_j L} \varphi_j^\pm \quad \text{and} \quad w_j^\pm|_{\Gamma_2} = e^{\pm 2ik_j L} \varphi_j^\pm.$$

Thanks to (5) and by definition of the operators  $\varphi \rightarrow e^\ell(\varphi), \ell = 0, 1$ ,

$$w_j^\pm|_{\mathcal{C}_0} = e^0(\varphi_j^\pm) + e^{\pm ik_j L} e^1(\varphi_j^\pm) \quad \text{and} \quad w_j^\pm|_{\mathcal{C}_1} = e^{\pm ik_j L} e^0(\varphi_j^\pm) + e^{\pm 2ik_j L} e^1(\varphi_j^\pm).$$

From the continuity of the normal derivative of  $w_j^\pm$  across  $\Gamma_1$  and the definition (66) of the  $\mathcal{T}^{\ell k}$ 's, we conclude that

$$\mathcal{T}(e^{\pm ik_j L}) \varphi_j^\pm = 0.$$

*Step 2.* Reciprocally, let  $\lambda$  be a solution of (85) with modulus 1. There exists  $k \in ]-\pi/L, \pi/L]$  such that  $\lambda = e^{ikL}$  and there exists  $\varphi \neq 0$  such that

$$(92) \quad \mathcal{T}(e^{ikL}) \varphi = 0$$

Let us define  $u(\varphi) \in L_{loc}^2$  as

$$u(\varphi)|_{\mathcal{C}_n} = C e^{in k L} (e^0(\varphi) + e^{ikL} e^1(\varphi)), \quad \forall n \in \mathbb{N},$$

where  $C$  is defined such that  $\|u(\varphi)\|_{L^2(\mathcal{C}_0)} = 1$ . By definition of  $e^0$  and  $e^1$ ,  $u(\varphi)$  is solution of (5) in each cell  $\mathcal{C}_n$ . By construction  $u(\varphi)$  is continuous across each  $\Gamma_n$  and because of (92), the co-normal derivative of  $u(\varphi)$  is also continuous across each  $\Gamma_n$ . Finally,  $e^{-ikx_d} u(\varphi)$  is  $L$ -periodic by construction. In conclusion,  $u(\varphi)$  is a propagative Floquet mode in the sense of (4-5) which is  $k$ -quasi periodic. Thus  $u(\varphi)$  belongs to  $\mathcal{F}(\omega, k)$  defined by (11) and described by (23). Thus

$$u(\varphi) = \sum_{\ell, k_\ell = k} \alpha_\ell^+ w_\ell^+ + \sum_{\ell, -k_\ell = k} \alpha_\ell^- w_\ell^-,$$

and we deduce that  $\varphi \in \text{span}\{\varphi_\ell^+ / k_\ell = k\} \oplus \text{span}\{\varphi_\ell^- / k_\ell = -k\}$ .  $\square$

We are now in position to characterize  $\mathcal{P}$  through its eigenvalues of modulus 1.

**Theorem 4.13.** *Let  $\omega^2 \notin \sigma_{th} \cup \sigma_{edge}^+ \cup \sigma_{cell}$ . The propagation operator  $\mathcal{P}$  is the unique solution of*

$$(93) \quad \text{Find } P \in \mathcal{L}(H^{1/2}(\Gamma_0)) \quad \text{such that } \mathcal{T}(P) = 0, \quad \rho(P) \leq 1,$$

that satisfies

$$(94) \quad \forall \lambda \in \sigma(P) \text{ with } |\lambda| = 1, \quad \forall \varphi \in \text{Ker}(P - \lambda I) \setminus \{0\}, \quad \text{Im} \langle (\mathcal{T}^{00} + \lambda \mathcal{T}^{10})\varphi, \varphi \rangle_{\Gamma_0} < 0.$$

*Proof. Step 1.* We know (Corollary 4.6) that  $\mathcal{P}$  is a solution of (93). Let us now show that it satisfies (94). By Proposition 4.9, each  $\varphi_j^+ = w_j^+|_{\Gamma_0}$  is an eigenvector of  $\mathcal{P}$  associated to  $\lambda := e^{ik_j L}$ . As a consequence of (93), any  $\lambda \in \sigma(\mathcal{P})$  is a solution of the quadratic eigenvalue problem (85) (cf. (86)). Therefore, thanks to Proposition 4.12, we have the double inclusion

$$\{e^{ik_j L}, 1 \leq j \leq N(\omega)\} \subset \sigma(\mathcal{P}) \cap \{|z| = 1\} \subset \{e^{\pm ik_j L}, 1 \leq j \leq N(\omega)\}.$$

Let us now show that none of the  $\{e^{-ik_j L}\}$  can be an eigenvalue of  $\mathcal{P}$ . By contradiction, assume that  $e^{-ik_j L} \in \sigma(\mathcal{P})$ . Then by Proposition 4.12 again, and more precisely (91), the corresponding eigenvector would necessarily be  $\varphi_j^- = w_j^-|_{\Gamma_0}$ , i. e.  $\mathcal{P}\varphi_j^- = e^{-ik_j L} \varphi_j^-$ . Let us now consider  $u^+(\varphi_j^-)$ , as (65), we obtain

$$u^+(\varphi_j^-)|_{\mathcal{C}_n} = e_0(\mathcal{P}^n \varphi_j^-) + e_1(\mathcal{P}^{n+1} \varphi_j^-) = e_0(e^{-in k_j L} \varphi_j^-) + e_1(e^{-i(n+1)k_j L} \varphi_j^-)$$

which we can also write, as  $w_j^-$  is  $(-k_j)$ -quasi-periodic,

$$u^+(\varphi_j^-)|_{\mathcal{C}_n} = e_0(w_j^-|_{\Gamma_n}) + e_1(w_j^-|_{\Gamma_{n+1}}) = w_j^-,$$

the last equality coming from the fact that  $w_j^-$  solves (5). This is of course a contradiction since  $u^+(\varphi_j^-)$  is supposed to be outgoing. We have thus shown that

$$\sigma(\mathcal{P}) \cap \{|z| = 1\} = \{e^{ik_j L}, 1 \leq j \leq N(\omega)\}.$$

Now let us show the property (94). By (87),  $\text{Ker}(\mathcal{P} - e^{ik_j L} I) \subset \text{Ker} \mathcal{T}(e^{ik_j L})$  and by (91) and since any  $\varphi_j^-$  is not an eigenvector of  $\mathcal{P}$ , we have  $\text{Ker}(\mathcal{P} - e^{ik_j L} I) = \text{span} \{\varphi_\ell^+, k_\ell = k_j\}$ . Let now  $\phi \in \text{span} \{\varphi_\ell^+, k_\ell = k_j\}$

$$\phi = \sum_{k_\ell = k_j} a_\ell \varphi_\ell^+ \text{ from which we define } v(\phi) = e_0(\phi) + e^{ik_j L} e_1(\phi)$$

Since, the function  $w_j^+$  satisfies  $w_j^+|_{\mathcal{C}_0} = e_0(\varphi_j^+) + e^{ik_j L} e_1(\varphi_j^+)$ ,  $v(\phi) = \sum_{k_\ell = k_j} a_\ell w_\ell^+$ . Proving (94) amounts to proving that

$$\forall 1 \leq j \leq N(\omega), \quad \text{Im} \langle (\mathcal{T}^{00} + e^{ik_j L} \mathcal{T}^{10})\phi, \phi \rangle_{\Gamma_0} < 0.$$

By definition of the local DtN operators (66), it is not difficult to check that

$$(95) \quad \text{Im} \langle (\mathcal{T}^{00} + e^{ik_j L} \mathcal{T}^{10})\phi, \phi \rangle_{\Gamma_0} = -q(v(\phi), v(\phi)).$$

If the set  $\{\ell, k_\ell = k_j\}$  has only one element ( $\ell = j$ ) then  $q(v(\phi), v(\phi)) = |a_j|^2 q(w_j^+, w_j^+) < 0$  a property which results from the definition of the rightgoing propagative modes, see (20). In general,

one has to use the bi-orthogonality property given in (21) which can be written in terms of the  $\varphi_\ell^+$  as follows

$$(96) \quad \forall \ell \neq j, \quad \langle (\mathcal{T}^{00} + e^{ik_j L} \mathcal{T}^{10}) \varphi_\ell^+, \varphi_j^+ \rangle_{\Gamma_0} = 0,$$

to deduce that

$$\text{Im} \langle (\mathcal{T}^{00} + e^{ik_j L} \mathcal{T}^{10}) \phi, \phi \rangle_{\Gamma_0} = \sum_{k_\ell = k_j} |a_\ell|^2 \langle (\mathcal{T}^{00} + e^{ik_j L} \mathcal{T}^{10}) \varphi_\ell^+, \varphi_\ell^+ \rangle_{\Gamma_0} = - \sum_{k_\ell = k_j} |a_\ell|^2 q(w_\ell^+, w_\ell^+) < 0.$$

**Step 2.** Let us now show that  $\mathcal{P}$  is the unique solution. Let  $P$  be a solution of (93-94) and let us prove that  $P = \mathcal{P}$ . The proof is similar to the proof of Theorem 4.8. We introduce the function defined in  $\Omega^+$  by

$$(97) \quad u(\varphi)|_{c_n} = e^0(P^n \varphi) + e^1(P^{n+1} \varphi).$$

If we can show that  $u(\varphi) = u^+(\varphi)$ , then we shall conclude as in the proof of Theorem 4.8 that  $P = \mathcal{P}$ . Thanks to Theorem 4.5, we know that  $u(\varphi)$  satisfies (30)(i),(ii) and (iii). It only remains to prove that  $u(\varphi)$  also satisfies the radiation condition (30)(iv) and conclude with the uniqueness result for (30). This is where (94) will come into play.

The condition (30)(iv) relies on the behaviour of  $u(\varphi)$  when  $x_d \rightarrow +\infty$ , *i.e.* the behaviour of  $u(\varphi)|_{c_n}$  when  $n \rightarrow +\infty$ . According to (97), we study the behaviour of  $P^n$  when  $n \rightarrow +\infty$ .

This behaviour is of course related to the spectrum of  $P$ . On the other hand, the condition (94) involves the eigenvalues of  $P$  of modulus one, in other words  $\sigma(P) \cap \{|z| = 1\}$ , which is a finite set since  $P$  is compact (Lemma 4.7). These are the object of the forthcoming analysis.

For the sequel, we introduce the finite dimensional space

$$(98) \quad E_1(P) := \bigoplus_{\lambda \in \sigma(P) \cap \{|z|=1\}} \text{Ker}(P - \lambda I)$$

This space satisfies obviously  $P E_1(P) \subset E_1(P)$ .

**Step 2.a : Description of  $\sigma(P) \cap \{|z| = 1\}$  and  $E_1(P)$ .** According to  $\mathcal{T}(P) = 0$ , reasoning as in Step 1, we know that any  $\lambda \in \sigma(P) \cap \{|z| = 1\}$  is solution of the quadratic eigenvalue problem (85) and by Proposition 4.12,

$$\sigma(P) \cap \{|z| = 1\} \subset \{e^{\pm ik_j L}, 1 \leq j \leq N(\omega)\},$$

and

$$E_1(P) \subset \text{span} \{\varphi_j^\pm, 1 \leq j \leq N(\omega)\}.$$

However, in the same way that we proved the inequality (95) for  $\varphi_j^+$ , one proves that

$$(99) \quad \text{Im} \langle (\mathcal{T}^{00} + e^{ik_j L} \mathcal{T}^{10}) \varphi_j^-, \varphi_j^- \rangle_{\Gamma_0} = -q(w_j^-, w_j^-) > 0,$$

Therefore by (94), we deduce that  $E_1(P)$  does not contain any of the  $\varphi_j^-$ , in other words

$$(100) \quad E_1(P) \subset \text{span} \{\varphi_j^+, 1 \leq j \leq N(\omega)\}$$

**Step 2.b: Each eigenvalue  $\lambda$  in  $\sigma(P) \cap \{|z| = 1\}$  is semi-simple**

This amounts to prove that for any  $\lambda \in \sigma(P) \cap \{|z| = 1\}$

$$(101) \quad \text{Ker} (P - \lambda I)^2 = \text{Ker} (P - \lambda I)$$

Let us prove that algebraic multiplicity of  $\lambda = e^{ik_j L}$  is 1. The proof for  $\lambda = e^{-ik_j L}$  is the same. If (101) were not true, there would exist  $\psi \neq 0$  ( a generalized eigenvector) such that

$$(P - e^{ik_j L})^2 \psi = 0 \quad \text{and} \quad (P - e^{ik_j L}) \psi \neq 0.$$

As  $(P - e^{ik_j L}) \psi \in \text{Ker}(P - e^{ik_j L})$ , according to Proposition 4.12 and (100), we deduce that

$$(P - e^{ik_j L}) \psi = \sum_{\ell/k_\ell=k_j} a_\ell^+ \varphi_\ell^+.$$

We then easily compute by induction over  $n \geq 1$  that

$$(102) \quad \forall n \in \mathbb{N}, \quad P^n \psi = e^{ink_j L} \varphi + n e^{i(n-1)k_j L} \sum_{\ell, k_\ell=k_j} a_\ell^+ \varphi_\ell^+.$$

Let us now define the function  $v(\psi) \in L_{loc}^2(\Omega^+)$  by

$$(103) \quad \forall n \in \mathbb{N}, \quad v(\psi)|_{c_n} = e^0(P^n \psi) + e^1(P^{n+1} \psi),$$

which belongs to  $H_{loc}^1(\Omega^+)$  and satisfies (30)(i)(ii)(iii) by Theorem 4.5 again. Let us compute the energy flux of this function, as defined in (13)

$$q(v(\psi), v(\psi)) := \text{Im} \int_{x_d=n} \left( \mathbb{A}_p \nabla v(\psi) \cdot \mathbf{e}_d \right) \overline{v(\psi)} dx_{\mathbf{s}}.$$

Since  $v(\psi)$  satisfies (30)(i)(ii), we recall that the above integral is independent of  $n$  which gives, using (103) and the definition (66) of the operators  $\mathcal{T}^{jk}$ ,

$$(104) \quad \forall n \in \mathbb{N}, \quad \text{Im} \langle (\mathcal{T}^{00} + e^{ik_j L} \mathcal{T}^{10}) \psi, \psi \rangle_{\Gamma_0} = \text{Im} \langle (\mathcal{T}^{00} + e^{ik_j L} \mathcal{T}^{10}) P^n \psi, P^n \psi \rangle_{\Gamma_0}$$

Using the expansion (102) and the bi-orthogonality property (21) in (104), we compute that, for all  $n$ ,

$$(105) \quad \left| \begin{aligned} n^2 \sum_{\ell, k_\ell=k_j} |a_\ell^+|^2 q(w_\ell^+, w_\ell^+) &= n \text{Im} \left\langle e^{ik_j L} (\mathcal{T}^{00} + e^{ik_j L} \mathcal{T}^{10}) \psi, \sum_{\ell, k_\ell=k_j} a_\ell^+ \varphi_\ell^+ \right\rangle_{\Gamma_0} \\ &+ n \text{Im} \left\langle \sum_{\ell, k_\ell=k_j} a_\ell^+ \varphi_\ell^+, e^{ik_j L} (\mathcal{T}^{00} + e^{ik_j L} \mathcal{T}^{10}) \psi \right\rangle_{\Gamma_0}. \end{aligned} \right.$$

Dividing (105) by  $n$  and making  $n \rightarrow +\infty$ , we deduce that, for all  $\ell$  such that  $k_\ell = k_j$ ,  $q(w_\ell^+, w_\ell^+) = 0$ . This is impossible since  $\omega^2 \notin \sigma_{\text{th}}$ .

**Step 2.c : Spectral decomposition of  $u(\varphi)$ .** Since the spectrum of  $P$  is discrete and the subset situated on the unit circle has no accumulation point, according to [18, Theorem 6.17], we can introduce the Riesz's projector  $\Pi_1$  (see [7, 36]) defined by the Cauchy integral

$$(106) \quad \Pi_1 = \frac{1}{2i\pi} \int_{c_\delta} (P - z)^{-1} dz, \quad c_\delta = \{(1 + \delta/2) e^{i\theta}, \theta \in [0, 2\pi]\} \cup \{(1 - \delta/2) e^{-i\theta}, \theta \in [0, 2\pi]\}$$

where  $\delta$  is less than the distance between  $\sigma(P) \cap \{|z| \neq 1\}$  and the unit circle. From Step 2.b., we have  $\text{Im } \Pi_1 = E_1(P)$  since the Riesz's projector is a projector on a generalized eigenspace. We then define the second projector  $\Pi_2 = I - \Pi_1$  with image  $E_2(P) := \text{Im } \Pi_2$ , and using [37], we can assert that

$$(107) \quad H^{1/2}(\Gamma_0) = E_1(P) \oplus E_2(P), \quad P E_2(P) \subset E_2(P).$$

These two projectors thus satisfy the properties

$$(108) \quad \Pi_j^2 = \Pi_j, \quad \Pi_j P = P \Pi_j, \quad j = 1, 2, \quad \Pi_1 \Pi_2 = \Pi_2 \Pi_1 = 0$$

from which it is easy to deduce that, defining  $P_j = \Pi_j P \equiv P \Pi_j$ ,

$$(109) \quad \forall n \in \mathbb{N}, \quad P^n = P_1^n + P_2^n.$$

therefore, according to (97),  $u(\varphi)$  can be decomposed as

$$(110) \quad u(\varphi) = u_1(\varphi) + u_2(\varphi), \quad u_j(\varphi)|_{\mathcal{C}_n} = e^0(P_j^n \varphi) + e^1(P_j^{n+1} \varphi), \quad \forall n \in \mathbb{N}, \quad j = 1, 2.$$

Note that each  $P_j$  is a solution of the Riccati equation so that, by Theorem (4.5),

$$(111) \quad u(\varphi) \in H_{loc}^1(\Omega_0), \quad -\nabla \cdot (\mathbb{A}_p \nabla u(\varphi)) - \omega^2 b_p u(\varphi) = 0, \quad \text{in } \Omega^+, \quad (\mathbb{A}_p \nabla u) \cdot \nu = 0 \quad \text{on } \partial\Omega^+ \setminus \Gamma_0.$$

**Step 2.d : Behaviour at infinity of  $u(\varphi)$ .** By construction, the spectrum of  $P_2$  is  $\sigma(P_2) = \{0\} \cup (\sigma(P) \cap \{|z| < 1\})$  so that the spectral radius of  $P_2$ ,  $\rho(P_2)$ , satisfies  $\rho(P_2) \leq 1 - \delta < 1$ .

Since  $\rho(P_2) = \lim_{m \rightarrow +\infty} \|P_2^m\|^{\frac{1}{m}}$ , where  $\|\cdot\|$  is the norm in  $\mathcal{L}(H^{1/2}(\Gamma_0))$ , we deduce that for all  $n$

$$(112) \quad \|P_2^n\| \leq C e^{-\alpha' n}, \quad \text{for some } C, \alpha' > 0.$$

Then, according to (110) and (111), it is easy to see that for  $0 < \alpha < \alpha'$

$$(113) \quad e^{\alpha x_d} u_2(\varphi) \in H^1(\Omega^+).$$

Since  $P_1 = P \Pi_1$ , for  $n \geq 1$ ,  $P_1^n = P^n \Pi_1$ , thus  $u_1(\varphi)|_{\mathcal{C}_n} = e^0(P^n \Pi_1 \varphi) + e^1(P^{n+1} \Pi_1 \varphi)$ . Since  $\Pi_1 \varphi \in E_1(P) \subset \text{span } \{\varphi_j^+, 1 \leq j \leq N(\omega)\}$ , we can write

$$(114) \quad \forall n \geq 1, \quad u_1(\varphi)|_{\mathcal{C}_n} = \sum_{j=1}^{N(\omega)} \alpha_j (e^0(P^n \varphi_j^+) + e^1(P^{n+1} \varphi_j^+)) = \sum_{j=1}^{N(\omega)} \alpha_j w_j^+.$$

where the last equality comes from  $w_j^+ = u^+(\varphi_j^+)$ , cf. (83), and formula (65). Joining (110), (113) and (114), it is clear that  $u(\varphi)$  satisfies the outgoing radiation condition (Definition (2.1)). This concludes the proof.  $\square$

## 4.4 The DtN reduction method and corresponding algorithm

In this last section, we put together all the pieces of the puzzle that we began in Section 3.2 and continue up to section 4.3.

According to Section 3.2, we first wish to compute the solution  $u$  of (27) inside the bounded domain  $\Omega_0$  by solving the problem

$$(115) \quad \begin{cases} -\nabla \cdot (\mathbb{A} \nabla u_0) - \omega^2 b u_0 = f & \text{in } \Omega_0, \\ \mathbb{A} \nabla u_0 \cdot \nu = 0 & \text{on } \partial\Omega_0 \setminus \Gamma_0, \\ \mathbb{A} \nabla u_0 \cdot \mathbf{e}_d + \Lambda u_0 = 0 & \text{on } \Gamma_0. \end{cases}$$

From Lemma 3.7 and Theorem 3.8, we know that this problem is well-posed and from Lemma 3.6 we know that its solution  $u_0$  characterizes the restriction of  $u$  to  $\Omega_0$ . This lemma also says that the restriction of  $u$  to  $\Omega^+ = \Omega \setminus \bar{\Omega}_0$  is then given by  $u^+(\varphi)$ , see (30), with  $\varphi := u_0|_{\Gamma_0}$ .

From the practical point of view the problem is that finding  $u^+(\varphi)$ , and thus the operator  $\Lambda$  which is defined from  $u^+(\varphi)$  amounts to solving a problem in an infinite domain, namely  $\Omega^+$ . However, the content of Sections 4.1 to 4.3 allows us to circumvent this problem, through the introduction of the local DtN operators  $\mathcal{T}^{\ell k}$  (see (66, 67), the propagator  $\mathcal{P}$  characterized by Theorem 4.13, and the cell by cell reconstruction formula (65) for  $u^+(\varphi)$ . The last piece of the puzzle is a practical formula for the operator  $\Lambda$ . Such a formula is an immediate consequence of

**Proposition 4.14.** *Let  $\omega^2 \notin \sigma_{th} \cup \sigma_{edge}^+ \cup \sigma_{cell}$ , the DtN operator  $\Lambda$  is given by*

$$(116) \quad \Lambda = \mathcal{T}^{00} + \mathcal{T}^{10} \mathcal{P}.$$

where  $\mathcal{P}$  is the propagator, characterized by Theorem 4.13, and the  $\mathcal{T}^{\ell k}$  are the local DtN operators.

*Proof.* From , we know that, in the first cell  $\mathcal{C}_0$ ,  $u^+(\varphi) = e_0(\varphi) + e_1(\mathcal{P}\varphi)$ . Thus

$$\Lambda\varphi = -\mathbb{A}_p \nabla u^+(\varphi) \cdot \mathbf{e}_d|_{\Gamma_0} = -\mathbb{A}_p \nabla e_0(\varphi) \cdot \mathbf{e}_d|_{\Gamma_0} - \mathbb{A}_p \nabla e_0(\mathcal{P}\varphi) \cdot \mathbf{e}_d|_{\Gamma_0}$$

and the conclusion follows from the definition of  $\mathcal{T}^{00}$  and  $\mathcal{T}^{10}$ .  $\square$

We then propose the following algorithm for the solution of (27) (at the continuous level - see Section 5.1 for the discrete counterpart).

- Step 1 : Compute the DtN operator  $\Lambda$ :
  - solve the two cell problems (62-63);
  - compute the local DtN operators  $\mathcal{T}^{\ell k}$ ,  $\ell, k \in \{0, 1\}$  defined in (66);
  - compute the unique solution  $\mathcal{P}$  of spectral radius less than 1 satisfying the stationary Ricatti equation (93) such that the unitary eigenvalues satisfy (94) (cf. Theorem 4.13);
  - compute the DtN operator  $\Lambda$  by formula (116);
- Step 2 : Solve the problem (51) in  $\Omega_0$ ;
- Step 3 : Reconstruct the solution of (27) in  $\Omega^+$ , cell by cell, using the formula

$$(117) \quad \forall n \in \mathbb{N}, \quad u^+(\varphi)|_{\mathcal{C}_n} = e^0(\mathcal{P}^n \varphi) + e^1(\mathcal{P}^{n+1} \varphi).$$



# 5 Numerical approximation : algorithm and results

## 5.1 Finite element approximation and related algorithm

We now describe in some details, the discretization of the algorithm of section 4.4 in the case  $d = 1$  (however, the generalization to  $d = 2$  is quite straightforward). The discretization of the various PDEs to be handled is chosen to be based on the Lagrange finite element method.

For the cell problems, we shall consider a conforming triangular mesh  $\mathcal{T}_h(\mathcal{C})$  whose "trace" on  $\Gamma^j$  defines a 1D mesh  $\mathcal{T}_h(\Gamma^j)$  of  $\Gamma^j$ . A useful property that we shall ask to this mesh is

$$(118) \quad \text{The mesh } T_h(\Omega) \text{ is periodic, that is to say } \mathcal{T}_h(\Gamma_1) = \mathcal{T}_h(\Gamma_0) + L \mathbf{e}_d$$

where, implicitly, each mesh is identified to the set of its edges. In the following, we denote  $V_h(\Omega) \subset H^1(\Omega)$  the usual approximation subspace based on  $\mathbb{P}_k$ -Lagrange finite elements (for some degree  $k \geq 1$ ) and define the corresponding trace spaces (also of  $\mathbb{P}_k$ -Lagrange type, but in 1D)

$$(119) \quad V_h(\Gamma^j) := \{v_h|_{\Gamma^j} / v_h \in V_h(\Omega)\} \subset H^{1/2}(\Gamma_0).$$

The interest of the periodicity assumption (118) lies in the following observation

$$(120) \quad (118) \implies \text{one can make the identification } V_h(\Gamma_1) \equiv V_h(\Gamma_0).$$

In the following, we shall denote  $N := \dim V_h(\Gamma_0)$  and we explain below how we construct a discrete DtN operator  $\Lambda_h$ , which is decomposed into several steps according to Section 4.4.

**Definition of the discrete local DtN operators.** These will be defined as operators  $\mathcal{T}_h^{\ell k}$  in  $\mathcal{L}(V_h(\Gamma_0))$ ,  $\ell, k \in \{0, 1\}^2$ , thanks to the identification (120). In some sense, we use the same finite dimensional subspace  $V_h(\Gamma_0)$  for the approximation of both infinite dimensional spaces  $H^{1/2}(\Gamma_0)$  and  $H^{-1/2}(\Gamma_0)$ . We simply need to define  $\mathcal{T}_h^{\ell k} \varphi_h$  for any  $\varphi_h \in V_h(\Gamma_0)$ . This is done consistently with the definition (66) of  $\mathcal{T}^{\ell k} \varphi$ , in a weak (or variational) sense :

- We introduce  $e_h^\ell(\varphi_h) \in V_h(\Omega)$  the function issued from the standard Lagrange finite element approximation of the boundary value problem (62, 63) for  $\varphi = \varphi_h$  (we omit the details).
- We define  $\mathcal{T}_h^{\ell k} \varphi_h$  from

$$(121) \quad \forall \psi_h \in V_h(\Gamma_0), \quad \langle \mathcal{T}_h^{\ell k} \varphi_h, \psi_h \rangle_{\Gamma_0} = \int_{\mathcal{C}_0} \left( \mathbb{A}_p \nabla e_h^\ell(\varphi_h) \cdot \overline{\nabla e_h^k(\psi_h)} - \omega^2 b_p e_h^\ell(\varphi_h) \overline{e_h^k(\psi_h)} \right)$$

In practice, given a basis  $\{\varphi_h^1, \dots, \varphi_h^N\}$ , for instance the usual finite element basis, each  $\mathcal{T}_h^{\ell k}$  is represented by a  $N \times N$  matrix.

**Definition of the discrete propagation operator  $\mathcal{P}_h$ .** Again, this operator will be searched as an element of  $\mathcal{L}(V_h(\Gamma_0))$ . Of course, in view of (93), this operator will be searched as a solution of the Riccati equation

$$(122) \quad \text{Find } \mathcal{P}_h \in \mathcal{L}(V_h(\Gamma_0)) \text{ such that } \mathcal{T}_h(X) := \mathcal{T}_h^{10} \mathcal{P}_h^2 + (\mathcal{T}_h^{00} + \mathcal{T}_h^{11}) \mathcal{P}_h + \mathcal{T}_h^{01} = 0 \text{ and } \rho(\mathcal{P}_h) \leq 1.$$

More precisely, in view of the characterization of the continuous propagation operator  $\mathcal{P}$  as the unique solution of (93) that satisfies (94), we use a spectral approach to characterize the operator

$\mathcal{P}_h$  as "the good" solution of (122). The approach is as follows.

We introduce the following quadratic eigenvalue problem seen as an approximation of (85):

$$(123) \quad \text{Find } \lambda \in \mathbb{C} \text{ such that } \text{Ker } \mathcal{T}_h(\lambda_h) \neq 0.$$

The determinant  $\det \mathcal{T}_h(\lambda)$  is a polynomial of degree  $2N$  and, for simplicity of the presentation, we shall assume in the following that

$$(124) \quad \text{All the roots of } \det \mathcal{T}_h(\lambda) = 0 \text{ are simple.}$$

This situation is of course generic and is the one that one encounters most often in practice.

Since the matrices  $\mathcal{T}_h^{\ell k}$ ,  $\ell, k \in \{0, 1\}$  are easily shown to satisfy the same adjointness properties as  $\mathcal{T}^{\ell k}$ ,  $\ell, k \in \{0, 1\}$  as described in Proposition 4.3, it is easy to show that for any  $\lambda \neq 0$

$$\text{Ker } \mathcal{T}_h(\lambda) \neq 0 \iff \text{Ker } \mathcal{T}_h(1/\lambda) \neq 0.$$

As a consequence, the set  $S_h$  of solutions of (123) can be described as follows

$$(125) \quad S_h = \{(\lambda_1, \lambda_1^{-1}), \dots, (\lambda_N, \lambda_N^{-1})\} \quad |\lambda_j| \leq 1, \lambda_j \neq \lambda_{j'} \text{ for } j \neq j'$$

A consequence of (124) is that

$$\forall 1 \leq j \leq N, \quad \dim \text{Ker } \mathcal{T}_h(\lambda_j) = \dim \text{Ker } \mathcal{T}_h(\lambda_j^{-1}) = 1$$

and one can find, for each  $j$ ,  $(\varphi_j, \varphi_j^*) \in V_h(\Gamma_0)$ , normalized in  $L^2(\Gamma_0)$  for instance, such that

$$(126) \quad \text{Ker } \mathcal{T}_h(\lambda_j) = \text{span } \varphi_j, \quad \text{Ker } \mathcal{T}_h(\lambda_j^{-1}) = \text{span } \varphi_j^*,$$

Let us partition  $\{1, 2, \dots, N\}$  as

$$\{1, 2, \dots, N\} = I_p \cup I_e, \quad \text{where } j \in I_p \iff |\lambda_j| = 1.$$

Let us define

$$(127) \quad c_h(\varphi_h) := \text{Im} \langle (\mathcal{T}_h^{00} + \lambda_h \mathcal{T}_h^{10}) \varphi_h, \varphi_h \rangle_{\Gamma_0} \text{ for any } \varphi_h \in V_h(\Gamma_0).$$

When  $j \in I_p$ , according to Theorem 4.13, we expect that one and only one of the two numbers  $(c_h(\varphi_j), c_h(\varphi_j^*))$  is strictly positive.

If (124) holds then we can now construct the operator  $\mathcal{P}_h$  by constructing a system of hopefully linearly independent  $\{\psi_1, \psi_2, \dots, \psi_N\}$  of  $V_h(\Gamma_0)$ , so that they form a basis of  $V_h(\Gamma_0)$ , in which the operator  $\mathcal{P}_h$  will be diagonal. More precisely

$$(128) \quad \left| \begin{array}{l} \text{(i) For } i \in I_e, \quad \text{we set } \psi_j := \varphi_j \text{ and } \mathcal{P}_h \psi_j := \lambda_j \psi_j \\ \text{(ii) For } i \in I_p, \quad \text{we set } \begin{cases} \psi_j := \varphi_j \text{ and } \mathcal{P}_h \psi_j := \lambda_j \psi_j & \text{if } c_h(\varphi_j) < 0, \\ \psi_j := \varphi_j^* \text{ and } \mathcal{P}_h \psi_j := \lambda_j^{-1} \psi_j & \text{if } c_h(\varphi_j^*) < 0. \end{cases} \end{array} \right.$$

The operator  $\mathcal{P}_h$  is then fully defined if we assume that  $\{\psi_1, \psi_2, \dots, \psi_N\}$  is a basis of  $V_h(\Gamma_0)$ .

**Definition of the discrete DtN operator  $\Lambda_h$ .** According to (116), we simply define

$$(129) \quad \Lambda_h = \mathcal{T}_h^{00} + \mathcal{T}_h^{10} \mathcal{P}_h \in \mathcal{L}(V_h(\Gamma_0)).$$

**The discrete problem in bounded domain  $\Omega_0$ .** As for the cell problems, we shall consider a conforming triangular mesh  $\mathcal{T}_h(\Omega_0)$  whose trace on  $\Gamma_0$  coincides with the 1D mesh  $\mathcal{T}_h(\Gamma_0)$  introduced previously and we denote  $V_h(\Omega_0) \subset H^1(\Omega)$  the usual approximation subspace based on  $\mathbb{P}_k$ -Lagrange finite elements of degree  $k$ . According to Section 3.2 and more precisely (53), the discrete solution in  $\Omega_0$ , denoted  $u_h^0$ , will be the solution of the variational problem

$$(130) \quad \begin{aligned} &\text{Find } u_{0,h} \in V_h(\Omega_0) \text{ such that } a_{0,h}(u_{0,h}, v) = \int_{\Omega_0} f \bar{v}_h, \quad \forall v_h \in V_h(\Omega_0), \text{ with} \\ &\forall (u_h, v_h) \in V_h(\Omega_0)^2, \quad a_{0,h}(u_h, v_h) = \int_{\Omega_0} \left[ \mathbb{A} \nabla u_h \cdot \nabla \bar{v}_h - \omega^2 b u_h \bar{v}_h \right] + \langle \Lambda_h u_h, v_h \rangle_{\Gamma_0} \end{aligned}$$

**The discrete solution outside  $\Omega_0$ .** According to (117), once  $u_{0,h}$  is computed, we can construct an approximation  $u_h$  of the exact solution  $u$ , cell by cell, with the formula

$$\forall n \in \mathbb{N}, \quad u_h|_{c_n} = e_h^0(\mathcal{P}_h^n \varphi_h) + e^1(\mathcal{P}_h^{n+1} \varphi_h) \quad \text{with } \varphi_h := u_{0,h}|_{\Gamma_0}.$$

## 5.2 Numerical experiments

In this last section, we report on two series of numerical experiments done in the 2D case ( $d = 1$ ).

**Numerical experiments 1:** This concerns the case of a locally perturbed periodic waveguide. More precisely, we consider the following problem

$$(131) \quad \begin{cases} -\Delta u - \omega^2 b u = f & \text{in } \Omega \\ \nabla u \cdot \nu = 0 & \text{on } \partial\Omega. \end{cases}$$

where  $\Omega$  is a locally perturbed periodic waveguide whose shape is represented in Figure 3, the periodicity cell  $\mathcal{C}$  is such that  $\mathcal{C} \subset (1/2, 3/2) \times (0, 1)$ ,  $f$ , represented in Figure 3 (top figure), is a compactly supported source such that

$$(132) \quad f = 25\chi_{\Omega_0}(x_1, x_2) \exp(-100(x_1^2 + (x_2 - 1/2)^2)), \quad \text{with } \Omega_0 := \Omega \cap \{-1/2 < x_1 < 1/2\},$$

and  $b$ , represented in Figure 3 (bottom figure), is a local perturbation of a periodic coefficient:

$$\text{Supp}(b - b_p) \subset \Omega_0, \quad b|_{\Omega_0} = 1, \quad b_p|_{\mathcal{C}} = \begin{cases} 10 & \text{if } (x_1 - 1)^2 + (x_2 - 0.5)^2 \leq 0.2^2 \\ 1 & \text{else} \end{cases}.$$

In Figure 3, the domain  $\Omega_0$  is delimited by white lines. As the domain has two periodic outlet at infinity, one has a priori to solve not one half-waveguide problem but two (independent) half-waveguide problems set in  $\Omega^\pm := \Omega \cap \{\pm x_d > a\}$  in order to compute two Dirichlet-to-Neumann operators  $\Lambda^\pm$  and restrict the computation in  $\Omega_0$

$$(133) \quad \begin{cases} -\Delta u_0 - \omega^2 b u_0 = f & \text{in } \Omega_0 \\ \nabla u \cdot \nu = 0 = 0 & \text{on } \partial\Omega \cap \partial\Omega_0; \\ \pm \nabla u_0 \cdot \mathbf{e}_d + \Lambda^\pm u_0 = 0 & \text{on } \Gamma^\pm := \{(x, y), x = \pm a\} \end{cases}$$

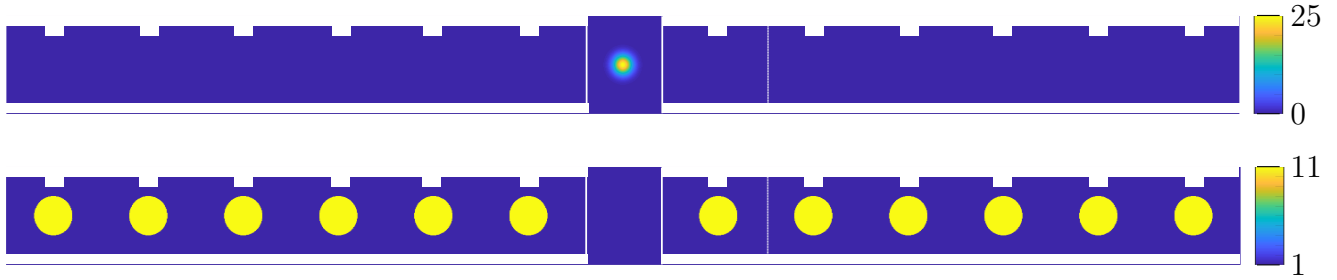

Figure 3: The compactly supported source term (top figure) and the local perturbation of the periodic coefficient (bottom figure) represented in the locally perturbed periodic waveguide  $\Omega$  that are considered in Problem 131.

However because of the position of the artificial boundaries  $\Gamma^\pm$ , the symmetry in  $x_1$  of the periodicity cell, one can show that the associated propagative operators are equal and the same holds for DtN operators:  $\mathcal{P}^+ = \mathcal{P}^- = \mathcal{P}$  and  $\Lambda^+ = \Lambda^- = \Lambda$ .

In order to illustrate the theoretical results of the paper and the algorithm presented in the previous section, we consider different values of  $\omega$ : three values,  $\omega_e^1 = \sqrt{29}, \omega_e^2 = \sqrt{360}, \omega_e^3 = \sqrt{418}$  are such that  $(\omega_e^i)^2 \notin \sigma^\infty$ , *i.e* the  $\omega_e^i$ 's are not propagative frequencies and three values,  $\omega_p^1 = 10, \omega_p^2 = 20, \omega_p^3 = 50$  are such that  $\omega_p^i \in \sigma^\infty$ , *i.e* the  $\omega_p^i$ 's are propagative frequencies, where we recall that  $\sigma^\infty$  is the essential spectrum of the underlying periodic operator (defined in (3)). The position of these values with respect to the essential spectrum (in blue) is represented in Figure 4. Note that the essential spectrum is obtained from a numerical computation (this is done only for the illustration, this computation is not necessary in our algorithm).

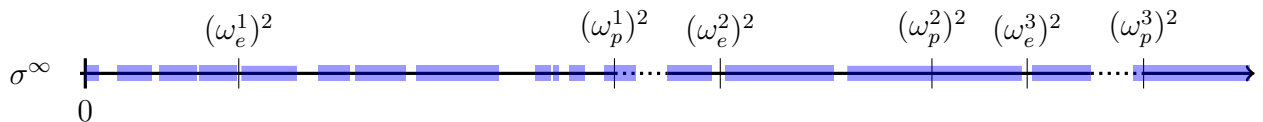

Figure 4: Essential spectrum (in blue) and position of the non propagative frequencies  $\omega_e^i$  and the propagative ones  $\omega_p^i$ .

For each frequency, we use  $\mathbb{P}_1$ -Lagrange finite elements with  $h = 0.005$ . As described at the end of Section 4.4, we solve the two cell problems, compute the discrete local DtN operators and finally solve the discrete Riccati equation by solving the discrete quadratic eigenvalue problem, as described in Section 5.1. We represent, for the values of the frequencies mentioned above, in Figure 5 the eigenvalues of the discrete propagative operator  $\mathcal{P}_h$  and some of the solutions of the quadratic eigenvalue problem which are not eigenvalues of  $\mathcal{P}_h$ . We recall that for non propagative frequencies, the solutions of the quadratic eigenvalue problem are strictly inside the unit cell or strictly outside: the operator  $\mathcal{P}_h$  is constructed from the eigenvalues, which are strictly inside the unit circle, and their associated eigenvector. Whereas for propagative frequencies, a finite (and even) number of the solutions of the quadratic eigenvalue problem are on the unit circle. For each of these values, we compute the associated quantity defined in (127): this is an eigenvalue of  $\mathcal{P}_h$  if and only if this quantity is negative.

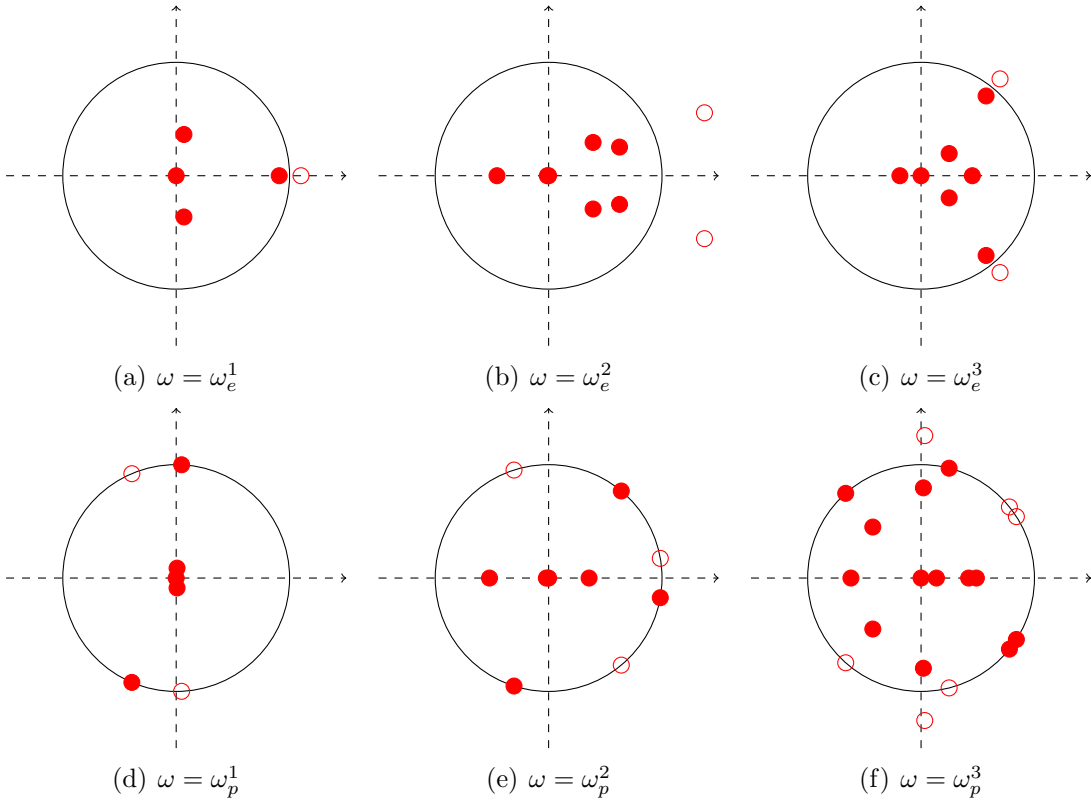

Figure 5: The eigenvalues of the discrete propagative operator  $\mathcal{P}_h$  (filled circle) and some other solutions of the quadratic eigenvalue problem (empty circle) for the values of the frequencies represented in Figure 4

We can finally compute the DtN operator and solve (133). The solution can be reconstructed in the whole waveguide, as explained in (117). The solution of the values of the frequencies represented in Figure 4 is represented in  $\Omega \cap \{-6.5 < x_d < 6.5\}$  in Figure 6. Note that all the solutions are symmetric with respect to the axis  $x_1 = 0$  and  $x_2 = 1/2$ . This is due the same symmetry property of the domain  $\Omega$ , the source term  $f$  and the coefficient  $b$  (see Figure 3). Note also that the solutions for the non-propagative frequencies decay when  $x_1 \rightarrow \pm\infty$ : each solution is actually exponentially decaying at the infinities and its exponential rate is linked to the modulus of the largest (in modulus) eigenvalue of the associated propagative operator (see Theorem 4.8 and its proof). Note for instance that  $\omega = \omega_e^2$ , the decay of the solution is really clear whereas for  $\omega = \omega_e^1$  or  $\omega_e^3$ , the decay of the solution is not obvious (for these cases, the largest eigenvalue has a modulus closed to one).

**Numerical experiments 2:** This concerns the case of the junction of two different half-waveguides. More precisely, we consider the solution of (131) for the domain  $\Omega$  whose shape is represented in Figure 7, the source term  $f$ , represented in Figure 7 (top figure), is given by (132) (same as the first numerical experiment) and the coefficient  $b$ , represented in Figure 7 (bottom

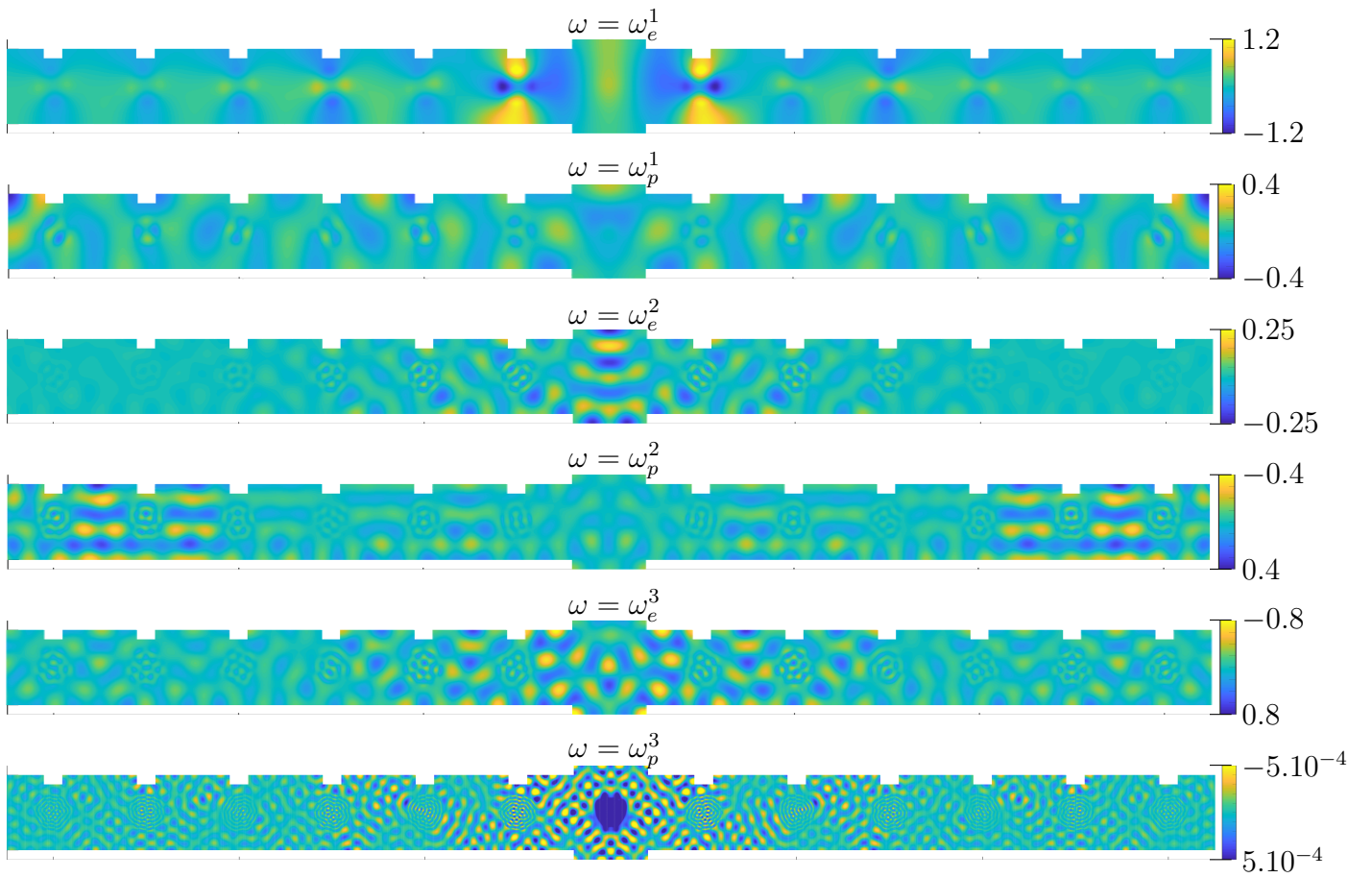

Figure 6: Solution of Problem (131) for the datas represented in Figure 3 and for the values of the frequency represented in Figure 4: from top to bottom  $\omega = \omega_e^1, \omega_p^1, \omega_e^2, \omega_p^2, \omega_e^3, \omega_p^3$ .

figure), is 1-periodic in  $\Omega \cap \{x_1 < -1/2\}$  and given by

$$b|_{\Omega \cap \{-3/2 < x_1 < -1/2\}} = \begin{cases} 10 & \text{if } |x_1 + 1| < 0.4 \text{ and } |x_2 - 0.5| \leq 0.4 \\ 1 & \text{else;} \end{cases}$$

it is 1-periodic in  $\Omega \cap \{x_1 > 1/2\}$  and given by

$$b|_{\Omega \cap \{1/2 < x_1 < 3/2\}} = 1 + 16 \exp(-((x_1 - 0.9)^2 + (x_2 - 0.4)^2)/0.2^2)$$

and finally

$$b|_{\Omega_0} = 1,$$

The waveguide has two different periodic outlets at infinity (different geometries and different coefficient). One has to solve the two different (independent) half-waveguide problems in order to compute the two propagative operators  $\mathcal{P}_h^\pm$  corresponding to each half-waveguide (the eigenvalues of the two propagative operators are represented in Figure 8 for  $\omega = 20$ ). Note that the considered frequency  $\omega = 20$  is a propagative frequency for each half-waveguide. Note also that there are much more propagative modes for the left half-waveguide than for the right one. Finally, the DtN operators can be computed, Problem (133) can be solved and the solution can be reconstructed in the whole waveguide. The solution for  $\omega = 20$  is represented in  $\Omega \cap \{-6.5 < x_1 < 6.5\}$  in Figure 9.

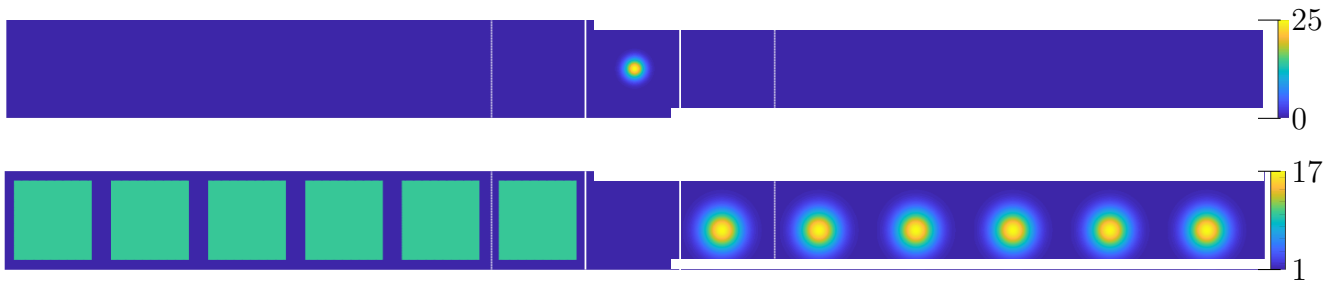

Figure 7: The compactly supported source term (top figure) and the coefficient (bottom figure) represented in the junction of two different half-waveguides  $\Omega$ , the associated solution is represented in Figure 9 for  $\omega = 20$ .

## References

- [1] F. Assous, P. Ciarlet, and S. Labrunie. *Mathematical foundations of computational electromagnetism*. Vol. 198. Springer, 2018.
- [2] J.-P. Berenger. “A perfectly matched layer for the absorption of electromagnetic waves”. In: *J. Comput. Phys.* 114.2 (1994), pp. 185–200. ISSN: 0021-9991.
- [3] A.-S. Bonnet-Bendhia et al. “Acoustic diffraction by a plate in a uniform flow”. In: *Math. Models Methods Appl. Sci.* 12.5 (2002), pp. 625–647. ISSN: 0218-2025. DOI: 10.1142/S0218202502001829. URL: <https://doi.org/10.1142/S0218202502001829>.
- [4] L. Bourgeois and É. Lunéville. “On the use of sampling methods to identify cracks in acoustic waveguides”. In: *Inverse Problems* 28.10 (2012), pp. 105011, 18.

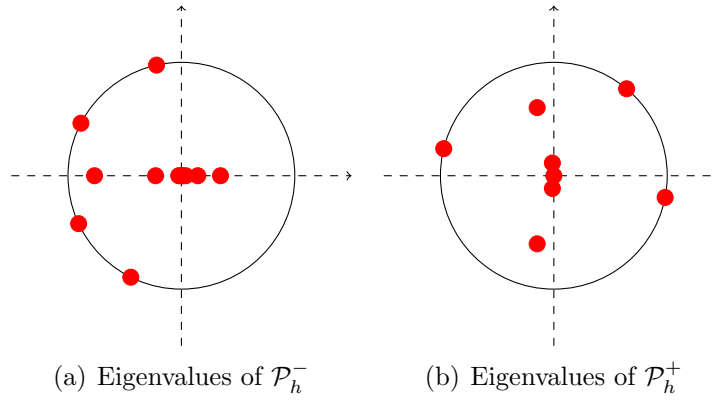

Figure 8: The eigenvalues of the discrete propagative operator  $\mathcal{P}_h^\pm$  for the two half-waveguides represented in Figure 7 and for  $\omega = 20$ .

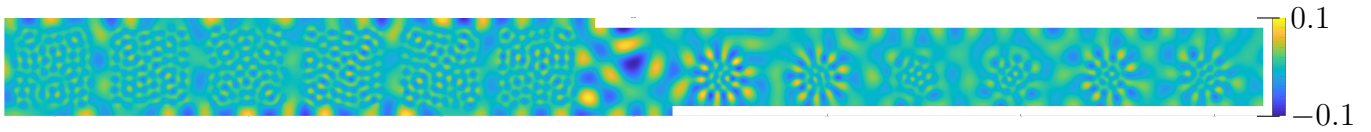

Figure 9: Solution of Problem (131) for the datas represented in Figure 7 and for  $\omega = 20$ .

- [5] D. L. Colton and R. Kress. *Integral equation methods in scattering theory*. Pure and Applied Mathematics (New York). A Wiley-Interscience Publication. New York: John Wiley & Sons Inc., 1983, pp. xii+271. ISBN: 0-471-86420-X.
- [6] E. B. Davies and L. Parnowski. “Trapped modes in acoustic waveguides”. In: *Quart. J. Mech. Appl. Math.* 51.3 (1998), pp. 477–492. DOI: 10.1093/qjmam/51.3.477.
- [7] N. Dunford and J. T. Schwartz. *Linear operators part I: general theory*. Vol. 243. Interscience publishers New York, 1958.
- [8] S. Fliss. “Étude mathématique et numérique de la propagation des ondes dans des milieux périodiques localement perturbés”. PhD thesis. PhD thesis, Ecole Polytechnique, Nov. 2009.
- [9] S. Fliss and P. Joly. “Exact boundary conditions for wave propagation in periodic media containing a local perturbation”. In: *Wave Propagation in Periodic Media, Book Series: Progress in Computational Physics* 1 (2009), pp. 108–134.
- [10] S. Fliss and P. Joly. “Solutions of the time-harmonic wave equation in periodic waveguides: asymptotic behaviour and radiation condition”. In: *Archive for Rational Mechanics and Analysis* 219.1 (2016), pp. 349–386.
- [11] L. Friedlander. “On the spectrum of a class of second order periodic elliptic differential operators”. In: *Comm. Math. Phys.* 229.1 (2002), pp. 49–55.
- [12] T. Hagstrom. “Radiation boundary conditions for the numerical simulation of waves”. In: *Acta numerica, 1999*. Vol. 8. Acta Numer. Cambridge: Cambridge Univ. Press, 1999, pp. 47–106.
- [13] I. Harari, I. Patlashenko, and D. Givoli. “Dirichlet-to-Neumann maps for unbounded wave guides”. In: *J. Comput. Phys.* 143.1 (1998), pp. 200–223. ISSN: 0021-9991.



- [14] V. Hoang. “A radiation condition for a periodic semi-infinite waveguide”. In: 71.3 (2011), p. 7. URL: <http://www.math.kit.edu/iana1/~hoang/media/radwaveguidehoang.pdf>.
- [15] V. Hoang. “The Limiting Absorption Principle for a Periodic Semi-Infinite Waveguide.” In: *SIAM J. Appl. Math.* 71.3 (2011), pp. 791–810. URL: <http://dblp.uni-trier.de/db/journals/siamam/siamam71.html#Hoang11>.
- [16] P. Joly, J.-R. Li, and S. Fliss. “Exact boundary conditions for periodic waveguides containing a local perturbation”. In: *Commun. Comput. Phys* 1.6 (2006), pp. 945–973.
- [17] Y. E. Karpeshina. *Perturbation theory for the Schrödinger operator with a periodic potential*. Vol. 1663. Lecture Notes in Mathematics. Berlin: Springer-Verlag, 1997.
- [18] T. Kato. *Perturbation theory for linear operators*. Classics in Mathematics. Reprint of the 1980 edition. Berlin: Springer-Verlag, 1995, pp. xxii+619. ISBN: 3-540-58661-X.
- [19] A. Kirsch and A. Lechleiter. “A radiation condition arising from the limiting absorption principle for a closed full- or half-waveguide problem”. In: *Mathematical Methods in the Applied Sciences* 41.10 (2018), pp. 3955–3975. DOI: 10.1002/mma.4879. eprint: <https://onlinelibrary.wiley.com/doi/pdf/10.1002/mma.4879>. URL: <https://onlinelibrary.wiley.com/doi/abs/10.1002/mma.4879>.
- [20] V. A. Kondratiev. “Boundary-value problems for elliptic equations in domains with conical or angular points”. In: *Trans. Moscow Math. Soc.* 16 (1967), pp. 227–313.
- [21] V. A. Kozlov, V. G. Maz’ya, and J. Rossmann. *Elliptic Boundary Value Problems in Domains with Point Singularities*. Vol. 52. Mathematical Surveys and Monographs. Providence: AMS, 1997.
- [22] V. A. Kozlov, V. G. Maz’ya, and J. Rossmann. *Spectral problems associated with corner singularities of solutions to elliptic equations*. Vol. 85. Mathematical Surveys and Monographs. Providence: AMS, 2001.
- [23] P. Kuchment. *Floquet theory for partial differential equations*. Vol. 60. Operator Theory: Advances and Applications. Basel: Birkhäuser Verlag, 1993, pp. xiv+350. ISBN: 3-7643-2901-7.
- [24] M. Lenoir and A. Tounsi. “The localized finite element method and its application to the two-dimensional sea-keeping problem”. In: *SIAM J. Numer. Anal.* 25.4 (1988), pp. 729–752. ISSN: 0036-1429.
- [25] J.-L. Lions and E. Magenes. “Problèmes aux limites non homogènes et applications”. In: (1968).
- [26] V. G. Maz’ya and B. A. Plamenevskiui. “On the coefficients in the asymptotics of solutions of elliptic boundary value problems with conical points”. In: *Math. Nachr.* 76 (1977). Engl. transl. Amer. Math. Soc. Transl. 123:57–89, 1984, pp. 29–60.
- [27] M. McIver et al. “Embedded Trapped Modes for Obstacles in Two-Dimensional Waveguides”. In: *Quart. J. Mech. Appl. Math.* 54.2 (2001), pp. 273–293. DOI: 10.1093/qjmam/54.2.273.
- [28] W. McLean. *Strongly elliptic systems and boundary integral equations*. Cambridge: Cambridge University Press, 2000, pp. xiv+357.
- [29] A. Morame. “The absolute continuity of the spectrum of Maxwell operator in a periodic media”. In: *J. Math. Phys.* 41.10 (2000), pp. 7099–7108.
- [30] S. A. Nazarov. “Elliptic boundary value problems with periodic coefficients in a cylinder”. In: *Izv. Math.* 18.1 (1982), pp. 89–98.

- [31] S. A. Nazarov. “Umov-Mandelstam radiation conditions in elastic periodic waveguides”. In: *Sbornik: Mathematics* 205:7 (2014), pp. 953–982. URL: <http://dx.doi.org/10.4213/sm8286>.
- [32] S. A. Nazarov and B. A. Plamenevsky. “Radiation principles for selfadjoint elliptic problems”. In: *Probl. Mat. Fiz.* 13 (1991), pp. 192–244.
- [33] S. Nazarov and B. A. Plamenevsky. *Elliptic problems in domains with piecewise smooth boundaries*. Vol. 13. Walter de Gruyter, 2011.
- [34] V. Pagneux. “Trapped modes and edge resonances in acoustics and elasticity”. In: *Dynamic Localization Phenomena in Elasticity, Acoustics and Electromagnetism*. Springer, 2013, pp. 181–223.
- [35] J. Peetre. “Another approach to elliptic boundary problems”. In: *Communications on pure and applied Mathematics* 14.4 (1961), pp. 711–731.
- [36] M. Reed and B. Simon. *Methods of modern mathematical physics v. I-IV*. New York: Academic Press, 1972-1978.
- [37] F Riesz and Sz- Nagy. *B.(1990). Functional analysis*. Vol. 3. 6. Dover Publications, Inc., New York. First published in, 1955, p. 35.
- [38] A. V. Sobolev and J. Walthoe. “Absolute continuity in periodic waveguides”. In: *Proc. London Math. Soc. (3)* 85.3 (2002), pp. 717–741.