



HAL
open science

Study on Establishing Functional Periodicity of New Products Based on TRIZ

Ya-Fan Dong, Peng Zhang, Run-Hua Tan, Wei Liu, Rui-Qin Wang,
Jian-Guang Sun

► **To cite this version:**

Ya-Fan Dong, Peng Zhang, Run-Hua Tan, Wei Liu, Rui-Qin Wang, et al.. Study on Establishing Functional Periodicity of New Products Based on TRIZ. 18th TRIZ Future Conference (TFC), Oct 2018, Strasbourg, France. pp.113-125, 10.1007/978-3-030-02456-7_10 . hal-02279770

HAL Id: hal-02279770

<https://inria.hal.science/hal-02279770v1>

Submitted on 5 Sep 2019

HAL is a multi-disciplinary open access archive for the deposit and dissemination of scientific research documents, whether they are published or not. The documents may come from teaching and research institutions in France or abroad, or from public or private research centers.

L'archive ouverte pluridisciplinaire **HAL**, est destinée au dépôt et à la diffusion de documents scientifiques de niveau recherche, publiés ou non, émanant des établissements d'enseignement et de recherche français ou étrangers, des laboratoires publics ou privés.



Distributed under a Creative Commons Attribution 4.0 International License

Study on establishing Functional Periodicity of new products based on TRIZ

Ya-Fan DONG^{1,2}, Peng ZHANG^{1,2}, Run-Hua TAN^{1,2}, Wei LIU^{1,2}, Rui-Qin WANG³,
Jian-Guang Sun^{1,2}

¹ National Engineering Research Center for Technological Innovation Method and Tool, Tianjin 300130, China

² Hebei University of Technology, Tianjin 300130, China

³ Tianjin University, Tianjin 057750, China
dyafan@foxmail.com

Abstract. Functional periodicity plays an important role in the process of product automatic innovation for ensuring stable systems. But there is no method of establishing Functional Periodicity. In order to establish the functional periodicity of a new product, an existed product called the goal product is firstly chosen, if it is similar to the new product on aspects of function, effect or structure. Subsequently, difference between the new product and the goal product is identified by establishing the mapping relationship between the functional requirements and design parameters. Using the tools from TRIZ, the function model of the new product is formulated based on the above-mentioned mapping relationship. Afterwards, the system functional periodicity of the new product is proposed in form of TRIZ function model by combining the results of proposed function model and the relationship among functions. Finally, the feasibility of the proposed method is verified with a specific design case.

Keywords: Functional Periodicity, Automatic Innovation, New Products, Function Model, TRIZ.

1 Introduction

The function is the core of the concept design in the process of product automatic innovation, and it is also the foundation of establishing functional periodicity. Suh [1] (2004) put forward the concept of functional periodicity, which is an important way to reduce system complexity. Functional periodicity plays an important role in the process of product automatic innovation for ensuring stable systems. The product function analysis mainly includes the function structure and the function model based on TRIZ [2]. The problems existing in the system can be found out by these two methods. However, they can't help the designers to build the system functional periodicity. The literature [3]- [7] verified that the function model is an important way to solve problems for the innovation. However, most of the studies improved the present products, not a new product. The literature [8] emphasizes that functional periodicity is the foundation for a system operating stability. The literature [9] verified that func-

tional periodicity is the most important way to reduce the system complexity and introduced several functional periodicity determination methods based on TRIZ. However, they did not put forward a method of a new product functional periodicity established.

The traditional function model based on TRIZ is applied to improve the existing system, not to develop a new product, not to establish functional periodicity. In this paper, according to function, effect or structure, a product is found out similar to the new product function, the structure or the effect. Namely, it is regarded as the goal product. Subsequently, difference between the new product and the goal product is identified by establishing the mapping relationship between the functional requirements and design parameters. Using the tools from TRIZ, the function model of the new product is formulated based on the above-mentioned mapping relationship. According to the improved function model and the relationship between each function, the system functional periodicity is determined. The process model of functional periodicity assisted by function model is set up for the new product development.

2 Time independent complexity and functional analysis

2.1 Time independent complexities

The complexity concept in axiomatic design theory is defined as a measure of uncertainty in achieving the desired set of functional requirements [10] (see Fig. 1). The size of the complexity is directly determined by the relationship between the design scope and system range. It may be a constant, and also may be changing over time. There are four different types of complexity, namely, time-dependent combinatorial complexity, time-dependent periodic complexity, time-independent real complexity and time-independent imaginary complexity [10].

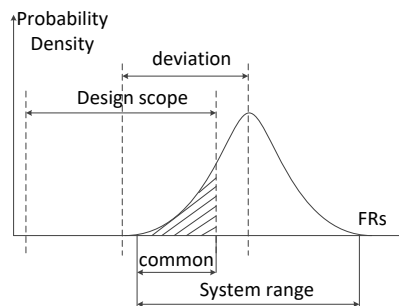

Fig. 1. The schematic diagram of the design scope and system range [10]

Time-independent real complexity is that the system range is not fully in the design scope. Namely, the area of the shaded part is uncertain in Fig. 1. It is real and does not change with time. Because the designer is not fully familiar with the product design,

the system produces the uncertainty. Time-independent imaginary complexity isn't really system complexity.

2.2 Function analysis

The carrier of the function is the product. The manifestation of the product is the function. In the 1940s American engineer Myers [2] put forward the concept of the function at first and put it on the core problems of value engineering research.

The main advantages of the function analysis are as follows: (a) Through the function analysis, unnecessary parts can be found out and be eliminated completely; (b) Through the function analysis, a cheaper alternative material can be found to instead of some parts, and even the total product; (c) Through the function analysis, the original design can be improved; (d) Through the function analysis, some parts which manufacturing tolerance is too high often can be found.

Function analysis is mainly from the total function and then divided into two directions: the function structure and the function model based on TRIZ.

(a) The function structure

The basis of the function structure is regarding product design as the conversion of substance, energy and signal. Starting from the total function to decomposition for each sub-function, the function structure is comprised of system sub-function, as shown in Fig. 2 [2]. The function structure is widely used in new product innovation and design.

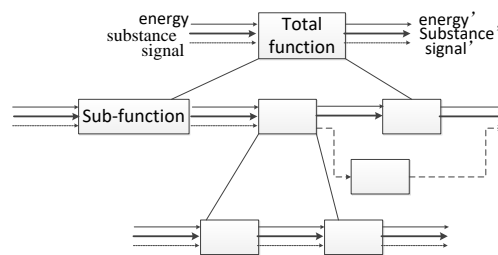

Fig. 2. Product function structure

(b)The function model

According to a total function, the function model is from the total system to sub-systems, until the typical components. Then a verb is used in each element, with the different linear representative of the interaction between components, such as harmful effects or shortage effect. The function model is set up. Function model which includes super systems, systems and products mainly improves the existing product or system. But there isn't a method of function model for a new product or system.

2.3 Functional periodicity

Based on the complexity of the axiomatic design theory, functional periodicity is defined as a set of functional requirements [10]. Function mentioned is a functional periodicity, but it is repeating a set of the same function, not only a time period.

Namely, that has a fixed time period. In Axiomatic Design Complexity Theory, functional periodicity types include time periodicity, geometric periodicity, biological periodicity, chemical periodicity[11-12], thermal cycle, power cycle and material cycle⁸ etc.

Functional periodicity is a kind of characteristic of the natural system and the technical system. This is an essential characteristic of the stable system. It is the premise and foundation of the stable operation of the system 8.

To ensure systems operating stability, it is very important to establish the functional periodicity. Suh [1] shows that functional periodicity is defined as the period set by repeating a set of function requirements. It is very important to establish the functional periodicity of the new product in the process of new product development. But there isn't a method of function model for a new product or system.

3 Determining process model of functional periodicity of a new product

According to the product functional requirements (FRs), the similar products are determined in the market at present; the mapping relationship [14] between the functional requirements (FRs) and design parameters (DPs) is established; then considering the difference between the design and present products, the mapping relationship between the functional requirements and design parameters is established. Based on the mapping relationship, the function model of the goal product is set up using TRIZ tools, such as the trimming [15], substance-field analysis, 76 standard solutions, etc., and a new product function model is gotten; According to the relationship between each function, the functional periodicity of a new product is determined. The concrete steps are as follows:

I. According to user requirements, the target patent is determined. Through the analysis functional domain and the domain of the similar products, the mapping relationship between the functional requirements (FRs) and design parameters (DPs) is established.

According to the product design requirements and market studies, the product to be designed is still blank in currently. The function model of the new product can't be established directly. Therefore, the existing products similar to the designed product are found out. Namely, starting from the function, the effect and the structure, a product similar to the new product function, the structure or the effect is found, namely, it is regarded as the goal product. The function model of the target product is set up. According to similarity principle [16][17], the similarity between the products has different forms, mainly including the following several aspects:

(a) Similar to the new product function: it refers to the similarity between the product or system function.

(b) Similar to the new product working principle: it refers to the similarity between the product or system working principle.

(c) Similar to the new product structure: it refers to the similarity between the product or system structure.

(d) Similar to the new product function and structure: it refers to the similarity between the product or system function and structure.

(e) Similar to the new product function and working principle: it refers to the similarity between the product or system function and working principle.

(f) Similar to the new product function, working principle and structure: it refers to the similarity between the product or system function, working principle and structure.

As long as a product meets the above anyone, it can be regarded as a similar product to the new product. Through the analysis functional domain and the domain of the similar products, the mapping relationship between the functional requirements (FRs) and design parameters (DPs) is established (see Fig. 3 9).

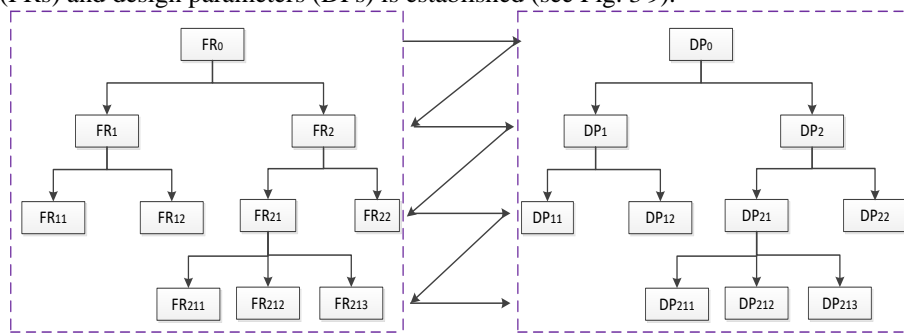

Fig. 3. The mapping relationship between the FRs and DPs [10]

II. Compared to the new product functional requirements and design parameters, the problem parameters are determined in the mapping principle. The mapping principle applied to the new product design requirements between the FR's and DP's is established.

Relative to the original design, the mapping relationship of the similar product is right. However, in order to apply to the design requirements of new products, some of the original design parameters may be changed. Therefore, the system will have some problems, such as a big bulk, complexity, missing some functions and so on. And then, the DPs would change into DP's (see Fig. 4). Compared to the new product functional requirements and design parameters and based on the mapping relationship of the similar product, the mapping principle applied to the new product design requirements between the FR's and DP's is established (see Fig. 4).

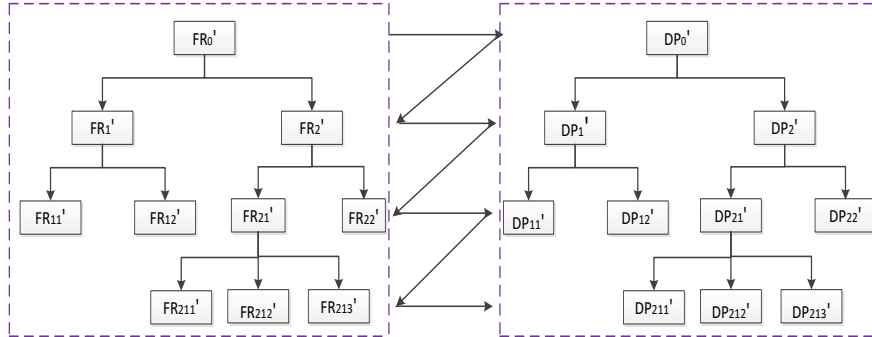

Fig. 4. The mapping relationship between the FR's and DP's

III. According to the mapping relationship between the FR's and DP's, the function model which has some problems is established (see Fig. 5). It is based on the similar product.

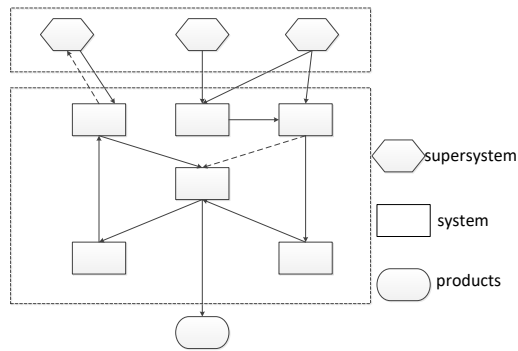

Fig. 5. The function model based on the similar product

IV. Introducing TRIZ tools, the improved function model of the new product is set up.

Analysis of problem function model established, designers introduce TRIZ tools, such as the trimming, substance-field analysis, 76 standard solutions, etc., and get a new product function model.

V. According to each function of the new product and the order of each function under working, the functional periodicity is determined.

According to the improved function model and the work order, the functional periodicity can be determined (see Fig. 6). Therefore, the design requirements and the stability of the system can be ensured.

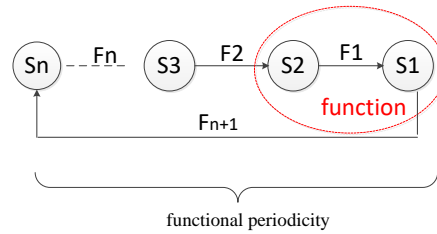

Fig. 6. Functional periodicity determined by function model

4 Case study

Nowadays since the German government put forward the strategy of "Industry 4.0", countries gradually raised a global upsurge of "Internet+", including China. Our country also puts forward "made in China 2025". Under the background of a more and more rapid pace of life today, People prefer to nutrition improvement of a healthy diet. But now most of the people are doing all kinds of porridge according to their own subjective consciousness.

Therefore, the auto-mixed system of porridge needs to develop urgently to substitute manual work. The product should be simple and convenient, meet the gradually rapid pace of the life and work, and satisfy people the different preferences of porridge. What's more, according to the special groups of customers (such as diabetes, etc.) requirements, it can provide the correctly kind of porridge. At the same time, application of "Internet +" concept, it can realize the remote control, and realize the customer to make an appointment. The auto-mixed system of porridge is rare at present. There are more vast development space and a broad market.

I. According to the calculation method of similar products, the ore automatic batching system in the patent CN202656318U [18] is similar to the auto-mixed system of porridge in function. Through the analysis of the similar products, the mapping relationship between the functional requirements (FRs) and design parameters (DPs) of the ore automatic batching system in the patent CN202656318U [18] is established.

Currently existing batching system is composed of storage hopper, weighing hopper, weighing sensor, unloading conveyor belt, devices, etc. such as ore automatic batching system (see Fig. 7 [18]), having a large volume and high precision requirements. At the same time, technology is not very mature and less finished products in the food industry.

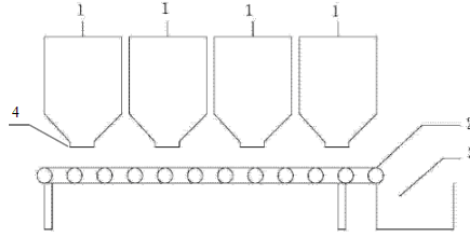

1---Weighing and blanking mechanism; 2--- Burden delivery mechanism;
3--- Material mixing mechanism; 4--- Valve

Fig. 7. The ore automatic batching system schematic diagram

Through the analysis of the similar products, the mapping relationship between the functional requirements (FRs) and design parameters (DPs) of the ore automatic batching system in the patent CN202656318U [18] is established (see Fig. 8).

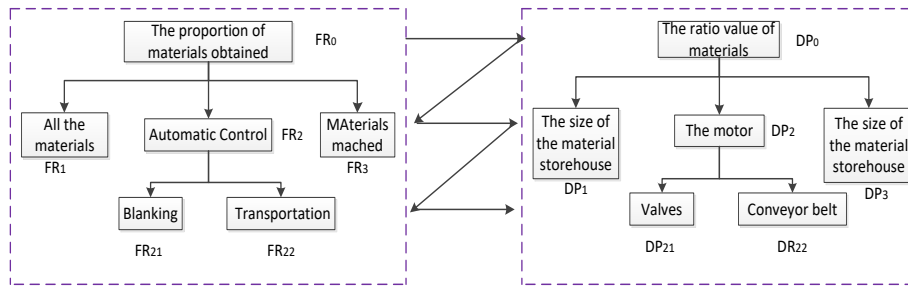

Fig. 8. The mapping relationship of the ore automatic batching system

II. Compared to the new product function requirements and the mapping principle of the ore automatic batching system, the control systems are complex and the size of device is too large. Therefore, the DPs of controls are changed into DP's. The mapping principle applied to the auto-mixed system of porridge design requirements is established (see Fig. 9).

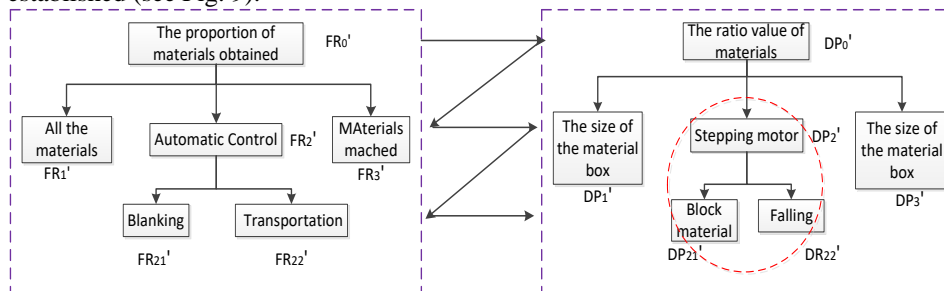

Fig. 9. The mapping relationship of the auto-mixed system of porridge

III. According to the mapping relationship of the auto-mixed system of porridge, the function model is established. It is based on the ore automatic batching system.

Through the analysis of system function model (see Fig. 10), a Material Storehouse needs a set of control systems, namely two Material Storehouses need two sets of control systems, so the equipment is complex, big volume and complicated operation.

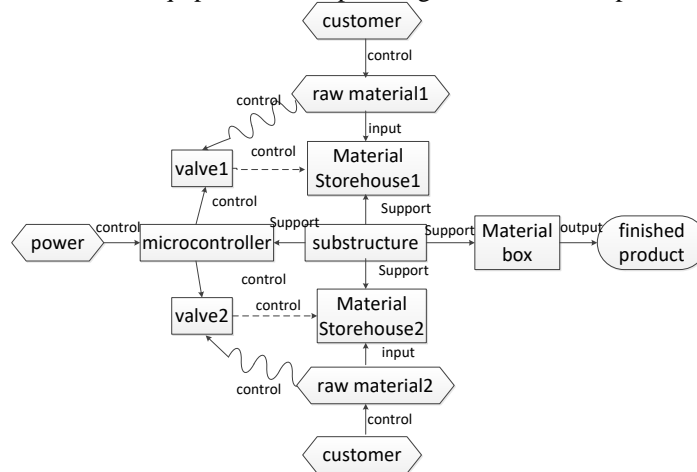

Fig. 10. The function model (two Material Storehouses)

IV. Introducing TRIZ tools, such as the trimming, substance-field analysis, 76 standard solutions, etc., the improved function model of the new product is set up.

The valve 1 is similar to the valve 2 and so on (see Fig. 10). Therefore, considering the principle of trimming, the control valves are regarded as trimming objects [19][20] (see Fig. 11).

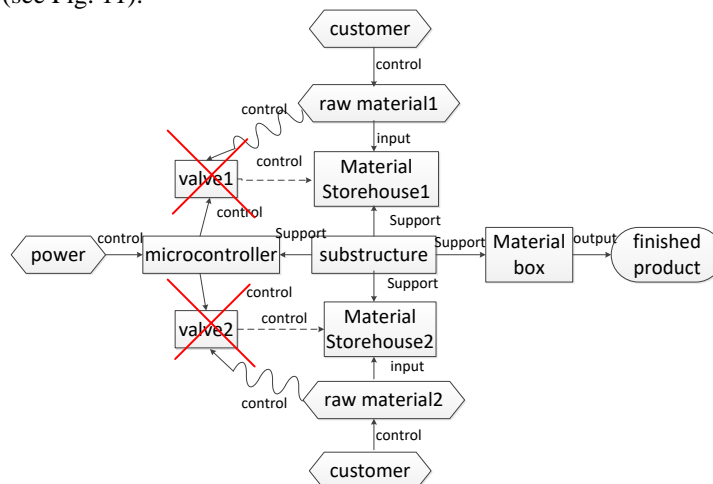

Fig. 11. The trimming function model

A clutch is referenced. Therefore, a set of control systems is applied to complete control of multiple storage bins. The function model of the new product system is shown in Fig. 12.

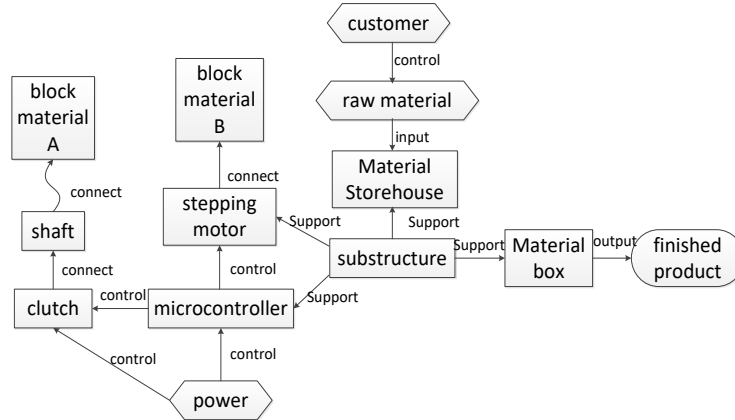
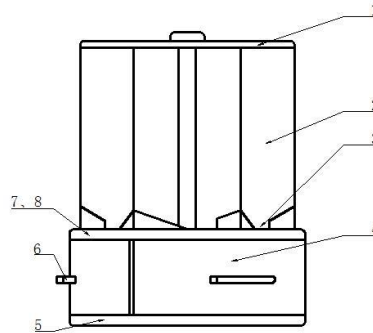

Fig. 12. The function model of new product system

Using substance-field analysis and 76 standard solutions, a convex flange is introduced, with the shaft directly, and then meets the block material A to eliminate the harmful effect. At the same time, it can strengthen the block material A rotational stability. The overall effect is as shown in Fig. 13.



1-top head; 2-material storehouse; 3-asymmetric feed opening; 4-Material box;
5-substructure; 6- Material box handle; 7-block material A; 8-block material B

Fig. 13. The schematic diagram of the overall effect

V. According to the relationship between each function, the new product functional periodicity is determined.

In working condition, the stepping motor and the clutch are electrified at the same time. Block material A and B rotate simultaneously. When they arrive at the asymmetric feed opening of the material storehouse, electromagnetic clutch with power off, block material A stops rotating and block material B continues. When the aperture of block material A is obscured completely, the stepping motor stops running.

Now blanking, materials are directly into the material box. When the expected regulation is achieved, stepping motor controls block material B inversion until keeping out the blanking round hole of block material A. At this point, the first time the material is completed. As repeating operation, the automatic batching of porridge is completed (see Fig. 14).

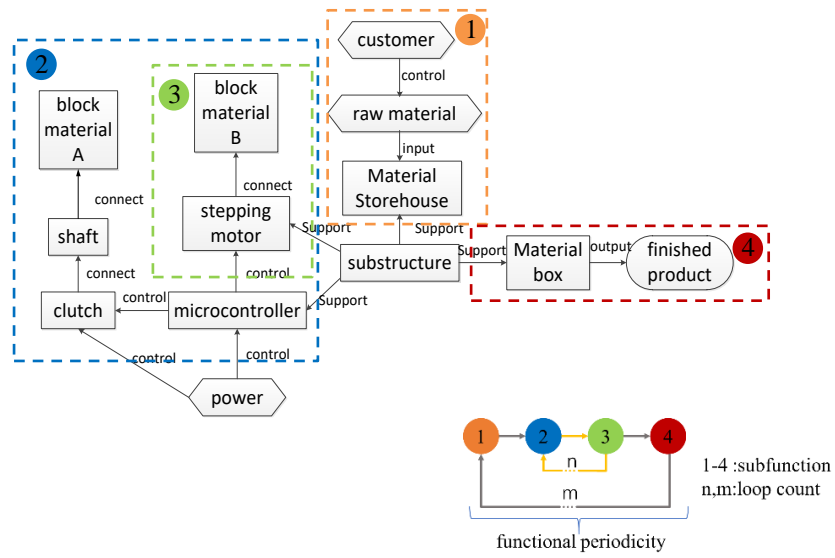

Fig. 14. The diagram of functional periodicity of the auto-mixed system of porridge

Therefore, according to the order of each function under working, functional periodicity is determined (see Fig. 14). The cylindrical structure of the new product can be designed according to the function model shown as Fig. 14. A new product is innovated. The prototype model is shown as Fig. 15.

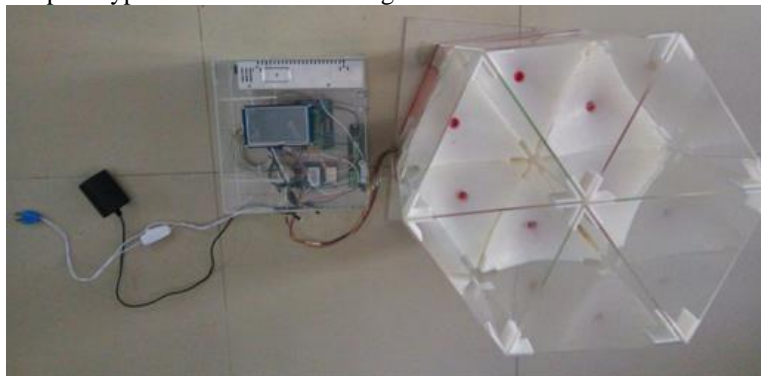

Fig. 15. Prototype model

5 Conclusions

Based on TRIZ, the process model of functional periodicity for the new product is established. There are two major innovations as follows:

(1) The traditional function model based on TRIZ is applied to improve the present product, not a new product. This paper puts forward a new direction for a new product design.

(2) Functional periodicity is determined based on conflict and others except the function model. This paper puts forward the calculation method of similar products and verifies the process of a functional periodicity based on function model.

The paper describes the meaning of the function structure and function model based on TRIZ. Starting from function, effect or structure, the similar product is found. At the same time, according to the mapping principle between the FRs and DPs and the function model, it puts forward the method of a functional periodicity of the new product. The validity of the method is proved by "the auto-mixed system of porridge ". It provides a new direction and lays a foundation for the new product design and innovation.

Acknowledgement Supported by National Natural Science Foundation of China (Grant No. 51675159), National Natural Science Foundation of China (Grant No. 51305123), and the National Science and Technology Basic Project (Grant No.2017IM040100).

References

1. N P Suh: On functional periodicity as the basis for long-term stability of engineered and natural systems and its relationship to physical laws. *Research in Engineering Design* 15(1): 72-75(2004).
2. R H Tan: *Innovation design-TRIZ: Theory of innovation problem solving*. China Machine Press, Beijing (2002).
3. G S Altshuller: *Creativity as an exact science: The Theory of the Solution of Inventive Problems*. Gordon & Breach Science Publishing, New York (1984).
4. G Cao, H Guo, C Zhang, et al.: Function evolution and forecasting for product innovation. In: *Management of Innovation and Technology (ICMIT), 2010 IEEE International Conference on*. IEEE, pp. 40-44. Singapore (2010).
5. M Orloff: Inventive thinking through TRIZ: A practical guide. *TQM Magazine* 18(3):312-314 (2006).
6. R H Tan, C Y Yuan, G Z Cao, et al.: Function model for products existed using reverse fishbone. *Journal of Engineering Design* 04 (2003).
7. X M Lu, F Y Zhang, Q Q Zhang: Product innovation design based on the theory of TRIZ and functional analysis. *Mechanical Design Manufacturing* 12: 255-257 (2010).
8. T Lee, Tae-Sik: *Complexity theory in axiomatic design*. Massachusetts Institute of Technology, Massachusetts (2003).
9. P Zhang, R H Tan: Design model for the combinatorial complexity elimination process. *Transactions of the Chinese Society of Agricultural Machinery* 41(3): 182-188 (2010).

10. N P Suh: Complexity: theory and applications. Oxford University Press on Demand, England (2005).
11. A Prokoph, H E Bilali, R Ernst: Periodicities in the emplacement of large igneous provinces through the Phanerozoic: Relations to ocean chemistry and marine biodiversity evolution. *Geoscience Frontiers* 4(3):263-276 (2013).
12. P Zhang, R H Tan: Rapid acquirement method for ideal result of system complexity. *Computer Integrated Manufacturing Systems* 16(4): 746-754 (2010).
13. N P Suh: Complexity in engineering. *CIRP Annals-Manufacturing Technology* 54(2): 46-63 (2005).
14. D T Matt: Achieving operational excellence through systematic complexity reduction in manufacturing system design. *Key Engineering Materials* 344: 865-872 (2007).
15. F Yu, R H Tan, G Z Cao, et al.: Study on trimming priority based on system functional model study. *Computer Integrated Manufacturing Systems* 19(2): 338-347 (2013).
16. H S Gitlow: Innovation on demand. *Quality Engineering* 11(1): 79-89 (1998).
17. G N Qi, X J Gu, Q H Yang, et al.: Principles and Key Technologies of Mass Customization. *Computer Integrated Manufacturing Systems* 9(9): 776-783 (2003).
18. Yunnan Chengjiang tiger Chemical Co. Ltd. ore automatic batching system. CN202656318U, China (2013).
19. P F Bariani, G A Berti, G Lucchetta: A combined DFMA and TRIZ approach to the simplification of product structure. *Proceedings of the Institution of Mechanical Engineers, Part B: Journal of Engineering Manufacture* 218(8): 1023-1027 (2004).
20. B Wang, G Xu, Q Song, et al.: Design of multi-function blade clean-polishing machine based on TRIZ theory. *Strategic Technology (IFOST)*. In: 6th International Forum on. IEEE, pp. 361-365. (2011).