



**HAL**  
open science

# Anticipation in the retina and the primary visual cortex: towards an integrated retino-cortical model for motion processing

Selma Souihel, Bruno Cessac, Matteo Di Volo, Alain Destexhe, Frederic Chavane, Sandrine Chemla, Olivier Marre

## ► To cite this version:

Selma Souihel, Bruno Cessac, Matteo Di Volo, Alain Destexhe, Frederic Chavane, et al.. Anticipation in the retina and the primary visual cortex: towards an integrated retino-cortical model for motion processing. NeuroMod 2019 - First meeting of the NeuroMod Institute, Jul 2019, Fréjus, France. hal-02172016

**HAL Id: hal-02172016**

**<https://inria.hal.science/hal-02172016v1>**

Submitted on 3 Jul 2019

**HAL** is a multi-disciplinary open access archive for the deposit and dissemination of scientific research documents, whether they are published or not. The documents may come from teaching and research institutions in France or abroad, or from public or private research centers.

L'archive ouverte pluridisciplinaire **HAL**, est destinée au dépôt et à la diffusion de documents scientifiques de niveau recherche, publiés ou non, émanant des établissements d'enseignement et de recherche français ou étrangers, des laboratoires publics ou privés.



# Anticipation in the retina and the primary visual cortex : towards an integrated retino-cortical model for motion processing

PhD student : Selma Souihel  
Adviser : Dr Bruno Cessac  
Team : Biovision



In collaboration with :

Matteo Di Volo  
Alain Destexhe



Frédéric Chavane  
Sandrine Chemla



Olivier Marre



# The visual flow

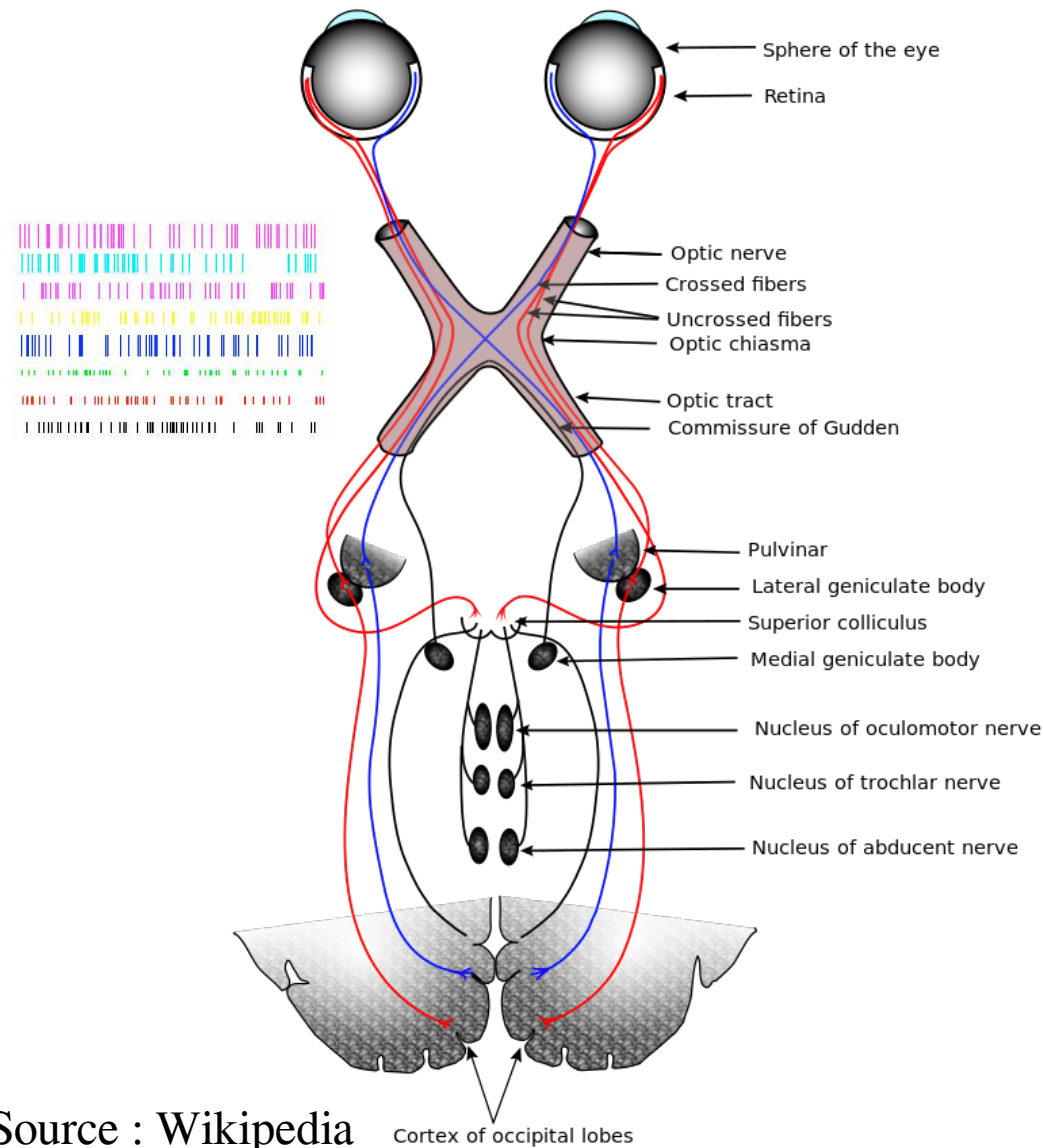

# The visual flow

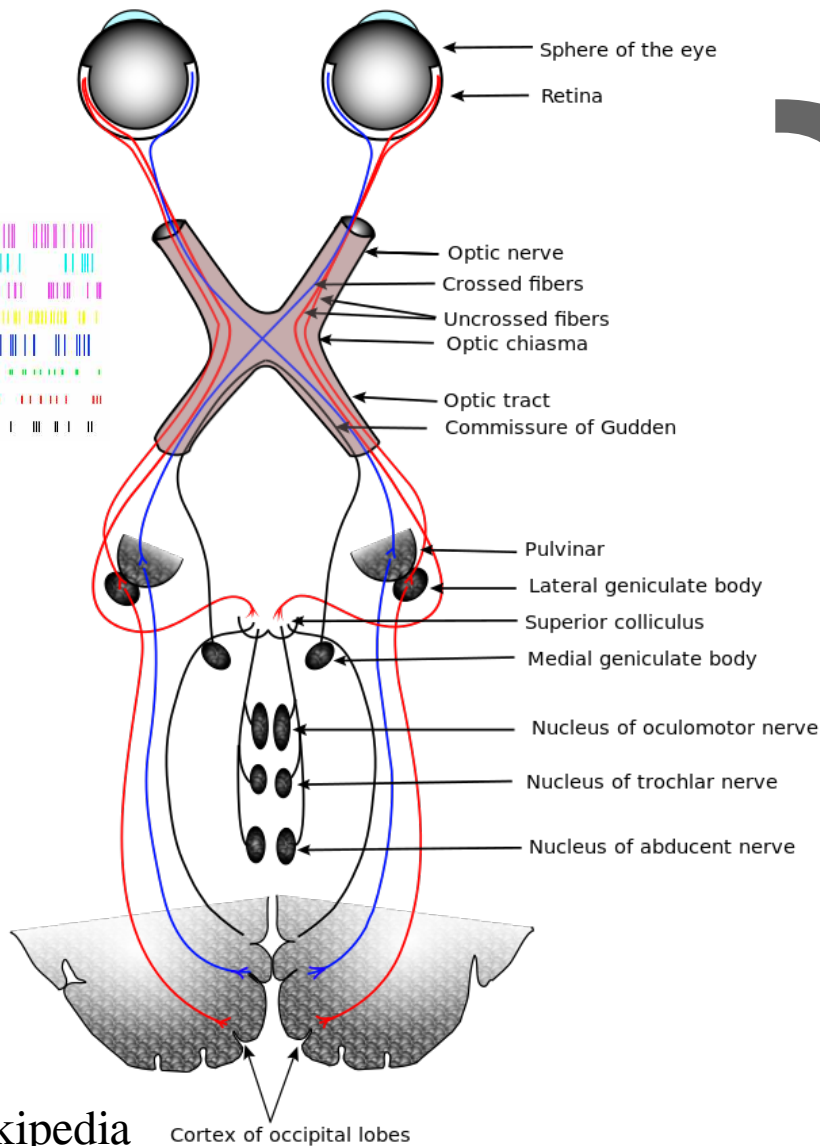

Source : Wikipedia

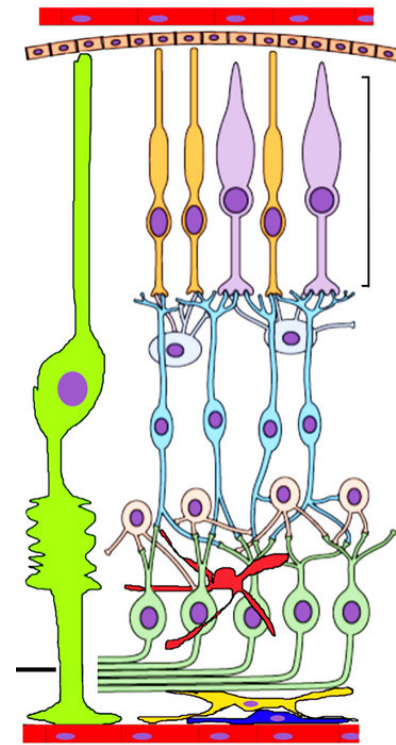
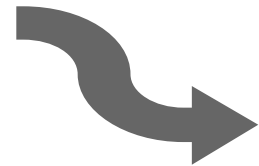

Source : Ryskamp et al. 2014

photoreceptors

bipolar cells

amacrine cells

ganglion cells

Upcoming light



# Stating the problem : Visual Anticipation

**Anticipation** is carried out by the primary visual cortex (V1) through an activation wave

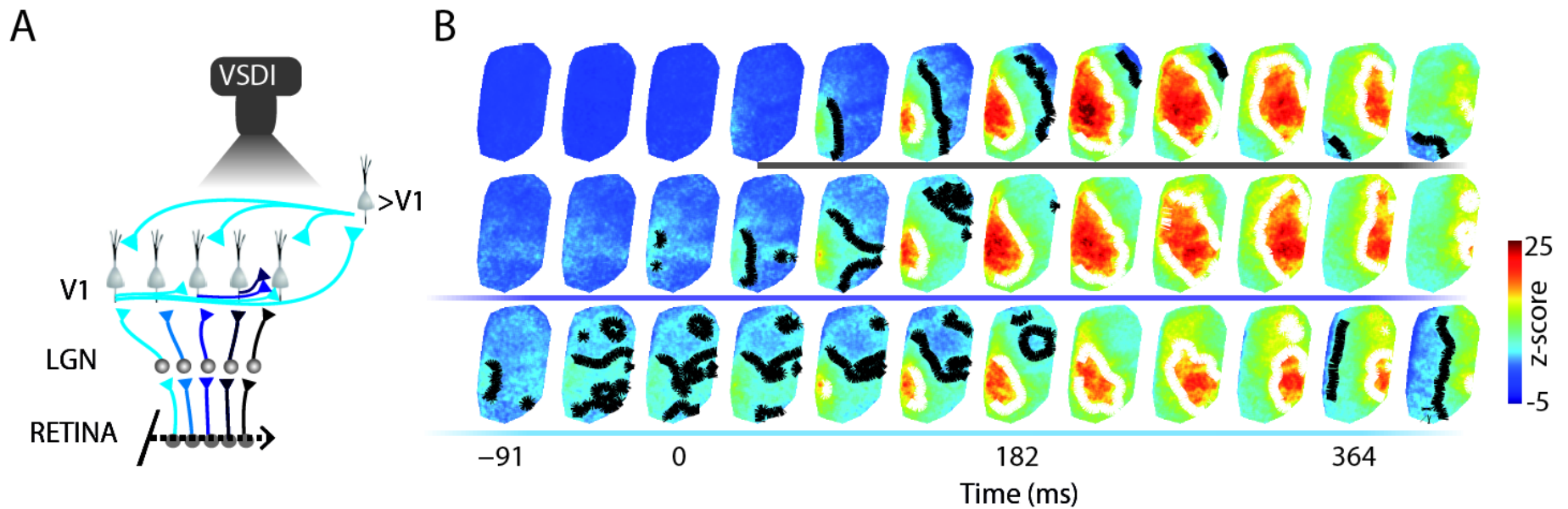

Source :  
Benvenuti et  
al. 2015

# Stating the problem : Visual Anticipation

But the retina is not a mere transmitter, it is able to perform many computations such as :

- Orientation sensitivity
- Contrast gain control
- Sensitivity to differential motion
- .... and « **Motion Anticipation** »

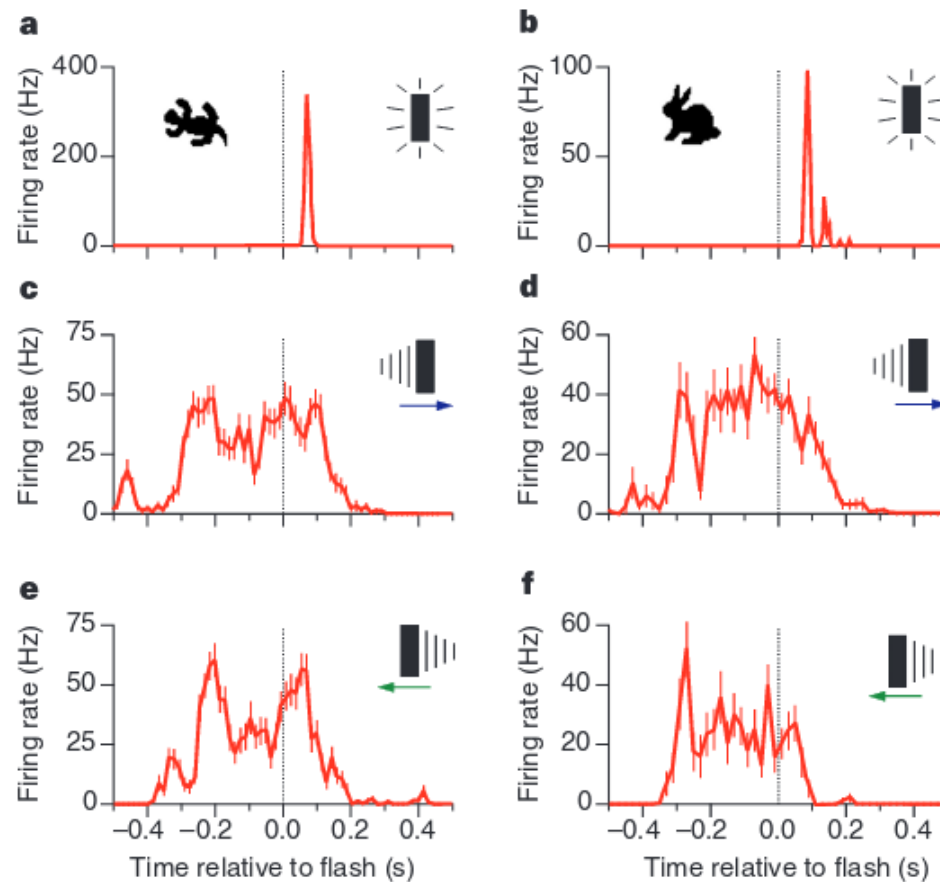

Source : Berry et al. 1999

# Stating the problem : Visual Anticipation

- **What are the respective :**
- **Mechanisms underlying retinal and cortical anticipation?**
- **Role of each part ?**



# I ) Anticipation in the retina

# The Hubel-Wiesel view of vision

Nobel prize 1981

Ganglion cells response is the convolution of the stimulus with a spatio-temporal receptive field followed by a non linearity

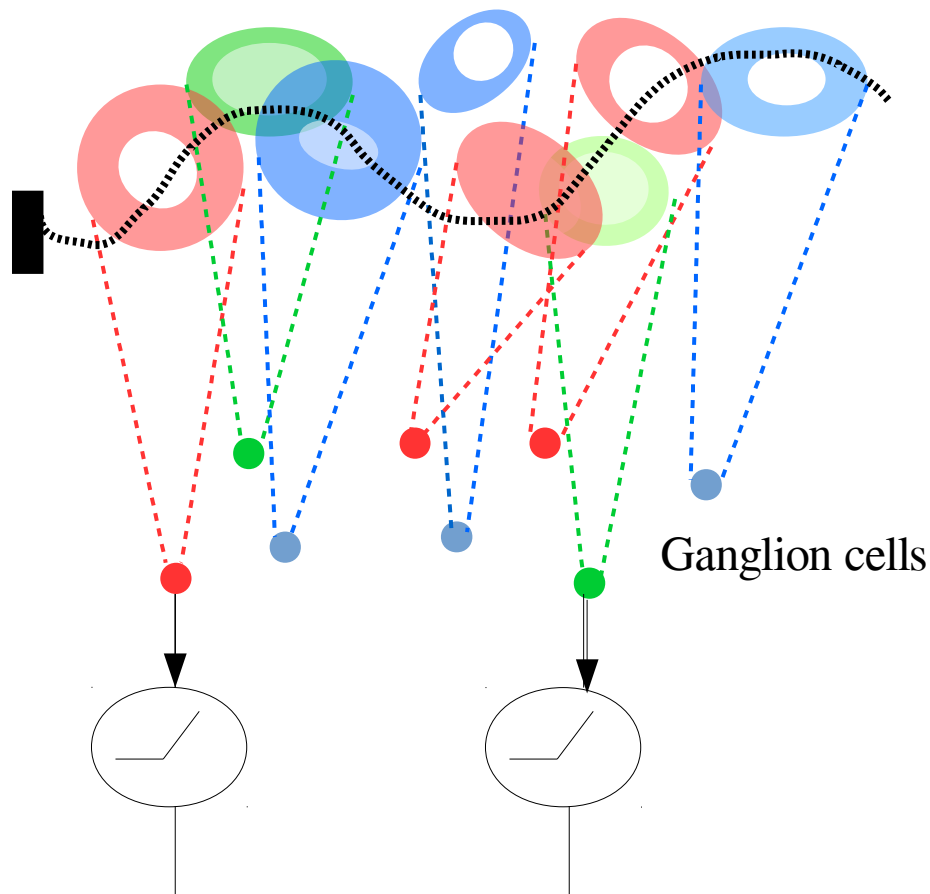

Ganglion cells are independent encoders

# The Hubel-Wiesel view of vision

Nobel prize 1981

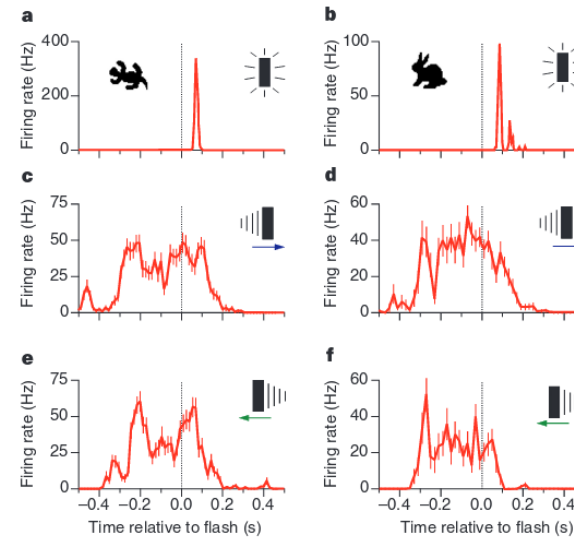
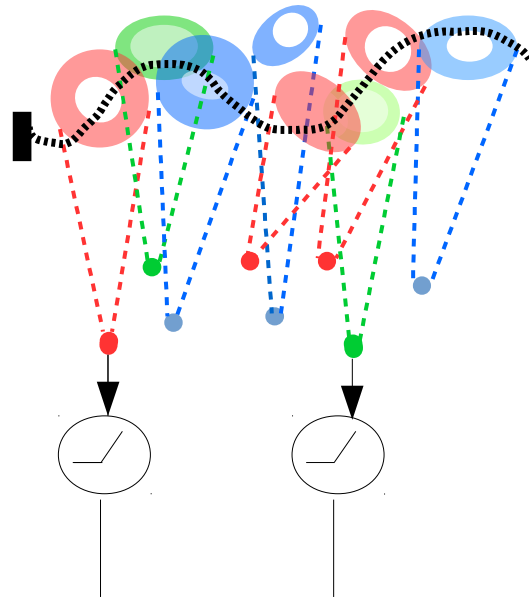

Source : Berry et al. 1999

➤ Which mechanism can account for motion anticipation in the retina ?

# Building a 2D retina model for motion anticipation

## 1) Gain control (Chen et al. 2013)

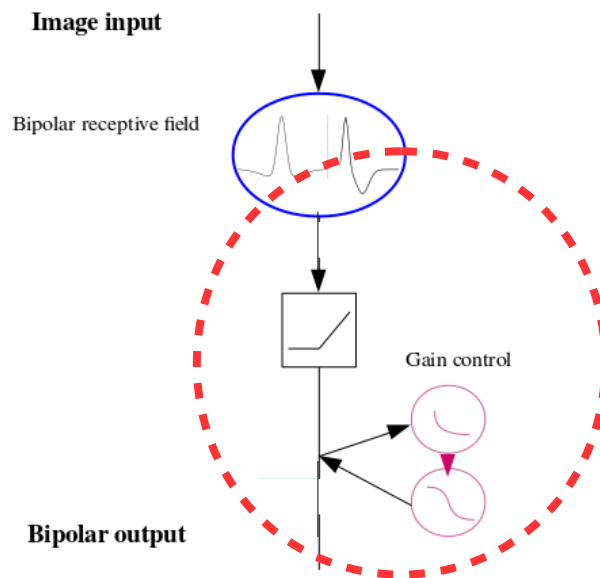

- Bipolar voltage :

$$\left[ K_i \overset{S,t}{*} S \right] (t) = \int_{-\infty}^t K_T(t-u) \left[ \int_{\mathbb{R}^2} K_{i,S}(x,y) S(x,y,u) dx dy \right] du$$

- Non-linear function :

$$\mathcal{N}_B(V_{B_i}) = \begin{cases} 0, & \text{if } V_{B_i} \leq \theta_B; \\ V_{B_i} - \theta_B, & \text{else.} \end{cases}$$

- Activation function :

$$\frac{dA_{B_i}}{dt} = -\frac{A_{B_i}}{\tau_a} + h \mathcal{N}(V_{B_i}(t)).$$

- Gain Control function :

$$\mathcal{G}_B(A) = \begin{cases} 0, & \text{if } A \leq 0; \\ \frac{1}{1+A^6}, & \text{else.} \end{cases}$$

- Output :

$$R_{B_i} = \mathcal{N}_B(V_{B_i}) \mathcal{G}_B(A_{B_i}).$$

# Building a 2D retina model for motion anticipation

## 1) Gain control (Chen et al. 2013)

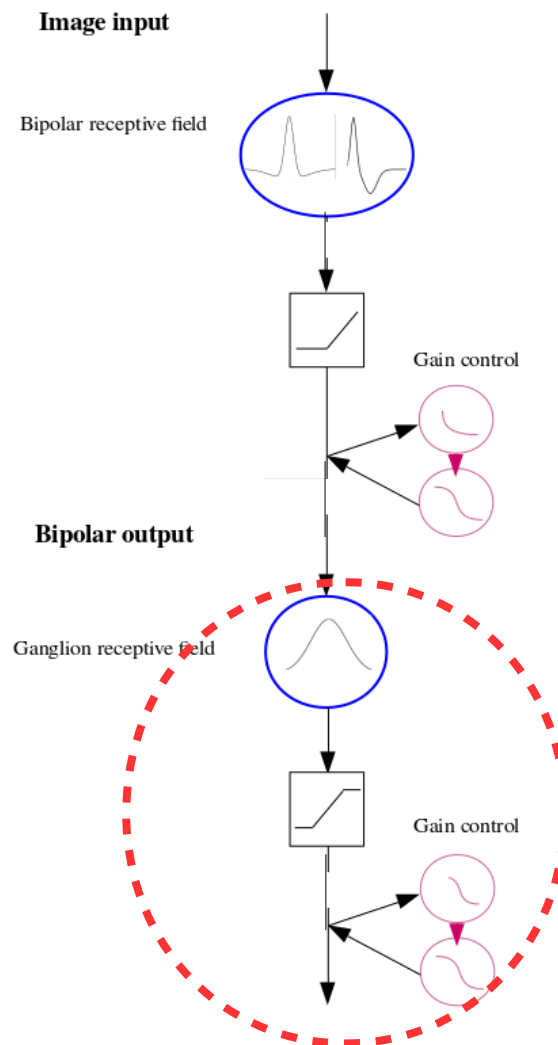
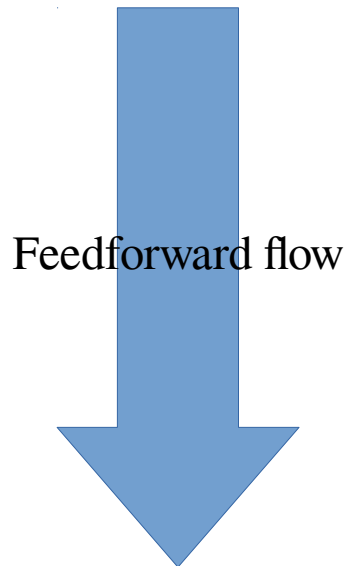

- Ganglion voltage

$$V_{G_k} = \sum_i W_{G_k}^{B_i} R_{B_i}$$

- Non-linear function :

$$\mathcal{N}_{G_F}(V) = \begin{cases} 0, & \text{if } V \leq 0; \\ \alpha_{G_F}(V - \theta_{G_F}), & \text{if } \theta_{G_F} \leq V \leq N_{G_F}^{max}/\alpha_{G_F} + \theta_{G_F} \\ N_{G_F}^{max}, & \text{else.} \end{cases}$$

- Activation function :

$$\frac{dA_{G_F k_F}}{dt} = -\frac{A_{G_F k_F}}{\tau_{G_F}} + h_{G_F} \mathcal{N}_{G_F}(V_{G_F k_F})$$

- Gain Control function :

$$\mathcal{G}_{G_F}(A) = \begin{cases} 0, & \text{if } A \leq 0; \\ \frac{1}{1+A}, & \text{else.} \end{cases}$$

- Output :

$$R_{G_F k_F}(V_{G_F k_F}, A_{G_F k_F}) = \mathcal{N}_{G_F}(V_{G_F k_F}) \mathcal{G}_{G_F}(A_{G_F k_F}).$$

# 1D results : smooth motion anticipation with gain control

Bipolar layer

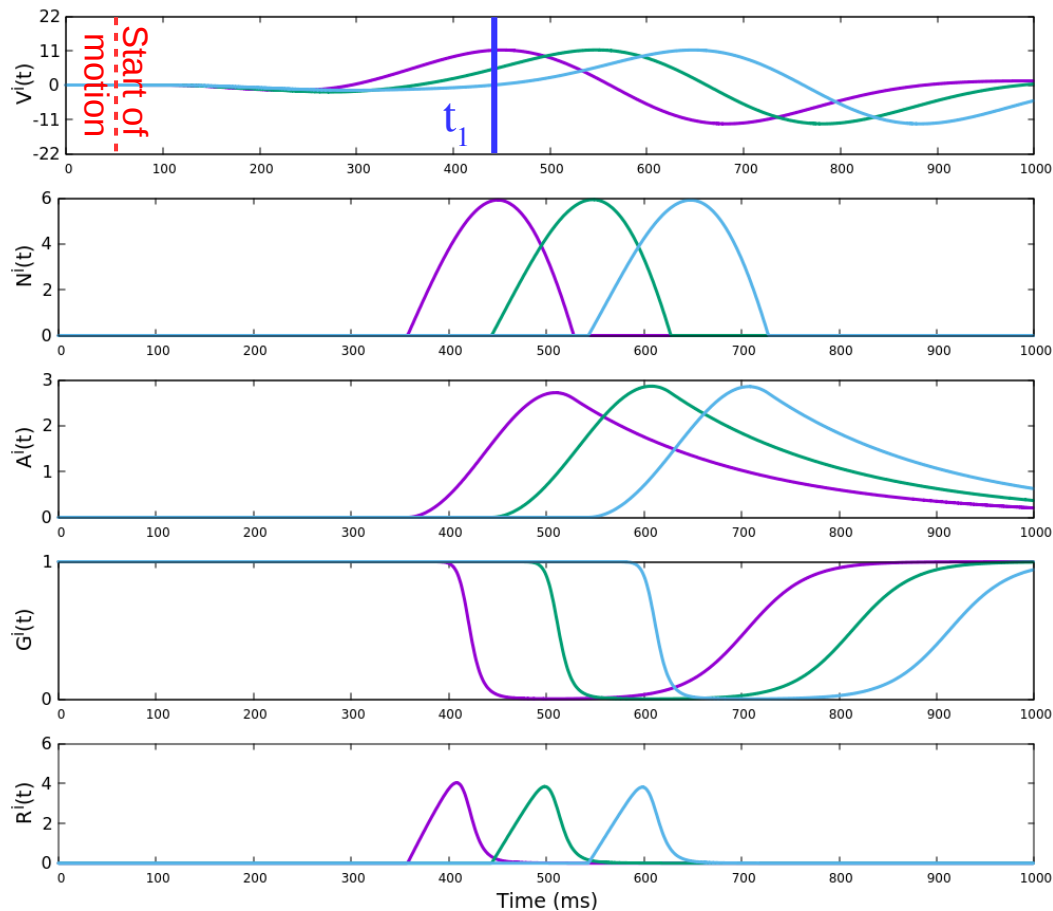

Ganglion layer

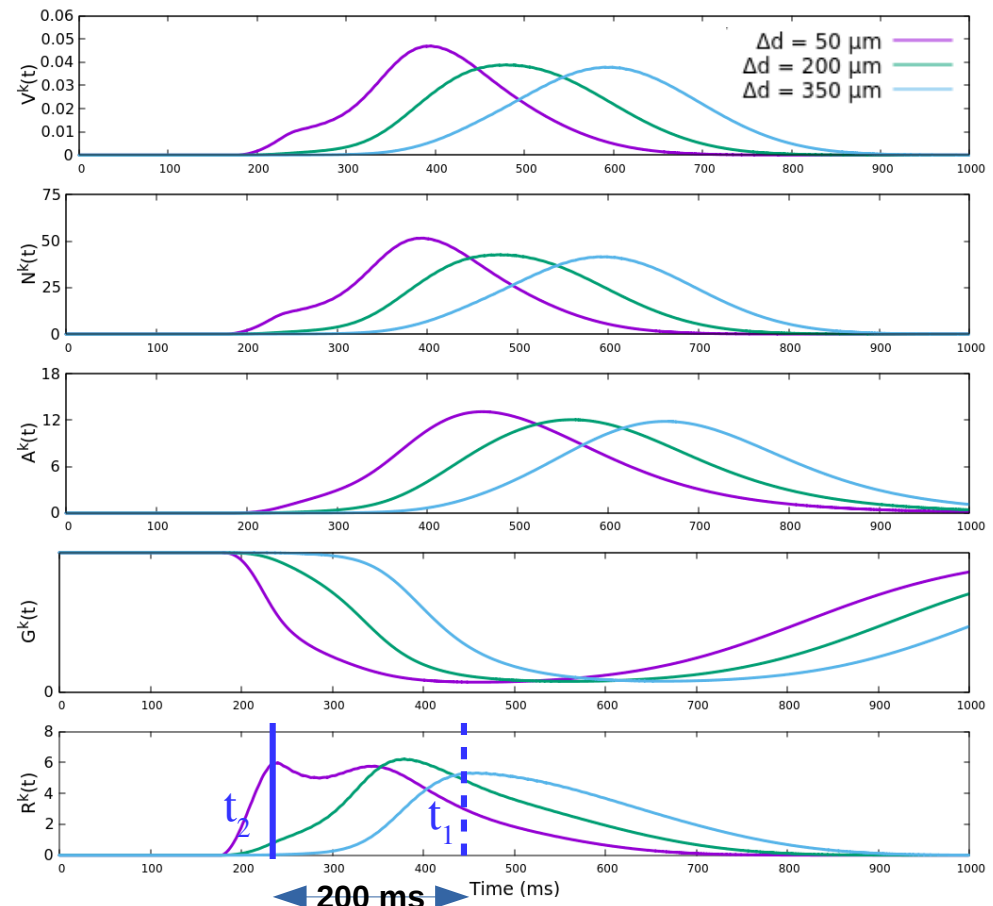

$$\text{Anticipation time} = |t_1 - t_2|$$

# 1D results : smooth motion anticipation with gain control

Anticipation variability with stimulus parameters

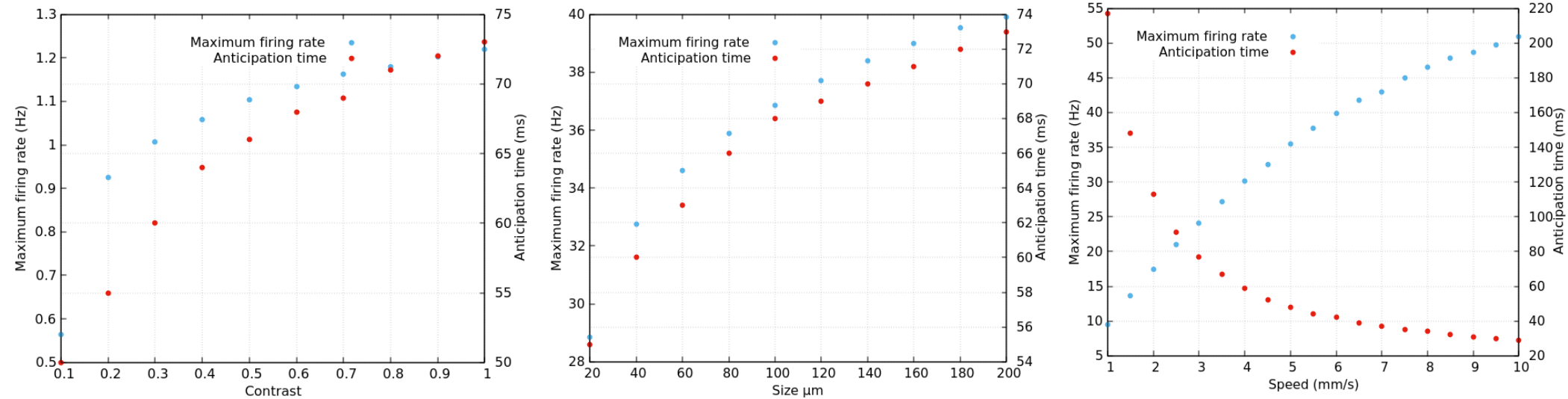

# Building a 2D retina model for motion anticipation

## 2) Gap junction connectivity

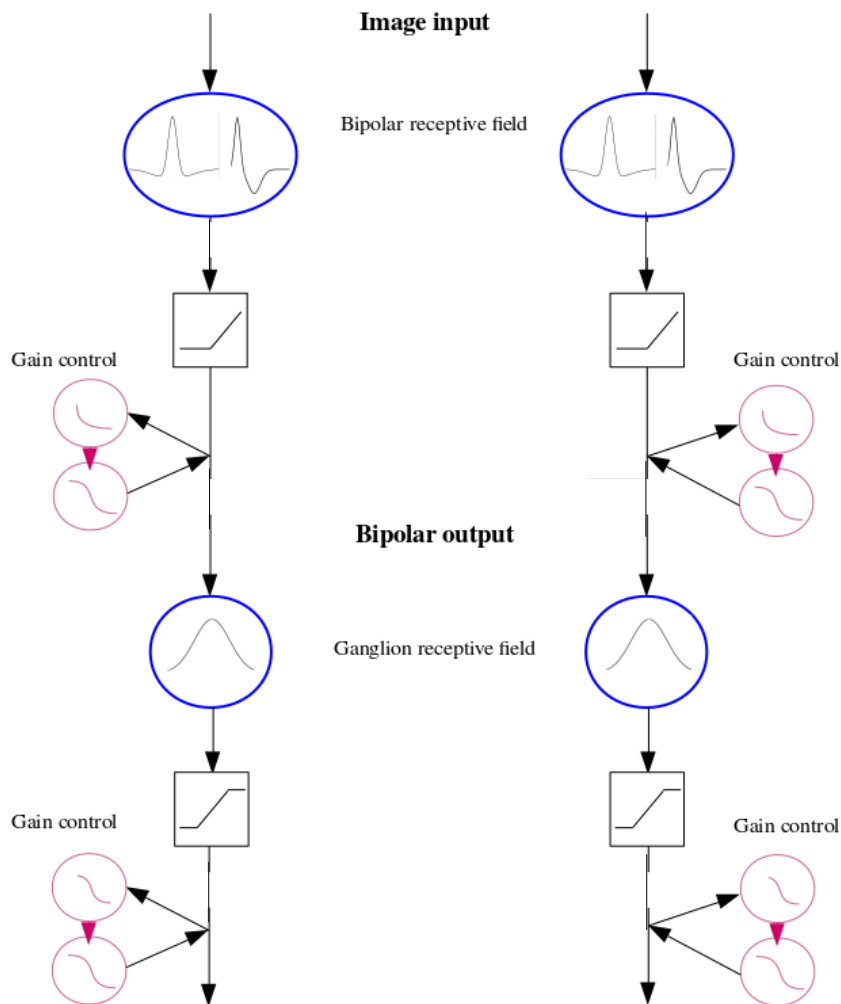

Ganglion cells are independent encoders



# Building a 2D retina model for motion anticipation

## 2) Gap junction connectivity

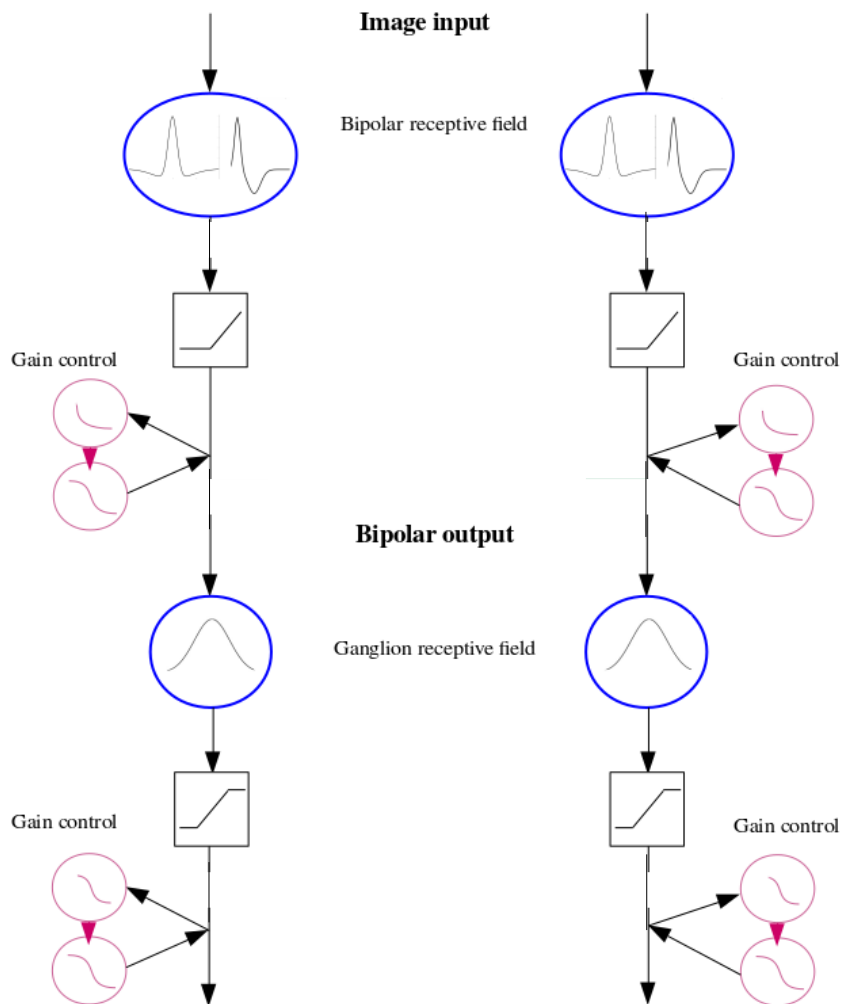

~~Ganglion cells are independent encoders~~

# Building a 2D retina model for motion anticipation

## 2) Gap junction connectivity

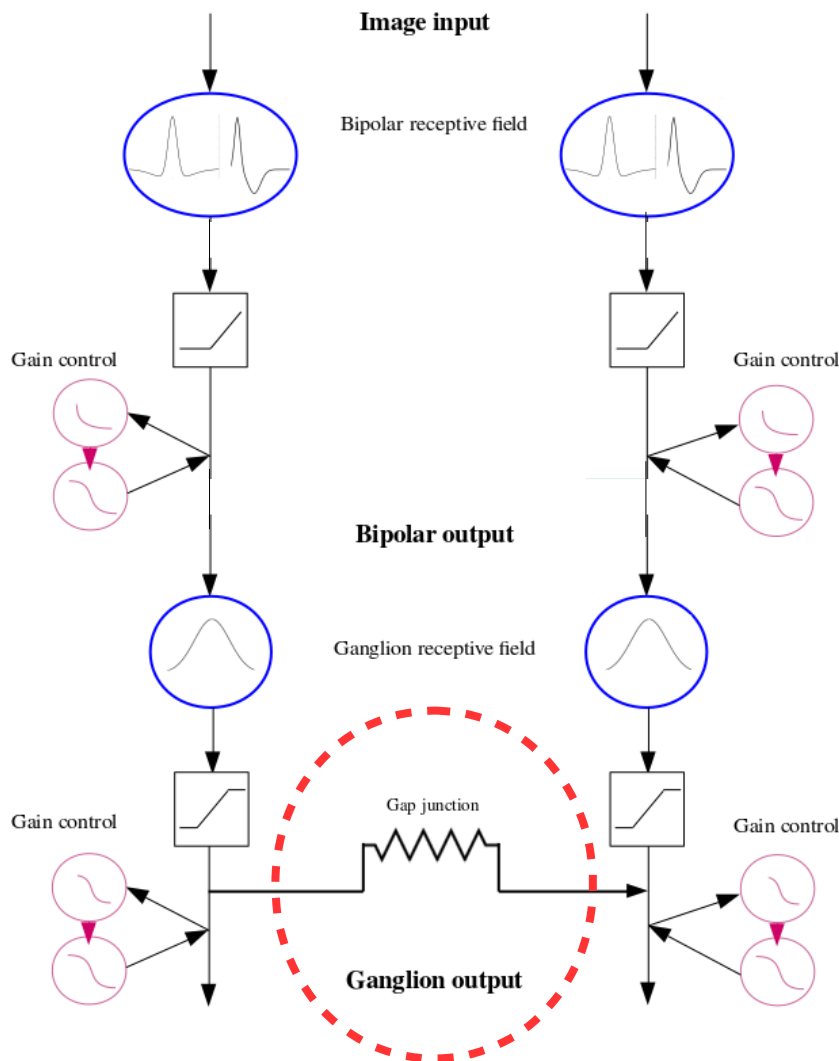

- A class of direction selective RGCs are connected through gap junctions
- Their activity comprises the activity pooled from bipolar cells and the activity coming from the downstream RGCs, in the direction of motion

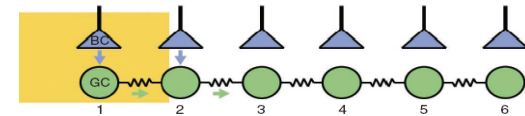

$$R_{GDkD} = V_{GDkD} + \beta R_{GDkD-1}$$

Trenholm & al. 2013

# 1D results : smooth motion anticipation with gap junctions

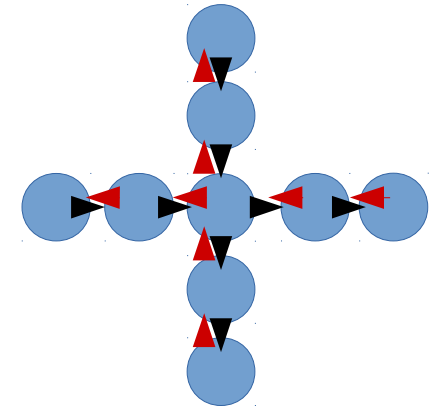
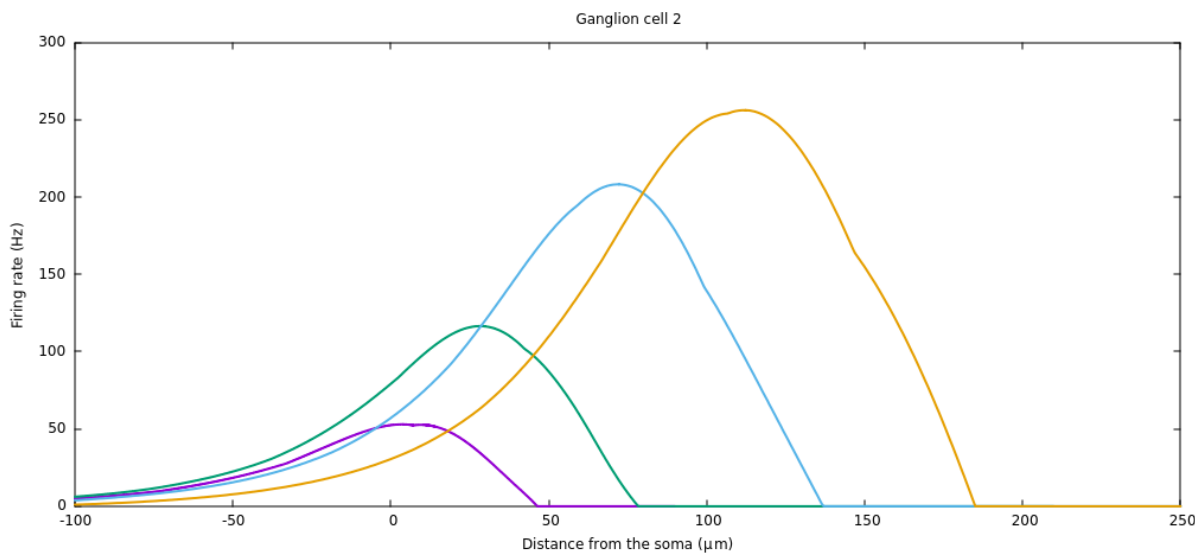

DSGCs in cardinal directions

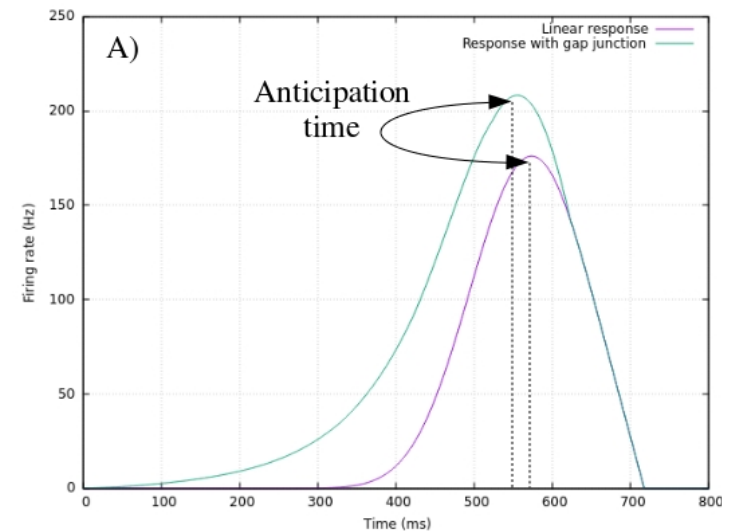

# 1D results : smooth motion anticipation with gap junctions

Anticipation variability with stimulus parameters

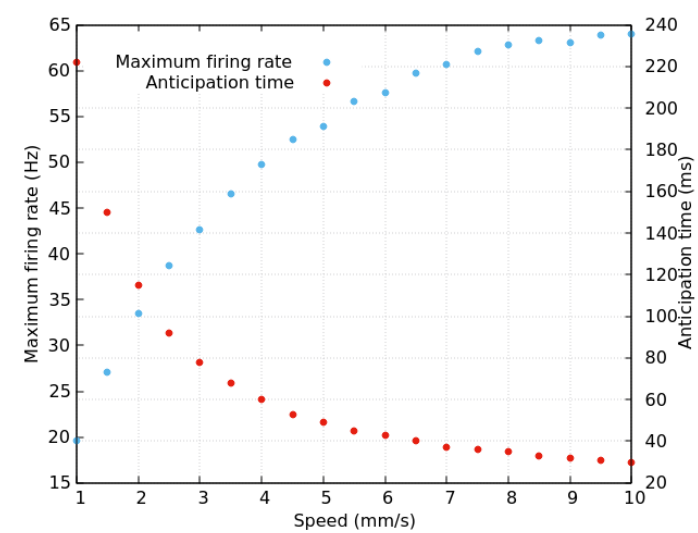
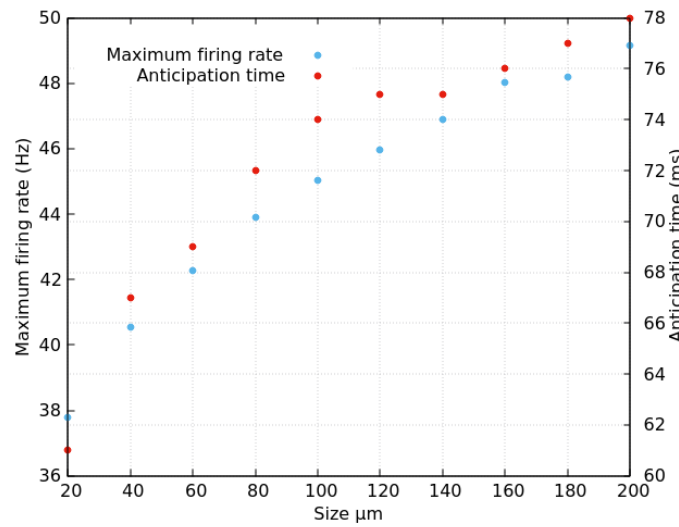
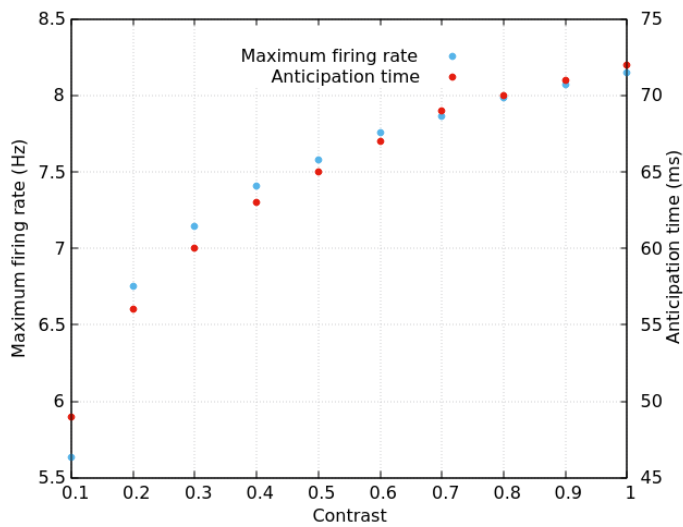

# Building a 2D retina model for motion anticipation

## 3) Amacrine cells connectivity

- A class of RGCs are selective to differential motion

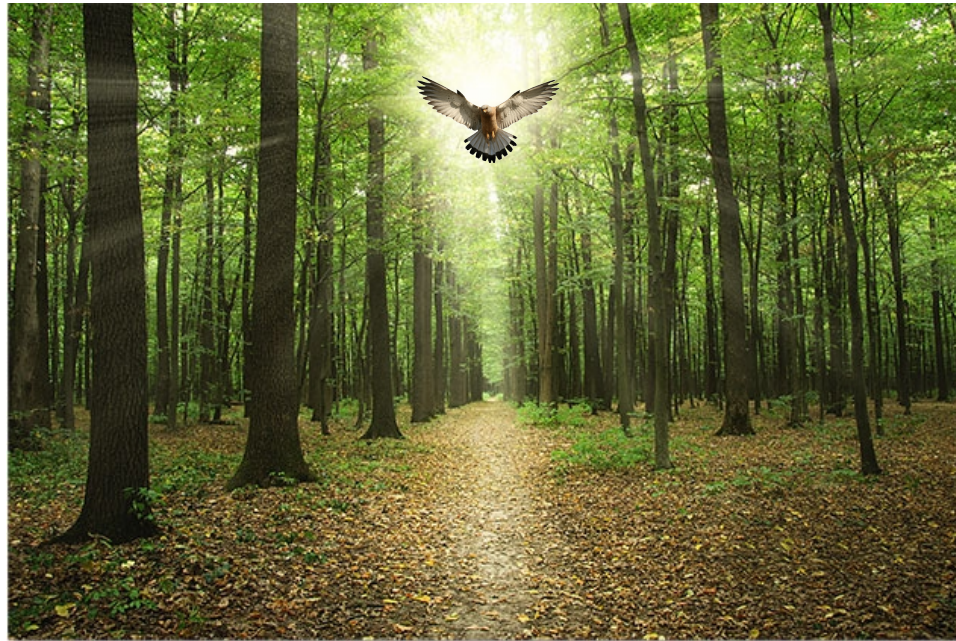

# Building a 2D retina model for motion anticipation

## 3) Amacrine cells connectivity

- A class of RGCs are selective to differential motion



- The circuitry involves amacrine cells connectivity upstream of ganglion cells

# Connectivity pathways

## 2) Amacrine cells connectivity

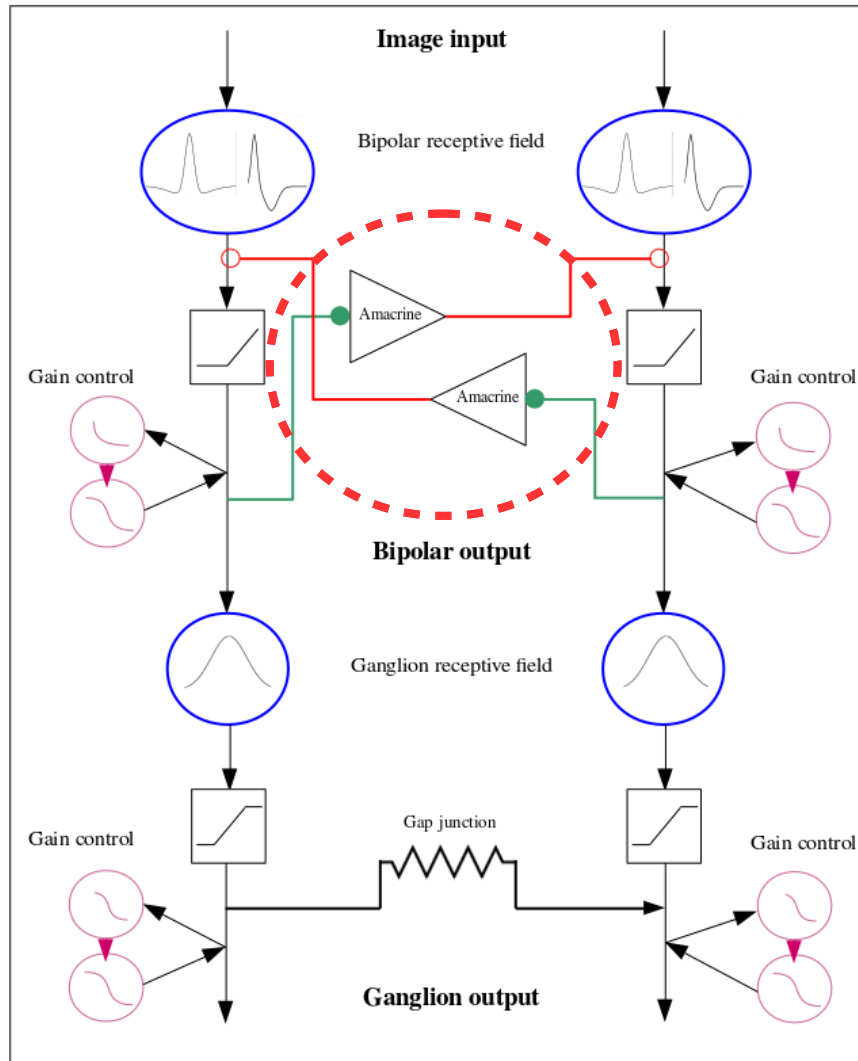

- Bipolar voltage :

$$\frac{dV_{B_i}}{dt} = -\frac{1}{\tau_B} V_{B_i} + \sum_{j=1}^{N_A} W_{B_i}^{A_j} V_{A_j} + F_{B_i}(t).$$

- External drive :

$$F_{B_i}(t) = \left[ K_i \overset{S,t}{*} \left( \frac{\mathcal{S}}{\tau_B} + \frac{d\mathcal{S}}{dt} \right) \right] (t)$$

- Amacrine voltage :

$$\frac{dV_{A_j}}{dt} = -\frac{1}{\tau_A} V_{A_j}(t) + \sum_{i=1}^{N_A} W_{A_j}^{B_i} R_{B_i}(t).$$

- Coupled dynamics :

$$\left\{ \begin{array}{l} \frac{dV_{B_i}}{dt} = -\frac{1}{\tau_B} V_{B_i} + \sum_{j=1}^{N_A} W_{B_i}^{A_j} V_{A_j} + F_{B_i}(t) \\ \frac{dA_{B_i}}{dt} = -\frac{A_{B_i}}{\tau_a} + h \mathcal{N}(V_{B_i}(t)), \\ \frac{dV_{A_j}}{dt} = -\frac{1}{\tau_A} V_{A_j}(t) + \sum_{i=1}^{N_A} W_{A_j}^{B_i} R_{B_i}(t). \end{array} \right. \quad 22$$

# 1D results : smooth motion anticipation with amacrine connectivity

Bipolar layer

Ganglion layer

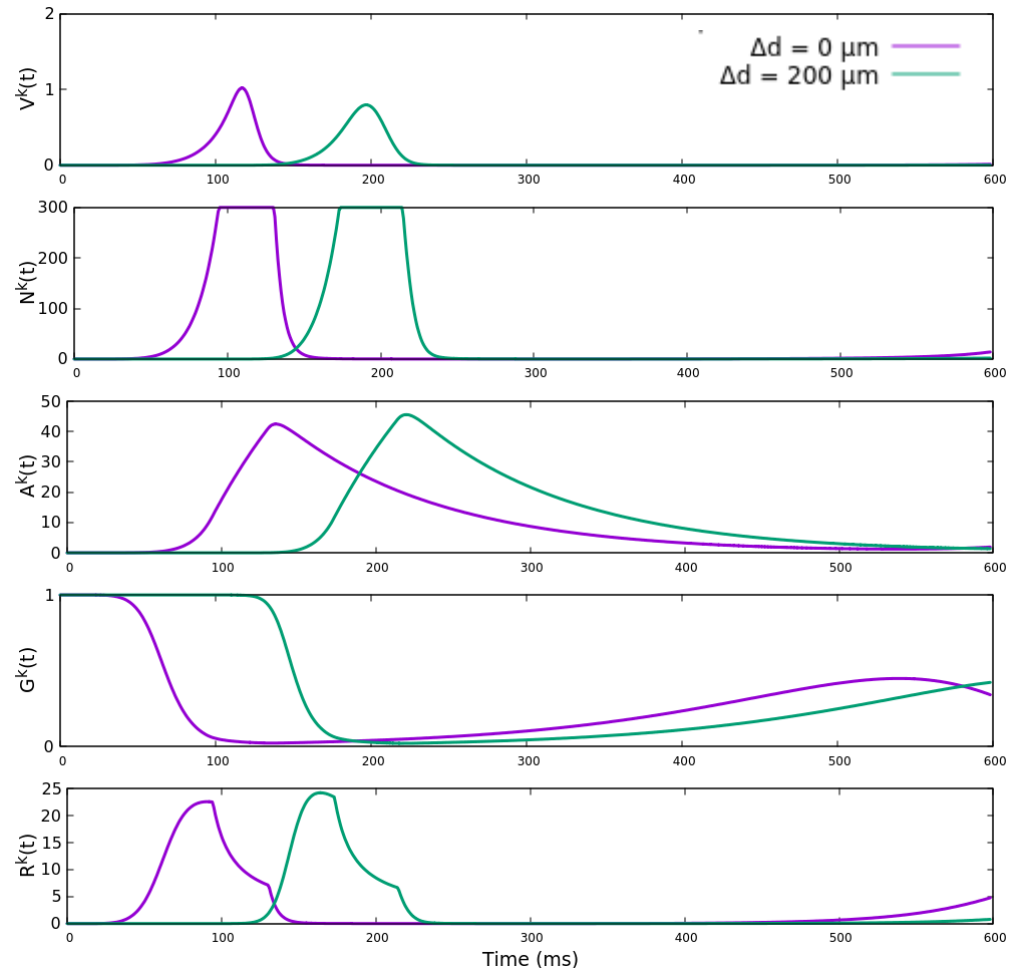
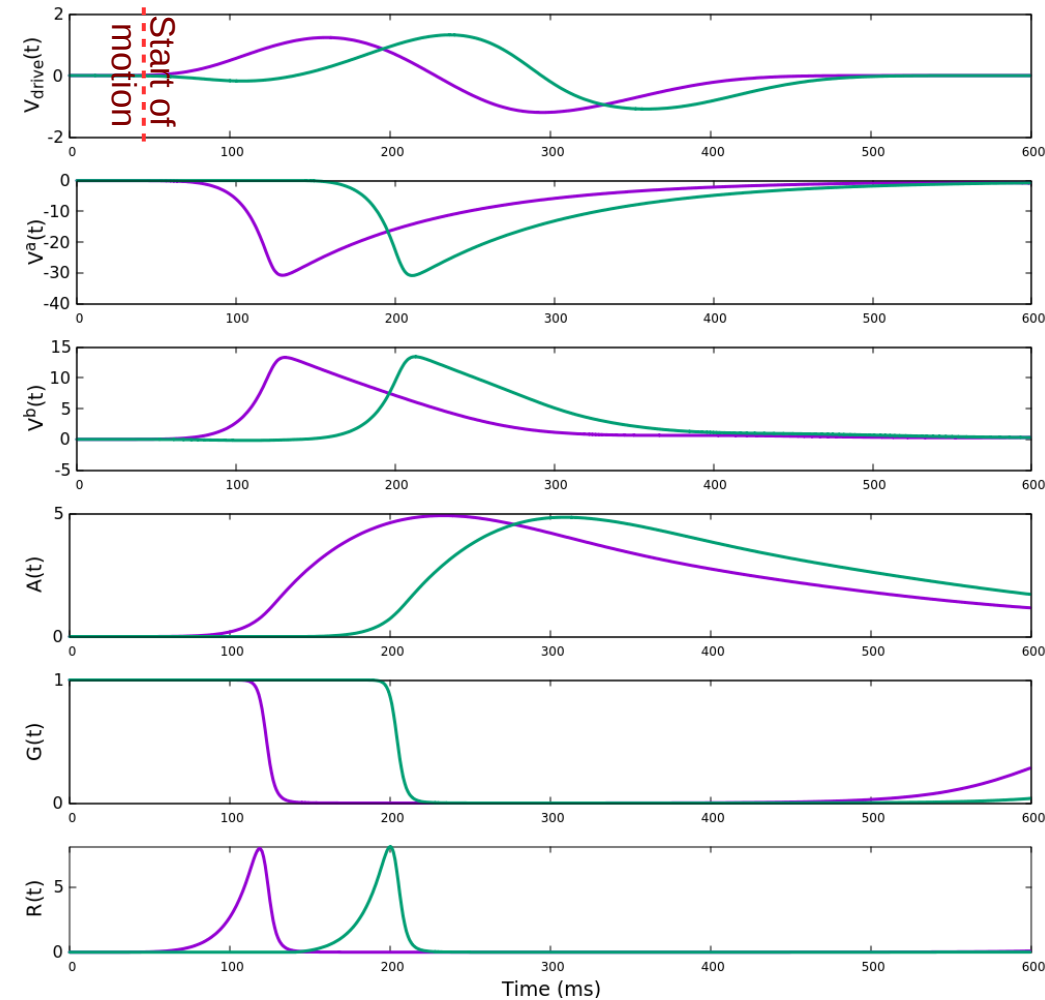



# 1D results : smooth motion anticipation with amacrine connectivity

Anticipation variability with stimulus parameters

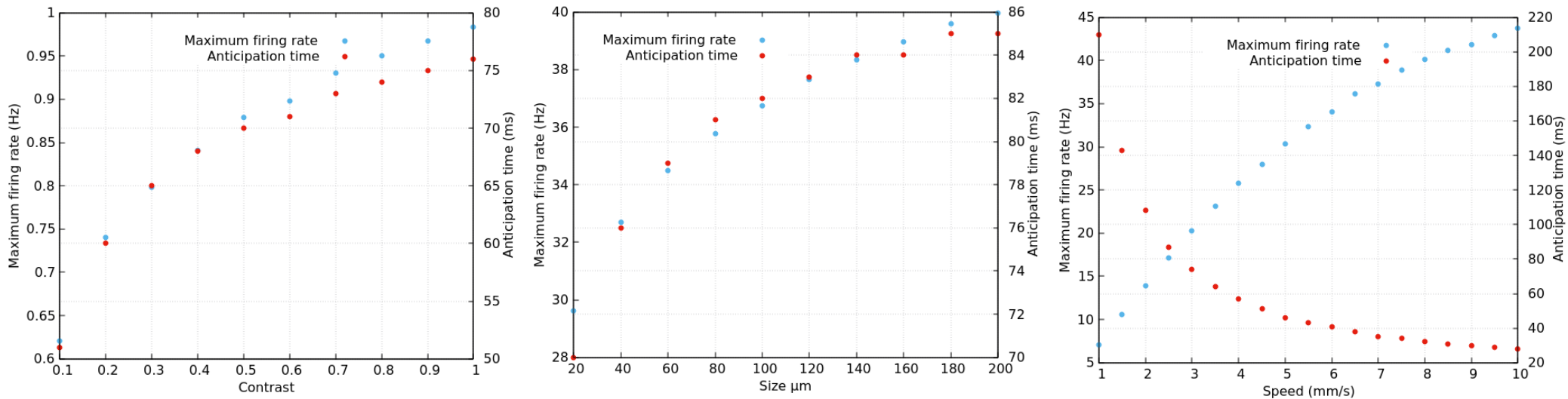

# Comparing the performance of the three layers

Anticipation contrast-wise

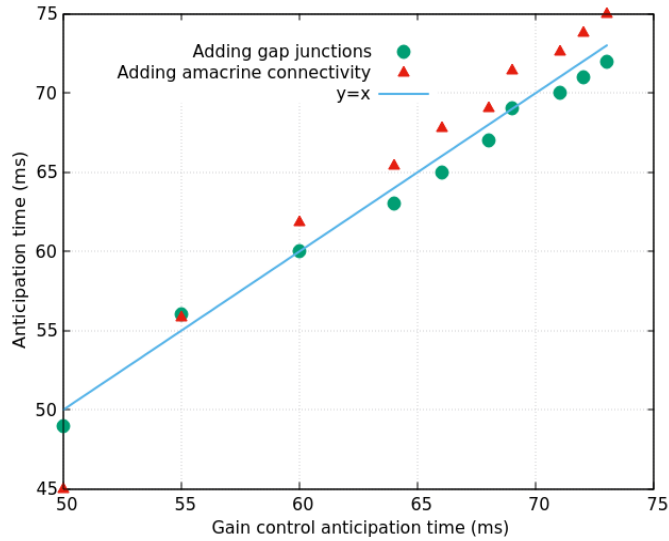

Anticipation size-wise

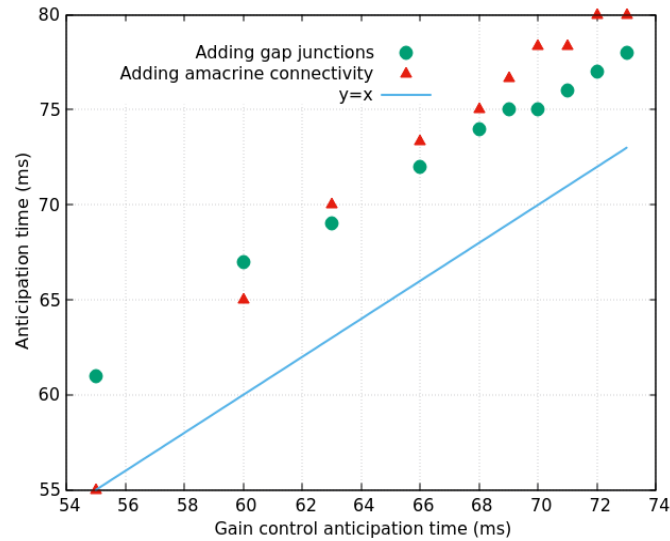

Anticipation speed-wise

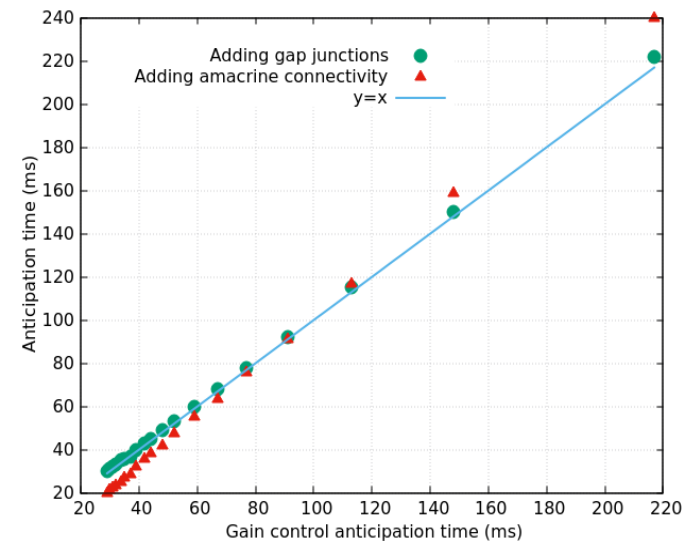

Maximum firing rate contrast-wise

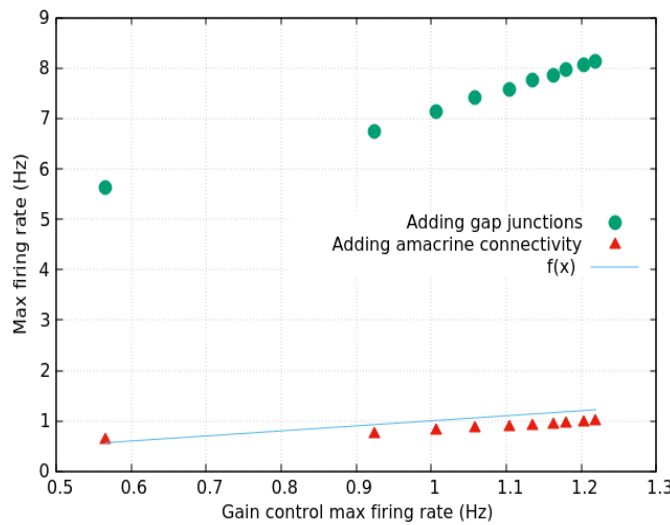

Maximum firing rate size-wise

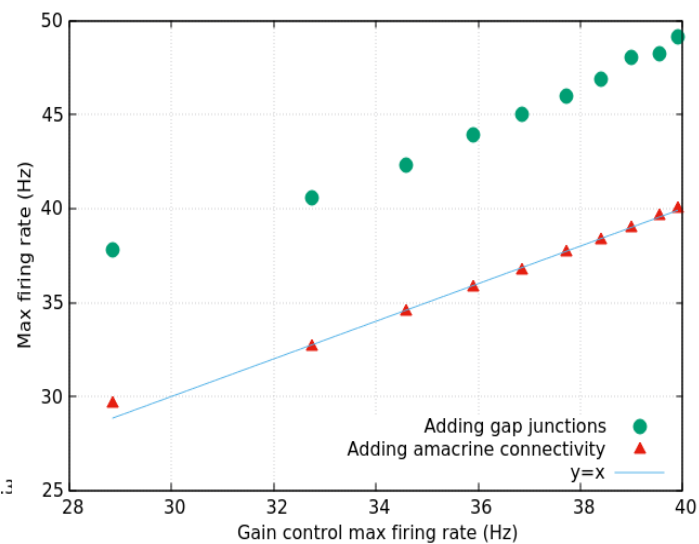

Maximum firing rate speed-wise

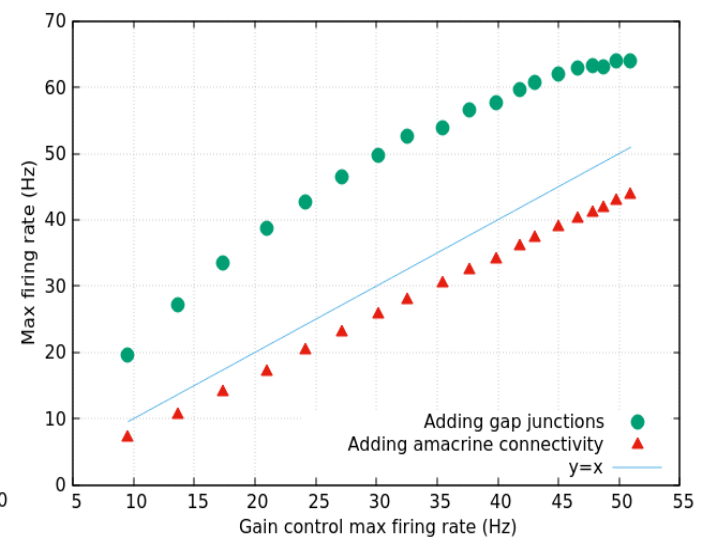

# Suggesting new experiments : 2D results

## 1) Angular anticipation

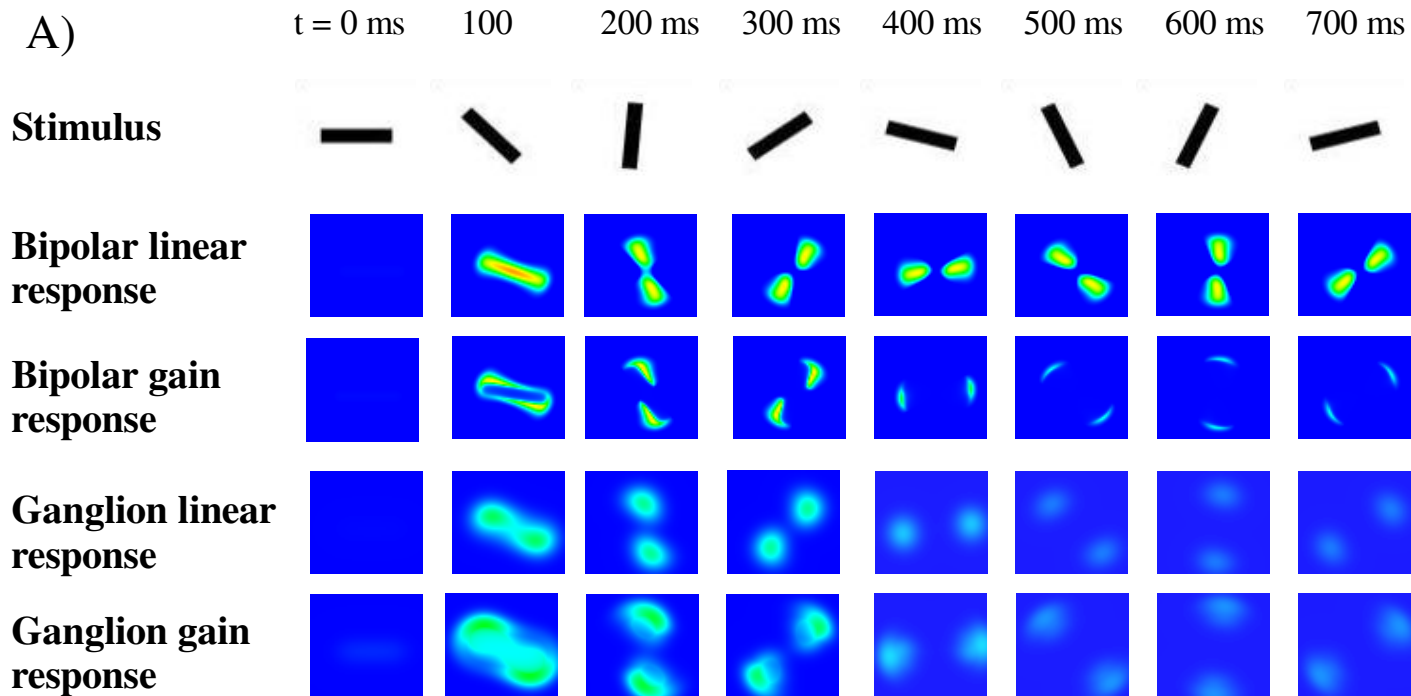

B)

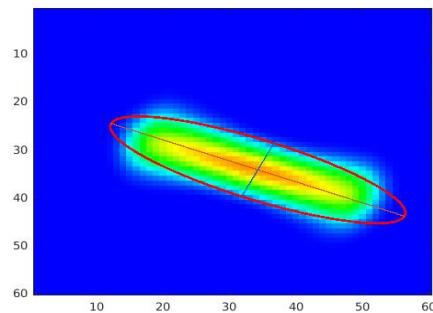

C)

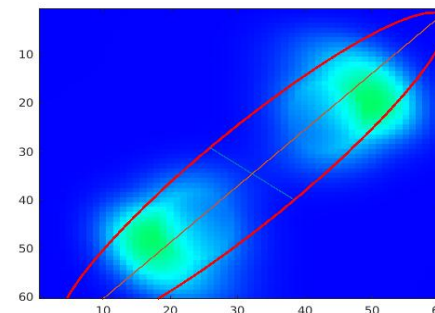

# Suggesting new experiments : 2D results

## 1) Angular anticipation

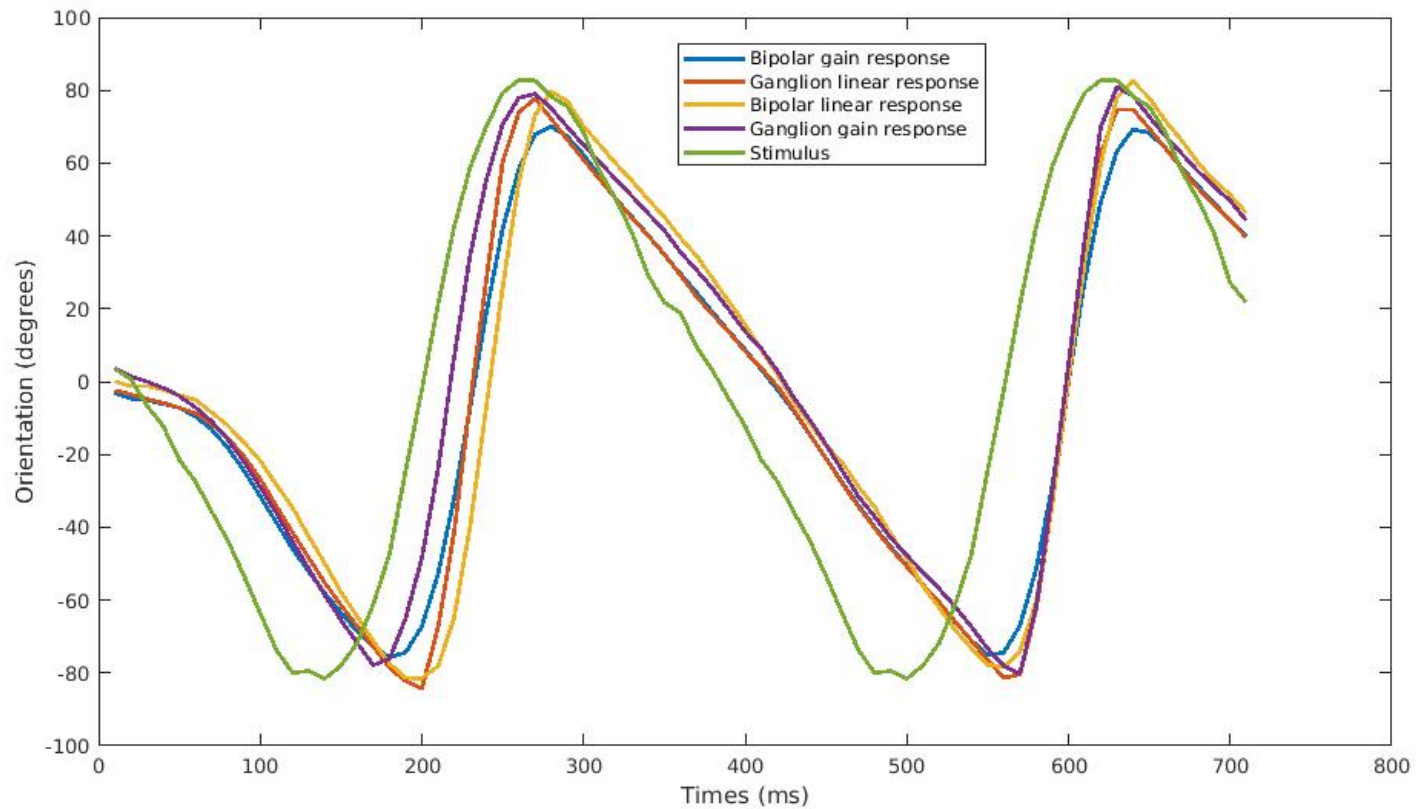

## II ) Anticipation in V1

# A mean field model to reproduce VSDI recordings

Zerlaut et al 2016  
Chemla et al 2018

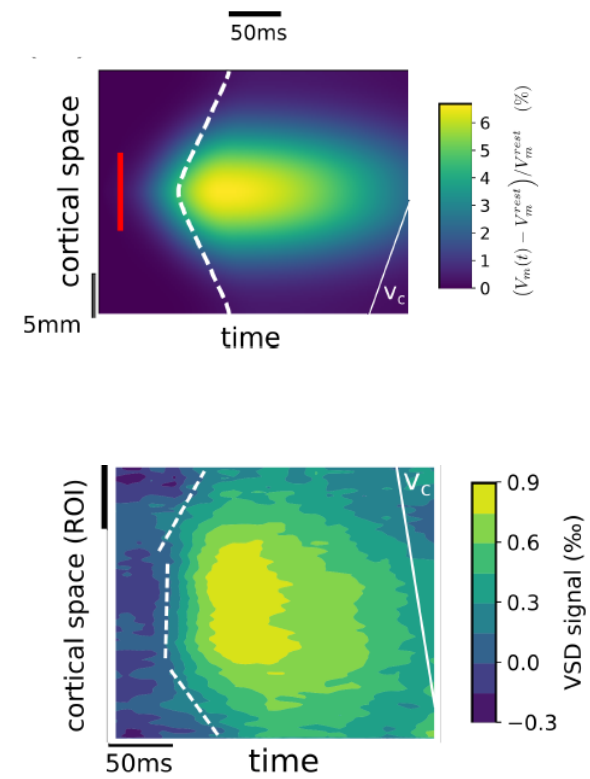
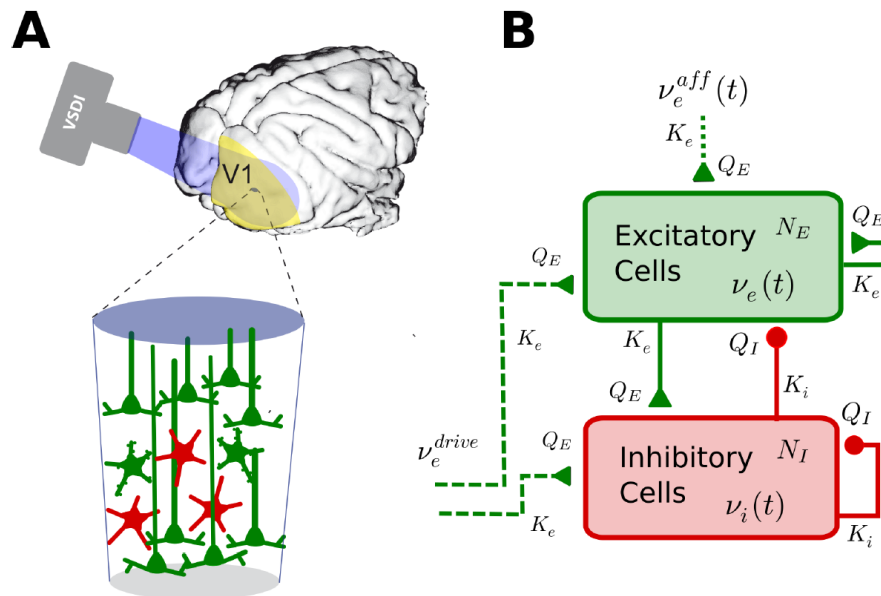

# A mean field model to reproduce VSDI recordings

Zerlaut et al 2016  
Chemla et al 2018

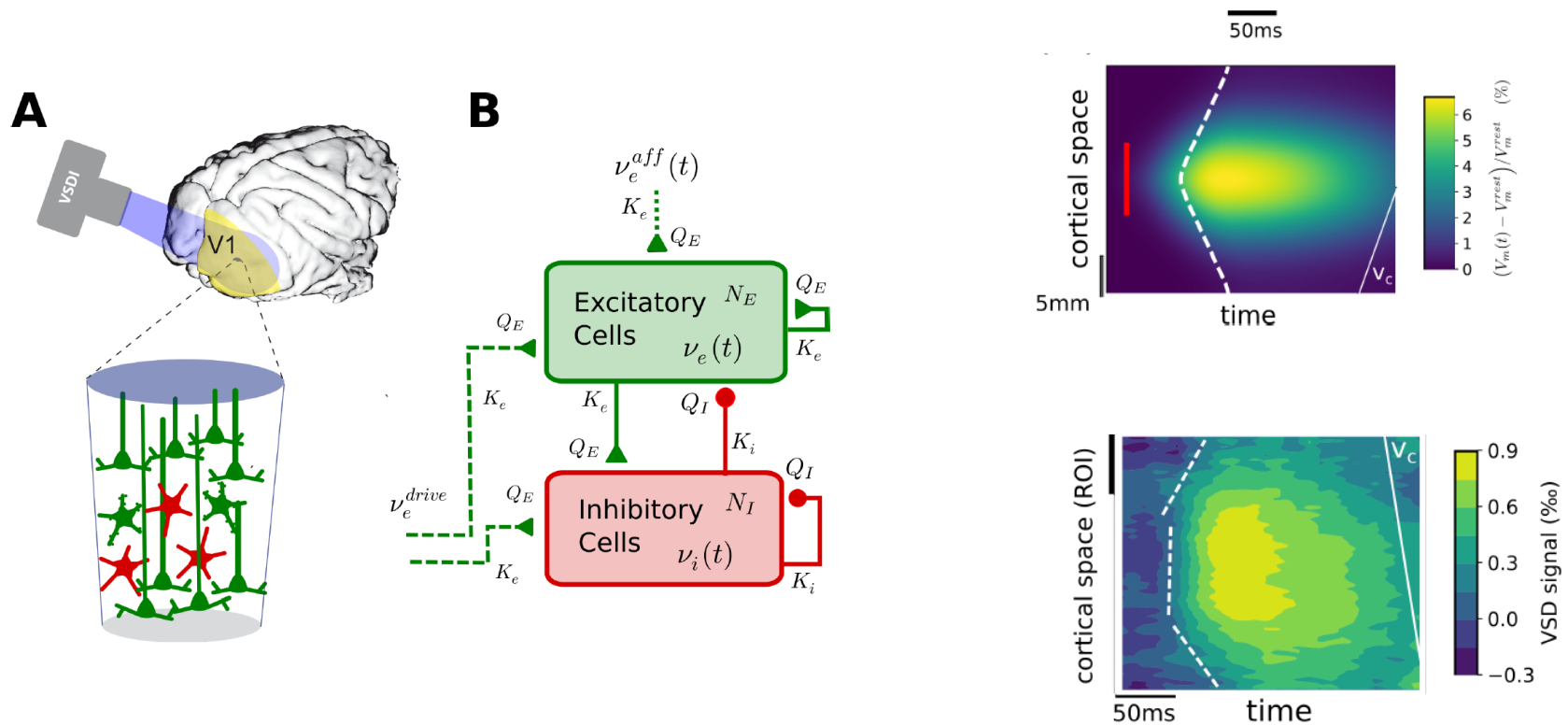

**Challenge** : connect our retina model to a mean field cortical model reproducing VSDI data

# Cortex mean field model

Zerlaut et al 2016  
Chemla et al 2018

Single neuron model

Semi analytical transfer function

Mean field equations

Single neuron model (The adaptative exponential integrate and fire model Brette and Gerstner, 2005 )

Semi analytical transfer function

Master equation local population dynamics (El Boustani and Destexhe, 2009)

$$\begin{cases} C_m \frac{dV}{dt} = g_L (E_L - V) + I_{syn}(V, t) + k_a e^{\frac{V - V_{thre}}{k_a}} - I_w \\ \tau_w \frac{dI_w}{dt} = -I_w + a \cdot (V - E_L) + \sum_{t_s \in \{t_{spike}\}} b \delta(t - t_s) \end{cases}$$

$$\nu_{out} = \mathcal{F}(\nu_e, \nu_i) = \frac{1}{2\tau_V} \cdot \text{Erfc}\left(\frac{V_{thre}^{eff} - \mu_V}{\sqrt{2}\sigma_V}\right)$$

$$\begin{cases} T \frac{\partial \nu_\mu}{\partial t} = (\mathcal{F}_\mu - \nu_\mu) + \frac{1}{2} c_{\lambda\eta} \frac{\partial^2 \mathcal{F}_\mu}{\partial \nu_\lambda \partial \nu_\eta} \\ T \frac{\partial c_{\lambda\eta}}{\partial t} = A_{\lambda\eta} + (\mathcal{F}_\lambda - \nu_\lambda) (\mathcal{F}_\eta - \nu_\eta) + c_{\lambda\mu} \frac{\partial \mathcal{F}_\mu}{\partial \nu_\lambda} + c_{\mu\eta} \frac{\partial \mathcal{F}_\mu}{\partial \nu_\eta} - 2c_{\lambda\eta} \end{cases}$$

$$I_{syn}(V, t) = \sum_{s \in \{e, i\}} \sum_{t_s \in \{t_s\}} Q_s (E_s - V) e^{-\frac{t-t_s}{\tau_s}} \mathcal{H}(t - t_s)$$

$$\begin{aligned} V_{thre}^{eff}(\mu_V, \sigma_V, \tau_V^N) = & P_0 + \sum_{x \in \{\mu_V, \sigma_V, \tau_V^N\}} P_x \cdot \left(\frac{x - x^0}{\delta x^0}\right) + P_{\mu_G} \log\left(\frac{\mu_G}{g_L}\right) \\ & + \sum_{x, y \in \{\mu_V, \sigma_V, \tau_V^N\}^2} P_{xy} \cdot \left(\frac{x - x^0}{\delta x^0}\right) \left(\frac{y - y^0}{\delta y^0}\right) \end{aligned}$$

$$A_{\lambda\eta} = \begin{cases} \frac{\mathcal{F}_\lambda (1/T - \mathcal{F}_\lambda)}{N_\lambda} & \text{if } \lambda = \eta \\ 0 & \text{otherwise} \end{cases}$$



# Anticipation in V1

For distant bars, the activity rises earlier

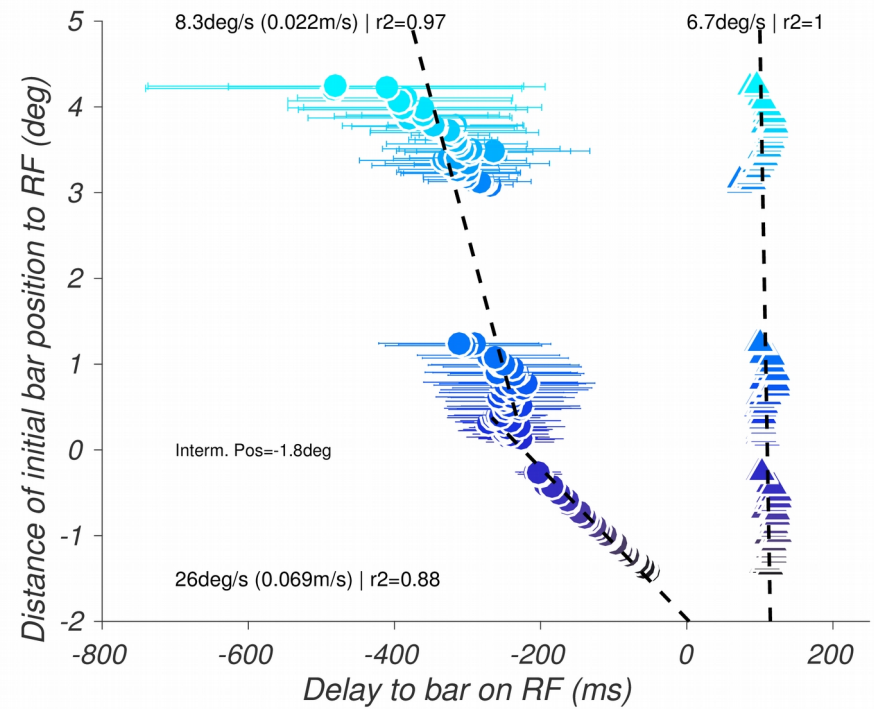
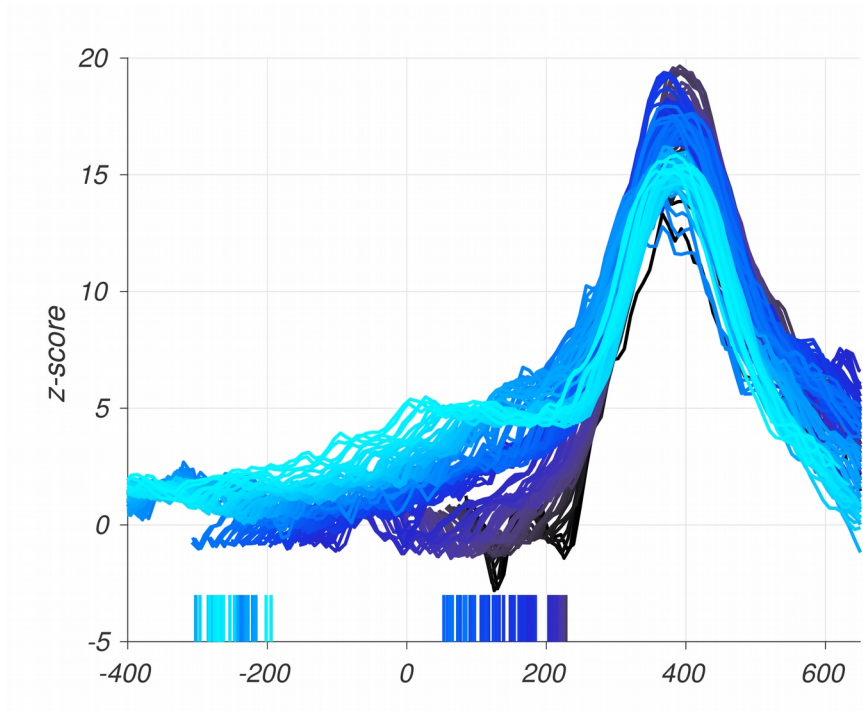

Source : Benvenuti et al. 2015

# Response of the cortical model to a retina drive without gain control

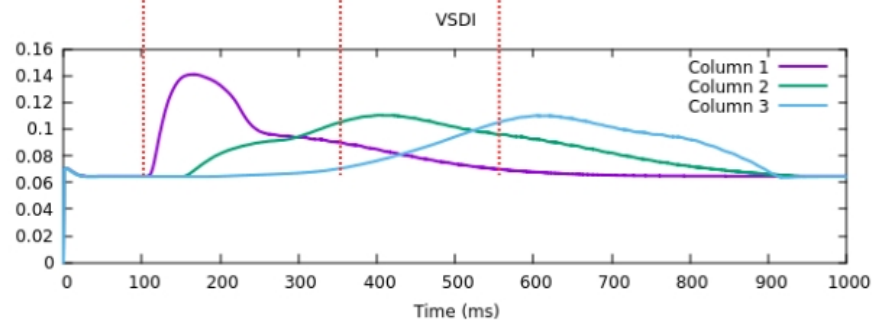
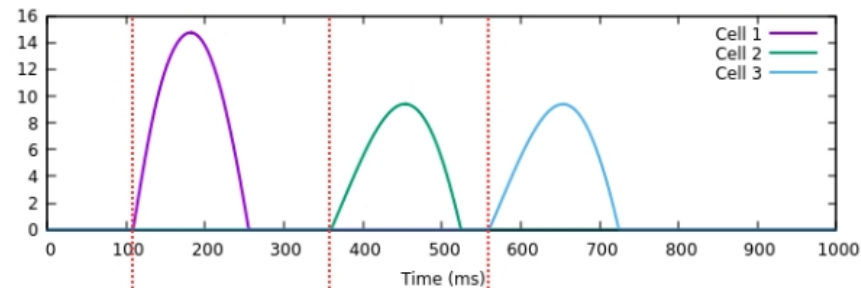
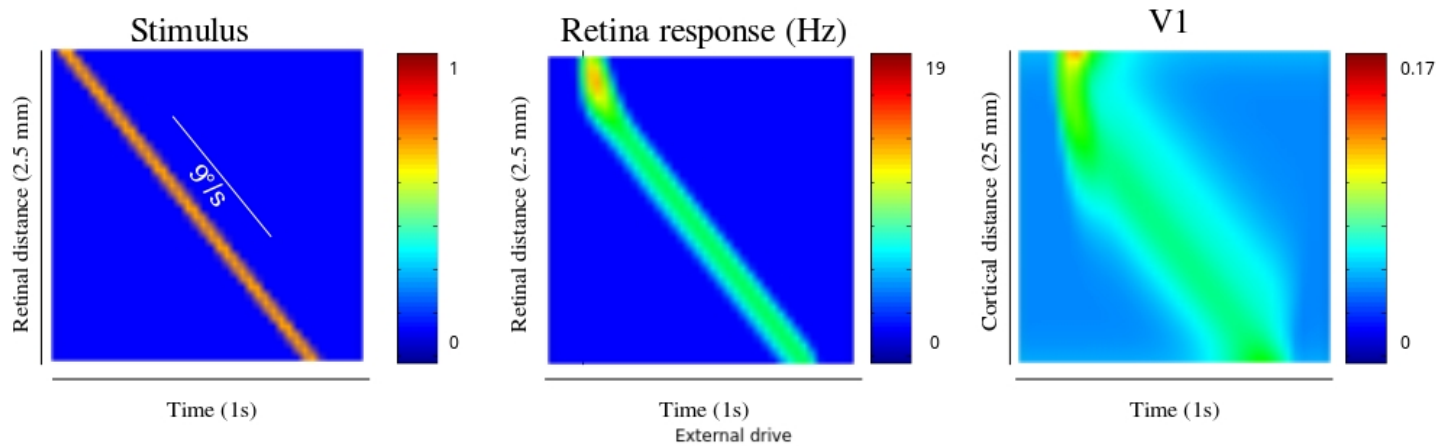

# Response of the cortical model to a retina drive with gain control

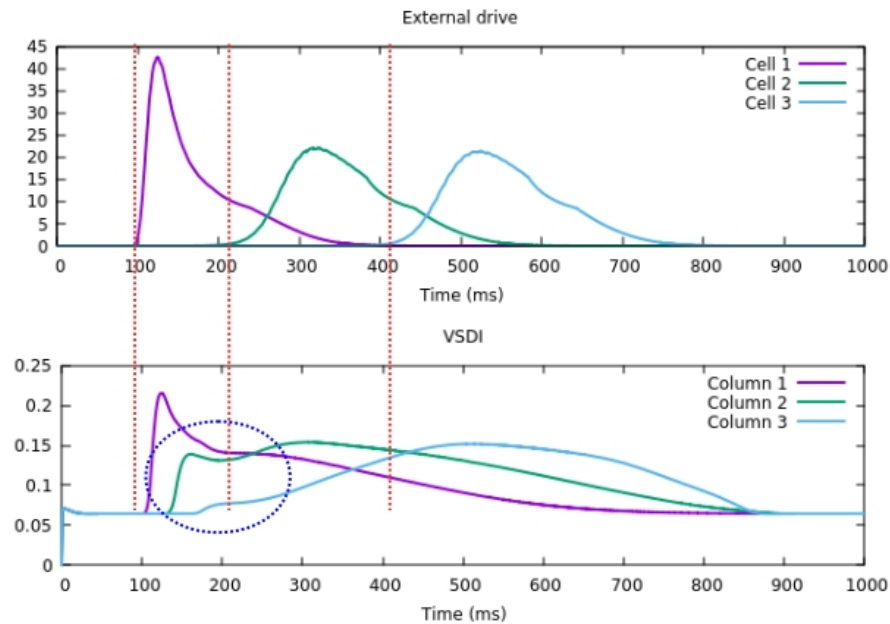
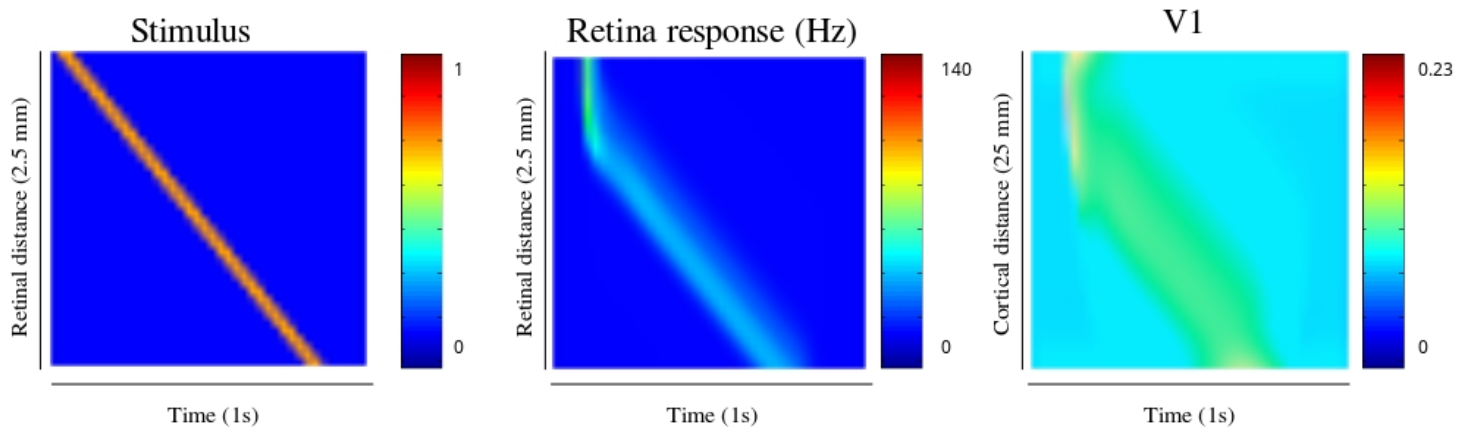

# Response of the cortical model to a retina drive with amacrine connectivity

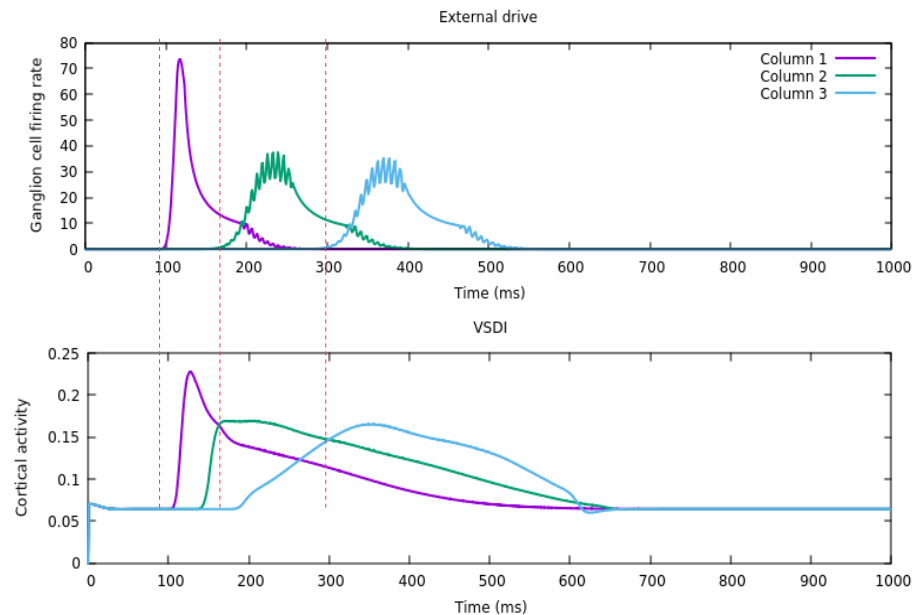
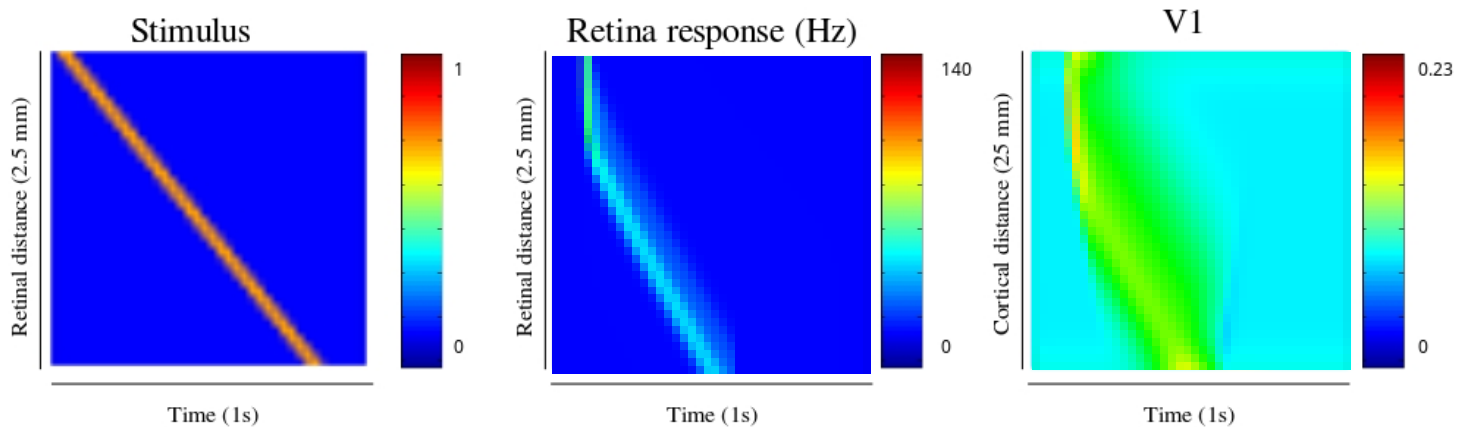

# Anticipation in the cortex : VSDI data analysis

(Data courtesy of F. Chavane et S. Chemla)

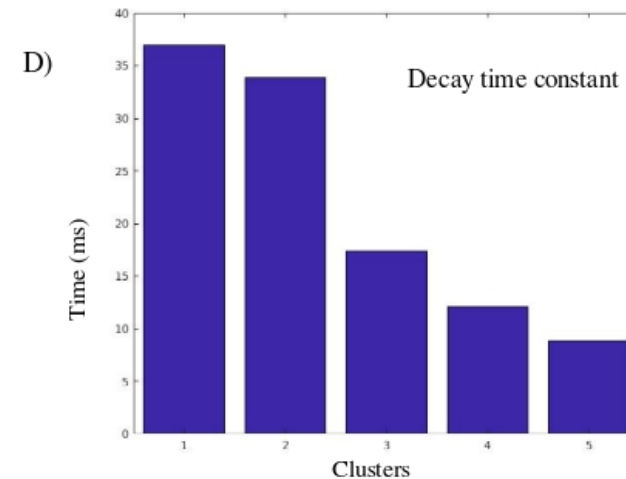
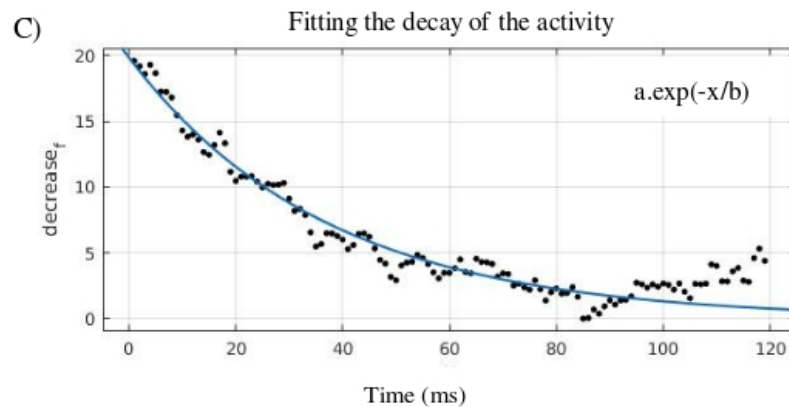
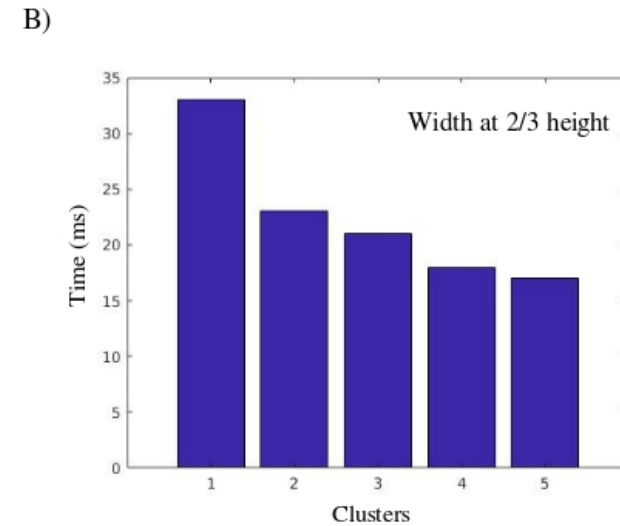
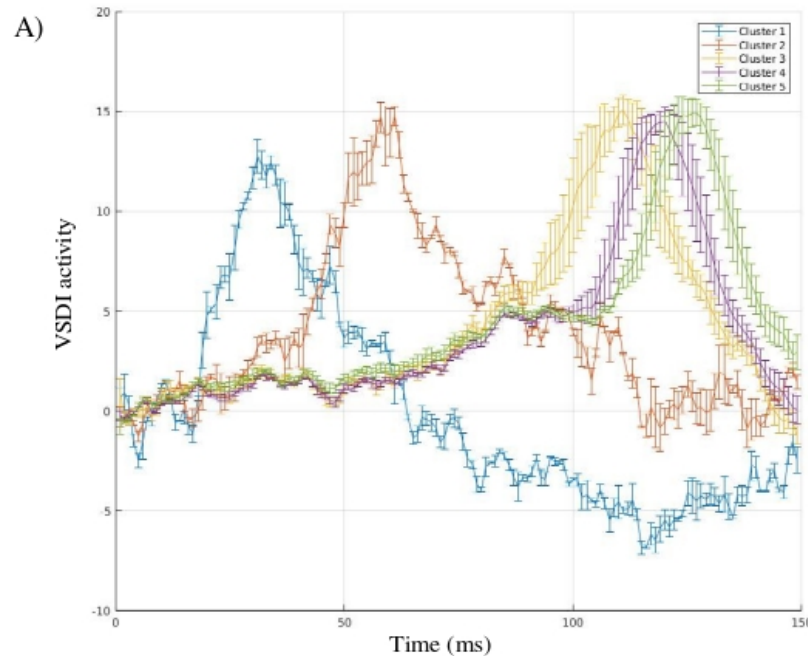

# Anticipation in V1

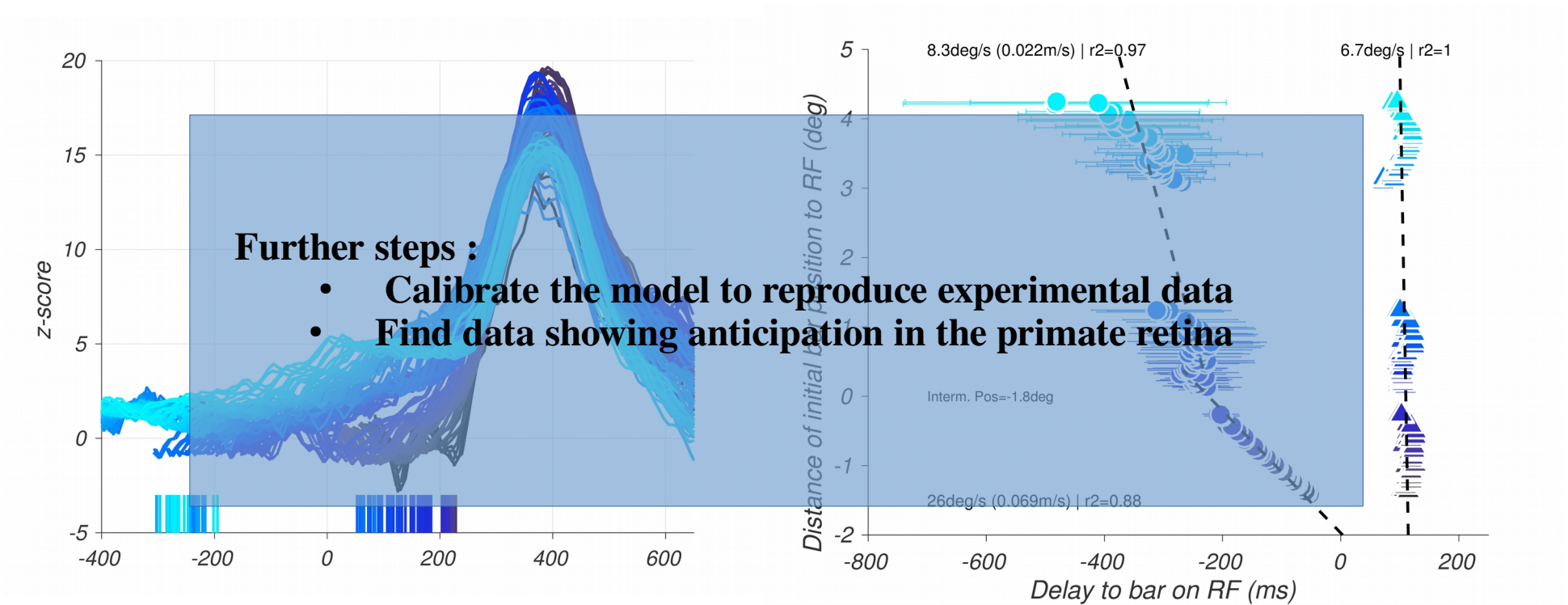

# Conclusions

## Ongoing work :

- Studying analytically anticipation in the amacrine connectivity sub-model
- Studying anticipation on non-uniform backgrounds
- Assessing the effect of anticipation in the retina on the one in the cortex

## Questions :

- How to improve object identification 1) exploring the model's parameters and 2) using connectivity ?
- Is our model able to anticipate more complex trajectories, with accelerations for instance ?
- How to calibrate connectivity using biology ?
- Would it be possible to design psycho-physical tests clearly showing the role of the retina in visual anticipation ?

Thank you for your attention !



# Supplementary material

# How does gain control work

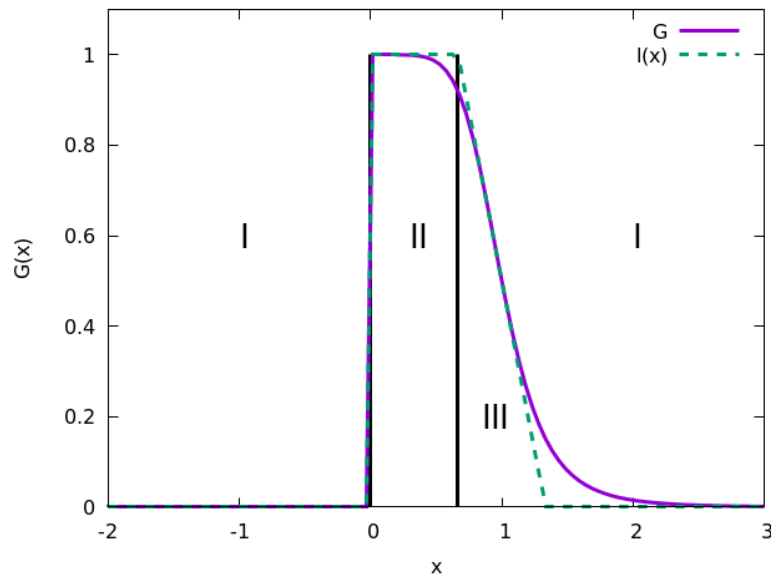

$$\mathcal{G}_B(A) = \begin{cases} 0, & \text{if } A \leq 0; \\ \frac{1}{1+A^6}, & \text{else.} \end{cases}$$

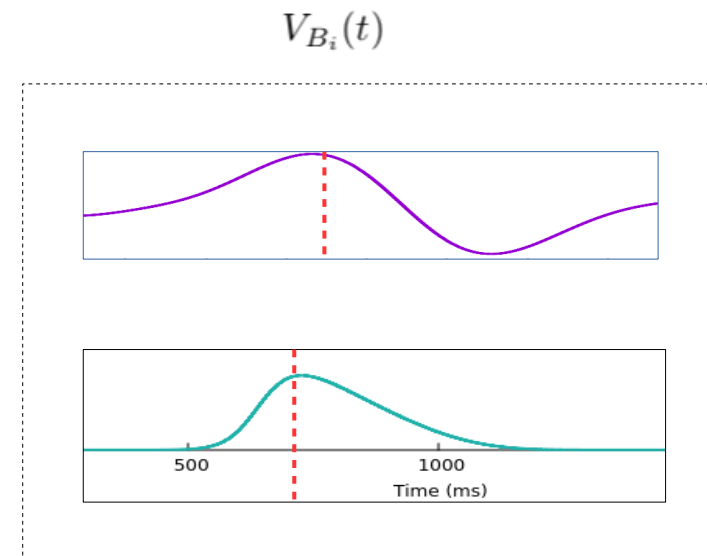

$$R_{B_i} = \mathcal{N}_B(V_{B_i}) \mathcal{G}_B(A_{B_i}).$$

# Stimulus integration

$$\left[ K_i \begin{smallmatrix} S, t \\ * \end{smallmatrix} \mathcal{S} \right] (t) = \int_{-\infty}^t K_T(t-u) \left[ \int_{\mathbb{R}^2} K_{i,S}(x, y) \mathcal{S}(x, y, u) dx dy \right] du \equiv V_{i,drive}(t).$$

A)

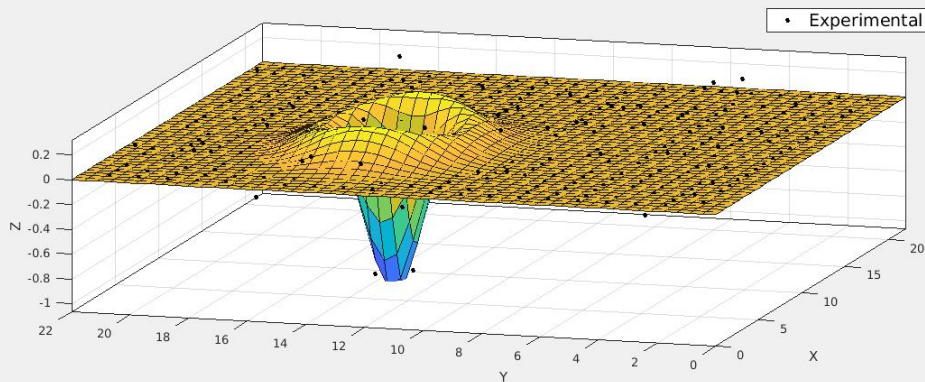

B)

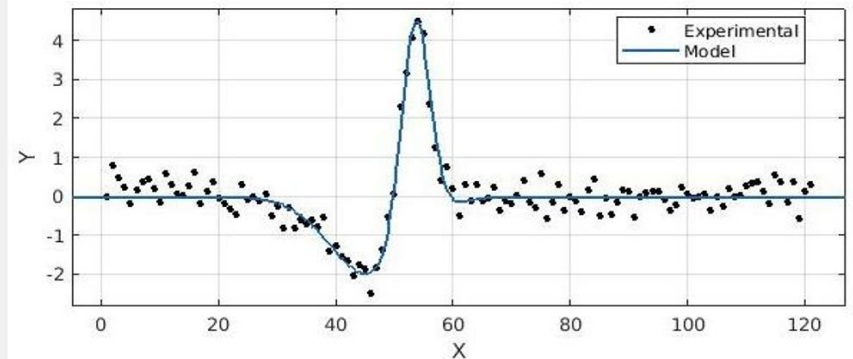

$$K_{i,S}(x, y) = \frac{A_1}{2\pi\sqrt{\det C_1}} e^{-\frac{1}{2} \bar{X}_1 \cdot C_1^{-1} \cdot X_1} - \frac{A_2}{2\pi\sqrt{\det C_2}} e^{-\frac{1}{2} \bar{X}_1 \cdot C_2^{-1} \cdot X_1},$$

$$K_T(t) = \left( \frac{K_1}{\sqrt{2\pi}\sigma_1} e^{-\frac{(t-\mu_1)^2}{2\sigma_1^2}} - \frac{K_2}{\sqrt{2\pi}\sigma_2} e^{-\frac{(t-\mu_2)^2}{2\sigma_2^2}} \right) H(t)$$

(Data courtesy of O. Marre )

# Stimulus integration : anisotropy

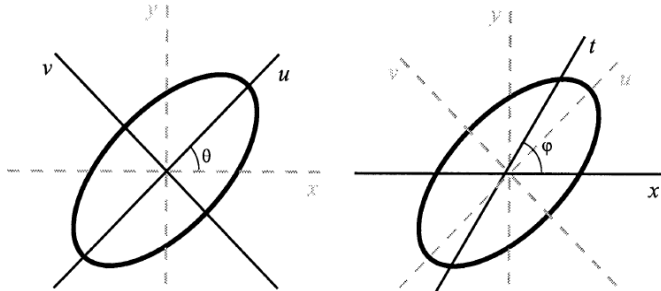

Geusebroek et al. 2003

$$\sigma_{x'} = \frac{\sigma_x \sigma_y}{\sqrt{\sigma_x^2 \cos^2 \theta + \sigma_y^2 \sin^2 \theta}}$$

$$\sigma_\phi = \frac{\sqrt{\sigma_y^2 \cos^2 \theta + \sigma_x^2 \sin^2 \theta}}{\sin \phi}$$

$$\tan(\phi) = \frac{\sigma_y^2 \cos^2 \theta + \sigma_x^2 \sin^2 \theta}{(\sigma^2 - \sigma_y^2) \cos \theta \sin \theta}$$

$$I = \sigma_{x'} \sqrt{\frac{\pi}{2}} \sum_{(i;j) \in [0, s_x] \times [0, s_y]} \int_{y - \frac{\delta}{\sin(\phi)}}^{(y+1) \frac{\delta}{\sin(\phi)}} C_{ij} e^{-\frac{(y' - y'_0)^2}{2\sigma_\phi^2}}$$

$$[erf(\frac{(-\cos(\phi)y' + x + 1)\delta - x'_0}{\sqrt{2}\sigma_{x'}}) - erf(\frac{(-\cos(\phi)y' + x)\delta - x'_0}{\sqrt{2}\sigma_{x'}})] dy'$$

$\Theta = 0^\circ$

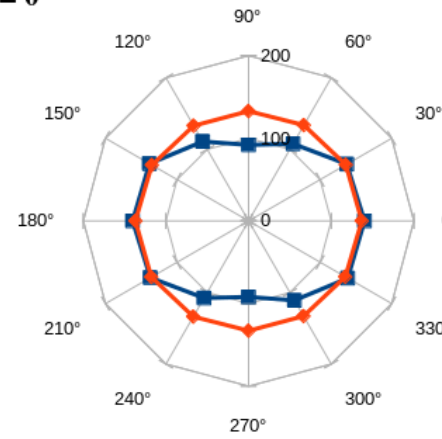

$\Theta = 30^\circ$

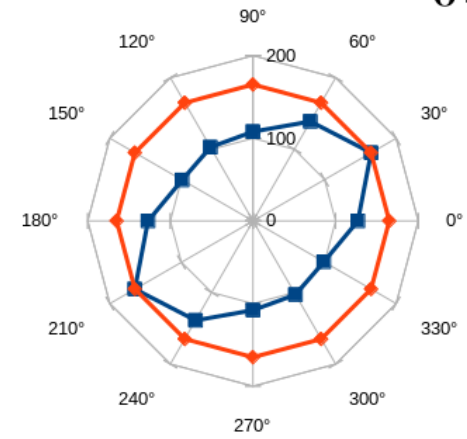

$\Theta = 90^\circ$

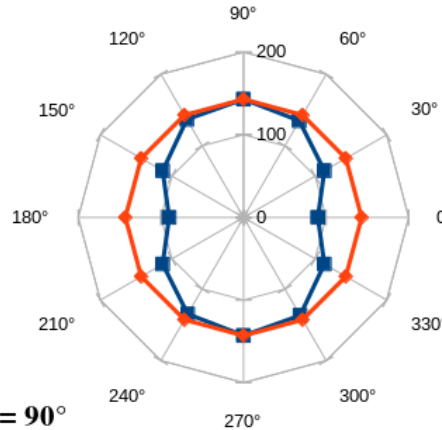

$\Theta = 120^\circ$

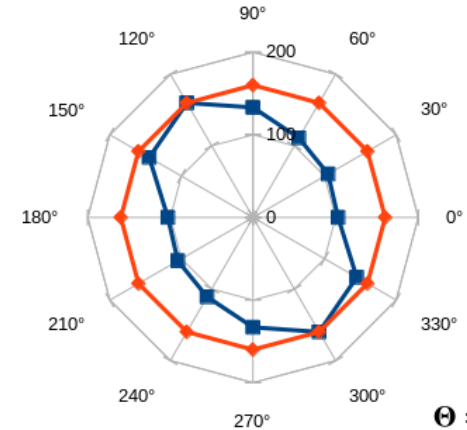

# Connectivity graph

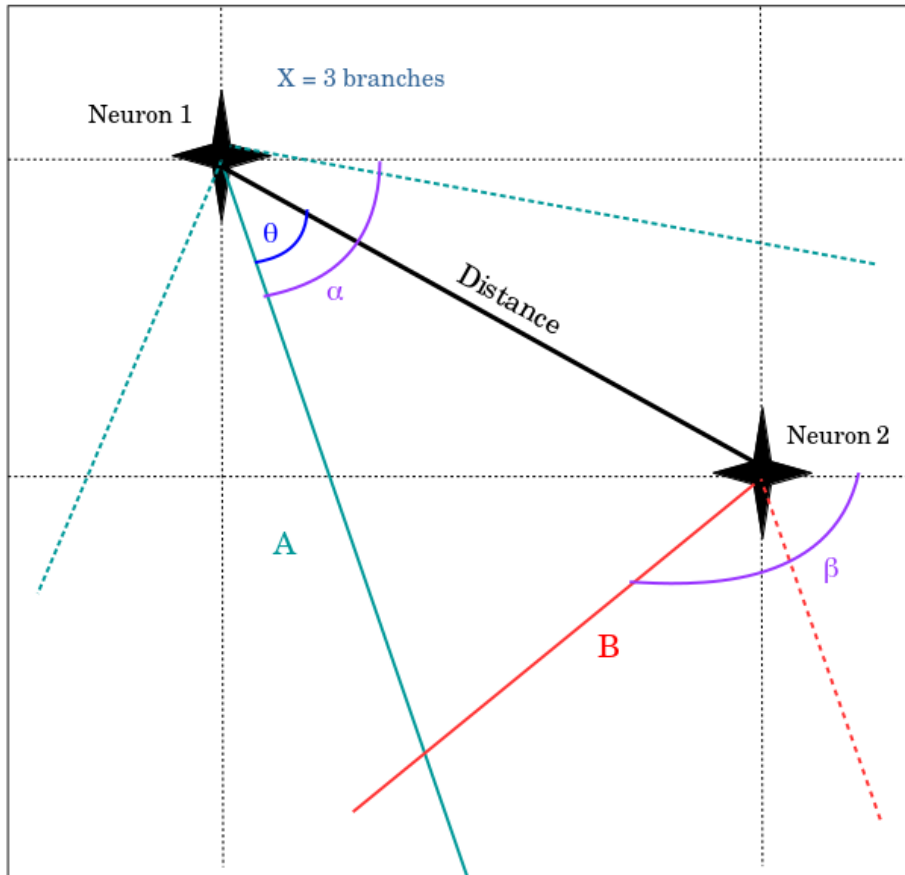

- Variables of the model :
- Number of branches  $N$
  - Branch length  $X$
  - Branch angle  $\alpha$

$$F_X(x) = \int_0^1 \frac{1}{\pi\sqrt{1-\delta^2}} \frac{x}{x+\delta} d\delta$$

$$\sin\left(\beta + \frac{\arcsin |y_j - y_i|}{\sqrt{(x_j - y_i)^2 + (y_j - x_j)^2}}\right)$$

# Cortex mean field model

Zerlaut et al 2016  
Chemla et al 2018

Single neuron model (The adaptive exponential integrate and fire model Brette and Gerstner, 2005 )

$$\begin{cases} C_m \frac{dV}{dt} = g_L (E_L - V) + I_{syn}(V, t) + k_a e^{\frac{V - V_{thre}}{k_a}} - I_w \\ \tau_w \frac{dI_w}{dt} = -I_w + a \cdot (V - E_L) + \sum_{t_s \in \{t_{spike}\}} b \delta(t - t_s) \end{cases}$$

The conductance-based exponential synapse

$$I_{syn}(V, t) = \sum_{s \in \{e, i\}} \sum_{t_s \in \{t_s\}} Q_s (E_s - V) e^{-\frac{t-t_s}{\tau_s}} \mathcal{H}(t - t_s)$$

Semi analytical transfer function :

$$\nu_{out} = \mathcal{F}(\nu_e, \nu_i) = \frac{1}{2\tau_V} \cdot \text{Erfc}\left(\frac{V_{thre}^{eff} - \mu_V}{\sqrt{2}\sigma_V}\right) \quad \text{with} \quad V_{thre}^{eff}(\mu_V, \sigma_V, \tau_V^N) = P_0 + \sum_{x \in \{\mu_V, \sigma_V, \tau_V^N\}} P_x \cdot \left(\frac{x - x^0}{\delta x^0}\right) + P_{\mu_G} \log\left(\frac{\mu_G}{g_L}\right) \\ + \sum_{x, y \in \{\mu_V, \sigma_V, \tau_V^N\}^2} P_{xy} \cdot \left(\frac{x - x^0}{\delta x^0}\right) \left(\frac{y - y^0}{\delta y^0}\right)$$

# Cortex mean field model

Zerlaut et al 2016  
Chemla et al 2018

The mean, standard deviation and auto-correlation time of the excitatory and inhibitory conductance read :

$$\begin{array}{l}
 \mu_{Ge}(\nu_e, \nu_i) = \nu_e K_e \tau_e Q_e \\
 \sigma_{Ge}(\nu_e, \nu_i) = \sqrt{\frac{\nu_e K_e \tau_e}{2}} Q_e \\
 \mu_{Gi}(\nu_e, \nu_i) = \nu_i K_i \tau_i Q_i \\
 \sigma_{Gi}(\nu_e, \nu_i) = \sqrt{\frac{\nu_i K_i \tau_i}{2}} Q_i
 \end{array}
 \longrightarrow
 \begin{array}{l}
 \mu_G(\nu_e, \nu_i) = \mu_{Ge} + \mu_{Gi} + g_L \\
 \tau_m(\nu_e, \nu_i) = \frac{C_m}{\mu_G} \\
 \downarrow \\
 \mu_V(\nu_e, \nu_i) = \frac{\mu_{Ge} E_e + \mu_{Gi} E_i + g_L E_L}{\mu_G} \\
 \sigma_V(\nu_e, \nu_i) = \sqrt{\sum_s K_s \nu_s \frac{(U_s \cdot \tau_s)^2}{2(\tau_m^{\text{eff}} + \tau_s)}} \\
 \tau_V(\nu_e, \nu_i) = \left( \frac{\sum_s (K_s \nu_s (U_s \cdot \tau_s)^2)}{\sum_s (K_s \nu_s (U_s \cdot \tau_s)^2 / (\tau_m^{\text{eff}} + \tau_s))} \right)
 \end{array}$$

Finally, the transfer function reads :

$$\nu_{out} = \mathcal{F}(\nu_e, \nu_i) = \frac{1}{2\tau_V} \cdot \text{Erfc}\left(\frac{V_{thre}^{eff} - \mu_V}{\sqrt{2}\sigma_V}\right)$$

# Cortex mean field model

Zerlaut et al 2016  
Chemla et al 2018

Master equation for first and second moments local population dynamics (El Boustani and Destexhe, 2009) read :

$$\left\{ \begin{array}{l} T \frac{\partial \nu_\mu}{\partial t} = (\mathcal{F}_\mu - \nu_\mu) + \frac{1}{2} c_{\lambda\eta} \frac{\partial^2 \mathcal{F}_\mu}{\partial \nu_\lambda \partial \nu_\eta} \\ T \frac{\partial c_{\lambda\eta}}{\partial t} = A_{\lambda\eta} + (\mathcal{F}_\lambda - \nu_\lambda) (\mathcal{F}_\eta - \nu_\eta) + \\ \quad c_{\lambda\mu} \frac{\partial \mathcal{F}_\mu}{\partial \nu_\lambda} + c_{\mu\eta} \frac{\partial \mathcal{F}_\mu}{\partial \nu_\eta} - 2c_{\lambda\eta} \end{array} \right. \longrightarrow T \frac{\partial \nu_\mu}{\partial t} = \mathcal{F}_\mu - \nu_\mu$$

$$A_{\lambda\eta} = \begin{cases} \frac{\mathcal{F}_\lambda (1/T - \mathcal{F}_\lambda)}{N_\lambda} & \text{if } \lambda = \eta \\ 0 & \text{otherwise} \end{cases}$$



# Comparing simulation results to VSDI recordings

Cortex experimental recordings

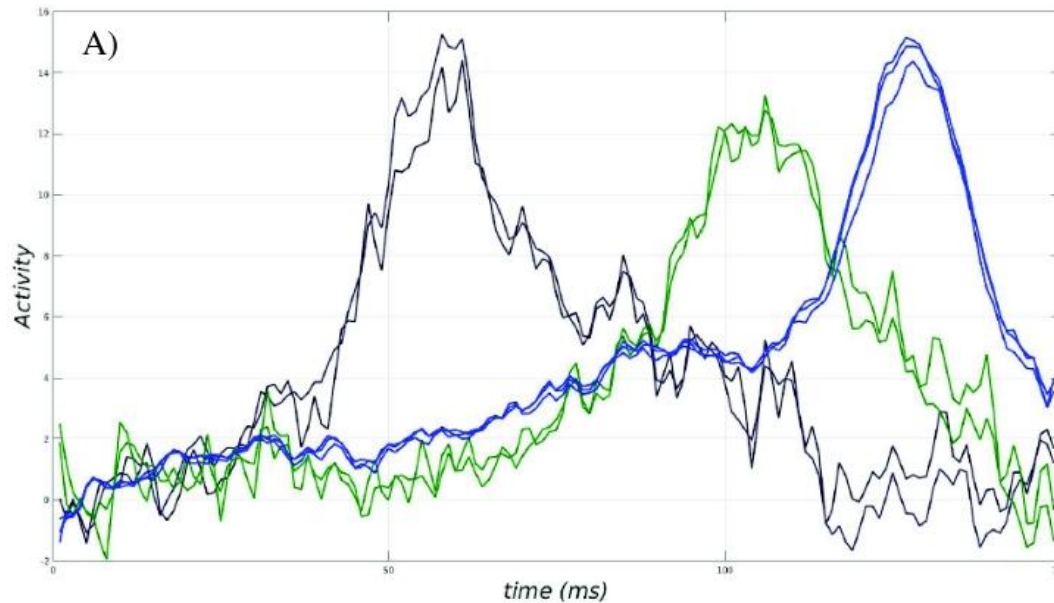

Simulation results  
Response to an LN  
model of the retina

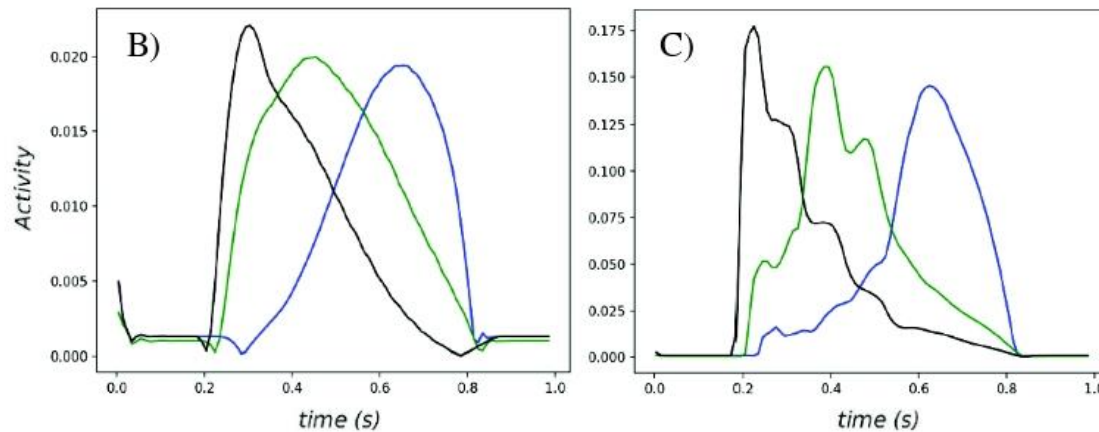

Simulation results  
Response to a gain  
control model of the  
retina