



HAL
open science

Design and Implementation of Water Spectrum Observation System for Aquaculture Pond

Yinchi Ma, Wen Ding, Yonghua Qu, Xiande Zhao

► **To cite this version:**

Yinchi Ma, Wen Ding, Yonghua Qu, Xiande Zhao. Design and Implementation of Water Spectrum Observation System for Aquaculture Pond. 11th International Conference on Computer and Computing Technologies in Agriculture (CCTA), Aug 2017, Jilin, China. pp.194-205, 10.1007/978-3-030-06137-1_19 . hal-02124230

HAL Id: hal-02124230

<https://inria.hal.science/hal-02124230>

Submitted on 9 May 2019

HAL is a multi-disciplinary open access archive for the deposit and dissemination of scientific research documents, whether they are published or not. The documents may come from teaching and research institutions in France or abroad, or from public or private research centers.

L'archive ouverte pluridisciplinaire **HAL**, est destinée au dépôt et à la diffusion de documents scientifiques de niveau recherche, publiés ou non, émanant des établissements d'enseignement et de recherche français ou étrangers, des laboratoires publics ou privés.



Distributed under a Creative Commons Attribution 4.0 International License

Design and Implementation of Water Spectrum

Observation System for Aquaculture Pond

Yinchi Ma¹(✉), Wen Ding¹, Yonghua Qu², Xiande Zhao³

1 Beijing Fisheries Research Institute, Beijing, China

{mayinchi,dingwen}@bjfishery.com

2 Beijing Normal University, Beijing, China

qyh@bnu.edu.cn

3 National Engineering Research Center for Intelligent Equipment in Agriculture,
Beijing, China

zhaoxd@nercita.org.cn

Abstract. The spectral characteristics of agriculture water can reflect the water quality indirectly. How to observe the spectrum quickly and accurately is basis of evaluating aquaculture water quality by remote sensing technology. Many investigations indicate that the spectrum of several specific bands can reflect some water quality conditions. In this article, a real-time and automatic spectrum observation system is built based on high-precision optical sensor, flash storage technology, GPRS and RS485 wireless data transmission technology to observe the spectrum of specific bands. Through continuous observation of 5 ponds, the data is compared with data measured by ASD spectrometer in bands 680nm, 700nm and 769nm. The data measured by ASD spectrometer is set as the standard value. The accuracy of the data measured by this system is above 98%. The result shows that, this system could take the place of spectrometer to measure the spectrum of specific bands. It can realize remote, real-time data observation.

Keywords: water; spectrum; observation; optical; sensor

1 Introduction

In recent years, the research of water has become more and more important. How to get the water information quickly and accurately is the basic research content of water environment remote sensing [1, 2]. Usually, the portable spectrometer is used to observe the spectrum on the surface of the water [3, 4]. Compared with satellite remote sensing or aerial remote sensing, the observation is more mobile and the operation of data is also easier. But the space scale of this way is lower. The observation program is cumbersome and the real time is poor otherwise [5, 6]. However, the spectroscopic observation on the surface of the water is the basis of water remote sensing on large-scale water. For small and medium-sized water, it is also an effective method [7, 8].

Fund program: Beijing Academy of Agriculture and Forestry "cold water fish science and technology innovation team" (JNKST201611) project financing; Beijing Academy of Agriculture and Forestry Innovation Ability Construction "Research of Spectrum Sensing Monitoring Technology for Aquaculture Pond Water Quality" (KJCX20150411) project financing; Beijing Academy of Agriculture and Forestry Innovation Ability Construction "Research and Development of High-precision Sensing Technology for Aquaculture" (KJCX20170701) project financing

The area of aquaculture pond is usually small or medium-sized. Daily maintenance is convenient and the aquaculture water is less affected by natural conditions. At the same time, spectrum of some specific bands in the visible light and near infrared range could reflect the water quality condition indirectly and objectively [9, 10]. There is no need to observe spectrum of a continuous band [11]. Considering the environment characteristic of the aquaculture pond and the preliminary research foundation, a real-time and automatic spectrum of specific bands observation system is built based on high-precision optical sensor, flash storage technology, GPRS and RS485 wireless data transmission technology [12, 13]. The system is unattended and easy to maintain. The data observed by this system is highly accurate and convenient to process and analyze. The system could replace artificial spectral observation effectively and provide a technical basis for the daily water quality monitoring of the aquaculture pond [14, 15].

2 Materials and Methods

2.1 Basic Principle of the Water Spectrum Observation

In the study of the water spectral characteristics, the physical quantities observed should compute the water-leaving radiance (L_w), normalized water-leaving radiance (L_{wn}), remote sensing reflectance (R_{rs}). There are two methods for the water spectrum observation. The first one is profiling method. The other one is above-water method. The profiling method is to calculate the optical signal of the water surface by measuring the optical properties of the water with different depths. However, this method is time-consuming and arduous. This method requires the depth of the measured water must be more than 10 meters and needs a high requirement of equipment. This method is usually used in the I-water. The above-water method is to measure the reflection signal of the water surface, the sky light and incident signal above the water by using appropriate observation geometry. Because of its convenient operation and high accuracy, this method plays an increasingly important role in the spectrum observation of the II-water. When measuring the reflection spectrum, the radiance of the target could be measured directly. However, the incident radiance of the target surface should be get by measuring the radiance of the standard reference plate.

When measuring the water spectrum outside, the signal received by the spectrometer L_{sw} shows as below.

$$L_{sw} = L_w + r * L_{sky} + L_g \quad (1)$$

L_w is the signal of the water. L_{sky} is the signal of the sky light. L_g is the direct reflection of the sun. r is the surface reflectance of the water vapor.

When adopting appropriate observation geometry, the signal received by the spectrometer can be approximate as below.

$$L_{sw} = L_w + r * L_{sky} \quad (2)$$

Taking the observation geometry in the analysis of the water spectrum as an example (Figure 1), the observation direction turns 90-135 degree angle from the incident direction of the sun light, and the fiver probe turns 30-40 degree angle from the normal lines of the water surface. This way can avoid the direct reflection of the sun light. L_E is approximately 0 at the time. When there is a direct sun light on a sunny day, L_{sky} is approximately 0. At this time, the signals that the spectrometer receives could be seem as the reflection signal of the water.

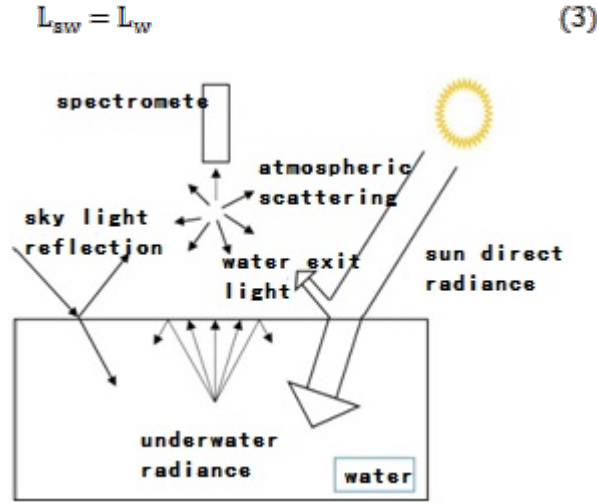

Fig. 1. Signal Composition of the Water Surface

The water reflectivity is calculated as follows.

$$R_{rs} = \frac{\pi * L_w}{E_d} = \frac{\pi * L_{sw}}{E_d} \quad (4)$$

L_{sw} is the radiance of the water surface. E_d is the incident radiation illumination that reaches the water surface.

2.2 System Composition

In the study of the water remote sensing, the reflectivity of water could be calculated by the spectrum observed. The water quality parameters such as chlorophyll-a, total phosphorus (TP), total nitrogen (TN) could be calculated further. It is very important to observe the spectrum conveniently and reliably. In this article, a water spectrum observation system is designed and implemented which is composed of the spectrum gathering terminal, the data forwarding unit and the data receiving terminal (Figure 2).

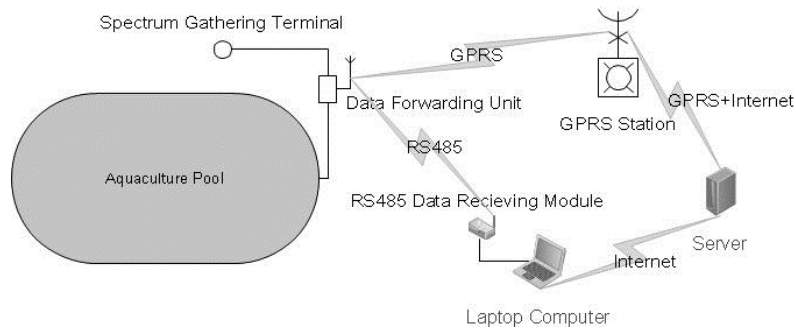

Fig. 2. Composition of the System

2.2.1 Spectrum Gathering Terminal

The spectrum Gathering Terminal consists of three sets of configurable high-precision optical sensor modules and a flash memory. When gathering the spectrum, data is backed up in the flash memory to ensure its security. The storage capacity of the memory can be configured according to the need. The data is usually held 30 days based on the system clock. The flash memory is connected with the data forwarding unit through a data line. For reducing the power consumption and improving the efficiency of the data gathering, a system sleeping function is designed. A remote instruction could be sent by the data receiving terminal to dormancy or awaken the spectrum gathering terminal. According to the characteristics of the water spectrum observation, the system acquiesced between 18pm to 6am. The spectrum gathering terminal and the data forwarding unit share a set of power supply module. The system not only could be powered by 220V power but also be powered by a solar battery. This way ensures the reliability of the system work continuously.

The different water quality parameters are associated with the spectrum of different wavelengths. For adjusting the band of spectrum observed conveniently, a removable optical sensor module is designed. Different observation bands can be configured according to the different applications. However, the optical sensor needs to be calibrated after reconfiguration each time. The spectrum gathering terminal is linked with the optical sensor through serial. There are three optical sensor extension interfaces including JP7, JP8 and JP9. Every interface is linked with a group of high-precision optical sensor module.

According the principle of water reflectivity observation, two kinds of sensor node are designed for multi-channel reflection observation system including the node for the sun downward radiation and the node for the water reflection radiation. The band configuration and electronic structure of these two kinds of node are exactly the same. The only difference between them is that there is an angle limiting device in the node for water reflection radiation which only allows the reflection of specific angle into the viewing angle. This way will minimize the interference of the reflection from the ambient light. The main function of these two kinds of node is to load the optical sensor based on I2C bus. They gather the brightness data, the observation time and the remaining power of the solar battery. At the same time, they sent these data to the data forwarding unit together. The composition of them

mainly includes sensor part, real-time clock part, serial communication part, power supply part, instrument working condition monitoring part and communication/microprocessor part (Figure 3).

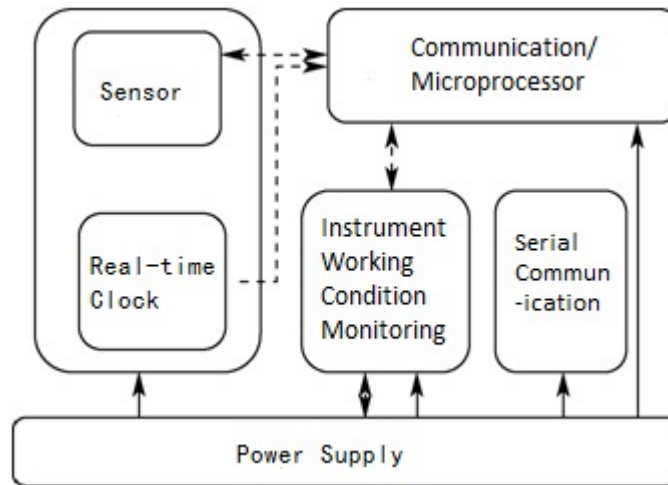

Fig. 3. Composition of the Spectrum Gathering Terminal

In the system test, the two kinds of node are adopted with the optical sensors of 680nm, 700nm and 769nm. The view angle of the water reflection radiation node is set as 25degree.

2.2.2 Data Forwarding Unit

The forwarding unit is linked with the spectrum gathering terminal through the serial communication. It transmits the real-time spectrum and other data from the flash memory of the spectrum gathering terminal to the remote data receiving terminal through GPRS and RS485 wireless protocol. Two kinds of data forwarding method are designed for the need of both field and remote data processing (Figure 4).

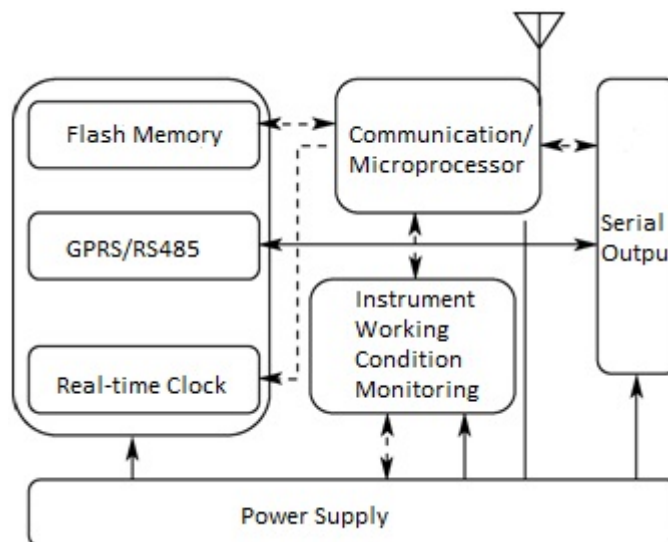

Fig. 4. Composition of the Data Forwarding Unit

There is a RS485 data sending module with a long-distance antenna integrated in the communication unit. The Operator can check the spectrum in real-time within 100 meters of the spectrum gathering terminal through a computer equipped with a RS485 receiving module. Then the data could be dealt with and analyzed. The

adjusting plan of the water quality could be made at site. In some isolated and the GRPS coverage not perfect aquaculture ponds, this data forwarding way is more reliable and the real-time performance of the spectrum observation is also stronger.

The GPRS unit goes into the mobile communication network through a SIM card. Then it forwards the spectrum and other data to the remote data server through the mobile communication network. The operator could visit the data server through the client software on any computer on the web. Then the data could be dealt with and analyzed in order to help the people at site to make a adjusting plan of the water quality. This kind of data forwarding mode is mainly faced with the manager or supervision departments outside the production line. There is also a flash data memory unit to cache part of data from the spectrum gathering terminal when the GPRS module works unusually. This way could ensure the integrity of the data while the spectrum could not be forwarded to the remote server in time.

2.2.3 Data Receiving Terminal

The data receiving terminal includes the remote data sever and the data analyzing software client. The system uses the Microsoft Windows Server and the SQL Server platform. The storage structure of the spectrum is shown in the Table 1.

ID	Pond Code	Observation Time	Band 1	Band 2	Band 3
----	-----------	------------------	--------	--------	--------

Table 1. Data Structure

The client software can receive data through two ways. When the data is received at site, the RS485 data receiving module is converted into RS232 serial communication by the conversion mode. At the same time, the client software is set as the serial communication mode and the spectrum could be read in through the serial port directly. When the data is received remotely, the client software is set as the server visiting mode. The data could be read in from the database by visiting the remote data server. The real-time and historical data can all be checked through this client software, and the water reflectivity could be computed based on the formula 4. In the data analyzing module, the chlorophyll-a, TN and TP could be estimated. At present, this module only reserves the program interface. These applications can be developed and integrated according to the business needs. The Structure of the client software is shown as the Figure 5.

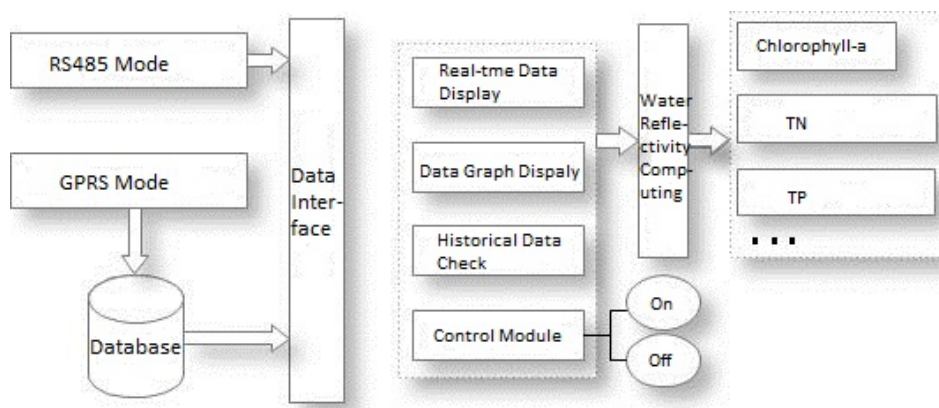

Fig. 5. Structure of the Client Software

The client software uses the VC2010 development platform, and the interface is easy to operate (Figure 6).

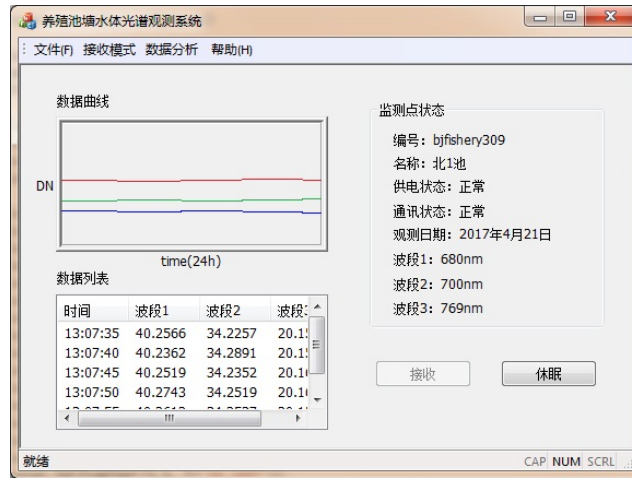

Fig. 6. Interface of the Client Software

3 Results and Analysis

In order to test the performance of the system and evaluate the reliability of the system to observe the water spectrum quantitatively, 5 aquaculture ponds for sturgeon in Beijing are selected as the water observation samples. In sunny and partly -cloudy condition, the FieldSpec HH spectrometer of ASD company is used to observe the spectrum of this 5 samples in synchronism.

3.1 Working Performance of the system

The optical channel of the three groups of sensor is tested, and the observation data is analyzed to check the data consistency among different channels. At the same time, the responsiveness of the high-precision optical sensor is verified under the changeable condition of solar illumination in one day.

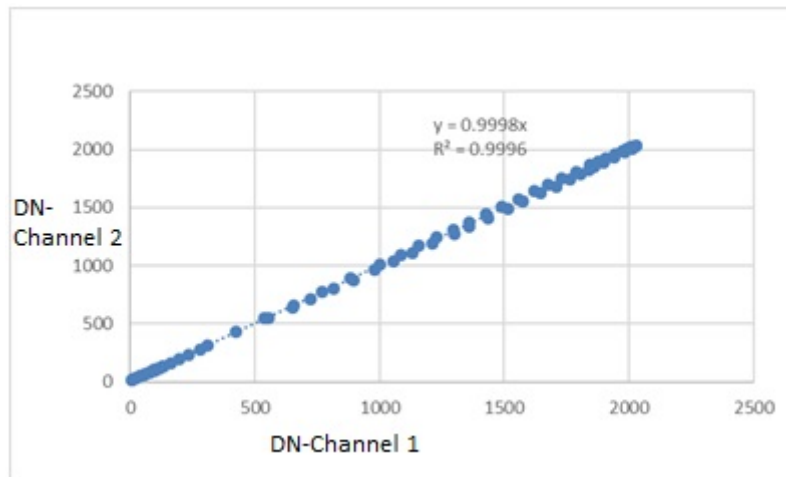

Fig. 7. Data Consistency between Channel 1 and Channel 2

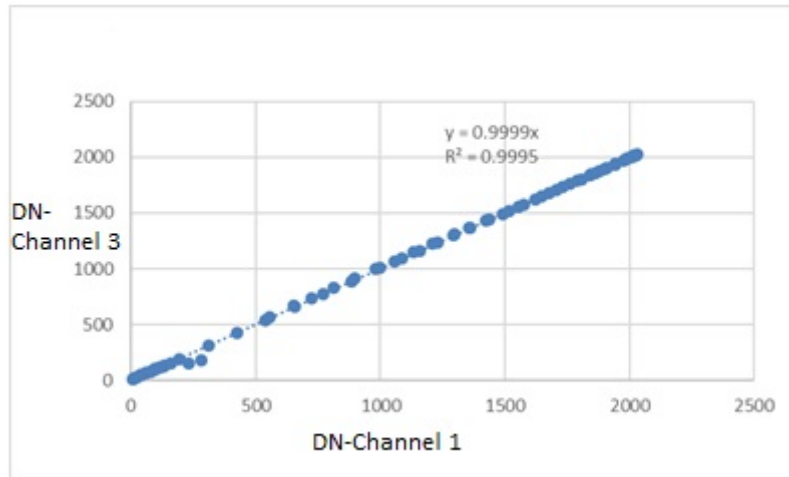

Fig. 8. Data Consistency between Channel 1 and Channel 3

Through the analysis of the data scatter diagram (Figure 7, Figure 8), the data consistency among different channels is very good. The decision coefficient is 0.9995 and the slope of different data regression straight line is very close to 1. The result shows that there is nearly no deviation between the measurements by these three different sensors.

In order to test whether the data transmission of the sensors is stable, the change curve of these three channels of the sensors in one day is made (Figure 9). An analysis is taken to find that whether the change of the observation data is consistent with the solar illumination curve, which can determine whether the data is unstable.

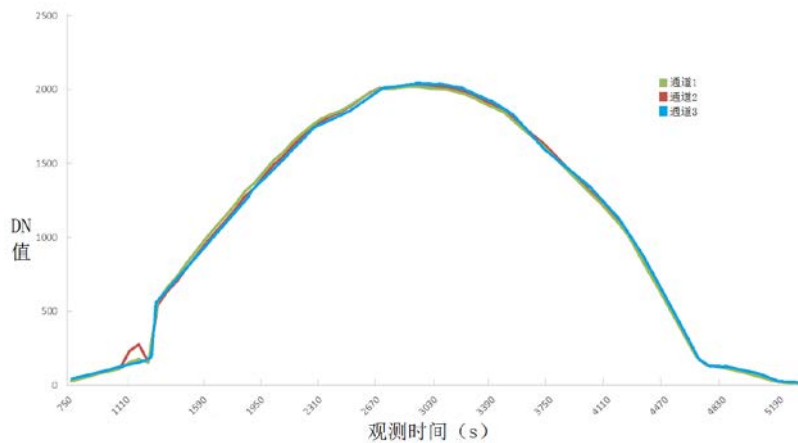

Fig. 9. Time-variation Analysis of the Light Intensity Measurement

Usually, under the clear air condition, the change of radiation value from the sun to the earth is related to the cosine function of the sun's vertical angle, which means that the data will be lowest in the morning and evening, but it will be highest in the noon. There is a similar cosine curve showed in the figure 9. Data is very stable in the rest time of one day except a slightly different in the morning. The curve is smooth and with no data missing, and the rate of the date reception reaches 100%. It indicates that the data transmission of the system is stable and the system could be used for continuous observation in time series.

3.2 Spectrum Observation of the Water

The center wavelength of the sensor filter is set as 680nm, 700nm and 769nm separately. The bandwidth of the filter is 3nm. The FieldSpec HH measures the continuous spectrum from 350nm to 1050nm, and its spectral resolution is also 3nm. The view angle of the reflection radiation observation node is 25 degree which is as the same as the spectrometer. This way ensures the reliability of the data alignment.

The time series observation is taken for the NO.1 ponds. The system observes spectrum at intervals of one hour from 10am to 14pm. The observation by the spectrometer is taken synchronously. 50 groups of data are gathered to check the reliability of the data for the same observation sample under different lighting conditions.

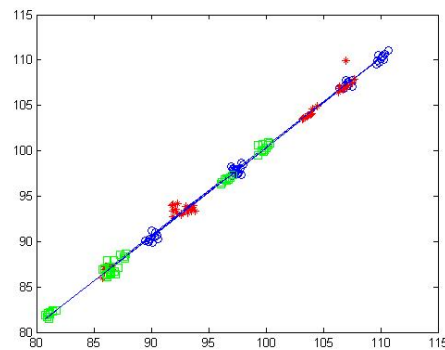

Fig. 10. Reliability Analysis of the Time Series Observation Data

The radiation angle and intensity of the solar will change as the time changes. The Fig.10 shows that the observation results of the system and the spectrometer both accord with the same law. The result describes a linear relationship and the imitation between them is good enough. The fit coefficient reaches to 0.9882. The result verifies the reliability of the system in the time series spectrum observation.

Synchronous observation is taken at five different aquaculture ponds. There are several different observation positions of the five ponds, including the filter tank, the feeding platform, the water outlet, the intake and the oxygen pump. The water quality of these positions is usually different. Five spectrum gathering terminals are activated at 10.30am and observe 10 groups of spectrum separately. Synchronous observation is taken at these positions by spectrometer at the same time. 50 groups of data are gathered to check the reliability of the data for the different observation sample under the same lighting conditions.

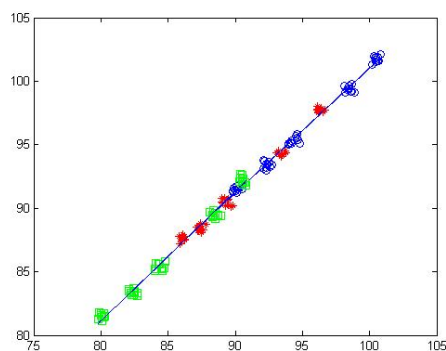

Fig. 11. Reliability Analysis of the Different Object Observation Data

For different aquaculture ponds, the water quality of these areas is usually different due to the observation points set in the different functional areas. The Fig.11 shows that there are also some data differences in the spectral performance. But the difference change has a highly linear relationship between the system and the spectrometer. And the imitation between them is good enough. The fit coefficient reaches to 0.9876. The result verifies the reliability of the system in the different object spectrum observation.

4 Conclusions

In conclusion, a real-time spectrum of specific band observation system for aquaculture pond water is designed and implemented in this article. The observation data achieves the effect of the data by spectrometer. At the same time, the system helps to get rid of the locked artificial observation program and the fault that spectrometer cannot take the real-time observation continuously. The using cost of the system is much low and the multi-point networked synchronous observation could be realized in the aquaculture area. The continuous accurate real-time observation data of the water spectrum provides the basis for the data analysis and the quality parameters evaluation of the aquaculture pond. The system could customize the spectral band for the main water quality parameters based on the analysis and modeling of remote sensing observation data on ground. Then the system could achieve a timely and accurate quantitative assessment for the water quality parameters of the aquaculture pond which will be of great significance to warn and control the change of water quality in aquaculture production.

Reference

- 1 L Feng, C Hu, X Han, X Chen, L Qi, Long-Term Distribution Patterns of Chlorophyll-a Concentration in China's Largest Freshwater Lake: MERIS Full-Resolution Observations with a Practical Approach [J], Remote Sensing, 2014, 7(1): 275-299.
- 2 K Ryan, K Ali, Application of a partial least-squares regression model to retrieve chlorophyll-a concentrations in coastal waters using hyper-spectral data [J], Ocean Science Journal, 2016, 51(2): 209-221.
- 3 L Wang, H Pu, DW Sun, Estimation of chlorophyll-a concentration of different seasons in outdoor ponds using hyperspectral imaging [J], Talanta, 2016, 147: 422-429.

- 4 Y Sakuno, K Hatakeyama, Y Miyamoto, A Hatsuda, et al., Relationship between spectral reflectance and chlorophyll-a concentration in the eutrophic Lake Togo-ike [C], Proceedings of SPIE - The International Society..., 2014, 9240:92400H-92400H-7.
- 5 E Choe, JW Lee, SU Cheon, Monitoring and modelling of chlorophyll-a concentrations in rivers using a high-resolution satellite image: a case study in the Nakdong river, Korea [J], International Journal of Remote Sensing, 2015, 36(6): 1645-1660.
- 6 Abd-Elrahman, A., et al., In situ estimation of water quality parameters in freshwater aquaculture ponds using hyper-spectral imaging system [J], ISPRS Journal of Photogrammetry and Remote Sensing, 2011, 66(4): 463-472.
- 7 Thiemann S, Kaufmann H. Determination of Chlorophyll Content and Tropic State of Lakes Using Field Spectrometer and IRS-1 C Satellite Data in the Mecklenburg Lake District, Germany[J]. Remote Sensing of Environment , 2000, 73 :227-235
- 8 Pulliainen J. Kallio K. Eloheimo K, et al. A Semi-operative Approach to Lake Water Quality Retrieval from Remote Sensing Data [J]. The Science of the Total Environment, 2001, 268 :79-93 .
- 9 K. Ya. Kondratyev, D. V. Pozdnyakov, L. H. Pettersson. Water quality remote sensing in the visible spectrum[J]. International Journal of Remote Sensing, 1998, 19(5):957-979.
- 10 Wei K L, Wen Z Y, Wu X, et al. [Research advances in water quality monitoring technology based on UV-Vis spectrum analysis][J]. Spectroscopy & Spectral Analysis, 2011, 31(4):1074.
- 11 Liu Z. Application of a water quality monitoring instrument based on UV-vis spectroscopy[J]. Water Resources Protection, 2008.
- 12 Dipl.-Phys K H M, Gitel'Son A A, Lopatchenko A A, et al. In-situ Monitoring of Water Quality on the Basis of Spectral Reflectance. Ship-borne Experiments for the Development of Remote Sensing Algorithms Especially for the Estimation of Algae Content in Natural Waters[J]. Internationale Revue Der Gesamten Hydrobiologie Und Hydrographie, 1988, 73(1):61-72.
- 13 A. GITELSON. The peak near 700 nm on radiance spectra of algae and water: relationships of its magnitude and position with chlorophyll concentration[J]. International Journal of Remote Sensing, 2007, 13(17):3367-3373.
- 14 Gong C L, Yin Q, Kuang D B, et al. Study on the spectral reflectivity models of different water quality parameters in Huangpu river[J]. Journal of Infrared & Millimeter Waves, 2006, 25(4):282-286.
- 15 Vinciková H, Hanuš J, Pechar L. Spectral reflectance is a reliable water-quality estimator for small, highly turbid wetlands[J]. Wetlands Ecology & Management, 2015, 23(5):933-946.