



**HAL**  
open science

# Design of Automatic Cutting and Welding Machine for Brake Beam-Axle

Leping Liu, Mingdong Zhong, Qizheng Dong

► **To cite this version:**

Leping Liu, Mingdong Zhong, Qizheng Dong. Design of Automatic Cutting and Welding Machine for Brake Beam-Axle. 4th Conference on Computer and Computing Technologies in Agriculture (CCTA), Oct 2010, Nanchang, China. pp.167-176, 10.1007/978-3-642-18369-0\_18 . hal-01564815

**HAL Id: hal-01564815**

**<https://inria.hal.science/hal-01564815v1>**

Submitted on 19 Jul 2017

**HAL** is a multi-disciplinary open access archive for the deposit and dissemination of scientific research documents, whether they are published or not. The documents may come from teaching and research institutions in France or abroad, or from public or private research centers.

L'archive ouverte pluridisciplinaire **HAL**, est destinée au dépôt et à la diffusion de documents scientifiques de niveau recherche, publiés ou non, émanant des établissements d'enseignement et de recherche français ou étrangers, des laboratoires publics ou privés.



Distributed under a Creative Commons Attribution 4.0 International License

# Design of Automatic Cutting and Welding Machine for Brake Beam-Axle

Leping Liu<sup>1</sup>, Mingdong Zhong<sup>2</sup>, Qizheng Dong<sup>3</sup>

Key Laboratory of Ministry of Education for Conveyance and Equipment,

East China Jiaotong University, Nanchang 330013, China

Email: <sup>1</sup>jxllp@163.com, <sup>2</sup>zhongmd168@126.com,

<sup>3</sup>dongqizheng205@yahoo.com.cn

**Abstract.** Brake beam is one of the important components working in railway vehicles braking process, which directly affects the security and stability of the high-speed running railway vehicles. Through the research of the cutting and welding technology for the 209T straight plate type brake beam, this paper presents an advanced maintenance method, and designs an automatic cutting and welding machine for the brake beam-axle, then studies the basic structure and working principle for the machine in detail. The automatic cutting and welding machine has been operating properly since been used in the maintenance workshop. What is more, the maintenance of each brake beam only spends about 15 minutes, so this advanced maintenance method can improve the efficiency of the maintenance appropriately, and ensure the reliability of maintenance quality.

**Keywords:** Brake beam-axle; Maintenance; Automatic cutting; Automatic welding

## 1. Introduction

Brake beam is an important component of the foundation brake rigging in railway vehicle bogie. And it is the essential device to ensure the security of the high-speed running train [1]. The 209T type brake beam withstands braking force repeatedly, and its end axles are abraded seriously, which connect with the railway vehicle's brake shoes [2]. Due to the 209T type brake beam's being widely used in the raising speed passenger train in china, its maintenance quality is crucial to the security of passenger train. In the traditional process of brake beam maintenance, the brake beam-axle is

replaced by manual cutting and welding [3]. In this case, the welding fume, dust and radiation endanger health of the workers severely [4]. What is more, the cutting gap is not smooth, and it is difficult for workers to control the welding seam track.

Based on the theoretical calculations, J.N. Chen [5] has analyzed the brake beam by using finite element software, and the simulation result has accorded with the theory calculations. Other authors, such as Y.P. Tang [6] and his colleagues, have focused on designing the numerical control system for automatic welder, which is used for brake beam of railway vehicle. Over the past years, welding robots are employed as substitutes for workers even in some developed vehicle depots, but it means high cost for most vehicle depots in china [7]. So we design an automatic cutting and welding machine for the brake beam-axle, which aims at solving the problem that the traditional maintenance method can not ensure the reliability of maintenance quality for break beam. Previous relevant researches [8, 9] have provided a certain reference for the design of automatic cutting and welding machine. The advanced machine improves the efficiency of the maintenance appropriately, and gives full play to the advantages of the computer numerical control system with high precision, good stability, and simple operation.

## 2. Maintenance process analysis for end axle

### 2.1 Maintenance process requirements of brake beam

The 209T type brake beam is composed of two end axles, two groups of pulling boards and a brake beam body. And the end axle consists of cylinder and cone. The cylinder's diameter is  $\phi 55_{-0.49}^{+0.19}$  mm. The large end of the cone's diameter is  $\phi 70_{-1}^{+1}$  mm. In addition, the cone is welded with the brake beam body, which thickness is  $20_{-1}^{+1}$  mm. The overall structure of 209T type brake beam is shown in Fig. 1.

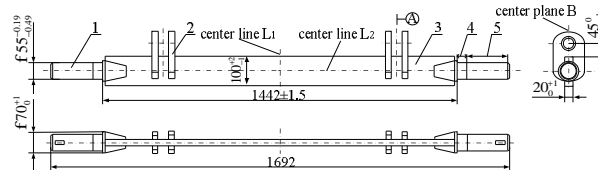

1 end axle; 2 pulling board; 3 brake beam body; 4 sleeve gasket working surface; 5 brake shoe working surface.

Fig.1. The structure diagram of 209T type brake beam

Due to sleeve gasket working surface of end axles being protected effectively by the sleeve gaskets, they are not abraded. However, the brake shoes working surface are abraded seriously. Then the maintenance process of 209T type brake beam must meet the following requirements:

- Dimensional Precision (as shown in Fig. 1).
- Position Precision

The symmetry error of two end axles should be less than 0.5 mm in the direction of thickness of the brake beam body, and their perpendicularity error that takes for reference with plane A should also be less than 0.5 mm. In addition, the permissible error of coaxiality for two end axles should be less than 1mm. Finally, the two groups of pulling boards take center line L1 for their symmetrical line.

- Tensile Strength

The repaired brake beam must take repeated tensile stress test, and permanent deformation can not emerge.

- Abrasive Hardness

The carburized depth of end axle must reach 0.8~1.5 mm, and Rockwell hardness of the cylindrical surface should reach HRC40~55.

## 2.2. Key technology for maintenance process

First, the maintenance process is not only the welding process, it must be in accordance with following technological process: “locating and clamping the worn brake beam → cutting the worn end axles → locating and clamping the new end axles → welding.” As is shown in Fig. 2, the brake beam body should be welded with the new end axles in double-side; furthermore, their welding trace must follow the cutting trace appropriately. Therefore, it is significant to apply the numerical controlling method to control the welding trace.

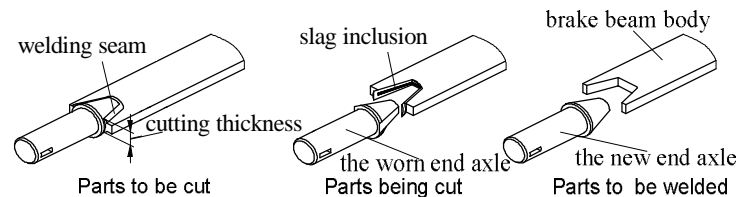

Fig.2. The maintenance process of 209T type brake beam

In addition, there are many serious technological problems in traditional process, such as lack of fusion, incomplete penetration and slag inclusion. In this case, there will exist potential danger in the high-speed running passenger trains. Accordingly, reasonable cutting and welding process parameters must be adopted to reduce this sort of defects.

Finally, serious welding heat deformation occurs frequently in the traditional maintenance process. And its coaxial error can not meet the process requirement. Thus, a locating and clamping device must be adopted to prevent the welding heat deformation efficiently.

### **3. Scheme design of automatic cutting and welding machine**

#### **3.1. Technical scheme of automatic locating and clamping**

##### *3.1.1. Locating the brake beam body*

As is shown in Fig. 1, the brake shoes' working surface is abraded seriously. However, sleeve gasket working surface of end axles are unworn. In this case, sleeve gasket working surface and end-face of the cone can be used as automatic cutting and welding location datum. Therefore, the locating device of automatic cutting and welding machine can find the center line L1, L2 and center plane B rapidly, and locate the brake beam body accurately [10].

##### *3.1.2. Clamping the brake beam body*

To cut the worn end axles and weld the new end axles accurately, the brake beam must be clamped stably. As is shown in Fig. 2, the worn end axles will be cut after locating the brake beam body accurately, so they can not be used as clamping parts. In contrast, the plane B exists as the center plane of the brake beam body in the direction of thickness during the whole maintenance process. Thus, the plane B can exist as datum plane for locating and clamping the brake beam body. And the automatic centering mechanism can achieve this function appropriately.

##### *3.1.3 Locating, clamping and rotating device*

The end axle can be located on the V-shape block by outside column surface accurately. What is more, the device can achieve several functions for the new end

axle, such as locating, clamping and rotating. Accordingly, the welding process of new end axle is carried out with the following steps. First, the new end axles must be located and clamped by the device accurately. Then, the drive boxes take the new end axles to the accurate welding position, and the new end axles are welded with brake beam body in single-side. Finally, the rotational device turns the brake beam over by 180°, and the new end axles are welded with brake beam body on another side. And the mechanical structures of automatic cutting and welding machine are shown in Fig.3.

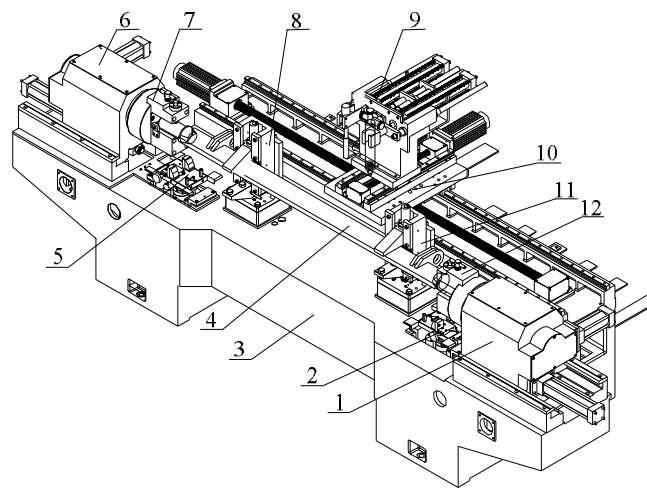

1,6 drive box; 2,5 bracket; 3 machine tool bed; 4 brake beam; 7,12 rotational device; 8,11 clamping device; 9 automatic cutting and welding device; 10 moving workbench.

Fig.3. The mechanical structures of automatic cutting and welding machine

### 3.2 Technical scheme of automatic cutting

There are many kinds of thermal cutting methods for practical application, such as plasma cutting, oxyacetylene cutting and laser cutting. Unfortunately, due to the high cutting cost, laser cutting is not suitable to be adopted in domestic vehicle depots. In this case, the appropriate cutting method must be chosen between plasma cutting and oxyacetylene cutting.

Plasma cutting is applied extremely widely in the steel plate cutting industry, such as cutting carbon steel, stainless steel, aluminum, copper and other metal materials

[11]. The local melt of steel is carried out by the high temperature plasma arc, and molten metal is blown away by the high speed plasma jet.

Oxyacetylene flame is suitable for cutting low-carbon steel materials. First, the oxyacetylene flame preheats the metal to its igniting temperature, and then the metal is burned violently in the high temperature oxygen stream. The molten slag is blown away by the high pressure oxygen stream. Afterwards, the metal is preheated under the combined action of the heat of oxyacetylene flame and combustion heat. Obviously, this process continues until the steel plate is cut down.

As the material of brake beam and welding seam is low-carbon steel, in this case, both oxyacetylene flame and Plasma can be adopted to cutting the worn end axles. However, the thickness of brake beam body is 20 mm, and the single-side thickness of welding seam is about 5~10 mm. Accordingly, the actual cutting thickness is almost about 30~40 mm. As is shown in Fig. 4, when the cutting thickness is more than 30mm, the cost of plasma cutting will be increasing rapidly, especially compared with oxyacetylene cutting. This is because that the expensive dedusting system must be adopted during the plasma cutting. From the economic aspect, the oxyacetylene cutting takes priority over plasma cutting.

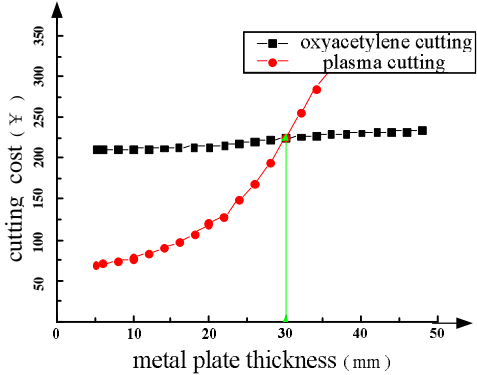

Fig.4. Cutting cost curve of plasma and oxyacetylene

As is shown in Fig. 5, when the cutting thickness is less than 30 mm, the speed of plasma cutting is significantly faster than that of oxyacetylene cutting, otherwise, it decreases dramatically. In contrast, the cutting speed curve of oxyacetylene is nearly level.

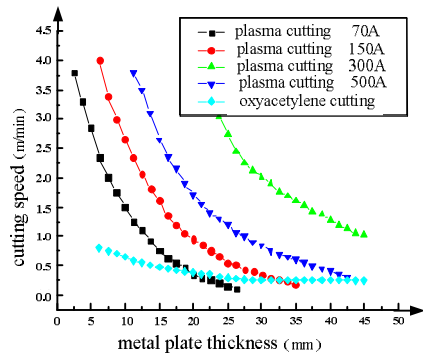

Fig.5. Cutting speed curve of plasma and oxyacetylene

In view of the cutting efficiency and cutting cost, low-carbon steel thickness below 30~40mm is suitable for oxyacetylene cutting. Consequently, oxyacetylene flame cutting is adapted appropriately to cutting the worn end axles.

### 3.3 Technical scheme of automatic welding

The brake beam is located at the bottom of railway vehicle, although it is cleaned before maintenance, its surface is still covered with rust and dirt. However, the carbon dioxide arc welding is insensitive to rust. What is more, it is very suitable for automatic welding with the excellent welding process, including high welding speed and excellent weld appearance quality.

In addition, the trapezoid slot of brake beam body has a low forming precision, because of the oxyacetylene flame cutting. And the preset welding gap between the brake beam body and the new end axle is almost about 3~4 mm. In this case, the welding trace must follow a short and tortuous path (as shown in Fig. 6) according to our experiment results.

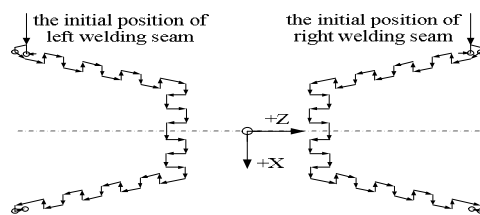

Fig.6. The welding path of new end axles



## 4. Main cutting and welding parameters

The cutting parameters have a great influence on cutting quality, such as heat affected zone, cutting width, cutting dross and roughness. And the optimal cutting parameters can be determined by orthogonal experimental design, and suitable for the balanced pressure cutting nozzles, as shown in Table 1. Similarly, the main welding parameters such as welding current, arc voltage and welding speed have been optimized by the orthogonal test. The inverter CO<sub>2</sub> welding machine's type is NB-350K. And its optimal parameters are shown in Table 2.

**Table 1** The optimal cutting parameters

Nozzles	Thickness ( mm )	Speed ( mm/min )	Gas pressure ( Mpa )		Gas consumption ( m <sup>3</sup> /h )	
			Oxygen	Acetylene	Oxygen	Acetylene
1	30~40	320	0.5	0.07	2.5	0.34
2	30~40	280	0.65	0.07	3	0.47

**Table 2** The optimal welding parameters

Weld modes	Current	Voltage	Welding spot size	Speed
	( A )	( V )	( mm )	( mm/min )
Spot weld	190	21	15~20	—
First weld layer	210	23	continuous	400
Second weld layer	250	27	continuous	400

## 5. System design of automatic cutting and welding machine

### 5.1 System design

The automatic cutting and welding machine is shown in Fig. 7. It is composed of machine tool bed, drive boxes, cross-type moving workbench, automatic cutting and welding device, clamping devices, brackets, hydraulic system, numerical control system and welding controller. And the cutting gun and welding torch are installed on the automatic cutting and welding device, which is located at moving workbench.

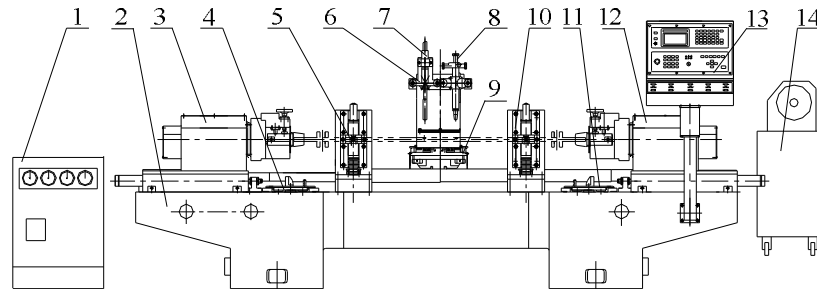

1 hydraulic system; 2 machine tool bed; 3,12 drive box; 4,11 bracket; 5,10 clamping device; 6 automatic cutting and welding device; 7 welding torch; 8 cutting gun; 9 moving workbench; 13 numerical control system; 14 welding controller.

Fig.7. The system design of automatic cutting and welding machine

## 5.2 Working principle

The whole technological processes have been identified as follows: To lift brackets to the locating position, and locate the brake beam roughly by center line  $L_1$  and  $L_2$  → To clamp the brake beam body and locate it precisely by center plane B → To retract the brackets → To cut the worn end axles → To clamp the new end axles → To spot-weld the new end axles with brake beam body (As shown in Fig. 8) → To weld the new end axles in single-side → To unclamp the clamping devices and turn the brake beam over by  $180^\circ$  → To weld the new end axles in another side → To unclamp all clamping devices and take down the repaired brake beam.



Fig.8. Automatic welding device in operation

### 5.3 Main technical parameters

Main technical parameters of the automatic cutting and welding machine have been identified as follows:

- Stroke of moving workbench
    - In the direction of X axis: 300 mm;
    - In the direction of Z axis: 1600 mm.
  - Stroke of drive box: 200 mm;
- Rotation angle:  $180^\circ$  .
- Cutting speed: 280 mm/min.
  - Welding speed: 400 mm/min.
  - The total power: 24 KW.

### 5.4 Experimental verification

There is no permanent deformation after the repaired brake beam takes repeated tensile stress test. As is shown in Fig. 9, the pulling force acting at each group of pulling boards is 35 kN [12]. In addition, tensile stress tests show that the tensile strength of repaired brake beam has completely reached the process requirement.

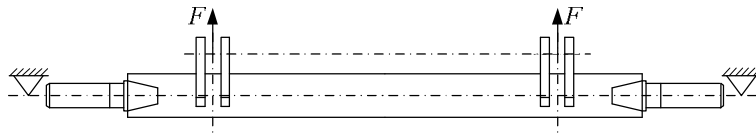

Fig.9. Repeated tensile stress test

The curves of coaxiality under different process conditions are shown in Fig. 10, and coaxiality of improved process is less than the permissible error. These results indicate that the advanced maintenance method is feasible to control the error of coaxiality, and the improved process takes obvious priority over original process.

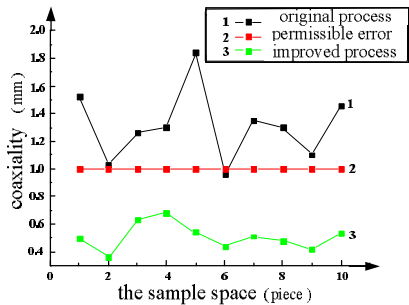

Fig.10. Curve diagram of coaxiality under different process conditions

## 6. Conclusions

An automatic cutting and welding machine for the brake beam-axle, to be employed in a vehicle depot, was designed. This maintenance process has the advantages of convenient clamping and accurate locating. This designed machine was set up and tested, and experimental results show that the designed machine is appropriate for practical application. After refitting the clamping device and changing the control program, this automatic cutting and welding machine could be applied to the field of maintenance for the similar type brake beam. The application of such low-cost automatic cutting and welding machine, which is urgently needed in many vehicle depots in China, not only improves the efficiency and maintenance quality, but also protects the operators from hazardous circumstances.

## References

1. Wang H.Z., Wang H. and Shang Y.J.: Strength character research on brake beam for type of 209 bogie. *Journal of Lanzhou Jiaotong University*.Vol.28, 121-123(2009).
2. Song H.L.: Technological measures to guarantee the coaxiality for brake beam. *Railway Locomotive & Rolling Stock Workers*.No.7, 10-13(1998).
3. Wang R.J. and Wang S.: Investigation and analysis on problems existing in inspection and repair of brake beams. *Rolling Stock*.Vol.39, 26-27(2001).
4. Li G.Y., Dong M.D. and Zhao J.Y.: Design and practice of new type pneumatic control

- system for trunk brake beam electric welding workshop. *Hydraulics Pneumatics & Seals*.No.5, 46-47, (2001).
5. Chen J.N.: Finite Element Analysis for Brake Beams. *Journal of Rolling Stock*. Vol.1, 30-33, (2000).
  6. Tang Y.P., Wang J.M. and Feng Q.X.: Automatic welder based on DSP motion control card for van brake beam. *Manufacturing Technology & Machine Tool*. No.2, 35-37, (2005).
  7. Xin H.B.: Application of Welding robot in Manufacture of Bogie frame. *Journal of Machinist Metal Forming*. Vol.24, 53-55 (2008).
  8. Fu P.X.: Application Research on Automatic Cutting and Welding process for Brake Beam-Axle. *Shanghai Railway Science & Technology*. Vol.1, 21-23, (2008).
  9. Zhou L.: Design and analysis of multi-function auto-welding machine tool control system. *Machine Tool Electric Apparatus*. Vol.3, 60-61, (2009).
  10. Di R.K., Fan X.H., and Fan X.Y.: *Mechanical Manufacture Engineering*. Zhejiang University Press. Hang Zhou, China, (2001).
  11. Hang Z.X., Ma X.Z., and Ma Y.J: Position of plasma cutting in thermal cutting methods. *Journal of Shenyang University of Technology*. Vol.21, 479-481(1999).
  12. Railway Ministry of the PRC, *Load Test Methods for TB/T 1978-2007 Brake Beams*. China Railway Press. Beijing, China,(2007).