



HAL
open science

Un modèle de BRDF bi-échelle combinant : Diffraction et Micro-facettes

Nicolas Holzschuch, Romain Pacanowski

► **To cite this version:**

Nicolas Holzschuch, Romain Pacanowski. Un modèle de BRDF bi-échelle combinant : Diffraction et Micro-facettes . Journée "Tout sur les BRDF", Jun 2017, Poitiers, France. hal-01545440

HAL Id: hal-01545440

<https://inria.hal.science/hal-01545440v1>

Submitted on 23 Jun 2017

HAL is a multi-disciplinary open access archive for the deposit and dissemination of scientific research documents, whether they are published or not. The documents may come from teaching and research institutions in France or abroad, or from public or private research centers.

L'archive ouverte pluridisciplinaire **HAL**, est destinée au dépôt et à la diffusion de documents scientifiques de niveau recherche, publiés ou non, émanant des établissements d'enseignement et de recherche français ou étrangers, des laboratoires publics ou privés.

Copyright

Un modèle de BRDF bi-échelle combinant Diffraction et Micro-facettes

Nicolas Holzschuch & Romain Pacanowski

Journée “Tout sur les BRDF”
Poitiers 15 Juin 2017

Realistic Image Synthesis



Realistic Image Synthesis



Realistic Image Synthesis



Lots of BRDF Models

SGD [Bagher et al. 2012]

GGX [Walter et al. 2007]

Ashikmin & Shirley [2000]

He et al. [1991]

Ashikmin et al. [2000]

Neumann and Neumann [1996]

Lafortune et al. [1997]

ABC [Löw et al. 2012]

Cook & Torrance [1982]

Ward [1992]

Hanrahan & Kruger [1993]

Blinn [1977]

Beard-Maxwel [1973]

Oren & Nayar [1994]

Granier & Heidrich [2003]

Schlick [1994]

Student-t [Ribardière et al. 2017]

AND MANY MORE !!!!!

Few BRDF Measurements Database

- MERL Data Base:
 - 100 materials
 - 2 versions: 2003 and 2006

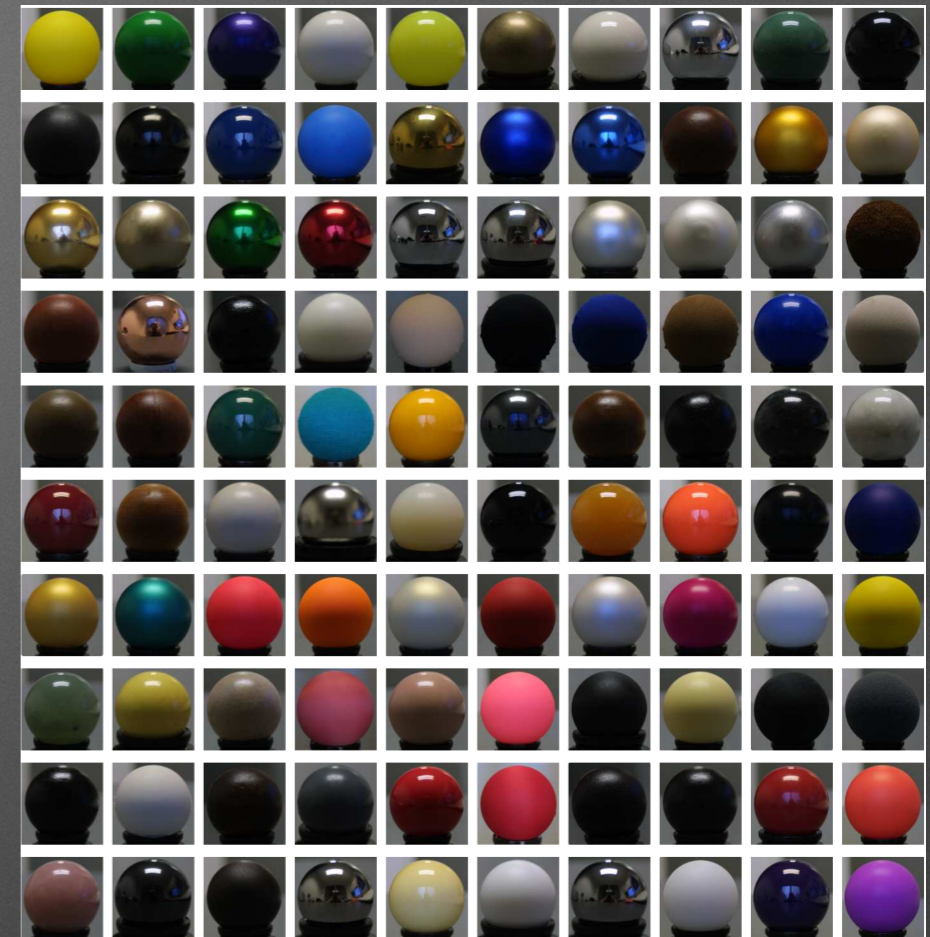

Cornell



Curet

BRDF Model comparisons

Study of fitting capabilities of BRDF Models [Ngan2005]

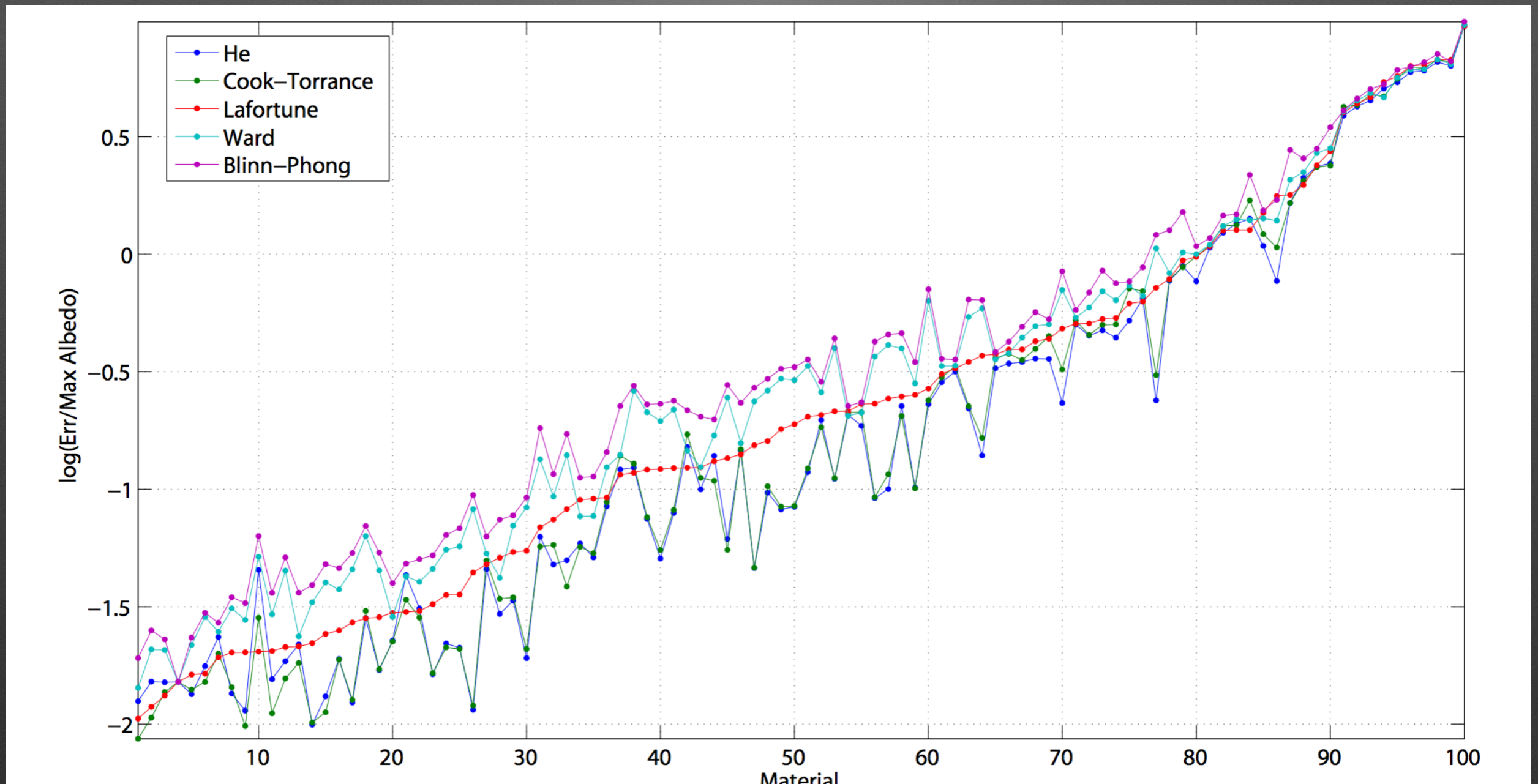

Winners: Cook-Torrance [1982] **and** A simplified version of He et al. [1991]

Closer Look on BRDF Measurements

- Microfacet Theory
 - Good prediction of Specular peak
 - Less Good for low values

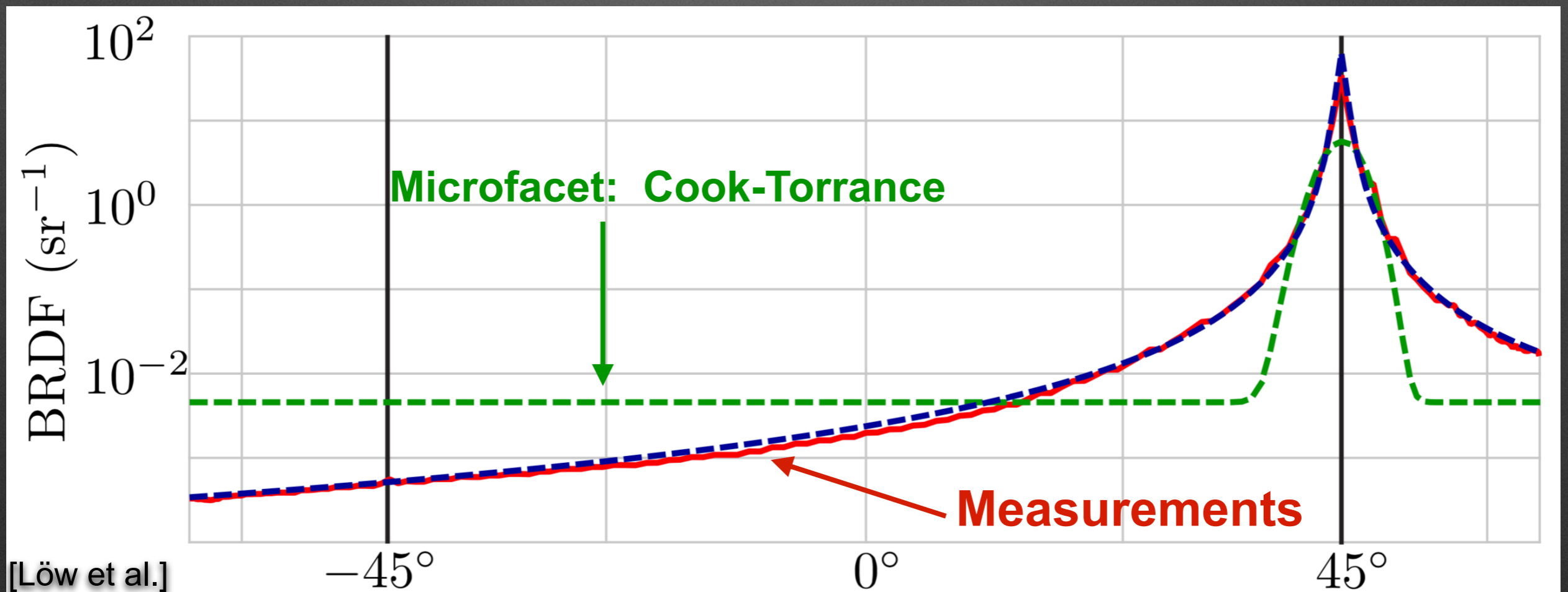

Closer Look on BRDF Measurements

- Microfacet Theory
 - Good prediction of Specular peak
 - Less Good for low values
- Common solution:
 - To add a constant or diffuse term
 - For subsurface scattering behavior of the material
 - To add new lobes ==> **No Physical Reality**

Closer Look on BRDF Measurements

Nickel from MERL database

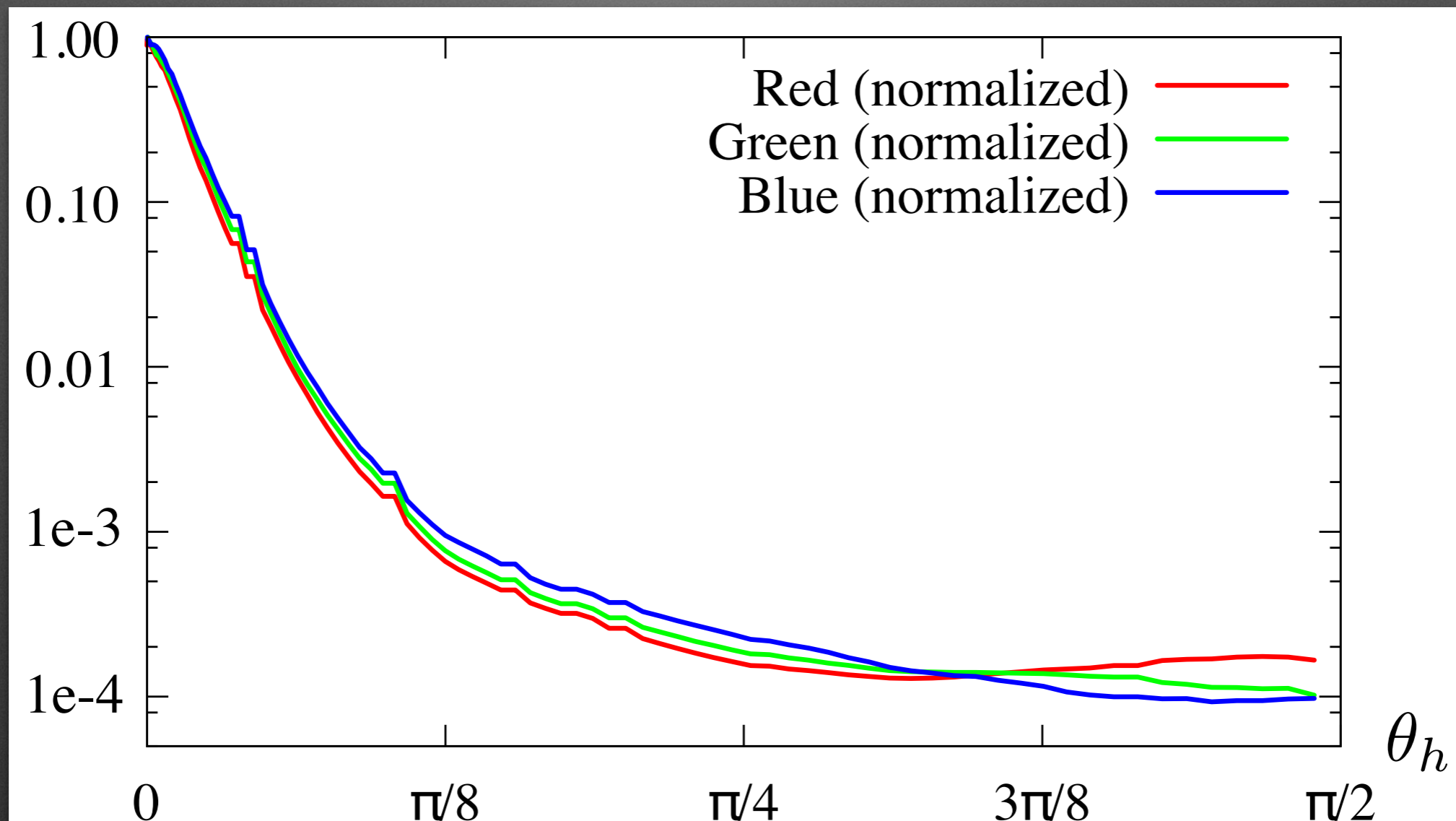

Lobe Size depends of the color

Closer Look on BRDF Measurements

$\lambda = 3,39$ microns

$\lambda = 10,6$ microns

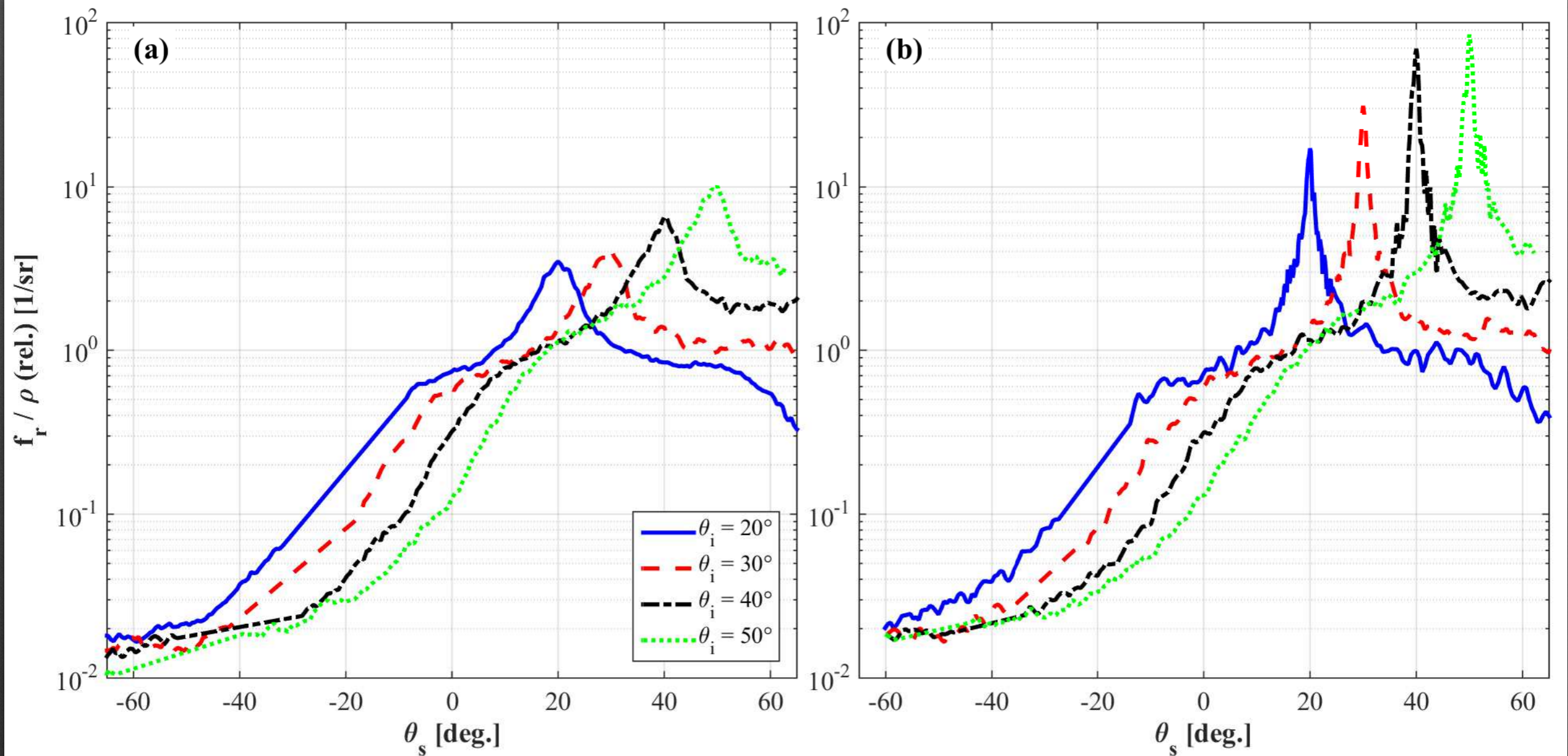

Grit-Blasted Nickel

[Butler et al. 2015] (SPIE Imaging Spectrometry)

Observations on Measurements

- Specular lobe
 - Wavelengths light Dependency
- ⇒ **Contradicts** Microfacet Theory

Microfacet Hypothesis



- Microfacet: Perfect Mirror with a Fresnel Coefficient
- Microfacet $\gg \lambda =$ light wavelength
 - Geometrical Optics
- Fresnel is the only wavelength dependent term
- How can we model this phenomenon?

Two-Scale Reflectance Model

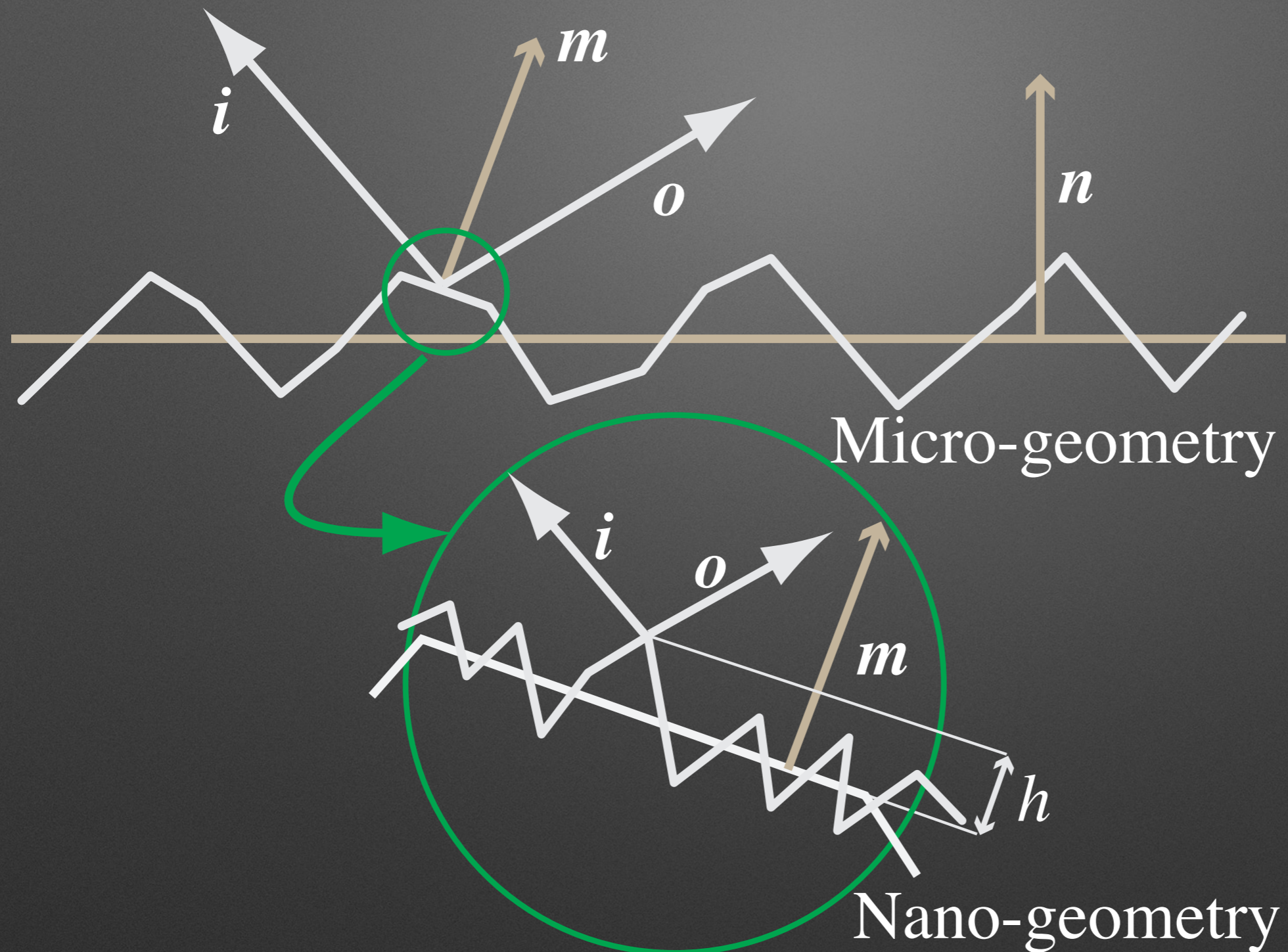

Two-Scale Reflectance Model

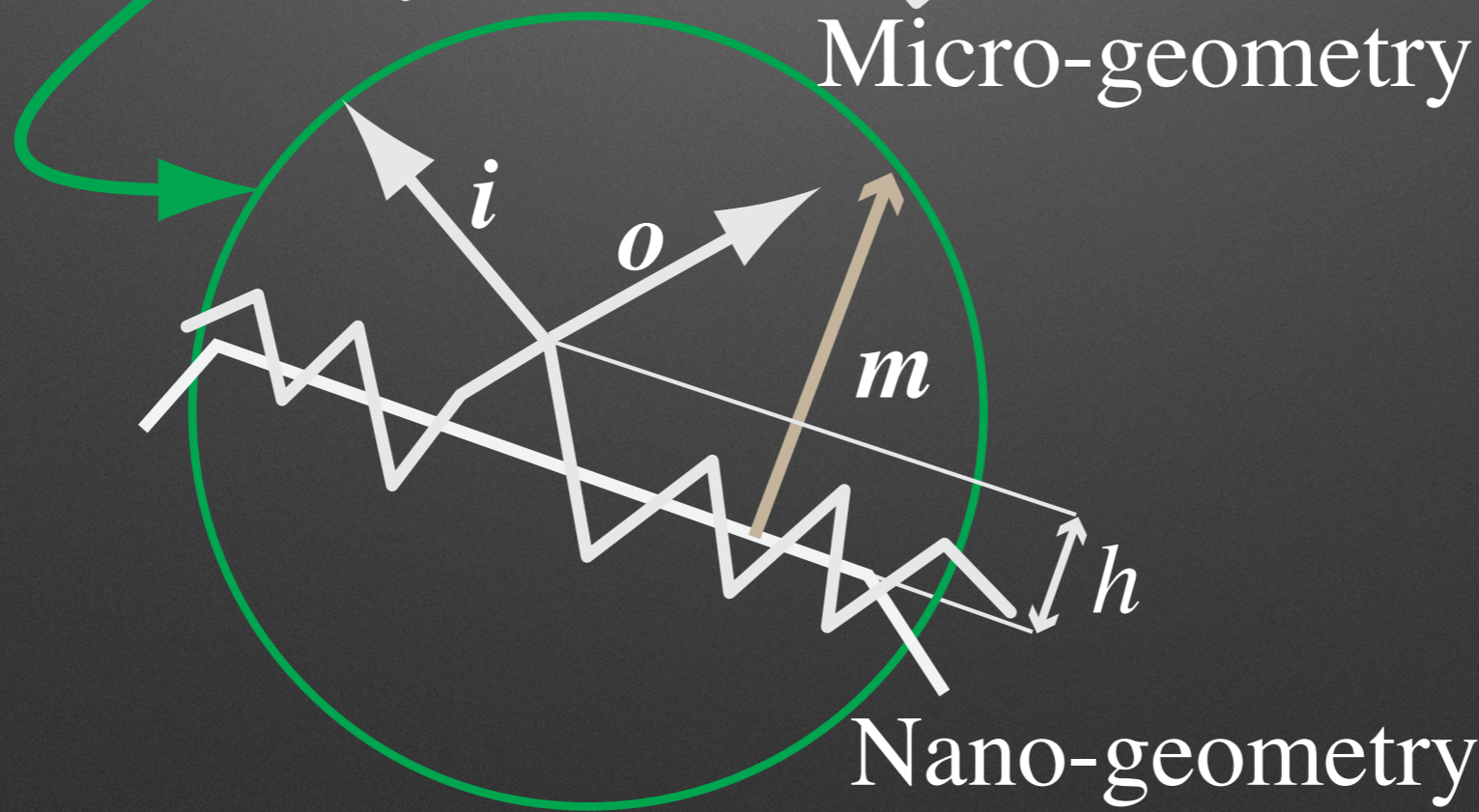
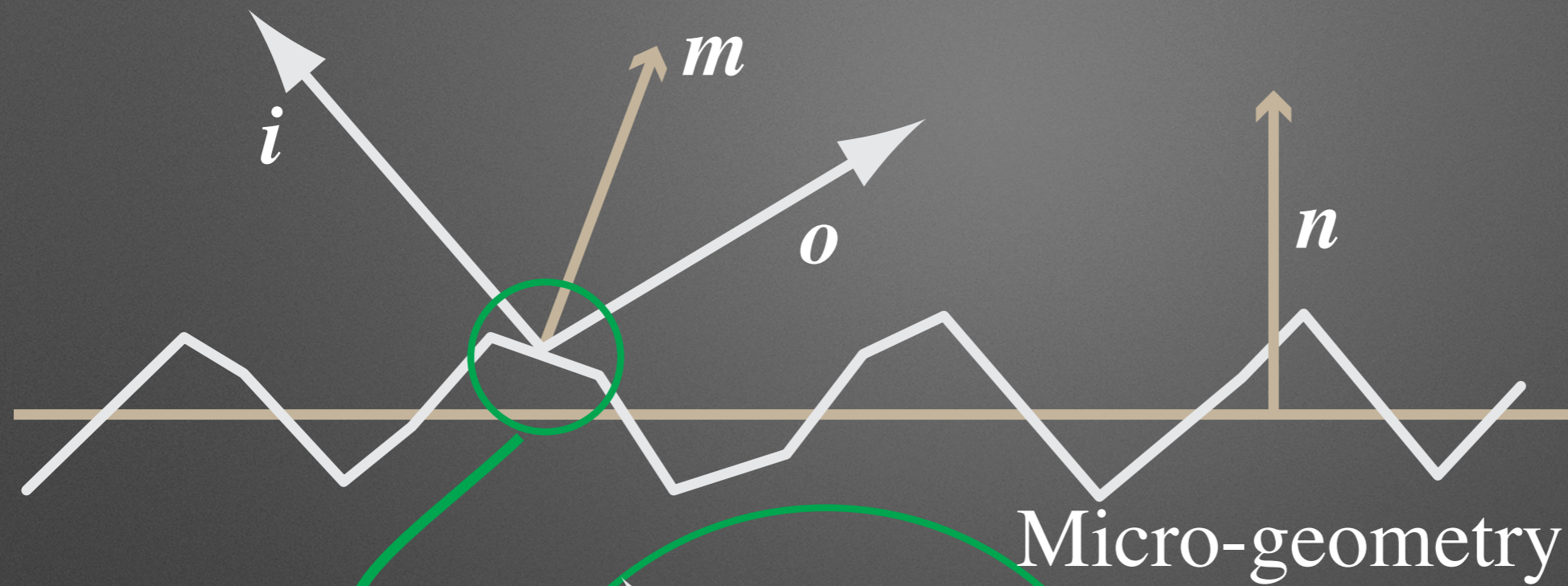

Two-Scale Reflectance Model

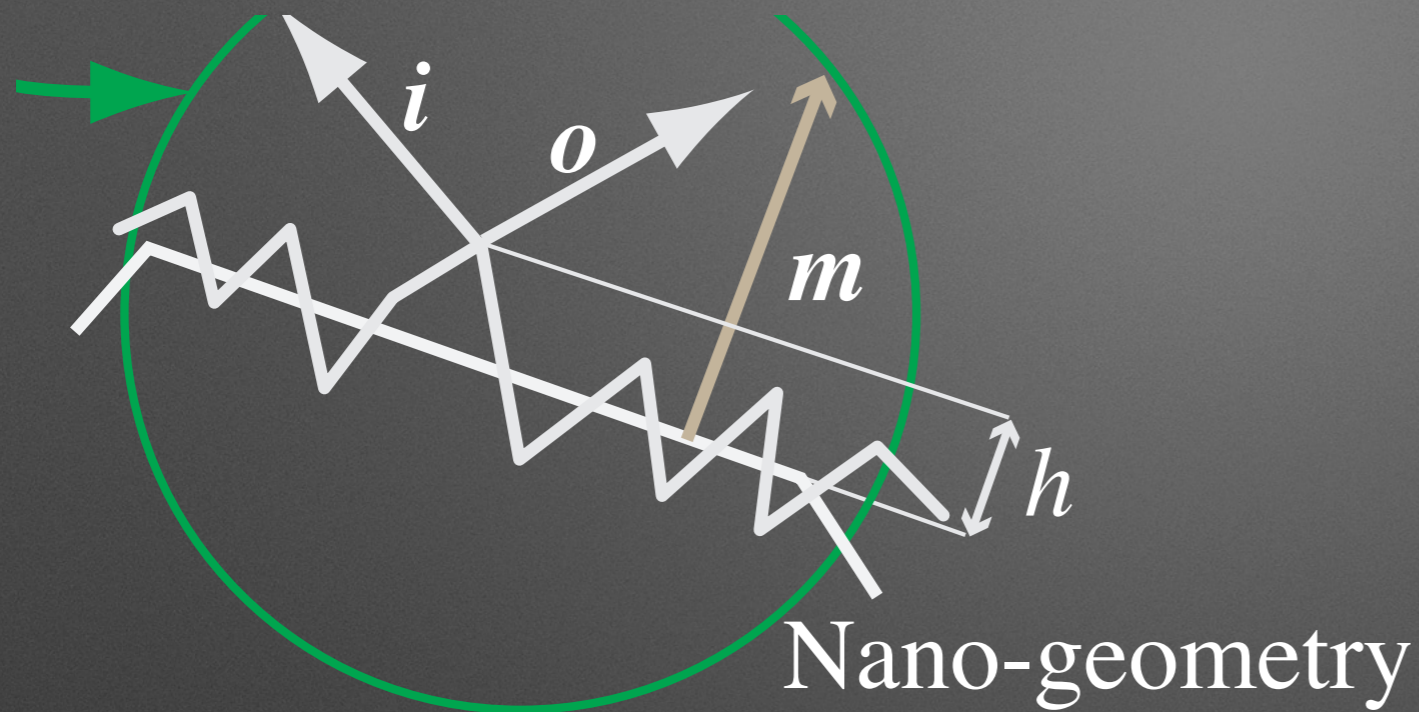

Wave Optics, Diffraction:

- Necessary to model Scattering of small scale surface
- Reflectance depends on wavelength

Surface Characteristics

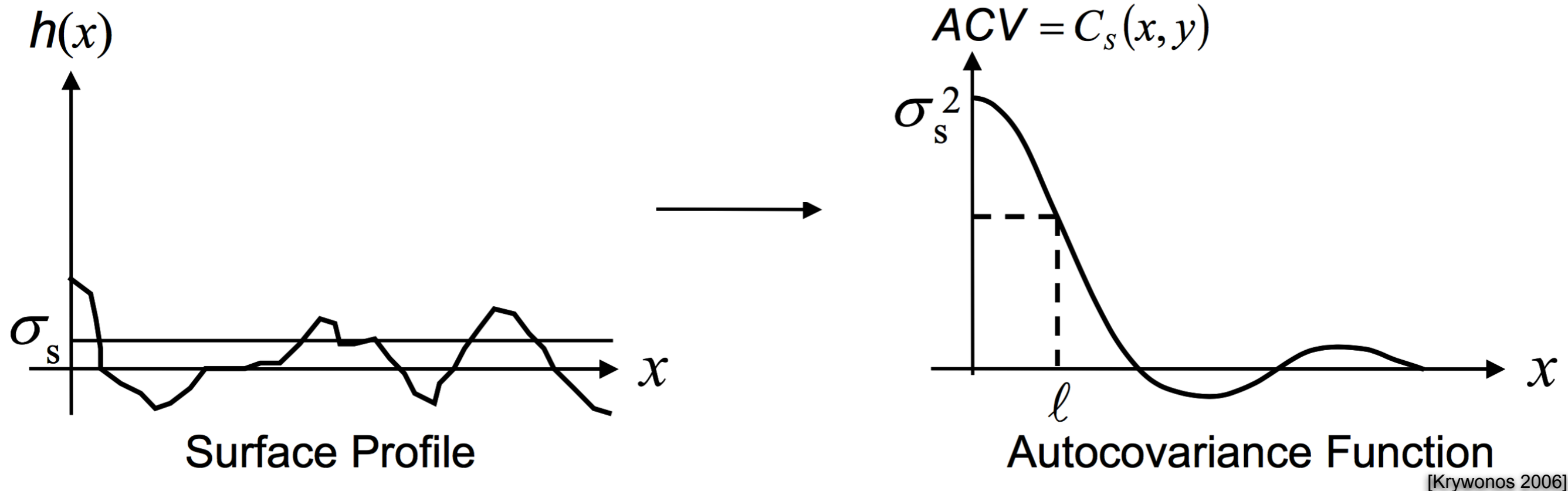

σ_s : RMS of the surface roughness

l : autocovariance length

Diffraction Theories for Scattering

Angular Wideness

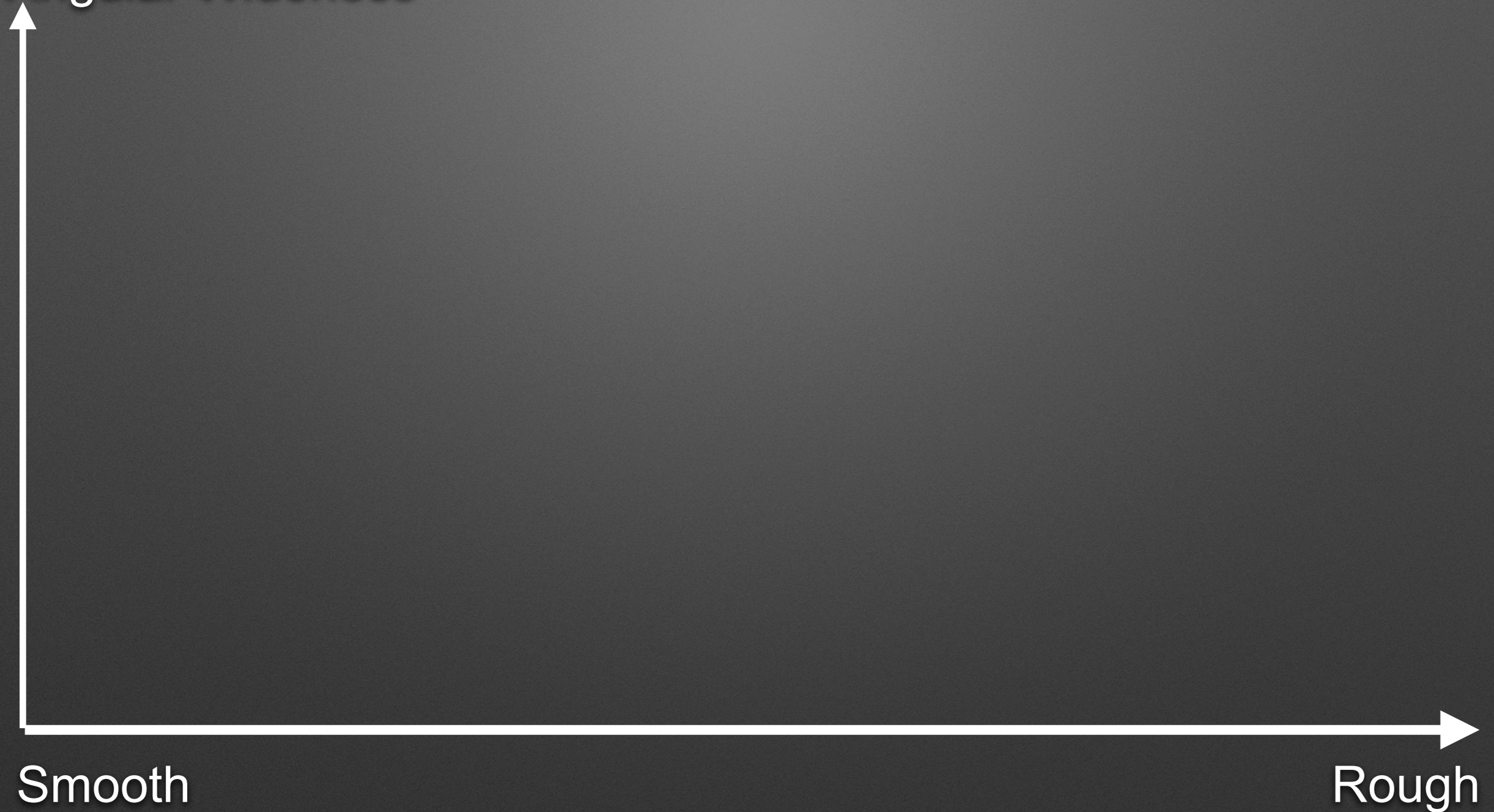

Diffraction Theories for Scattering

Angular Wideness

Rayleigh-Rice
[Löw 2012]

Smooth

Rough

Diffraction Theories for Scattering

Angular Wideness

Rayleigh-Rice
[Löw 2012]

Beckman-Kirchoff. [He 91, Stam 99]

Smooth

Rough

Diffraction Theories for Scattering

Angular Wideness

Rayleigh-Rice
[Löw 2012]

Harvey-Shack [HK 1975]

Beckman-Kirchoff. [He 91, Stam 99]

Smooth

Rough

Diffraction Theories for Scattering

Angular Wideness

Rayleigh-Rice
[Löw 2012]

Modified Beckman-Kirchoff. [Krywonos 2006]

Harvey-Shack [HK 1975]

Beckman-Kirchoff. [He 91, Stam 99]

Smooth

Rough

Diffraction Theories for Scattering

Angular Wideness

Rayleigh-Rice
[Löw 2012]

Generalized Harvey-Shack [HK 2012]

Modified Beckman-Kirchoff. [Krywonos 2006]

Harvey-Shack [HK 1975]

Beckman-Kirchoff. [He 91, Stam 99]

Smooth

Rough

Diffraction Theories for Scattering

Angular Wideness

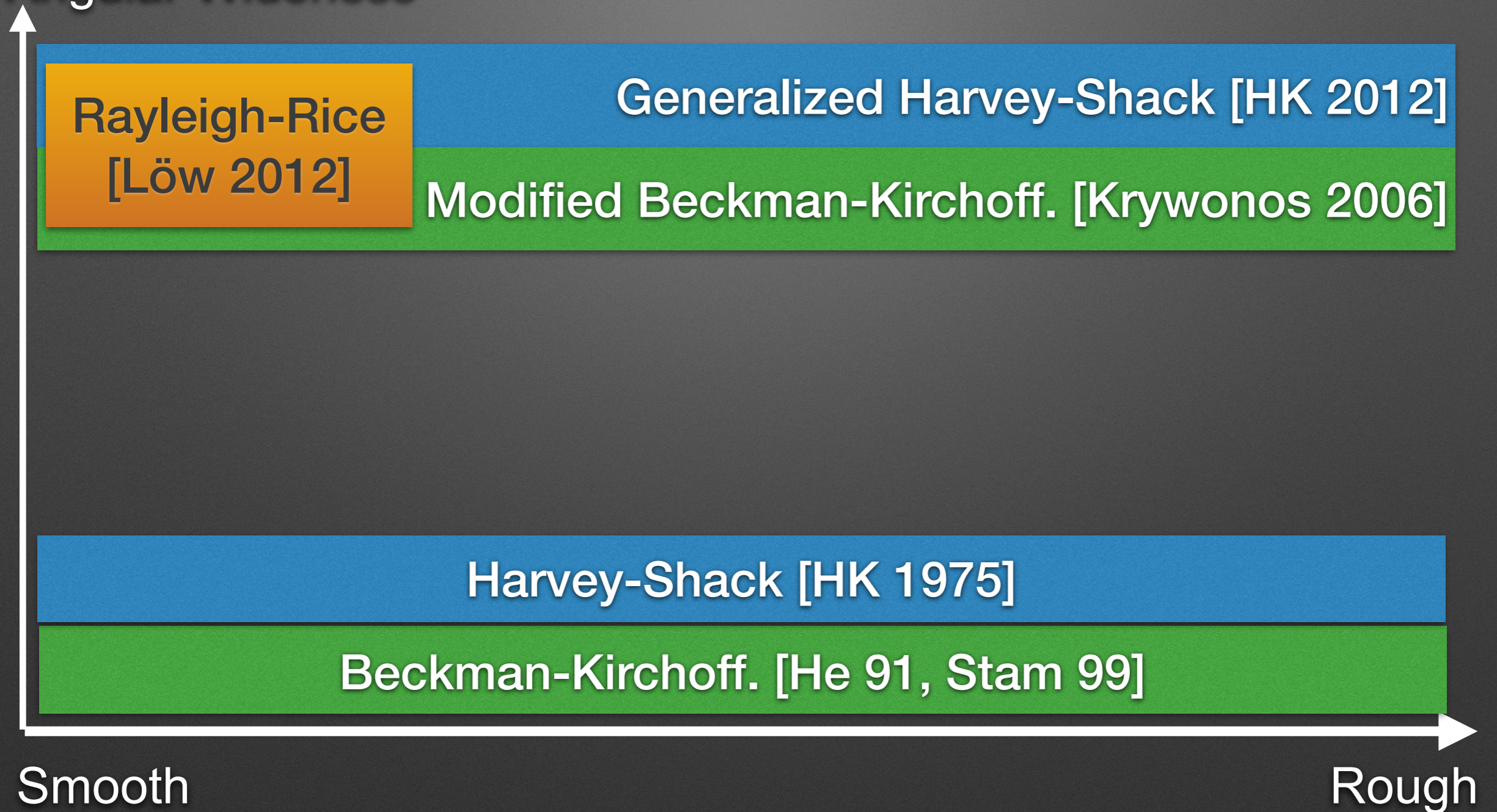

All Theories: **SINGLE** Scattering ONLY

Diffraction Theories for Scattering

Generalized Harvey-Shack

- Gaussian Surface Profile
- **Arbitrary** Autocovariance Function

⇒ Our Model utilizes it

Modified Beckman-Kirchoff

- Gaussian Surface Profile
- Gaussian Autocovariance Function

Generalized Harvey-Shack

Main Idea: **Surface = Transfer Function** on the incident wave

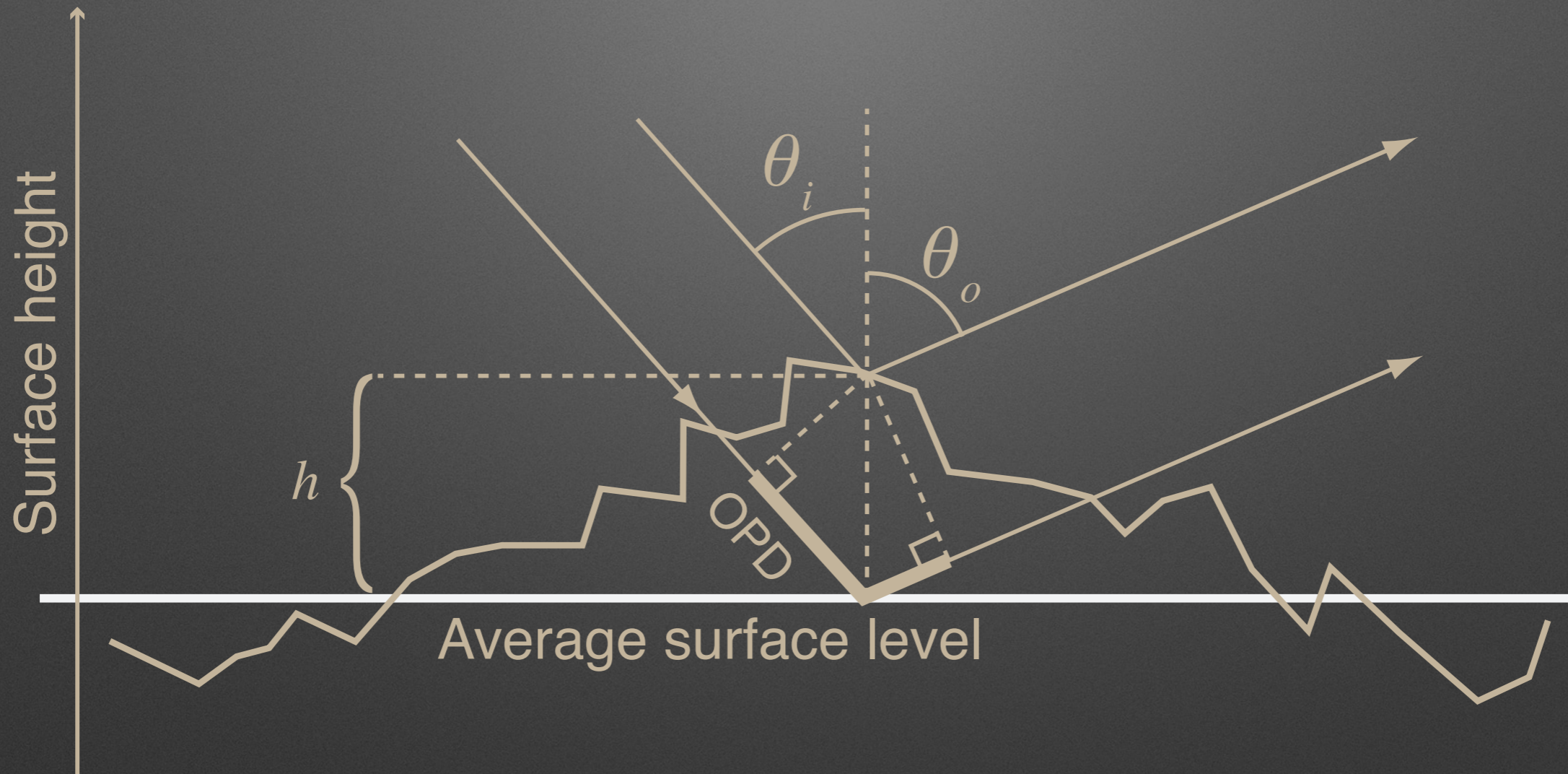

$$\text{OPD} = (\cos\theta_i + \cos\theta_o)h(x, y)$$

$$\text{random phase} = \frac{2\pi}{\lambda} \text{OPD}$$

Generalized Harvey-Shack

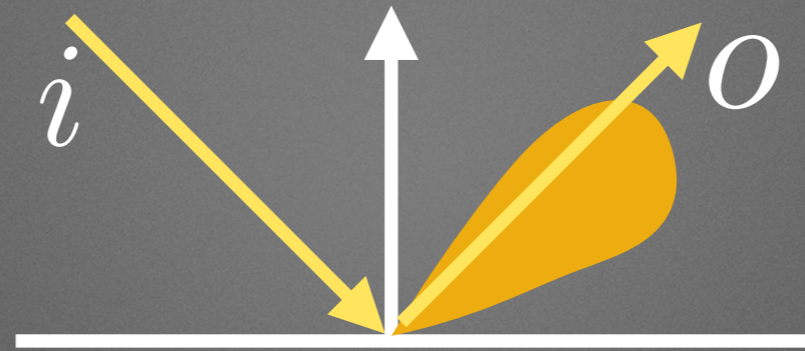

BRDF: Specular Peak (Dirac) + Diffraction Lobe

Generalized Harvey-Shack

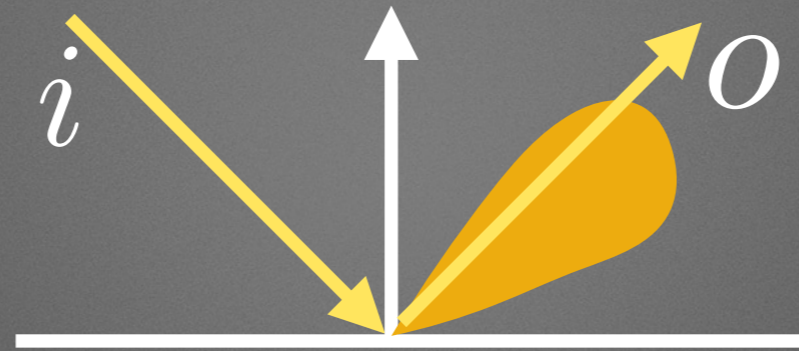

BRDF: Specular Peak (Dirac) + Diffraction Lobe

$$\rho(i, o) = \text{Fresnel}(i, o) \left[A\delta(\text{refl}(i), o) + (1 - A) \underbrace{\mathcal{F}_{|x,y}\{C(x, y, i, o)\}}_{\text{2D Fourier Transform}} \right]$$

Generalized Harvey-Shack

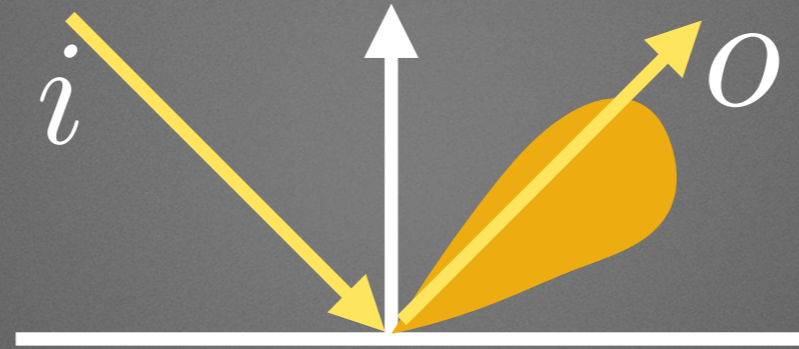

BRDF: Specular Peak (Dirac) + Diffraction Lobe

$$\rho(i, o) = \text{Fresnel}(i, o) \left[A\delta(\text{refl}(i), o) + (1 - A) \underbrace{\mathcal{F}_{|x,y}\{C(x, y, i, o)\}}_{\text{2D Fourier Transform}} \right]$$

$\mathcal{F}_{|x,y}\{C(x, y, i, o)\}$: Fourier Transform per light and view

$$C(x, y, i, o) \propto \text{AutoCovariance}(x, y) C'(i, o)$$

$$A = \exp\left\{-\left(2\pi(\cos\theta_i + \cos\theta_o)\frac{\sigma_s}{\lambda}\right)^2\right\}$$

Summary on Generalized Harvey-Shack

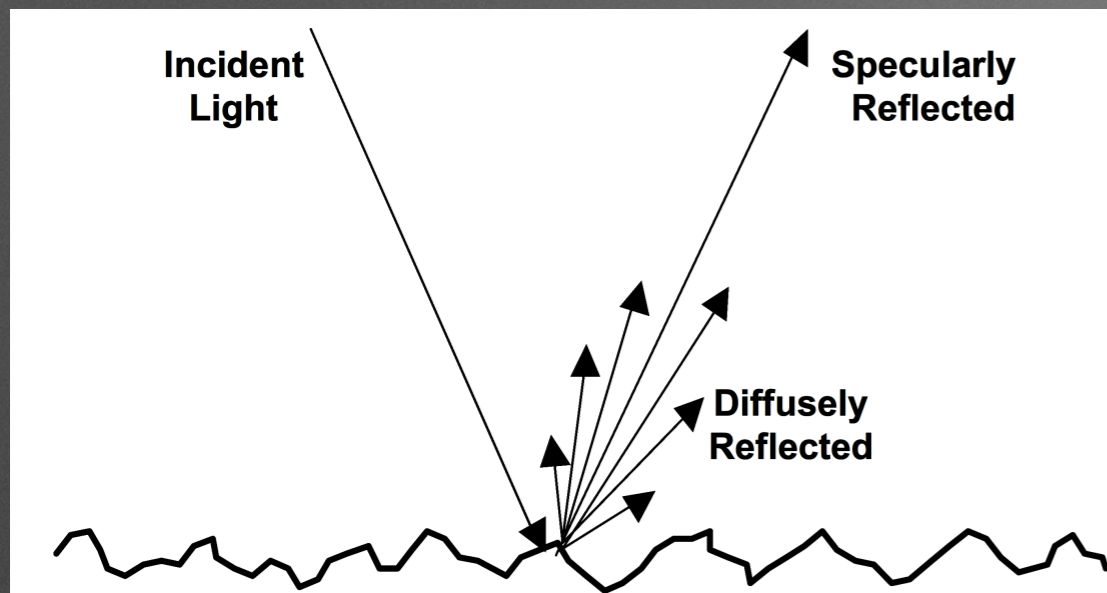

$$\rho(i, o) = \dots(1 - A) \mathcal{F}\{G(x, y, i, o)\}$$

$$A = e^{-\left(2\pi(\cos \theta_i + \cos \theta_o) \frac{\sigma_s}{\lambda}\right)^2}$$

- Valid for all roughness and all angles
- Reflectance Depends on Wavelength
- BUT ...
- **Fourier Transform per directions**



GHS is **too expensive** for CG

Diffraction into our Two-Scale Model

- Hypotheses

- Micro-geometry: ROUGH

- Nano-geometry: SMOOTH

⇒ **GHS simplifies** a bit

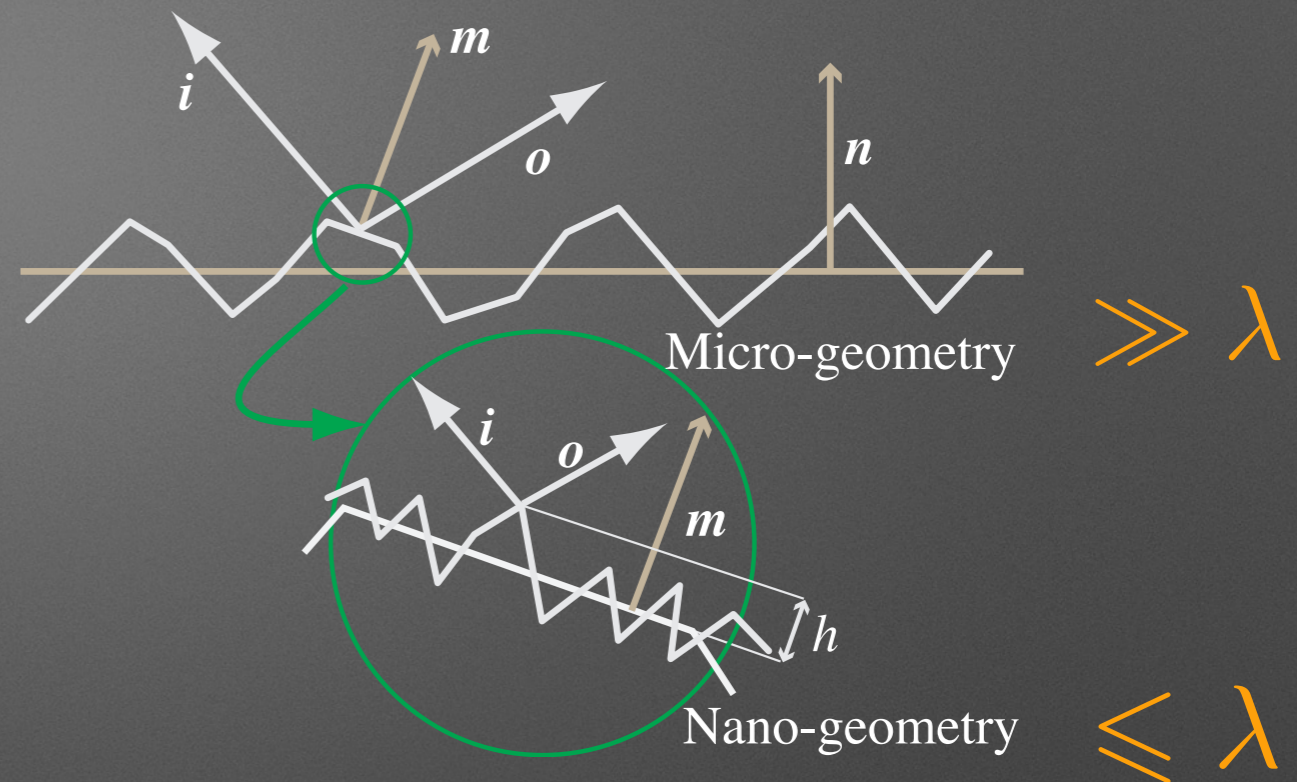

- Each Microfacet is a diffractive element

- Final BRDF :

- Convolution of Diffractive Elements with Micro-geometry

Our Approach for Smooth Regime

$$\rho(i, o) = \text{Fresnel} \left[A \delta(\text{refl}(i), o) + (1 - A) \mathcal{F}\{C(x, y, i, o)\} \right]$$

Our Approach for Smooth Regime

$$\rho(i, o) = \text{Fresnel} \left[A \delta(\text{refl}(i), o) + (1 - A) \mathcal{F}\{C(x, y, \underline{i}, \sigma)\} \right]$$

- Fourier Transform depends **only** on the surface

Our Approach for Smooth Regime

$$\rho(i, o) = \text{Fresnel} \left[A \delta(\text{refl}(i), o) + (1 - A) \mathcal{F}\{C(x, y, \underline{i}, \sigma)\} \right]$$

- Fourier Transform depends **only** on the surface

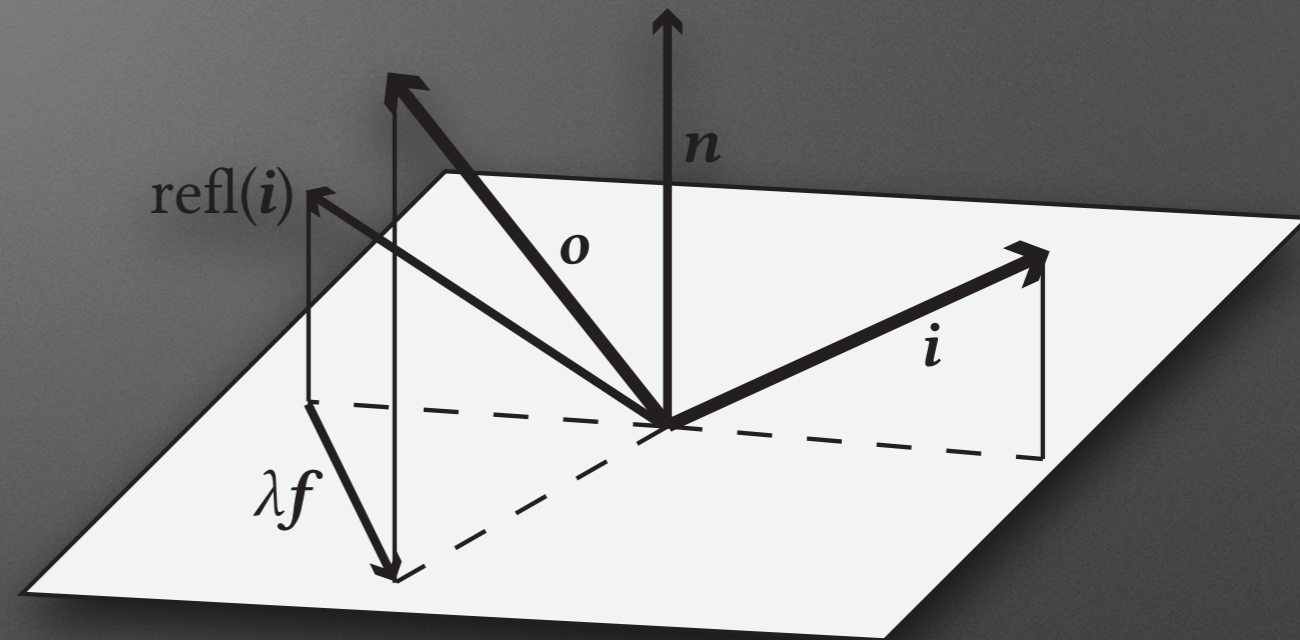

$$\mathcal{F}\{C(x, y)\} : \text{PSD}(\text{Surface}) \approx \text{K-Correlation}(\sigma_s, f)$$

$$\|\mathbf{f}\| = \frac{2}{\lambda} \sin \theta_h \cos \theta_d$$

Our Approach for Smooth Regime

$$\rho(i, o) = \text{Fresnel} \left[A \delta(\text{refl}(i), o) + (1 - A) \mathcal{F}\{C(x, y, \underline{i}, \sigma)\} \right]$$

- Fourier Transform depends **only** on the surface

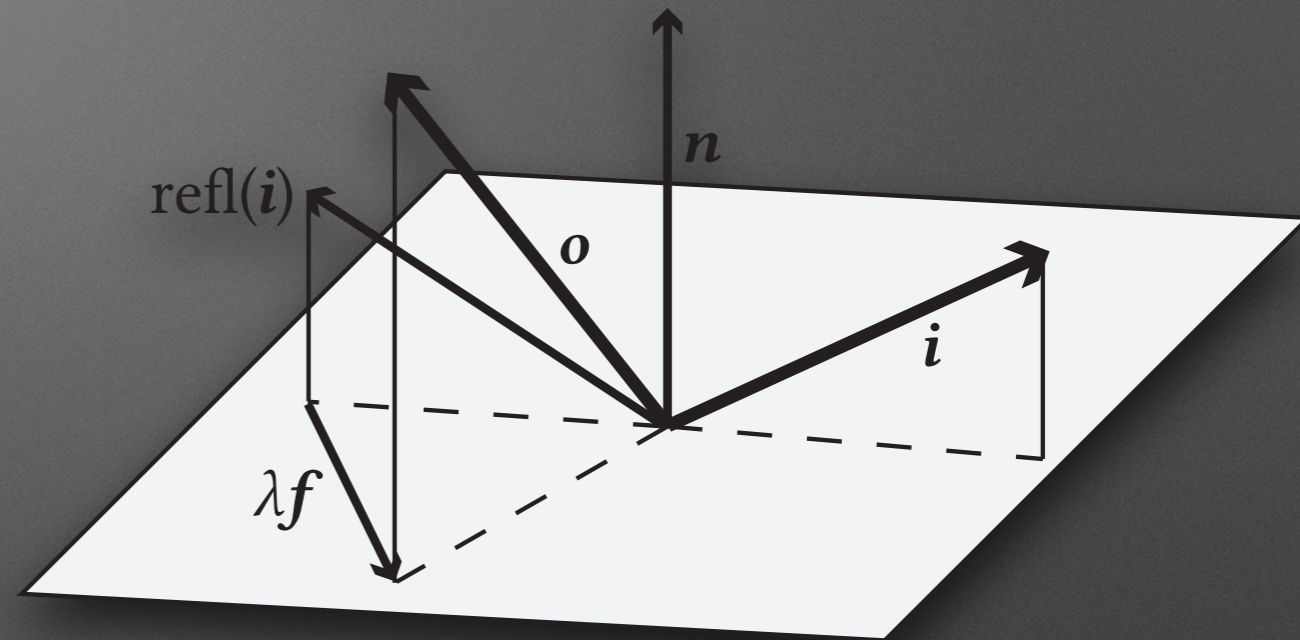

$$\mathcal{F}\{C(x, y)\} : PSD(\text{Surface}) \approx \text{K-Correlation}(\sigma_s, f)$$

$$\|\mathbf{f}\| = \frac{2}{\lambda} \sin \theta_h \cos \theta_d$$

- $\mathbf{f} \Leftrightarrow$ Alternative Parametrization [Barla et al. Mam 2015]

Renormalization of the Diffraction Lobe

$$\mathcal{F}\{C(x, y)\} \approx \text{K-Correlation}(\sigma_s, \mathbf{f})$$

$$\sigma_s^2 = \iint \text{K-Correlation}(\sigma_s, \mathbf{f}) d\mathbf{f}$$

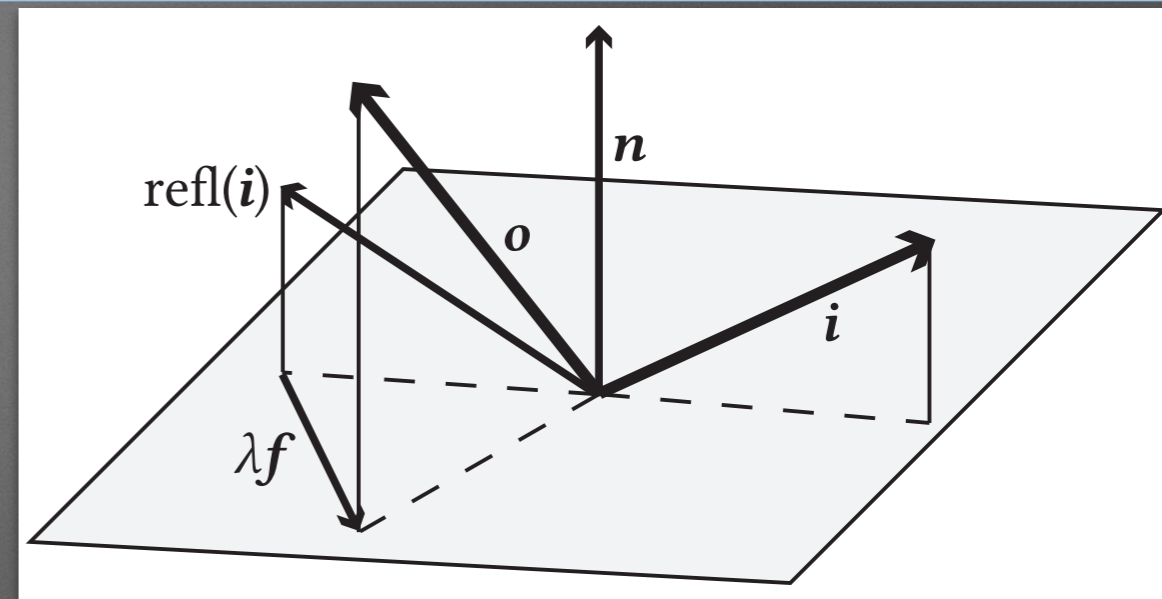

Renormalization of the Diffraction Lobe

$$\mathcal{F}\{C(x, y)\} \approx \text{K-Correlation}(\sigma_s, \mathbf{f})$$

- Renormalization

$$\sigma_s^2 = \iint \text{K-Correlation}(\sigma_s, \mathbf{f}) d\mathbf{f}$$

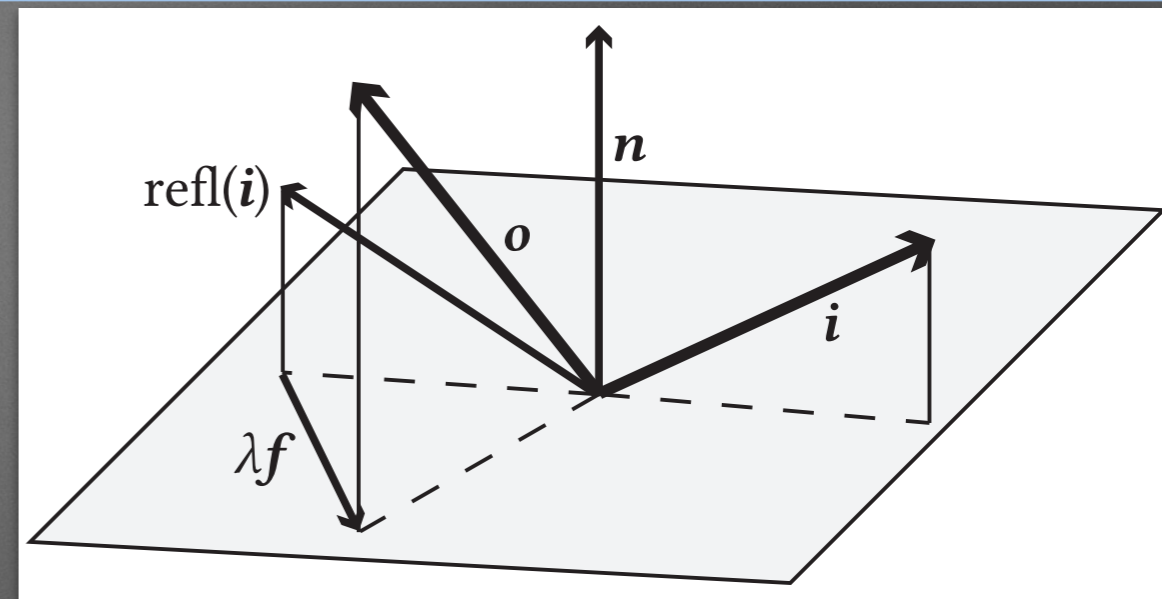

- **Enforce Energy repartition** between dirac and diffraction [Harvey2012]
- Comes from the Autocovariance Function Property
- Precomputed for a large range of values: 8.9MB

Diffraction into our Two-Scale Model

- Microfacet Framework [Walter2007]
- Convolution of a Microfacet BRDF

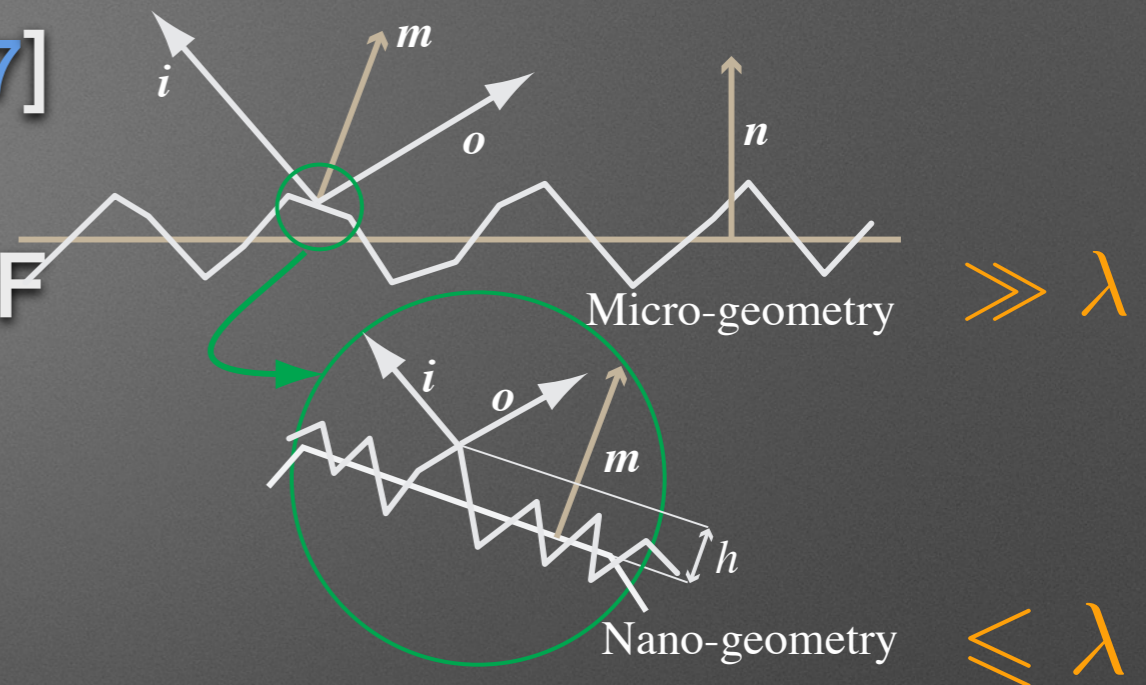

Diffraction into our Two-Scale Model

- Microfacet Framework [Walter2007]
- Convolution of a Microfacet BRDF

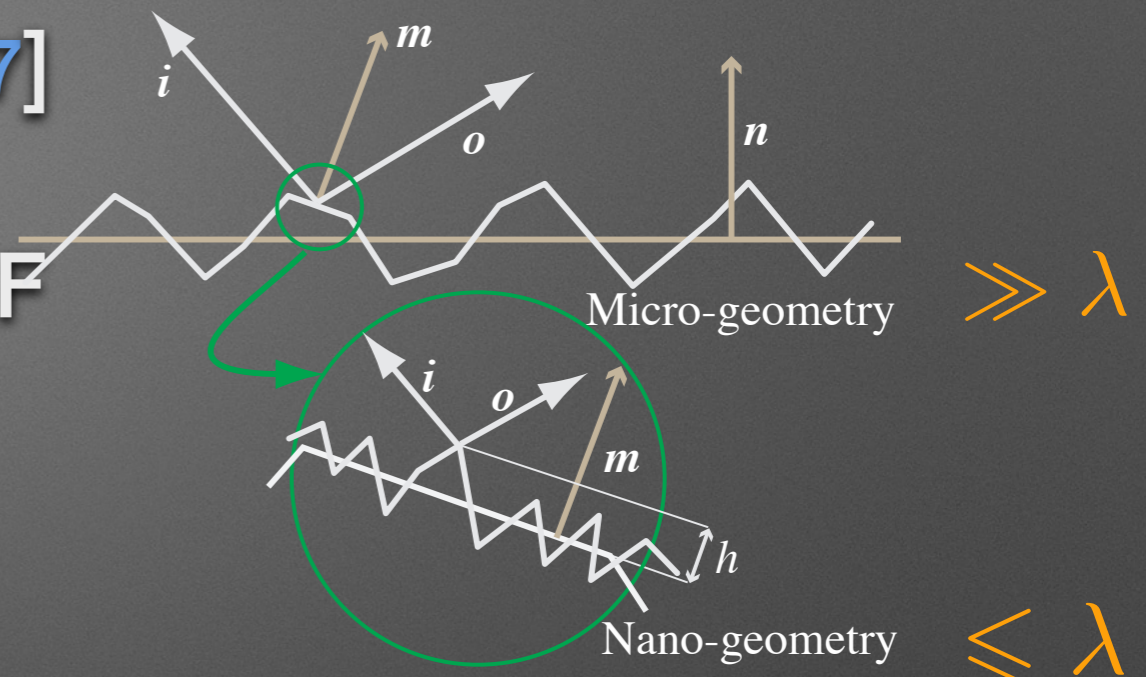

$$\rho(i, o) = \int_{\Omega_m} \underbrace{\rho_m(i, o, m)}_{\text{Microfacet BRDF}} G(i, o) D(m) d\omega_m$$

Diffraction into our Two-Scale Model

- Microfacet Framework [Walter2007]

- Convolution of a Microfacet BRDF

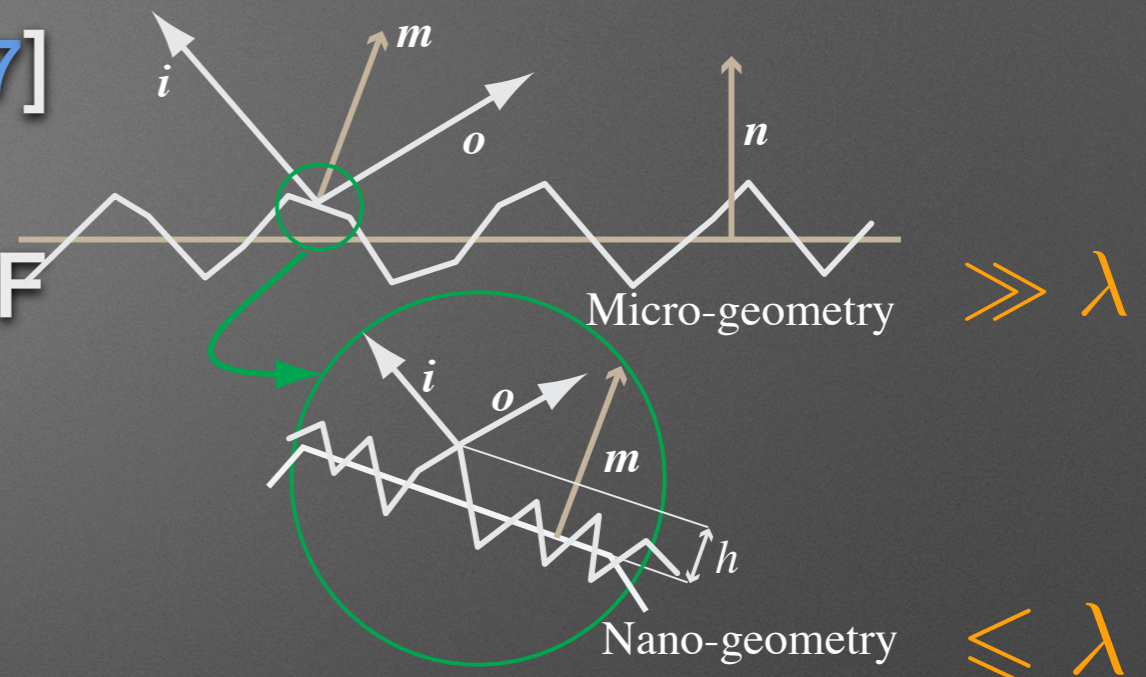

$$\rho(i, o) = \int_{\Omega_m} \underbrace{\rho_m(i, o, m)}_{\text{Microfacet BRDF}} G(i, o) D(m) d\omega_m$$

- In Our Case, **Smooth Diffractive Microfacet:**

$$\rho_m(i, o, m) = \text{Fresnel} \left[A \delta(\text{refl}(i), o) + (1 - A) K_{\sigma_s}(f) \right]$$

Convolution of a Diffractive Microfacet

$$\rho(i, o) = \int_{\Omega_m} \text{Fresnel}(i, o) \left[A \delta(\text{refl}(i), o) + (1 - A) K_{\sigma_s}(f) \right] G(i, o) D(m) d\omega_m$$

Convolution of a Diffractive Microfacet

$$\rho(i, o) = \int_{\Omega_m} \text{Fresnel}(i, o) \left[A \delta(\text{refl}(i), o) + (1 - A) K_{\sigma_s}(f) \right] G(i, o) D(m) d\omega_m$$

$$\rho(i, o) = \underbrace{\int_{\Omega_m} \text{Fresnel}(i, o) A \delta(\text{refl}(i), o) G(i, o) D(m) d\omega_m}_{\text{Microfacet-based BRDF}}$$

$$+ \underbrace{\int_{\Omega_m} \text{Fresnel}(i, o) (1 - A) K_{\sigma_s}(f) G(i, o) D(m) d\omega_m}_{\text{Diffraction Part}}$$

Convolution of a Diffractive Microfacet

$$\rho(i, o) = \int_{\Omega_m} Fresnel(i, o) \left[A \delta(refl(i), o) + (1 - A) K_{\sigma_s}(f) \right] G(i, o) D(m) d\omega_m$$

$$\rho(i, o) = \frac{Fresnel(i, o) D(\theta_h) G(i, o)}{4 \pi \cos \theta_i \cos \theta_o}$$

$$+ \underbrace{\int_{\Omega_m} Fresnel(i, o) (1 - A) K_{\sigma_s}(f) G(i, o) D(m) d\omega_m}_{\text{Diffraction Part}}$$

Diffraction Part

Convolution of a Diffractive Microfacet

$$\rho_{ghs}(i, o) = \int_{\Omega_m} Fr(i, o) (1 - A_{\sigma_s}(i, o)) K_{\sigma_s}(f) G(i, o) D(m) d\omega_m$$

Convolution of a Diffractive Microfacet

$$\rho_{ghs}(i, o) = \int_{\Omega_m} Fr(i, o) (1 - A_{\sigma_s}(i, o)) K_{\sigma_s}(f) G(i, o) D(m) d\omega_m$$

$$\rho_{ghs}(i, o) \approx Fr(i, o) G(i, o) (1 - A_{\sigma_s}(\theta_d)) \underbrace{\int_{\Omega_m} K_{\sigma_s}(f) D(m) (h \cdot m)^2 d\omega_m}_{\text{Convolution} \approx K'_{\sigma_s}(f)}$$

$$f = 2 \cos \theta_d \sqrt{(1 - (h \cdot m)^2)}$$

Convolution of a Diffractive Microfacet

$$\rho_{ghs}(i, o) = \int_{\Omega_m} Fr(i, o) (1 - A_{\sigma_s}(i, o)) K_{\sigma_s}(f) G(i, o) D(m) d\omega_m$$

$$\rho_{ghs}(i, o) \approx Fr(i, o) G(i, o) (1 - A_{\sigma_s}(\theta_d)) \underbrace{\int_{\Omega_m} K_{\sigma_s}(f) D(m) (h \cdot m)^2 d\omega_m}_{\text{Convolution} \approx K'_{\sigma_s}(f)}$$

$$f = 2 \cos \theta_d \sqrt{(1 - (h \cdot m)^2)}$$

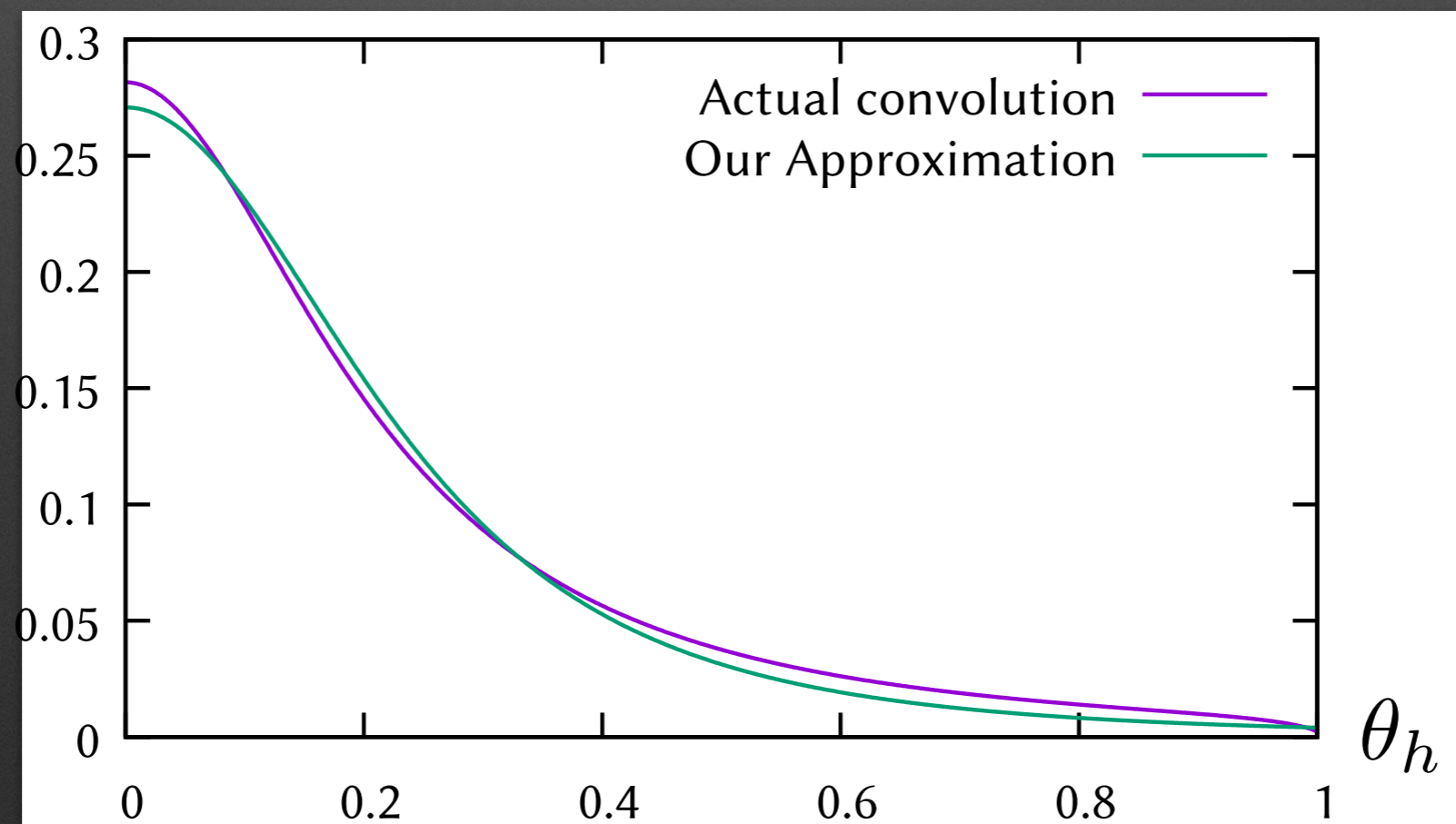

Convolution of a Diffractive Microfacet

$$\rho_{ghs}(i, o) \approx Fr (1 - A) G(i, o) \underbrace{\int_{\Omega_m} K_{\sigma_s}(f) D(m) (h \cdot m)^2 d\omega_m}_{\text{Convolution} \approx K'_{\sigma_s}(f)}$$
$$f = 2 \cos \theta_d \sqrt{(1 - (h \cdot m)^2)}$$

Convolution Computation

- Product of Zonal Harmonics. 100 Coefficients
- Result is a **new K-Correlation Function**
- 4D Table Precomputed
- Parameters : $\frac{\cos \theta_d}{\lambda}$, $D(m)$ and K-Correlation Model

Our Model for Conductor

- Combination of a Specular Lobe and Diffractive Lobe

$$\rho(i, o) = A_{\sigma_s}(\theta_d) \underbrace{\rho_{epd}(i, o)}_{\text{specular}} + \underbrace{\rho_{ghs}(i, o)}_{\text{diffraction}}$$

- Specular Lobe: Exponential Power Distribution (EPD)

$$epd(x) = \frac{p}{\pi \beta^2 \Gamma(1/p)} e^{-(x/\beta^2)^p}$$

Exponential Power Distribution NDF

- Generalization of Gaussian Distribution
 - Kurtosis control
 - Similar to [Brady2014]
- Analytical Importance Sampling
 - Distribution only
- Shadowing Term
 - Precomputed for large range of possible values for the parameters
 - 390 KB 2D Array

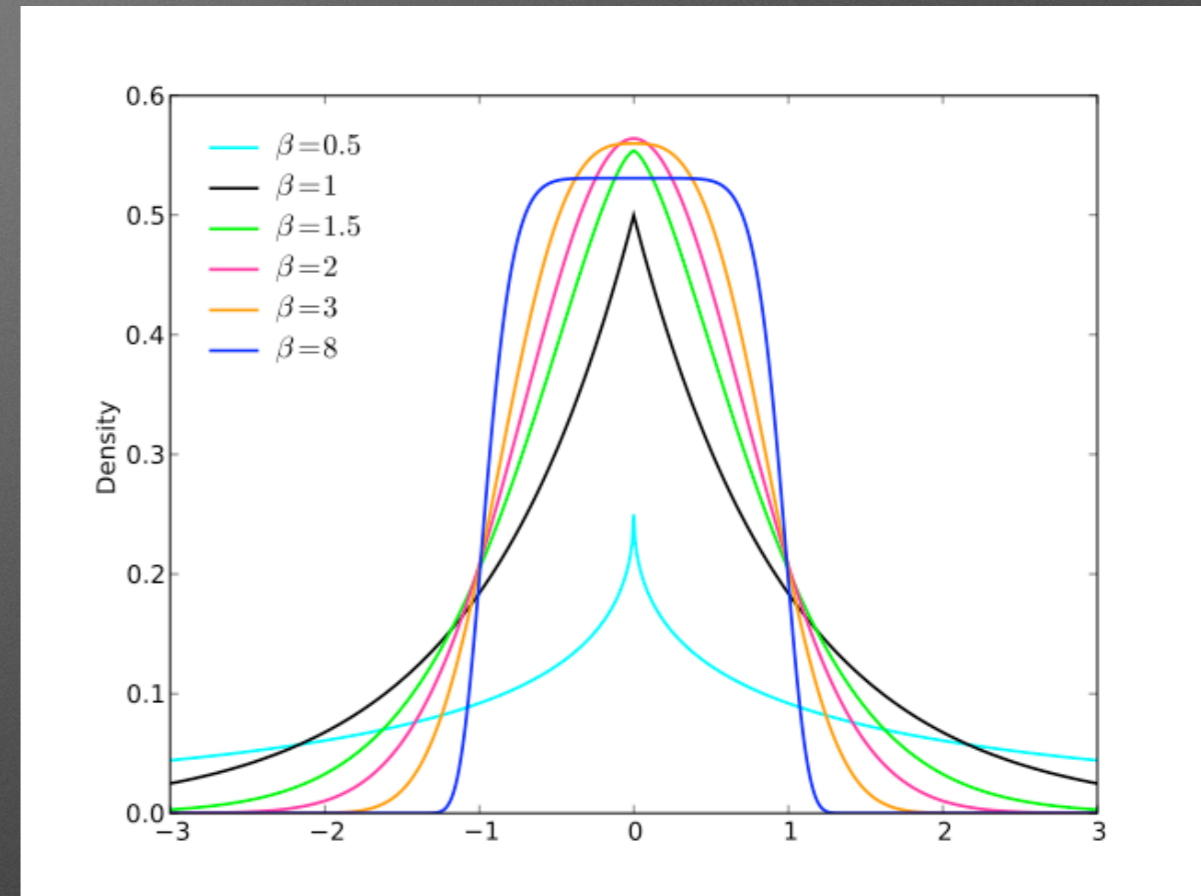

Parameters of the Model

- Diffraction Lobe

RMS of Surface Roughness : 1

Index of Refraction : 2 per wavelength

K-correlation Model : 2 parameters

- Specular Lobe

β : Width

p : Kurtosis

Diffraction Parameters Behaviour

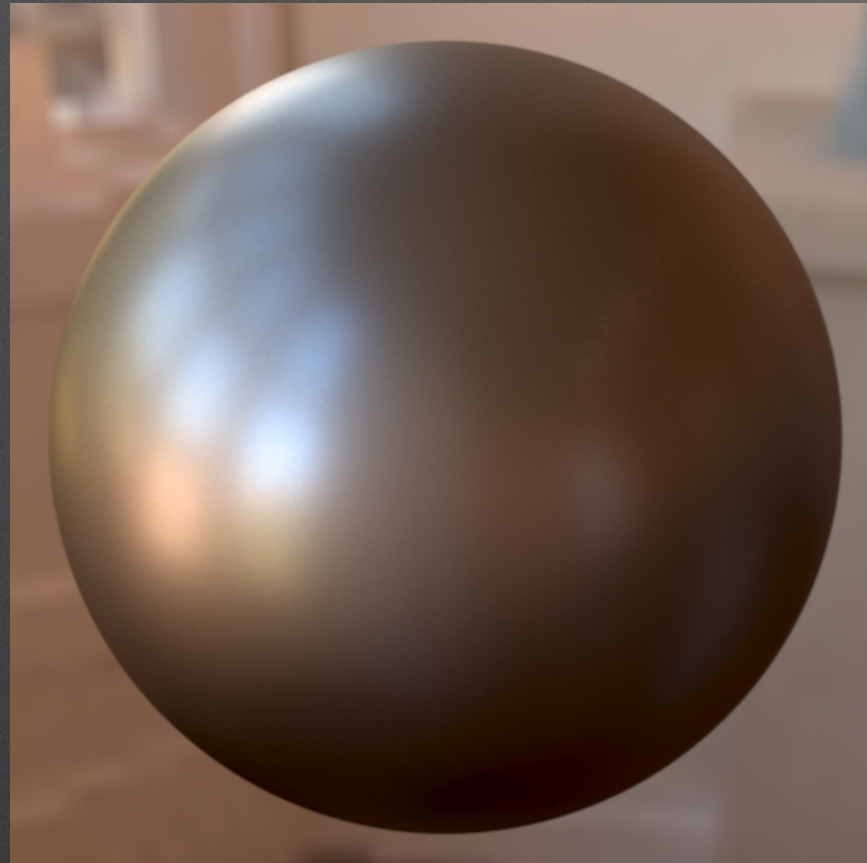

$$\sigma_s \times 3, b/3$$

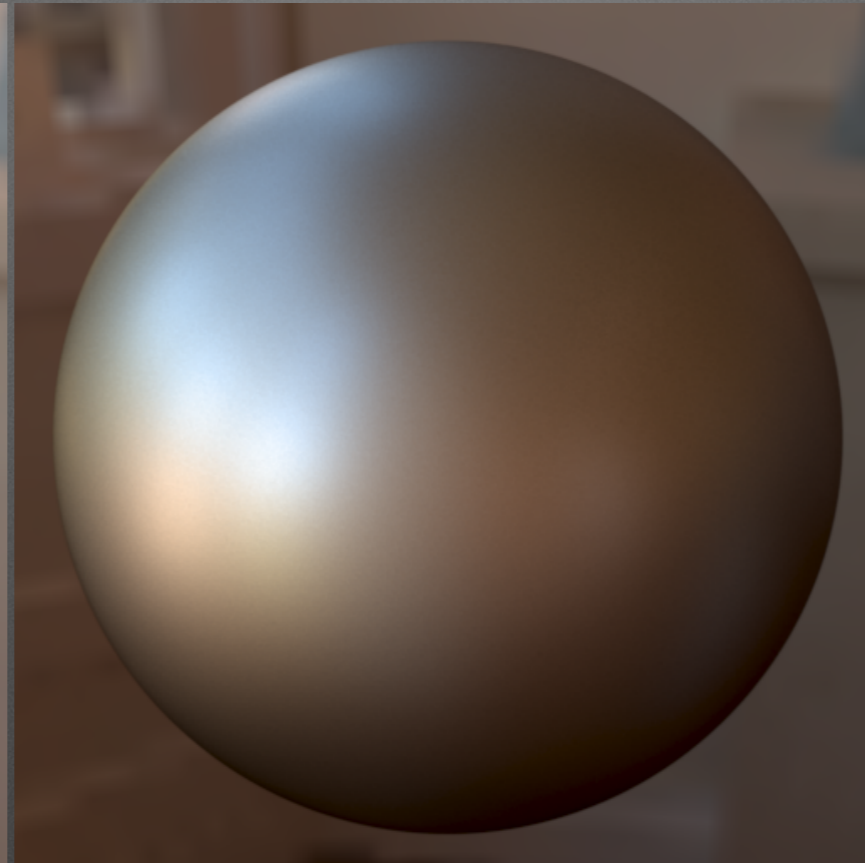

$$\sigma_s \times 1, b \times 1$$

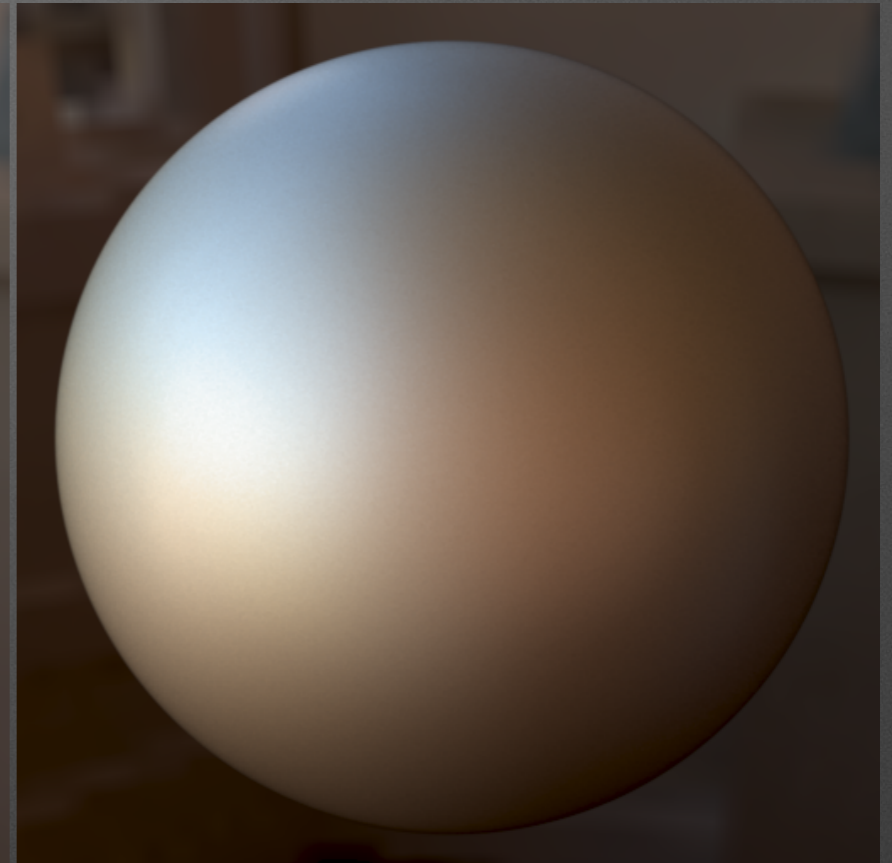

$$\sigma_s \times 4, b \times 4$$

Specular Lobe Behavior

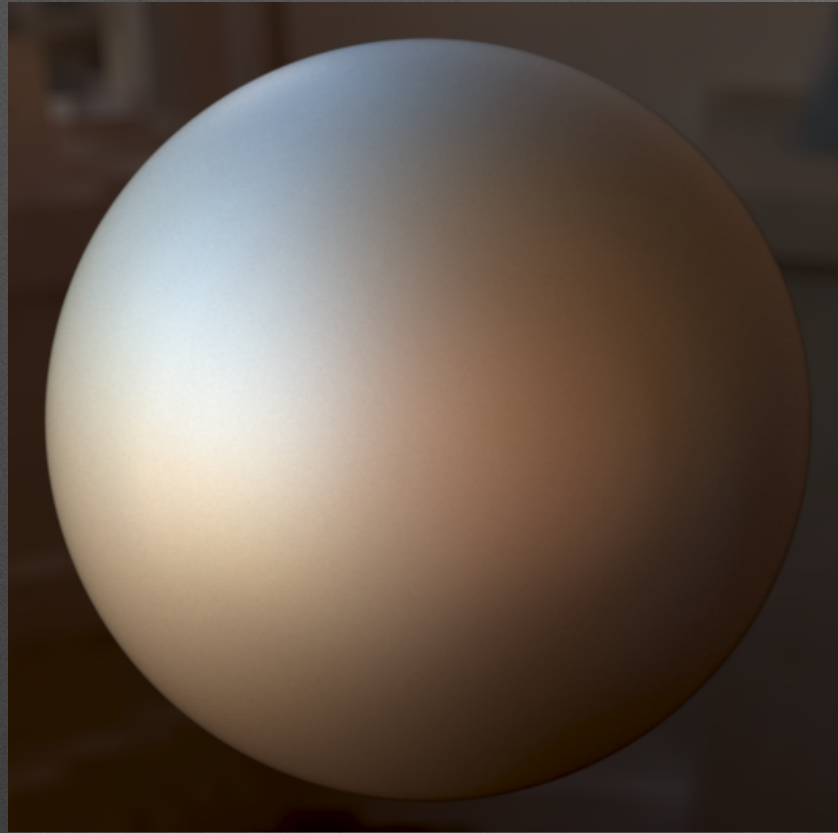

$$\beta \times 4$$

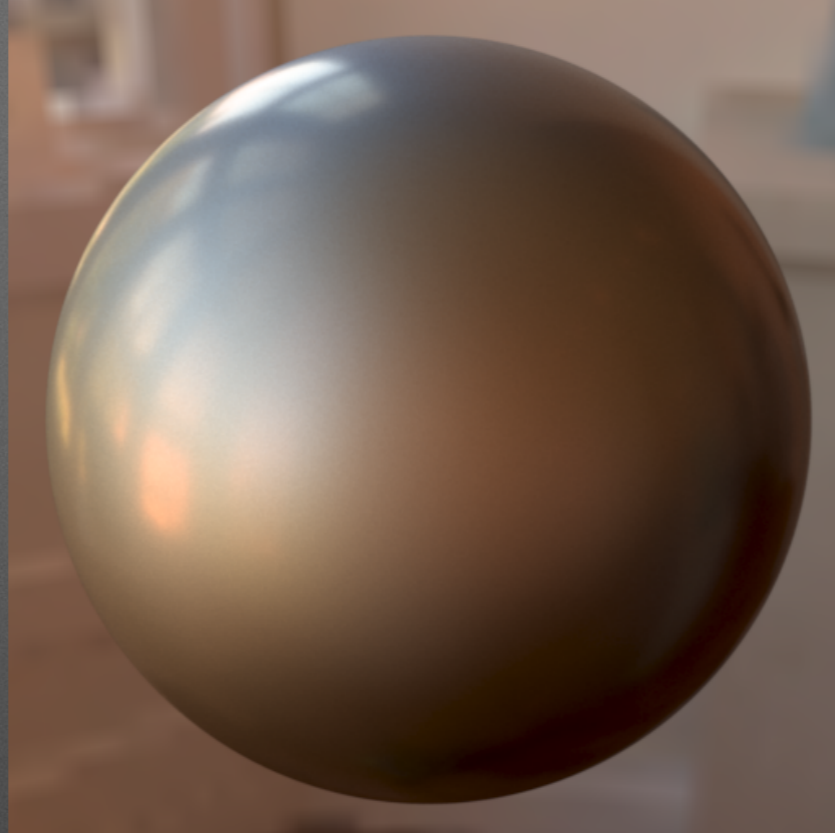

$$\beta \times 1$$

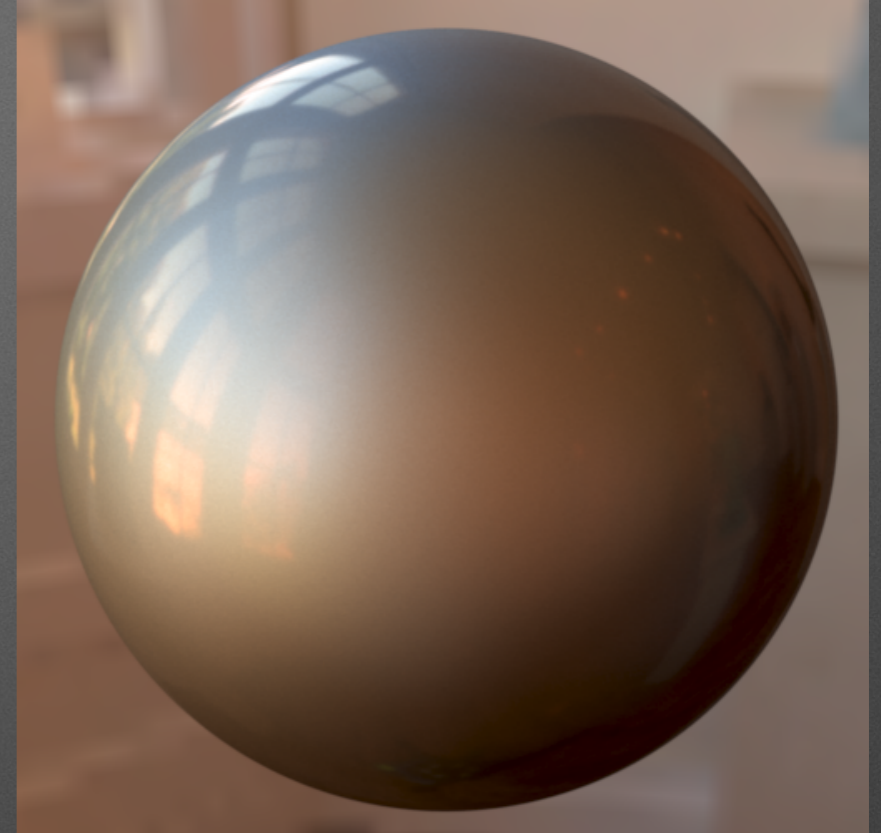

$$\beta / 4$$

Diffraction parameters remain unchanged

Comparison for Nickel

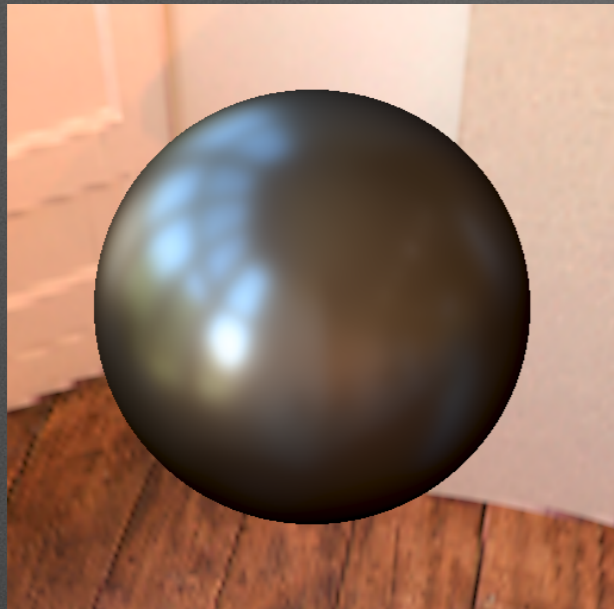

Diffraction

+

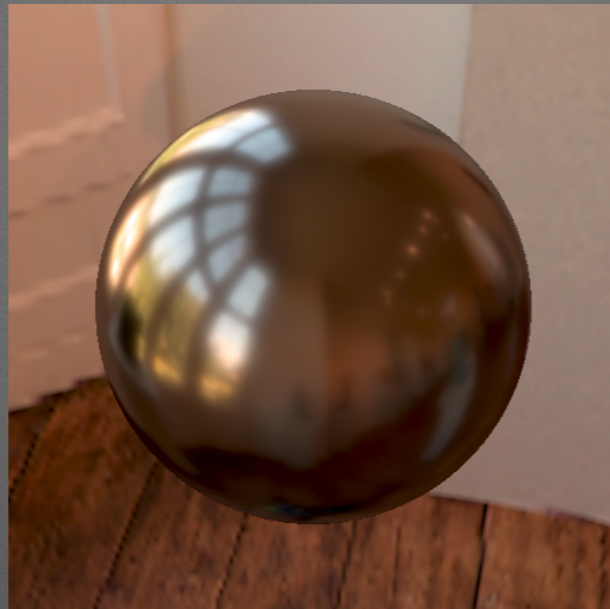

Microfacet

=



Model

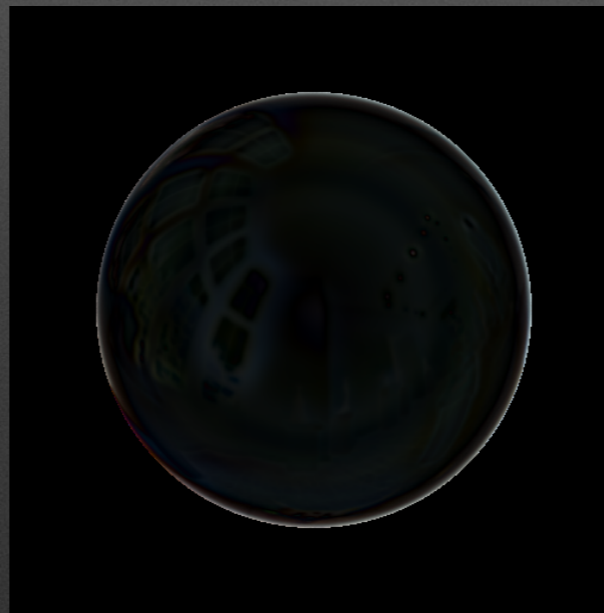

Difference

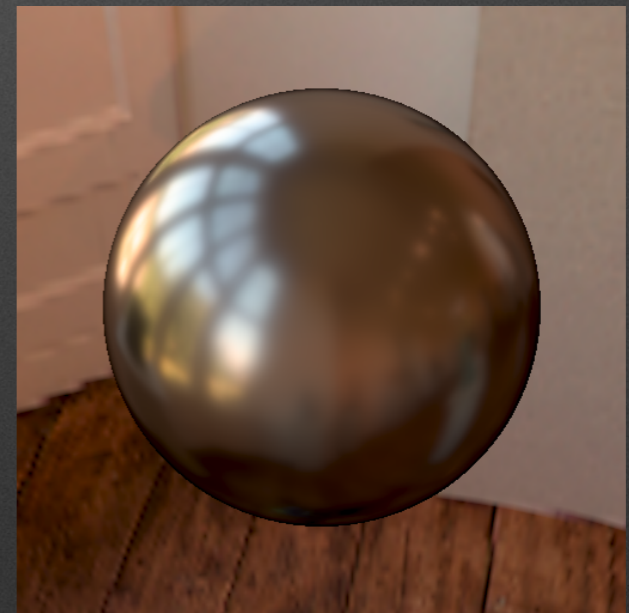

Reference

Comparison for Alum-Bronze



Diffraction

+



Microfacet

=

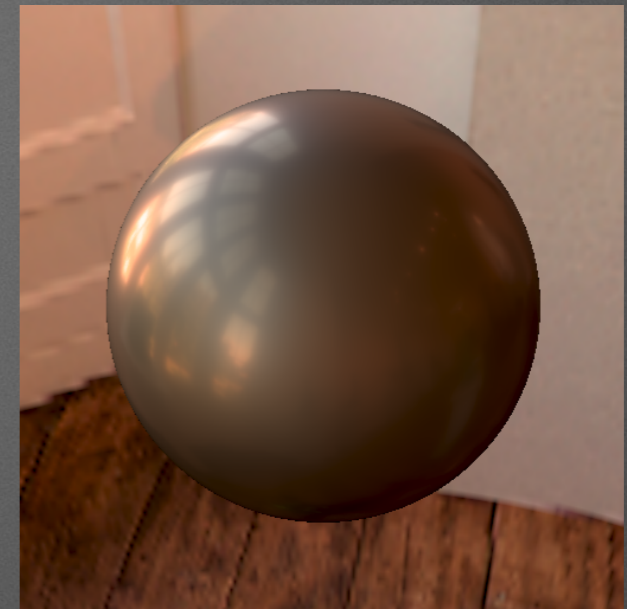

Model

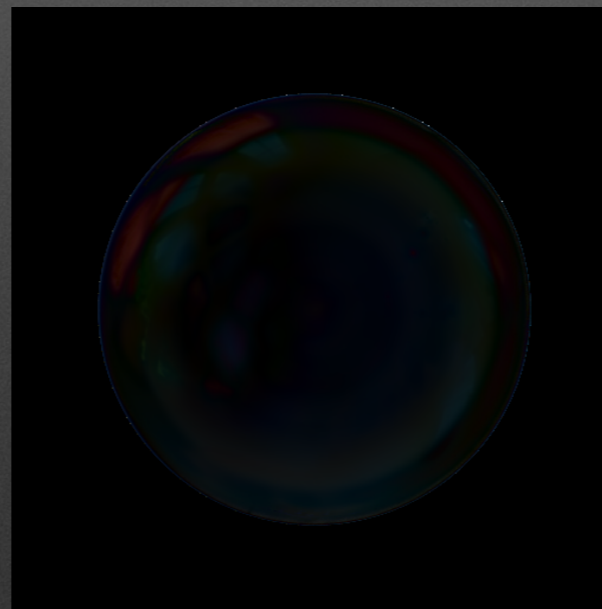

Difference

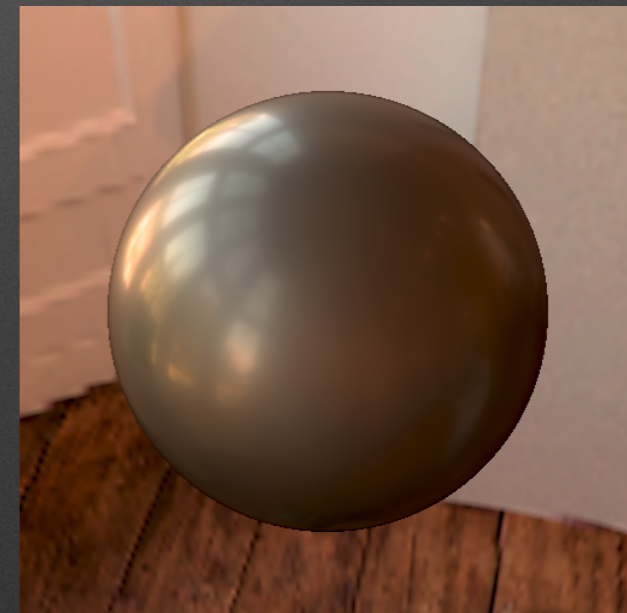

Reference

Fitting Results **outside** the Incident Plane

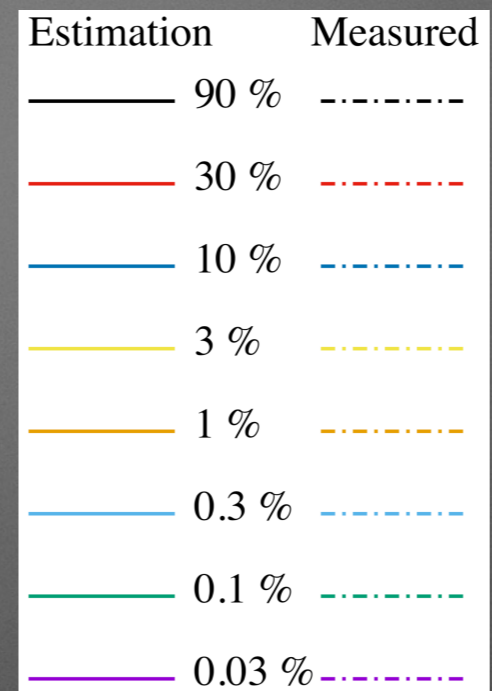
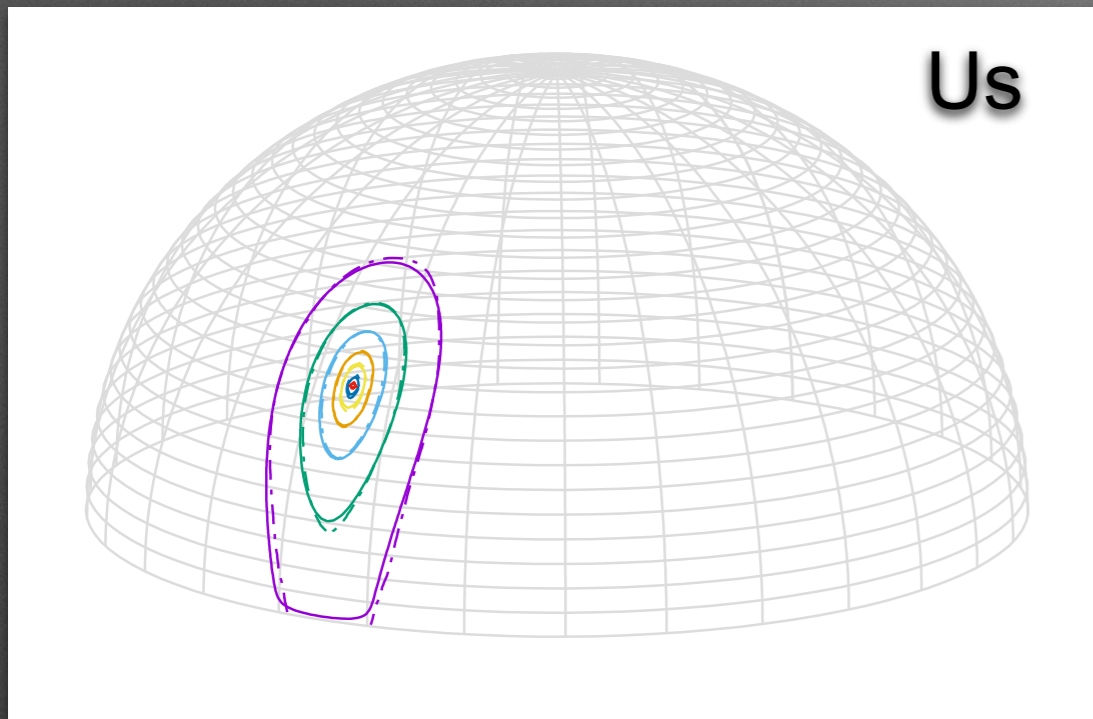

blue-metallic-paint2

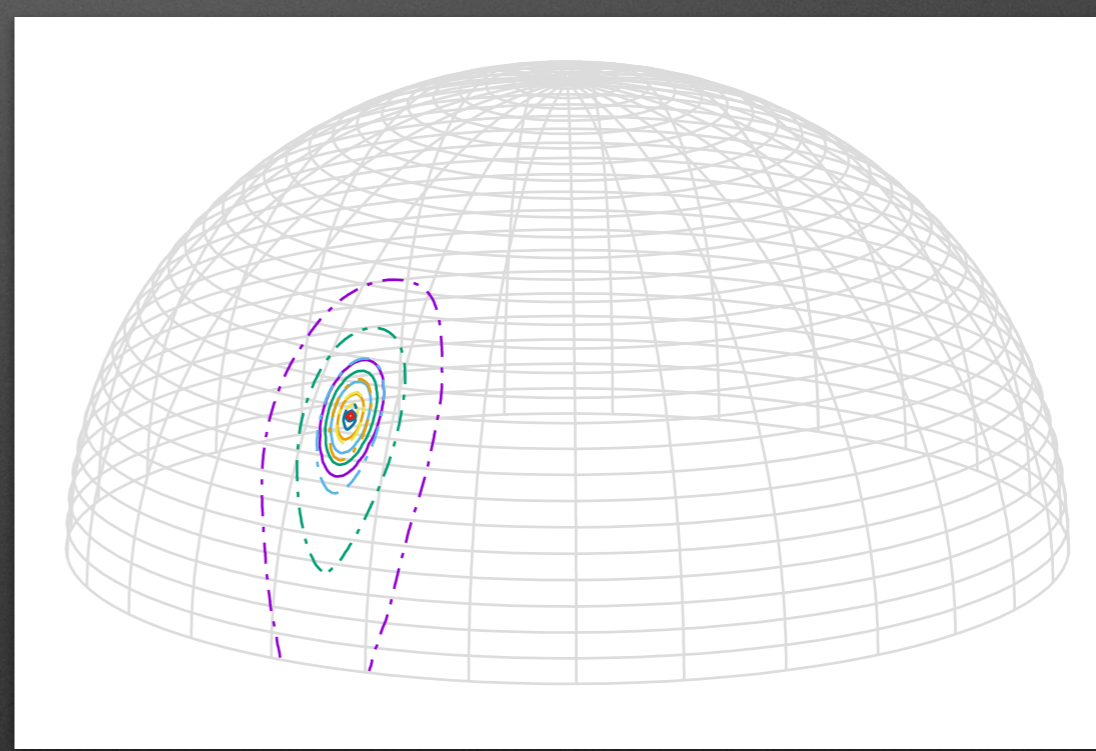
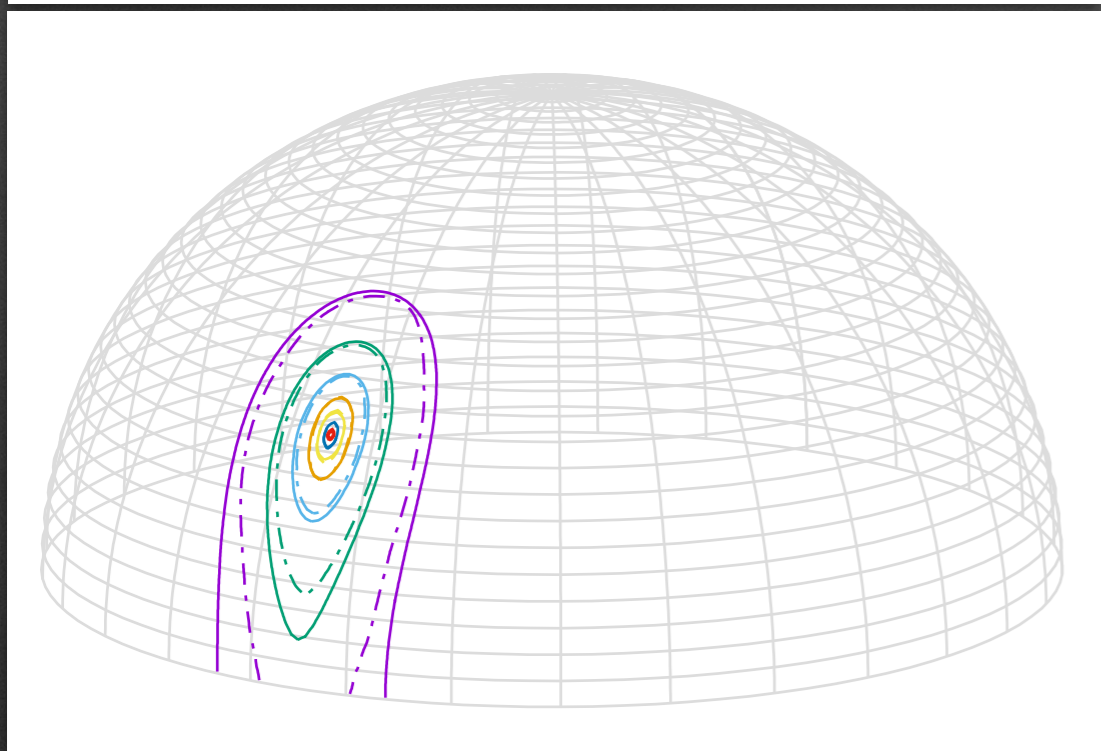

Löw et al. (diffraction only)

SGD (microfacet only)

Lobe width variation

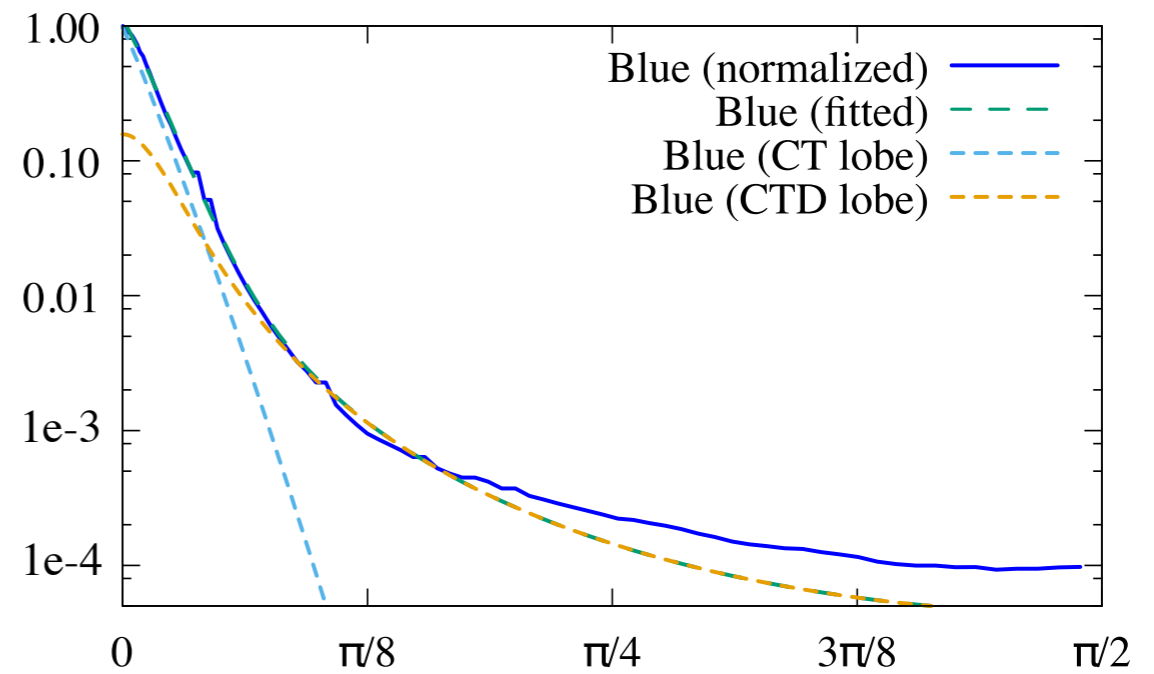
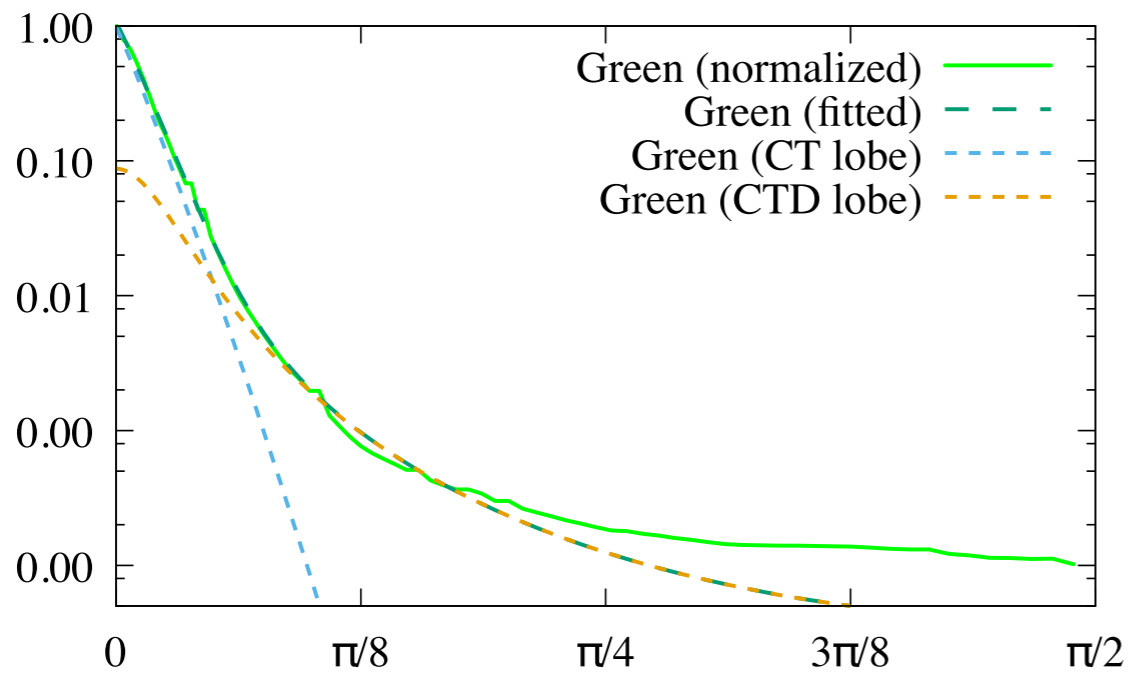
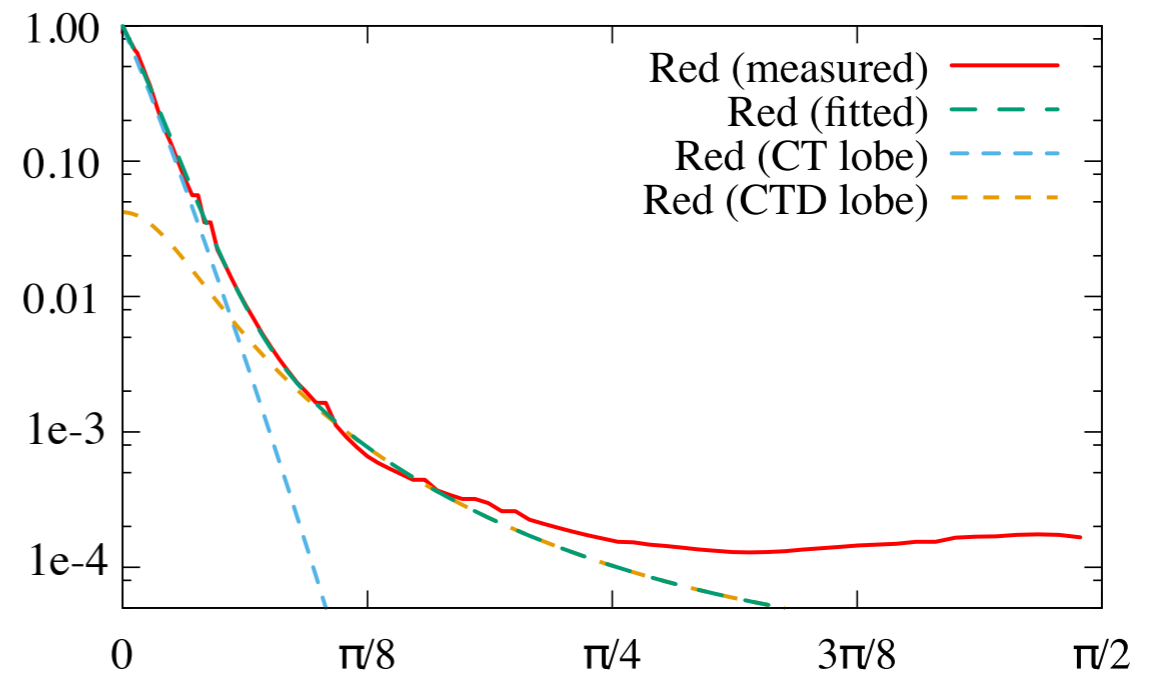
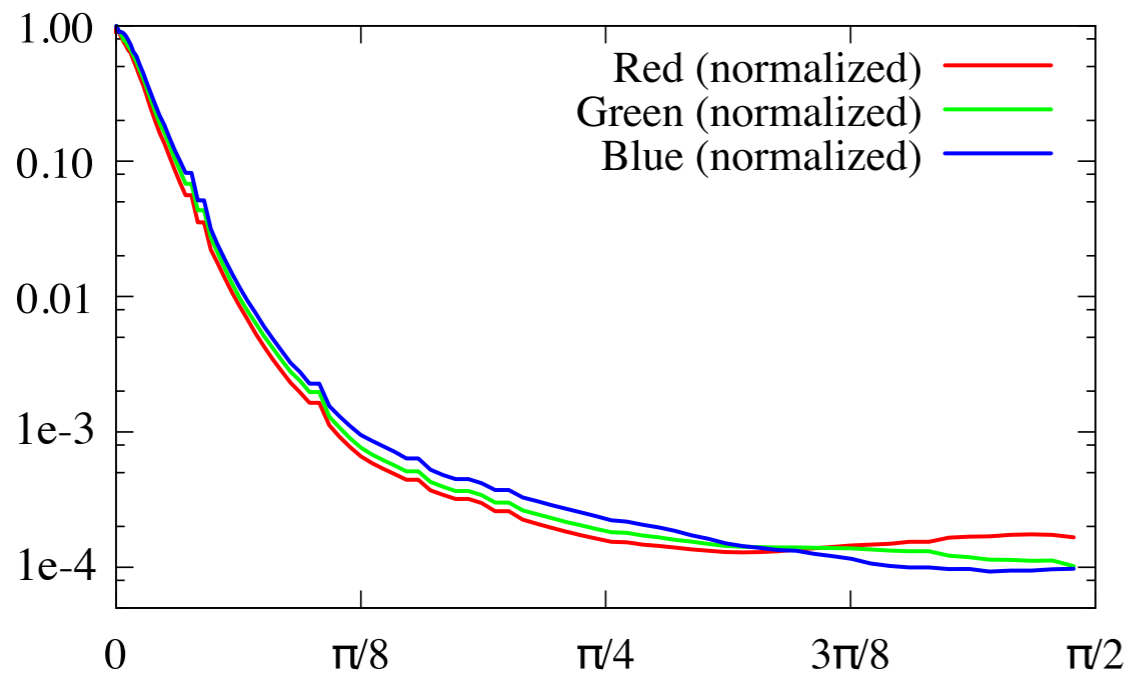

Extension for Plastic Material

$$\rho_{plastic}(\mathbf{i}, \mathbf{o}) = \rho_{conductor}(\mathbf{i}, \mathbf{o}) + \rho_{diffuse}(\mathbf{i}, \mathbf{o})$$

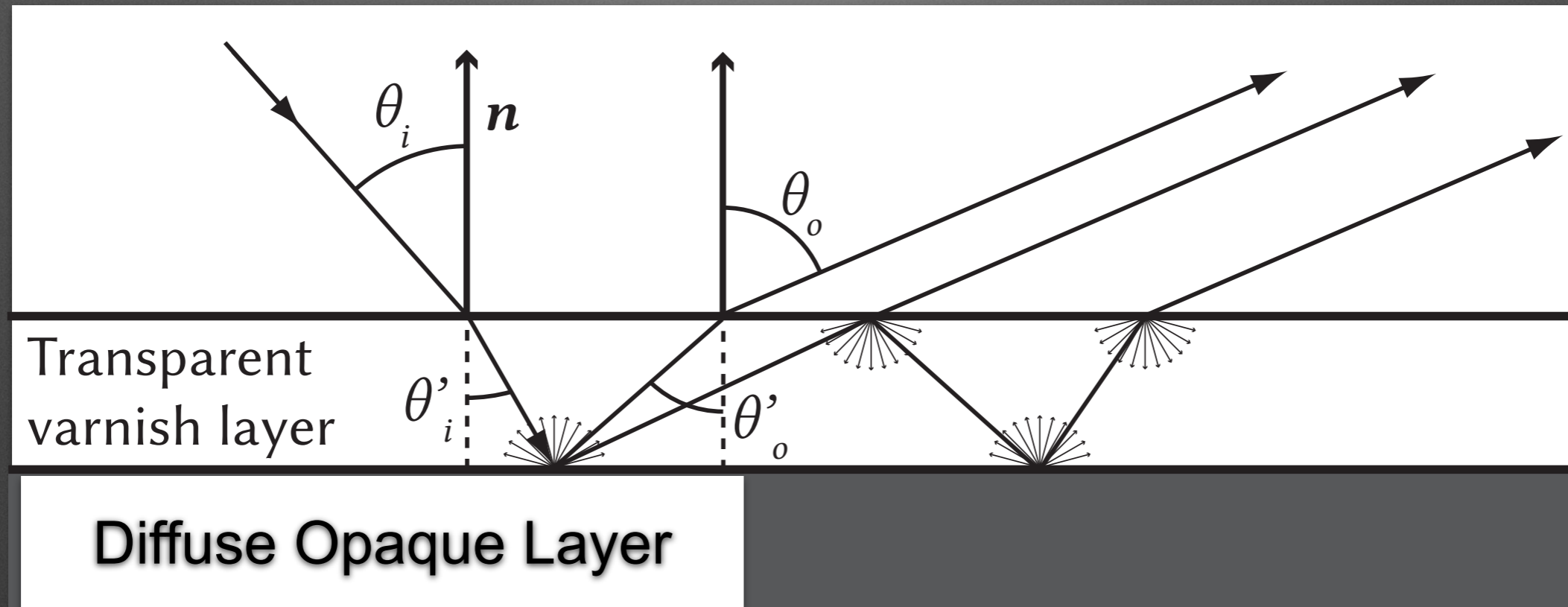

- Diffuse Part: Model from [Weidlich et Wilkie 2007]
- Conductor Part: Real Index of Refraction

Results for Plastic Model

- Varnish on a diffuse surface:



Diffraction

+

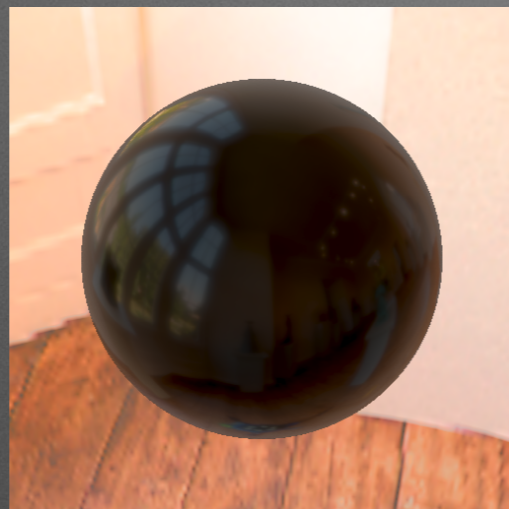

Microfacet

+

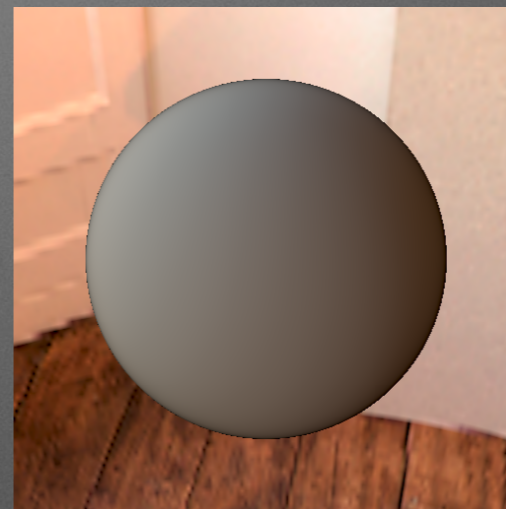

Diffuse

=

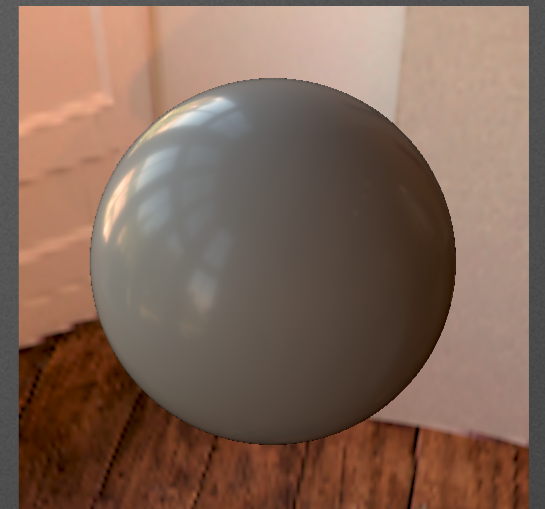

Model

Gray-Plastic Material



Difference

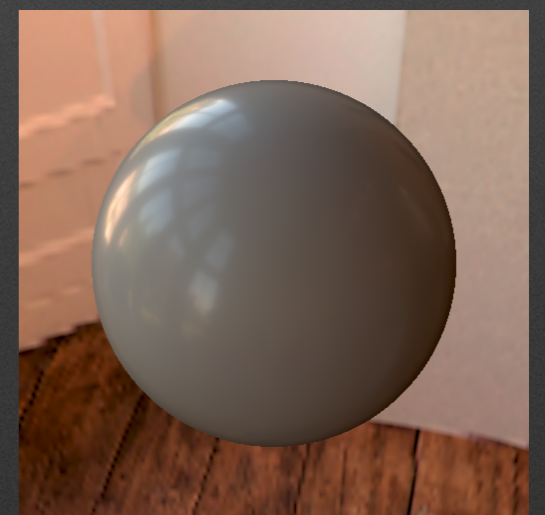

Reference

Fitting Results in Incident Plane

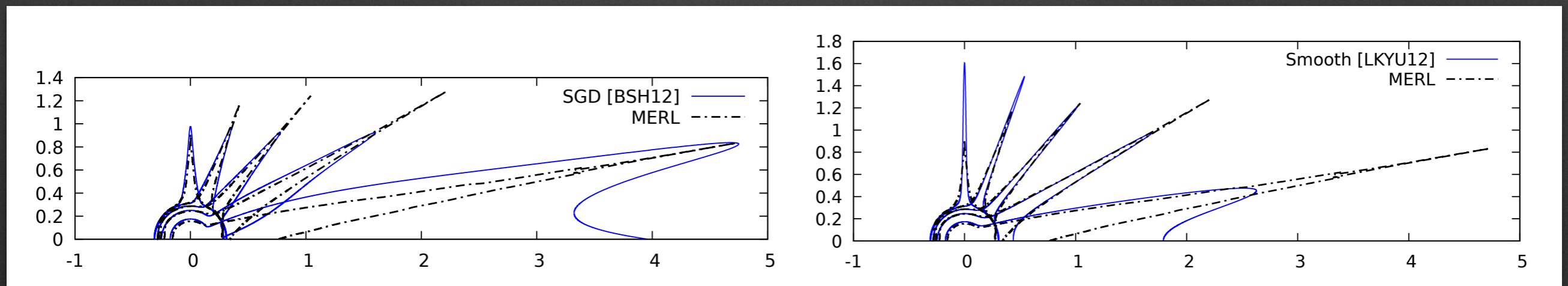
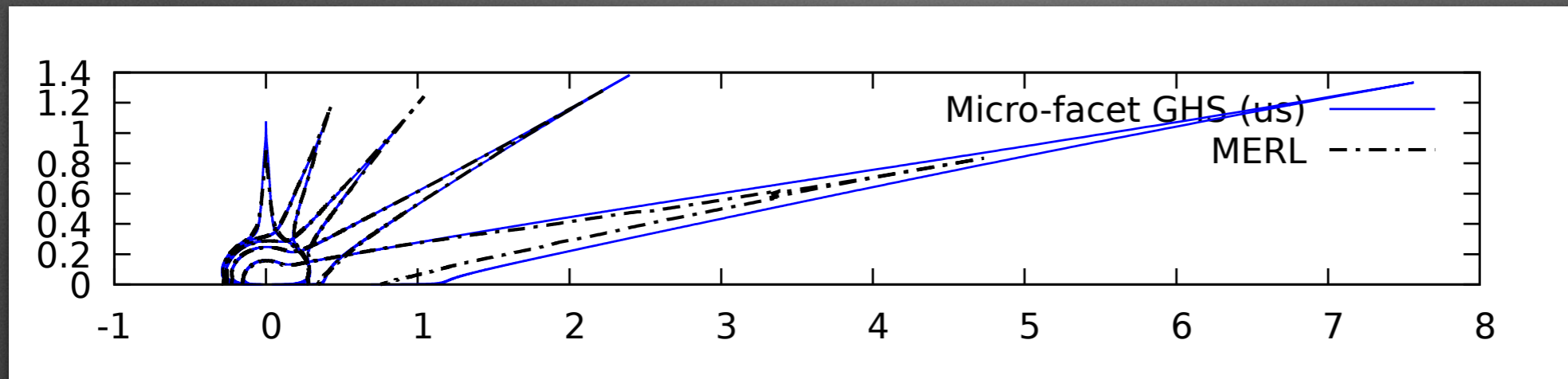

Fitting Results **outside** Incident Plane

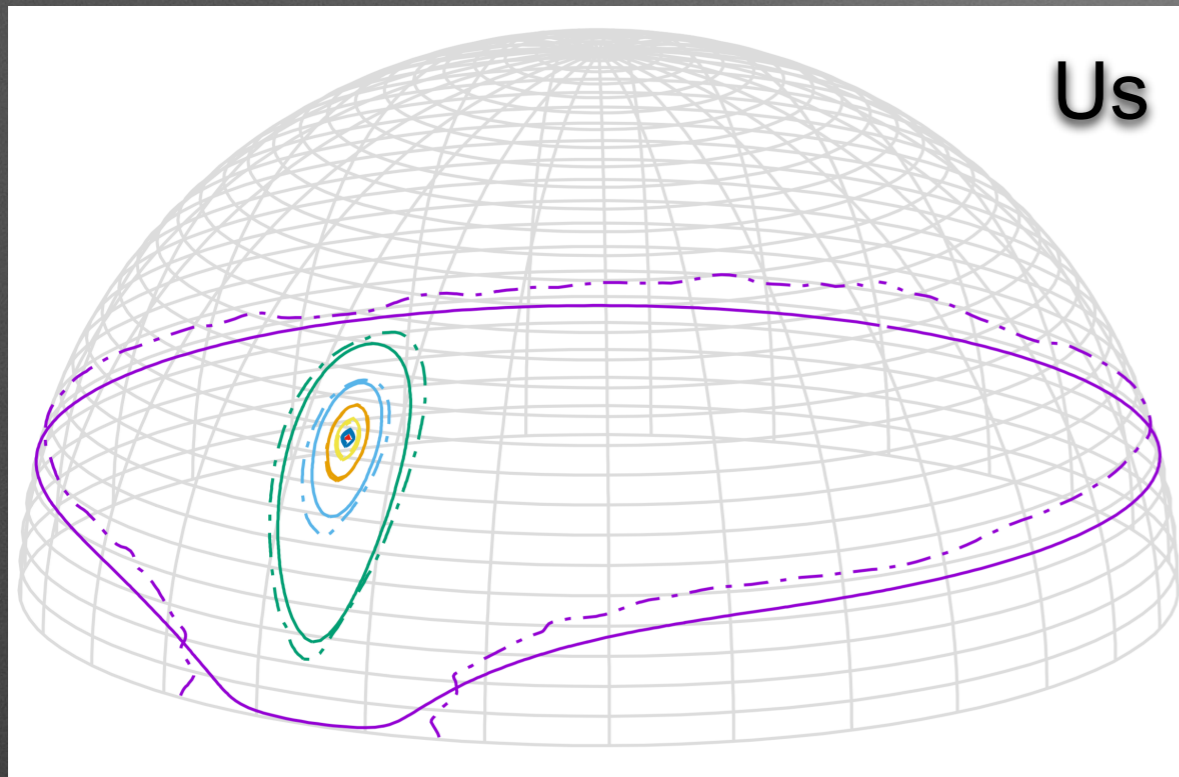

Our Model



Gray-plastic

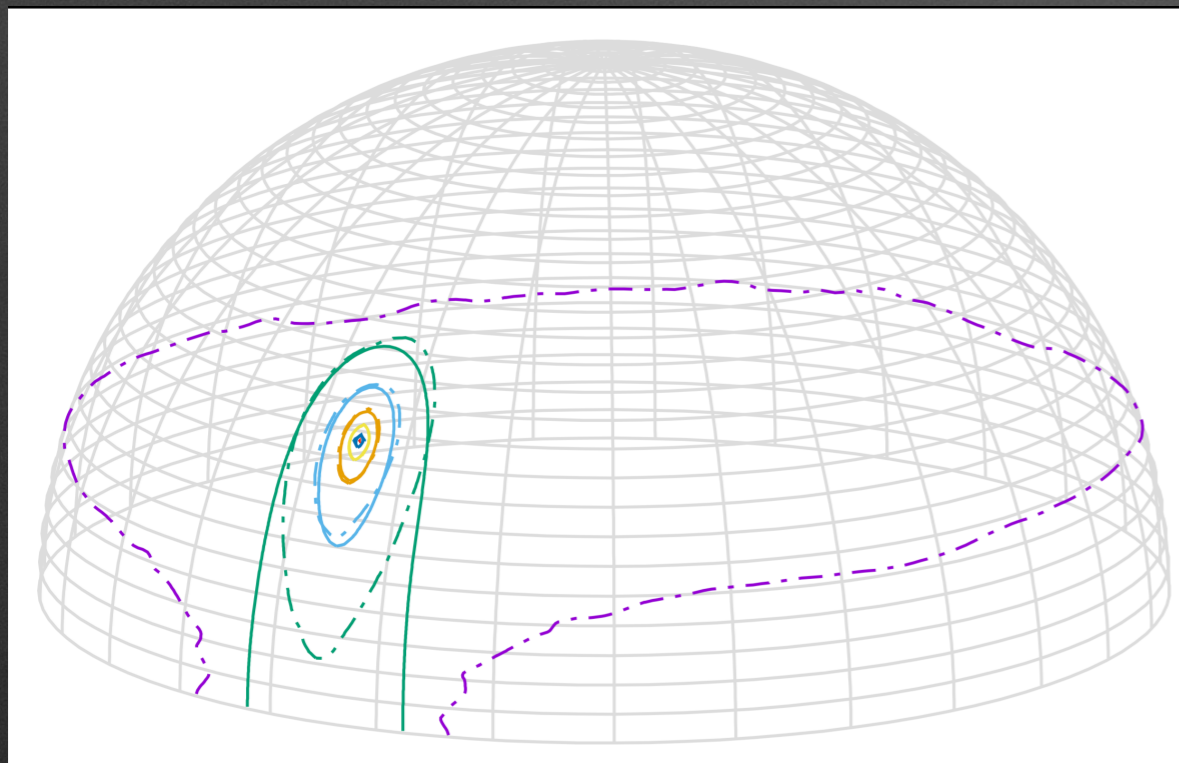

Löw et al. (diffraction only)

Two-Layer Model for Subsurface

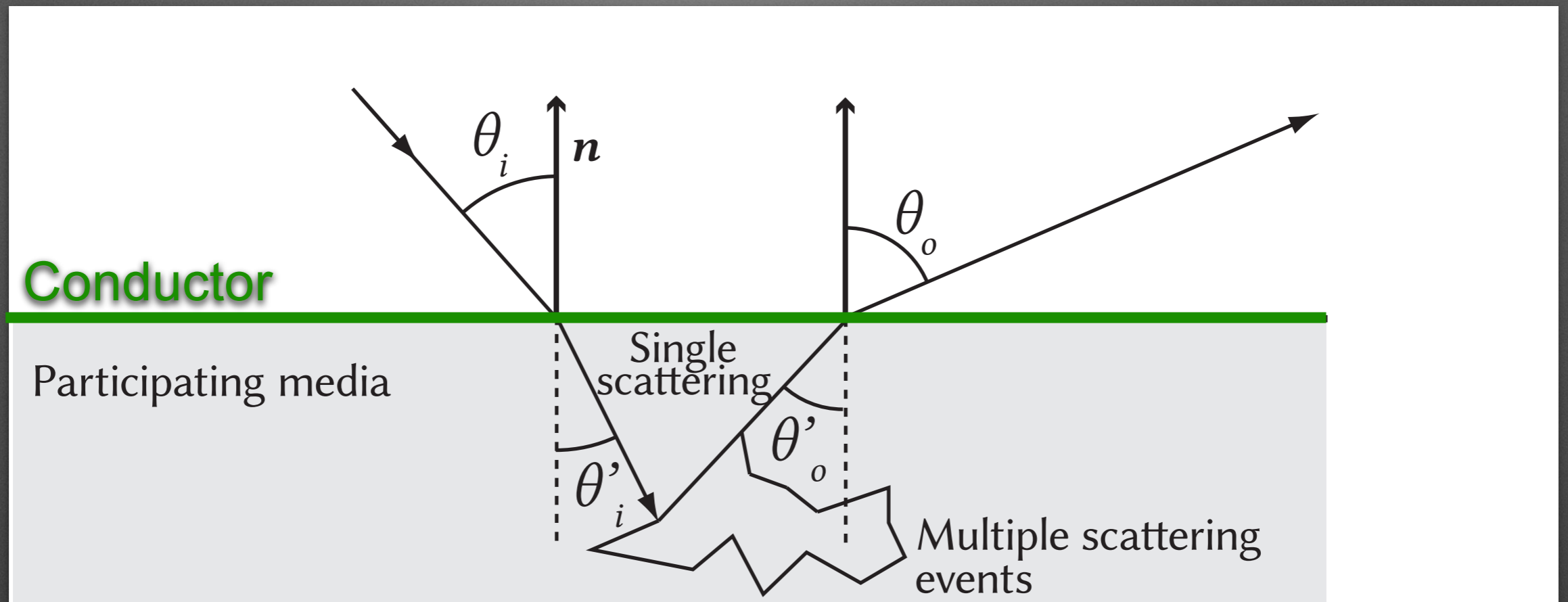

$$\rho_{subsurface}(i, o) = \rho_{conductor}(i, o) + \underbrace{\rho_{single}(i, o) + \rho_{multi}(i, o)}$$

Subsurface Model from Jensen et al. Sigg. 2001

Result for Subsurface Model

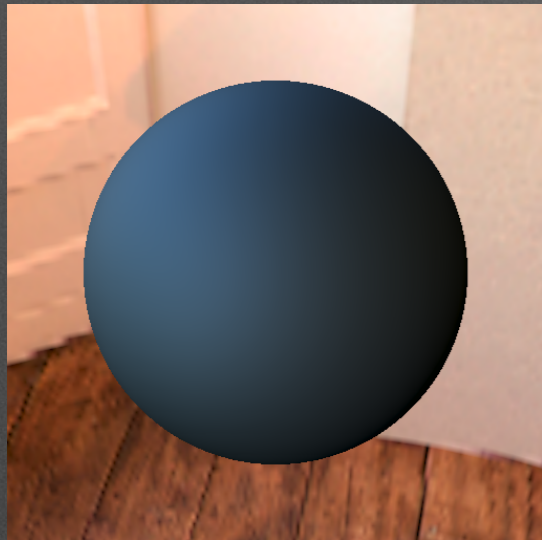

Diffraction

+

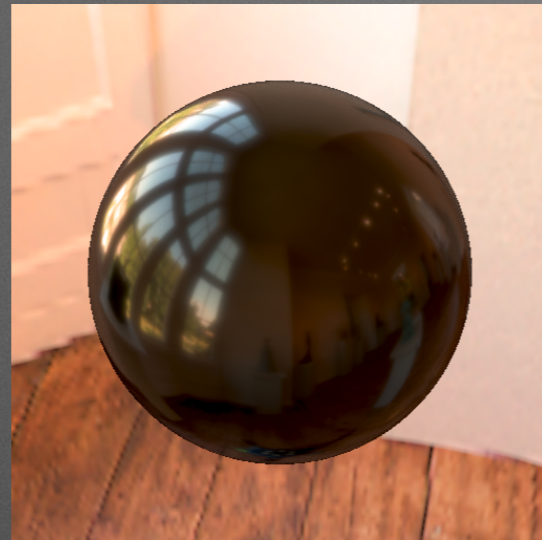

Microfacet

+

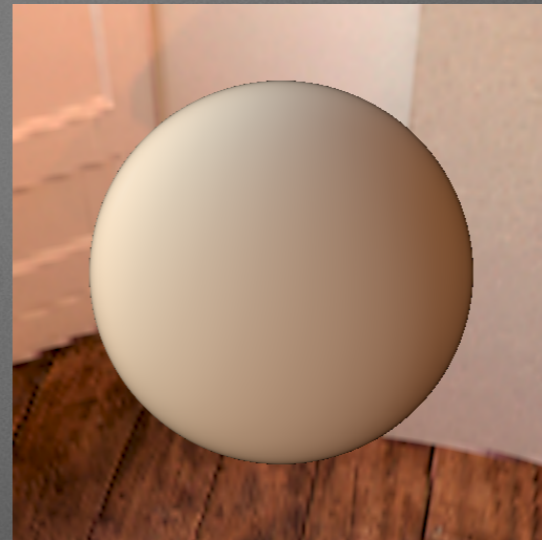

Diffuse

=

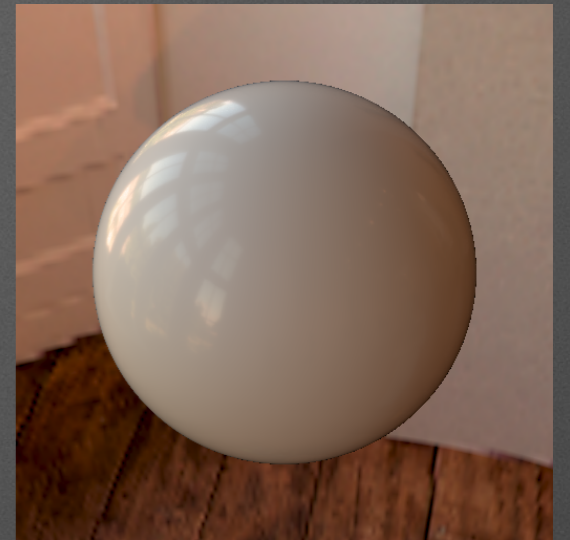

Model

Alumina-oxide Material

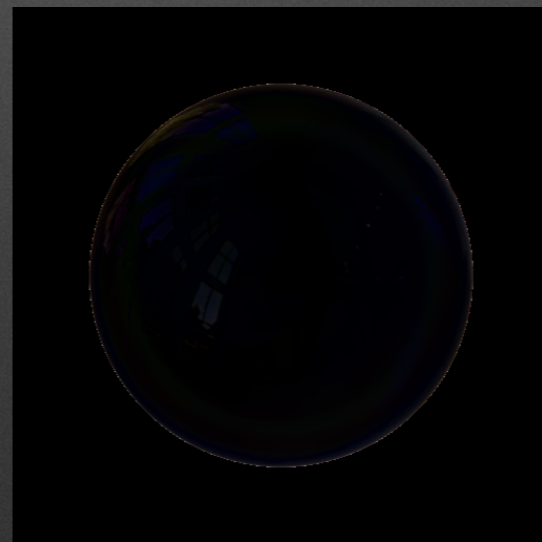

Difference

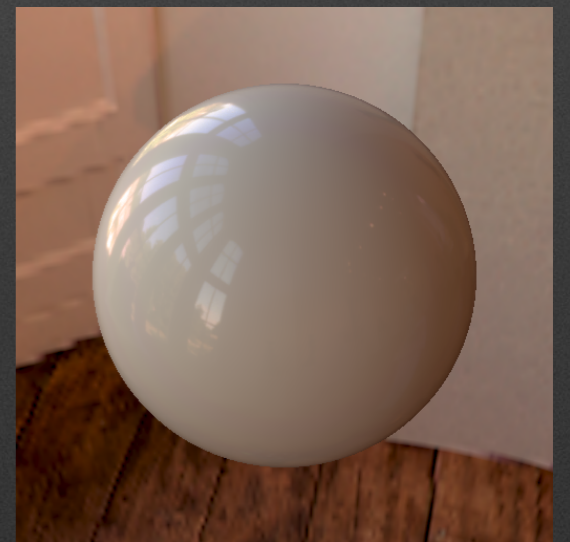

Reference

Result for Subsurface Model

ALUMINA-OXYDE

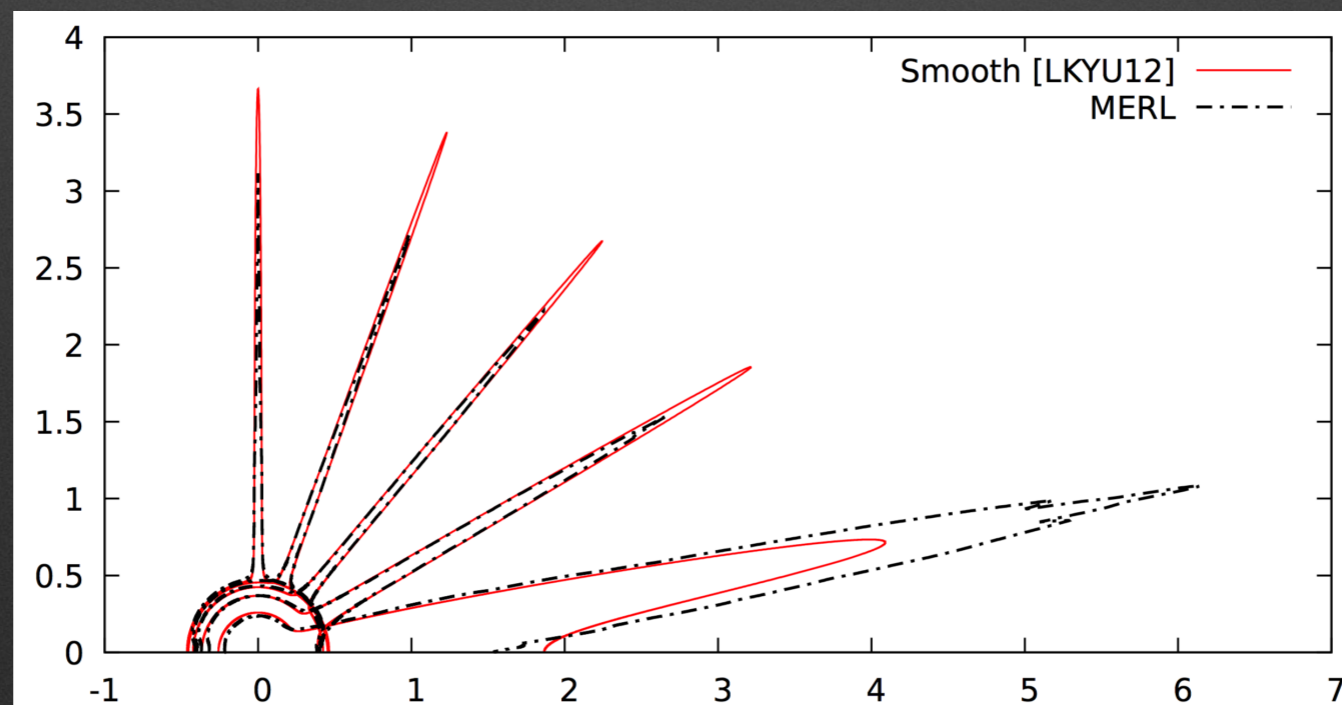
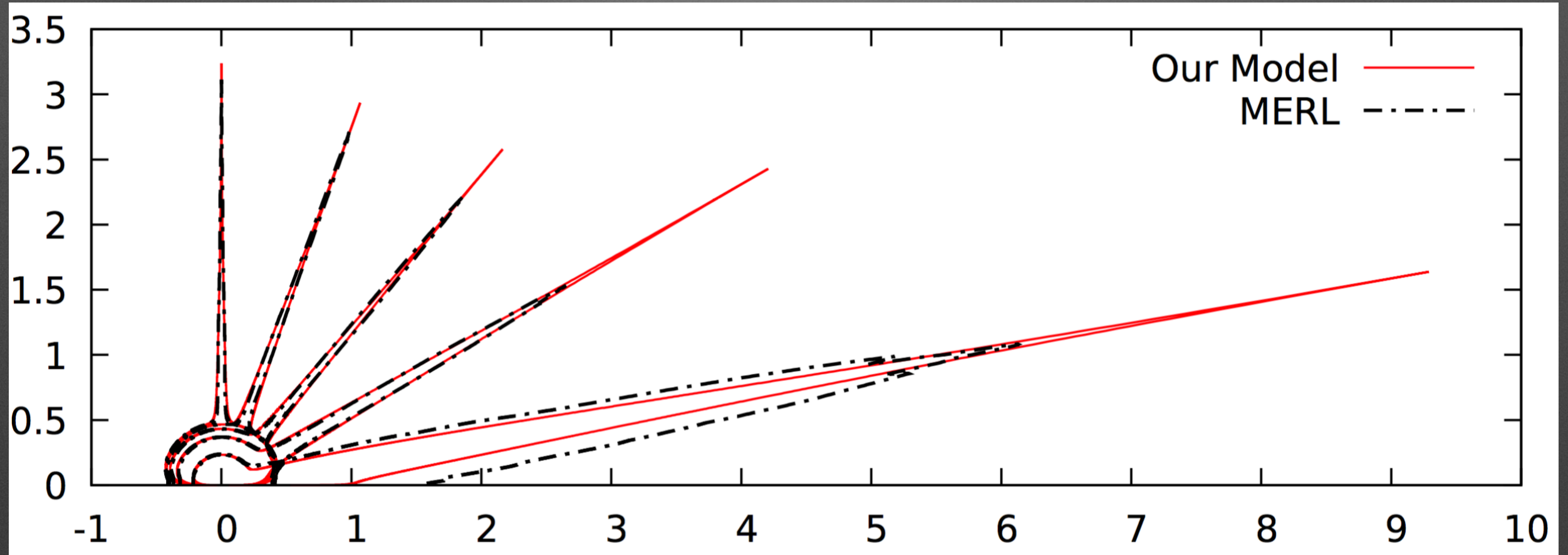

Result for Subsurface Model

ALUMINA-OXYDE

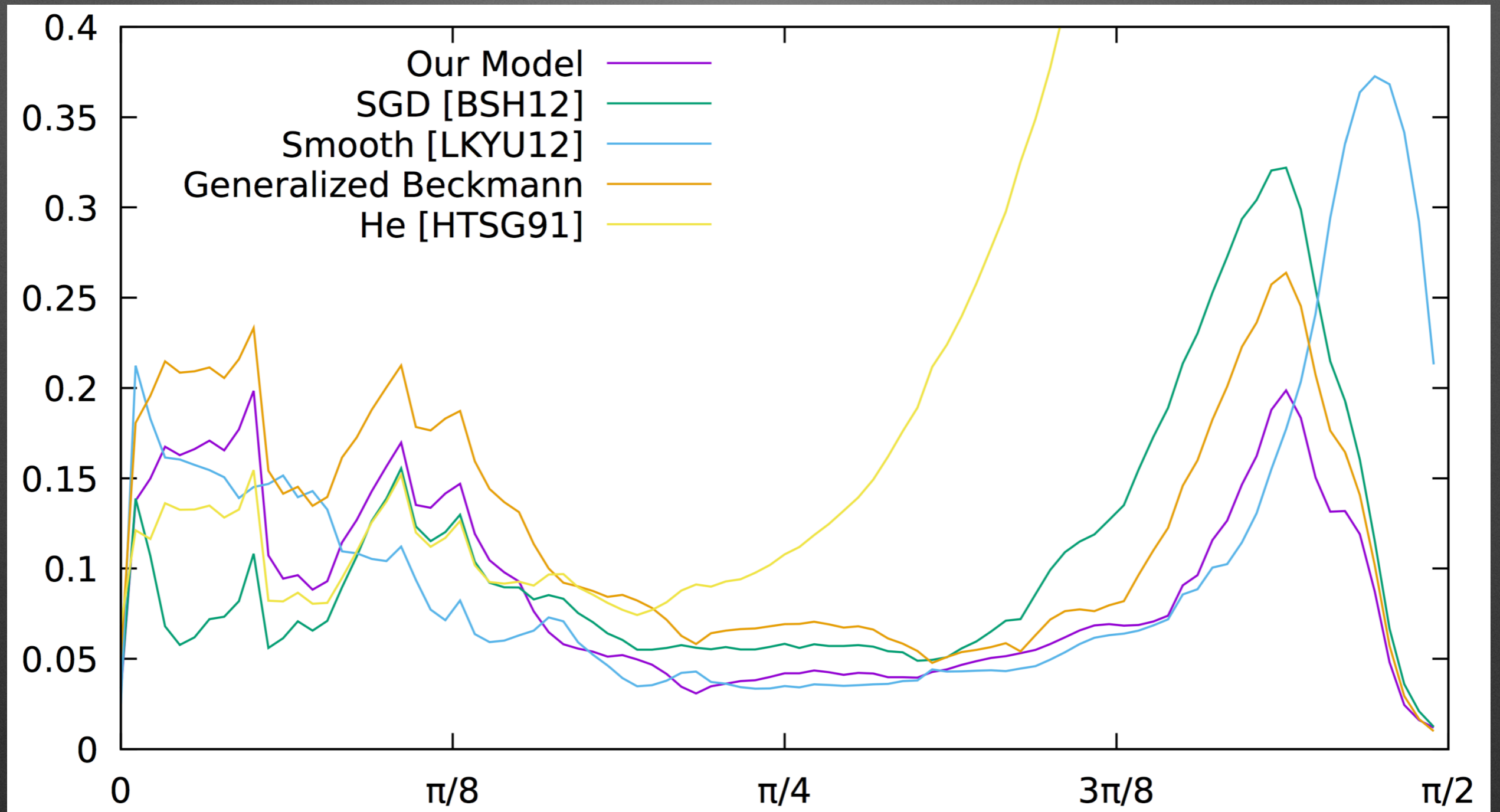

RMS Error of BRDF * cosine

Fitting Strategy

- Similar to Bagher et al. 2016
 - Compressive Weights \Leftrightarrow less weight on high values
 - Measurement **Apparatus Compensation**
- **One Pass** of all parameters
- Approx. 10 minutes on 2.6 GHz Intel i7
 - C++. Levenberg-Marquardt impl. Lourakis

General Fitting Comparisons

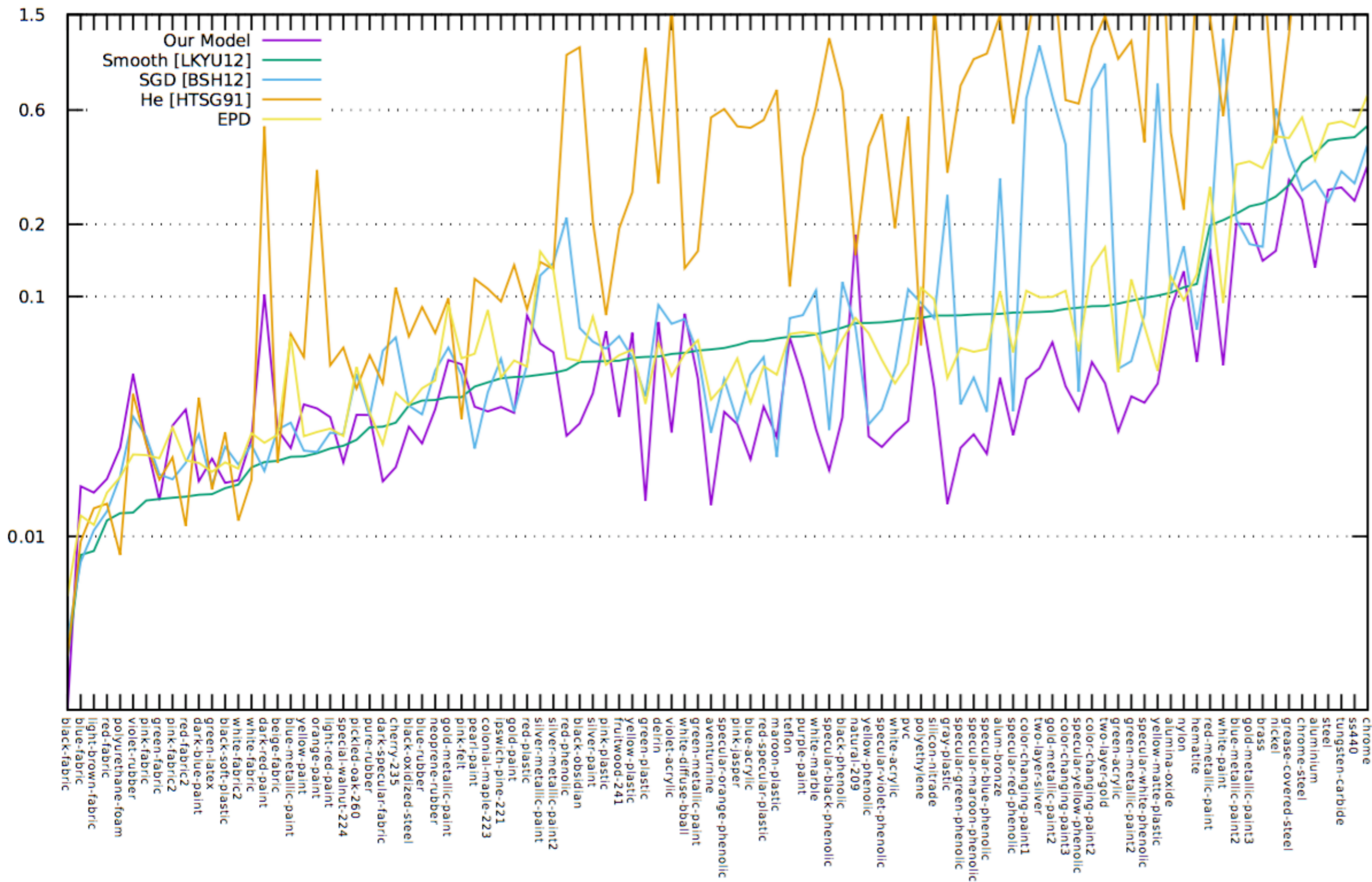

Rendering Comparisons : SMAPE Metric

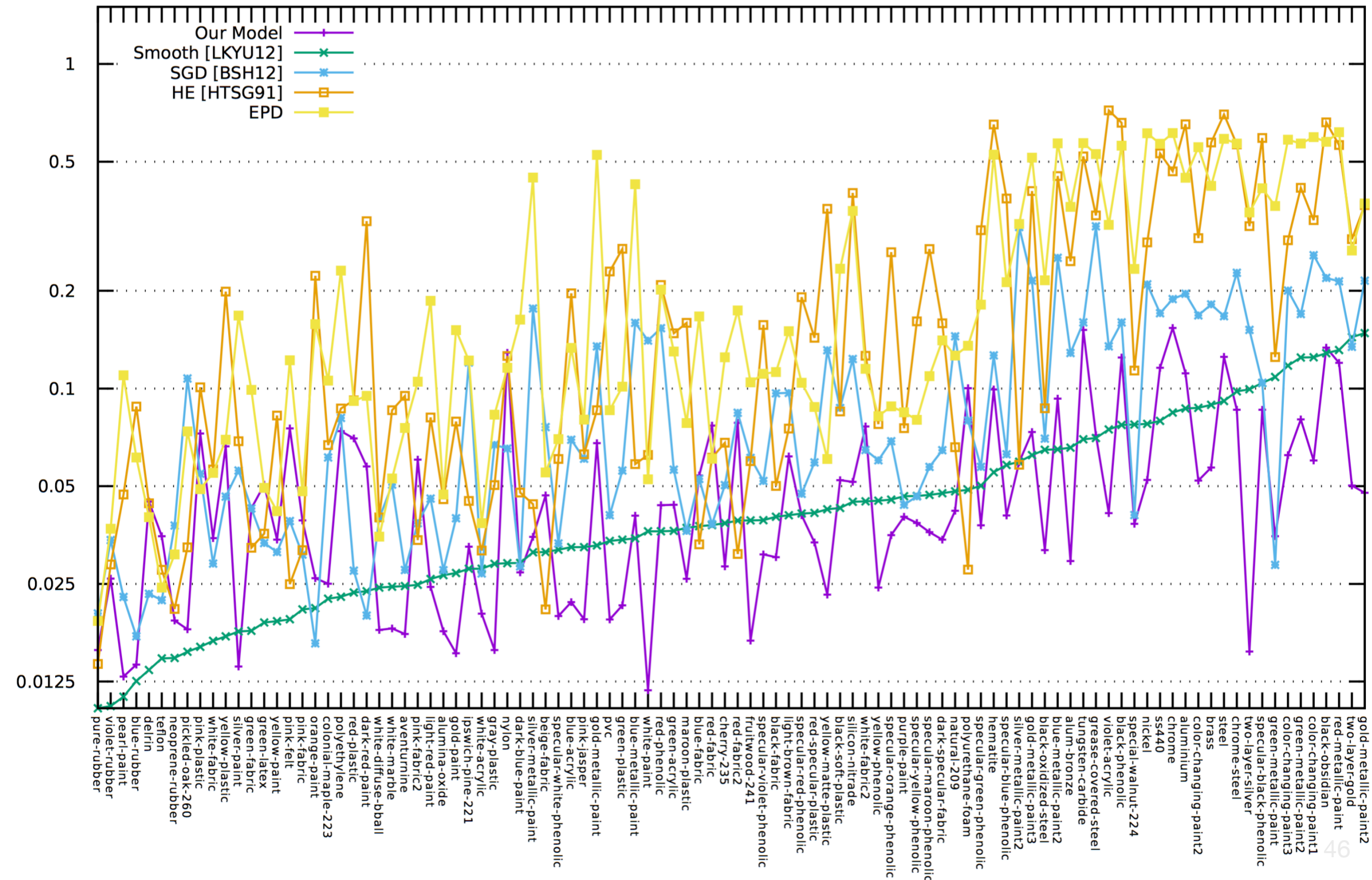

Rendering Comparisons : SMAPE Metric

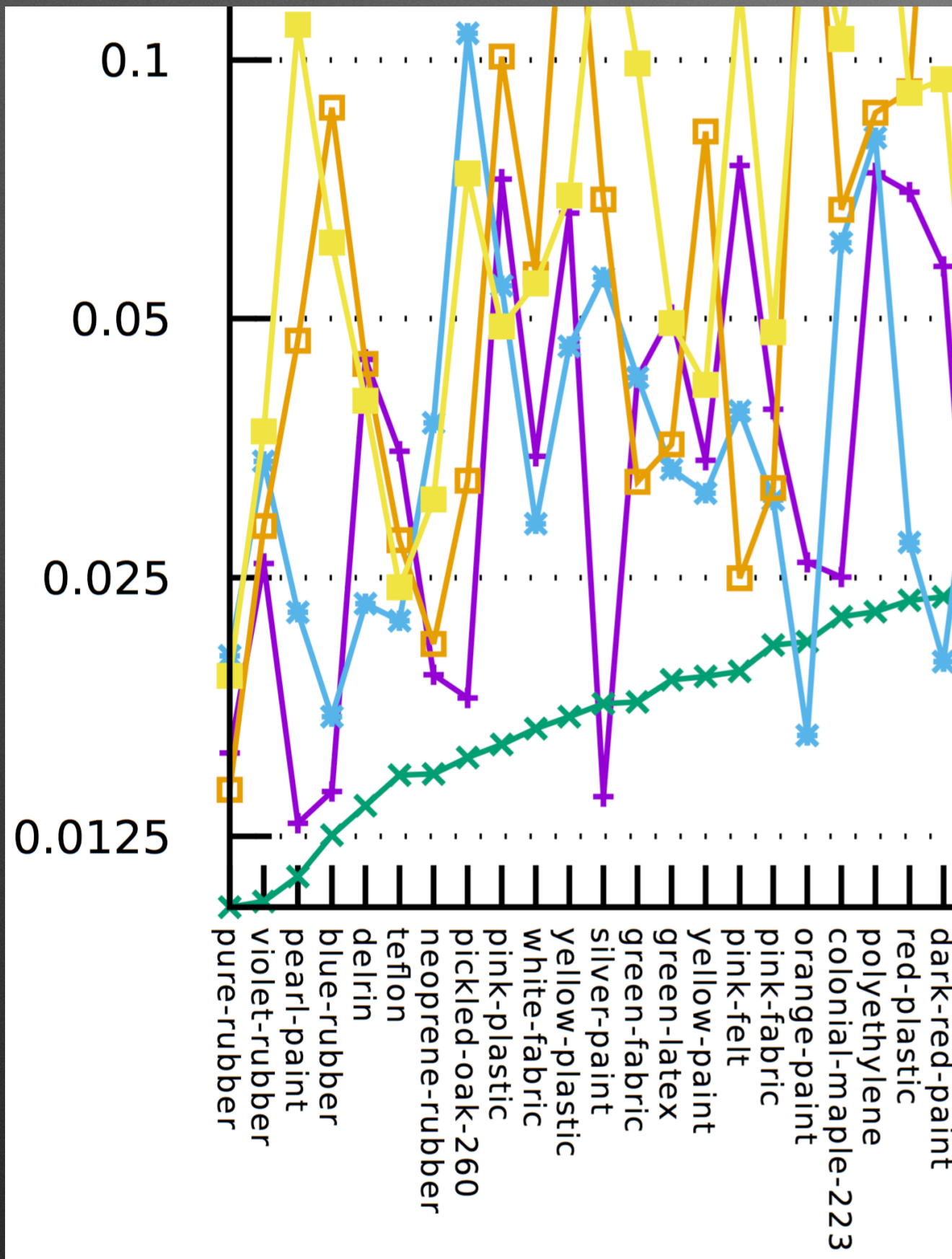

Bad Fits:

Pink Plastic

Pink Felt

Gold-Metallic Paint 2

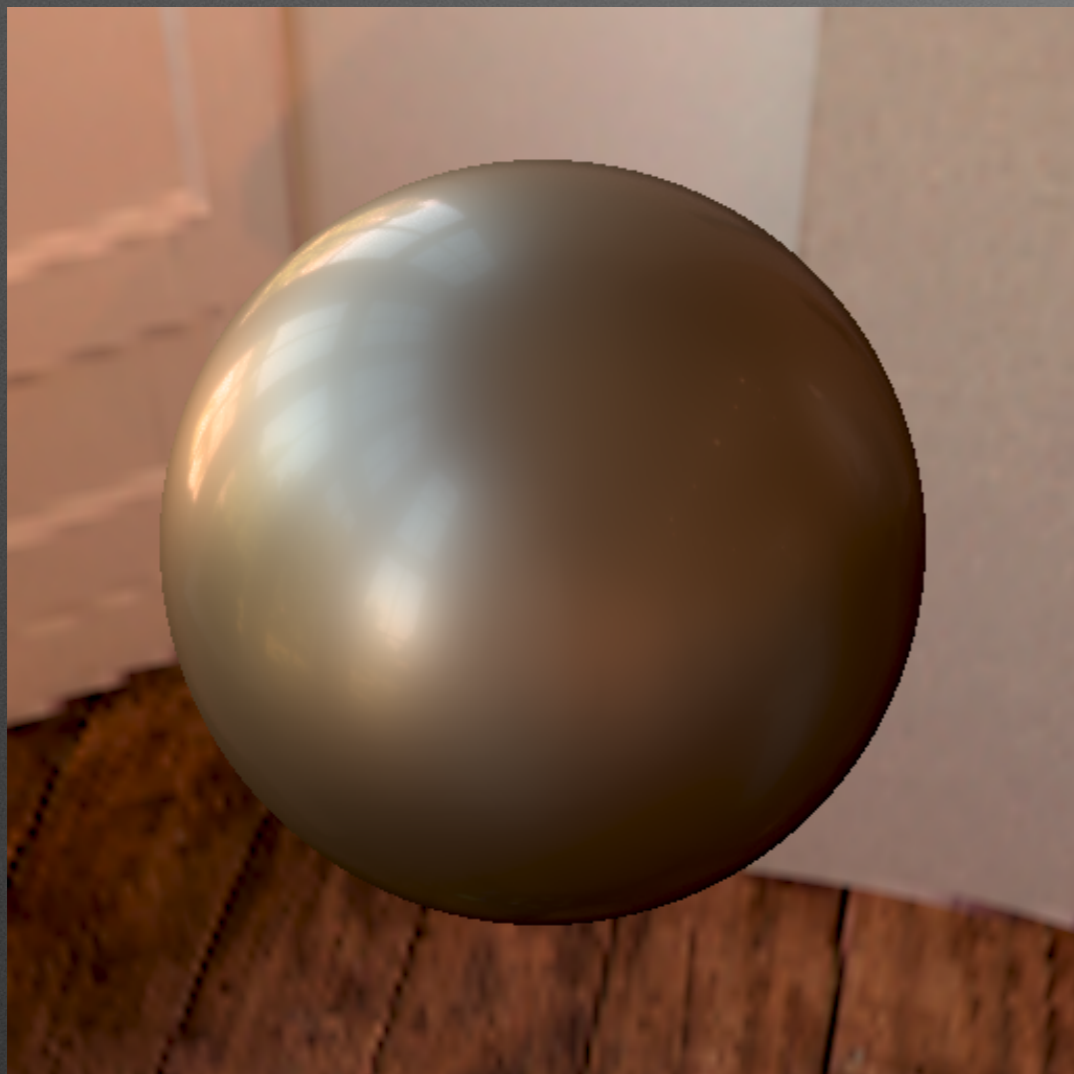

Merl Data Reference

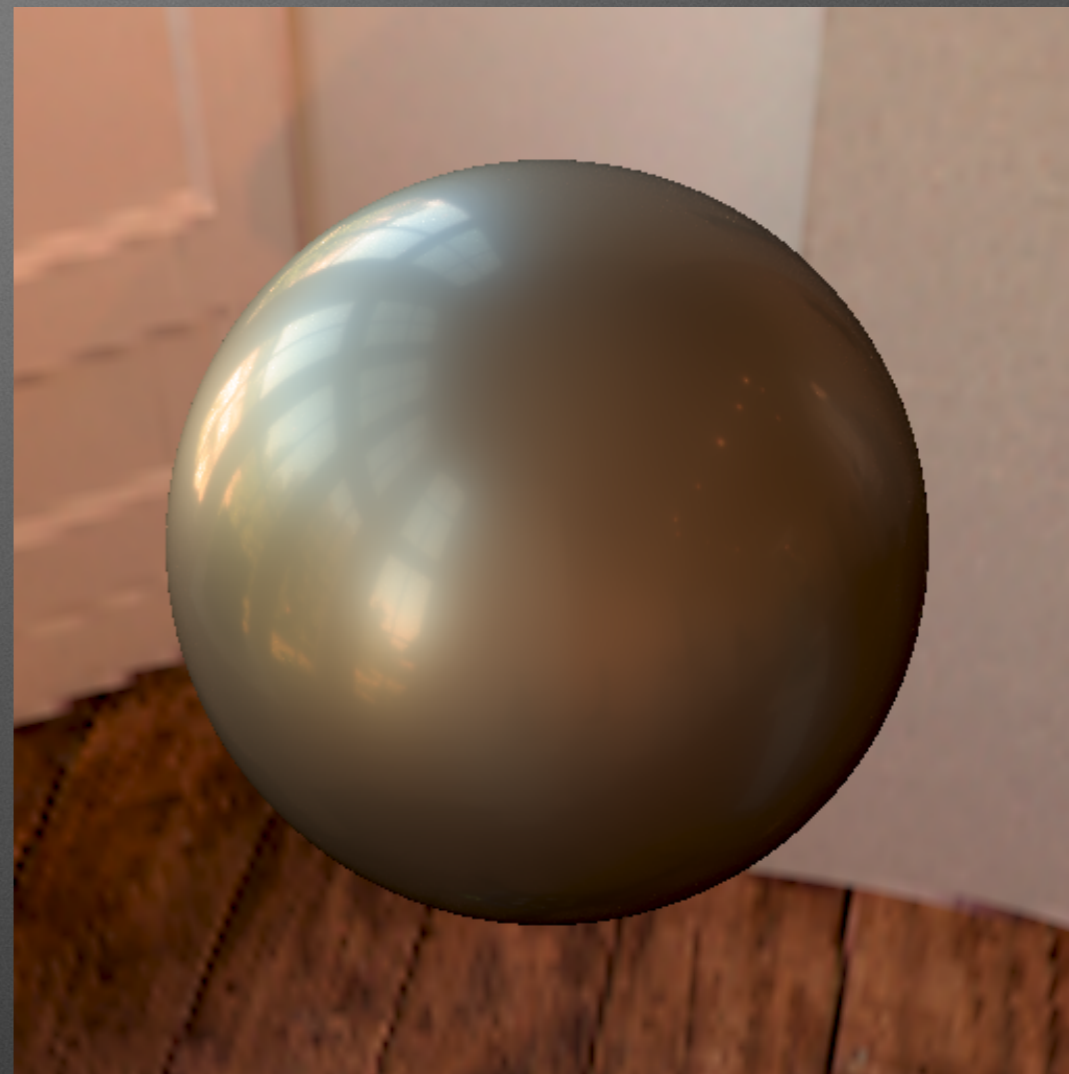

Our Model

Gold-Metallic Paint 2

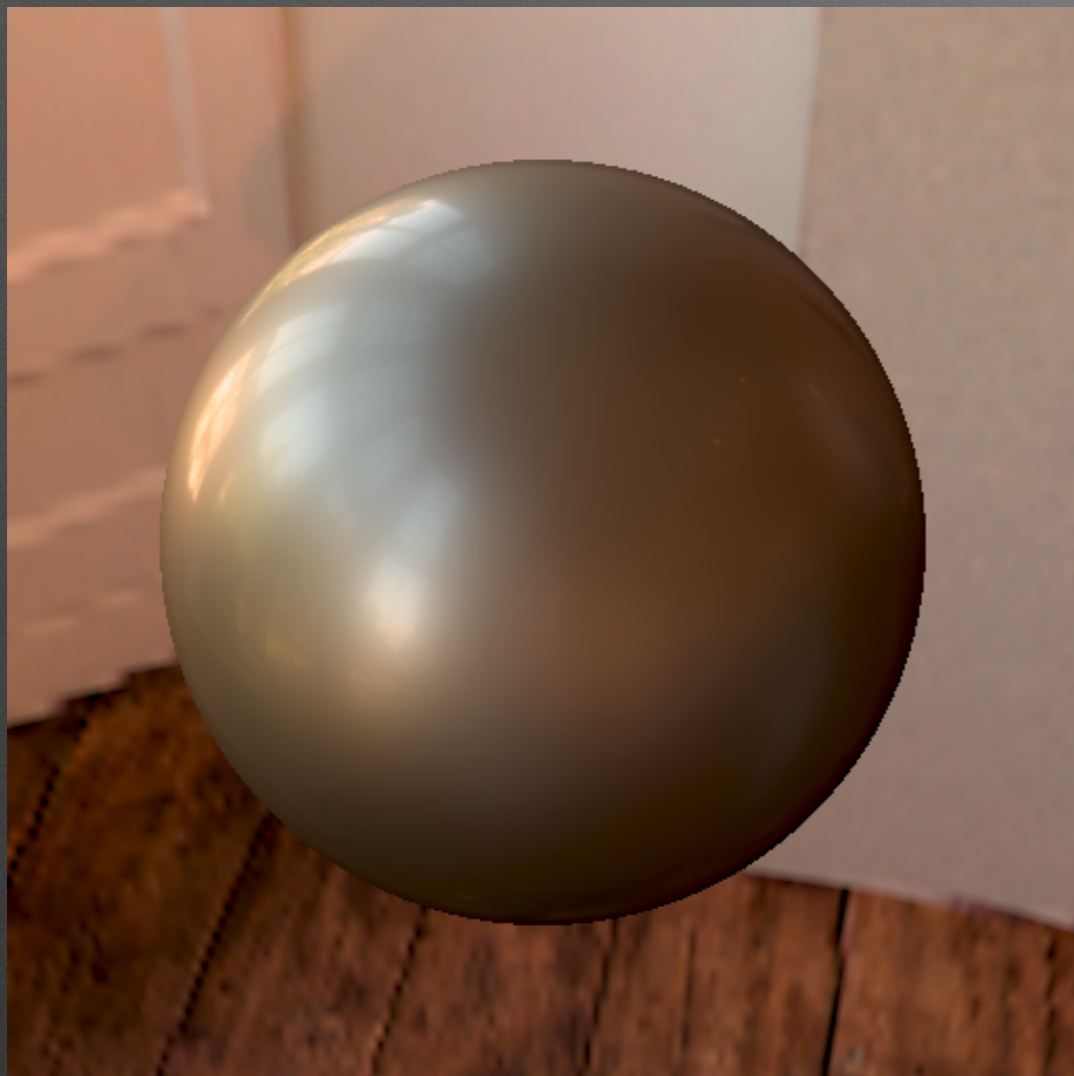

Merl Data Reference

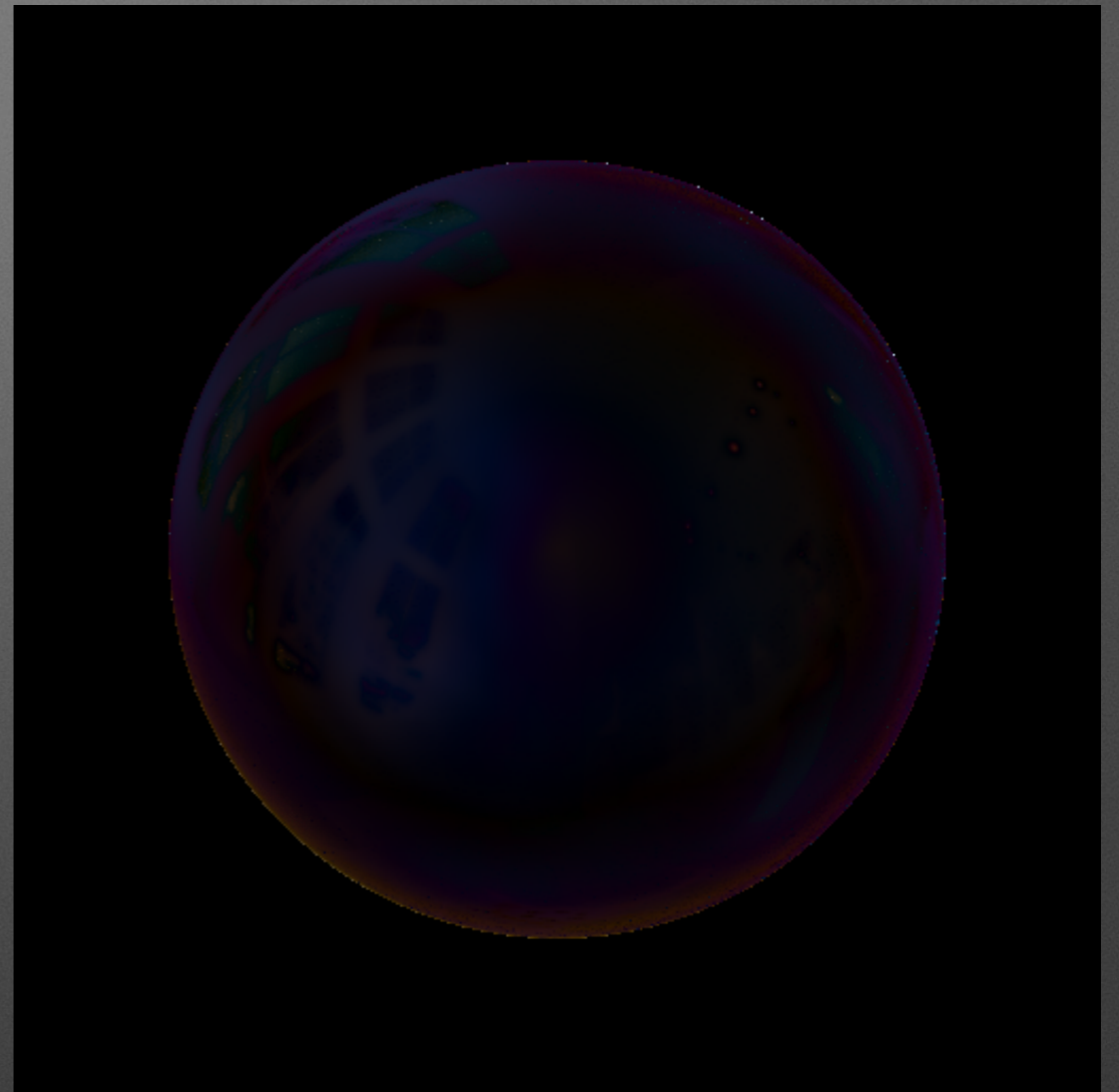

Our Model
Difference sMAPE:0.048

Gold Metallic Paint2

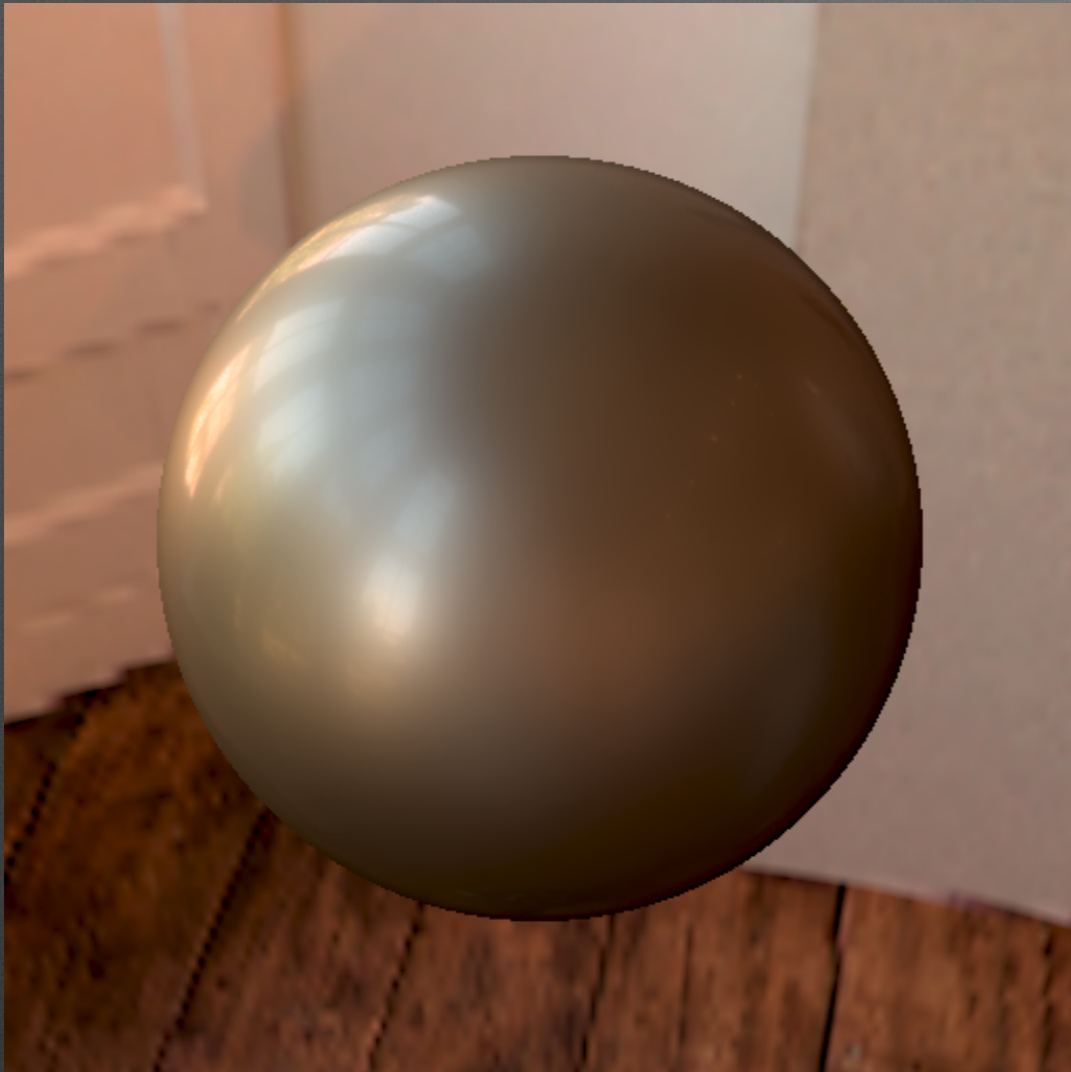

Merl Data Reference

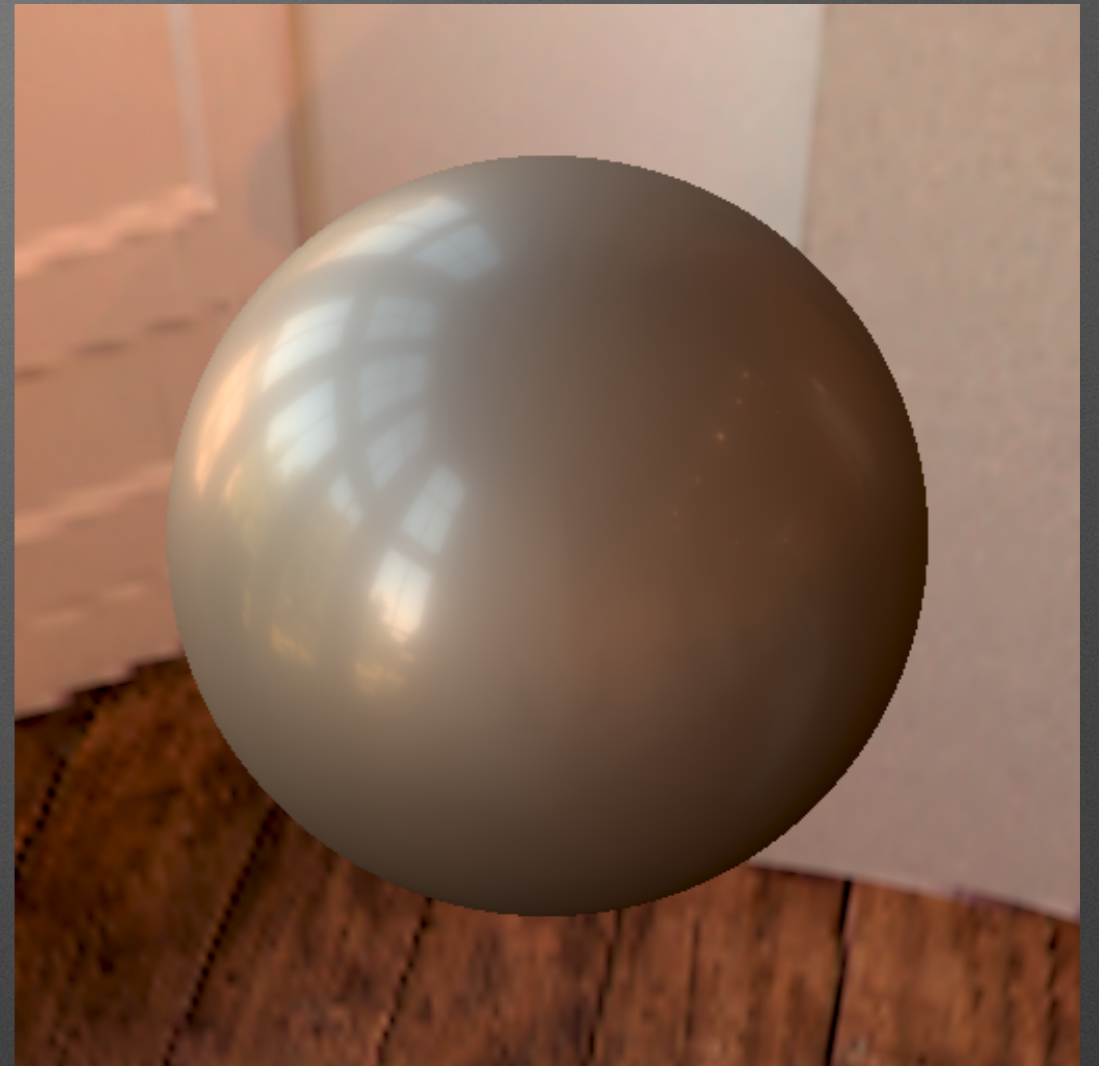

Löw Model

Gold Metallic Paint2

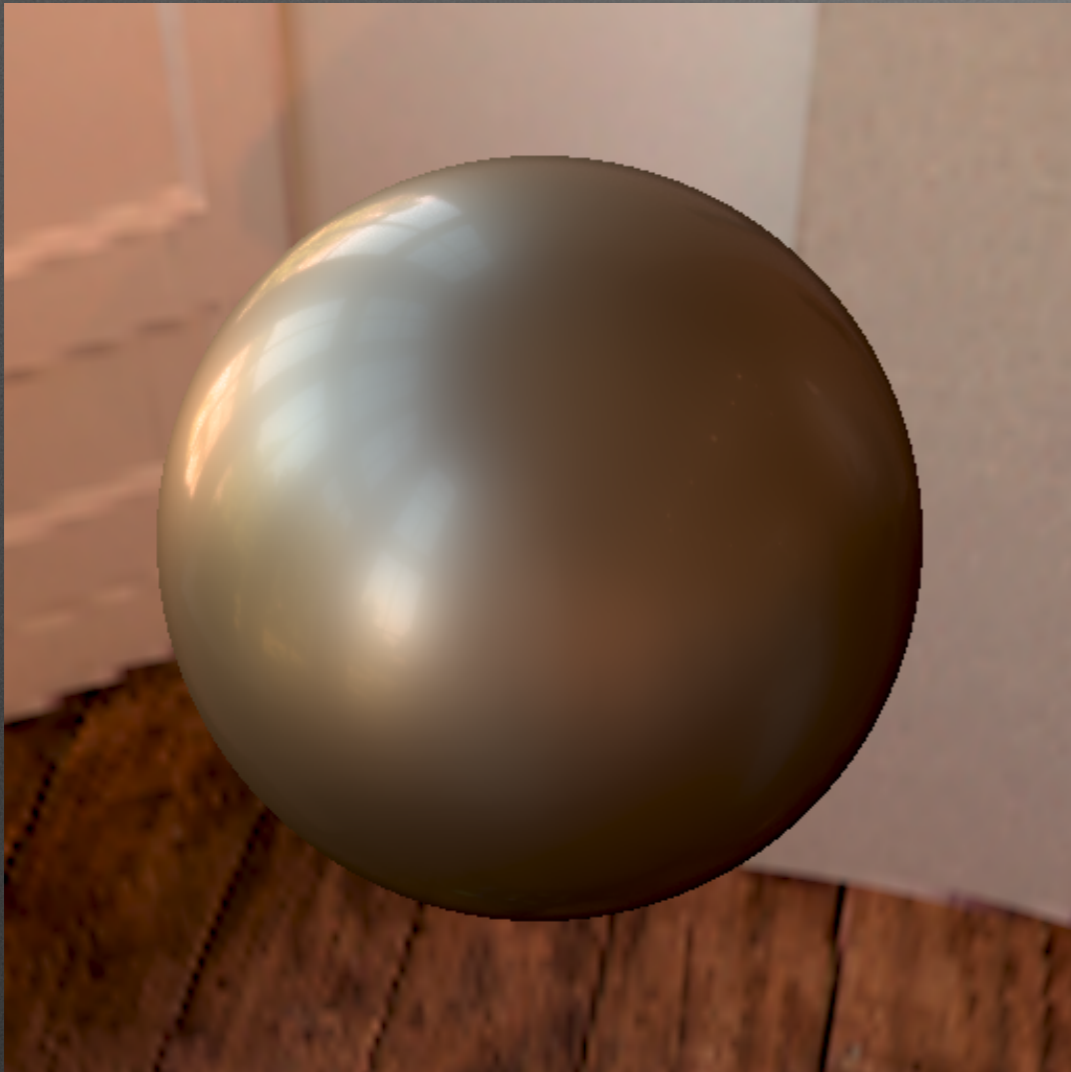

Merl Data Reference

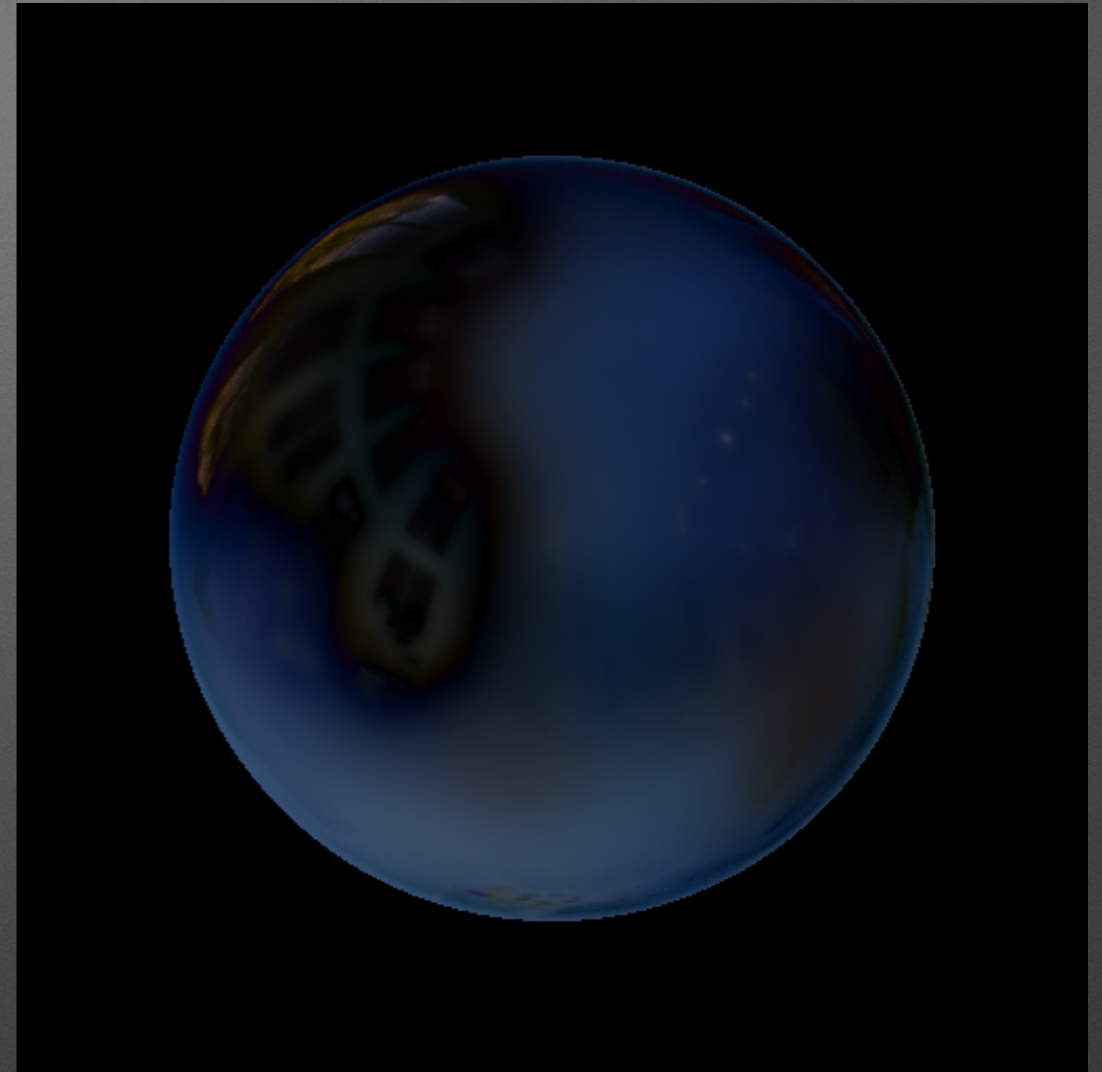

Löv Model
Diff. sMAPE: 0.148

Gold Metallic Paint2

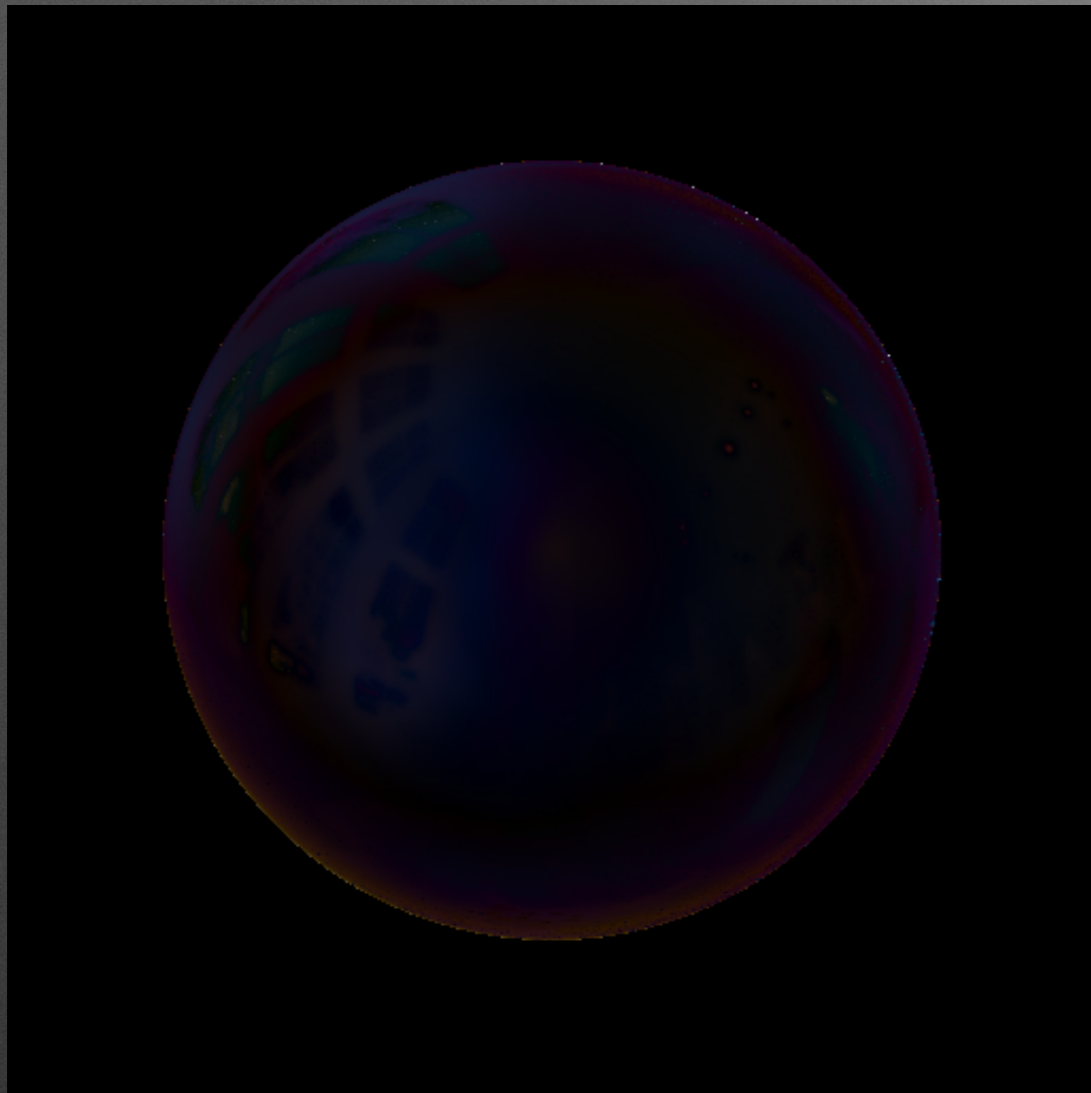

Our Model
Difference sMAPE:0.048

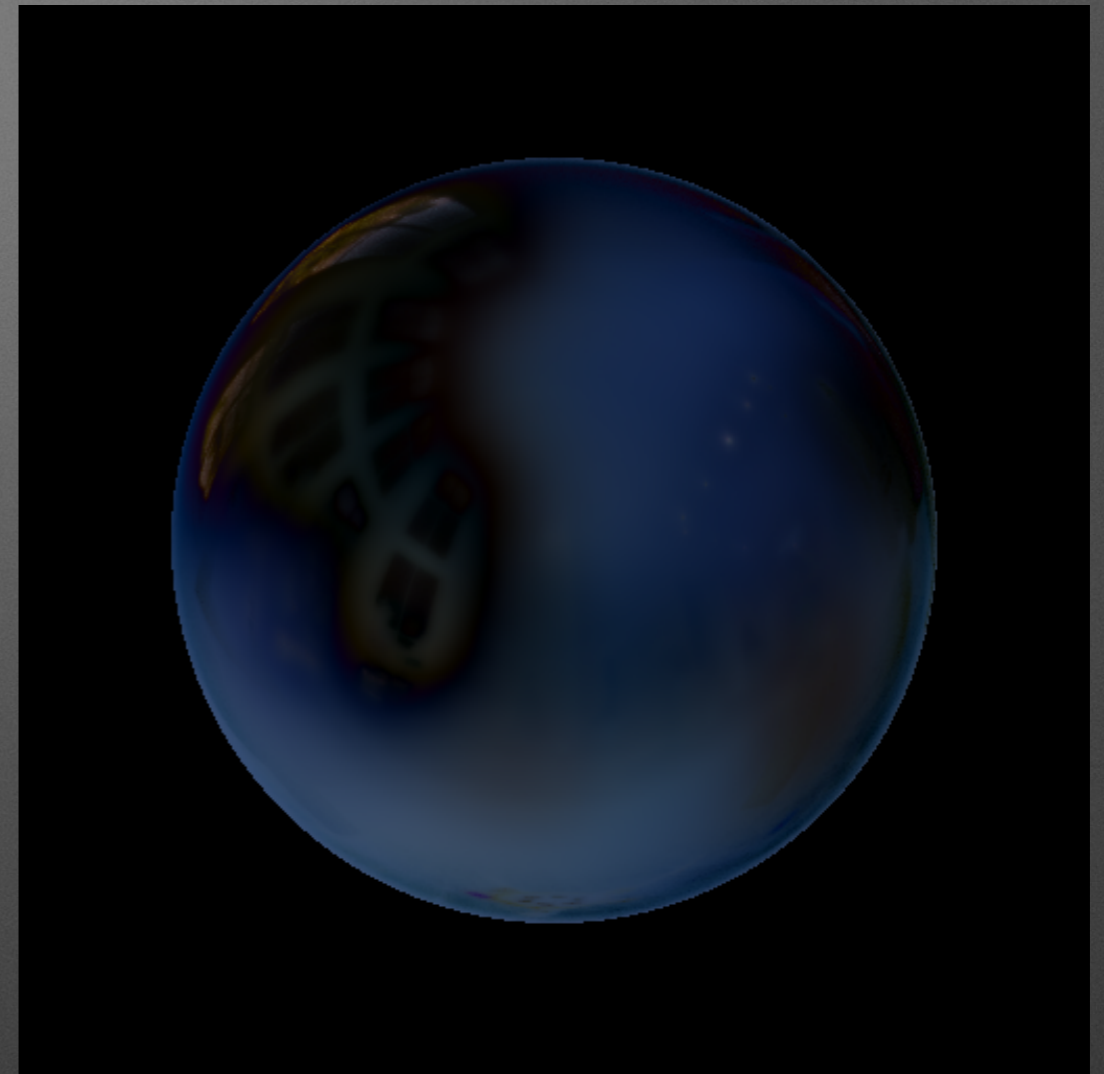

Löw Model
Diff. sMAPE: 0.148

Regarding He et al. Model

- Based on Beckman-Kirchoff Diffraction
 - Our implementation and fitting
- Overall **POOR** Results
 - Better:
 - Fitting: 3 materials
 - Rendering: 4 materials
- **Different** from Ngan et al. results

Yellow Mate Plastic

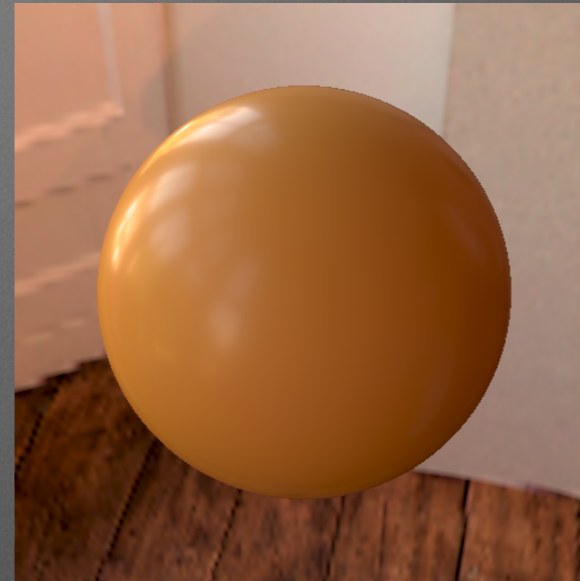

Reference

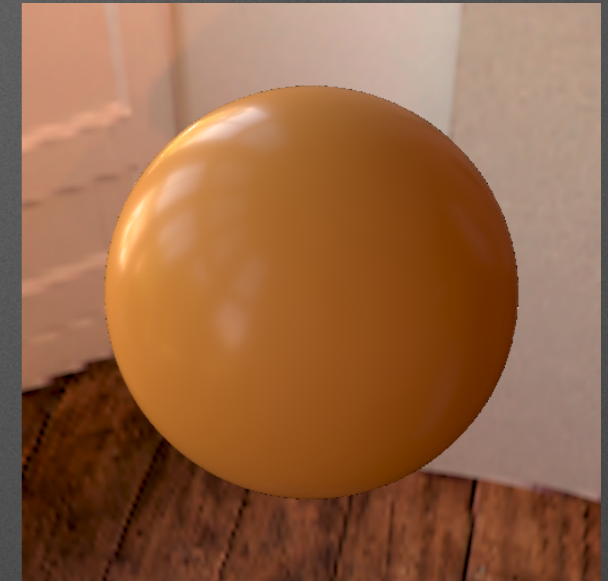

Our Model

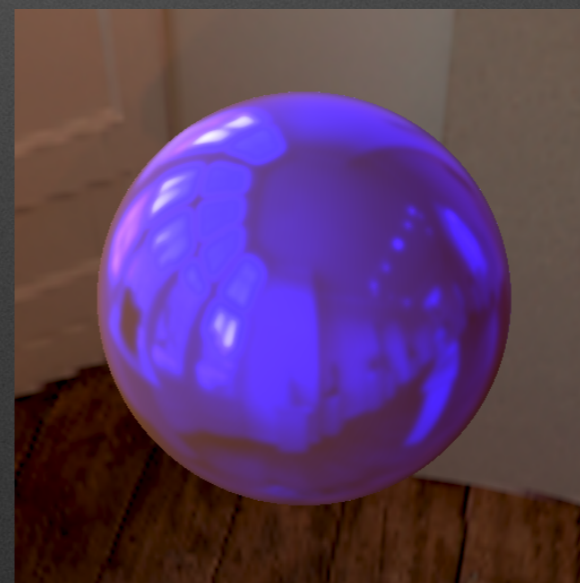

He et al.

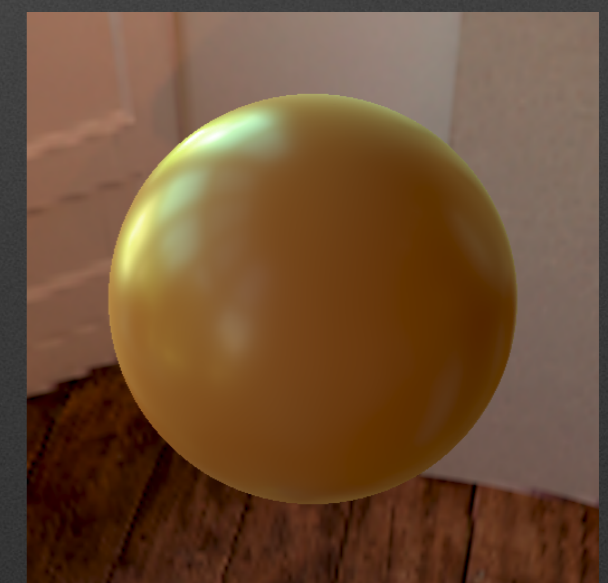

SGD

Number of parameters

MODEL	NUMBER OF PARAMETERS	DIFFRACTION THEORY
Our Model	11	Hybrid Harvey-Shack
Exponential Distribution and Lambert	11	None
Shifted Gamma Distribution	18	None
He et al. Model	11	Beckman - Kirchoff
Löw et al. Smooth	9	Inspired from Rayleigh-Rice

Conclusion

Our two-scale model:

- Better explanation of Measured Data
 - Lobe Size/Width depends on Wavelength
- Micro-facet Theory: Specular Peak
- Limitations:
 - No multi-bounces
 - One Layer of Diffraction

Future Work

- Multiple Scattering and Diffraction

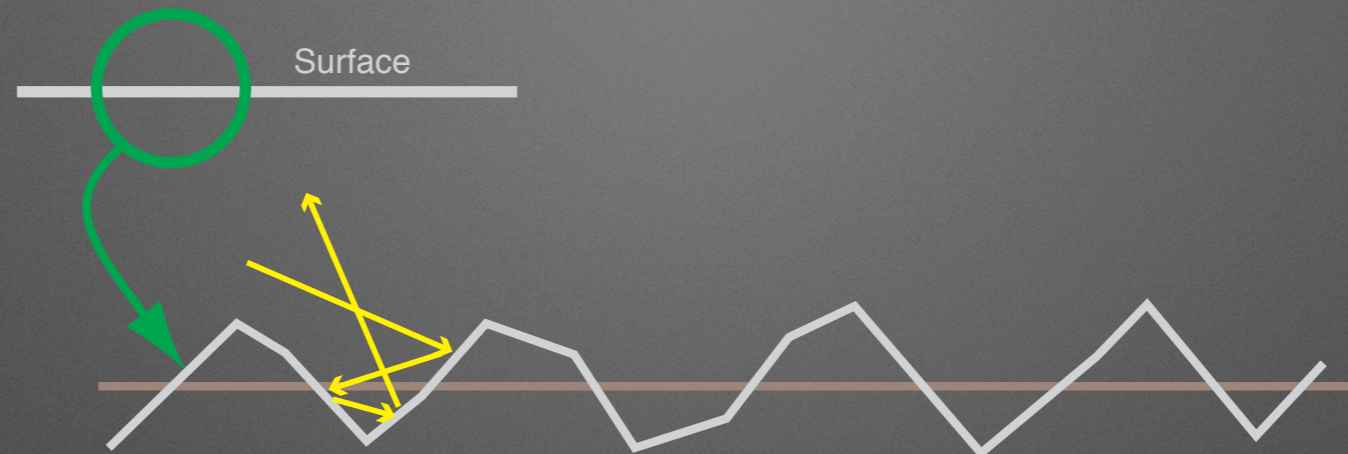

- Multi-Layers and Diffraction

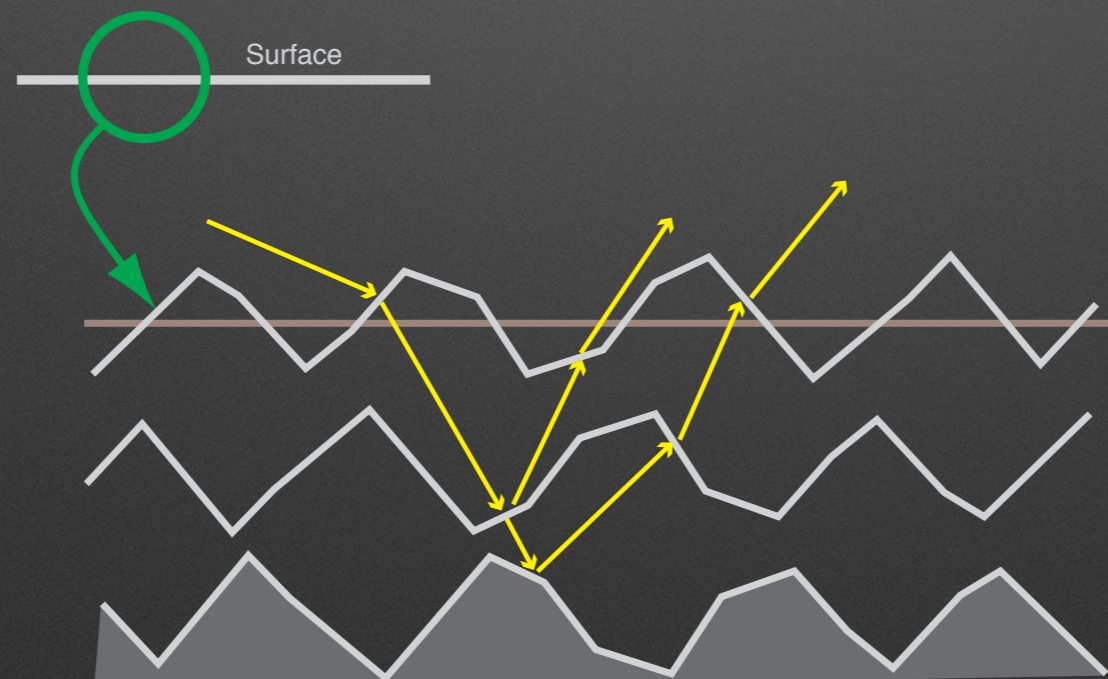

+ polarisation ?

Future Work

- Using Diffraction as shading “enhancer”
 - Virtual transformation of a non-metallic surface
- Anisotropic Version of the Model
- A unified Representation
 - PSD for Nano-facet, Normal Distribution for Micro-facet
- Further Validation with precise Measurements:
 - Surface height-field
 - Wavelength BRDF

Future Work

- Further Validation with precise Measurements:
 - Surface height-field
 - Wavelength BRDF

**Thank you
for your attention**

More on Microfacet convolution

$$\rho_{ghs}(i, o) = \int_{\Omega_m} Fr(i, o) (1 - A_{\sigma_s}(i, o)) K_{\sigma_s}(f) G(i, o) D(m) d\omega_m$$

- **Second: Geometrical Term**

$$(1 - A_{\sigma_s}(i, o)) = 1 - e^{-\left(2\pi \frac{\sigma_s}{\lambda} (\cos \theta_i + \cos \theta_o)\right)}$$

$$(1 - A_{\sigma_s}(i, o)) \approx (1 - A_{\sigma_s}(\theta_d))(h \cdot m)^2$$

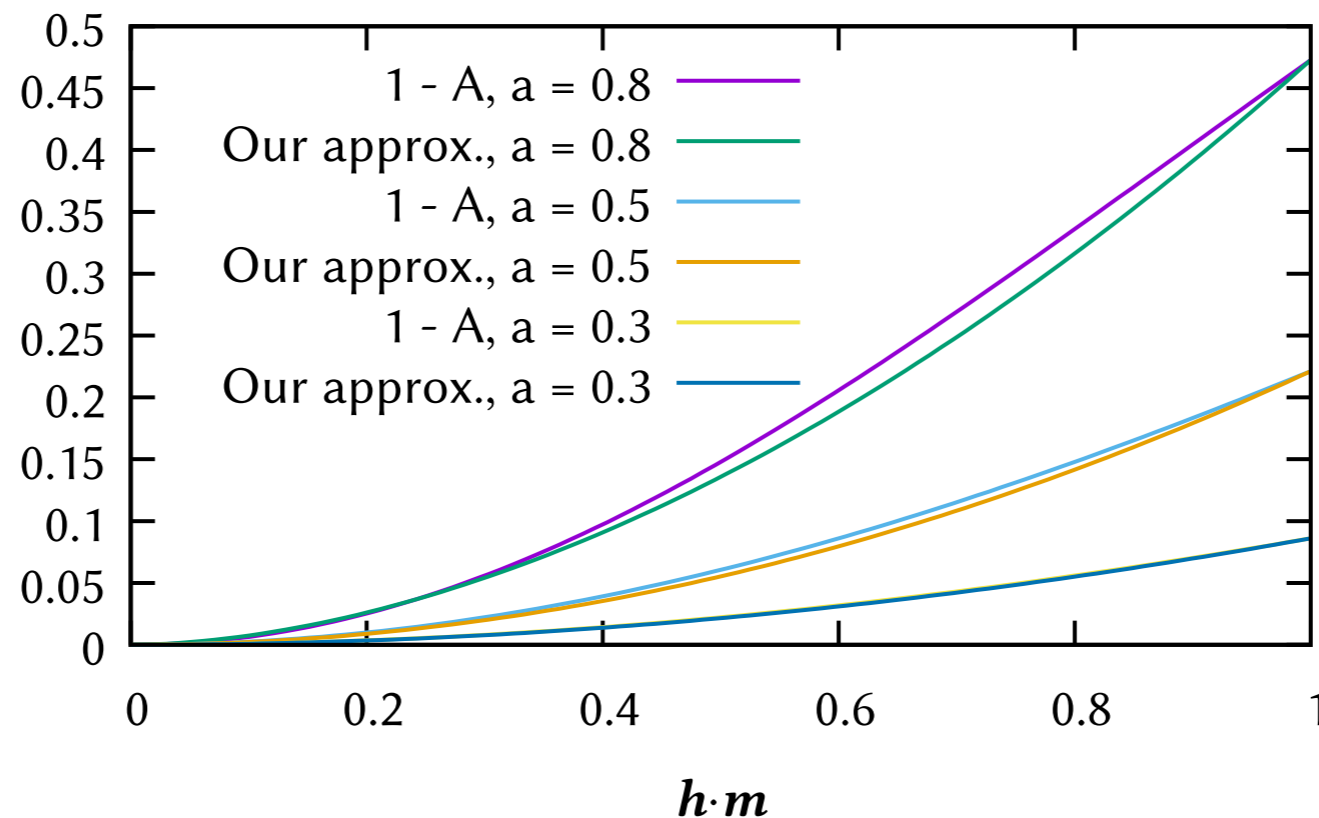

More on Microfacet convolution

$$(1 - A_{\sigma_s}(i, o)) \approx (1 - A_{\sigma_s}(\theta_d))(h \cdot m)^2$$

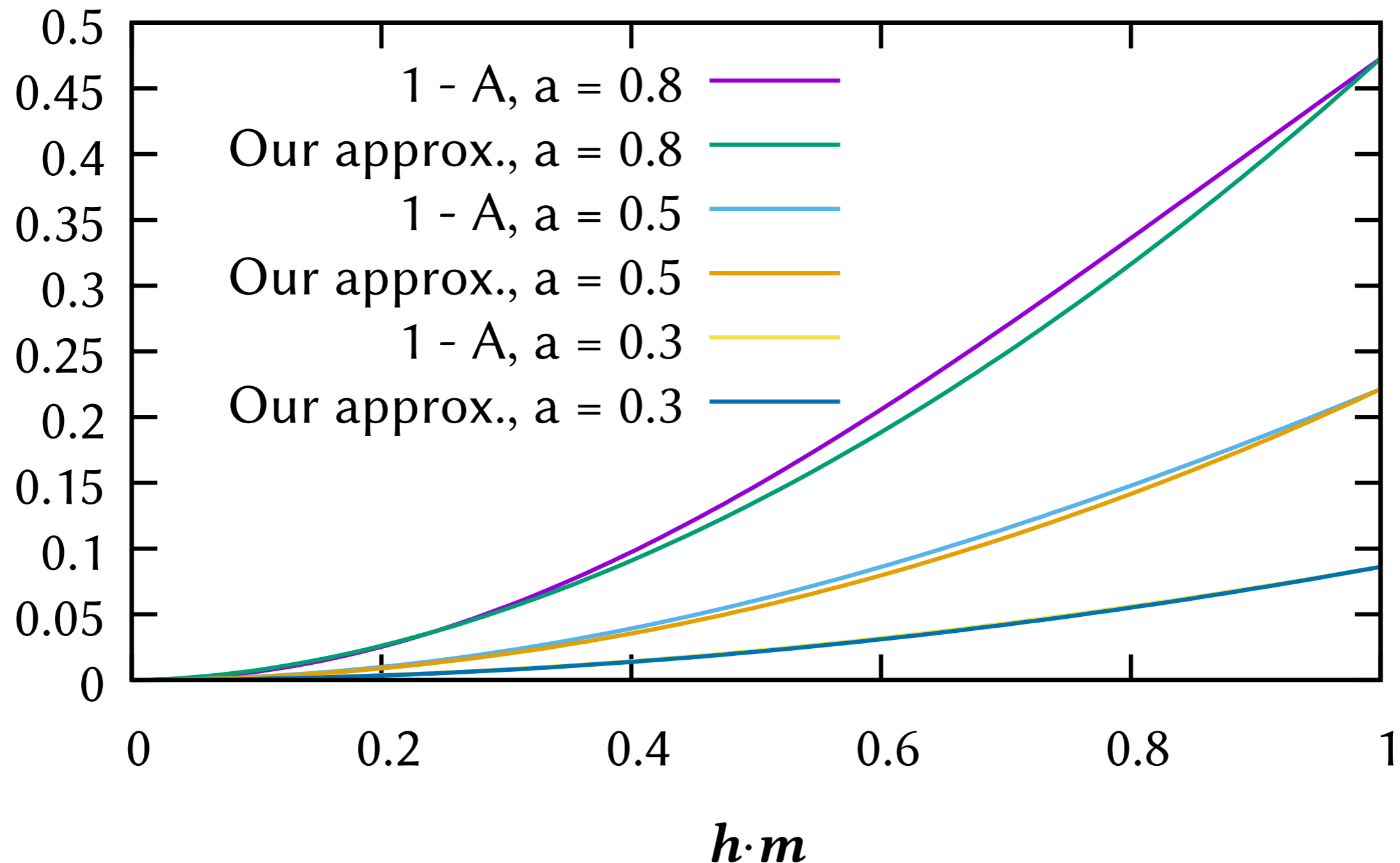

Fresnel and Polarization Factor Q

- Q is NOT the Fresnel Term
- Q comes from Rayleigh-Rice Theory
- For Perfect Specular direction $Q = 2 \text{ Fresnel_Coefficient}$
- Q is re-introduced into GHS **empirically** for comparisons