



HAL
open science

The Cost Estimation of Production Orders

Tomasz Chlebus

► **To cite this version:**

Tomasz Chlebus. The Cost Estimation of Production Orders. 12th International Conference on Information Systems and Industrial Management (CISIM), Sep 2013, Krakow, Poland. pp.465-475, 10.1007/978-3-642-40925-7_43 . hal-01496092

HAL Id: hal-01496092

<https://inria.hal.science/hal-01496092>

Submitted on 27 Mar 2017

HAL is a multi-disciplinary open access archive for the deposit and dissemination of scientific research documents, whether they are published or not. The documents may come from teaching and research institutions in France or abroad, or from public or private research centers.

L'archive ouverte pluridisciplinaire **HAL**, est destinée au dépôt et à la diffusion de documents scientifiques de niveau recherche, publiés ou non, émanant des établissements d'enseignement et de recherche français ou étrangers, des laboratoires publics ou privés.



Distributed under a Creative Commons Attribution 4.0 International License

The Cost Estimation of Production Orders

Tomasz Chlebus

Wroclaw University of Technology, The Faculty of Computer Science and Management, Institute of Organization and Management

tomasz.chlebus@pwr.wroc.pl

Abstract. Time and cost oriented management of production orders requires methods and models of business processes in the enterprise as well as a structural analysis and a reference model of a production process based on a model of a production order. Estimating costs of the execution of a production order may contribute to initial and quite accurate analysis of the costs of the order. The developed method allows for estimation of the interdependence of costs in comparison with different clients. An example shows an analysis of costs of the manufacture of a frame for usual clients, who have no specific requirements, and for clients with additional requests regarding the products. The analysis of the costs of execution of such orders may help estimate the costs of diverse products in the future as well as predict cost variations for different orders. Additional operations may be taken into account and added to the final assessment of costs, which will allow for more accurate cost calculating and indicating orders with worse profitability or orders which cannot be executed due to excessive production costs. The method allows for assessment of production costs both in a sequential model and in distributed manufacturing.

Keywords: Cost analyze simulation production system order estimation

1 INTRODUCTION

Requirements of market economy and increasing competition is forcing companies to change the management style in the direction of rationality and economic efficiency, which is based on the correct use of all outstanding offer companies the means of production. This is possible only if the decision-making processes are based on full information about the state of the company. Adequate information is required for economic decision making at all levels of management. Special role in the information system of economic information companies represent a high cost because the costs are the economic parameter, which shows the level of effort and resources involved in the production of economic activity. The focus is on cost management processes. Processes are identified, which raises the value of the so-called. value chain to be added. The management costs are related to the rationalization of their new methods of managing such a radical reconstruction processes. By contrast, directly aimed

K. Saeed et al. (Eds.): CISIM 2013. LNCS 8104, p. 460-470, 2013.

© IFIP International Federation for Information Processing 2013

at cost management are the new cost accounting methods as developed in the U.S. cost accounting activities (Activity Based Costing - ABC)[1] and a native of Japan, target costing (Target Costing)[2], and the concept of product life management costs. Thus improving the balance sheet of a company is possible, inter alia, by carefully analyzing the cost of production and final demand. The best way to reduce costs is their foresight that can be made from the very beginning of its life cycle, so in the course of its conceptual design. Early diagnosis and determine the cost of the design, manufacture and distribution of finished products will allow the company to better manage their own capital and relationships with network providers. Basic data processing phase of construction-technological and organizational device manufacturing process is also called the phases of product development - design (Fig.1). What is essential in costs of manufacturing process, especially during the development phase, is the possibility of influence of the designer and planner for the development costs implementation phases of the manufacturing process. As can be seen from the diagram as much as 70% of the cost is generated in the development phase of the product and its manufacturing processes.[3]

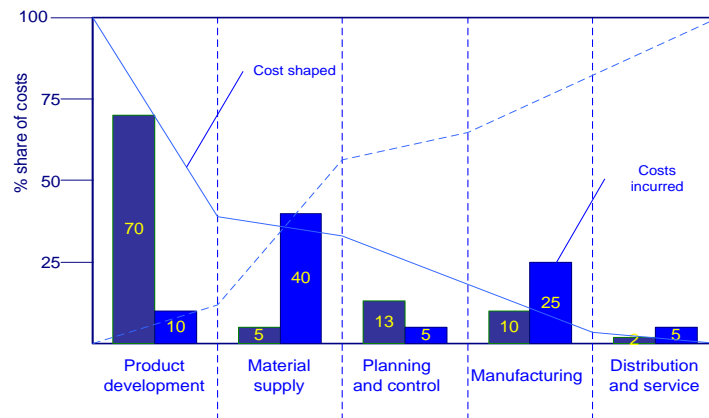

Fig. 1. Phase of product development and cost [3]

Items to be taken into account in this analysis are as follows:

- the purchase of materials,
- costs of materials,
- means of internal transport
- costs associated with machines, tools and resources needed to manufacture,
- costs of servicing and ancillary staff (not production),
- storage of materials for the production in progress.

When examining the impact of individual elements on the final cost of the final product can be assumed that the cost of buying the materials will have the greatest impact on production. It is not always true. We are seeking suppliers of materials to choose from a number acceptable, which means that you can negotiate a purchase price of raw materials and components so that the costs incurred, did not influence significantly the cost of producing the product. On the other hand, need to pay special

The Cost Estimation of Production Orders

attention to the quality of the raw materials and components, whether they meet the requirements and whether the supply is consistent with the contract and the date.

Costs incurred during the production mainly generated by the many ingredients in the workplace and have a significant impact on the general costs of production, Fig.2.

Places cost order at this stage of creating the finished product can be found primarily on the machinery, equipment and tools intended for machining and assembly components (in addition to the costs of course material, which is usually the price does not change dynamically). In order to solve problems cost please consider what factors influence the development of costs in the production process.

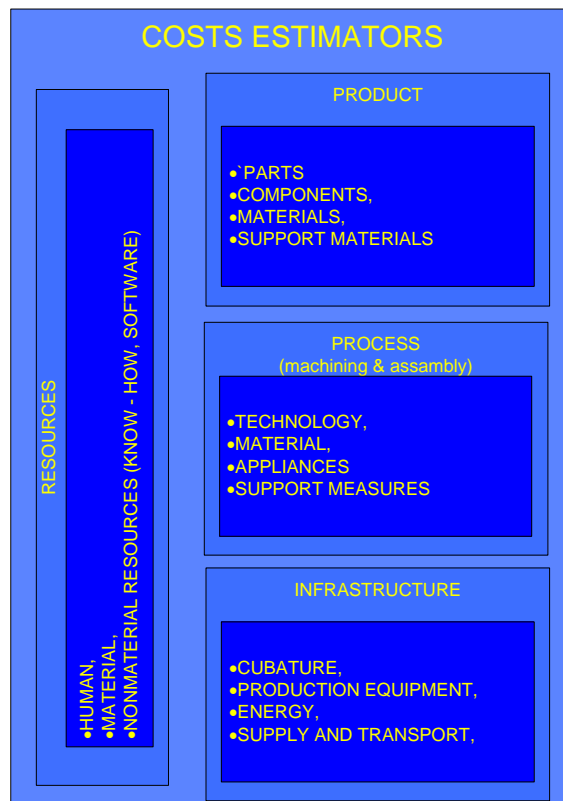

Fig. 2. Estimators costs in the production process [prep.]

Expenditure incurred in the almost three pillars (Fig.3):

1. Product development,
2. Process development and production planning,
3. Machining, production control and logistic and assembly process management.

The most important step and also the point where the costs are planned and decisions are taken, often unknowingly, to the cost of production is where you prepare the documentation and product design, develop manufacturing technologies, identify the necessary resources and organization recalculate pre-project costs.

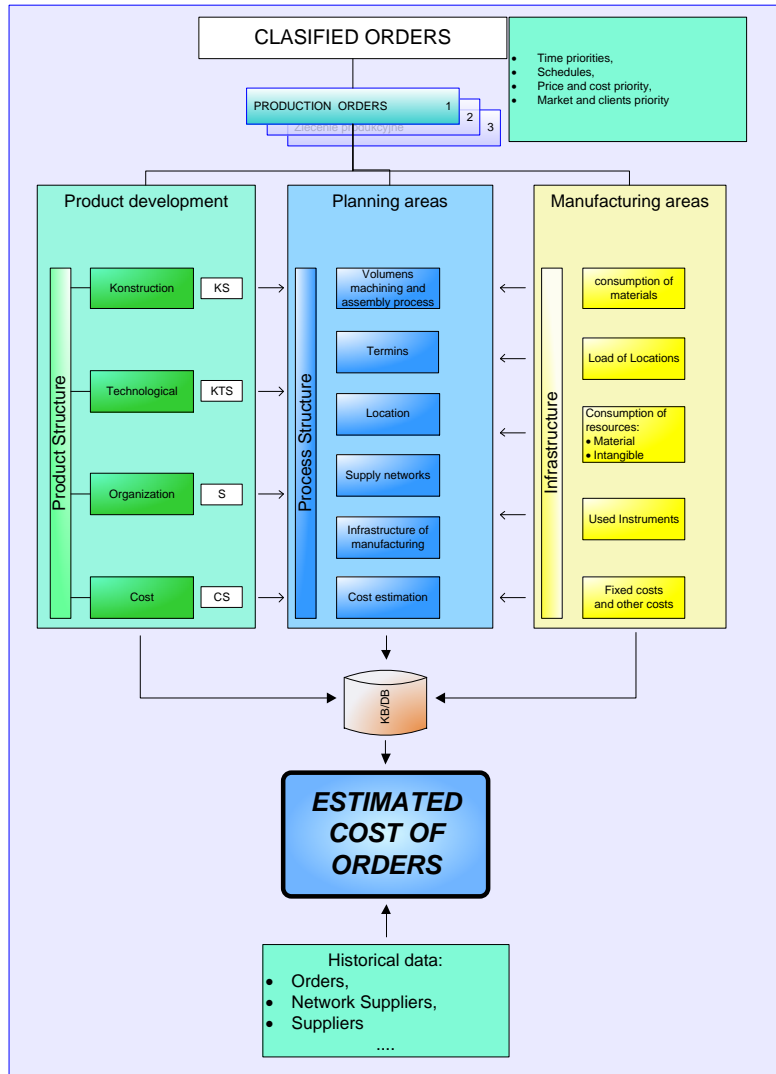

Fig. 3. Factors affecting the cost of production orders (prep.)

2 COST DATA MODEL FOR FORECAST

For the preparation of product documentation will be needed design, construction, technology, information on customer requirements. The costs of construction are not one of the most spending in the first phase of the product life, and therefore in the design. This happens because when the design is extremely difficult to assess whether the costs identified, incurred during this first phase will be in effect as they are scheduled.

The Cost Estimation of Production Orders

In the preparation phase of production should also take into account the cost of implementing the technology and technological burden of production. The structure should be taken into account the technological process of manufacturing the elements taken from the structure of construction and the identity of all aspects of production on some activities such as:

- The order of delivery of materials to production lines,
 - Transport equipment responsible for the internal transportation of raw materials,
- Cost based on the structure of the product it is necessary to determine when and what the costs and time are applied to the product. Analysis of the structure of the product, the tree cost and the time of manufacture is shown on Fig.4 (Ishikawa diagram [4]).

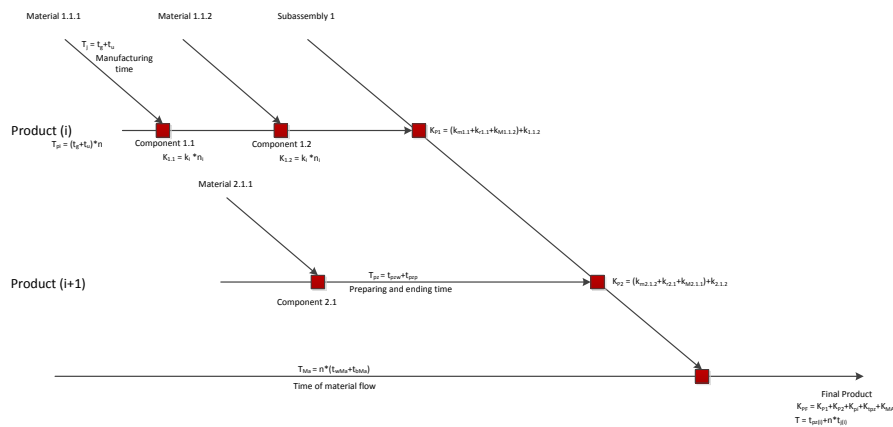

Fig. 4. Model of balancing time and cost components in the node of the article (prep.)

T –	Production time
T_{Ma} –	Time of material flow
T_{wMa} –	Main time of material flow
T_{bMa} –	Brake time of material flow
T_{pz} –	Preparing and ending time
T_{pzw} –	Main preparing and ending time
T_{pzp} –	Subsidiary preparing and ending time
K_{PF} –	Costs of final product
K_{P1} –	Costs of sub product
K_{m1} –	Cost of material flow
K_{r1} –	Cost of produce of subassembly
K_{M1} –	Cost of material

3 THE ALGORITHM OF COSTS ESTIMATING PROCESS

Taking into account these elements can be to build an algorithm of determining the cost of labour and production orders, which was presented at Fig.5 and Fig.6. By

Tomasz Chlebus

proceeding according to the individual steps away from the top of a full scenario in which there is to generate models: product, process and manufacturing system and manufacturing industry. These models are intended to identify the individual modes of production and providing the necessary data to apply methods, models and simulation tools.

The all-important issue in planning a new production facility is to determine the output level and pair it with an adequate production process. The output level is determined based on available expert and theoretical knowledge [9]. Very important information needed in this algorithm should be stored and accessed in knowledge bases and data bases. Data that are needed in order planning should include: specifications, procedures for KM and IT, and the other data that may be used in future. A significant role in this algorithm is modelling and simulation. Results of those steps are easy to receive not incurring additional costs and charge on the production line. Of course there are needs that the enterprise that take or calculate order has to prepare a few variants of the order realization, but with sure they are less cost-intensive. There might be more than one model in result, but all models should be stored in DB/KB, and be stored and analyzed in different productions orders. Continuous improvement of manufacturing system is important point of this method because the environment of production is changing dynamic.

Another important step is to generate simulation models, which will estimate the value sought. On this basis, a specific model of the aggregate costs and labour. The next step is to introduce data to the simulation programs such as Arena, ProModel and Igrafx and track the accuracy of the model built. With formula, you cannot tell right away whether it is best and meets the expectations. Therefore, on the basis of the model is base generates other variants that may arise during the actual production. The next step should be to compare the results with data from databases to determine the validity of the analysis and to be able to verify the developed models. Of course the model must be stable. Both supply (shipment) and production system should have to stable input. Ship stability system is rather complicated [5], but in this model material delivery is realized by cells called kits. Following this analysis and find the best variant of the model, change the base model and deploy the generated model to an existing company. The company is a living, functioning organism, therefore, be still and seek to improve the system both in the form of the model and the actual conditions of production.

The Cost Estimation of Production Orders

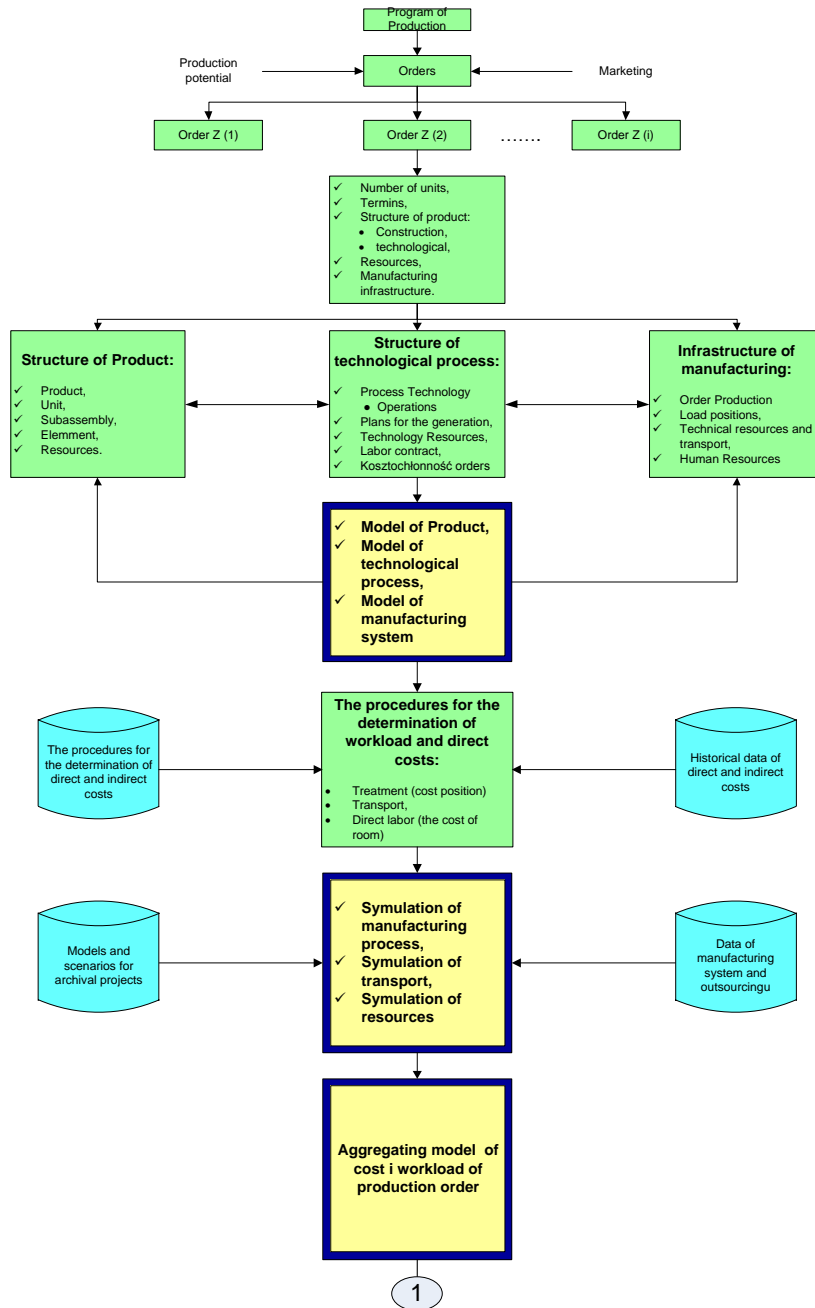

Fig. 5. The algorithm of determination of workload and cost of production order (Part 1) (prep.)

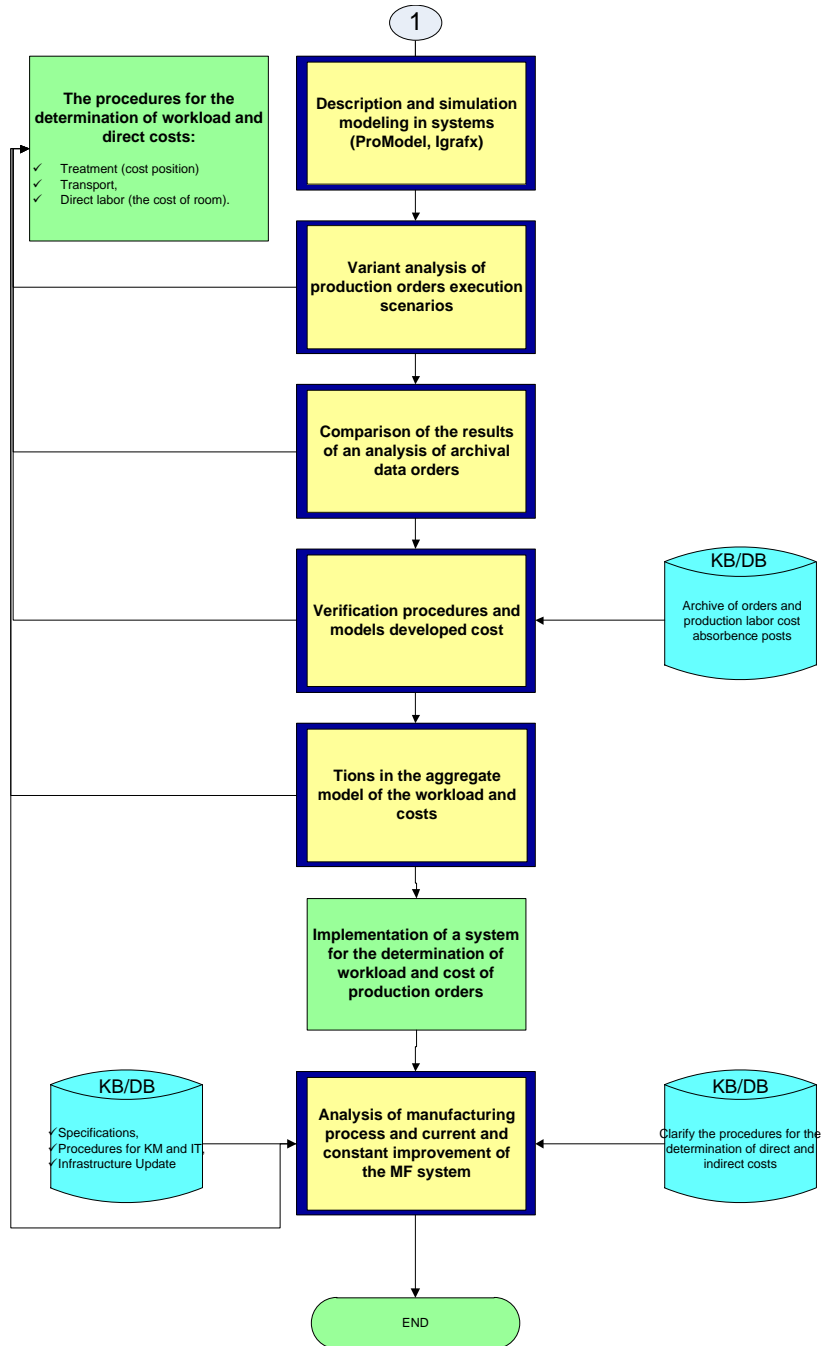

Fig. 6. The algorithm of determination of workload and cost of production order (Part 2) (prep.)

The Cost Estimation of Production Orders

Described company manufactures freight and passenger trains as well as complete transportation systems. Wrocław plant of the company consists of three divisions: Locomotives, Bogies, Service. The project presented in this paper was conducted in Bogies Division, where bogies frames for locomotives and for passenger trains are produced [6]. The following Fig.7 presents an example of the deployment of machines from the ProModel simulation.

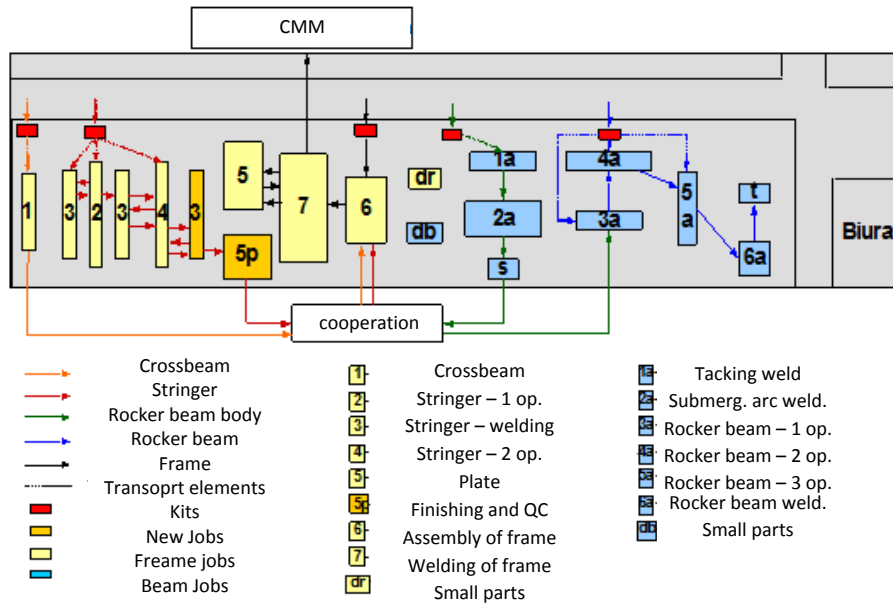

Fig. 7. The plan layout production system simulation framework for ProModel[7]

In addition, the final model was optimized in terms of:

- the optimal number of units of transport,
- shortening the length of road transport
- optimal use of productive resources,
- optimal use of the production line.

After inputting new workstations in layout and applying some productions changes there are some interesting results which can see on (Fig.8.) presented improved the productivity of a plot line for the new version.

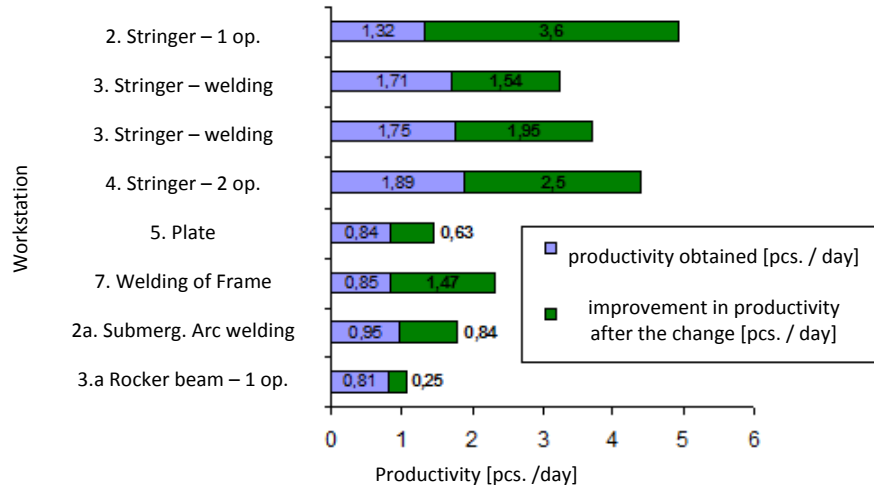

Fig. 8. Summary of productivity, obtained before and after the changes made for selected workstations.

From the analyzes and the developed method can draw insights indicating that the full identification of the product model in the form of its hierarchical structure and complete information describing parameterized processes and production together with the available human and technical resources allows for accurate and rapid identification of the effort and cost of production job. It may be carried out in a simplified way, using tools such as MS Excel or in a multiple and multivariate analysis, with the help of simulation systems such as iGrafix or ProModel. Taking these elements set out in previous chapters, you can use them build an algorithm determining workload and cost of production job was, which is shown in Fig.5 and Fig.6. Items that are shown in the boxes, there are new procedures that have been introduced by the author to calculate the effort and cost of production order. Following each step from the top of the full scenario arises as a result of which there is to generate models of the product and the manufacturing process technology and manufacturing system. These models are intended to describe the various phases of production and providing the necessary data for the application of simulation tools.

4 SUMMARY

The algorithm for estimating the costs can be particularly useful for SMEs (small and medium-sized enterprises)[8], which for reasons of economic systems cannot implement ERP / Bus, and are devoid of advanced calculation tools which significantly reduces their competitiveness. CAD Tools / TPP / CAP / TPM today are already widely used in SMEs and can provide a basis to build custom implementations of storage product knowledge, technology and markets, which can significantly improve the competitiveness of not only business but also can ensure the stability of market

and innovation through the use of accumulated knowledge on immunization and personnel turnover.

5 REFERENCES

1. Robin Cooper and Robert S. Kaplan, Profit Priorities from Activity-Based Costing, Harvard Business Review May-June 1991
2. Tiago Pascoal Filomena, Francisco José Kliemann Neto, Michael Robert Duffey, Targetcosting operationalization during product development: Model and application, International Journal of Production Economics, Volume 118, Issue 2
3. Bauer C.-O. Produkthaftung-Ansprüche an die Konstruktion haben einen Anteil von 70%. Maschinenmarkt, 1984, nr 68
4. P. Konieczka, J. Namieśnik, Chem. Anal. (Warsaw), 53 (2008), p. 785
5. Lech Kobyliński, System and risk approach to ship safety, with special emphasis of stability, Archives Of Civil And Mechanical Engineering, vol.7, Politechnika Wrocławska, Wrocław, Poland
6. Anna Burduk, Edward Chlebus, Methods of risk evaluation in manufacturing systems, Archives Of Civil And Mechanical Engineering, vol.9, Politechnika Wrocławska, Wrocław, Poland
7. Chlebus E., Burduk A., Chrobot J., Kowalski A., Wierzchowski, L. Variant simulation and optimisation of production system in Bombardier Transportation Polska Company, Zarządzanie Przedsiębiorstwem, rok: 2004, Vol. 7, nr 2, s. 15—20
8. Silvio Wilde, Small and Medium-Sized Enterprises, Customer Knowledge Management, Springer, 2011
9. Kowalski A., Marut T. Hybrid Methods Aiding Organisational and Technological Production Preparation Using Simulation Models of Nonlinear Production Systems, Hybrid Artificial Intelligent Systems, PT II Book Series: Lecture Notes in Computer Science Volume: 7209 Pages: 259-266 Published: 2012