



HAL
open science

Simple Displaying Method for Genealogy with Assisted Reproductive Technologies

Seiji Sugiyama, Daisuke Yokozawa, Atsushi Ikuta, Satoshi Hiratsuka, Miyuki Shibata, Tohru Matsuura

► **To cite this version:**

Seiji Sugiyama, Daisuke Yokozawa, Atsushi Ikuta, Satoshi Hiratsuka, Miyuki Shibata, et al.. Simple Displaying Method for Genealogy with Assisted Reproductive Technologies. 14th Computer Information Systems and Industrial Management (CISIM), Sep 2015, Warsaw, Poland. pp.204-215, 10.1007/978-3-319-24369-6_17. hal-01444466

HAL Id: hal-01444466

<https://inria.hal.science/hal-01444466v1>

Submitted on 24 Jan 2017

HAL is a multi-disciplinary open access archive for the deposit and dissemination of scientific research documents, whether they are published or not. The documents may come from teaching and research institutions in France or abroad, or from public or private research centers.

L'archive ouverte pluridisciplinaire **HAL**, est destinée au dépôt et à la diffusion de documents scientifiques de niveau recherche, publiés ou non, émanant des établissements d'enseignement et de recherche français ou étrangers, des laboratoires publics ou privés.



Distributed under a Creative Commons Attribution 4.0 International License

Simple Displaying Method for Genealogy with Assisted Reproductive Technologies

Seiji Sugiyama¹, Daisuke Yokozawa¹, Atsushi Ikuta¹,
Satoshi Hiratsuka², Miyuki Shibata¹, and Tohru Matsuura³

¹ Otani University, Kyoto, JAPAN,
seijisan@sch.otani.ac.jp, dyokozawa@gmail.com,
a.ikuta@sch.otani.ac.jp, neko@res.otani.ac.jp

² Ritsumeikan University, Kusatsu, Shiga, JAPAN,
hiratsuka@spice.ci.ritsumei.ac.jp

³ Hokkaido University Hospital, Sapporo, Hokkaido, JAPAN,
macchan@med.hokudai.ac.jp

Abstract. In this research, a new layout style, ‘Nodes of Effects and/or Way through for TYing Particular Elements (NeWTYPE)’, for displaying genealogy with assisted reproductive technologies (ART) that include a sperm/ovum donor and/or a surrogate mother using our WHiteBasE method is proposed. The NeWTYPE is a node with symbols; ‘Arrow’, ‘Pipe’, and ‘Arrow and Pipe’. Using the NeWTYPE, complex relations of the ART can be understood easily. Note that previous WHiteBasE method has perfectly been able to integrate each relation that includes a married couple and their children, and has been able to display complex relations with segment intersections and various layout styles easily, and also, our JaBBRoW method for abbreviating some jointed relations on the WHiteBasE has been proposed. As a result, displaying both regular complex genealogy and the ART can be realized simultaneously. Our improved software that can display the NeWTYPE automatically and seamlessly by only mouse operations is presented.

Keywords: Family Trees, Pedigrees, Sperm or Ovum Donor, Surrogate Mother, GEDCOM, WHiteBasE

1 Introduction

There is a lot of genealogy display software these days[1]-[18]. However, almost all of them cannot display complex relations perfectly. In the case of writing complex genealogy on paper media, one individual is written only once in most cases using segment intersections and various layout styles. In contrast, in the case of using the software, one individual is often displayed in multiple places because the software considers no complex layouts even if GEDCOM[19], a de facto standard for recording genealogy data exchange format, can store them perfectly. These displaying results are very difficult to understand complex relations correctly.

To cope with the difficulty, new genealogy display software has already been proposed on our previous research by using the WHiteBasE (Widespread Hands

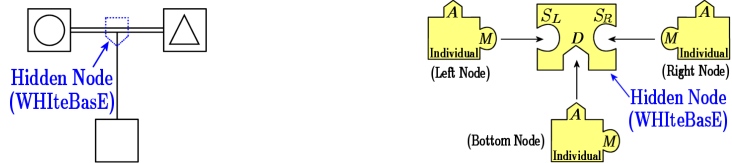

Fig. 1. A regular family layout in genealogy **Fig. 2.** Connection model of WHiteBasE

to InTErconnect BASic Elements) method[20]. The WHiteBasE is a hidden node for integrating relations that include not only a married couple and their children but also information of those positions. As a result, one individual have been displayed only once using segment intersections easily. In addition, not only various layouts such as paper media have been displayed but also intuitive inputs and inspections such as map display systems have been realized[21],[22]. Moreover, JaBBRoW (Joint ABBReviation for Organizing WHiteBasE) method has also been proposed for abbreviating a part of genealogy[23]. As a result, arbitrary relations with horizontal and vertical connections in genealogy can be abbreviated easily.

On the other hand, there is different complex relations these days such as Assisted Reproductive Technologies (ART) that include a sperm or ovum donor, and a surrogate mother[24]. This work said that ART symbols and pedigree lines can be displayed on many existing genealogy display software. However, these software cannot display regular complex relations with segment intersections perfectly mentioned above. In addition, these layout styles has slant lines between a parent generation and a child generation. Using slant lines makes displaying genealogy complicated in the case of using segment intersections. Displaying all situations both of regular genealogy and medical pedigree such as the ART cannot be realized using the existing medical line definitions.

In this paper, a new layout style, ‘Nodes of Effects and/or Way through for TYing Particular Elements (NeWTYPe)’, is added to the WHiteBasE method. The NeWTYPe is a node with symbols; ‘Arrow’, ‘Pipe’, and ‘Arrow and Pipe’. Using the NeWTYPe, complex relations of the ART can be understood easily. As a result, displaying both regular complex genealogy and the ART can be realized simultaneously. Our improved software that can display the NeWTYPe automatically and seamlessly by only mouse operations is presented.

2 WHiteBasE and JaBBRoW

In this section, the WHiteBasE method and the JaBBRoW method that are our previous proposal [20]-[23] are briefly introduced. A regular family relation between a married couple and their child is managed as an event by a Hidden Node, WHiteBasE as shown in Fig. 1. The connection model of WHiteBasE is shown in Fig. 2. WHiteBasE has three keyholes, S_L , S_R (Substance) and D (Descendant). Individuals have two keys, A (Ascendant) and M (Marriage). A can connect with D , and M can connect with S_L or S_R , where denote one family.

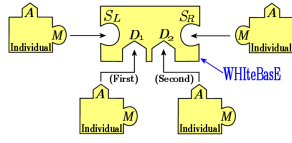

Fig. 3. Brothers and sisters

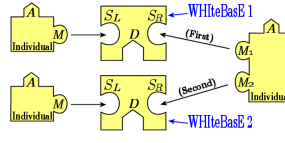

Fig. 4. Multiple Remarriages

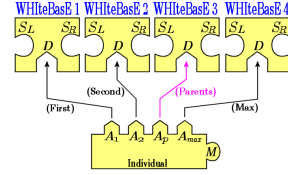

Fig. 5. Adoptions

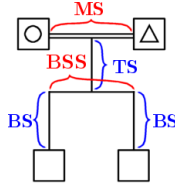

Fig. 6. Regular layout

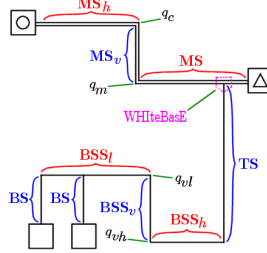

Fig. 7. Various Layouts

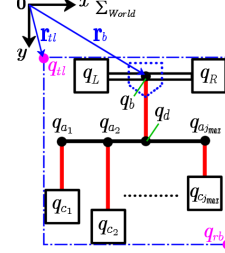

Fig. 8. Coordinate System

For brothers and sisters, D is extended to multiple keyholes D_j as shown in Fig. 3. For multiple remarriages, M is extended to multiple keys M_k and plural WHItEBasEs are used as shown in Fig. 4. For adoptions, A is extended to multiple keys A_l as shown in Fig. 5 where A_p , one of A_l , denotes ID for handling the biological parents, and the others denote IDs for handling social parents.

Fig. 6 shows the regular Japanese layout style. It includes a double horizontal segment MS (Marriage Segment), a vertical segment TS (Trunk Segment), a horizontal segment BSS (Brothers and Sisters Segment), and a vertical segment BS (Branch Segment). The ‘ Δ ’ denotes a male, and the ‘ \circ ’ denotes a female that are a couple connected by using MS. For various layouts, MS is extended to MS, MS_v , and MS_h named DB (Double Bend), and BSS is extended to BSS_h , BSS_v , and BSS_l named HS (Hooked Segment), as shown in Fig. 7.

A set of W_i that defines WHItEBasEs and a set of I_j that defines Individual Nodes are represented by

$$\begin{aligned}
 W_i &= \{S_L, S_R, D_j, \mathbf{Q}\} \\
 I_j &= \{M_k, A_l\}
 \end{aligned}
 \quad \left\{ \begin{array}{l}
 i = 0, 1, \dots, i_{max} \\
 j = 0, 1, \dots, j_{max} \\
 k = 0, 1, \dots, k_{max} \\
 l = 0, 1, \dots, p, \dots, l_{max}
 \end{array} \right. \quad (1)$$

where i, j, k, l and $i_{max}, j_{max}, k_{max}, l_{max}$ denote the IDs and their maximum values on the data table respectively, p denotes the ID for handling a biological parents, S_L and S_R denote the IDs for handling a couple, D_j denote the IDs for handling descendants, M_k denote the IDs for handling marriages, and A_l denote the IDs for handling ascendants. Individuals are managed by using data table including names and annotation data. WHItEBasEs are managed by using data table separated from Individuals.

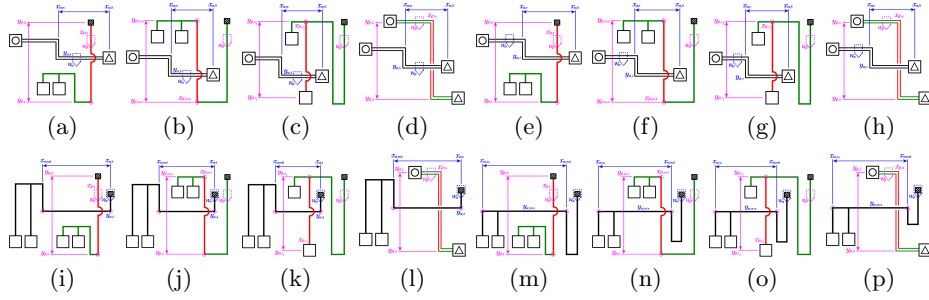

Fig. 9. Search pattern of segment intersections for various layouts

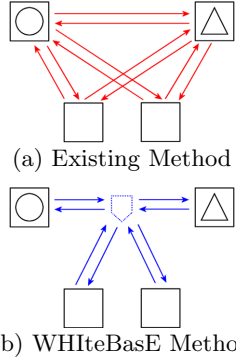

Fig. 10. Number of references

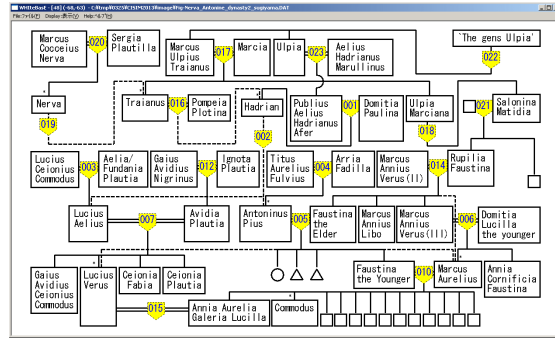

Fig. 11. Displaying Result by using WHiteBasE [25]

A set of \mathbf{Q} that defines coordinate values for each position managed by a WHiteBasE measured from the origin in the displaying area is represented by

$$\mathbf{Q} = \{q_b, q_L, q_R, q_d, q_{c_j}, q_{a_j}, q_{vl}, q_{vh}, q_m, q_e, q_{tl}, q_{rb}\} \quad (2)$$

where q_b denotes the WHiteBasE's position, q_L, q_R denote the parents' positions, q_d denotes a junction's position between MS and TS, q_{c_j} denotes children's positions, q_{a_j} denotes junctions' positions between BSS and BS, q_{vl}, q_{vh} denote the corners on DB, q_m, q_e denote the corners on HS, q_{tl}, q_{rb} denote positions of top-left and bottom-right of all area managed by a WHiteBasE, as shown in Fig. 7 and Fig. 8.

There are only four kinds of horizontal segments and four kinds of vertical segments in the WHiteBasE method. The positions of segment intersections can be calculated by using only 16 patterns of line crossing as shown in Figs. 9(a)-(p). The half arcs are displayed on the positions of segment intersections. The detailed information has already been written in our previous research [22].

This algorithm is very fast because it skips when two WHiteBasEs' areas do not overlap. In addition, when adoptions are set, the segment style changes to the dashed segments named AS (Adopted Segment) and the arcs are not used.

One of advantages using WHiteBasE is the decreased reference volume. If the existing software is used, all of individuals connect with other individuals as

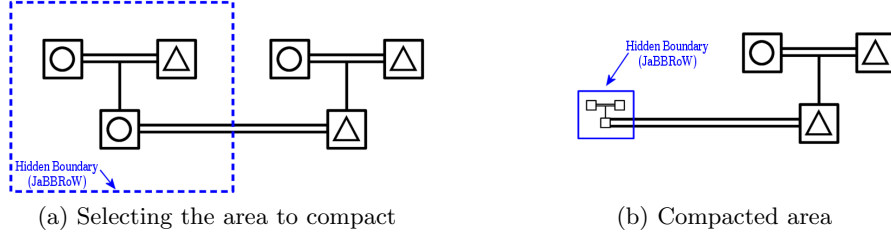

Fig. 12. Compacted and Recovered Operation by using the Hidden Node, JaBBRoW

shown in Fig. 10(a). In contrast, if the WHItEBasE is used, two reference links per a child decrease as shown in Fig. 10(b). Moreover, the users can understand the complex relations intuitively and can input and inspect them easily.

Fig. 11 shows the sample demonstrations by using our previous genealogy display software that can display complex relations with segment intersections automatically and seamlessly by only mouse operation [25].

In addition, the JaBBRoW method can be used for abbreviating a part of genealogy. A selected area of genealogy with abbreviation is managed as an event by a Hidden Boundary as shown in Fig. 12(a). When the area is compacted, the dotted rectangle becomes the solid rectangle as shown in Fig. 12(b). All of relations in genealogy can be maintained while compacting, and all of relations in the Hidden Boundary can be scaled down to the very small area.

JaBBRoW is defined using a set of hyper-graph G represented by

$$G = (V, \epsilon) \quad (3)$$

where ϵ denotes a hyper-edge given by

$$\epsilon = \{ J_0, J_1, J_2, \dots \in V \mid J_i \cap J_j = \emptyset, i \neq j \} \quad (4)$$

where J_k ($k = 0, 1, 2, \dots$) denote a Hidden Boundary JaBBRoW, each JaBBRoW is a disjoint set, and one node is not managed by plural JaBBRoW. On the other hand, V denotes a set of each node inside the JaBBRoW represented by

$$V = \{ V_0, V_1 \} \quad (5)$$

where V_0 and V_1 denote a set of Individuals and a set of WHItEBasE respectively represented by

$$V_0 = \{ I_0, I_1, I_2, \dots, \mid I_j \notin J_k \text{ then } I_j \notin V_0, k = 0, 1, 2, \dots \} \quad (6)$$

$$V_1 = \{ W_0, W_1, W_2, \dots, \mid W_i \notin J_k \text{ then } W_i \notin V_1, k = 0, 1, 2, \dots \} \quad (7)$$

where I_j are coordinate values on the \sum_{world} , and W_i are coordinate values of only corner points in the WHItEBasE represented by

$$W_i = \{ q_b, q_d, q_{vl}, q_{vh}, q_m, q_e \mid q_b \notin J_k \text{ then } q_d, q_{vl}, q_{vh}, q_m, q_e \notin W_i, k = 0, 1, 2, \dots \}. \quad (8)$$

As a result, a set of each node inside the JaBBRoW is scaled in each J_k . Note that q_{vl}, q_{vh}, q_m, q_e are not calculated when various layouts are not used.

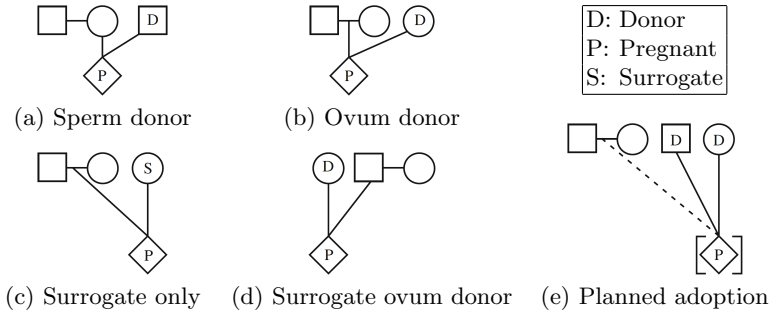

Fig. 13. Assisted Reproductive Technology Symbols and Definitions[26]

3 Layout style for Assisted Reproductive Technologies

3.1 Existing Definitions

The common pedigree symbols have been defined in the medical pedigree[26]. It is very important to discuss these symbols, however, it is not necessary to calculate segment positions for displaying these symbols because they are only symbols instead of displaying individuals' names. Therefore, only segment layout styles are considered for calculating segment intersections in this research.

There are five segment styles in the ART as shown in Figs. 13(a)–(e)[26] where 'D' denotes Donor, 'P' denotes Pregnant and 'S' denotes Surrogate, '○' denotes woman, '□' denotes man, and '◇' denotes sex unknown. The five layout styles (a)–(e) mean as the following:

- (a) Couple in which woman is carrying pregnancy using donor sperm.
- (b) Couple in which woman is carrying pregnancy using a donor egg and partner's sperm.
- (c) Couple whose gametes are used to impregnate a woman (surrogate) who carries the pregnancy.
- (d) Couple in which male partner's sperm is used to inseminate.
- (e) Couple contracts with a woman to carry a pregnancy using ovum of the woman carrying the pregnancy and donor sperm.

3.2 Problem of these definitions

It is necessary to draw slant lines between parents and a child in these definitions. It is thought that the reason why slant lines are necessary is to display parents and a donor on the same horizontal position and to display genetic relations with reproductive technologies. However, if the display distance between a couple and a donor is long and there is a lot of relations near the couple, the angle of slant lines becomes small and the segment layout becomes complicated because a lot of horizontal and vertical segments are crossing on the slant lines. In addition, it takes more times to calculate positions of segment intersections with slant lines than using only horizontal and vertical segments. Moreover, these definitions are special transcription specialized in medical pedigree and are not general.

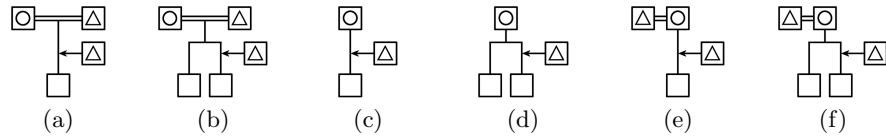

Fig. 14. Sperm donor layouts using Regular Layouts and Direct Segments

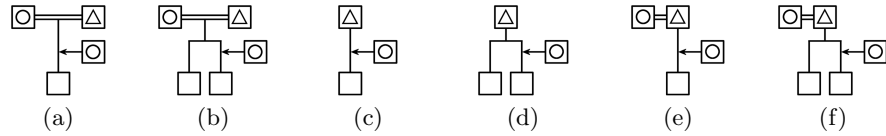

Fig. 15. Ovum donor layouts using Regular Layouts and Direct Segments

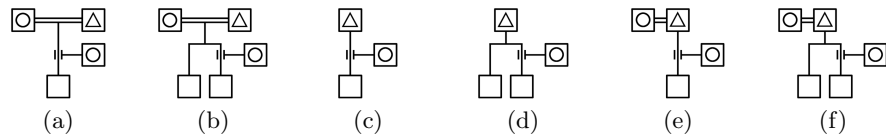

Fig. 16. Surrogate only layouts using Regular Layouts and Direct Segments

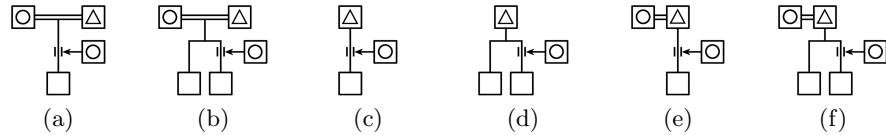

Fig. 17. Surrogate ovum donor layouts using Regular Layouts and Direct Segments

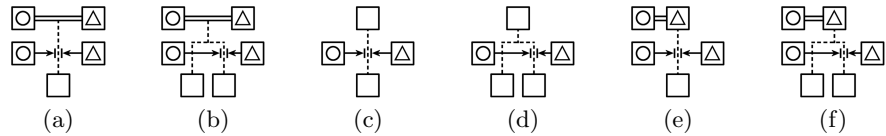

Fig. 18. Planned adoption layouts using Regular Layouts and Direct Segments

4 NeWTYPe

It is important to realize the requirement both of regular genealogy layouts such as the WHItEBasE method and pedigree layouts for the ART. To realize this requirement, a new layout style, ‘Nodes of Effects and/or Way through for TYing Particular Elements (NeWTYPe)’, is proposed in this research. It can be said that persons other than a couple and a child are only added in the ART treatment. This scenario only includes connections of donors and/or surrogates from third persons to the stream between a couple and a child. Existing ART layouts can be changed to the following new layout styles.

Sperm donor: Figs. 14(a)–(f) show sperm donor layouts where (a) and (b) denote Regular Layout for a child and children respectively, (c) and (d) denote Direct Segment from a single parent for a child and children respectively, and (e) and (f) denote Direct Segment from parents for a child and children respectively. The horizontal arrow from a third person denotes a sperm donor.

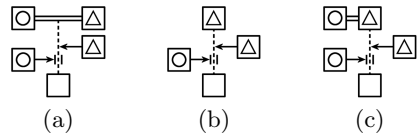

Fig. 19. Different Vertical Positions

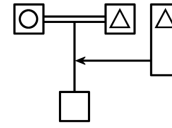

Fig. 20. Generation alignment

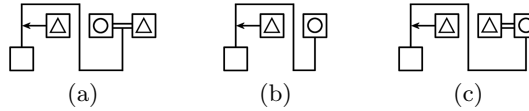

Fig. 21. The sample using Hooked Segments

These layouts correspond to Fig. 13(a), however, only horizontal and vertical segments are used. Note that these six layouts without arrows (donors) have already displayed on the WHiteBasE method. The node of the vertical segment BS (see Fig. 6) and the arrow segment is one of NeWTYPE. These layouts are very simple to understand the meaning.

Ovum donor: Figs. 15(a)–(f) show ovum donor layouts where (a)–(f) mean the same mentioned above. The difference between sperm donor layouts and ovum donor layouts is only the sex display of donors that includes a man ‘ Δ ’ and a woman ‘ \circ ’. These layouts correspond to Fig. 13(b).

Surrogate only: Figs. 16(a)–(f) show surrogate only layouts where (a)–(f) also mean the same. In this case, genetically parents are the couple and the surrogate person only takes her place. Considering this meaning, a pipe symbol is used instead of the arrow. These layouts correspond to Fig. 13(c).

Surrogate ovum donor: Figs. 17(a)–(f) show surrogate ovum donor layouts where (a)–(f) also mean the same. In this case, the event has not only surrogate but also donor. Considering this meaning, both an arrow and a pipe symbol are used together. These layouts correspond to Fig. 13(d).

Planned Adoption: Figs. 18(a)–(f) show planned adoption layouts where (a)–(f) also mean the same. In this case, two arrows from two persons other than a couple and a child to the node are used. Note that all donor/surrogate persons of (a)–(f) are placed at the same vertical position. In contrast, Figs. 19(a)–(c) show the sample of different vertical positions. Both cases use two arrows and one pipe symbol. These layouts correspond to Fig. 13(e).

Generation Alignment: Fig. 20 shows the sample of generation alignment. Using the long size of individual’s text-box vertically, the top position of a couple and a donor/surrogate person can be aligned even though the NeWTYPE is used.

Using Hooked Segments: Figs. 21(a)–(c) show the sample of sperm donor using Hooked Segments. Using these styles, various layouts with the NeWTYPE can be displayed. The other samples using Hooked Segments including ovum donor, surrogate only, surrogate ovum donor, and planned adoption, are similar to these samples, because the node is located on the BS using both regular layout, Direct segments, and Hooked segments. Therefore, the figures of the other samples are omitted in this paper.

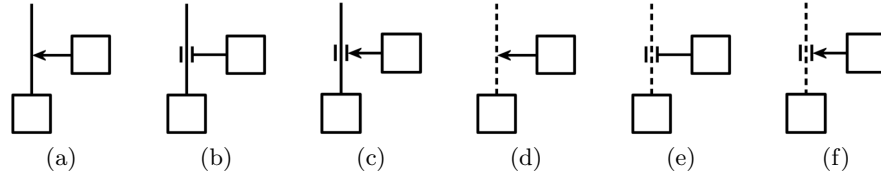

Fig. 22. Symbols for the NeWTYPe

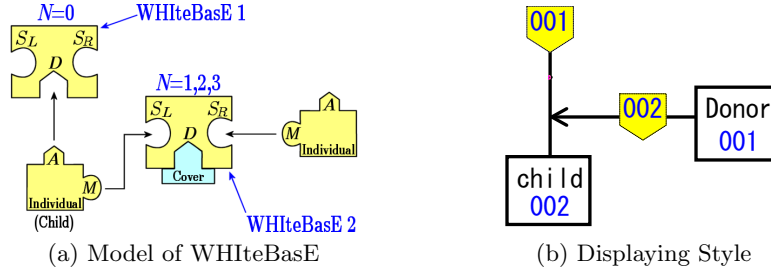

Fig. 23. Improved WHIteBasE model for the NeWTYPe

As a result, the necessary symbols for the NeWTYPe can be only six types; ‘Arrow’, ‘Pipe’, and ‘Arrow and Pipe’ using solid segment BS or dotted segment BS as shown in Figs. 22(a)–(f).

5 Improved WHIteBasE model

Symbols ‘Arrow’, ‘Pipe’, and ‘Arrow and Pipe’ are necessary to display the NeWTYPe. NeWTYPe flag N is added to the WHIteBasE represented by

$$W_i = \{S_L, S_R, D_j, \mathbf{Q}, N\}. \quad (9)$$

If $N = 0$, the WHIteBasE is the normal mode that equals previous model. If $N = 1, 2, 3$, the WHIteBasE changes the NeWTYPe mode and the keyhole D is covered, that means connecting descendants is not allowed as shown in Fig. 23(a). The numbers of N mean ‘Arrow’ ($N = 1$), ‘Pipe’ ($N = 2$), and ‘Arrow and Pipe’ ($N = 3$). The left individual that has connected with ascendant WHIteBasE denotes a child of reproductive treatment. The meaning of key M in the left individual changes to the NeWTYPe connection.

One of this displaying style is shown in Fig. 23(b). In this case, the right individual in (a) equals to the individual 001 in (b), the left individual in (a) equals to the individual 002 in (b), and $N = 1$. If the top position of text box in the individual is lower than the vertical position of the WHIteBasE that is NeWTYPe mode, the NeWTYPe (arrow node) is displayed automatically.

The horizontal segment (arrow) is single segment, however, the layout is similar to MS. Therefore, the same search method for segment intersections as shown in Figs. 9(a)–(p) can be used for the NeWTYPe in a little change

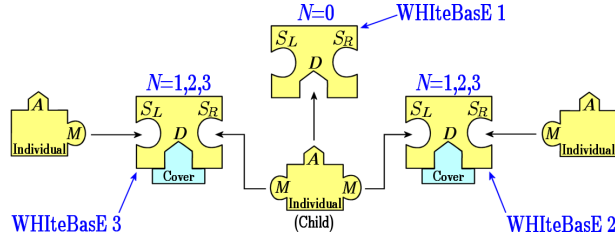

Fig. 24. Connection model of the WHiteBasE for planned adoptions

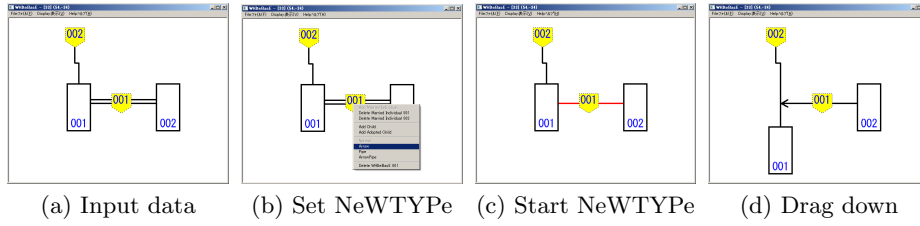

Fig. 25. Instruction for setting NeWTYPE

between single segment and double segment. As a result, the advantages of the WHiteBasE and the JaBBRoW can be maintained as in the past.

For planned adoptions, plural WHiteBasEs that are set to the NeWTYPE mode and multiple keys M_k in the child are only used as shown in Fig. 24. In this case, the definition of WHiteBasE does not change at all.

6 Demonstration of Our New Software

Figs. 25(a)–(d) show the instruction for setting the NeWTYPE. The detailed sequence is as the following:

- Input data; two Individuals and two WHiteBasEs and connect them.
- Select NeWTYPE menu that includes ‘Arrow’ or ‘Pipe’ or ‘Arrow Pipe’ on the WHiteBasE 001.
- The WHiteBasE 001 changes to the NeWTYPE mode and the MS becomes a single segment automatically.
- Drag down the individual 001, the NeWTYPE appears automatically. In this case, ‘Arrow’ is selected in (b).

Fig. 26(a) shows the sample of five NeWTYPE test on WHiteBasE where Individuals 001/002 are a couple, Individual 004 is a sperm donor, Individual 006 is a ovum donor, Individual 008 is a surrogate mother, Individual 010 is a surrogate ovum donor, and Individuals 012/013 are the case of planned adoption. In this sample, a lot of arcs for segment intersections are automatically displayed.

Fig. 26(b) shows the sample of five NeWTYPE test using JaBBRoW. The JaBBRoW 001 manages the five NeWTYPE area to abbreviate. The ascendant

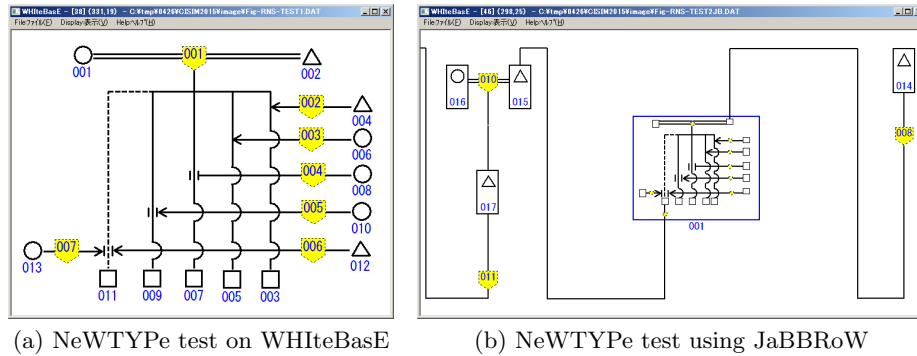

Fig. 26. Our new Genealogy Display Software for ART Layouts

of JaBBRoW 001 is WHItEBasE 008 and the descendant of JaBBRoW 001 is Individual 015. The stream line from WHItEBasE 008 to Individual 015 can be seen directly. Note that the JaBBRoW method does not change at all, however, the function of JaBBRoW can be used even though the NeWTYPe is used, because the difference between previous method and new method is only to add the NeWTYPe flag to the WHItEBasE. The definition of the JaBBRoW is the same as our previous research.

7 Conclusion

In this research, a new layout style, ‘Nodes of Effects and/or Way through for TYing Particular Elements (NeWTYPe)’, that includes ‘Arrow’, ‘Pipe’, and ‘Arrow and Pipe’, could be added to our previous WHItEBasE method.

As a result, not only regular complex genealogy with segment intersections but also the ART can be displayed simultaneously. Using the NeWTYPe layout, relations of the ART can be understood easily because slant segments are not used. In addition, the calculation time of the NeWTYPe is less than the case using slant segments. Moreover, the layout style of the NeWTYPe is not special transcription specialized in medical pedigree and this method has wide variety of use.

Future plan will be conducted to construct grid layouts on semi-automatic, displaying mythology genealogy, multi OS application, and new genealogy data format for automatic layouts.

References

1. The Generations Network: Genealogy, Family Trees and Family History Records on line, <http://ancestry.com>
2. MyHeritage, <http://myheritage.jp>
3. Jurek Software, <http://www.pedigree-draw.com/>

4. He, M., Li, W.: PediDraw: A web-based tool for drawing a pedigree in genetic counseling. In: BMC Medical Genetics, pp. 1–4 (2007)
5. Brun-samarcq, L., et al.: CoPE: a collaborative pedigree drawing environment. Bioinformatics ‘Applications Note’, 15(4), pp. 345–346 (1999)
6. Dudbridge, F., et al.: Pelican: pedigree editor for linkage computer analysis. Bioinformatics ‘Applications Note’, 20(14), pp. 2327–2328 (2004)
7. Trager, E.H., et al.: Madeline 2.0 PDE: a new program for local and web-based pedigree drawing. Bioinformatics ‘Applications Note’, 23(14), pp. 1854–1856 (2007)
8. Makinen, V.P., et al.: High-throughput pedigree drawing. European Journal of Human Genetics 13, pp. 987–989 (2005)
9. Mancosu, G., Ledda, G., Melis, P.M.: PedNavigator: a pedigree drawing servlet for large and inbred populations. Bioinformatics ‘Applications Note’, 19(5), pp. 669–670 (2003)
10. Tores, F., Barillot, E.: The art of pedigree drawing: algorithmic aspects. Bioinformatics, 17(2), pp. 174–179 (2001)
11. Loh, A.M., et al.: Celestial3D: a novel method for 3D visualization of familial data. Bioinformatics ‘Applications Note’, 24(9), pp. 1210–1211 (2008)
12. Bennett, R.L., et al.: Recommendations for Standardized Human Pedigree Nomenclature. Journal of Genetic Counseling, 4(4), pp. 267–279 (1995)
13. PED Pedigree Software, <http://www.medgen.de/ped/>
14. PAF, <http://www.familysearch.org/>
15. ScionPC, <http://homepages.paradise.net.nz/scionpc/>
16. XY Family Tree, <http://www.xy-family-tree.com/>
17. WeRelate, http://www.werelate.org/wiki/Main_Page/
18. GenoPro, <http://www.genopro.com/>
19. GEDCOM LETTER, <http://en.wikipedia.org/wiki/GEDCOM>
20. Sugiyama, S., Ikuta, A., Shibata, M., Matsuura, T.: A Study of An Event Oriented Data Management Method for Displaying Genealogy: Widespread Hands to InTErconnect BASic Elements (WHItEBasE). International Journal of Computer Information Systems and Industrial Management Applications (IJCISIM), pp. 280–289 (2011) ISSN: 2150-7988/2
21. Sugiyama, S., Ikuta, A., Yokozawa, D., Shibata, M., Matsuura, T. : Displaying Genealogy with Various Layouts by using the “WHItEBasE” Method, International Journal of Computer Information Systems and Industrial Management Applications (IJCISIM), pp. 102-115 (2014) ISSN: 2150-7988/6
22. Sugiyama, S., Ikuta, A., Yokozawa, D., Shibata, M., Matsuura, T.: Displaying Genealogy with Adoptions and Multiple Remarriages Using the WHItEBasE, Proc. of International Conference on Computer Information Systems and Industrial Management (CISIM), LNCS 8104, pp. 325-336 (2013)
23. Sugiyama, S., Yokozawa, D., Ikuta, A., Hiratsuka, S., Saito, S., Shibata, M., Matsuura, T.: Abbreviation Method for Some Jointed Relations in Displaying Genealogy, Proc. of International Conference on Computer Information Systems and Industrial Management (CISIM), LNCS 8838, pp. 339-350 (2014)
24. Voon, F. W., Meow, K. T., Siew, H. O.: An Overview of Computer-Aided Medical Pedigree Drawing Systems, Proc. of CMU. J. Nat. Sci., 7(1), 95-108 (2008)
25. Nerva-Antonine dynasty, <http://en.wikipedia.org/wiki/Nerva>
26. Robin, L. B., Kathryn, S. F., Robert, G. R., Debra, L.D.: Standardized Human Pedigree Nomenclature: Update and Assessment of the Recommendations of the National Society of Genetic Counselors, Journal of Genetic Counseling, 18(5), 424-433 (2008)