



HAL
open science

Scalar Variable Speed Motor Control for Traction Systems with Torque and Field Orientation Filter

Paulo Mendonça, Duarte M. Sousa

► **To cite this version:**

Paulo Mendonça, Duarte M. Sousa. Scalar Variable Speed Motor Control for Traction Systems with Torque and Field Orientation Filter. 7th Doctoral Conference on Computing, Electrical and Industrial Systems (DoCEIS), Apr 2016, Costa de Caparica, Portugal. pp.226-234, 10.1007/978-3-319-31165-4_23 . hal-01438248

HAL Id: hal-01438248

<https://inria.hal.science/hal-01438248v1>

Submitted on 17 Jan 2017

HAL is a multi-disciplinary open access archive for the deposit and dissemination of scientific research documents, whether they are published or not. The documents may come from teaching and research institutions in France or abroad, or from public or private research centers.

L'archive ouverte pluridisciplinaire **HAL**, est destinée au dépôt et à la diffusion de documents scientifiques de niveau recherche, publiés ou non, émanant des établissements d'enseignement et de recherche français ou étrangers, des laboratoires publics ou privés.



Distributed under a Creative Commons Attribution 4.0 International License

Scalar Variable Speed Motor Control for Traction Systems with Torque and Field Orientation Filter

Paulo Mendonça, Duarte M. Sousa

DEEC, Instituto Superior Técnico, Technical University of Lisbon, Lisboa, Portugal & INESC-ID

paulo.mendonca@tecnico.ulisboa.pt, duarte.sousa@tecnico.ulisboa.pt

Abstract. Scalar traction control systems can be used in trains, trams and electrical vehicles equipped with induction motors. To increase the versatility and efficiency of such systems compared to conventional solutions, they must enable dynamic links to different types of power grids, i.e., be supplied by multi-frequency and multi-voltage power sources. Behind these solutions, there are control systems based on vectorial controllers. In order to set systems with the above features, in this work it is intended to build a scalar traction control system, in which the speed is controlled via a scalar controller. The system controls the motor speed and also the position of the rotor and stator fields. Furthermore, it allows to clearly setting the operation conditions, i.e., avoiding situations that would change from braking to traction and vice-versa due to operational and/or functional disturbances. To achieve the required speed reference follow up, the proposed solution includes a torque and field orientation filter.

Keywords: Variable speed, motor control, electric traction.

1 Introduction

Nowadays are commercialized several types of electrical vehicles, both road and rail vehicles, but in the near future it is expected that even more electrical vehicles will be manufactured. Besides the electrical vehicles, there are several industrial systems and solutions based on different types of electrical motors. The main purpose of this is to build a command variable speed system, for a rail traction system based on an induction motor, in which the speed is controlled instead of the torque and the controller is scalar and not vectorial. In addition, the proposed system allows avoiding undesirable situations, as for instance, changing from braking to traction and vice-versa due to operational and/or functional disturbances.

To build this system, which is a part of a larger traction system that is being developed in a PhD thesis, it was used as core systems a three arm inverter, a triphasic induction motor and a constant DC voltage source [1]. The inverter uses IGBT semiconductors, and they are controlled via a PWM SVM controller, which can be disabled by the main control system. This drive system must be adaptable to the different power grids used in the railway sector, i.e., be designed considering the requirements of multi-frequency and multi-voltage power supplies. Technically,

should also constitute a step forward of other requirements and features, such as energy efficiency, energy recovery, service interruptions, interoperability of transport networks, disturbance and failures in power systems, for instance. The solution to synthesize be an energy efficient and versatile solution in the face of conventional solutions, namely dynamically adapt to different feeding systems (multi-voltage and multi-frequency). This PhD thesis has the objective of building energy efficient and versatile multi voltage traction system for a rail vehicle when compared to conventional solutions.

The main control system controls the voltage input of the induction motor. The direct voltage is kept always at zero, and the quadrature voltage module is regulated according to the speed, via a hysteric controller and a proportional controller. The control angle is calculated and set according to the desired speed.

In many speed control systems, it is usual that the fluxes of the stator and rotor are, sometimes, in undesirable positions [2-6]. In these cases, the motor breaks when it is submitted to a traction effort. In this paper, this situation is analyzed and presented a solution, by predicting the position of the two vector fields and not allowing undesirable flux positions. This way the fluxes are always in the correct position and this flux filter is combined with a torque limitation filter. With this type of solution it is not only guaranteed a better controller reference follow up, but also, energy savings.

For testing and validating the proposed solution, a model of the system was simulated [2]. The main results illustrating the operation principles and the added value of the proposed solution are presented and discussed in this paper.

2 Contribution to Cyber-Physical Systems

Over the past decades, the operation of the railways have been changed in response to technological, social and economic challenges. As push factors of these changes, it is important to highlight the increasing number of rail operators sharing the same infrastructure, the advent of the smart grids and the adoption of cyber solutions. In this context, apart from the interoperability, security and safety of electric traction systems, remote control and cyber monitoring of railway operation are topics that have to be investigated and developed. To obtain efficient solutions that address these challenges have also to be made on valid cybernetic solutions.

It should be also referred that the operation of trams and of light rail vehicles can be monitored remotely in real time. These systems should also be able to optimize its operation, which can be set according to traffic or weather conditions, for instance. In addition, these systems have potential to incorporate new features, as for instance, acting as a backup energy storage system. Under this context, in this PhD work is described an approach that intends to contribute to control the speed of these type of electric vehicles. The proposed approach is integrated in a more complex solution that allows moving up the interaction of urban rail systems with smart electrical grids [1].

Considering the operating principle of the proposed solution, the main contribution of this work to “Technological Innovation for Cyber-Physical Systems” consist on the

development of a scalar variable speed motor control for traction systems that will allow implementing a full and remote automated driving.

3 System Description

3.1 Power System

The design used for the main power electronics system was a three arm inverted feed by a 600 V DC power source, which corresponds to the feeding voltage used in the Lisbon tramways. The inverter uses six IGBT semiconductors with parallel diodes [7-8].

The inverter feeds a 100 horsepower induction motor, which is a typical traction motor power in light railway.

The mathematical model used is the same as the one implemented in the simulation model. The induction motor electrical model is simulated based on the following equations:

$$\begin{aligned}
 V_{qs} &= R_s i_{qs} + \frac{d\varphi_{qs}}{dt} + \omega \varphi_{ds} \\
 V_{ds} &= R_s i_{ds} + \frac{d\varphi_{ds}}{dt} - \omega \varphi_{qs} \\
 V'_{qr} &= R'_r i'_{qr} + \frac{d\varphi'_{qr}}{dt} + (\omega - \omega_r) \varphi'_{ds} \\
 V'_{dr} &= R'_r i'_{dr} + \frac{d\varphi'_{dr}}{dt} - (\omega - \omega_r) \varphi'_{qs}
 \end{aligned} \tag{1}$$

Equation system (1), describes the voltage model in dq0 coordinates, where ω is the reference frame angular velocity and ω_r is the electrical angular velocity.

Equation system (2) is used to describe the torque behavior.

$$T_e = 1.5p(\varphi_{ds} i_{qs} - \varphi_{qs} i_{ds}) \tag{2}$$

Equation system (3) is used to describe the flux model.

$$\begin{aligned}
 \varphi_{qs} &= L_s i_{qs} + L_m i'_{qr} \\
 \varphi_{ds} &= L_s i_{ds} + L_m i'_{dr} \\
 \varphi'_{qr} &= L'_r i'_{qr} + L_m i_{qs} \\
 \varphi'_{dr} &= L'_r i'_{dr} + L_m i_{ds}
 \end{aligned} \tag{3}$$

Equation system (4) describes the inductance relationship.

$$\begin{aligned} L_s &= L_{ls} + L_m \\ L'_r &= L'_{lr} + L_m \end{aligned} \tag{4}$$

This model will give the dq fluxes components for the field orientation filter.

3.2 Main Controller

The main controller sets the direct voltage to zero and controls the quadrature voltage according to the desirable speed. The angle is calculated according to the desired speed, according to equation (5). The voltage provided by the controller is converted into gate pulses through a space vector controller.

Together with the main controller, the system has also two filters that are described in the following subsection. These two systems are responsible for limiting the torque, not allowing torques greater than 1000 Nm in the motor, and fluxes in undesirable positions.

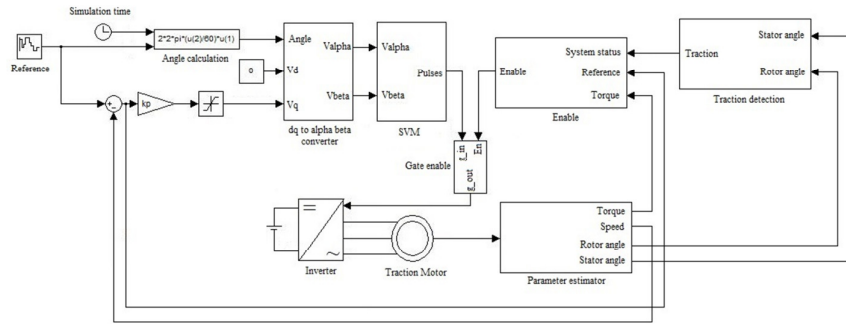

Fig. 1. Model of the proposed system

To control the motor speed, it is assumed that the motor speed is measured by a sensor, which output is used as feedback in the control chain (Fig. 1). The real speed is compared with the reference signal and multiplied by a gain. This result is limited between 500 V and -500 V, which are the desirable limits to the voltage applied to the motor. In practice, this is a proportional controller that controls the quadrature voltage module. The direct voltage is kept always at zero.

The voltage angle θ is calculated according to equation (5).

$$\theta = P_p \left(2\pi \frac{t}{60} \right) N_{ref} \tag{5}$$

In equation (5), P_p is the number of pole pairs in the machine, which is two in this case, t is the time and N_{ref} is the reference speed.

The block “dq to alfa beta converter”, converts the voltage in dq0 coordinates to $\alpha\beta$ coordinates. The block “SVM” converts the $\alpha\beta$ voltage components to PWM signals using a space vector modulator controller. So that, a control of the machine supply voltage is performed. The PWM signals command the six IGBT gates via a “Gate Enable” block, shown in figure 2, which is responsible for enabling and disabling the command signals. This block is commanded by the “Enable” block, so when the enable signal is 0, all gates commands are put to 0 also.

3.3 Torque and Field Orientation Filter

This filter prevents the torque to be greater than 1000 Nm. Every time that the torque exceeds this value the gate signals are disabled, which means in practice that all signals are set to zero. With this filter it is implemented a supervision of the torque avoiding to reach high torque values and thus preventing big current and torque surges.

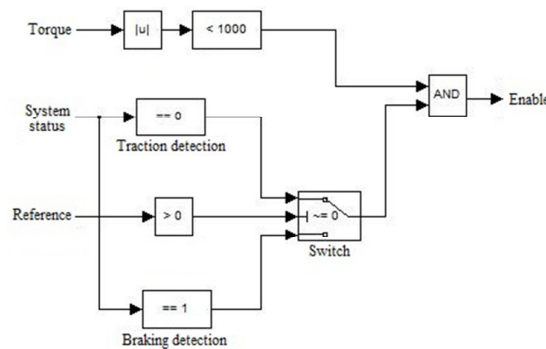

Fig. 2. Model of the “Gate Enable” block

The positions of the fluxes, the torque and the speed are calculated within the “parameter estimator” block, according to equations (1), (2), (3) and (4). It is important to refer that the accuracy of this model and of the prediction implemented depends on the knowledge of the motor parameters, as for instance, the real inductance and inductor resistance. The angle values are inputs of the “Traction Detection” block that predicts if the motor is braking or in traction. This filter contributes for a best energy usage and better reference follow up. Figure 3 shows the flux position and its effect.

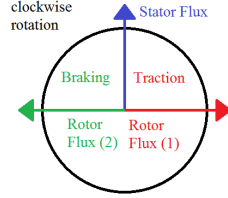

Fig. 3. Fluxes positioning and effect

Inside the “*traction detection*” block is the equation set (6) and (7). If the statement (6) OR (7) = TRUE is valid, than the system is braking.

$$\begin{cases} \varphi_r + \pi \geq \varphi_s \\ \varphi_s \geq \varphi_r \\ \varphi_r \geq 0 \\ \varphi_r \leq \pi \end{cases} \quad (6)$$

$$\begin{cases} \varphi_s \geq \varphi_r \\ \varphi_r \leq 0 \\ \varphi_r \geq \pi \end{cases} \quad (7)$$

After the selection had been made, than the enable block decides to enable or disenable the gate command block according to fig.5.

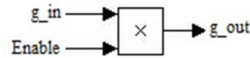

Fig. 4. Model of the “*Enable*” block

4 Results

In order to validate the proposed solution the system was tested by simulation with variable speed steps and loads, i.e., submitting the motor to different torques. It was tested the influence of the flux and torque filter, as well. The filter is responsible for not allowing unwanted flux positions and torques higher than 1000 Nm.

In the fig. 5 it can be observer a simulated result using a 10 Nm load, fig. 6 has the same simulation using a 100 Nm load, fig. 7 has a 300 Nm load and simulation 8 has a 100 Nm load and has no filter applied.

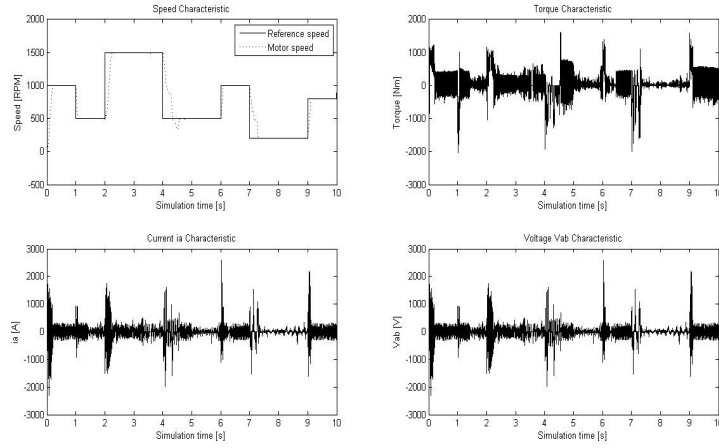

Fig. 5. Results for 10 Nm load.

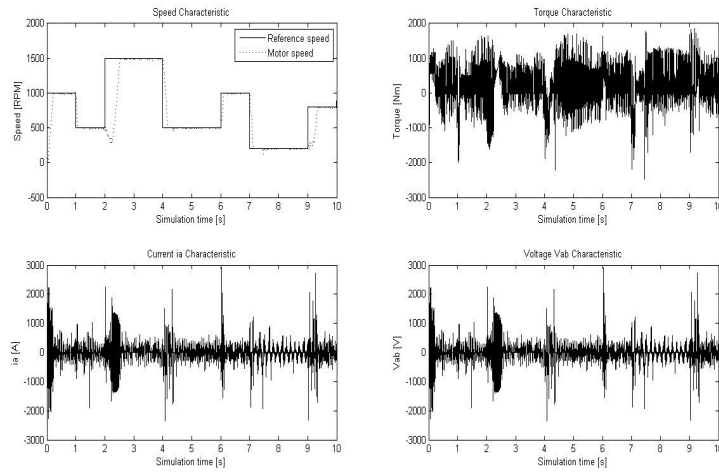

Fig. 6. Results for 100 Nm load.

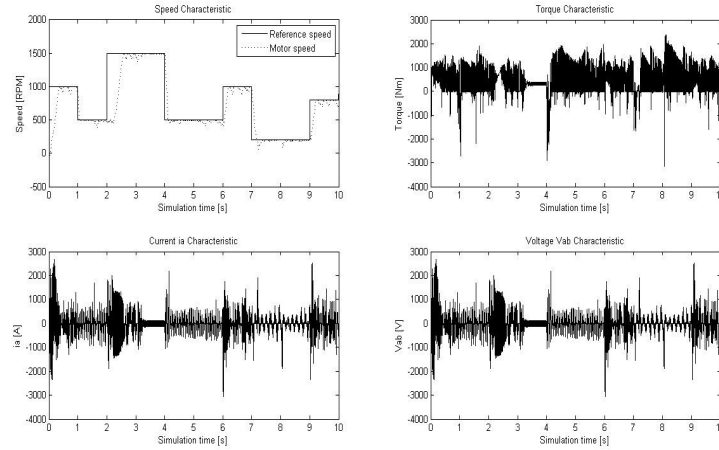

Fig. 7. Results for 300 Nm load.

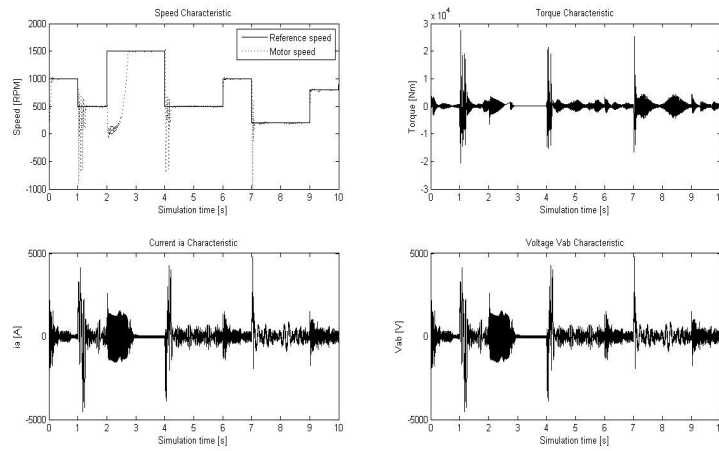

Fig. 8. Results for 100 Nm load, without using the filters described in subchapter 3.3.

In Fig. 5 to Fig. 8, it can be observed a good system follow up of the reference speed and without any static error. At higher speeds it can be observed some ripple and transients during some speed transitions. This can be due to simulation errors or a controller unable of guarantee every time smooth transitions. As it can be observed, at higher speeds the ripple decreases due to the machine characteristics, as expected, since the better performance of the system will be achieved in this speed range. All of

this ripple and transients will be reduced inside the rail vehicle car, because the transmission has a 1:6 reduction factor, in most light rail vehicles, and mechanic filters like silent blocks and other shock absorbing systems.

5 Conclusions and further work

In this work it was made a speed controller for rail traction, using a scalar controller. With the proposed system, it is achieved an effective control of the speed and, at the same time, the control system rejects states where the stator and rotor fluxes are in a traction position when the vehicle is in braking and states where the fluxes are in braking position when the vehicle is in traction. In addition the system prevents high levels of torque. To implement this option, filters are used constituting an important feature of this system, giving that the filters are compatible with a scalar control system and allow to achieve the required performance. This system is an alternative to the field orientation systems available and widely used.

For testing the results consistency, laboratorial test will be performed for the proposed system. It is expected to confirm the transient states and the load ripple observed in the simulations, since in a real rail vehicle there are mechanic filters like silent blocks and other shock absorbing systems that contribute to overcome these technical issues.

Considering the results obtained and the characteristics of the proposed system, being the speed control robust, in the future it is expected to implement a full automated driving, although it can be conventionally driven. It has the advantage of being energy efficient when it blocks high torques and undesirable flux positioning.

As further work, an interesting development would be to build a similar controller using the same concept, but instead of controlling the speed, controlling the torque.

Acknowledgements: This work was supported by national funds through FCT – Fundação para a Ciência e a Tecnologia, under project UID/CEC/50021/2013.

References

1. P. Mendonça, Duarte M. Sousa, José Fernando Silva, Sónia Pinto, “*An approach to recover braking energy of a tram*”, IEEE PEDG2014, Galway-Ireland, 2014.
2. Barbara H. Kenny and Robert D. Lorenz, Stator- and Rotor-Flux-Based Deadbeat Direct Torque Control of Induction Machines, IEEE TRANSACTIONS ON INDUSTRY APPLICATIONS, VOL. 39, NO. 4, JULY/AUGUST 2003.
3. G. D. Marques and Duarte M. Sousa, “Sensorless Direct Slip Position Estimator of a DFIM Based on the Air Gap pq Vector—Sensitivity Study,” IEEE TRANSACTIONS ON INDUSTRIAL ELECTRONICS, VOL. 60, NO. 6, JUNE 2013,
4. Gil D. Marques, Duarte M. Sousa, and Matteo F. Iacchetti, “An Open-Loop Sensorless Slip Position Estimator of a DFIM Based on Air-gap Active Power Calculations—Sensitivity Study,” IEEE TRANSACTIONS ON ENERGY CONVERSION, VOL. 28, NO. 4, DECEMBER 2013.

5. Matteo Felice Iacchetti, Gil D. Marques, Roberto Perini, and Duarte M. Sousa, "Stator Inductance Self-Tuning in an Air-Gap-Power-Vector-Based Observer for the Sensorless Control of Doubly Fed Induction Machines," IEEE TRANSACTIONS ON INDUSTRIAL ELECTRONICS, VOL. 61, NO. 1, JANUARY 2014.
6. G. D. Marques, Duarte M. Sousa, and Matteo F. Iacchetti, "Air-Gap Power-Based Sensorless Control in a DFIG Connected to a DC Link," IEEE TRANSACTIONS ON ENERGY CONVERSION, VOL. 30, NO. 1, MARCH 2015.
7. Jian Sun, Dynamics and Control of Switched Electronic Systems Advanced Perspectives for Modeling, Simulation and Control of Power Converters, Chapter 2, Vasca, F; Lannelli, L.(Eds.), ISBN: 978-1-4471-2884-7.
8. Silva, José Fernando, "*Electrónica Industrial*", Fundação Calouste Gulbenkian, Instituto Superior Técnico, 1998.