



HAL
open science

Comparison of solvers performance when solving the 3D Helmholtz elastic wave equations using the Hybridizable Discontinuous Galerkin method

Marie Bonnasse-Gahot, Henri Calandra, Julien Diaz, Stephane Lanteri

► **To cite this version:**

Marie Bonnasse-Gahot, Henri Calandra, Julien Diaz, Stephane Lanteri. Comparison of solvers performance when solving the 3D Helmholtz elastic wave equations using the Hybridizable Discontinuous Galerkin method. Workshop DIP - Depth Imaging Partnership, Oct 2016, Houston, United States. hal-01400656

HAL Id: hal-01400656

<https://inria.hal.science/hal-01400656v1>

Submitted on 22 Nov 2016

HAL is a multi-disciplinary open access archive for the deposit and dissemination of scientific research documents, whether they are published or not. The documents may come from teaching and research institutions in France or abroad, or from public or private research centers.

L'archive ouverte pluridisciplinaire **HAL**, est destinée au dépôt et à la diffusion de documents scientifiques de niveau recherche, publiés ou non, émanant des établissements d'enseignement et de recherche français ou étrangers, des laboratoires publics ou privés.

Comparison of solvers performance when solving the 3D Helmholtz elastic wave equations using the Hybridizable Discontinuous Galerkin method

M. Bonnasse-Gahot^{1,2}, H. Calandra³, J. Diaz¹ and S. Lanteri²

¹ INRIA Bordeaux-Sud-Ouest, team-project Magique 3D

² INRIA Sophia-Antipolis-Méditerranée, team-project Nachos

³ TOTAL Exploration-Production

Motivations

Imaging methods

- ▶ Reverse Time Migration (RTM) : based on the **reversibility of wave equation**
- ▶ Full Wave Inversion (FWI) : **inversion process** requiring to solve **many forward problems**

Motivations

Imaging methods

- ▶ Reverse Time Migration (RTM) : based on the **reversibility of wave equation**
- ▶ Full Wave Inversion (FWI) : **inversion process** requiring to solve **many forward problems**

Seismic imaging : time-domain or harmonic-domain ?

- ▶ **Time-domain** : **imaging condition complicated** but **quite low computational cost**
- ▶ **Harmonic-domain** : **imaging condition simple** but **huge computational cost**

Motivations

Imaging methods

- ▶ Reverse Time Migration (RTM) : based on the **reversibility of wave equation**
- ▶ Full Wave Inversion (FWI) : **inversion process** requiring to solve **many forward problems**

Seismic imaging : time-domain or harmonic-domain ?

- ▶ **Time-domain** : **imaging condition complicated** but **quite low computational cost**
- ▶ **Harmonic-domain** : **imaging condition simple** but **huge computational cost**



Memory usage



Motivations

Resolution of the forward problem of the inversion process

- ▶ Elastic wave propagation in the frequency domain : **Helmholtz equation**

Motivations

Resolution of the forward problem of the inversion process

- ▶ Elastic wave propagation in the frequency domain : **Helmholtz equation**

First order formulation of Helmholtz wave equations

$$\mathbf{x} = (x, y, z) \in \Omega \subset \mathbb{R}^3,$$

$$\begin{cases} i\omega\rho(\mathbf{x})\mathbf{v}(\mathbf{x}) = \nabla \cdot \underline{\underline{\sigma}}(\mathbf{x}) + \mathbf{f}_s(\mathbf{x}) \\ i\omega\underline{\underline{\sigma}}(\mathbf{x}) = \underline{\underline{C}}(\mathbf{x}) \underline{\underline{\varepsilon}}(\mathbf{v}(\mathbf{x})) \end{cases}$$

- ▶ \mathbf{v} : velocity vector
- ▶ $\underline{\underline{\sigma}}$: stress tensor
- ▶ $\underline{\underline{\varepsilon}}$: strain tensor

Motivations

Resolution of the forward problem of the inversion process

- ▶ Elastic wave propagation in the frequency domain : **Helmholtz equation**

First order formulation of Helmholtz wave equations

$$\mathbf{x} = (x, y, z) \in \Omega \subset \mathbb{R}^3,$$

$$\begin{cases} i\omega\rho(\mathbf{x})\mathbf{v}(\mathbf{x}) = \nabla \cdot \underline{\underline{\sigma}}(\mathbf{x}) + \mathbf{f}_s(\mathbf{x}) \\ i\omega\underline{\underline{\sigma}}(\mathbf{x}) = \underline{\underline{C}}(\mathbf{x}) \underline{\underline{\varepsilon}}(\mathbf{v}(\mathbf{x})) \end{cases}$$

- ▶ ρ : mass density
- ▶ $\underline{\underline{C}}$: elasticity tensor
- ▶ \mathbf{f}_s : source term, $\mathbf{f}_s \in L^2(\Omega)$

Approximation methods

Discontinuous Galerkin Methods

- ✓ unstructured tetrahedral meshes
- ✓ combination between FEM and finite volume method (FVM)
- ✓ *hp*-adaptivity
- ✓ easily parallelizable method

Approximation methods

Discontinuous Galerkin Methods

- ✓ unstructured tetrahedral meshes
- ✓ combination between FEM and finite volume method (FVM)
- ✓ *hp*-adaptivity
- ✓ easily parallelizable method
- ✗ ✗ large number of DOF as compared to classical FEM

Approximation methods

Discontinuous Galerkin Methods

- ✓ unstructured tetrahedral meshes
- ✓ combination between FEM and finite volume method (FVM)
- ✓ *hp*-adaptivity
- ✓ easily parallelizable method
- ✗ ✗ large number of DOF as compared to classical FEM

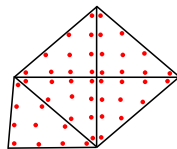
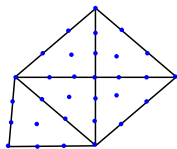

Approximation methods

Hybridizable Discontinuous Galerkin Methods

- ✓ same advantages as DG methods : unstructured tetrahedral meshes, *hp*-adaptivity, easily parallelizable method, discontinuous basis functions
- ✓ introduction of a new variable defined only on the interfaces
- ✓ lower number of coupled DOF than classical DG methods

Approximation methods

Hybridizable Discontinuous Galerkin Methods

- ✓ same advantages as DG methods : unstructured tetrahedral meshes, *hp*-adaptivity, easily parallelizable method, discontinuous basis functions
- ✓ introduction of a new variable defined only on the interfaces
- ✓ lower number of coupled DOF than classical DG methods

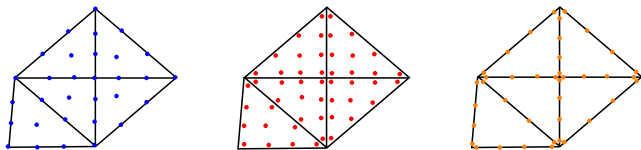



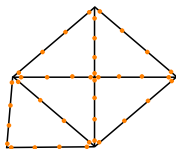
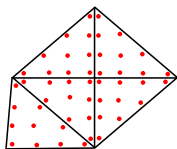
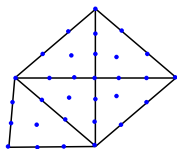

Approximation methods

Hybridizable Discontinuous Galerkin Methods

- ✓ same advantages as DG methods : unstructured tetrahedral meshes, *hp*-adaptivity, easily parallelizable method, discontinuous basis functions
- ✓ introduction of a new variable defined only on the interfaces
- ✓ lower number of coupled DOF than classical DG methods
- ✗ time-domain increases computational costs



Hybridizable Discontinuous Galerkin method

-  B. Cockburn, J. Gopalakrishnan and R. Lazarov. Unified hybridization of discontinuous Galerkin, mixed and continuous Galerkin methods for second order elliptic problems. *SIAM Journal on Numerical Analysis*, Vol. 47 :1319-1365, 2009.
-  S. Lanteri, L. Li and R. Perrussel. Numerical investigation of a high order hybridizable discontinuous Galerkin method for 2d time-harmonic Maxwell's equations. *COMPEL*, 32(3)1112-1138, 2013.
-  N.C. Nguyen, J. Peraire and B. Cockburn. High-order implicit hybridizable discontinuous Galerkin methods for acoustics and elastodynamics. *Journal of Computational Physics*, 230 :7151-7175, 2011
-  N.C. Nguyen and B. Cockburn. Hybridizable discontinuous Galerkin methods for partial differential equations in continuum mechanics. *Journal of Computational Physics* 231 :5955-5988, 2012

Contents

Hybridizable Discontinuous Galerkin method

- Classical HDG Formulation

- Symmetric HDG formulation

- Algorithm

2D Numerical results : comparison of the two HDG formulations

3D numerical results : focus on the resolution part

HDG formulation of the equations

Local HDG formulation

$$\begin{cases} i\omega\rho\mathbf{v} - \nabla \cdot \underline{\underline{\sigma}} = 0 \\ i\omega\underline{\underline{\sigma}} - \underline{\underline{C}}\varepsilon(\mathbf{v}) = 0 \end{cases}$$

HDG formulation of the equations

Local HDG formulation

$$\begin{cases} \int_K i\omega \rho^K \mathbf{v}^K \cdot \mathbf{w} + \int_K \underline{\underline{\sigma}}^K : \nabla \mathbf{w} - \int_{\partial K} \widehat{\underline{\underline{\sigma}}}^{\partial K} \cdot \mathbf{n} \cdot \mathbf{w} = 0 \\ \int_K i\omega \underline{\underline{\sigma}}^K : \underline{\underline{\xi}} + \int_K \mathbf{v}^K \cdot \nabla \cdot (\underline{\underline{C}}^K \underline{\underline{\xi}}) - \int_{\partial K} \widehat{\mathbf{v}}^{\partial K} \cdot \underline{\underline{C}}^K \underline{\underline{\xi}} \cdot \mathbf{n} = 0 \end{cases}$$

$\widehat{\underline{\underline{\sigma}}}^K$ and $\widehat{\mathbf{v}}^K$ are numerical traces of $\underline{\underline{\sigma}}^K$ and \mathbf{v}^K respectively on ∂K

HDG formulation of the equations

We define :

$$\hat{v}^{\partial K} = \lambda^F, \quad \forall F \in \mathcal{F}_h,$$

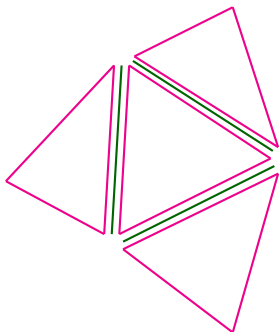

HDG formulation of the equations

We define :

$$\begin{aligned} \hat{\mathbf{v}}^{\partial K} &= \lambda^F, & \forall F \in \mathcal{F}_h, \\ \underline{\hat{\sigma}}^{\partial K} \cdot \mathbf{n} &= \underline{\sigma}^K \cdot \mathbf{n} - \tau \mathbf{l} (\mathbf{v}^K - \lambda^F), & \text{on } \partial K \end{aligned}$$

where τ is the stabilization parameter ($\tau > 0$)

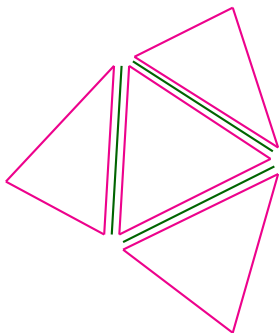

HDG formulation of the equations

Local HDG formulation

$$\left\{ \begin{array}{l} \int_K i\omega \rho^K \mathbf{v}^K \cdot \mathbf{w} - \int_K (\nabla \cdot \underline{\underline{\sigma}}^K) \cdot \mathbf{w} + \int_{\partial K} \tau \mathbf{l} (\mathbf{v}^K - \lambda^F) \cdot \mathbf{w} = 0 \\ \int_K i\omega \underline{\underline{\sigma}}^K : \underline{\underline{\xi}} + \int_K \mathbf{v}^K \cdot \nabla \cdot (\underline{\underline{C}}^K \underline{\underline{\xi}}) - \int_{\partial K} \lambda^F \cdot \underline{\underline{C}}^K \underline{\underline{\xi}} \cdot \mathbf{n} = 0 \end{array} \right.$$

HDG formulation of the equations

Local HDG formulation

$$\begin{cases} \int_K i\omega \rho^K \mathbf{v}^K \cdot \mathbf{w} - \int_K (\nabla \cdot \underline{\underline{\sigma}}^K) \cdot \mathbf{w} + \int_{\partial K} \tau \mathbf{l} (\mathbf{v}^K - \lambda^F) \cdot \mathbf{w} = 0 \\ \int_K i\omega \underline{\underline{\sigma}}^K : \underline{\underline{\xi}} + \int_K \mathbf{v}^K \cdot \nabla \cdot (\underline{\underline{C}}^K \underline{\underline{\xi}}) - \int_{\partial K} \lambda^F \cdot \underline{\underline{C}}^K \underline{\underline{\xi}} \cdot \mathbf{n} = 0 \end{cases}$$

We define :

$$\underline{\underline{W}}^K = \left(\underline{V}_x^K, \underline{V}_y^K, \underline{V}_z^K, \underline{\sigma}_{xx}^K, \underline{\sigma}_{yy}^K, \underline{\sigma}_{zz}^K, \underline{\sigma}_{xy}^K, \underline{\sigma}_{xz}^K, \underline{\sigma}_{yz}^K \right)^T$$

$$\underline{\underline{\Lambda}} = \left(\underline{\Lambda}^{F_1}, \underline{\Lambda}^{F_2}, \dots, \underline{\Lambda}^{F_{n_f}} \right)^T, \text{ where } n_f = \text{card}(\mathcal{F}_h)$$

Discretization of the local HDG formulation

$$\underline{\underline{A}}^K \underline{\underline{W}}^K + \sum_{F \in \partial K} \underline{\underline{C}}^{K,F} \underline{\underline{\Lambda}} = 0$$

HDG formulation of the equations

Local HDG formulation

$$\begin{cases} \int_K i\omega\rho^K \mathbf{v}^K \cdot \mathbf{w} - \int_K (\nabla \cdot \underline{\underline{\sigma}}^K) \cdot \mathbf{w} + \int_{\partial K} \tau \mathbf{l} (\mathbf{v}^K - \lambda^F) \cdot \mathbf{w} = 0 \\ \int_K i\omega \underline{\underline{\sigma}}^K : \underline{\underline{\xi}} + \int_K \mathbf{v}^K \cdot \nabla \cdot (\underline{\underline{C}}^K \underline{\underline{\xi}}) - \int_{\partial K} \lambda^F \cdot \underline{\underline{C}}^K \underline{\underline{\xi}} \cdot \mathbf{n} = 0 \end{cases}$$

We define :

$$\underline{\underline{W}}^K = \left(\underline{\underline{V}}_x^K, \underline{\underline{V}}_y^K, \underline{\underline{V}}_z^K, \underline{\underline{\sigma}}_{xx}^K, \underline{\underline{\sigma}}_{yy}^K, \underline{\underline{\sigma}}_{zz}^K, \underline{\underline{\sigma}}_{xy}^K, \underline{\underline{\sigma}}_{xz}^K, \underline{\underline{\sigma}}_{yz}^K \right)^T$$

$$\underline{\underline{\Lambda}} = \left(\underline{\underline{\Lambda}}^{F_1}, \underline{\underline{\Lambda}}^{F_2}, \dots, \underline{\underline{\Lambda}}^{F_{n_f}} \right)^T, \text{ where } n_f = \text{card}(\mathcal{F}_h)$$

Discretization of the local HDG formulation

$$\mathbf{A}^K \underline{\underline{W}}^K + \mathbf{C}^K \underline{\underline{\Lambda}} = 0$$

HDG formulation of the equations

Transmission condition

In order to determine λ^F , the continuity of the normal component of $\underline{\hat{\sigma}}^{\partial K}$ is weakly enforced, rendering this numerical trace conservative :

$$\int_F \llbracket \underline{\hat{\sigma}}^{\partial K} \cdot \mathbf{n} \rrbracket \cdot \eta = 0$$

HDG formulation of the equations

Transmission condition

In order to determine λ^F , the continuity of the normal component of $\underline{\hat{\sigma}}^{\partial K}$ is weakly enforced, rendering this numerical trace conservative :

$$\int_F \llbracket \underline{\hat{\sigma}}^{\partial K} \cdot \mathbf{n} \rrbracket \cdot \eta = 0$$

Replacing $(\underline{\hat{\sigma}}^{\partial K} \cdot \mathbf{n})$ and summing over all faces, the transmission condition becomes :

$$\sum_{K \in \mathcal{T}_h} \int_{\partial K} (\underline{\hat{\sigma}}^K \cdot \mathbf{n}) \cdot \eta - \sum_{K \in \mathcal{T}_h} \int_{\partial K} \tau \mathbf{l} (\mathbf{v}^K - \lambda^F) \cdot \eta = 0$$

HDG formulation of the equations

Transmission condition

In order to determine λ^F , the continuity of the normal component of $\underline{\underline{\hat{\sigma}}}^{\partial K}$ is weakly enforced, rendering this numerical trace conservative :

$$\int_F [[\underline{\underline{\hat{\sigma}}}^{\partial K} \cdot \mathbf{n}]] \cdot \eta = 0$$

Replacing $(\underline{\underline{\hat{\sigma}}}^{\partial K} \cdot \mathbf{n})$ and summing over all faces, the transmission condition becomes :

$$\sum_{K \in \mathcal{T}_h} \int_{\partial K} (\underline{\underline{\hat{\sigma}}}^K \cdot \mathbf{n}) \cdot \eta - \sum_{K \in \mathcal{T}_h} \int_{\partial K} \tau \mathbf{l} (\mathbf{v}^K - \lambda^F) \cdot \eta = 0$$

Discretization of the transmission condition

$$\sum_{K \in \mathcal{T}_h} [\mathbb{B}^K \underline{\underline{W}}^K + \mathbb{L}^K \underline{\underline{\Lambda}}] = 0$$

HDG formulation of the equations

Global HDG formulation

$$\left\{ \begin{array}{l} \int_K i\omega \rho^K \mathbf{v}^K \cdot \mathbf{w} - \int_K (\nabla \cdot \underline{\underline{\sigma}}^K) \cdot \mathbf{w} + \int_{\partial K} \tau \mathbf{l} (\mathbf{v}^K - \lambda^F) \cdot \mathbf{w} = 0 \\ \int_K i\omega \underline{\underline{\sigma}}^K : \underline{\underline{\xi}} + \int_K \mathbf{v}^K \cdot \nabla \cdot (\underline{\underline{C}}^K \underline{\underline{\xi}}) - \int_{\partial K} \lambda^F \cdot \underline{\underline{C}}_{K\underline{\underline{\xi}}} \cdot \mathbf{n} = 0 \\ \sum_{K \in \mathcal{T}_h} \int_{\partial K} (\underline{\underline{\sigma}}^K \cdot \mathbf{n}) \cdot \eta - \sum_{K \in \mathcal{T}_h} \int_{\partial K} \tau \mathbf{l} (\mathbf{v}^K - \lambda^F) \cdot \eta = 0 \end{array} \right.$$

HDG formulation of the equations

Global HDG discretization

$$\left\{ \begin{array}{l} \mathbf{A}^K \underline{W}^K + \mathbf{C}^K \underline{\Lambda} = 0 \\ \sum_{K \in \mathcal{T}_h} [\mathbf{B}^K \underline{W}^K + \mathbf{L}^K \underline{\Lambda}] = 0 \end{array} \right.$$

HDG formulation of the equations

Global HDG discretization

$$\left\{ \begin{array}{l} \underline{W}^K = -(\underline{A}^K)^{-1} \underline{C}^K \underline{\Lambda} \\ \sum_{K \in \mathcal{T}_h} [\underline{B}^K \underline{W}^K + \underline{L}^K \underline{\Lambda}] = 0 \end{array} \right.$$

HDG formulation of the equations

Global HDG discretization

$$\sum_{K \in \mathcal{T}_h} [-\mathbf{B}^K (\mathbf{A}^K)^{-1} \mathbf{C}^K + \mathbf{L}^K] \underline{\Delta} = 0$$

Symmetric HDG formulation

Local HDG formulation

$$\begin{cases} i\omega\rho\mathbf{v} - \nabla \cdot \underline{\underline{\sigma}} = 0 \\ i\omega\underline{\underline{\sigma}} - \underline{\underline{C}}\underline{\underline{\varepsilon}}(\mathbf{v}) = 0 \end{cases}$$

Symmetric HDG formulation

Local HDG formulation

$$\begin{cases} i\omega\rho\mathbf{v} - \nabla \cdot \underline{\underline{\sigma}} = 0 \\ i\omega\underline{\underline{\sigma}} - \underline{\underline{C}}\underline{\underline{\varepsilon}}(\mathbf{v}) = 0 \end{cases}$$

$\underline{\underline{C}}$ invertible and symmetric tensor, i.e for a symmetric $\underline{\underline{\sigma}}$:

$$\underline{\underline{\sigma}} = \underline{\underline{C}}\underline{\underline{\varepsilon}}(\mathbf{u}) \quad \text{and} \quad \underline{\underline{\varepsilon}}(\mathbf{u}) = \underline{\underline{D}}\underline{\underline{\sigma}}$$

with $\underline{\underline{D}} = \underline{\underline{C}}^{-1}$ and $\mathbf{u} = i\omega\mathbf{v}$

Symmetric HDG formulation

Local HDG formulation

$$\begin{cases} \int_K i\omega\rho^K \mathbf{v}^K \cdot \mathbf{w} + \int_K \underline{\underline{\sigma}}^K : \nabla \mathbf{w} - \int_{\partial K} \widehat{\underline{\underline{\sigma}}}^{\partial K} \cdot \mathbf{n} \cdot \mathbf{w} = 0 \\ \int_K i\omega \underline{\underline{\sigma}}^K : \underline{\underline{\xi}} + \int_K \mathbf{v}^K \cdot \nabla \cdot (\underline{\underline{C}}^K \underline{\underline{\xi}}) - \int_{\partial K} \widehat{\mathbf{v}}^{\partial K} \cdot \underline{\underline{C}}^K \underline{\underline{\xi}} \cdot \mathbf{n} = 0 \end{cases}$$

$\widehat{\underline{\underline{\sigma}}}^K$ and $\widehat{\mathbf{v}}^K$ are numerical traces of $\underline{\underline{\sigma}}^K$ and \mathbf{v}^K respectively on ∂K

Symmetric HDG formulation

Local HDG formulation

$$\begin{cases} \int_K i\omega\rho^K \mathbf{v}^K \cdot \mathbf{w} + \int_K \underline{\underline{\sigma}}^K : \nabla \mathbf{w} - \int_{\partial K} \widehat{\underline{\underline{\sigma}}}^{\partial K} \cdot \mathbf{n} \cdot \mathbf{w} = 0 \\ \int_K i\omega \underline{\underline{\sigma}}^K : \underline{\underline{\xi}} + \int_K \mathbf{v}^K \cdot \nabla \cdot (\underline{\underline{C}}^K \underline{\underline{\xi}}) - \int_{\partial K} \widehat{\mathbf{v}}^{\partial K} \cdot \underline{\underline{C}}^K \underline{\underline{\xi}} \cdot \mathbf{n} = 0 \end{cases}$$

$\widehat{\underline{\underline{\sigma}}}^K$ and $\widehat{\mathbf{v}}^K$ are numerical traces of $\underline{\underline{\sigma}}^K$ and \mathbf{v}^K respectively on ∂K

$$\underline{\underline{\xi}} = -\underline{\underline{D}}^K \underline{\underline{\xi}}'$$

Symmetric HDG formulation

Local HDG formulation

$$\left\{ \begin{array}{l} \int_K i\omega \rho^K \mathbf{v}^K \cdot \mathbf{w} + \int_K \underline{\underline{\sigma}}^K : \nabla \mathbf{w} - \int_{\partial K} \widehat{\underline{\underline{\sigma}}}^{\partial K} \cdot \mathbf{n} \cdot \mathbf{w} = 0 \\ - \int_K i\omega \underline{\underline{\sigma}}^K : \underline{\underline{D}}^K \underline{\underline{\xi}}' - \int_K \mathbf{v}^K \cdot \nabla \cdot \left(\underline{\underline{C}}^K \underline{\underline{D}}^K \underline{\underline{\xi}}' \right) \\ \quad + \int_{\partial K} \widehat{\underline{\underline{v}}}^{\partial K} \cdot \underline{\underline{C}}^K \underline{\underline{D}}^K \underline{\underline{\xi}}' \cdot \mathbf{n} = 0 \end{array} \right.$$

Symmetric HDG formulation

Local HDG formulation

$$\left\{ \begin{array}{l} \int_K i\omega \rho^K \mathbf{v}^K \cdot \mathbf{w} + \int_K \underline{\underline{\sigma}}^K : \nabla \mathbf{w} - \int_{\partial K} \underline{\underline{\hat{\sigma}}}^{\partial K} \cdot \mathbf{n} \cdot \mathbf{w} = 0 \\ - \int_K i\omega \underline{\underline{D}}^K \underline{\underline{\sigma}}^K : \underline{\underline{\xi}}' - \int_K \mathbf{v}^K \cdot \nabla \cdot \underline{\underline{\xi}}' + \int_{\partial K} \underline{\underline{\hat{v}}}^{\partial K} \cdot \underline{\underline{\xi}}' \cdot \mathbf{n} = 0 \end{array} \right.$$

Symmetric HDG formulation

Local HDG formulation

$$\left\{ \begin{array}{l} \int_K i\omega \rho^K \mathbf{v}^K \cdot \mathbf{w} + \int_K \underline{\underline{\sigma}}^K : \nabla \mathbf{w} - \int_{\partial K} \widehat{\underline{\underline{\sigma}}}^{\partial K} \cdot \mathbf{n} \cdot \mathbf{w} = 0 \\ - \int_K i\omega \underline{\underline{D}}^K \underline{\underline{\sigma}}^K : \underline{\underline{\xi}}' - \int_K \mathbf{v}^K \cdot \nabla \cdot \underline{\underline{\xi}}' + \int_{\partial K} \widehat{\mathbf{v}}^{\partial K} \cdot \underline{\underline{\xi}}' \cdot \mathbf{n} = 0 \end{array} \right.$$

$$\begin{aligned} \widehat{\mathbf{v}}^{\partial K} &= \lambda^F, & \forall F \in \mathcal{F}_h, \\ \widehat{\underline{\underline{\sigma}}}^{\partial K} \cdot \mathbf{n} &= \underline{\underline{\sigma}}^K \cdot \mathbf{n} - \tau \mathbf{l}(\mathbf{v}^K - \lambda^F), & \text{on } \partial K \end{aligned}$$

Symmetric HDG formulation

Local HDG formulation

$$\left\{ \begin{array}{l} \int_K i\omega \rho^K \mathbf{v}^K \cdot \mathbf{w} - \int_K (\nabla \cdot \underline{\underline{\sigma}}^K) \cdot \mathbf{w} + \int_{\partial K} \tau \mathbf{l} (\mathbf{v}^K - \lambda^F) \cdot \mathbf{w} = 0 \\ - \int_K i\omega \underline{\underline{D}}^K \underline{\underline{\sigma}}^K : \underline{\underline{\xi}}' - \int_K \mathbf{v}^K \cdot \nabla \cdot \underline{\underline{\xi}}' + \int_{\partial K} \lambda^F \cdot \underline{\underline{\xi}}' \cdot \mathbf{n} = 0 \end{array} \right.$$

Symmetric HDG formulation

Local HDG formulation

$$\begin{cases} \int_K i\omega \rho^K \mathbf{v}^K \cdot \mathbf{w} - \int_K (\nabla \cdot \underline{\underline{\sigma}}^K) \cdot \mathbf{w} + \int_{\partial K} \tau \mathbf{l} (\mathbf{v}^K - \lambda^F) \cdot \mathbf{w} = 0 \\ - \int_K i\omega \underline{\underline{D}}^K \underline{\underline{\sigma}}^K : \underline{\underline{\xi}}' - \int_K \mathbf{v}^K \cdot \nabla \cdot \underline{\underline{\xi}}' + \int_{\partial K} \lambda^F \cdot \underline{\underline{\xi}}' \cdot \mathbf{n} = 0 \end{cases}$$

Discretization of the local HDG formulation

$$\mathbb{A}_2^K \underline{\underline{W}}^K + \sum_{F \in \partial K} \mathbb{C}_2^{K,F} \underline{\underline{\Lambda}} = 0$$

Symmetric HDG formulation

Local HDG formulation

$$\left\{ \begin{array}{l} \int_K i\omega \rho^K \mathbf{v}^K \cdot \mathbf{w} - \int_K (\nabla \cdot \underline{\underline{\sigma}}^K) \cdot \mathbf{w} + \int_{\partial K} \tau \mathbf{l} (\mathbf{v}^K - \lambda^F) \cdot \mathbf{w} = 0 \\ - \int_K i\omega \underline{\underline{D}}^K \underline{\underline{\sigma}}^K : \underline{\underline{\xi}}' - \int_K \mathbf{v}^K \cdot \nabla \cdot \underline{\underline{\xi}}' + \int_{\partial K} \lambda^F \cdot \underline{\underline{\xi}}' \cdot \mathbf{n} = 0 \end{array} \right.$$

Discretization of the local HDG formulation

$$\mathbb{A}_2^K \underline{\underline{W}}^K + \mathbb{C}_2^K \underline{\underline{\Lambda}} = 0$$

Symmetric HDG formulation

Local HDG formulation

$$\begin{cases} \int_K i\omega \rho^K \mathbf{v}^K \cdot \mathbf{w} - \int_K (\nabla \cdot \underline{\underline{\sigma}}^K) \cdot \mathbf{w} + \int_{\partial K} \tau \mathbf{l} (\mathbf{v}^K - \lambda^F) \cdot \mathbf{w} = 0 \\ - \int_K i\omega \underline{\underline{D}}^K \underline{\underline{\sigma}}^K : \underline{\underline{\xi}}' - \int_K \mathbf{v}^K \cdot \nabla \cdot \underline{\underline{\xi}}' + \int_{\partial K} \lambda^F \cdot \underline{\underline{\xi}}' \cdot \mathbf{n} = 0 \end{cases}$$

Discretization of the local HDG formulation

$$\mathbb{A}_2^K \underline{\underline{W}}^K + \mathbb{C}_2^K \underline{\underline{\Lambda}} = 0$$



\mathbb{A}_2^K symmetric matrix

Symmetric HDG formulation

Transmission condition

$$\int_F \llbracket \underline{\hat{\sigma}}^{\partial K} \cdot \mathbf{n} \rrbracket \cdot \eta = 0$$

Symmetric HDG formulation

Transmission condition

$$\int_F \llbracket \underline{\hat{\sigma}}^{\partial K} \cdot \mathbf{n} \rrbracket \cdot \eta = 0$$

$$\sum_{K \in \mathcal{T}_h} \int_{\partial K} (\underline{\sigma}^K \cdot \mathbf{n}) \cdot \eta - \sum_{K \in \mathcal{T}_h} \int_{\partial K} \tau \mathbf{l} (\mathbf{v}^K - \lambda^F) \cdot \eta = 0$$

Symmetric HDG formulation

Transmission condition

$$\int_F [[\underline{\hat{\sigma}}^{\partial K} \cdot \mathbf{n}]] \cdot \eta = 0$$

$$\sum_{K \in \mathcal{T}_h} \int_{\partial K} (\underline{\hat{\sigma}}^K \cdot \mathbf{n}) \cdot \eta - \sum_{K \in \mathcal{T}_h} \int_{\partial K} \tau \mathbf{l} (\mathbf{v}^K - \lambda^F) \cdot \eta = 0$$

Discretization of the transmission condition

$$\sum_{K \in \mathcal{T}_h} [\mathbb{B}^K \underline{W}^K + \mathbb{L}^K \underline{\Lambda}] = 0$$

Symmetric HDG formulation

Transmission condition

$$\int_F [[\underline{\underline{\hat{\sigma}}}^{\partial K} \cdot \mathbf{n}]] \cdot \eta = 0$$

$$\sum_{K \in \mathcal{T}_h} \int_{\partial K} (\underline{\underline{\sigma}}^K \cdot \mathbf{n}) \cdot \eta - \sum_{K \in \mathcal{T}_h} \int_{\partial K} \tau \mathbf{l} (\mathbf{v}^K - \lambda^F) \cdot \eta = 0$$

Discretization of the transmission condition

$$\sum_{K \in \mathcal{T}_h} [\mathbb{B}^K \underline{\underline{w}}^K + \mathbb{L}^K \underline{\underline{\Lambda}}] = 0$$

$$\mathbb{B}^K = (\mathbb{C}_2^K)^T$$

Symmetric HDG formulation

Transmission condition

$$\int_F [[\underline{\hat{\sigma}}^{\partial K} \cdot \mathbf{n}]] \cdot \eta = 0$$

$$\sum_{K \in \mathcal{T}_h} \int_{\partial K} (\underline{\sigma}^K \cdot \mathbf{n}) \cdot \eta - \sum_{K \in \mathcal{T}_h} \int_{\partial K} \tau \mathbf{l} (\mathbf{v}^K - \lambda^F) \cdot \eta = 0$$

Discretization of the transmission condition

$$\sum_{K \in \mathcal{T}_h} [(\mathbf{C}_2^K)^T \underline{W}^K + \mathbf{L}^K \underline{\Lambda}] = 0$$

Symmetric HDG formulation of the equations

Global HDG formulation

$$\left\{ \begin{array}{l} \int_K i\omega \rho^K \mathbf{v}^K \cdot \mathbf{w} - \int_K (\nabla \cdot \underline{\underline{\sigma}}^K) \cdot \mathbf{w} + \int_{\partial K} \tau \mathbf{l} (\mathbf{v}^K - \lambda^F) \cdot \mathbf{w} = 0 \\ - \int_K i\omega \underline{\underline{D}}^K \underline{\underline{\sigma}}^K : \underline{\underline{\xi}}' - \int_K \mathbf{v}^K \cdot \nabla \cdot \underline{\underline{\xi}}' + \int_{\partial K} \lambda^F \cdot \underline{\underline{\xi}}' \cdot \mathbf{n} = 0 \\ \sum_{K \in \mathcal{T}_h} \int_{\partial K} (\underline{\underline{\sigma}}^K \cdot \mathbf{n}) \cdot \eta - \sum_{K \in \mathcal{T}_h} \int_{\partial K} \tau \mathbf{l} (\mathbf{v}^K - \lambda^F) \cdot \eta = 0 \end{array} \right.$$

Symmetric HDG formulation of the equations

Global HDG discretization

$$\left\{ \begin{array}{l} \mathbb{A}_2^K \underline{W}^K + \mathbb{C}_2^K \underline{\Lambda} = 0 \\ \sum_{K \in \mathcal{T}_h} [(\mathbb{C}_2^K)^T \underline{W}^K + \mathbb{L}^K \underline{\Lambda}] = 0 \end{array} \right.$$

Symmetric HDG formulation of the equations

Global HDG discretization

$$\left\{ \begin{array}{l} \underline{W}^K = -(\underline{A}_2^K)^{-1} \underline{C}_2^K \underline{\Lambda} \\ \sum_{K \in \mathcal{T}_h} [(\underline{C}_2^K)^T \underline{W}^K + \underline{L}^K \underline{\Lambda}] = 0 \end{array} \right.$$

Symmetric HDG formulation of the equations

Global HDG discretization

$$\sum_{K \in \mathcal{T}_h} [-(\mathbf{C}_2^K)^T (\mathbf{A}_2^K)^{-1} \mathbf{C}_2^K + \mathbf{L}^K] \underline{\underline{\Lambda}} = 0$$

Symmetric HDG formulation of the equations

Global HDG discretization

$$\sum_{K \in \mathcal{T}_h} [-(\mathbf{C}_2^K)^T (\mathbf{A}_2^K)^{-1} \mathbf{C}_2^K + \mathbf{L}^K] \underline{\underline{\Lambda}} = 0$$

\Rightarrow **Symmetric linear system**

Main steps of the HDG algorithm

1. Construction of the global matrix \mathbf{M}

with
$$\mathbf{M} = \sum_{K \in \mathcal{T}_h} \left[-\mathbf{B}^K (\mathbf{A}^K)^{-1} \mathbf{C}^K + \mathbf{L}^K \right]$$

for $K = 1$ to Nb_{tri} **do**

 Computation of matrices \mathbf{B}^K , $(\mathbf{A}^K)^{-1}$, \mathbf{C}^K and \mathbf{L}^K

 Construction of the corresponding section of \mathbf{M}

end for

Main steps of the HDG algorithm

-
1. Construction of the global matrix \mathbf{M}
 2. Construction of the right hand side \mathbf{S}
-

Main steps of the HDG algorithm

-
1. Construction of the global matrix \mathbf{M}
 2. Construction of the right hand side \mathbf{S}
 3. Resolution $\mathbf{M}\underline{\Lambda} = \mathbf{S}$, with a direct solver (MUMPS) or hybrid solver (MaPhys)
-

Main steps of the HDG algorithm

-
-
1. Construction of the global matrix \mathbf{M}
 2. Construction of the right hand side \mathbf{S}
 3. Resolution $\mathbf{M}\underline{\Lambda} = \mathbf{S}$, with a direct solver (MUMPS) or hybrid solver (MaPhys)
 4. Computation of the solutions of the initial problem
-

Main steps of the HDG algorithm

-
1. Construction of the global matrix $\underline{\mathbf{M}}$
 2. Construction of the right hand side $\underline{\mathbf{S}}$
 3. Resolution $\underline{\mathbf{M}}\underline{\mathbf{\Lambda}} = \underline{\mathbf{S}}$, with a direct solver (MUMPS) or hybrid solver (MaPhys)
 4. Computation of the solutions of the initial problem

for $K = 1$ to Nb_{tri} **do**
 Compute $\underline{\mathbf{W}}^K = -(\underline{\mathbf{A}}^K)^{-1}\underline{\mathbf{C}}^K\underline{\mathbf{\Lambda}}$
end for

Contents

Hybridizable Discontinuous Galerkin method

2D Numerical results : comparison of the two HDG formulations

Plane wave in an homogeneous medium

Anisotropic test case

3D numerical results : focus on the resolution part

Plane wave

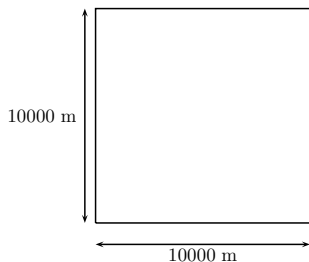

Computational domain Ω
setting

► Physical parameters :

- $\rho = 2000 \text{ kg.m}^{-3}$
- $\lambda = 16 \text{ GPa}$
- $\mu = 8 \text{ GPa}$

► Plane wave :

$$u = \nabla e^{i(k \cos \theta x + k \sin \theta y)}$$

where $k = \frac{\omega}{v_p}$

- $\theta = 0, v_p = 4000 \text{ m.s}^{-1}, \omega = 4\pi$
- Three meshes :
 - 3000 elements
 - 10000 elements
 - 45000 elements

Plane wave : Convergence order

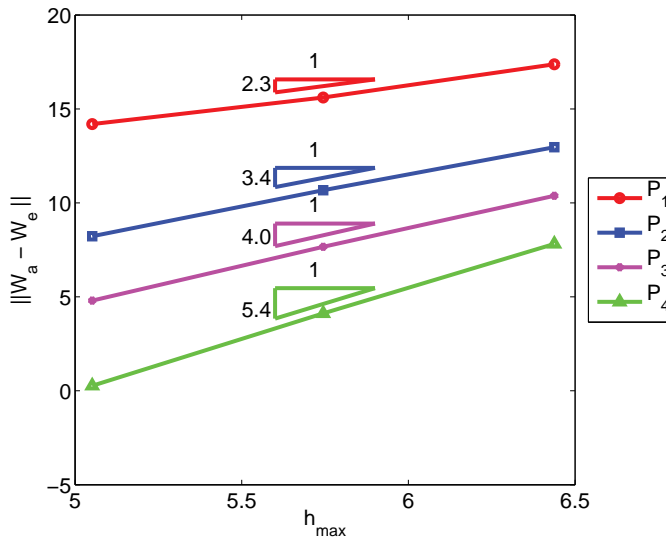

Plane wave : Memory consumption

Finest mesh (45000 elements)

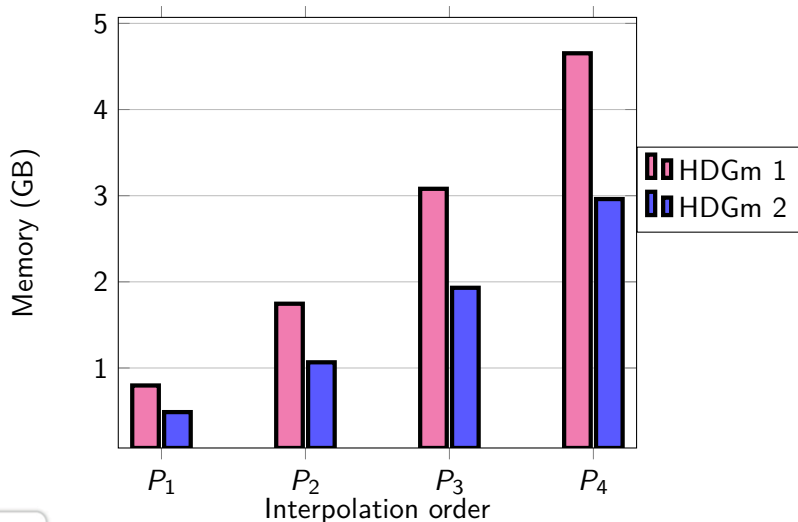

Plane wave : Memory consumption

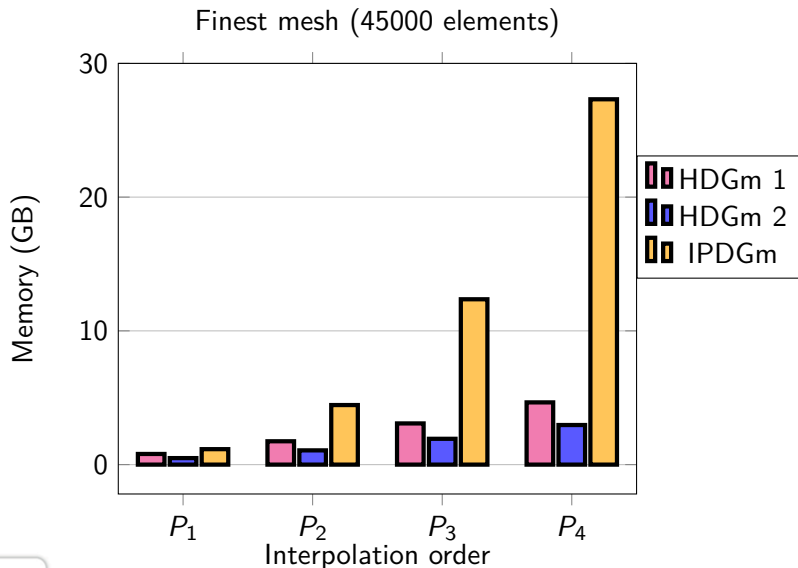

Plane wave : CPU time

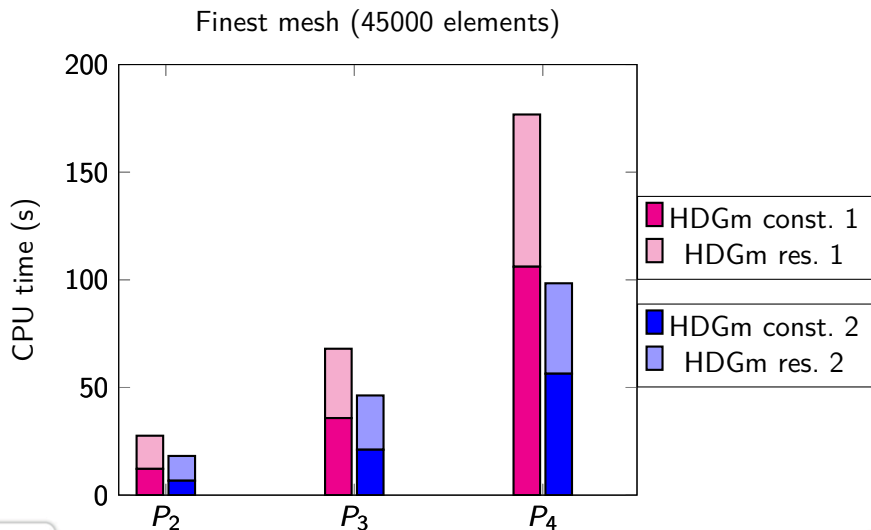

Plane wave : CPU time

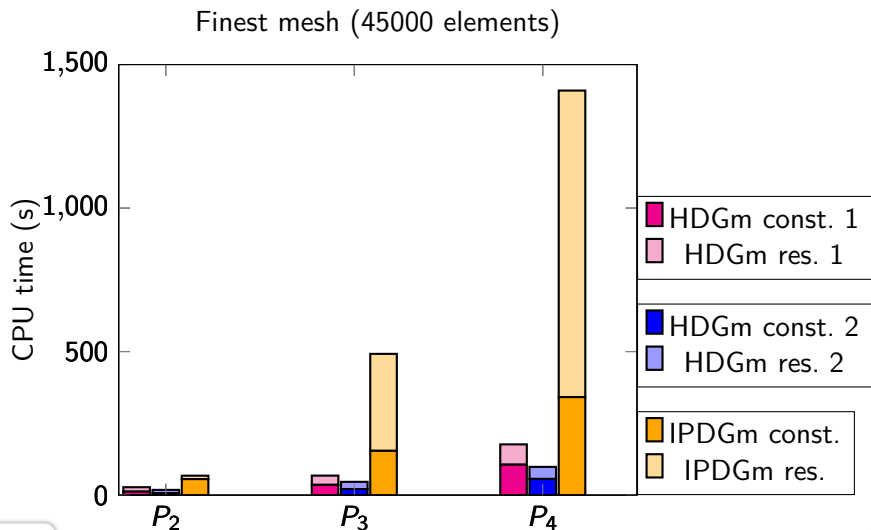

Anisotropic test case

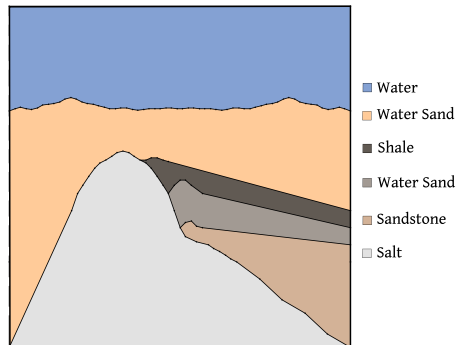

- ▶ Three meshes :
 - ▶ 600 elements
 - ▶ 3000 elements
 - ▶ 28000 elements

Anisotropic case : Memory consumption

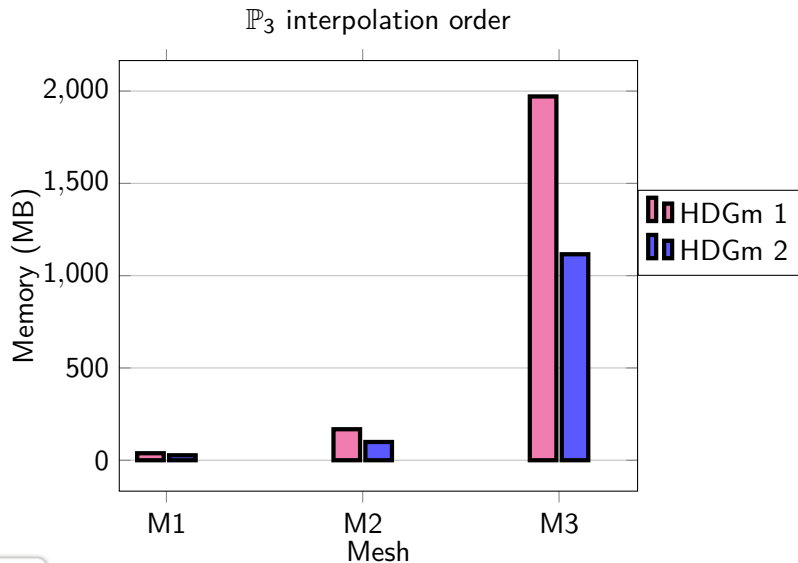

Anisotropic case : Memory consumption

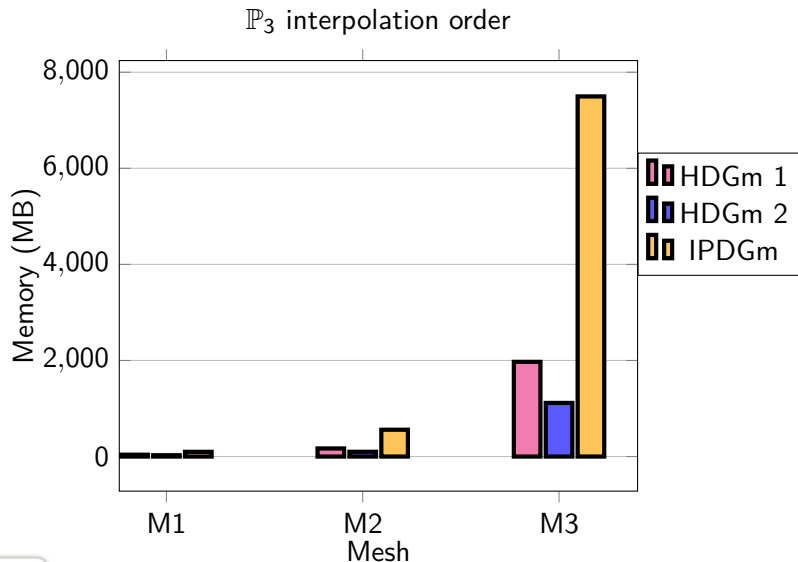

Anisotropic case : CPU time (s)

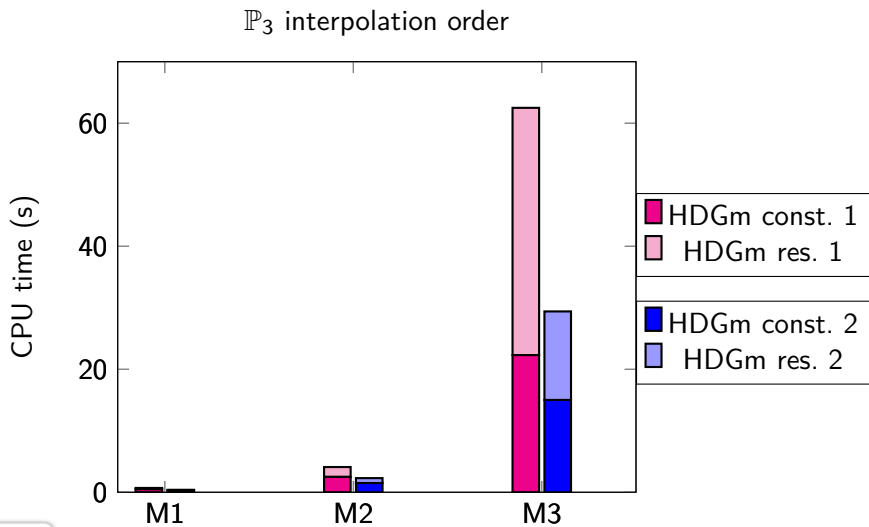

Anisotropic case : CPU time (s)

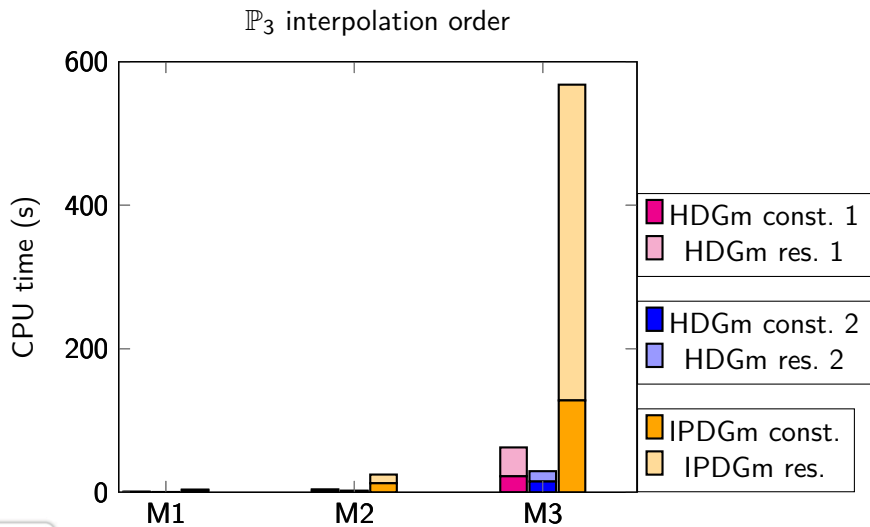

Conclusion

- ▶ HDG method more efficient than classical DG methods for a same accuracy
 - ▶ Memory
 - ▶ Computational time

2D specific study of HDG formulation

- ▶ Anisotropic HDG algorithm without any additional computational cost
- ▶ Computational gain without loss of accuracy using p -adaptivity

Contents

Hybridizable Discontinuous Galerkin method

2D Numerical results : comparison of the two HDG formulations

3D numerical results : focus on the resolution part

3D plane wave in an homogeneous medium

3D geophysic test-case : Epati test-case

Main steps of the HDG algorithm

-
-
1. Construction of the global matrix \mathbf{M}
 2. Construction of the right hand side \mathbf{S}
 3. Resolution $\mathbf{M}\underline{\Lambda} = \mathbf{S}$, with a direct solver (MUMPS) or hybrid solver (MaPhys)
 4. Computation of the solutions of the initial problem
-

Main steps of the HDG algorithm

-
-
1. Construction of the global matrix \mathbf{M}
 2. Construction of the right hand side \mathbf{S}
 3. **Resolution $\mathbf{M}\underline{\Lambda} = \mathbf{S}$, with a direct solver (MUMPS) or hybrid solver (MaPhys)**
 4. Computation of the solutions of the initial problem
-

MaPhys Vs MUMPS

Pattern of the HDG global matrix for \mathbb{P}_1 interpolation and for a 3D mesh composed of 21 000 elements

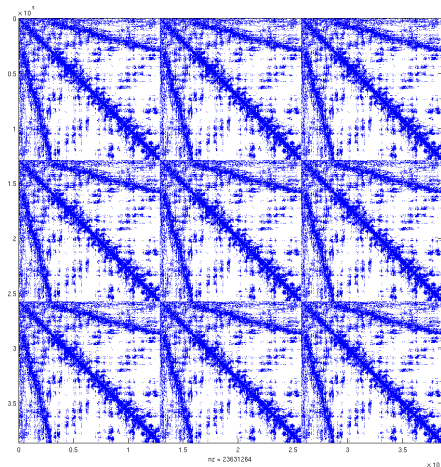

MaPhys Vs MUMPS

Software packages for solving systems of linear equations $Ax = b$, where A is a sparse matrix

- ▶ MUMPS (MULTifrontal Massively Parallel sparse direct Solver) :
 - ▶ Direct factorization $A = LU$ or $A = LDL^T$
 - ▶ Multifrontal approach
- ▶ MaPhys (Massively Parallel Hybrid Solver) :
 - ▶ Direct and iterative methods
 - ▶ non-overlapping algebraic domain decomposition method (Schur complement method)
 - ▶ resolution of each local problem thanks to direct solver such as MUMPS or PaStiX.

3D plane wave in an homogeneous medium

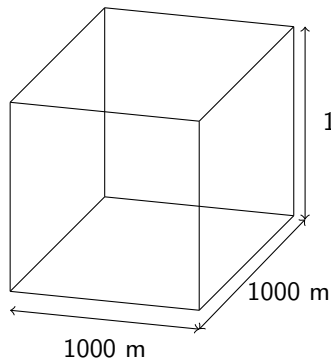

Configuration of the computational domain Ω .

► Physical parameters :

- $\rho = 1 \text{ kg.m}^{-3}$
- $\lambda = 16 \text{ GPa}$
- $\mu = 8 \text{ GPa}$

► Plane wave :

$$u = \nabla e^{i(k_x x + k_y y + k_z z)}$$

where $k_x = \frac{\omega}{v_p} \cos \theta_0 \cos \theta_1$,

$k_y = \frac{\omega}{v_p} \sin \theta_0 \cos \theta_1$, and

$k_z = \frac{\omega}{v_p} \sin \theta_1$

- $\omega = 2\pi f$, $f = 8 \text{ Hz}$
- $\theta_0 = 30^\circ$, $\theta_1 = 0^\circ$
- Mesh composed of 21 000 elements

Cluster configuration

Features of the nodes :

- ▶ 2 Dodeca-core Haswell Intel Xeon E5-2680
- ▶ Frequency : 2,5 GHz
- ▶ RAM : 128 Go
- ▶ Storage : 500 Go
- ▶ Infiniband QDR TrueScale : 40Gb/s
- ▶ Ethernet : 1Gb/s

3D Plane wave : Memory consumption

Maximum local memory for HDG- \mathbb{P}_3 method

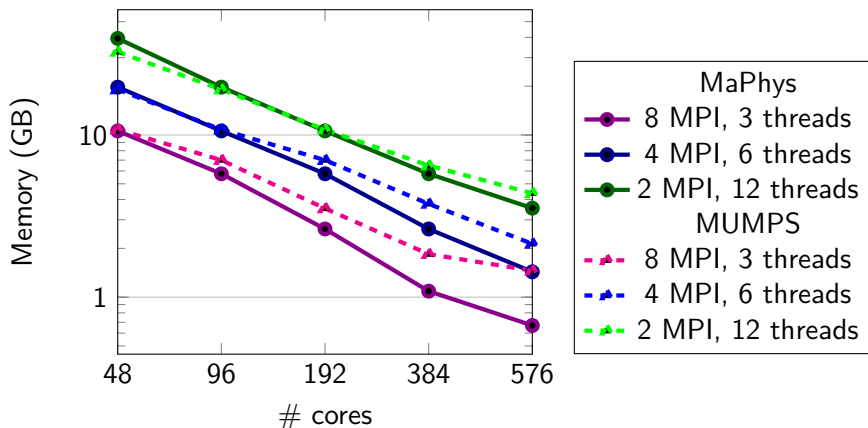

(matrix order = 1 287 360, # nz=298 598 400)

3D Plane wave : Memory consumption

Average memory for one node (8 MPI by node and 3 threads by MPI)

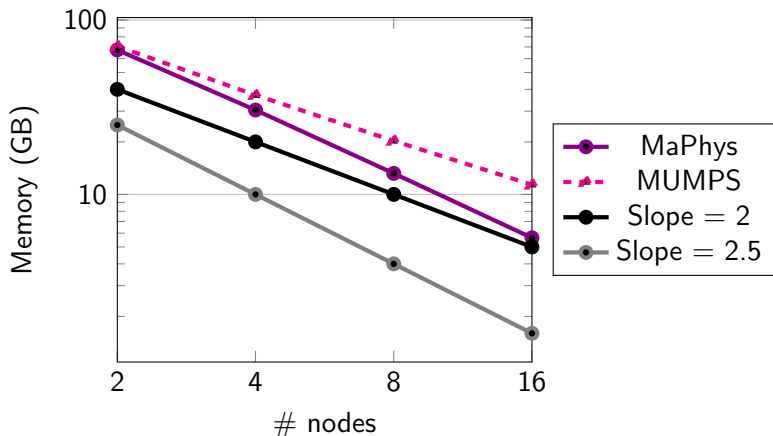

(matrix order = 1 287 360, # nz=298 598 400)

3D Plane wave : Execution time

Execution time for the resolution of the HDG- \mathbb{P}_3 system

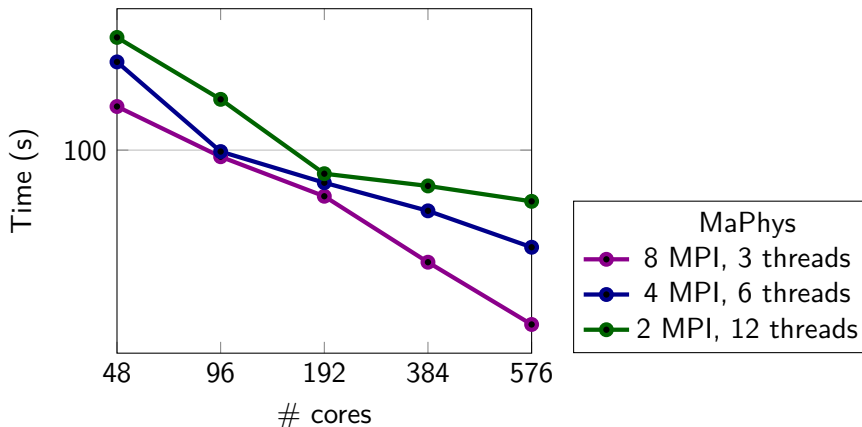

(matrix order = 1 287 360, # nz=298 598 400)

3D Plane wave : Execution time

Execution time for the resolution of the HDG- \mathbb{P}_3 system

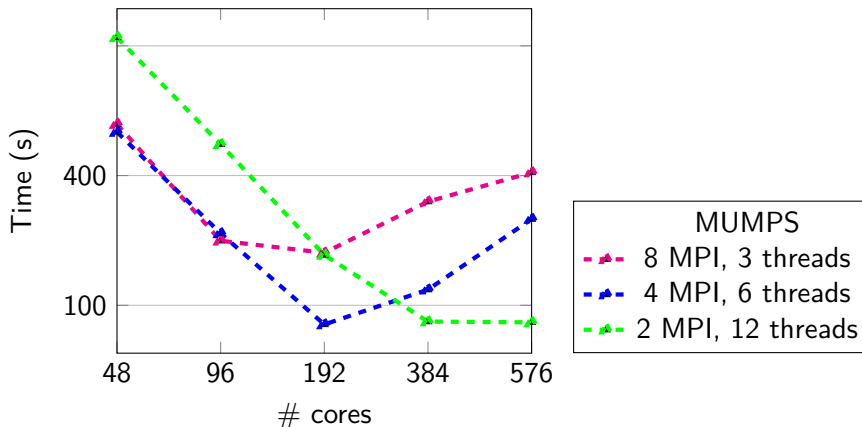

(matrix order = 1 287 360, # nz=298 598 400)

3D Plane wave : Execution time

Execution time for the resolution of the HDG- \mathbb{P}_3 system

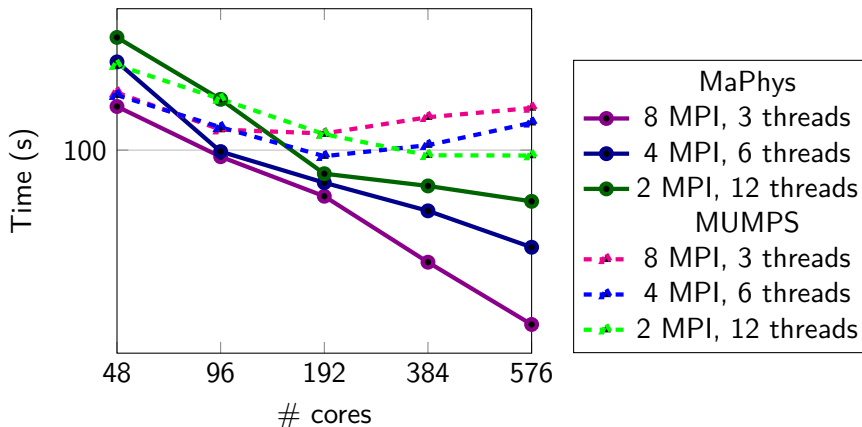

(matrix order = 1 287 360, # nz=298 598 400)

Epati test-case

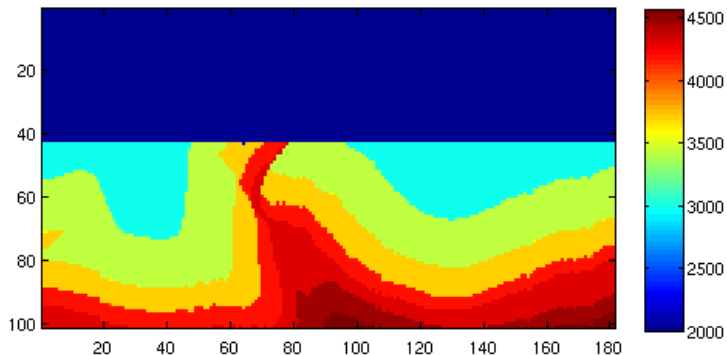

V_p -velocity model ($\text{m}\cdot\text{s}^{-1}$), vertical section at $y = 700$ m

Mesh composed of 25 000 tetrahedrons

Epati test-case : Memory consumption

Maximum local memory for HDG- \mathbb{P}_3 method

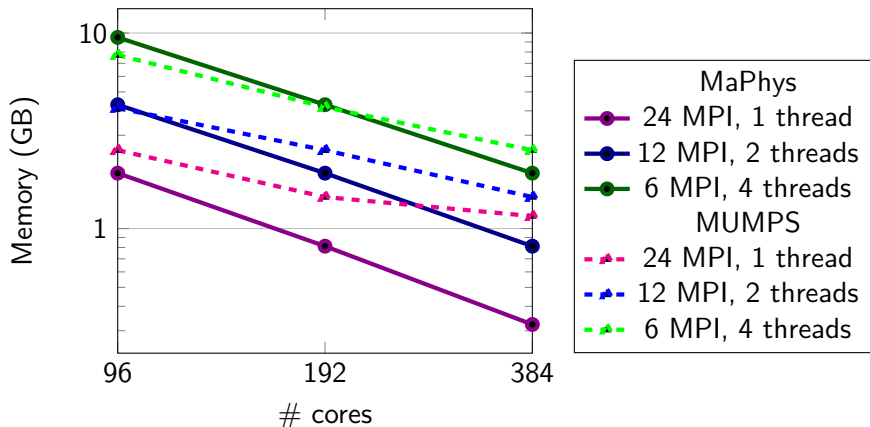

(matrix order = 1 600 740, # nz=365 385 600)

Epati test-case : Memory consumption

Average memory for one node (24 MPI by node and 1 thread by MPI)

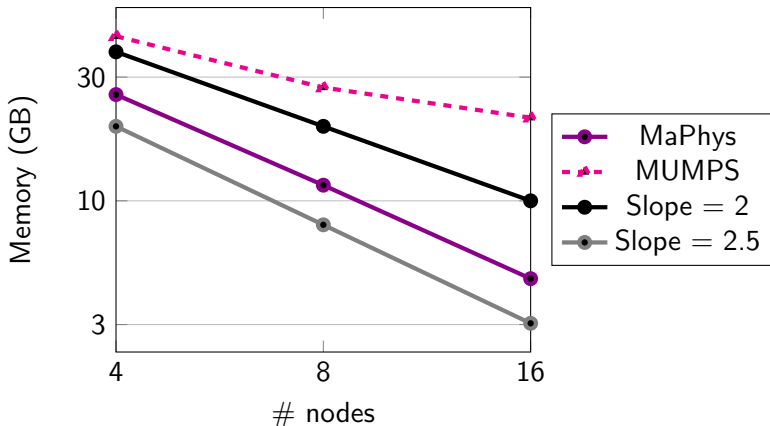

(matrix order = 1 287 360, # nz=365 385 600)

Epati test-case : Execution time

Execution time for the resolution of the HDG- \mathbb{P}_3 system

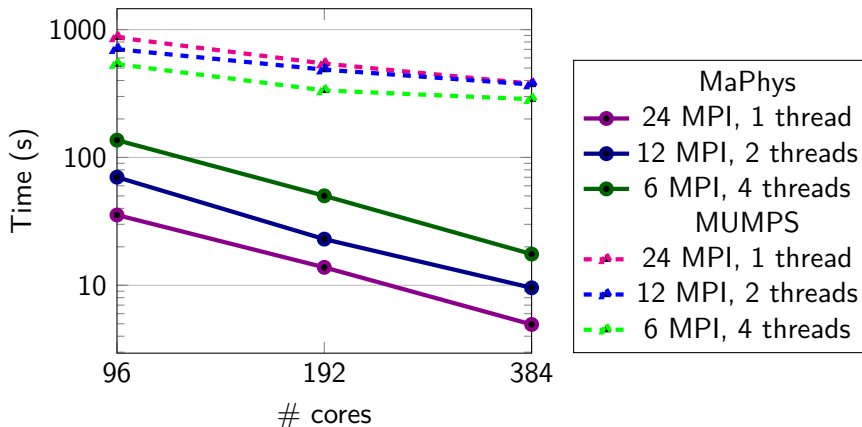

(matrix order = 1 287 360, # nz=365 385 600)

Conclusion-Perspectives

- ▶ more detailed analysis of the comparison between MUMPS and MaPhys
 - ▶ comparison for the symmetric HDG formulation
- ▶ comparison to PaStiX solver
- ▶ extension to elasto-acoustic case
- ▶ study of the stabilization parameter τ for the 3D case
- ▶ call for projects PRACE to test bigger test-cases

Thank you !

The logo for Inria, featuring the word "inria" in a stylized, cursive font with a color gradient from red to orange. Above the "ria" part, the words "informatiques" and "mathématiques" are written in a smaller, black, sans-serif font, separated by a small red asterisk.

inria
informatiques mathématiques