



HAL
open science

Inria@SiliconValley Activity Report 2011-2014

Valérie Issarny, Tania Castro, Helene Kirchner, Christine Morin

► **To cite this version:**

Valérie Issarny, Tania Castro, Helene Kirchner, Christine Morin. Inria@SiliconValley Activity Report 2011-2014. [0] Inria. 2015, pp.1-44. hal-01199428

HAL Id: hal-01199428

<https://inria.hal.science/hal-01199428v1>

Submitted on 15 Sep 2015

HAL is a multi-disciplinary open access archive for the deposit and dissemination of scientific research documents, whether they are published or not. The documents may come from teaching and research institutions in France or abroad, or from public or private research centers.

L'archive ouverte pluridisciplinaire **HAL**, est destinée au dépôt et à la diffusion de documents scientifiques de niveau recherche, publiés ou non, émanant des établissements d'enseignement et de recherche français ou étrangers, des laboratoires publics ou privés.



Inria@SiliconValley

ACTIVITY REPORT

2011-2014





CONTENTS

Inria@SiliconValley part of Inria's International Strategy	5
Inria's international strategy.....	6
Inria@SiliconValley	6
Inria@SiliconValley Research Partners	7
Collaboration framework with CITRIS.....	7
Research collaborations with California universities and laboratories	7
Inria@SiliconValley Associate Teams	8
New computation & data analysis approaches	8
Computing and communication for the future Internet.....	9
Content and supporting learning technologies.....	9
Inria@SiliconValley Grantees & Trainees	10
Inria international chairs.....	10
Inria visiting scientists	11
Inria postdoctoral grantees	11
Inria internships	11
Inria@SiliconValley Awardees	11
France-Berkeley Fund.....	11
France-Stanford Center for Interdisciplinary Studies.....	12
The Bis Annual Event for Research Exchange	12
Focus on Smart City and Mobility	13
Future trends in urban mobility.....	13
Urbancivics: democratizing urban data	13
Appcivist: engaging citizens.....	13
Focus on Innovation	14
Partnership with "French-American hub for innovative entrepreneurs".....	14
Partnership with CITRIS and PRIME on smart cities research & open innovation.....	14
Inria@SiliconValley in 2020	15
Developing collaborations with California at large	15
From Associate Teams to joint research & innovation projects.....	15
Inria@SiliconValley and the open innovation landscape.....	15
Inria@SiliconValley in Few Dates	16

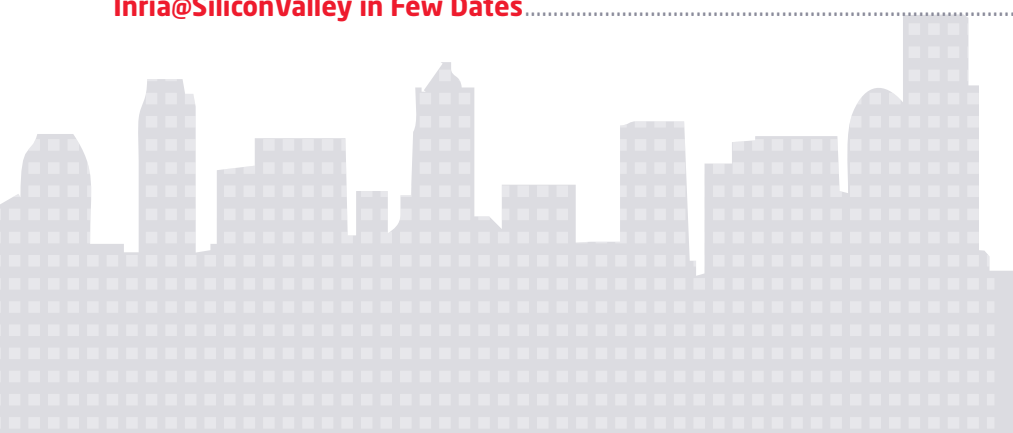

Inria@SiliconValley Associate Teams 2011-2014	18
AQUARIUS	19
BIGDATANET	20
CAPNEONATES	21
CARDIO	22
CLOUSHARE	23
CLOUDY.....	24
COALA	25
COMET	26
COMFORT	27
COMMUNITY	28
CRIPS.....	29
DALHIS.....	30
FASTLA	31
HYPERION	32
IT-SG-WN	33
ITSNAP.....	34
OAKSAD.....	35
ORESTE.....	36
RIPPES	37
SIRIUS	38
SNOWFLAKE	39
SPLENDID	40
STATWEB.....	41





Created in 2011, *Inria@SiliconValley* promotes Inria-California research collaborations in informatics and mathematics to address scientific, economic and societal challenges on international priorities.

 Know more about Inria@SiliconValley at <https://project.inria.fr/siliconvalley/>

Inria@SiliconValley part of Inria's International Strategy

Inria, the French national institute for research in informatics and mathematics, operating under the joint authority of the Ministries of Research and of Industry, is dedicated to produce outstanding research in the computing and mathematical fields of digital sciences, and to ensure the impact of its research on the economy and society.

Inria has a **workforce of 4 400 people**, 3 400 of whom are scientists from Inria or from Inria's partner organizations such as CNRS (the French National Center for Scientific Research), universities and leading engineering schools.

As its strategy closely combines **scientific excellence with technology transfer**, Inria develops collaborations with the economic world through strategic industrial partnerships, including joint laboratories with industry, such as with Microsoft Research and with Alcatel-Lucent. **120 companies have stemmed from Inria since 1984.**

Inria also significantly contributes to the development of the **European Research Area** through its participation to European programs in information and communication technologies and by hosting European Research Council grantees and Marie Skłodowska-Curie fellows.

 Know more about Inria at <http://www.inria.fr/en/>



☉ Inria's International Strategy

To strengthen its impact, Inria seeks to **join forces with the best partners at the International level.**

The **Inria International Labs**, based mainly on joint research projects including **Associate Teams**, joint assessment and co-funding, are a key tool in strengthening Inria's presence and visibility internationally. They are also a key factor in achieving scientific breakthrough and jointly addressing shared research topics by leveraging on the complementary characteristics of partners and exchange of ideas, in a context that promotes inter-connected relations. Inria International Labs include: LIAMA in **China**, LIRIMA in **Africa**, Joint Laboratory on Extreme-Scale Computing in the **USA**, Inria Chile in **Chile** and more recently EPFL-Inria in **Switzerland**.

Inria@SiliconValley aims to make the transition to an organizational structure similar to the Inria international Labs.

Whenever possible, **Inria join forces with French and European partners** to accentuate the institute's alliance, visibility and attractiveness policy.

To step up **international exchanges of students and researchers**, Inria further implements a number of mobility programs: International chairs, sabbatical stays, exploratory visits, exchanges of interns, PhD students, post-doctoral researchers and guest researchers.

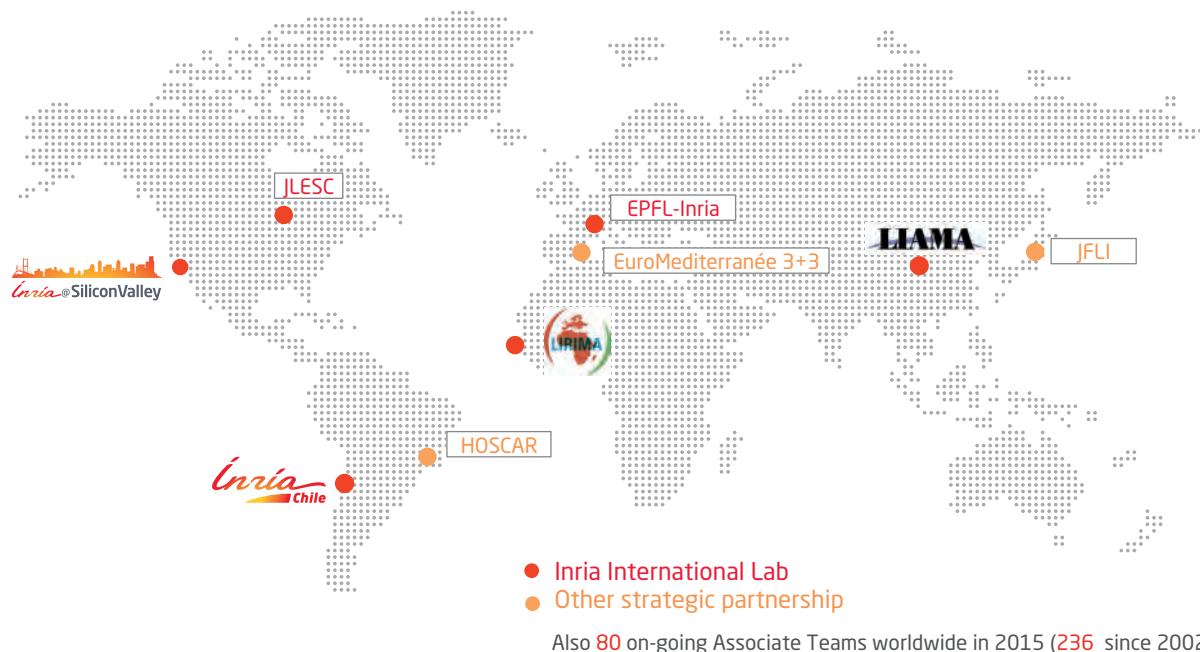

☉ Inria@SiliconValley

Inria@SiliconValley builds research and innovation partnerships in California, with the aim to carry out joint projects with a transatlantic impact. The program was initiated in 2011 based on Inria collaborations with University of California at Berkeley and Stanford University and has since been expanding.

The program leverages the Inria International mobility and **Associate Team** programs, resulting among others in 23 joint scientific projects plus 4 new ones starting in 2015.

The report proposes a walk through the various activities and outcomes of Inria@SiliconValley over its first 4 years, and also an introduction to the plan for the next four years.



Inria@SiliconValley Research Partners

Partnerships with California Universities and Researcher Centers are a central element of Inria@SiliconValley.

Collaboration Framework with CITRIS



The Center for Information Technology Research in the Interest of Society - CITRIS -

"was formed in 2001, when researchers within the UC system realized that the real opportunities lay not just in developing new and innovative technologies, but in applying them. CITRIS was established to address the most pressing social and environmental issues facing California. To meet this goal, CITRIS focuses its research on four core initiatives: Energy, Health Care, Intelligent Infrastructure, and Data and Democracy."

Thanks to shared objectives and similar organization, Inria and CITRIS engaged in a collaboration framework since 2011 to jointly contribute to the advancement of knowledge and the development of technology. This has in particular led to fruitful collaborations around smart city and mobility systems built upon citizen engagement.

 Know more about CITRIS at <http://citris-uc.org/>

Research Collaborations with California Universities and Laboratories



Inria@SiliconValley builds upon long-lasting collaborations between Inria researchers and researchers from **University of California at Berkeley** and **Stanford University**.

Past and ongoing research undertaken within *Inria@SiliconValley* now involve collaborations with further Universities and their affiliated Laboratories across California: **University of California Irvine, University of California San Diego, University of California Santa Cruz, University of California Santa Barbara, University of Southern California, CalTech** and **Lawrence Berkeley National Laboratory**.

The Inria **Associate Team** program allows reinforcing and structuring existing collaborations with research teams as well as developing new ones, by defining a joint research work plan for a period of 3 years.

Since the creation of *Inria@SiliconValley*, **23 Associate Teams** were launched, addressing **3 main thematic areas**:

- **New Computation & Data Analysis Approaches**
- **Computing and Communication for the Future Internet**
- **Content and Supporting Learning Technologies**

In 2015, **4 additional teams** are launched.

The following tables list the research topics being investigated while the **Teams' research objectives and achievements** are outlined in the dedicated section at the end of the report.

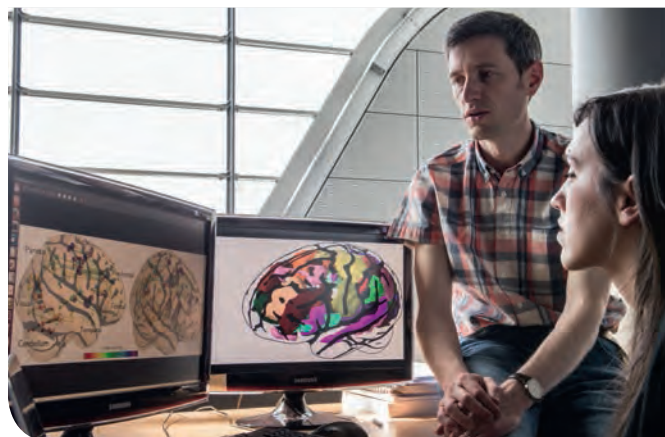

PARIETAL research team involved in Associate Team CAPNEONATES

Know more about *Inria@SiliconValley Associate Teams* at <https://project.inria.fr/siliconvalley/research-teams/>

⦿ New Computation & Data Analysis Approaches

Associate Team	Research Focus	Partners	Principal Investigators	Dates
AQUARIUS	Advanced methods for uncertainty quantification applied to CFD problems	Stanford	P. Congedo & G. Iaccarino	Since 2011
CARDIO	Physiological flow modeling in complex and moving geometries	Stanford	I. Vignon-Clementel & C. Taylor	2008-2013
COALA	Communication optimal algorithms for linear algebra	UC Berkeley	L. Grigori & J. Demmel	Since 2010
COMFORT	Control and forecasting in transportation networks	UC Berkeley	C. Canudas de Wit & R. Horowitz	Since 2014
FASTLA	Fast and scalable hierarchical algorithms for computational linear algebra	Stanford & LBNL	O. Coulaud, E. Darve, & E. Ng	Since 2012
ITSNAP	Intelligent techniques for structures of nucleic acids and proteins	Stanford	J. Bernauer, M. Levitt, & H. van den Bedem	2009-2014
ORESTE	Optimal reroute strategies for traffic management	UC Berkeley	P. Goatin & A. Bayen	Since 2012



⦿ Computing and Communication for the Future Internet

Associate Team	Research Focus	Partner	Principal Investigators	Dates
BIGDATANET	A hybrid P2P/cloud for big data	UC Santa Barbara	P. Valduriez & D. Agrawal	Since 2013
CLOUDSHARE	Cloud computing over Internet volunteer resources	UC Berkeley	A. Legrand & D. Anderson	2009-2014
CLOUDY	Secure and private distributed storage and publication in the future Internet	UC Berkeley & UC Irvine	C. Castellucia, D. Song, & G. Tsudik	2012-2014
COMMUNITY	Message delivery in heterogeneous networks	UC Santa Cruz	T. Turletti & K. Obraczka	2009-2014
DALHIS	Data analysis on large-scale heterogeneous infrastructures for science	LBNL	C. Morin & D. Agarwal	Since 2013
IT-SG-WN	Wireless networks and information theory	UC Berkeley	F. Baccelli & V. Anantharam	2011-2013
RIPPES	Rigorous programming of predictable embedded systems	UC Berkeley	A. Girault & E. Lee	Since 2013

⦿ Content and Supporting Learning Technologies

Associate Team	Research Focus	Partner	Principal Investigators	Dates
CAPNEONATES	Analysis of structural MR and DTI in neonates	USC	P. Fillard, B. Thirion & C. Brun	2011-2013
COMET	Computational methods for the analysis of high-dimensional data	Stanford & Ohio-State U.	S. Oudot, L. Guibas, & Y. Wang	2011-2013
CRISP	Creating and rendering images based on the study of perception	UC Berkeley	A. Bousseau, & M. Agrawala	Since 2011
HYPERION	Large-scale statistical learning for visual recognition	UC Berkeley	Z. Harchaoui, C. Schmid, N. El Karoui, & M. Jitendra	2012-2014
OAKSAD	Languages and techniques for efficient large-scale Web data management	UC San Diego	I. Manolescu & A. Deutsch	Since 2013
SIRIUS	Situated interaction	Stanford & UC Berkeley	W. Mackay, S. Klemmer, & B. Hartmann	2011-2013
SNOWFLAKE	Knowledge discovery from linked data and clinical notes	Stanford	A. Coulet & N. Shah	Since 2014
SPLENDID	Self-paced learning for exploiting noisy, diverse or incomplete data	Stanford	N. Paragios & D. Koller	2012-2014
STATWEB	Fast statistical analysis of web data via sparse learning	UC Berkeley	F. Bach & L. El Ghaoui	2011-2013



The **Inria mobility programs** strengthen research collaborations within Inria@SiliconValley, enabling the exchange of researchers and students between the involved teams.

 Know more about the Inria@SiliconValley visiting scholars at <https://project.inria.fr/siliconvalley/visiting-scholars/>

🕒 Inria International Chairs

Since the creation of the Inria International Chairs program in 2013, 4 positions have been awarded to Professors and senior researchers of California universities and laboratories.

Prof. John Canny, University of California, Berkeley:
Active robotic agents for preschool learning.
2013-2017.

The project explores the use of robotic agents for interaction and learning with children. The project builds upon prior work of Prof. Canny on: speech interfaces, affect (emotion) inference from speech, language learning games and animated agents. The Inria international chair within the WILLOW team at Inria Paris will further allow radical advances in this interdisciplinary effort, at the frontier between HCI, robotics, and social studies. In particular, the vision expertise of the group will enrich the developed interfaces so as to interact more intelligently with children. Both groups are working together on the integration of vision and natural language to facilitate naturalistic interaction with children in language games.

Prof. Victor Vianu, University of California, San Diego: Data-driven collaborative workflows.
2013-2017.

Data-driven workflows have become ubiquitous in a variety of application domains. But the existing technology is mostly addressing centralized orchestrated workflows. However, with the Web, distributed applications between autonomous systems are more and more the norm. The goal of this research that is carried out in collaboration with the DAHU team at Inria Saclay, is to extend workflow technology to this new setting, by studying data-driven collaborative workflows. More precisely, the objective is to develop new techniques and tools for designing, analyzing, managing, and optimizing complex data-driven collaborative workflows

Prof. Mathieu Desbrun, CalTech:
Efficient conversion between real, digital, and abstract representations of shapes.
2014-2018.

Nowadays, shape acquisition (through laser scans, aerial imagery, MRI, etc.) and reconstruction allow the creation of digital models from real geometry. Conversely, digital models can be printed out as 3D objects via the increasingly rich variety of manufacturing technologies. The same digital models often require mathematical abstractions if high-level scene understanding and structural analysis are required; abstract models such as a city layout, however, require the addition of geometric details to render them more visually realistic. Studying the efficient conversion between real, digital, and abstract representations of shapes is the focus of this research, in collaboration with the TITANE team at Inria Sophia Antipolis.

Dr. Deborah Agarwal, Lawrence Berkeley National Laboratory and Berkeley Institute for Data Science, University of California, Berkeley:
Workflow: user-centered design, data management and mobile applications for data science.
2015-2019.

Computational and data management tools for scientific data processing, analysis, and collaboration environments are currently hitting several barriers. For example, today's workflow tools are unable to manage the typical large-scale HPC data processing jobs, mechanisms for curation of data are largely non-existent, and mobile applications for entering and verifying data are regularly requested by users but are currently largely unavailable. Dr. Agarwal's research with the MYRIADS team at Inria Rennes will focus on addressing these areas as well as opportunities to rethink and enhance the end-to-end computation and data management infrastructure for science.

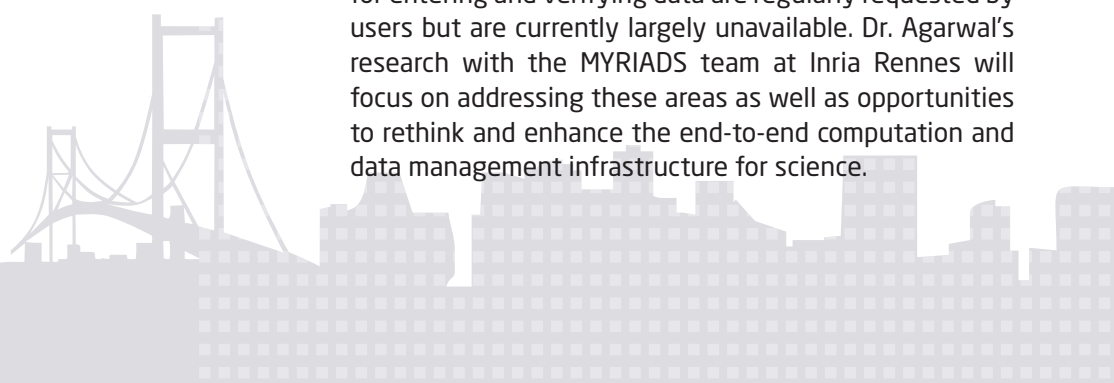

◉ Inria Visiting Scientists

The **Inria Explorer** and **Sabbatical programs** enable Inria scientists to visit California universities and laboratories for short- (up to 3 months) to long-term (longer than 6 months) period, respectively.

Since 2011, **10 Inria scientists** have been visiting scholars at *Inria@SiliconValley* partner universities and institutions.

◉ Inria Postdoctoral Grantees

Inria@SiliconValley postdoctoral grantees contribute to ongoing research collaborations, primarily as part of Associate Teams although not exclusively.

19 Grantees have contributed to the program since its creation.

◉ Inria Internships

Inria welcomes undergraduate as well as graduate students from all over the world for a research training experience. **Trainees** from California universities may be supported by dedicated programs such as the **Chateaubriand Fellowship in Science, Technology,**

Engineering & Mathematics offered by the Embassy of France in the United States (Office for Science and Technology - OST), or the **REUSSI - Research Experience for US Students at Inria** - internship program funded by the **National Science Foundation** and Inria.

Inria@SiliconValley Awardees

Beyond the Inria grants supporting research collaborations and researcher mobility, collaborations between Inria and California researchers have been supported by a number of prestigious grants fostering France-US collaborations.

◉ France Berkeley Fund



Invariant image representations and high dimensional sparse estimation for neurosciences: Prof. Bin Yu, Department of Statistics, University of California, Berkeley and Julien Mairal, Inria Grenoble Rhône Alpes. 2014 Grant.

Optimal traffic flow management with GPS enabled smartphones: Prof. Alexandre Bayen, CITRIS & University of California, Berkeley and Dr. Paola Goatin, Inria Sophia Antipolis Méditerranée. 2012 Grant.

Improving fMRI by using anatomical data to constrain functional models: Prof. Jack L. Gallant, Department of Psychology, University of California, Berkeley and Dr. Bertrand Thirion, Inria Saclay Île de France. 2012 Grant.

Large-scale learning for image and video interpretation: Prof. Jitendra Malik, EECS Department, University of California, Berkeley and Dr. Zaaid Harchaoui & Dr. Cordelia Schmid, Inria Grenoble Rhône Alpes. 2012 Grant.

Scalable hybrid solvers for large sparse linear systems of equations on petascale computing architectures: Dr. Esmond G. Ng, Computational Research Division, Lawrence Berkeley National Laboratory and Dr. Luc Giraud, Inria Bordeaux Sud Ouest. 2010 Grant.

Real-time simulation methods for interactive surgical simulation and planning: Prof. James F. O'Brien, EECS Department, University of California, Berkeley and Prof. Marie-Paule Cani, Inria Grenoble Rhône Alpes. 2010 Grant.

Implementation and extensive performance evaluation of future standards for wireless sensor networks: Prof. Kristofer S. J. Pister, College of Engineering, University of California, Berkeley and Prof. David Simplot-Ryl, Inria Lille Nord Europe. 2010 Grant.

 Know more about France Berkeley Fund at <http://fbf.berkeley.edu>



France-Stanford Center for Interdisciplinary Studies

Toward structurally characterizing protein-RNA interactions with kino-geometric sampling: Dr. Henry van den Bedem, Stanford Synchrotron Radiation Lightsource, SLAC, and Dr Julie Bernauer, Inria Saclay-Île-de-France & Ecole Polytechnique. 2014-15 Collaborative Research Grant.

Statistical geometric model of organ's shapes for computational medicine: Nina Miolane, PhD student in Geometric Statistics, Inria Sophia Antipolis Méditerranée. 2014-15 Visiting Student Researcher Fellowship.

Diagnosis of lower back pain from CT images by combining computational topology: Prof. Susan Holmes, Statistics Department, Stanford University and Dr Xavier Pennec, Inria Sophia Antipolis Méditerranée. 2013-14 Collaborative Research Grant.

The 4th International Conference on Engineering Frontiers in Pediatric and Congenital Heart Disease: Prof. Jeff Feinstein, Stanford School of Medicine and Dr. Irene Vignon-Clementel, Inria Paris-Rocquencourt. 2013-2014 Conference Grant.

 Know more about the France-Stanford Center for Interdisciplinary Studies at <http://francestanford.stanford.edu/>

The **BIS Annual Event** for Research Exchange

*Inria@SiliconValley organizes with its California collaborators and in partnership with **CITRIS** and the **French Ministry of Foreign Affairs**, the annual **BIS - Berkeley-Inria-Stanford - workshop**. BIS gathers from 50 to 80 participants; it takes place in spring and alternatively in France and in California.*

BIS'2011 @ CITRIS kick-started the *Inria@SiliconValley* collaborations leveraging the existing strong ties between Inria and California scientists.

BIS'2012 @ Paris brought together the *Inria@SiliconValley* associate teams as well as opened new grounds for collaborations on the Big Data Science theme.

BIS'2013 @ Stanford gathered the increasing crowd of researchers working together as part of *Inria@SiliconValley*. It was further the occasion to investigate possible joint projects on the smart city theme.

BIS'2014 @ Paris opened participation beyond Inria researchers and their California collaborators, featuring a one-day event on smart cities with talks from city, academia and industry representatives so as to emphasize opportunities for France-California collaborations on the topic.

 Know more about BIS at <https://project.inria.fr/siliconvalley/workshops/>



Poster for BIS'2014 Workshop



Focus on Smart City and Mobility



The smart city vision raises the prospect that cities will become more sustainable environments, ultimately enhancing the citizens' well being. There

is the additional promise of enabling radically new ways of living in, regulating, operating and managing cities, through the increasing active involvement of citizens by ways of crowdsourcing/sensing and social networking.

From the more technical perspective, smart cities are **fascinating, yet challenging systems of systems** for the digital science and technologies due to the key characteristics of connected cities and especially their scale. Moreover, the vision of what smart cities should be about is evolving at a fast pace in close concert with the latest technology trends and especially mobile social

networking, the IoT, open data as well as big data.

Inria with CITRIS and its partners at University of California Berkeley have engaged into research collaboration on smart cities, leveraging their related initiatives in the area among which the **CityLab@Inria Project Lab** - <https://citylab.inria.fr/> - under creation at Inria and the CITRIS core initiatives on **"Data and Democracy"** and **"Intelligent Infrastructure"**.

The overall objective is to develop novel systems to improve urban life and mobility by integrating sensors, social media and citizen engagement. These will ultimately result into solutions that create actionable intelligence for policymakers, entrepreneurs and advocacy organizations.

Collaboration has so far been focused on 3 research themes.

Future Trends in Urban Mobility

Attention is urgently needed in **traffic management** to alleviate the congestion that leads to negative effects on economy and health. Active collaboration on that topic is ongoing as part of the **Associate Teams COMFORT**

and **ORESTE** and in cooperation with ITS - **The Institute of Transportation Studies** - at University of California Berkeley.

UrbanCivics: Democratizing Urban Data

The unprecedented **democratization of urban data** fueled by open data channels, social networks and crowd sourcing enables not only the monitoring of the activities of the city but also the assessment of their nuisances based on their impact on the citizens, thereby prompting social and political actions. However, the comprehensive integration of urban data sources for the purpose of sustainability remains largely unexplored.

UrbanCivics studies urban data systems allowing the collection and further aggregation of heterogeneous urban data sources toward understanding but also

prompting solutions to urban nuisance. In a first attempt, UrbanCivics concentrates on noise pollution that is a major nuisance in our modern cities with health effects becoming a growing concern.

In addition, UrbanCivics brings to citizens the **Sense2Civics Quantified-Self apps**, so that citizens contribute to and get knowledge about urban pollution, including the impact on their health. The first app of the family, **SoundCity**, is to be released in 2015 with a focus on Paris and the San Francisco Bay area.

AppCivist: Engaging Citizens

AppCivist joins forces of CityLab@Inria and the **Social Apps Lab** - <http://citriss.org/initiatives/social-apps-lab/> - at **CITRIS at University of California Berkeley**

AppCivist seeks to build a **middleware platform for democratic assembly and collective action** that lets users (and especially social activists) make their own applications, called **Assemblies**, with modular

components. The components support a wide range of civic engagement practices such as proposal making, deliberation, versioning, voting, alerting, networking, and mapping. When assembled, they help people engage issues and places in their city.



Focus on Innovation

“ 1984: Inria becomes a shareholder in a first company, SIMULOG. It was the start of a history of company creation which is still going strong today! Over the coming months, Inria is turning the spotlight on 30 years of exciting entrepreneurial ventures. It is an opportunity to remind ourselves that the creation of businesses is one of the areas Inria decided to focus on in its search for economic and societal impact. Over 120 spin-offs emerged from work carried out in Inria project teams, and these companies have led to the creation of more than 3,000 jobs. ”

“Inria celebrates 30 years of business creation”

 www.inria.fr/en/content/view/full/84762

30 years OF CREATING START-UPS

Contributing to Innovation in digital technology is a strategic goal for Inria and its worldclass research teams. Through its presence in Silicon Valley, *Inria@SiliconValley* is no exception; it is now an integral part of the local ecosystem thanks to strong partnerships.

◉ Partnership with “French-American Hub for Innovative Entrepreneurs”

The Inria partnership with **PRIME** and the **French Tech Hub**, the **French-American hub for innovative entrepreneurs**, supports and promotes Inria startups network, brings together Inria’s Alumni and fosters collaboration between Inria research teams, startups and American companies through industry meetings.

PRIME & French Tech Hub offer **soft-landing facilities for selected Inria start-ups**.

In September 2014, the **American network of Inria alumni and spinoffs** was officially launched. It now counts more than 50 members and has its dedicated online group.



◉ Partnership with CITRIS and PRIME on Smart Cities Research & Open Innovation

Inria, CITRIS and PRIME signed in February 2014 a **partnership to accelerate the development of ambitious research and experimentation initiatives on urban development**.

The **French Minister for Higher Education and Research** witnessed the signature of this Memorandum of Understanding. Researchers from Inria and CITRIS will expand their existing relationship and leverage PRIME’s network and programs on smart cities to lead this effort. The trio of experts will reach out to public and private organizations to expand the scope and implementation of their projects.



Michel Cosnard (CEO of Inria), Sabine Enjalbert (Director of Paris Region Economic Development Agency), Genevieve Fioraso (French Minister of Higher Education and Research), Costas Spanos (CITRIS Director)



Since its creation in 2011, Inria@SiliconValley has been expanding its research collaborations from the **Bay area to California at large**, and further developing partnerships and joint projects spanning **Research and Innovation**.

◉ Developing Collaborations with California at Large

While *Inria@SiliconValley* initially built upon existing research collaborations between Inria researchers and Professors of University of California Berkeley and Stanford University, it naturally developed collaborations with Universities across California.

Acknowledging the rich research & innovation ecosystem in Southern California, partnerships will be built, in

particular leveraging strong ties with the Viterbi Engineering School of University of Southern California and its associated centers.

The overall objective is to continue acting as a facilitator for the creation of Associate Teams but also Joint Research & Innovation projects across California.

◉ From Associate Teams to Joint Research & Innovation Projects

Associate Teams are the pillars of *Inria@SiliconValley*: each team initiates and further strengthens Inria-California research collaboration toward a common scientific objective. Joint research and innovation projects leverage those initiatives toward larger scale collaboration, with possible additional funding from EU and American sources. The first Joint project of *Inria@SiliconValley* relates to the Smart City and Mobility theme; it is the objective to pursue such initiatives that leverage *Inria@SiliconValley* collaborations and partnerships.

• **Smart City and Mobility:** Early urban-scale experiments of the *Inria@SiliconValley* solutions, which are planned in Paris and the Bay area in 2015, will bring insights about Cities and Citizens engagements. This will then inform follow-up research as well as potential follow-up innovation.

• **Urban Systems and Networking:** Urban systems come along with significant challenges in terms of scale

regarding in particular associated data management and networking. It is our objective to develop a project focused on those issues in partnership with University of Southern California.

• **Computational Health:** Thanks to a number of Associate Teams researching on the Computational Health theme, it is on our agenda to investigate the possible set up of a dedicated Joint Research and Innovation project.

• **Data-intensive Science:** Challenges on understanding climate change, origin of the universe, or energy alternatives need to be addressed jointly by researchers in earth sciences, applied mathematics, and computer science. We plan to federate efforts on big data analytics and high performance computing with the objective to build next-generation scientific data analysis environments.

◉ Inria@SiliconValley and the Open Innovation Landscape

Innovation is a central concern of Inria, next to Scientific Excellence. *Inria@SiliconValley* has been developing dedicated partnerships to assist its researchers in developing innovation in relation with the Bay area

ecosystem. The effort will continue, while considering California at large.



Inria@SiliconValley in Few Dates

NOVEMBER

CITRIS-Inria Memorandum of Understanding (MoU) on a research collaboration framework.

JANUARY



Launch of *Inria@SiliconValley* with Dr Malik Ghalab as scientific coordinator, building upon the existing Associate Teams: **CARDIO**, **CLOUSHARE**, **COALA**, **COMMUNITY**, and **ITSNAP**.

Creation of the *Inria@SiliconValley* Associate Teams: **AQUARIUS**, **CAPNEONATES**, **COMET**, **CRISP**, **IT-SG-WN**, **SIRIUS**, and **STATWEB**.

JANUARY

Creation of the *Inria@SiliconValley* Associate Teams: **FASTLA**, **CLOUDY**, **HYPERION**, **ORESTE**, and **SPLENDID**.

MAY

2nd edition of **BIS** in Paris, which is co-organized by University of California Berkeley, Inria, and Stanford University, in partnership with CITRIS and the French Ministry of Foreign Affairs.

2010

2011

2012

MAY

1st edition of the annual **BIS** workshop jointly organized by CITRIS and Inria, and held at CITRIS headquarters on the University of California Berkeley campus.

SEPTEMBER



Dr Christine Morin takes over the role of *Inria@SiliconValley* scientific coordinator.

5 postdoctoral grantees join *Inria@SiliconValley*.

SEPTEMBER

Paris-San Francisco MoU renewing the sister city relationship and including the willingness to work together and with other partners to develop innovative programs of research and development with, among others, the shared goal of being global leaders in the creation of smart and sustainable cities.

5 postdoctoral grantees join *Inria@SiliconValley*.



JANUARY

Creation of the *Inria@SiliconValley* Associate Teams: BIGDATANET, DALHIS, OAKSAD, and RIPPES.

Prof John Canny, University of California Berkeley, and Prof Victor Vianu, University of California San Diego are awarded Inria International Chair grants to work respectively with the Inria WILLOW and DAHU teams.

Addendum to the CITRIS-Inria Memorandum of Understanding to support the city of Paris and the city of San Francisco in carrying out research and innovation projects toward smart and sustainable cities.

JANUARY

Creation of the *Inria@SiliconValley* Associate Teams: COMFORT and SNOWFLAKE.

Prof Mathieu Desbrun, CalTech, is awarded an Inria International Chair grant to work with the Inria TITANE team.

FEBRUARY



CITRIS-Inria-PRIME MoU establishing a framework for collaboration to accelerate the roll out of ambitious research and experimentation initiatives on issues relating to major urban centers, signed in the presence of Mrs. Genevieve Fioraso, French Minister for Higher Education and Research.

2013

2014

MAY

3rd edition of BIS, held on the campus of Stanford University.

SEPTEMBER



Dr. Valerie Issarny takes over the role of *Inria@SiliconValley* scientific coordinator.

6 postdoctoral grantees join *Inria@SiliconValley*.

MAY

4th edition of BIS, held at the CNAM engineering school, Paris, France.

SEPTEMBER

3 postdoctoral grantees join *Inria@SiliconValley*.

JULY

Signature of an Inria partnership with PRIME joined by the French Tech Hub - The French-American hub for innovative entrepreneurs – to support and promote Inria startups' network, bring together Inria's Alumni and organize an Inria-Industry meeting featuring Inria research teams and startups.



Inria@SiliconValley Associate Teams 2011-2014

- AQUARIUS:** Numerical methods for uncertainty quantification applied to CFD problem
- BIGDATANET:** A hybrid P2P/cloud for big data
- CAPNEONATES:** Analysis of structural MR and DTI in neonates
- CARDIO:** Physiological flow modeling in complex and moving geometries
- CLOUSHARE:** Cloud computing over Internet volunteer resources
- CLOUDY:** Secure and private distributed storage and publication in the future Internet
- COALA:** Communication optimal algorithms for linear algebra
- COMET:** Computational methods for the analysis of high-dimensional data
- COMFORT:** Control and forecasting in transportation networks
- COMMUNITY:** Message delivery in heterogeneous networks
- CRISP:** Creating and rendering images based on the study of perception
- DALHIS:** Data analysis on large-scale heterogeneous infrastructures for science
- FASTLA:** Fast and scalable hierarchical algorithms for computational linear algebra
- HYPERION:** Large-scale statistical learning for visual recognition
- IT-SG-WN:** Wireless networks and information theory
- ITSNAP:** Intelligent techniques for structures of nucleic acids and proteins
- OAKSAD:** Languages and techniques for efficient large-scale Web data management
- ORESTE:** Optimal reroute strategies for traffic management
- RIPPES:** Rigorous programming of predictable embedded systems
- SIRIUS:** Situated Interaction
- SNOWFLAKE:** Knowledge discovery from linked data and clinical notes
- SPLENDID:** Self-paced learning for exploiting noisy, diverse or incomplete data
- STATWEB:** Fast statistical analysis of web data via sparse learning





AQUARIUS (SINCE 2011)

Numerical methods for uncertainty quantification applied to CFD problem

PRINCIPAL INVESTIGATORS

- Dr. Pietro Marco Congedo, CARDAMOM project-team, Inria Bordeaux Sud-Ouest
- Prof. Gianluca Iaccarino, Stanford University

RESEARCH OBJECTIVES

AQUARIUS deals with the development of uncertainty quantification methods and its application to Computational Fluid Dynamics problems.

It involves the Inria team CARDAMOM (P.M. Congedo) and the Department of Mechanical Engineering at Stanford University (Prof. G. Iaccarino).

SCIENTIFIC ACHIEVEMENTS

AQUARIUS has been investigating various topics since 2011, mostly focused on its main research axes:

- **Uncertainty quantification:** The team has proposed a formulation dealing with a semi-intrusive (SI) method allowing the computation of statistics of linear and non linear Partial Differential Equations (PDEs) solutions.
- **Robust design optimization:** Two efficient global strategies for robust optimization have been developed. The first one is based on the extension of simplex stochastic collocation to the optimization space, while the second one consists in a hybrid strategy using ANOVA decomposition and high-order statistical moments.

PUBLICATIONS AND AWARDS

- 10 Journal articles, 9 Book chapters, 13 Conference papers, 13 Invited seminars.

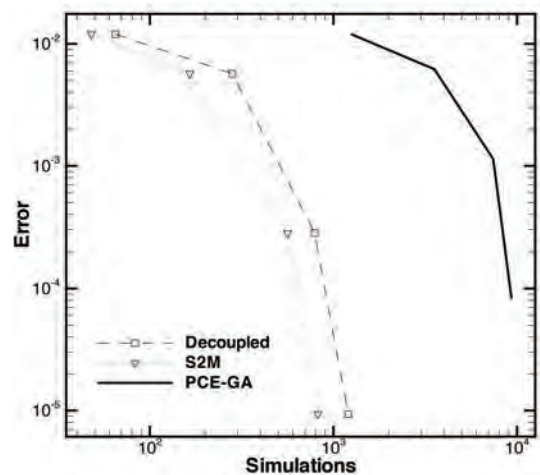

Convergence rates of the S2M method with respect to other classical techniques for robust design optimization (short column test function)

- Organization of the international workshop BOQUSE 2013 (December, Bordeaux), of the von Karman Institute (VKI) Lecture Series (Brussels), of Minisymposia at ECCOMAS 2014 and EUROGEN 2011-2013, of the Center for Turbulence Research (CTR) Summer Program (Stanford University).

SELECTED PUBLICATION

P.M. Congedo, J. Witteveen, G. Iaccarino, 2013, A simplex-based numerical framework for simple and efficient robust design optimization. *Computational Optimization and Application*, 56 (1), pp. 231-251.

FOLLOW-UP

The team was renewed for 3 years in 2014 and is pursuing its collaboration along the 2 aforementioned research axes.



BIGDATANET (SINCE 2013)

A hybrid P2P/cloud for big data

PRINCIPAL INVESTIGATORS

- Dr. Patrick Valduriez, ZENITH project-team, Inria Sophia Antipolis Méditerranée
- Prof. Divyakant Agrawal, University of California Santa Barbara

RESEARCH OBJECTIVES

With the advent of the Internet and the World-wide-web, there is an emergent need to develop user applications that access data and resources stored in the network. In order to facilitate the development of network-centric applications, new computational paradigms are needed that are scalable, elastic, available, and fault-tolerant. During the past decades two dominant paradigms referred to as Peer-to-Peer (P2P) Computing and Cloud Computing have become widely prevalent as computational paradigms for distributed applications. The two paradigms in many ways are complementary and provide different trade-offs. For instance, the cost for computing and storage is almost free in P2P but it suffers from the challenges of churn and low reliability of user machines. Cloud computing, on the other hand significantly simplifies the task of system administration in the data-center but requires a very large investment in building large-scale datacenters.

BIGDATANET plans to develop a hybrid platform that combines the two paradigms and leverages computing, storage, and network resources both in the data-centers (i.e., the cloud) as well as at the edges of the network (i.e., the peer or user machines). The team thus explores the suitability of this hybrid model for big-data applications such as scientific applications, social networks, and massive data analytics. The research challenges that need to be addressed are the massive scale of both systems and data, complexity of the overall architecture, and heterogeneity of the overlay network.

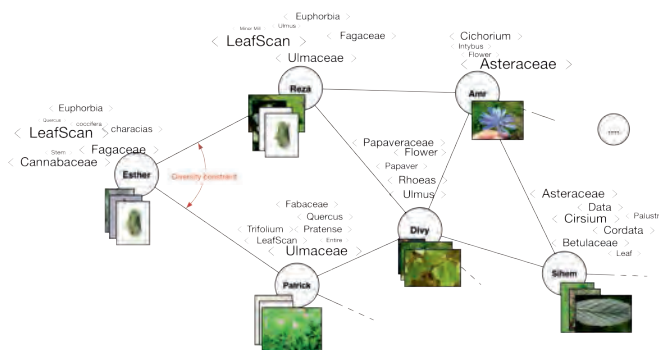

SCIENTIFIC ACHIEVEMENTS

Contributions relate to: P2P/cloud architecture, decentralized recommendation for big data sharing, scalable query processing with big data, and privacy-preserving database outsourcing.

PUBLICATIONS AND AWARDS

- 3 Journal articles & 7 Conference papers.

SELECTED PUBLICATIONS

M. Liroz-Gistau, R. Akbarinia, D. Agrawal, E. Pacitti, P. Valduriez. Data Partitioning for Minimizing Transferred Data in MapReduce. GLOBE 2013, p. 1-12.





CAPNEONATES (2011-2013)

Analysis of structural MR and DTI in neonates

PRINCIPAL INVESTIGATORS

- Pierre Fillard and Bertrand Thirion, PARIETAL project-team, Inria Saclay Ile de France
- Natasha Lepore, University of Southern California and Children's hospital of Los Angeles

RESEARCH OBJECTIVES

Prematurity induced neurological problems are rapidly becoming one of the leading public health issues of this century. CAPNEONATES aimed to determine group differences in brain anatomy between normal newborns and premature babies at term equivalent age using MRI. The team's goal was to develop a set of image processing and statistical analysis tools for the modeling and analysis of structural MR and DTI in neonates, and to compare he considered premature and control groups.

SCIENTIFIC ACHIEVEMENTS

- The team designed a new tractography method to analyze term born and premature neonates.
- This method was adapted to perform reproducible tractography in rats using high spatial resolution at 7T.
- The team benchmarked some statistical analysis tools to enhance the detection of differences across populations.

PUBLICATIONS AND AWARDS

- 1 Journal article & 3 Conference papers.

SELECTED PUBLICATION

N Lepore and F Yepes, Y Lao, A Panigrahy, R Ceschin, S Ravichandran, MD Nelson, P Fillard, Template-Based Tractography for Clinical Neonatal Diffusion Imaging Data, SPIE Medical Imaging, San Diego, California, USA, February 4-9 (2012).

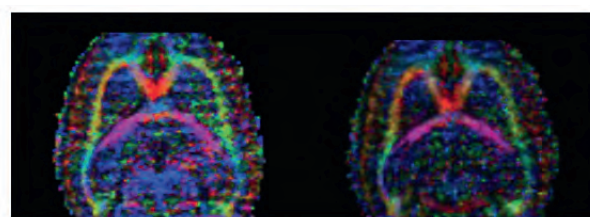

(a) MoD at $0.2mm^3$

(b) Averaged subject at $0.2mm^3$

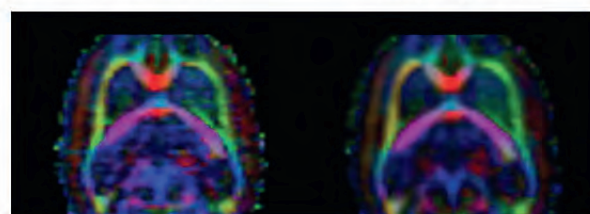

(c) MoD at $0.3mm^3$

(d) Averaged subject at $0.3mm^3$

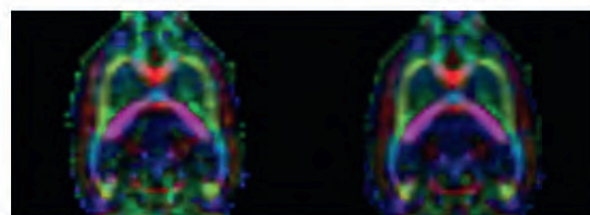

(e) MoD at $0.4mm^3$

(f) Averaged subject at $0.4mm^3$

Improvement in FA color maps from the team method, axial view of one slice. Rows from top to bottom: resolutions of $0.2mm^3$, $0.3mm^3$, $0.4mm^3$. Left column: original acquisitions with the best CNR in each of the resolutions. Right column: average subject with improved CNR.

FOLLOW-UP

CAPNEONATES generated other project ideas. In particular, the team has been working on a new machine learning method for the detection of Alzheimer's disease in the clinic, which relies on the selection of discriminative features and a multivariate classification machine. The selection of a sparse set of features is particularly important to ease the clinical interpretation of the discriminative model. This development has been made relatively easy through the scikit learn library, contributed by PARIETAL.



CARDIO (2008-2013)

Physiological flow modeling in complex and moving geometries

PRINCIPAL INVESTIGATORS

- Dr. Irene Vignon-Clementel, REO project-team, Inria Paris-Rocquencourt
- Dr. Charles Taylor, Stanford University & Heartflow

RESEARCH OBJECTIVES

The REO project-team of Inria and the Cardiovascular Biomechanics Research laboratory (CVBRL) have both developed numerical methods geared towards cardiovascular applications. They further share similar goals and both interact with the medical and industrial communities, yet approaches and developed methodologies are complementary.

SCIENTIFIC ACHIEVEMENTS

CARDIO worked on the challenges of bringing together medical data and numerical simulations of blood and air flow:

- Clinically based geometry & boundary conditions: for the fluid - air and flow - the rest of the system not modeled in the detailed 3D part is taken into account, and for the vessel wall taking into the surrounding tissue viscoelastic effects.
- 3 applications were specifically studied: single ventricle repair (congenital heart disease), aorta in healthy and disease states, emphysema (respiratory disease).

PUBLICATIONS AND AWARDS

- 6 PhD theses.
- 15 Journal articles.
- Software advances.
- Leducq funded transatlantic network of excellence.
- 2 student prizes and 2 student fellowships.
- ERC Starting Grant of C. A. Figueroa (KCL).



SELECTED PUBLICATION

G. Troianowski, C. Taylor, A., J. Feinstein, A., I. Vignon-Clementel, E., Three dimensional simulations in Glenn patients: clinically based boundary conditions, hemodynamic results and sensitivity to input data, Journal of Biomechanical Engineering 133, 11, 2011.

FOLLOW-UP

While CARDIO permitted to deliver state of the art responses to scientific challenges, follow-up research is undertaken within existing grants or new avenues: more automatized parameter estimation from clinical data (REO-INRIA, UCSD and Leducq network; M3DISIM-INRIA and KCL with Figueroa ERC grant); Verification/validation (Figueroa ERC grant, REO Air Liquide collaboration) ; Uncertainty analysis (Leducq network, ...) ; Disease assesment.



CLOUDSHARE (2009-2014)

Cloud computing over internet volunteer resources

PRINCIPAL INVESTIGATORS

- Dr. Arnaud Legrand, MESCAL project-team, Inria Grenoble Rhône Alpes
- Dr. David Anderson, University of California Berkeley, Space Sciences Laboratory



RESEARCH OBJECTIVES

CLOUDSHARE investigates the use of **cloud computing** for large-scale and demanding applications and services over the most unreliable but also most powerful resources in the world, namely **volunteered resources over the Internet**. The motivation is the immense collective power of volunteered resources (evidenced by FOLDING@home's 3.9 PetaFLOPS system), and the relatively low cost of using such resources.

SCIENTIFIC ACHIEVEMENTS

The contributions of CLOUDSHARE were twofold. First, the team collected and archived traces, and developed software that facilitate their analysis and use (visualization and simulation). Second, building on the previous tools, the team developed **models and algorithms** optimizing the behavior of large-scale infrastructures.

PUBLICATIONS AND AWARDS

- 6 Journal articles.
- 2 Book chapters.
- 5 Conference papers.
- Failure trace archive at  <http://fta.inria.fr>
- Simgrid simulation framework at  <http://simgrid.gforge.inria.fr>

SELECTED PUBLICATION

E. Heien, D. Kondo, and D. P. Anderson. A Correlated Resource Model of Internet End Hosts. IEEE Transactions on Parallel and Distributed Systems, 23(6), June 2012.

FOLLOW-UP

The collaboration with David Anderson and the BOINC (Berkeley Open Infrastructure for Network Computing) COMMUNITY is very fruitful. It has led to new collaborations with for example Rhonda Righter (University of California Berkeley) and Wenjing Wu (Chinese Academy of Science). Ongoing research directions include: BOINC as a storage facility and improving BOINC turnaround time.



CLOUDY (2012-2014)

Secure and private distributed storage and publication in the future internet

PRINCIPAL INVESTIGATORS

- Dr. Claude Castelluccia, PRIVATICS project-team, Inria Grenoble Rhône Alpes
- Prof. Dawn Song, University of California Berkeley
- Prof. Gene Tsudik, University of California Irvine

RESEARCH OBJECTIVES

The customers of cloud applications benefit from outsourcing the management of their computing infrastructure to a third-party cloud provider. However, the customer has to assume that the “cloud” always remains confidential, available, fault-tolerant, well managed, properly backed-up and protected from natural accidents as well as intentional attacks. The main goal of CLOUDY is to study various aspects of Cloud Computing Security and Privacy.

SCIENTIFIC ACHIEVEMENTS

CLOUDY research spanned:

- **Password security:** The work led to: (i) a novel password cracker based on Markov models; and (ii) investigating how additional personal information about a user helps in speeding up password guessing.
- **New authentication schemes:** The team studied a new type of knowledge-based authentication scheme MooneyAuth, which eases the high cognitive load of passwords. It is based on implicit visual memory and is a graphical authentication scheme, which requires users to recognize degraded two-tone images that contain a hidden object.
- **Twitter privacy:** The work explores linkability of tweets based on a very large corpus of tweets, and demonstrates that, at least for relatively active tweeters, linkability of tweets by the same author is easily attained even with a large number of tweeters.



Top is the modified gray-scale version of the image, bottom is the Mooney version of the gray-scale image.
Copyright for the original image by Alex Pepperhill (CC by 2.0, source: <http://tinyurl.com/nhtlsfh>)

PUBLICATIONS AND AWARDS

- 3 Conference & 1 Workshop papers.

SELECTED PUBLICATION

C. Castelluccia, M. Duermuth, D. Perito. Adaptive Password Strength Meters from Markov Models, Network and Distributed Systems Security Symposium (NDSS), February 2012.

FOLLOW-UP

Most current security systems are not user-friendly and impose a strong cognitive burden on human users. Planned future work then includes exploring how new “health” related devices (such as EEG) and various monitoring sensors could be used to develop novel and practical authentication schemes.



COALA (SINCE 2010)

Communication optimal algorithms for linear algebra

PRINCIPAL INVESTIGATORS

- Dr. Laura Grigori, ALPINES project-team, Inria Paris-Rocquencourt
- Prof. James Demmel, University of California Berkeley

RESEARCH OBJECTIVES

COALA focuses on the design and implementation of numerical algorithms for today's large supercomputers formed by thousands of multicore processors, possibly with accelerators. COALA focuses on operations that are at the heart of many scientific applications such as solving linear systems of equations or least squares problems. The algorithms belong to a new class referred to as **communication avoiding** that provably minimize communication, where communication means the data transferred between levels of memory hierarchy or between processors in a parallel computer. This research is motivated by studies showing that communication costs can already exceed arithmetic costs by orders of magnitude, and that the gap is growing exponentially over time.

SCIENTIFIC ACHIEVEMENTS

COALA has developed communication avoiding algorithms for several operations in linear algebra, such as LU factorization, QR factorization, rank revealing QR factorization, sparse matrix multiplication, iterative solvers, and ILU preconditioner. An important aspect that is considered is the validation of the algorithms in real applications through the team's collaboration. Several invited plenary talks have been given on this topic at major conferences such as Supercomputing, SIAM Conference on Parallel Processing.

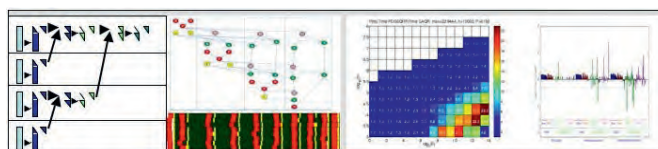

Communication avoiding algorithms: scheduling, performance, and stability

PUBLICATIONS AND AWARDS

- 5 Journal articles & 4 Conference papers.
- The algorithms are progressively implemented in widely used libraries such as LAPACK, ScaLAPACK, and some of them are available in vendor libraries such as Cray's libsci or Intel's MKL libraries.

SELECTED PUBLICATION

J. Demmel, L. Grigori, M. Hoemmen, and J. Langou, Communication-optimal parallel and sequential QR and LU factorizations, SIAM Journal on Scientific Computing, Vol. 34, No 1, 2012.

FOLLOW-UP

The collaboration continues as part of Dr. L. Grigori's sabbatical at UC Berkeley. The focus of the collaboration extends now to linear algebra operations that are used in Data Analytics and their implementation by using Spark.





COMET (2011-2013)

Computational methods for the analysis of high-dimensional data

PRINCIPAL INVESTIGATORS

- Dr. Steve Y. Oudot, GEOMETRICA project-team, Inria Saclay Ile de France
- Prof. Leonidas Guibas, Stanford University
- Prof. Yusu Wang, Ohio-State University

RESEARCH OBJECTIVES

COMET is an Associate Team between the GEOMETRICA group at Inria, the Geometric Computing group at Stanford University, and the Computational Geometry group at the Ohio State University. Its focus is on the design of computational methods for the analysis of high dimensional data, using tools from metric geometry and algebraic topology. The goal of the team is to extract enough structure from the data, so as to get a higher-level informative understanding of these data and of the spaces they originate from. The main challenge is to be able to go beyond mere dimensionality reduction and topology inference, without the need for a costly explicit reconstruction.

SCIENTIFIC ACHIEVEMENTS

COMET focused on the following topics:

- **Analysis of shapes via signatures:** Analysis and visualization of maps between shapes, and Map-based exploration of intrinsic shape differences and variability.
- **Geometric and topological inference in the presence of noise and outliers:** Smoothing GPS trajectories using distances to measures, Reconstructing metric graphs from point cloud data, Clustering point cloud data using topological persistence, Homology inference in the presence of unbounded noise and outliers, and Scalar fields analysis in the presence of unbounded noise and outliers.

PUBLICATIONS AND AWARDS

- 4 Journal articles.
- 3 Conference papers.
- Selected publication below elected among the notable articles of 2013 in computing by ACM and Computing Review:

 http://computingreviews.com/recommend/bestof/notable-items_2013.cfm

SELECTED PUBLICATION

F. Chazal, L. J. Guibas, S. Y. Oudot, and P. Skraba. Persistence-Based Clustering in Riemannian Manifolds. Journal of the ACM, volume 60, issue 6, article 41, 2013.

FOLLOW-UP

The work done between Inria and Stanford within COMET has given promising results, while the 2 topics addressed would benefit greatly from being considered jointly instead of separately.





COMFORT (SINCE 2014)

Control and forecasting in transportation networks

PRINCIPAL INVESTIGATORS

- Prof. Carlos Canudas de Wit, NECS project-team, Inria Grenoble Rhône Alpes
- Prof. Roberto Horowitz, University of California Berkeley

RESEARCH OBJECTIVES

COMFORT addresses open issues for Intelligent Transportation Systems (ITS). The goal of ITS is to use information technologies (sensing, signal processing, machine learning, communications, and control) to improve traffic flow, as well as enhance COMFORT and safety of drivers. These tools are doubtlessly of very high societal and economical value. It has been established over the past several decades, through field studies and many scholarly publications, that ITS tools can significantly improve traffic flows on congested freeways and streets. COMFORT is concerned with the following three main objectives: (i) Model validation and robust modeling for traffic estimation, control and forecasting; (ii) New methods for traffic forecasting; and (iii) New methods for distributed traffic control and estimation.

SCIENTIFIC ACHIEVEMENTS

The issue of maximizing the green-light interval that allows uninterrupted traffic flow along the entire arterial is nowadays critical. Benefits of traffic lights coordination are undeniable in terms of reducing delay, unnecessary stops, energy and fuel consumption, pollution. COMFORT has addressed this problem through the use of two control actions: traffic light offsets and variable speed limits. Specifically, the state-of-the-art of the optimization problem was enriched in order to account for traffic energy consumption and network travel time, thus avoiding impractical or undesirable solutions. A traffic microscopic simulator was used to assess the performance of the proposed technique in terms of

energy consumption, travel time, idling time, and number of stops. The correlation of theoretical bandwidth with known traffic performance metrics was studied, and an analysis of the Pareto optimum was carried out to help the designer to choose a trade-off in the multi-objective optimization problem. Finally, an evaluation of the traffic performance at different levels of traffic demand, aimed at showing the best operation conditions of the proposed strategy, and at devising a demand-dependent optimization, was performed. The main result of the work can be summarized as follows: At under-saturated traffic conditions (i.e. all queues at the traffic lights are dissipated within the cycle time), the variable-speed-limits control is able to reduce the energy consumption by 35%, while ensuring no loss in terms of travel time.

PUBLICATIONS AND AWARDS

- 2 Conference papers.
- 1 Journal paper (to appear) & 1 Journal paper (submitted).

SELECTED PUBLICATION

C. Canudas de Wit, F. Morbidi, L. Leon Ojeda, A. Kibangou, I. Bellicot, P. Bellemain. Grenoble Traffic Lab: An experimental platform for advanced traffic monitoring and control. IEEE Control Systems Magazine (2015).



COMMUNITY (2009-2014)

Message delivery in heterogeneous networks

PRINCIPAL INVESTIGATORS

- Dr. Thierry Turletti, DIANA project-team, Inria Sophia Antipolis Méditerranée
- Prof. Katia Obraczka, University of California Santa Cruz

RESEARCH OBJECTIVES

COMMUNITY has investigated a number of research challenges raised by message delivery in environments consisting of heterogeneous networks with possibly episodic connectivity.

SCIENTIFIC ACHIEVEMENTS

During the first three years, COMMUNITY explored solutions to enable efficient delivery mechanisms for disruption-prone and heterogeneous networks (i.e., challenged networks). This resulted in the MeDeHa framework along with the Henna naming scheme, which allow communication in infrastructure and infrastructure-less networks with varying degrees of connectivity. The team also proposed efficient routing strategies adapted to environments with episodic connectivity that take into account the utility of nodes to relay messages. The various solutions have been evaluated using both simulations and real experimentations in testbeds located at Inria and UC Santa Cruz. These solutions have demonstrated good performance in challenged networks. However, the ossification of the Internet prevents the deployment of such solutions in large scale.

Following, in 2012, the team pursued its collaboration along two research directions: (i) the design of innovative information-centric communication mechanisms adapted to challenged networks; and (ii) the exploration of the SDN - Software-Defined Network - paradigm to facilitate the implementation and large-scale deployment of new network architectures, to offer innovative services such as capacity sharing.

PUBLICATIONS AND AWARDS

- 6 Journal articles.
- 8 Conference papers.
- 5 demos at conferences.
- Open source software for Software-Defined Networking Based Capacity Sharing in Hybrid Networks, available at

 <http://inrg.cse.ucsc.edu/community/Software>

SELECTED PUBLICATION

B. Astuto, M.A. S. Santos, B.T. de Oliveira, C.B. Margi, K. Obraczka, and T. Turletti, "Software- Defined Networking Enabled Capacity Sharing in User Centric Networks", in IEEE Communication Magazine, Special Issue on User-Centric Networks, IEEE, 52(9) 09/2014.

FOLLOW-UP

The expertise gained in SDN by the Inria team has allowed follow-up French ANR projects.





CRISP (SINCE 2011)

Creating and rendering images based on the study of perception

PRINCIPAL INVESTIGATORS

- Dr. Adrien Bousseau, REVES project-team, Inria Sophia Antipolis Méditerranée
- Prof. Maneesh Agrawala, University of California Berkeley

RESEARCH OBJECTIVES

CRISP explores novel ways to create, render and interact with images based on the study of human perception. The participants of CRISP share complementary expertise in computer graphics, human computer interaction and human visual perception.

SCIENTIFIC ACHIEVEMENTS

During the first 3 years, the team made significant progress on its three research themes:

- **Perception:** Work relates to extensive studies evaluating how materials are perceived in stylized images (specifically painting and cartoon) and how people perceive distortions in image-based street-level visualizations, such as Google Street View.
- **Rendering:** Results include a new algorithm to render objects with rough refraction in real-time. The method achieves real-time performance by approximating the complex light transport phenomena involved in rough refractions while producing results visually similar to images computed with an offline physically-based path tracer.
- **Interaction:** Contribution includes an automatic system to facilitate the design of effective lighting for material depiction. The system optimizes environment map lighting according to guidelines on lighting design for material depiction. The team has also introduced “vector shade trees” that bring to vector graphics the flexibility of modular shading as commonly used in 3D rendering.



Experiment to measure perceived distortion

PUBLICATIONS AND AWARDS

- 3 Journal articles published in ACM Transactions on Graphics, 2 articles in Computer Graphics Forum, 1 article in IEEE Transactions on Visualization and Computer Graphics.
- Best paper award at ACM SIGGRAPH Symposium on Interactive 3D Graphics and Games, 2011.

SELECTED PUBLICATION

Peter Vangorp, Christian Richardt, Emily A. Cooper, Gaurav Chaurasia, Martin S. Banks, George Drettakis, Perception of Perspective Distortions in Image-Based Rendering, ACM Transactions on Graphics (SIGGRAPH Conference Proceedings), Volume 32, Number 4, jul 2013

FOLLOW-UP

CRISP pursues its collaboration along the 3 directions of: Perception, Rendering and Interaction.



DALHIS (SINCE 2013)

Data analysis on large-scale heterogeneous infrastructures for science

PRINCIPAL INVESTIGATORS

- Dr. Christine Morin, MYRIADS project-team, Inria Rennes - Bretagne Atlantique
- Dr. Deb Agarwal, Lawrence Berkeley National Laboratory, University of California Berkeley

RESEARCH OBJECTIVES

DALHIS is creating a software ecosystem to facilitate seamless data analysis across desktops, HPC and cloud environments. The goal is to build a dynamic software stack that is user-friendly, scalable, energy efficient and fault tolerant.

Research areas span:

- **Programming environment for scientific data analysis workflows:** An integrated capability that will allow users to easily compose their workflows in a programming environment such as Python and execute them on diverse high performance computing (HPC) and cloud resources.
- **Adaptive orchestration layer:** The adaptation model will use real-time data mining to support elasticity, fault-tolerance, energy efficiency and provenance.
- **Infrastructure support for HPC, clusters and cloud systems:** The research will determine how to provide execution environments that allow users to seamlessly execute their dynamic data analysis workflows in various research environments and scales.

SCIENTIFIC ACHIEVEMENTS

- Evaluation of the performance/energy efficiency trade-off of Hadoop run on physical and virtual clusters for two deployment modes: colocated data and compute services and dedicated data nodes separated from compute nodes.

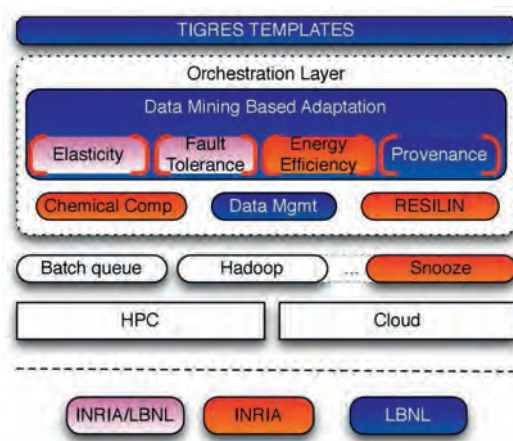

- Development and evaluation of a chemical runtime support for TIGRES high-level specification of scientific workflows.
- Evaluation of FRIEDA flexible robust intelligent data management framework for deploying data-intensive scientific applications in clouds.

PUBLICATIONS AND AWARDS

- 1 Journal article, 1 Book chapter, 1 Conference paper, 3 Workshop papers
- Deb Agarwal is the recipient of a 2015 Inria International chair.

SELECTED PUBLICATION

Eugen Feller, Lavanya Ramakrishnan, Christine Morin, Performance and Energy Efficiency of Big Data Applications in Cloud Environments: A Hadoop Case Study, JPDC, 2015.





FASTLA (SINCE 2012)

Fast and scalable hierarchical algorithms for computational linear algebra

PRINCIPAL INVESTIGATORS

- Dr. Olivier Coulaud, HIEPACS project-team, Inria Bordeaux Sud Ouest
- Prof. Eric Darve, Stanford University
- Dr. X.S. Li, Lawrence Berkeley National Lab

RESEARCH OBJECTIVES

FASTLA studies fast and scalable hierarchical numerical kernels and their implementations on heterogeneous manycore platforms for two major computational kernels in intensive challenging applications. Namely, fast multipole methods (FMM) and sparse linear solvers that appear in many intensive numerical simulations in computational sciences. For the solution of large linear systems, the ultimate goal is to design parallel scalable methods that rely on efficient sparse and dense direct methods using H-matrix arithmetic. Finally, the innovative algorithmic design will be essentially focused on heterogeneous manycore platforms by using task based runtime systems.

SCIENTIFIC ACHIEVEMENTS

- **Fast Multipole Method:** The focus is on developing and on improving methods based on interpolation formulations (Chebyshev, equispaced points) and their efficiency and ease of use in the context of dislocation kernels.
- **Sparse Linear Solvers:** Study the use of low rank techniques (H-matrix like) to design fast direct and hybrid solvers able to compute data-sparse approximation of Schur complements.
- **Improved parallelism for modern computers for heterogeneous manycores:** Improvement of the parallel performance and scalability using hybrid parallelism and a task based programming model.

PUBLICATIONS AND AWARDS

- 9 Journal articles.
- 12 Conference and Workshop papers.

SELECTED PUBLICATION

E. Agullo, B. Bramas, O. Coulaud, E. Darve, M. Messner, T. Takahashi, Taskbased FMM for Multicore Architectures, SIAM Journal on Scientific Computing. vol 36, num 1, 2014.

FOLLOW-UP

The team was renewed for 3 years in 2015 to pursue its collaboration along the aforementioned topics involving many PhD and post-docs in addition to the senior researchers of each group.



HYPERION (2012-2014)

Large-scale statistical learning for visual recognition

PRINCIPAL INVESTIGATORS

- Dr. Zaid Harchaoui, LEAR project-team, Inria Grenoble Rhône Alpes
- Dr. Cordelia Schmid, LEAR project-team, Inria Grenoble Rhône Alpes
- Prof. Jitendra Malik, University of California Berkeley
- Prof. Nouredine El Karoui, University of California Berkeley

RESEARCH OBJECTIVES

A recent trend in computer vision as well as in other fields is the advent of “**big data**” with an increasing number of large annotated image and video datasets now becoming available to researchers, along with an increasing number of benchmarks and challenges associated to these datasets. In particular, designing principled and **scalable statistical learning** approaches from such big datasets is actually challenging. Furthermore, these datasets also bring to light not only major statistical and computational challenges but also core **computer vision issues**. The scientific objective of HYPERION is to take up these challenges and propose new principled large-scale statistical learning approaches for image interpretation and learning models for video understanding.

SCIENTIFIC ACHIEVEMENTS

- **Action localization with movemes:** The team designed new visual descriptors, called movemes, blending information from shape and motion cues, for human action localization.
- **Fast and robust archetypal analysis:** The team proposed a novel approach, called robust archetypal analysis, for visualization of large image collections.
- **Object localization with S-LSVM:** The team proposed a two-step approach called S-LSVM for object localization in images with minimal supervision.

PUBLICATIONS AND AWARDS

- 10 Conference papers.
- Open-source software packages and publicly available benchmark datasets.
- Awardee of a 2012 France-Berkeley Fund.

SELECTED PUBLICATION

Y. Chen, J. Mairal, and Z. Harchaoui. Fast and robust archetypal analysis for representation learning. In CVPR Computer Vision and Pattern Recognition, 2014.

FOLLOW-UP

The collaboration has been fruitful, leading to several published papers in top venues in computer vision and machine learning. Follow-up work is thus anticipated along the research themes that were investigated as part of HYPERION.





IT-SG-WN (2011-2013)

Wireless networks and information theory

PRINCIPAL INVESTIGATORS

- Dr. François Baccelli, TREC project-team, Inria Paris-Rocquencourt
- Prof. Venkat Anantharam, University of California Berkeley

RESEARCH OBJECTIVES

The research is centered on the interplay between stochastic geometry and network information theory, with a particular emphasis on wireless networks. In terms of research, two main lines of thought are: (1) Error exponents and stochastic geometry, (2) Stochastic geometry and the modeling of networks leveraging multi user information theory.

SCIENTIFIC ACHIEVEMENTS

- **Error exponents and stochastic geometry:** The team continued its prior work on the analysis of the error exponent (reliability function) for classical channels in Information Theory, with combined techniques of point process theory and stochastic geometry in high dimension, large deviations and perturbation analysis. This led to general results on error exponents associated with stationary and ergodic noise for classical channels of information theory as well as network information theory like the MAC channel.
- **Stochastic geometry and the modeling of networks leveraging multi user information theory:** The team investigated the interplay between Network Information Theory and stochastic geometry to analyze large wireless networks. The objective was to derive innovative distributed communication strategies alleviating the interference limitations and allowing one to transfer information more efficiently through large wireless networks. In collaboration with A. El Gamal at Stanford University and D. Tse, the team obtained

a global estimation of the improvement brought by simultaneous decoding in networks with multiple MAC or multiple interference channels.

PUBLICATIONS AND AWARDS

- 4 Journal articles.
- 3 Conference papers.

SELECTED PUBLICATION

F. Baccelli, A. El Gamal and D. Tse, 2011, Interference networks with point-to-point codes. IEEE International Symposium on Information Theory Proceedings (ISIT).

FOLLOW-UP

The team has continued work on the Shannon Capacity and Error Exponents. The focus is on improvement of known error exponents by investigating other point processes like Matern, Gibbs, Determinantal. The team also had interest in extending the theory to other channels of Network IT like broadcast channels, interference channels and MIMO channels.



ITSNAP (2009-2014)

Intelligent techniques for structures of nucleic acids and proteins

PRINCIPAL INVESTIGATORS

- Dr. Julie Bernauer, AMIB project-team, Inria Saclay Île-de-France
- Prof. Michael Levitt, Stanford University
- Dr Henry van den Bedem, Stanford Synchrotron Radiation Laboratory, SLAC



RESEARCH OBJECTIVES

RNA molecules are key biomolecules that are involved in a wide range of important biological processes for therapeutics such as gene regulation. To better understand the role of nucleic acids and specifically RNA in the cell, its folding, dynamics and interactions with ions and proteins should be studied. The ITSNAP team aimed at developing methods based on recent improvements in biogeometry, statistics and machine learning to improve RNA structure modeling, possibly dynamics simulations, junction characterization and protein-RNA interactions.

SCIENTIFIC ACHIEVEMENTS

Results span: (i) developing inverse-kinematics strategies for RNA sampling (KGSrna), (ii) improving on the initial sampling to handle protein assemblies for experimental fitting and refinement, (iii) extending the KB potentials to drive the RNA sampling and docking, and (iv) developing a new full-flexible protein-RNA procedure that incorporates biological information.

PUBLICATIONS AND AWARDS

- 4 Journal articles.
- 4 Conference papers.
- KGSrna software for RNA conformation sampling at <http://albios.saclay.inria.fr/kgsrna/>
- NA KB potential Web server at <http://csb.stanford.edu/rna>
- Recipient of a 2014-15 France Stanford Research grant.

SELECTED PUBLICATION

Fonseca R, Pachov DV, Bernauer J, van den Bedem H: Characterizing RNA ensembles from NMR data with kinematic models. *Nucleic Acids Res.* 2014, 42(15): 9562-72. PMID: 25114056.

FOLLOW-UP

ITSNAP proved essential in shedding light on the undertaken activities to the international community but also on Inria in the Computational Structural Biology community. Hopefully, the Inria Associate team and *Inria@SiliconValley* programs will continue successfully promoting the teams' activities and creating an active scientific community and local social networks internationally.



OAKSAD (SINCE 2013)

Languages and techniques for efficient large-scale web data management

PRINCIPAL INVESTIGATORS

- Dr. Ioana Manolescu, OAK project-team, Inria Saclay Île de France
- Prof. Alin Deutsch, University of California San Diego

RESEARCH OBJECTIVES

Data with complex structure and semantics is increasingly created by users and applications and shared through a variety of means, mostly based on the Web. Popular Web formats are W3C's XML for structured documents and RDF for Semantic Web data; the JSON model is also increasingly used as a flexible way of encoding and sharing data. **Efficient data management algorithms and tools** are needed to help users apprehend and exploit such large volumes and variety of data, based on: high-level languages; optimization algorithms; and efficient evaluation primitives.

SCIENTIFIC ACHIEVEMENTS

Most significant results of OAKSAD concern so far: (i) efficient models, algorithms and techniques for highly efficient data stores and (ii) massively parallel algorithms for processing Web data, in particular Linked Open Data through SPARQL, and nested data through PigLatin.

PUBLICATIONS AND AWARDS

- 2 Conference papers, 2 Technical reports.
- Software: **CliqueSquare**, a platform for massively parallel RDF processing; **PigReuse**, an optimization library deployed within the Apache Pig project; **Estocada** (development ongoing), a platform for efficiently storing massive data on top of heterogeneous stores.

SELECTED PUBLICATION

Ioana Ileana, Bogdan Cautis, Alin Deutsch, Yannis Katsis: "Complete yet Practical Search for Minimal Query Reformulation under Constraints", ACM Conference of the Special Interest Group in the Management of Data (SIGMOD), 2014.



ORESTE (SINCE 2012)

Optimal reroute strategies for traffic management

PRINCIPAL INVESTIGATORS

- Dr. Paola Goatin, ACUMES team, Inria Sophia Antipolis Méditerranée
- Prof. Alexandre Bayen, University of California Berkeley

RESEARCH OBJECTIVES

The problem of road traffic, and its effects on pollution, time-consumption and their social and economical consequences, require an accurate policy and planning of road networks. The recent advances in technology and Internet can provide low-cost and reliable solutions to the collection of traffic data. GPS-equipped mobile devices can contribute to reduce traffic and the amount of time spent on the road by providing more accurate sources of travel information. ORESTE tackles a problem that has become fundamental in congested areas: flow reroutes. It looks for optimal strategies for rerouting some of the highway traffic flow into the secondary network, to decongest the freeways without congesting the arterials. This requires the construction of adapted macroscopic models of road traffic on networks, which are based on partial differential equations and result in optimization problems that are extremely hard to solve in a continuous setting. Therefore, ORESTE approaches the problem from a discrete (numerical) standpoint, to provide constructive results (in a discrete setting), which can be implemented in practice.

SCIENTIFIC ACHIEVEMENTS

Contributions span: (1) A continuous junction model with on-ramp buffer, (2) Coordinated ramp-metering for road networks via adjoint-based optimization, and (3) Optimal dynamic traffic assignment with partial compliance for horizontal queuing networks.

PUBLICATIONS AND AWARDS

- 2 Journal articles (+1 currently submitted).
- 1 Conference paper.
- Awardee of a 2012 France-Berkeley Fund.
- Integration of the results in the platform:

 <http://connected-corridors.berkeley.edu/>

SELECTED PUBLICATION

M.L. Delle Monache, J. Reilly, S. Samaranayake, W. Krichene, P. Goatin and A. Bayen. A PDE-ODE model for a junction with ramp buffer, *SIAM J. Appl. Math.*, 74(1) (2014), 22-39.

FOLLOW-UP

The team has been renewed for 3 years in 2015 and further extends the collaboration to Rutgers University (PI Prof. Benedetto Piccoli), with the aim to develop a unified macroscopic approach for traffic management by providing analytical and numerical tools for traffic monitoring, prediction and control, based on real-time sensing.





RIPPES (SINCE 2013)

Rigorous programming of predictable embedded systems

PRINCIPAL INVESTIGATORS

- Dr. Alain Girault, SPADES project-team, Inria Grenoble Rhône-Alpes
- Prof. Edward Lee, EECS Department, University of California Berkeley

RESEARCH OBJECTIVES

Embedded systems are deployed on many-core chips with architectural features that render program execution extremely efficient but also highly unpredictable (e.g., caches, out-of-order execution, branch prediction). This unpredictability makes it almost impossible to guarantee that the constraints are met, or when they are, it is at the cost of huge over-approximations. The goal of RIPPES is to achieve both predictability and adaptivity.

SCIENTIFIC ACHIEVEMENTS

Contributions of RIPPES have been twofold. First, RIPPES has proposed a new parametric data-flow model of computation, called BPDF (Boolean Parametric Data Flow). BPDF combines integer parameters so that actors can adapt dynamically their input and output rates, and Boolean parameters so that edges can be disabled dynamically. This makes BPDF ideally suited to program modern video codec and software defined radio applications. In contrast with existing parametric model of computations, BPDF offers static analyses for soundness, liveness, schedulability, throughput calculation, and buffer size assessment.

The second contribution of the team concerns Precision Timed Machines (PRET). The PRET philosophy is to propose both a programming language and a processor such that source code written in this language can be compiled into object code whose execution time on the PRET processor can be both very precise (i.e., the over-

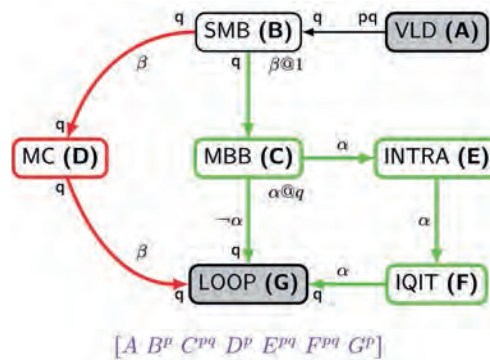

The VC-1 video decoder implemented in the BPDF model of computation

approximation between the real worst-case execution time – WCRT – and the computed one must be as small as possible) and still good compared to the average-case execution time – ACRT – of the same source code on a regular modern processor. The team has proposed the ForeC programming language, which is an extension of C with synchronous concurrency constructs to provide a deterministic execution on multi-core chips. RIPPES has also proposed several PRET processors, for instance the FlexPRET processor, which is multithreaded such that critical threads are perfectly time predictable (i.e., their ACRT is equal to their WCRT) while non-critical threads are executed on a best effort basis to improve the average performances.

PUBLICATIONS AND AWARDS

- 2 Journal articles & 5 Conference papers.

SELECTED PUBLICATION

S. Andalam, P.S. Roop, A. Girault and C. Traulsen, "A predictable framework for safety-critical embedded systems", IEEE Trans. on Computers, 63(7): 1600-1612, July 2014.



SIRIUS (2011-2013)

Situated interaction

PRINCIPAL INVESTIGATORS

- Dr. Wendy Mackay, IN-SITU project-team, Inria Saclay Île-de-France
- Prof. Scott Klemmer, Stanford University
- Prof. Bjoern Hartmann, University of California, Berkeley

RESEARCH OBJECTIVES

SIRIUS explored how to create novel interactive environments, with a focus on tangible and multi-surface interaction, using participatory and “research through design” techniques.

SCIENTIFIC ACHIEVEMENTS

Multi-surface Interaction: SIRIUS created Hydrascope, which distributes web applications in multi-surface environments; Combinatorix, in which students obtain a concrete understanding of combinatorial statistics by manipulating both physical and virtual tokens; the CHI Video Preview system for the dynamic display of over 500 30-second videos of technical content; and WILDView/Cobi, which used the WILD interactive wall to schedule the four-day CHI’13 conference (16-parallel sessions, 1000 presentations).

Research Methods: SIRIUS explored novel participatory design techniques, including branching storyboards and peer-critical incident technique, to understand how medical students handle critical events and interact with emergency manuals in the operating room. The team also explored how “makers” customize 3d-printed objects in the Thingiverse.

The team wrote a book chapter on “research through design”, which explores the multidisciplinary links between traditional natural scientific and design techniques.

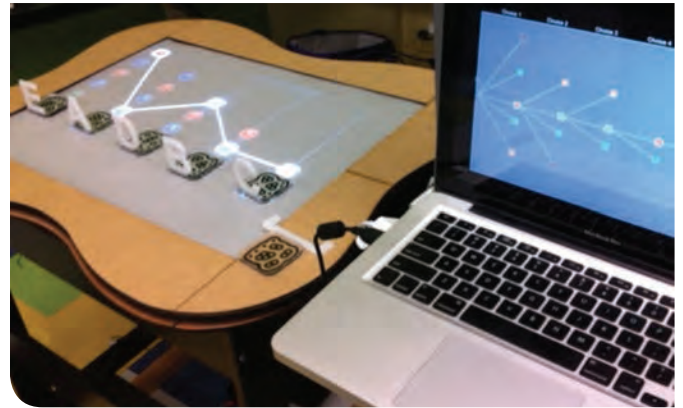

Combinatorix

PUBLICATIONS AND AWARDS

- 1 Book chapter; 3 Posters: CURIS’11, ACM CHI EA’13 (2).
- Software: Hydrascope, Combinatorix, WILDView/Cobi.
- NSF CNIC award on Multi-Surface environments - OISE-1157574.

SELECTED PUBLICATION

Dow, S., Ju, W. and Mackay, W.E. (2012). Projection, Place and Point-of-View in Research through Design. In *The Sage Handbook of Digital Technology Research*, Chapter 22, Sarah Price, C. Jewitt & Barry Brown (eds). Sage Publications, 2012.

FOLLOW-UP

Collaborations and cross-visits continue with both Berkeley and Stanford.

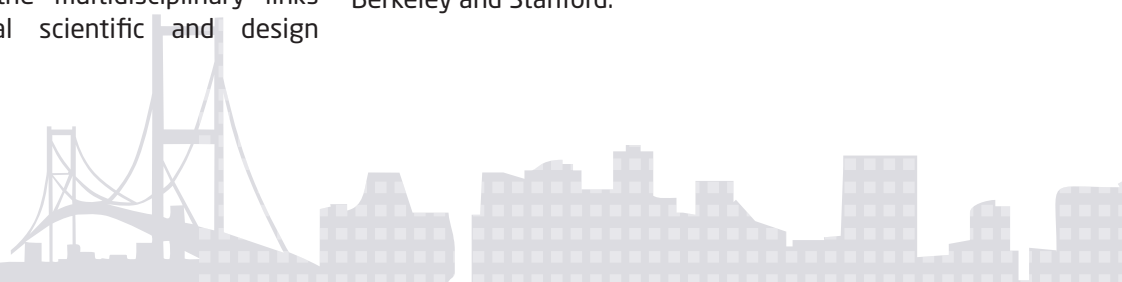



SNOWFLAKE (SINCE 2014)

Knowledge discovery from linked data and clinical notes

PRINCIPAL INVESTIGATORS

- Dr. Adrien Coulet, ORPAILLEUR project-team, Nancy Grand Est
- Dr. Nigam Shah, Stanford Center for Biomedical Informatics Research, Stanford University

RESEARCH OBJECTIVES

The aim of SNOWFLAKE is to study the impact of connecting Electronic Health Records (EHRs) with Linked Open Data (LOD), because the team believes that LOD and associated ontologies can guide the process of knowledge discovery from EHRs.

Scientific objectives of SNOWFLAKE are:

- To increase the quality of information extraction from EHRs.
- To create accurate links between EHR extracted data and LOD.
- To discover knowledge that explains the variability of drug responses.

SCIENTIFIC ACHIEVEMENTS

Depending on their genetics and their exposure to the environment, individuals are reacting differentially to drugs. During its first year, the SNOWFLAKE Associate Team proposed to characterize this variability to drug response by mining the EHRs of the Stanford Hospital. The team implemented an approach to detect dose and drug changes in patient history with the hypothesis that if a patient over reacts or under reacts to a drug, physicians will either change the dosage or change the drug itself. In the meanwhile, the team is profiling phenotypes before and after dose and drug changes to characterize these events. Next step is to establish how phenotype profiles are specific to some drugs or to certain populations, and further how they can be used to predict the necessity of changing the dose or the drug of a patient.



Adrien Coulet and Yen Low at HCBO Hackathon 2014 : Best Application Prize

PUBLICATIONS AND AWARDS

- 3 Journal articles & 2 Conference papers.
- First common article in preparation.
- Best Application Prize, NCBO Hackathon 2014 - for "Whypothesis?", a prototypical software that searches the LOD for molecular mechanisms that could explain drug side effects of unknown origin.

SELECTED PUBLICATION

Personeni G., Daget S., Bonnet C., Jonveaux P., Devignes M.-D., Smail-Tabbone M. and Coulet A.: Mining Linked Open Data: a Case Study with Genes Responsible for Intellectual Disability. In International Conference on Data Integration in Life Sciences 2014, Lecture Notes in Bioinformatics, 8574: 16 - 31, Springer.



SPLENDID (2012-2014)

Self-paced learning for exploiting noisy, diverse or incomplete data

PRINCIPAL INVESTIGATORS

- Dr. Nikos Paragios, GALEN project-team, Inria Saclay Île-de-France
- Prof. Daphne Koller, Stanford University

RESEARCH OBJECTIVES

Supervised learning requires that all the samples in the training dataset are fully annotated. In many cases, the collection of such datasets is either impossible to obtain (e.g., in computational biology where the ground truth annotation is unknown) or, even if it is possible, it is too expensive (e.g., segmentation of millions of images). SPLENDID would like to move towards a learning paradigm that reflects the true availability of data in real life. The goal of SPLENDID is thus to develop machine learning techniques that allow exploiting the information present in the following three related categories of data: (i) Diverse data, where some training samples are fully supervised, while other samples are weakly supervised; (ii) Incomplete data, where the training samples have not been fully annotated; and (iii) Noisy data, where some of the training samples may be labeled incorrectly.

SCIENTIFIC ACHIEVEMENTS

SPLENDID results span the following areas: Dissimilarity coefficient learning, Parameter estimation for random walks, Parameter estimation for region-based models, and Local symmetries for contour and object reconstruction.

PUBLICATIONS AND AWARDS

- 1 Journal article.
- 2 Conference papers.
- API for Modeling Latent Variable Uncertainty for Loss-based Learning ;

 <http://cvn.ecp.fr/personnel/pawan/code/DISCAPI.zip>

SELECTED PUBLICATION

P.-Y. Baudin, D. Goodman, P. Kumar, N. Azzabou, P.G. Carlier, N. Paragios and M. Pawan Kumar. Discriminative Parameter Estimation for Random Walks Segmentation. In Proceedings of International Conference on Medical Image Computing and Computer Assisted Intervention (MICCAI), 2013.

FOLLOW-UP

While Prof. Daphne Koller has left Stanford University to work full-time as the CEO of Coursera, GALEN is continuing its research on this topic with IIIT Hyderabad (supported by a CEFIPRA grant). Preliminary results of this work have appeared in the leading conferences on machine learning (NIPS 2014) and computer vision (ECCV 2014 and CVPR 2014).





STATWEB (2011-2013)

Fast statistical analysis of web data via sparse learning

PRINCIPAL INVESTIGATORS

- Dr. Francis Bach, SIERRA project-team, Inria Paris Rocquencourt
- Prof. Laurent El Ghaoui, University of California Berkeley

RESEARCH OBJECTIVES

STATWEB aims to provide web-based tools for the analysis and visualization of large corpora of text documents, with a focus on databases of news articles. The team uses advanced algorithms, drawing from recent progresses in machine learning and statistics, to allow a user to quickly produce a short summary and associate timeline showing how a certain topic is described in news media.

SCIENTIFIC ACHIEVEMENTS

- **Theoretical analysis of sparse PCA:** The team has shown that methods based on convex relaxations could reach the desired detection threshold, improving over the best known polynomial-time result.
- **Parallel graph cuts for computer vision:** While general submodular minimization is challenging, the team has proposed a new approach that exploits existing decomposability of submodular functions. In contrast to previous approaches, the method is neither approximate, nor impractical, nor does it need any cumbersome parameter tuning. Moreover, it is easy to implement and parallelize.
- **Natural language processing with weakly supervised learning:** the team has designed a new algorithm to extract relations from text using distant supervision.

PUBLICATIONS AND AWARDS

- 2 Journal articles.
- 2 Conference papers.

SELECTED PUBLICATION

A. d'Aspremont, F. Bach, L. El Ghaoui. Approximation Bounds for Sparse Principal Component Analysis. *Mathematical Programming*, 2013.

FOLLOW-UP

The collaboration has continued in several forms among which the *Inria@SiliconValley* postdoctoral grant of Edouard Grave who has been studying "semi-supervised models for event extraction from textual data". The associate team has allowed building a collaboration and a mutual respect between Inria and UC Berkeley teams, which is lasting.







Contact
siliconvalley@inria.fr

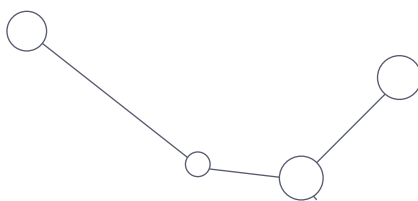

For more information



<https://project.inria.fr/siliconvalley/>



In partnership with



Supported by

