



HAL
open science

Wireless Cognitive Networks Technologies and Protocols

Valeria Loscrì, Arash Maskooki, Nathalie Mitton, Anna Maria Vegni

► **To cite this version:**

Valeria Loscrì, Arash Maskooki, Nathalie Mitton, Anna Maria Vegni. Wireless Cognitive Networks Technologies and Protocols. Modeling and Simulation of Computer Networks and Systems: Methodologies and Applications, 2015. hal-01145389

HAL Id: hal-01145389

<https://inria.hal.science/hal-01145389>

Submitted on 24 Apr 2015

HAL is a multi-disciplinary open access archive for the deposit and dissemination of scientific research documents, whether they are published or not. The documents may come from teaching and research institutions in France or abroad, or from public or private research centers.

L'archive ouverte pluridisciplinaire **HAL**, est destinée au dépôt et à la diffusion de documents scientifiques de niveau recherche, publiés ou non, émanant des établissements d'enseignement et de recherche français ou étrangers, des laboratoires publics ou privés.

Wireless Cognitive Networks Technologies and Protocols

Valeria Loscri¹, Arash Maskooki¹, Nathalie Mitton¹, and Anna Maria Vegni²

¹ Inria Lille-Nord Europe, Villeneuve d'Ascq, France. Email: {firstname.lastname}@inria.fr

² Department of Engineering, COMLAB Telecommunications Laboratory, Roma Tre University, Rome, 00146 Italy. Email: annamaria.vegni@uniroma3.it

Preface

Software Defined Radio and Cognitive Radio applied to Wireless Sensor Networks and Body Area Networks represent an intriguing and really recent paradigm, which represents an objective of study of several researchers. In order to make this technology effective, it is necessary to consider an analytical model of communication capacity, energy consumption and congestion, to effectively exploit the Software Defined Radio and Cognitive Radio in this type of systems.

This chapter discusses on the analytical modeling to make this kind of technologies effective for wireless networks, by focusing on Cognitive Wireless Sensor Networks and Cognitive Wireless Body Area Networks. Moreover, we consider some routing approaches proposed for Cognitive Wireless Sensor Networks and Cognitive Wireless Body Area Networks, and evaluated by means of simulation. Finally, we address additional issues that this type of networks presents by comparing them with "traditional" routing protocols.

Keywords: Software Defined Radio, Cognitive Radio, Wireless Sensor Networks, Body Area Networks.

Introduction

Software Defined Radio (SDR) can be considered as the technology that allows the implementation of some modulation or demodulation schemes through modifiable software or firmware.

The concept of Cognitive Radio (CR) [1, 88] can be synthesized as: devices equipped with the capability to observe and learn from the operating environment, and adapt their wireless communication parameters in order to optimize network performance. The key attributes of Cognitive Radio can be considered as "learn", "sense", and "adapt". The learning mechanisms are necessary to acquire information about communication parameters and to capture the underutilized spectrum by sensing the surrounding. Adaptive and dynamic adjustment of the transmission parameters (*i.e.*, transmission power) allows the achievement of a better utilization of the spectrum.

Future wireless communications will require an increasing opportunistic use of the licensed radio frequency spectrum, and the CR paradigm provides a suitable

framework for this aim. The main objective of CR paradigm is to improve spectrum usage efficiency, while minimizing the problem of spectrum over-crowdedness [2]. Indeed, a CR system is based on the fact that the different parts of the channel are not only allocated to fixed and pre-assigned users, but idle segments of the spectrum are made available to other users.

Recent advances in Cognitive Radio Networks (CRNs) have dealt with multi-hop networks, representing a promising design to leverage the full potential of CRNs. One of the main features in multi-hop networks is the routing metric used to select the best route to forward packets. In [3], Youssef *et al.* survey the state-of-the-art routing metrics for CRNs. The problem of reliability of a multi-hop, and multi-channel CRN is investigated also by Pal *et al.* in [4]. In such a scenario, to support multi-link operations and networking functions, traditional spectrum sensing is not enough, and there is the need of developing a CR tomography to meet the general needs of networking operations. This topic has also been investigated by Kai-Yu in [5]. Well-designed multi-hop CRNs can provide high bandwidth efficiency by using dynamic spectrum access technologies, as well as provide extended coverage and ubiquitous connectivity for end users. Before Cognitive Radio approaches, a better usage of the underused spectrum bandwidth was obtained by focusing on the scheduler at Medium Access Level (MAC) as showed in [89] and [90], that were supposed to improve the assignment of the time slots for each user. The advent of Cognitive Radio represents a new open research direction that presents specific challenges and issues.

In [7], Sengupta and Subbalakshmi survey unique challenges and open research issues in the design of multi-hop CRNs *i.e.*, they focus on the MAC and network layers of the multi-hop CR protocol stack. They investigate the issues related to efficient spectrum sharing, optimal relay node selection, interference mitigation, end-to-end delay, and many others. As an instance, the concept of spectrum sharing represents an effective method to fix the spectrum scarcity problem. Indeed, spectrum-sharing solutions allow unlicensed users to coexist with licensed users, under the condition of protecting the latter from interference. In [5], Stotas and Nallanathan investigate the throughput maximization in spectrum sharing CRNs by introducing a novel receiver and frame structure, and then deriving the optimal power allocation strategy that maximizes the capacity of the proposed CR system.

Another survey on recent advances in CR is presented by Wang *et al.* in [8], while Naeem *et al.* [9] present the issue and suitable solutions for efficient resource allocation in cooperative CRNs, in order to meet the challenges of future wireless networks. The authors in [9] also highlight the use of power control, cooperation types, network configurations, and decision types used in cooperative CRNs.

The integration of the SDR capabilities and the CR paradigm in Wireless Sensor Networks (WSNs) is an active research field that is attracting attention from various parts. This increasing interest of integration of the SDR and WSNs mainly relies on the potential advantages that can derive. First of all, by integrating the SDR into WSN, and considering the same hardware, it is possible to have more standards. Also reprogramming the sensor nodes rather than the hardware and circuits will drastically reduce the design time. The same reasoning can be applied to the integration of the SDR capabilities and the Cognitive Radio paradigm in the Wireless Body Area Networks.

This chapter is mainly devoted to the description of the main contribution about the integration of the SDR and CR into the WSNs, and WBANs, respectively. After a general description of the key features deriving from the integration, we provide some insights on the modeling aspects and the simulation tools that are mostly considered and exploited in both contexts of WSNs and WBANs. The last contribution considers the routing approaches by highlighting the main differences among traditional approaches applied to both Wireless Sensor Networks and Wireless Body Area Networks, and routing techniques based on SDR and CR paradigms.

For the sake of clarity, in the following Table 1 we enclose a list of main acronyms used in the chapter.

Table 1. List of acronyms used in the book chapter.

Acronym	Definition
ACQUIRE	Active Query Forwarding in Sensor Networks
AMC	Automatic Modulation Schemes
AWGN	Additive White Gaussian Noise
BAN	Body Area Networks
BNC	Body Network Controller
CR	Cognitive Radio
CRCN	Cognitive Radio Cognitive Network
CRN	Cognitive Radio Network
CRSN	CR Sensor Node
CWBAN	Cognitive Wireless Body Area Network
CWSN	Cognitive Wireless Sensor Network
MAC	Medium Access Control
MBAN	Medical Body Area Networks
MEMS	Micro-Electro Mechanical Systems
MICS	Medical Implant Communications Service
PU	Primary User
QoS	Quality-of-Service
RF	Radio Frequency
SDR	Software Defined Radio
SPIN	Sensor Protocol for Information via Negotiation
SU	Secondary User
WBAN	Wireless Body Area Network
WMTS	Wireless Medical Telemetry Service
WPAN	Wireless Personal Area Network
WSN	Wireless Sensor Network

WBSN	Wireless Body Sensor Network
------	------------------------------

Cognitive Wireless Sensor Networks and Cognitive Wireless Body Area Networks

In this section we introduce the basic concepts of Cognitive Wireless Sensor Networks (CWSN), and Cognitive Wireless Body Area Networks (CWBAN), from traditional wireless sensor and body area networks, where the concept of cognition is applied to the definition of routing protocols for such specific networks. We observe how adding cognition to the existing Wireless Sensor Networks brings many benefits, and highlight the main differences between traditional WSN/BAN and CWSN/CWBAN.

The following subsections present an overview of CWSNs, and CWBANs, respectively, and then discuss the emerging topics and recent challenges in such areas.

Cognitive Wireless Sensor Networks

Nowadays, the increasing demand for wireless communications represents a challenge for efficient spectrum utilization. To address this challenge, CR has emerged as a key technology, which enables opportunistic access to the spectrum. A CR is an intelligent wireless communication system that is aware of its surrounding environment and adapts accordingly its internal parameters to achieve reliable and efficient communications [1]. Following an opportunistic manner, CR enables unlicensed (*secondary*) users to exploit the spectrum allocated to licensed (*primary*) users. As a consequence, innovative and energy efficient MAC and routing protocols must be implemented to improve the coexistence between different users, as well as managing the scarce resources in an efficient way without degrading primary user communication performances.

Moreover, the next generation of CR networks will be supplied by renewable energy from natural resources, such as solar, wind and Radio Frequency (RF) energy. This energy could be used overnight to increase the battery charge, or to prevent power leakage. In a hazardous situation, if a battery or a solar-collector/battery package completely fails, harvested energy from radio waves can enable the system to transmit a wireless distress signal, whilst potentially maintaining critical functionalities.

Finally, in future applications [2] such as upcoming smart dust networks, an opportunistic use of spectrum would be inevitable. Smart-dust is a system of many tiny Micro-Electro Mechanical Systems (MEMS), such as sensors, robots, or other devices, that can detect light, temperature, vibration, and so on. They are usually distributed over some area to perform tasks, usually sensing through RF identification. In such a scenario, the growing number of such short range nodes distributed in a region which use different radio technologies at unknown locations cause the spectral environment to be sharply variable, even over short distances and brief time periods. Hence, time limited measurements carried out at a

distance from the local area under study cannot characterize the local conditions [3].

In general, the main aspects of the cognitive network consist in a *behavior-oriented architecture* with agents that have a sensor-based robust behavior with slow rate of processing, distributed control, small size, and inexpensive low power consumption hardware [4]. Since a WSN is comprised of low power consumption devices with limited processor capabilities, cognition should be implemented in such an infrastructure. Today, WSNs is one of the areas with the highest demand for cognitive networking. Traditionally, WSNs have been exploited as enabling technology for Ambient Intelligence [5], and adding cognition capabilities to the existing WSN infrastructure is expected to provide many benefits and advantages such as (i) higher transmission range, (ii) a lower number of nodes required to cover a specific area, and (iii) lower energy consumption per bit. Indeed, the higher communication range provides CWSNs with a smaller number of hops per route. This also provides a smaller average end-to-end delay.

The term "cognition" applied to networks refers to the process of making decision and action based on the network conditions in order to achieve end-to-end goals. Specifically, when applied to WSNs [6], cognition can help the network to achieve a better performance by the means of awareness and information sharing in the network. In more detail, when incorporated in sensor networks, cognition will enable achieving two main objectives: (i) to make the network aware of, and dynamically adapt to, application requirements and the environment in which it is deployed, and (ii) to provide a holistic approach to enable the sensor network to achieve its end-to-end goals, i.e. gather information about the network status from network and MAC layers, application requirements from the application layer and achieve the objectives of the network [7].

For the first objective, cognitive WSN nodes should change their transmission and reception parameters according to the radio environment. Cognitive capabilities are based in four technical components: (i) sensing spectrum monitoring, (ii) analysis and environment characterization, (iii) optimization for the best communication strategy based on different constraints i.e., reliability, power consumption, security, etc., (iv) adaptation, and collaboration strategy. Indeed, the cognitive technology will not only provide access to new spectrum but also provide better propagation characteristics. By adaptively changing system parameters like modulation schemes, transmit power, carrier frequency and constellation size, a wide variety of data rates can be achieved. This can improve power consumption, network life and reliability in a WSN.

The ultimate goal is to design WSNs, which are more aware of the concurrent conditions of the network, but above all can make decisions based on the information, and take actions. In [91] Baumgarten and Mulvenna present the potentials and challenges of future sensor networks, and provide the foundations for sensor nodes with self-adapting ambient intelligence. As an instance, CWSN could provide access not only to new spectrum (rather than the worldwide available 2.4 GHz band), but also to the spectrum with better propagation characteristics. A channel decision of lower frequency leads to more advantages in a CWSN such as higher transmission range, fewer sensor nodes required to cover a specific area, and lower energy consumption.

In WSNs, nodes are constrained mainly in terms of battery and computation power, but also in terms of spectrum availability. With cognitive capabilities, WSN could find a free channel in the unlicensed band to transmit or in the licensed band to communicate. A cognitive WSN should be aware of the amount of sensory data being communicated, and know when and where to forward it. The energy available at each node is fed back to determine a maximum average power [4]. In addition, because cognitive sensor networks should have such a high level of knowledge about the environment and the types of information exchanged, they must be application specific.

Cognitive nodes are then designed such that they use the same infrastructure as sensor nodes but are able to handle cognition processes and manage decisions and actions by commanding other nodes. By using cognitive nodes in the network, the performance of the network would be improved, as well as the cost, like the energy consumption and the delay [8]; in particular, the cost added due to cognition will be as low as possible, and can benefit from previous developments in the design of sensor nodes.

Leveraging on all the previous features, we can distinguish some basic differences between WSN and CWSN. In a WSN, each node either sends/receives data, or it is in idle state. Similarly, a CWSN consists of many tiny and inexpensive sensors where each node operates on limited battery energy; moreover, in CWSN there is another state, called *sensing state*, where the sensor nodes sense the spectrum to find spectrum opportunities or spectrum holes. However, among various tasks for each node, the transmission and reception of data are the most energy consuming tasks.

Spectrum sensing task in the CWSN sensing state, can be performed either by a distributed or centralized scheme. In a distributed scheme, each sensor competes with other sensors to access the available spectrum [9], and then it must have the ability to sense the whole channel, and determine an optimal scheme to maximize its benefits, such as the number of transmissions over time. However, due to the fact that CWSN sensor nodes are mostly low-powered with limited capabilities, it may not be feasible to deploy the full functionalities of a distributed scheme in these networks. Thus, in many applications a centralized scheme is preferred, where spectrum opportunities are detected by a single entity called network coordinator [10], [11]. The network coordinator broadcasts a channel switch command to indicate an alternate available channel (*i.e.*, the alternate channel could be another licensed channel or an unlicensed channel in the ISM band). The broadcast message could be retransmitted by multiple nodes, in order to reliably deliver the message. Typically, there exist two traffic load configurations in a CWSN *i.e.*, (i) the regular status report, where each sensor sends regular status update to the coordinator, and (ii) the control commands, where control messages are sent by the coordinator (*e.g.*, in a heat control application, the coordinator sends commands to switch on/off the heaters, thus providing an automatic domotic system).

The presence of a coordinator node is typical of a distributed network architecture. Figure 1 compares a distributed sensing scheme with a centralized method; the main difference is the presence of the spectrum coordinator, as well as the task of spectrum hole information gathering, in the distributed scheme.

Sensor nodes in a CWSN can measure and provide accurate information at various locations within the network. The higher communication range provides CWSNs with the smaller number of hops needed per route. Thus, the average end-to-end delays will be likely to be smaller. In addition, a CWSN could provide access not only to new spectrum (rather than the worldwide available 2.4 GHz band), but also to the spectrum with better propagation characteristics [9]. As an instance, if the transmission power of the secondary user remains the same, its transmission range increases at lower frequencies [12].

Based on all previous highlights, it is expected that CWSNs will be widely used in the future. The performance gains can be obtained at the cost of a slight increase in the protocol complexity, and network control overhead. Table 2 compares WSNs and CWSNs, by means of main features. It follows that CWSN is envisaged as a new concept [3] with many advantages, such as higher transmission range, fewer sensor nodes required to cover a specific area, a better use of the spectrum, lower energy consumption and delays, better communication quality and data reliability, and also a better use of sensing frequency based on the changes in the channel environment. In Table 2 we highlighted the features that represent a strength point for a given technology (e.g., high transmission range is an advantage for CWSNs, while low power complexity is an advantage for WSNs).

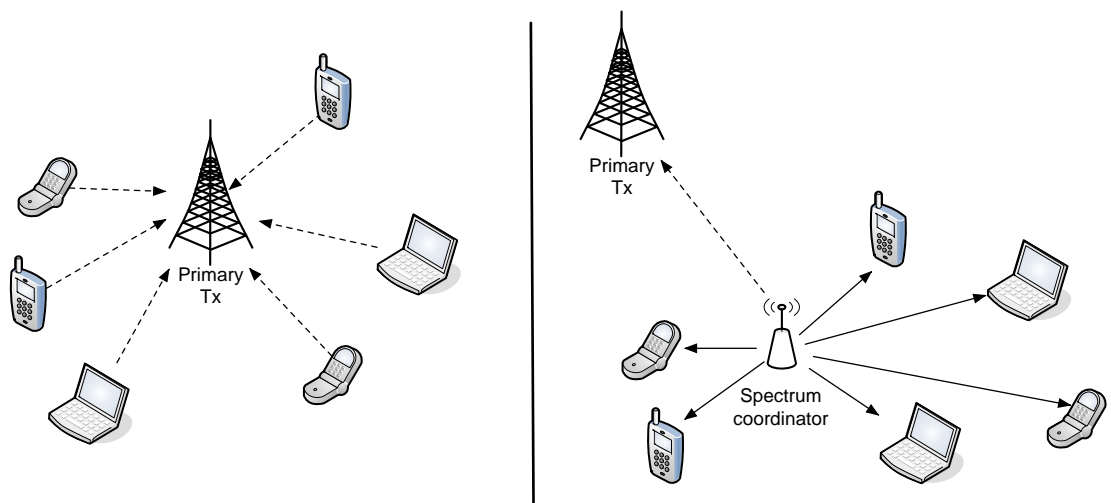

Figure 1. Schematic of (left) centralized, and (right) distributed architecture for Cognitive Wireless Sensor Networks. Nodes perform different tasks *i.e.*, channel sensing (dotted lines), and spectrum hole information gathering (solid lines).

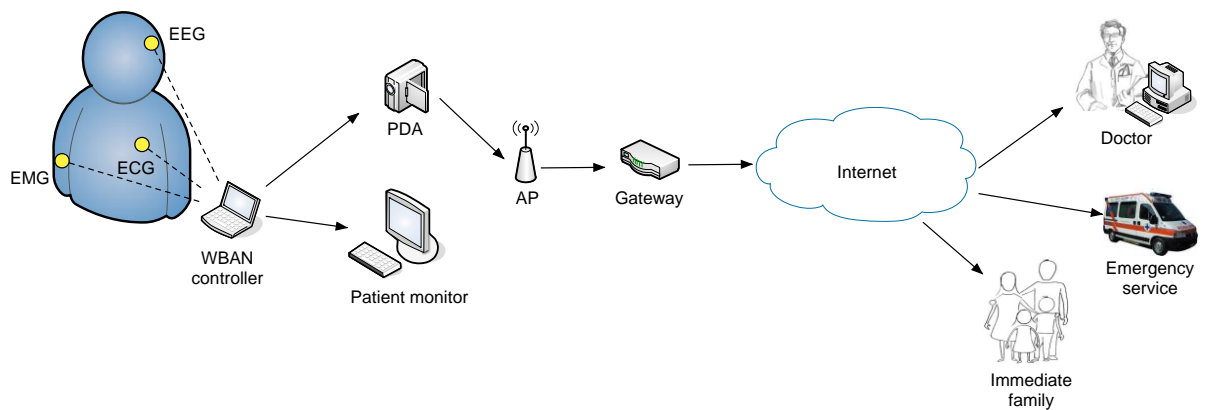

Figure 2. Basic architecture of a telemedicine system.

Table 2. Main features and differences of Wireless Sensor Networks, and Cognitive Wireless Sensor Networks. Gray cells represent an advantage for a given network.

Parameter	WSNs	CWSNs
Transmission range	Lower	Higher
Sensor nodes required	Higher	Lower
Energy consumption	Higher	Lower
End-to-end delay	Higher	Lower
Accuracy of sensing algorithm	Lower	Higher
Protocol complexity	Lower	Higher
Network control overhead	Lower	Higher

Cognitive Wireless Body Area Networks

In this subsection, we investigate how CR technology is applied to future Body Area Networks (BAN). Indeed, CR features are expected to affect BAN, like to supply all the nodes of a BAN without the need of replacement of the primary source of energy (*i.e.*, batteries). At the same time, new cross-layer algorithms are envisaged to adapt to the changes in the transmission link, based on the quality of the received signal, radio interference, radio node density, network topology or traffic demand.

Although many papers [1, 12, 18, 21] have discussed the different facets of CR, just a few works [22, 23, 24] address CR application to medical environments. The most representing scheme of a typical BAN scenario with CR is depicted in Figure 2. A medical BAN (*i.e.*, a WBAN for medical applications) comprises multiple sensor nodes, each of them able of sampling, processing, and communicating one or more vital signals *i.e.*, electroencephalography (EEG), electromyography (EMG), electrocardiography (ECG), etc. This biomedical information is transmitted to a Body Network Controller (BNC) [13], and on the basis of the spectrum availability,

sensor nodes transmit their results from the sensing to the next hops, and eventually to the sink in an opportunistic manner [14].

The recent trend in telemedicine is towards the use of wearable health monitoring devices [13]. This has motivated the standardization of the so-called Wireless Body Area Networks (WBANs) through the IEEE 802.15.6 working group [16]. The IEEE 802.15.6 standardization working group has produced the first draft of a document specifying the physical (PHY) and MAC layer characteristics of the radio interfaces for WBAN applications [15].

The requirements for a wireless communication system to be used in healthcare have been identified in [13] and a CR system has been proposed for a hospital scenario. The proposed system is designed to avoid electromagnetic interference to electronic medical devices, which are considered to be protected users. At the same time, the system guarantees Quality-of-Service (QoS) for different wireless applications.

Some medical applications, namely the Wireless Medical Telemetry Service (WMTS) and the Medical Implant Communications Service (MICS), have been licensed to operate in exclusive parts of the spectrum. Specifically, the 608–614 MHz, 1395–1400 MHz, and 1427–1432 MHz bands are assigned to WMTS, whereas the 402–405 MHz band is for MICS. However, spectrum regulatory policies affect the ability to deploy MBAN technologies on a global scale; nevertheless, they also offer unique opportunities for a CR-based solution.

Regardless of the different spectrum regulatory constraints across the world, several bands designated for medical applications are mostly available on a license-exempt secondary basis. Specifically, UWB technology shows interesting applicability for MBANs. Both the United States and Europe have regulated the parts of the spectrum that can be used by UWB on a license-exempt basis. The band made available in the United States corresponds to 3.1–10.6 GHz, whereas in Europe two spectrum segments have been defined, 3.4–4.8 GHz and 6–8.5 GHz.

Analytical Models and Simulations tools for Wireless Sensor Networks based on Software Defined Radio

The combination of the CR paradigm and the WSNs is a promising field of research, since it allows the coexistence of overlapping wireless networks in ISM bands by minimizing the interference [24]. As outlined in [25], the advantages to make an opportunistic usage of the lower frequency in the spectrum in terms of better propagation characteristics, the fact that this type of frequency allows a better penetration to obstacles, makes the CWSNs a very interesting and promising solution to a better management of the spectrum. In Figure 3, we show a general model for a CWSN, where nodes send their readings to the sink via multiple hops in an ad hoc manner. This topology imposes less communication overhead (*i.e.*, control data), but due to the hidden terminal problem, spectrum sensing may result inaccurate.

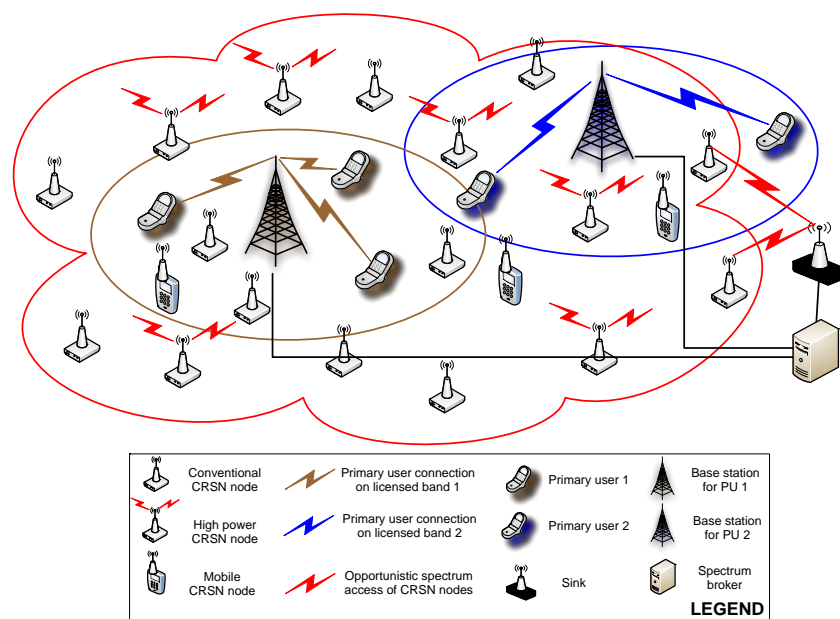

Figure 3. A Cognitive Radio Wireless Sensor Network Model [21].

Analytical Models

In this section we present the main analytical models adopted for the Wireless Sensors Networks by applying the CR paradigm. Fundamentally, we can notice two main classes of models *i.e.*, (i) Queuing Traffic Modeling, and (ii) Topology Modeling.

Queuing Traffic Modeling

Generally, the modeling approaches related to the CR-based Wireless Sensor Networks, regard Primary Users (PUs) and Secondary Users (SUs) modeling traffic. In [18], Zhang *et al.* model the hierarchical structures, by considering the secondary user as a relaying terminal for assisting primary communication. They present a system model of the cooperative CRNs, and in order to evaluate the effectiveness of the cooperation on their system, they also consider a non-cooperative model based on priority queuing system. The M/G/1 priority queuing system proposed for the cognitive radio network allows the evaluation of the performance in terms of delay and throughput for each user. At this modeling they add the cooperative diversity and show the effectiveness of the cooperation on the secondary user throughput. Another user model has been presented in [19], where the authors focus on the waiting time analysis in a time slotted system. CR is modeled by considering a priority queuing and arrival of the packets is modeled as a modified M/D/1 system. Gao and Jiang in [20] also take account of the errors deriving from a non-ideal spectrum sensing and model these “imperfections” through a stochastic approach, namely stochastic network calculus. The authors

also consider the retransmission of the packets in their model, by considering three retransmission schemes, such as (i) without retransmissions, (ii) retransmission until success, and (iii) maximum-N-time retransmissions. By using the stochastic network calculus, they show expressions for backlog and delay bounds and their results could be exploited to design efficient retransmission schemes in CR based WSNs.

Topology Modeling

In Figure 4 we show two possible topologies that can be figured out for CR based WSNs. How to model the deployment in this type of network is maybe more important than in a "traditional" CRNs, since CWSNs are prone to change more frequently than CRNs. Just to provide an example, the main difference between the hardware structure of a classical sensor and a CR Sensor Node (CRSN) is represented by the cognitive radio transceiver. Indeed, a CRSN is able to dynamically adapt the communication parameters, such as carrier frequency, transmission power, and modulation.

In [21], Akan *et al.* propose four different types of topologies, namely (i) Ad Hoc CWSNs, (ii) Clustered CWSNs, (iii) Heterogeneous and Hierarchical CWSNs, and (iv) Mobile CWSNs. They outline that, despite the increased challenges and complexity, the last two types of topologies, due to the heterogeneity and the mobility aspects, can be very effective and beneficial for increasing the potentiality of the network. In fact, either the presence of more powerful devices, or the possibility to move some devices towards a specific and useful position, can be exploited to increase the lifetime of the whole network, by decreasing the energy consumption.

Figure 4 (a) describes a clustered CWSN topology, where there is a common channel to exchange various control data, such as spectrum sensing results, spectrum allocation data, neighbor discovery, and maintenance information. This type of topology is an appropriate choice for effective dynamic spectrum management, with a local common control channel approach. On the other hand, Figure 4 (b) depicts the architecture for heterogeneous and hierarchical CWSN, which incorporates special nodes (*i.e.*, actor nodes) equipped with renewable power sources, and acting additional tasks like local spectrum bargaining.

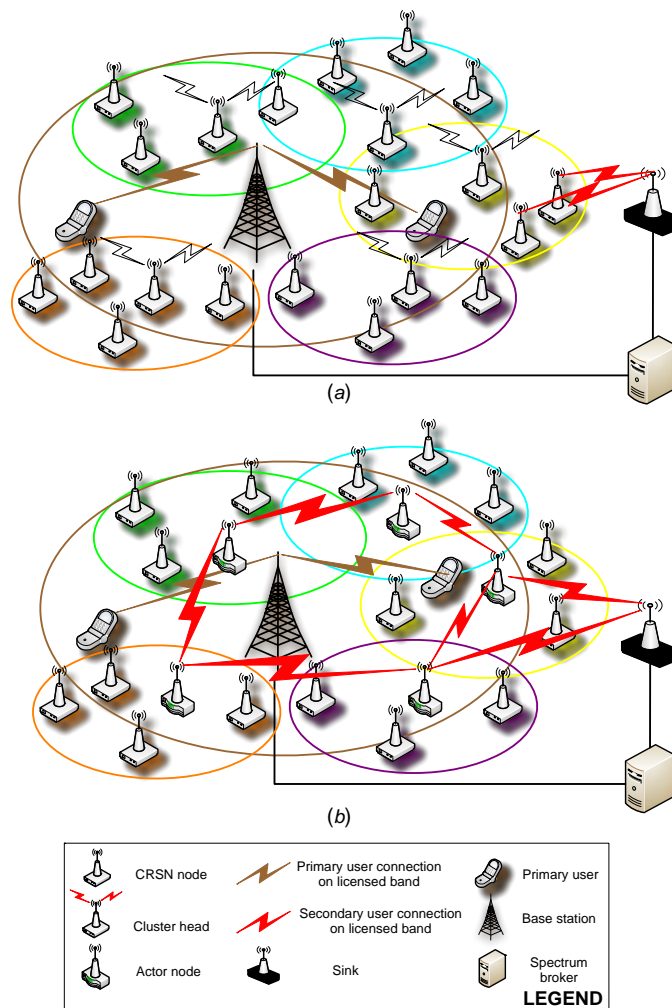

Figure 4. Two possible topologies for CR based WSNs *i.e.*, (a) clustered, and (b) heterogeneous and hierarchical CWSNs, [21].

Simulation Tools

In this section, we present the main simulation tools that have been used to implement the SDR paradigm in the context of Wireless Sensor Networks.

Software Defined Radio as simulation tool

Firstly, in this section we consider the matter of Link Quality estimation, and control in a Wireless Sensor Network, and the possibility to exploit the SDR paradigm to make that in a very effective and efficient way, as shown in [17]. In this case, the authors have built an IEEE 802.15.4 physical layer communication connection based on SDR, and then used it as a kind of spectrum analyzer. The authors simulated three different types of link quality metrics and performed

simulations by considering four most common radio environments *i.e.*, (i) clean channel, with no interference and a low level of thermal noise, (ii) Additive White Gaussian Noise (AWGN), that represents the most common channel model considered in wireless systems, (iii) In-band noise system, where a noise with a spectrum similar to the spectrum of the signal is considered as additional noise, and (iv) Adjacent channel interference, where two sensor nodes transmitting simultaneously on adjacent channels can interfere to each other. The authors envisage a very interesting potential future research based on the novel link quality estimation method they proposed they obtained, that consists in modeling various types of channels.

Monte Carlo Simulation

In [19], Suliman and Lehtomaki introduce two types of errors, namely false alarms and missed detections and evaluate their impact on the system performance by considering Monte Carlo simulations. Through the simulation tool, the authors were able to show the match with the analytical results. In [22], Marković and Dukić consider Monte Carlo simulations to study and evaluate Automatic Modulation Schemes (AMC) in terms of average probability of correct classification. They conclude that the cooperative based schemes are able to reach larger gains than classical AMC schemes. In [23] Ho *et al.* propose a Sensor Network Controlled Indoor Cognitive Radio system. This system is conceived to make the SUs able to access the licensed spectrum inside a building, located in a space where SUs are excluded. The authors considered Monte Carlo simulation to show the effectiveness of the system in terms of control the outdoor interference caused by unlicensed access of indoors users.

OPNET

Many researchers make use of OPNET as simulation tool to test their proposals in the context of CR based WSNs in which the standard ZigBee/802.15.4 model is available. Cavalcanti *et al.* [26] leverage on this model and built an enhanced CR mode on the ZigBee/802.15.4 protocol stack. The authors aim to analyze and study the performance of a CWSN considered for specific applications, and compare their performance with a standard WSN based on the ZigBee/802.15.4 paradigm. In their work they show, by means of simulation results, that the application of the CR to the WSNs can reduce the number of hops required to route packets, by allowing a decrease in terms of energy expenditure and improving the network lifetime. These results derive from the fact that the authors obtained that by using the same transmission power, the transmission range of 680 MHz UHF TV band frequency doubles that of 2.4 GHz.

Cognitive Wireless Sensor Network Simulator [28]

The Cognitive Wireless Sensor Network simulator is based on Castalia [76], and OMNET++ [77]. The main advantage of this kind of simulator is that the physical and MAC layers are realistic. The authors added explicitly the difference between

PUs, and SUs. In Figure 5 the Castalia cognitive radio module is shown. This module is composed from four main elements *i.e.*, a repository, an optimizer, a policy, and an executor. The Virtual Control Channel (VCC) element represents the access interface. The authors showed the effectiveness of this new simulation tool to validate and test new schemes and optimization mechanism.

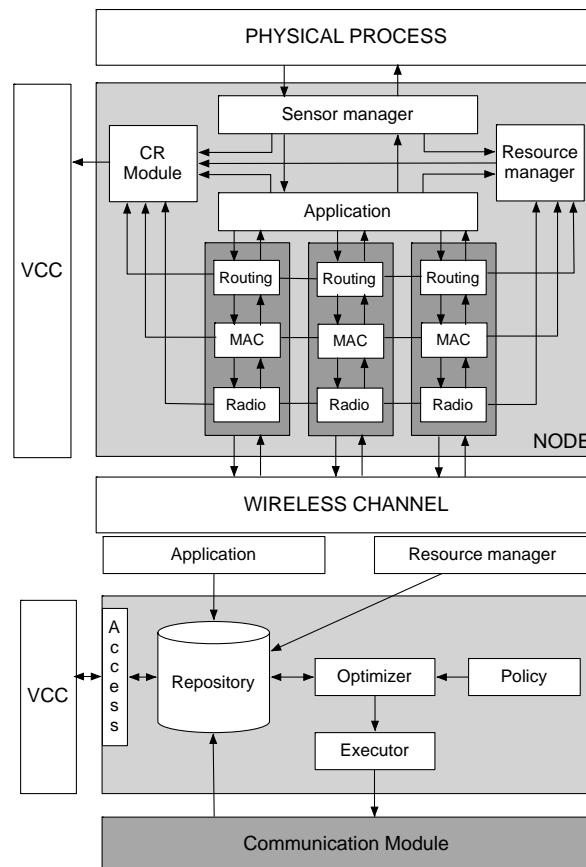

Figure 5. Castalia Cognitive Radio Module.

MATLAB and Network Simulator 2 Simulation

Another very common simulation tool in the wireless scientific community is the Network Simulator 2 (NS-2). The version 2.31 of NS-2 incorporated the Cognitive Radio Cognitive Network (CRCN) [29]. In [25] Oey *et al.* used MATLAB to analyze the metrics when they have to evaluate their analytical model. In the same contribution, the authors propose a routing approach based on cognitive radio for WSNs to make an efficient usage of the energy, named Energy and Cognitive radio aware Routing (ECR). The simulation results show that they are able to obtain better results in terms of lifetime and throughput compared to AODV. In this work the authors envisage the main issues related to the integration of the CR paradigm

in WSNs, namely: (i) enabling dynamic spectrum access implies a joint node-channel assignment, and (ii) energy consumption in hardware constrained networks.

Finally, a recent work by Al-Ali and Chowdhury [35] proposes a framework for CRs in Network Simulator 3 (NS-3). The authors introduce several CR capabilities, such as spectrum sensing, primary user detection, and spectrum hand-off. Compared to NS-2, the simulator in [35] demonstrates improvements in execution time and memory usage.

FREVO

FREVO [35] is an open source simulation tool. In [34], the authors propose to compute the best modulation schemes for fixed/mobile devices equipped with SDR capabilities by implementing a multi-objective and distributed Neural/Genetic algorithm. The objectives that nodes have to achieve are multiple and in some way opposite, namely a better coverage of a specific sensing field and connectivity with a central node that plays the role of sink. In [34] the authors show the potential of mobile SDR communication sensors both from operation flexibility and dynamical reconfiguration. The use of the FREVO framework allowed the developing of a simulator for evolutionary design, and the strategy considered has been validated in different scenarios, by varying the number of nodes supporting the SDR capabilities and the number of nodes equipped with mobility capabilities. The use of SDR capabilities is envisaged as the possibility to form self-evolving wireless networks able to support high data rate and connectivity in various communication scenarios. In Figure 6, we show a mobile node supporting SDR capabilities.

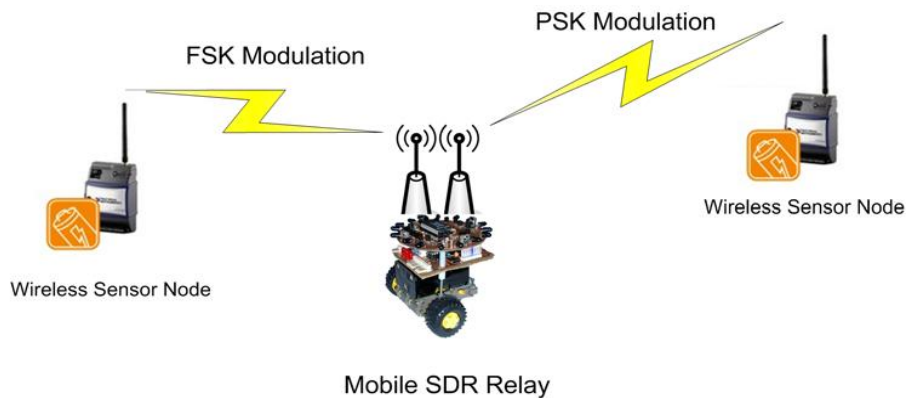

Figure 6. Mobile nodes supporting Software Defined Radio capabilities.

In the following Figure 7 we show that several modulation/demodulation software blocks can be developed within the generic SDR architecture for both transmitter and receiver. In this way, more powerful devices, able to support the dynamic modulation changing can be considered.

Analytical Models and Simulations tools for Wireless Body Area Networks based on Software Defined Radio

Wireless Body Area Network is a new and intriguing concept that is gaining more and more interest. The possibility to include CR approaches in WBAN architecture represents a really recent and hot topic research field. In [30] Wang *et al.* specify the application of the Cognitive Radio to the Medical Body Area Networks (MBANS) as a new and emerging cognitive radio application.

In the following subsections, we present the contributions that can be found in literature by distinguishing them from a modeling point of view and from a simulation point of view.

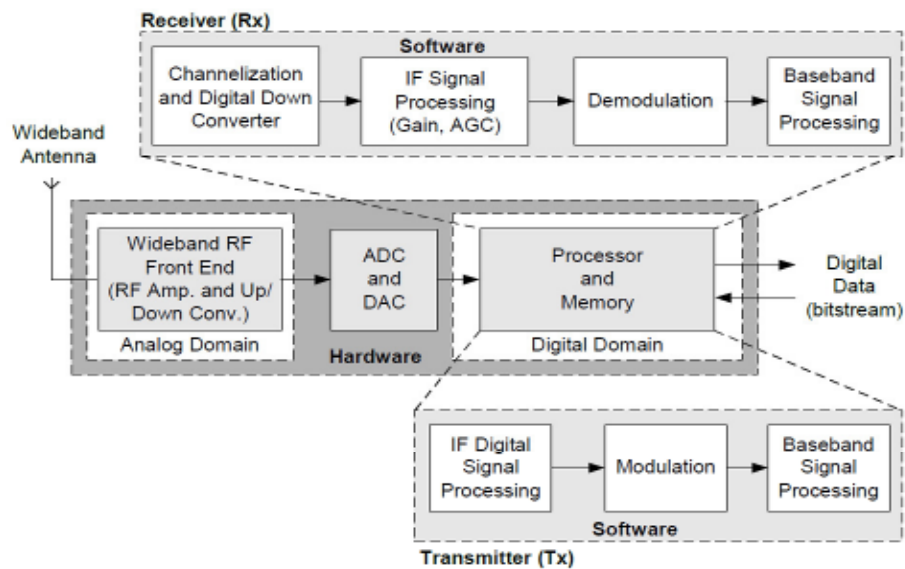

Figure 7. Software Defined Architecture for a sensor node [75].

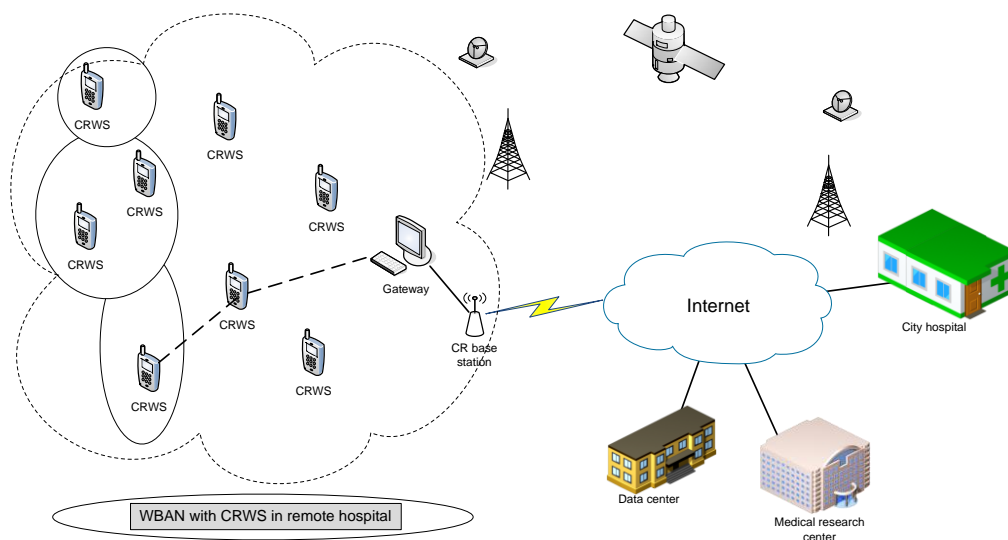

Figure 8. A model of Wireless Body Area Networks with Cognitive Wireless Sensor Networks.

Analytical Models

The possibility to exploit the CR paradigm in an effective way when applied to WBANs is a fervent research topic from some time, but in the last few years, it is acquiring more and more interest. In [31] Joshi *et al.* show a model of WBAN with the CWSNs, as well depicted in Figure 8.

Channel Modeling

One of the most important and crucial aspects of the CR-based WBANs is the statistical characterization and modeling of the channel. Indeed, in April 2009, the channel modeling subcommittee of the IEEE 802.15 task group 6 (TG6) worked on channel models of wireless body area networks, by focusing on in-body and on-body communications [72]. In order to exploit the Cognitive Radio paradigm in the context of Wireless Body Area Networks, a correct channel modeling is a fundamental prerequisite. A very useful contribution is represented by [73], where the authors present various channel models developed at the Centre for Wireless Communications (CWC) in Finland. Specifically, the authors focus on two WBAN channel models. Another interesting contribution in terms of channel modeling for UWB WBAN with Finite Integration Technique (FIT) is given in [74]. The interesting conclusion achieved in [74], is that FIT is individuated as a promising technique to model a realistic on-off body communications channel, in the case where no analytical model is available.

In [32], a different perspective of the channel modeling problem is presented. Cotton and Scanlon propose a modeling of an indoor radio channel for Wireless Personal Area Networks (WPANs). From the measurements performed, they

established that at the specific frequency 868 MHz, the Nakagami- m distribution presents the best propagation behavior in all the environments they considered.

Configurations Modeling

Fundamentally we can consider two main configuration models in the context of CR-based WBANs: Centralized and Distributed. Both models present their advantages. In the Centralized configuration, sensors are physically tethered to the sensor interface and this allows the relief of some of the concerns with communication and power. In this case, scheduling is not required and this makes the delivery of data packets easier and more effective. In a Distributed model, the communication and power components are present on each distributed node. For sure, this type of configuration is more "open" to the integration of additional devices/sensors, by presenting a higher level of scalability. This type of configuration model is really useful to meet the patient needs and risk level.

Simulation Tools

OPNET and MATLAB

In [33] Çalhan and Atmaca propose a new Network Coordinator Node design for the selection of the most suitable technology among those available, both in indoor and out-door applications. The performance evaluation of the selection mechanism is realized through OPNET Modeler, and the implementation of the fuzzy logic based algorithm incorporated into the NCN has been realized in MATLAB. The authors compared their approach with some more "traditional" approach based on the Received Signal Strength Indicator (RSSI), and showed how in an RSSI-based AP selection algorithm, where the value of RSSI is the only parameter used to make the selection, the results can be sometimes misleading. In [73] the authors use MATLAB to develop a simulation tool to evaluate the performances of two single-band Ultra Wide Band (UWB) systems, *i.e.* Direct-Sequence UWB (DS-UWB) and UWB Frequency-Modulation (UWB-FM). Their work is relevant since they were able to show that the choice of the channel model plays a crucial role in the performance of the system.

Routing Approaches for Wireless Cognitive Sensor Networks

In this section, we address on the routing techniques that have been specifically studied for CWSNs, and we focus on the most common simulation tools that have been considered to evaluate their performance. We start with a rapid excursus on the routing protocols that have been proposed for the "traditional" WSNs, by outlining the main simulator used for this type of networks. Then, we introduce the relatively new concept of WBANs and the routing approaches related to and the simulation tools mostly used for their performance evaluation. Finally, we try to outline the necessity to define and study new effective solutions in terms of

routing for the CR based WSNs and we present the main simulators that have been considered also in this case. We conclude this part of the chapter with a dissertation of the CR paradigm applied to the Wireless Body Area Networks.

Traditional Routing Techniques and Simulators adopted

Networking is an important functionality of WSNs. Networking enables WSN to transmit the sensed information to a central device for monitoring, and decision making. Classical IP-based routing techniques could not be utilized in most of the sensor networks due to the sheer number of the nodes. Hence, a decentralized routing system must be exploited to efficiently route to the designated sink.

Flooding is a simple classical solution to disseminate information through the network [36], [37]. In flooding every node will re-transmit every newly received packet to all its neighbors until the packet reaches the destination or the maximum number of hops allowed. In this way, the information is spread through the network without any networking overhead. However, flooding causes significant energy waste in large networks due to unnecessary packet forwarding and duplicate receptions [38]. In gossiping, nodes avoid this problem by randomly choosing a neighbor to disseminate the information. Although gossiping solves the duplicate transmission problem, it increases the average delay in data delivery in large networks significantly.

In general, routing solutions for wireless sensor networks are application dependent *i.e.*, there is no unique protocol that could be used for any WSN application. Here we discuss three main classes, data centric, heretical and geographical briefly and describe modeling and simulation approaches used for each protocol.

Data Centric

The first class includes the data centric protocols. Data centric protocols are query based and generally use data labeling to address data. Neighbor nodes aggregate the received data with their own and transmit to the next hop [37]. Routing can be advertisement based as in Sensor Protocol for Information via Negotiation (SPIN) [38], where nodes advertise for their information by transmitting a description of their data. Nodes that are interested will request and receive the data. The authors have compared SPIN with gossiping and flooding by extending the functionality of NS-2 software package. They have shown that SPIN can perform better than gossiping in terms of throughput while has equal performance with flooding but with less energy consumption. Reportedly, SPIN can save more energy than flooding by avoiding unnecessary transmissions by a factor of 3.5 and halves the redundant data. However, it does not guarantee data delivery in larger network as the middle nodes may not be interested in the data of the faraway nodes and hence do not route it to the sink. Directed Diffusion [39] is a query-based protocol where a query is flooded in the network by the sink where multiple routes are established between the sink and source. The sink reinforces one of the paths and receives data in shorter interval through this reinforced path. Authors in [39] have altered the NS-2 software radio energy model, which is originally designed for

802.11 radio, to analyze the energy consumption of the sensor network using directed diffusion protocol. It is shown that directed diffusion could save energy by choosing the good path. Nevertheless, directed diffusion cannot be applied to the applications that require constant data delivery such as monitoring application. Energy-aware routing [40] argues that using the same minimum energy path will deplete the nodes in this route form energy and hence probabilistically chooses between different existing paths. Simulation results using OPNET show that the energy dissipation is spread over different paths and results in increasing the lifetime of the network by 44% comparing to directed diffusion. In *rumor routing*[41], instead of flooding the network with queries, the source nodes will create long-lived data packets corresponding to certain events called agents and inject them to the network. Agents travel through the network and inform the nodes about the event. If any node is interested in the data it will request it from a node that knows the route. Monte Carlo simulations shows that rumor routing can results in significant energy savings comparing to flooding. However, rumor routing is only applicable when the number of events is small. The energy cost of maintaining the agent when the number of events is large is significant. *Gradient-based routing*[42] defines height of each node as the number of hops to the sink and the difference between the heights of the nodes as gradients. The next hop is chosen as the node with the highest gradient. Numerical simulations show that this scheme can reduce the overall energy comparing to directed diffusion. Active Query Forwarding in Sensor Networks (ACQUIRE) [43] sees the network as a distributed database. The query is generated and transmitted by the sink node. Nodes that receive the query respond by sending their pre-cached information. If the pre-cached information is not up to date, the nodes will request the information from their neighbors. A mathematical model for the energy consumption is provided and the performance of the protocol is evaluated and compared with flooding-based queries. Results show that ACQUIRE can outperform its counterpart.

Hierarchical routing

Hierarchical protocols create clusters of nodes where a cluster head has the task of aggregating data, removing redundancy and to avoid overloading the gateway. Low-Energy Adaptive Clustering Hierarchy (LEACH) [44] forms clusters of nodes in the network and uses the cluster heads to route data to the sink. The cluster heads collect and aggregate the data from the nodes in their cluster before transmitting to the sink. The nodes in a cluster become the cluster head in turn to distribute the energy consumption in the cluster. MATLAB is used to show that LEACH can reduce the energy dissipation by a factor 8 comparing to conventional routing protocols. Power-Efficient Gathering in Sensor Information Systems (PEGASIS) [45] avoids the dynamic clustering overhead of forming clusters as in LEACH by forming a chain of nodes where each node transmits the data to its neighbor and one node will transmit the aggregated data to the sink. Numerical analysis shows that PEGASIS can achieve up to 300% improvement in energy efficiency comparing to LEACH. Hierarchical-PEGASIS [46] decreases the delay incurred by the chain transmission of the information by using concurrent transmission

separated by CDMA or other signal processing techniques. Threshold sensitive Energy Efficient sensor Network protocol (TEEN) [47] is designed for the applications where the sensed attribute changes suddenly. Closer nodes form a cluster with a cluster head. The cluster head in turn form a second level cluster and the process goes on until the sink is reached. Nodes are activated when the sensed attribute passes a hard threshold and report the value when the value changes at least equal to a soft threshold. The hard and soft thresholds are defined by the user and transmitted to the sensor by the cluster heads. NS-2 network simulator with LEACH extension is used to show that TEEN can achieve better energy efficiency than LEACH.

Geographical routing

Geographical routing protocols [37] exploit the location information of the nodes for a more efficient routing of data. Minimum Energy Communication Network (MECN) [48] exploits the fact that transmission through a relay will dissipate much less energy than transmitting directly for a distant node. Each node has the location information of its neighbors and hence can find the most energy efficient path. Mathematical models for the energy consumption, and numerical analysis of the network confirm the energy efficiency advantage of the protocol. Geographic Adaptive Fidelity (GAF) [49] forms a virtual grid for the covered area and activates only one node in every point of the grid. The active node is randomly changed to preserve the energy of the nodes. NS-2 simulations show that GAF can substantially conserve the energy. Geographic and Energy Aware Routing (GEAR) [50] saves the energy by limiting the region in which a certain query is disseminated, which is confirmed by NS-2 simulator. In this merit, it could be considered as a location aware directed diffusion.

Cognitive radio approaches for routing and medium access in generic Wireless Sensor Networks

Wireless sensor networks often use the Industrial, Scientific and Medical (ISM) radio bands for communication since these bands are license free and available globally. However, this comes at a cost. As the band is license free, many other applications use the same band including microwave ovens, cordless phones, RFID devices, Bluetooth technology, etc. This can have catastrophic effects on the performance of the WSN if it shares the spectrum with one or more of these applications due to the high levels of interference.

An interesting solution to this problem is to use licensed band for WSN communications as the secondary user of the band using CR techniques. Studies [51] show that the licensed spectrum is largely under-utilized temporally and spatially. Due to the large number of the nodes in WSN, using a central scheduling system is not the best option. Hence, studies have been mostly focused on decentralized medium access and routing techniques for cognitive radio WSN.

In [52], a cognitive spectrum access method is proposed to optimize the performance of the individual nodes without a centralized scheduling system. The proposed MAC protocol is modeled and analyzed mathematically by Partially

Observable Markov Decision Process (POMDP). It is shown that the best strategy for the secondary user to utilize the spectrum is a policy of POMDP that maximizes the reward function. Finding the optimum policy for POMDP can be computationally prohibitive when the number of accessible channels is large. This is because the number of POMDP states increase exponentially by the number of available channels. Hence, a suboptimal greedy approach is proposed where the statistics of the channels are assumed independent which leads to less complexity of the POMDP. The greedy approach tries to maximize the reward function at each individual time slot. The performance of the suboptimal approach is compared with the optimal protocol using numerical simulations. The results show that the greedy approach has comparable performance with the optimal approach and both have significant improvements over random channel selection. Subsequently, the effect of error in sensing the spectrum is investigated. It is shown that as the percentage of collision with the primary network is relaxed; the performance of the greedy policy in the presence of channel sensing error approaches the optimal policy with no sensing errors.

In [53], an energy-efficient opportunistic spectrum access strategy is proposed for energy harvesting secondary users of the spectrum. The optimum strategy is developed as the solution to a Partially Observable Markov Decision Process (POMDP) as the mathematical model of the spectrum access for the secondary user. In this model, statistics of the primary user's transmission is assumed known. Based on this information and the knowledge of the available energy reserve, the secondary user decides on sensing and transmitting according to the optimum policy of the POMDP model, which aims to maximize the immediate throughput of the secondary user. Numerical simulations are used to show that the optimum policy outperforms the random channel selection in most scenarios.

CR-based routing is studied in [54]. Spectrum Aware Routing Protocol for Cognitive ad-Hoc networks (SEARCH) is proposed which jointly selects path and channel to minimize end-to-end delivery time. NS-2 network simulator is used to compare SEARCH with existing routing protocols. Results show that SEARCH has advantage over other schemes in minimizing the end-to-end delivery time.

Routing techniques for Wireless Body Sensor Networks

One of the most promising applications of the WSN is Wireless Body Sensor Network (WBSN). A wireless body sensor network consists of a network of heterogeneous wireless devices reporting certain physiological data to a Network Coordinator (NC). NC is usually more powerful in terms of computational and energy resources [55], [56], [57]. NC aggregates data received from sensors and transmits the data to a central processing and logging server over an external link. WBSN shares some of the challenges of the generic sensor network. However, unique features of WBSN such as small number of nodes, heterogeneity of the devices connected to the network, and dynamic nature of the human body as the propagation medium, makes it necessary to develop medium access and routing approaches specifically designed for WBSN.

Routing data in body area network has been investigated in literature. Design of a personal gateway for communication with outside networks is investigated in [58]. Narrowband radio is compared with FM-UWB for connecting the sensor nodes in

an on-body network in [59]. Numerical results implemented in OMNET++ discrete event simulator show that FM-UWB outperforms the narrowband radio in terms of energy consumption. In [60], communication between an implanted sensor node and an outside base station is investigated. A MAC layer protocol is provided for a star topology of WBSN, which uses a flexible bandwidth allocation to reduce the energy consumption of the nodes is simulated in [61] by using Open-ZB toolset, and open source implementation of IEEE 802.15.4.

In [62], cooperation between nodes in a multi-BAN network to route data to a sink node belonging to one BAN is studied. A stochastic route selection mechanism based on the maximum perceived outage probability, maximum queue utilization factor, and the remaining battery power information, is provided. The performance of the proposed scheme is assessed through system level simulation and has been shown to outperform random and best route selection schemes. In general, existing routing protocols for WBSN could be assorted into three categories. Some protocols use a star topology. Star topology is the most simple network topology for BAN. In this configuration, communication between sensor nodes and NC is direct or single hop. Direct communication between nodes and network coordinator simplifies the network protocol and reduces packet delivery delay when the link quality is high enough to satisfy the quality of service merit. However, as mentioned above, human body is a dynamic environment. As a result, the topology of the BAN can change drastically by time.

Such variations in the network topology can cause high path loss between the source node and the network coordinator even though the nodes might be very close to each other. Thus, to compensate for the severe attenuation of the signal, transmission power has to be increased proportionally so that the signal reaches the destination with the desired SNR. Nevertheless, increasing transmit power severely affects the energy resources of the nodes and reduces the lifetime of the network. The reason is that, unlike a generic sensor network where nodes are usually similar and can undertake each other's task in case one of them runs out of energy or fails, in a body area network, each node has a specific task which is different from other nodes. Hence, if a node fails the whole network might malfunction.

To avoid increasing transmission power proportional to the path loss, cooperative communication is suggested for WBSNs. In this type of protocols, each node is assigned to a higher-level node. Network coordinator has the highest level. To reach NC, source node transmits its packets to higher-level nodes in a multi-hop scheme until it reaches NC. Based on the number of nodes and network topology, the number of hops can vary between two to several hops. Multi-hop communication is investigated for routing data in BAN [63], [64], [65], [66]. In [63], using extra nodes and cooperation between nodes to relay information to the base is compared with the single hop scheme. The simulation results show that the relay network can greatly improve the lifetime of the network. Network lifetime is defined as the time interval between the time the network starts working to the time in which the first node dies in the network. Numerical analysis shows that in the single hop scheme the nodes with highest distance from the sink will be drained out of energy and die faster while in the multi-hop case the relay nodes closer to the sink have much higher energy consumption due to the traffic they carry.

In [66], performance of non-cooperative communication is compared with cooperative communication in body area network environment. Numerical simulations show that cooperation can reduce energy consumption in higher path loss environment while direct transmission is preferred in lower path loss environment. In addition, it is suggested that prior knowledge of the body posture can improve the energy efficiency. While such protocols provide higher packet delivery success rates and reduce outage probability, they severely increase energy usage of the nodes due to excessive and unnecessary packet retransmissions.

Opportunistic routing is suggested and analyzed for BANs in [67], [68], [69], [70]. In opportunistic routing, each node is assigned to a pre-defined node. During the packet transmission, the relay node assigned to the source node tries to pick up the packet. If the relay receives the packet successfully it would forward it to the destination node (NC) at another session. Numerical analysis has shown that opportunistic routing can improve packet delivery success rate while reducing the outage probability in comparison with direct and multi-hop routing protocols.

Sensor nodes in a body area network must be small and ergonomic. The small dimensions means small antenna size, which in turn translates to higher frequency bands usage. On the other hand, human body is considered a hostile environment in terms of electromagnetic propagation for higher frequencies (*i.e.*, microwave and above). This is because higher frequencies are greatly attenuated inside and in the close vicinity of human body. This means that two on-body nodes may experience very weak connectivity even though they are located in very close proximity. To make everything worse, human body is a dynamic environment. This means that the on-body network topology is changing drastically by time. Such changes could be quite abrupt and can affect the channel severely even between two nearby nodes. Hence, there is a great need for cognitive approaches that can adapt to the changes of the parameters of the environment.

Cognitive Radio based Wireless Body Sensor Networks

A cognitive radio can intelligently use the information about the transmission medium to adapt its parameters and enhance its performance. An example of such adaptive approach for WBSNs is proposed in 81 to improve the energy efficiency of the nodes in the network. The key idea is to adaptively change the routing strategy based on the quality of the channel.

Assume node *A* is an on-body device which has information to transmit to the NC, which is another on-body device with more computational and energy resources. It has the choice to transmit directly or through an on-body relay *R*. Due to the dynamic nature of the human body, channel quality between the nodes changes by time. In the proposed adaptive routing, *A* obtains information on the channel quality through RTS-CTS scheme; *A* transmits a Request-To-Send frame (RTS) to indicate that it has data to transmit and reserve the channel. *NC* will reply by CTS indicating that it is ready to receive the data. Node *A* obtains the channel information Through CTS preamble. If the channel quality is above a certain threshold, *A* transmits directly to *NC*. Otherwise, it will request a relay path by transmitting a Request-To-Relay (RTR). The relay will reply by CTR, and reserve the channel for node *A*, which will transmit its data, and both *R* and *NC* try to

receive the packet. Upon successful reception, both NC and R will transmit an acknowledgement packet (ACK) to indicate the reception of the packet. If relay receives the packet correctly but does not hear any ACK from NC it will retransmit the packet to NC . If A receives no ACK from either R or NC it will retry transmission in another session.

A two dimensional Markov chain model is proposed to model the adaptive protocol and the protocol is mathematically analyzed based on the medium access procedures of the IEEE 802.15.6 standard. Based on the standard, a node can access the medium when the channel is idle for a certain amount of time. To access the medium, the node will initiate a random counter between zero and a maximum window size (W_i) after the idle period, where i is the stage of the counter. The node will transmit when the counter reaches zero. If the channel becomes busy during the count down the counter freezes. In case two or more nodes transmit at the same time collision occurs which results in increasing the counter stage. The maximum windows size doubles every even stage number. The Markov model of the adaptive protocol is depicted in Figure 9, where rows indicate the stage of the counter and columns indicate the state of the counter, m is the maximum number of retries before the packet is discarded, p_b and p_f indicate the probability that the channel is busy, and that of a failed transmission due to collision or unfavorable channel conditions, respectively. The energy consumption model *i.e.*, the energy consumed per bit [J/bit], for node A is derived as follows,

$$E_b^A = \frac{E_{bo}^A + E_o^A + E_r^A + E_s^A}{L}, \quad (1)$$

where E_{bo}^A [J] is the average energy consumed during the back off procedure, E_o^A [J] is the average energy consumed to overhear the on-going communications to assess the transmission opportunity, E_r^A [J] is the average energy consumed for retransmission of a failed data frame, E_s^A [J] is the average energy of transmitting a data frame successfully, and L [bit] is the payload size.

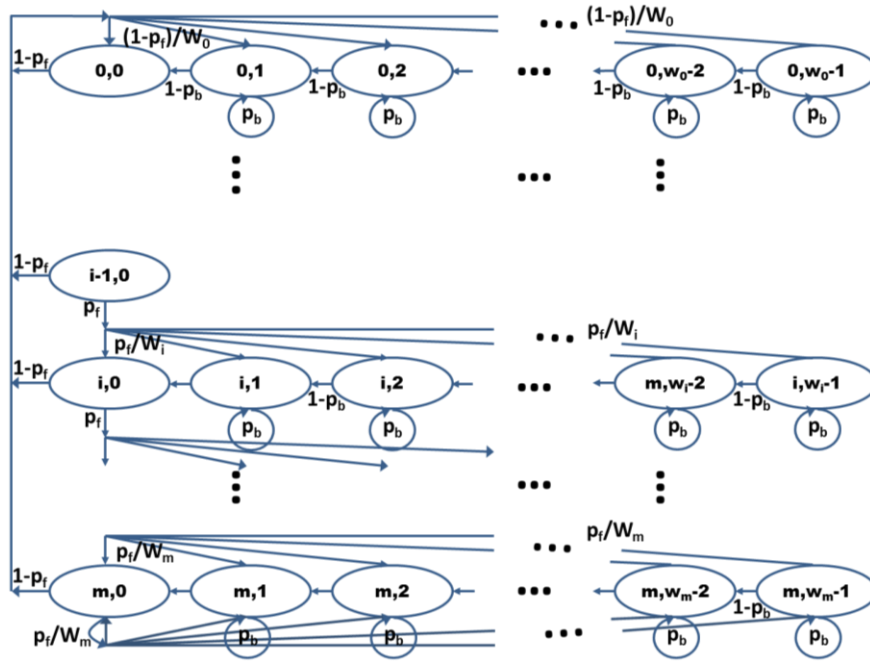

Figure 9: Markov model of the back off procedure. Rows indicate the stage of the back off, while columns represent the state of the back off counter.

The average energy consumption could be derived mathematically based on the Markov chain steady state equations. More details on the derivations are given in [71]. Again, the energy consumption model *i.e.*, the energy consumed per bit [J/bit], for the relay node is as follows,

$$E_b^R = \frac{E_{RX}^R + (1-p_d)(E_{bo}^R + E_o^R + E_r^R + E_s^R)}{L}, \quad (2)$$

where E_{RX}^R [J] is the average energy consumed to receive the packet, and p_d is the probability that the packet is received with errors. Hence, from (1) and (2), the total energy consumed per bit in adaptive routing derives as:

$$E_b^T = E_b^A + p_R E_b^R, \quad (3)$$

where p_R is the probability of using relay.

The analytical model is then validated through MATLAB simulations. Medium access functions and routing procedures are implemented in MATLAB and the results are compared with predictions from mathematical model. Simulation results show that the mathematical model can closely predict the energy consumption of the nodes. In addition, the adaptive routing scheme is compared with fixed direct and relayed transmission schemes provisioned in the IEEE 802.15.6 standard. Results show that adaptive routing can reduce the transmission energy cost per bit by 54% compared to the other schemes.

Future Directions

This section is devoted to summarize the main and key features of the technologies described in the chapter. Moreover, we will try to sketch out some useful directions in terms of research, without pretending to be exhaustive.

The following Table 3 characterizes and summarizes main aspects of WSNs, CWSNs, BANs, and CBANs.

Cognitive radio technologies seem promising for the exponential rise in the demand for bandwidth. However, as remarked in the Table 3, there are still open problems that need to be addressed before such applications could be utilized in practice.

To the follow we detail some of the most significant open problems *i.e.*, spectrum decision, sharing, mobility and handover, and energy efficiency.

Spectrum decision

Spectrum decision strategy is still an open problem in cognitive radio networks. An optimal strategy aims to minimize the delay and energy consumption by selecting the best channel at the right time, in order to access the medium, and transmit data. A promising solution to this problem is to create an accurate model of channel availability rate, and update the model based on the observed data in real-time. This model could be used to make decisions on the optimum channel to access, and transmit data.

Spectrum sharing

Conventional spectrum sharing protocols cannot be applied in cognitive radio setting. This is because the operating frequency is constantly changing according to the observations and the model predictions. Hence, cognitive MAC protocol has to be able to assign transmission time fairly to the nodes operating in the same band. This approach is still broadly under investigation by both academic and industrial communities.

Spectrum mobility and handover

Spectrum mobility and handover mechanism is another open problem in cognitive radio paradigm. To guarantee a seamless communication, hopping to a new frequency band should be handled efficiently by MAC and PHY layer. In other words, the frequency hopping should be invisible to higher layers especially for delay intolerant applications, such as audio and video transmissions.

Energy efficiency

Energy efficiency in cognitive radios is of great importance, as one of the main "users" of the cognitive radio are energy constraint network such as wireless sensor networks. Particularly, cognitive radio systems must be able to sense the spectrum, transmit data and predict the spectrum availability in an energy efficient way. Channel sensing and prioritizing the channels to access should be efficiently implemented in CR protocols, in order to avoid unnecessary energy overhead on CR device. As instance, in [92] Maleki *et al.* present a scheme for minimizing the energy consumed in distributed sensing in a CRN, subject to

constraints on the detection performance. Specifically, they consider the availability of prior knowledge about the probability of primary user presence.

Table 3. Key features of WSNs, CWSNs, BANs, and CBANs.

	WSNs	CWSNs	BANs	CBANs
Standards	IEEE 802.15.4, ZigBee, ISA 100, IEEE 1451	Not yet defined	IEEE 802.15.6	Not yet defined
Hardware Features	Small devices, low processing capacity, low memory capacity	Small Intelligent devices, Cognition capabilities, moderate processing capacity, moderate memory capacity	Low power devices, small devices, low memory capacity	Small Intelligent devices, cognition capabilities
Inter-communication	Normally operates as an autonomous system	Normally operates as an autonomous system	Seldom works alone	Seldom works alone
Interaction with Human Being	Focus on the interaction with the environment	Focus on the interaction with the environment	Very close to the humans	Very close to the humans
x/centric	Generally data/centric	Generally data/centric	Data/user/centric	Data/user/centric
Application Specific	Yes	Yes	Yes	Yes
Routing Type	Broadcast, from/to sink	Broadcast, from/to sink	Broadcast, from/to sink	Broadcast, from/to sink
QoS Parameters	<ul style="list-style-type: none"> • Energy • Scalability • Throughput • Approximation Accuracy 	<ul style="list-style-type: none"> • Energy • Scalability • Approximation Accuracy • Spectrum Efficiency Utilization • Interference to PUs 	<ul style="list-style-type: none"> • Guaranteed Bandwidth • Delay • Jitter • Error Rates • Energy 	<ul style="list-style-type: none"> • Guaranteed Bandwidth • Delay • Jitter • Error Rates • Energy • Spectrum Efficiency Utilization • Interference to PUs
Research Directions	Many areas related to WSNs have been very deeply	Research is still in infancy. Several areas are still to be explored, such as:	QoS handling is a challenge job in BANs. Interesting research direction	QoS handling is a challenge job in BANs. Interesting research direction are

	<p>explored.</p> <p>Among the most critical topics we individuate:</p> <ul style="list-style-type: none"> • Trust and Security • Management of big data 	<ul style="list-style-type: none"> • Spectrum Decision • Spectrum Sharing • Spectrum Mobility and Handover • Energy Efficiency 	<p>are concerning MAC protocol definition and routing approaches.</p>	<p>concerning MAC protocol definition and Routing approaches.</p> <p>Cross-layer techniques to include:</p> <ul style="list-style-type: none"> • QoS • Spectrum Decision • Spectrum Sharing • Spectrum Mobility and Handover • Energy Efficiency
--	---	--	---	---

Conclusions

This chapter focuses on the relatively new notion of software defined and cognitive radio for wireless sensor networks. Specifically, analytical modeling of capacity, energy consumption and congestion for Cognitive Wireless Sensor Networks and Cognitive Wireless Body Area Networks is discussed and evaluated. Moreover, routing approaches and modeling techniques to evaluate the performance of routing for both generic wireless sensor networks and wireless body sensor networks are discussed in details.

Several studies show that cognitive approaches are among the most promising approaches to target higher capacity demand and lower energy consumption for the abovementioned wireless networks. As an example of cognitive solution for future body area networks, adaptive routing scheme for wireless body sensor networks is discussed. The key idea in this approach is to adaptively change the routing strategy based on the quality of the channel.

Mathematical models for the MAC protocol and the energy cost per bit are provided and analyzed based on the medium access procedures of the IEEE 802.15.6. The adaptive scheme is then compared with the existing methods, and it is shown that the adaptive routing can reduce the energy cost of information per bit by 54%. However, there is still a need for more efficient cognitive techniques to sense the spectrum, and exploit this information to increase the quality-of-service in the future wireless sensor networks. Modeling and analysis of these techniques not only provide more insight into the limitations of the system but also lead to more practical and efficient solutions.

Acknowledgment: This work is partially supported by CPERNPdC/FEDER CIA.

References

1. J. Mitola, and G.Q. Jr. Maguire, "Cognitive radio: making software radios more personal," *IEEE Personal Communications*, vol. 6, no. 4, pp. 13-18, Aug 1999.
2. Y. Tawk, J. Costantine, and C.G. Christodoulou, "Cognitive-radio and antenna functionalities: A tutorial [Wireless Corner]," *IEEE Antennas and Propagation Magazine*, vol. 56, no. 1, pp. 231-243, Feb. 2014.
3. M. Youssef, M. Ibrahim, M. Abdelatif, C. Lin, and A.V. Vasilakos, "Routing Metrics of Cognitive Radio Networks: A Survey," *IEEE Communications Surveys & Tutorials*, vol. 16, no. 1, pp. 92-109, First Quarter 2014.
4. R. Pal, D. Idris, K. Pasari, and N. Prasad, "Characterizing reliability in cognitive radio networks," in *Proc. of First International Symposium on Applied Sciences on Biomedical and Communication Technologies*, (ISABEL), vol., no., pp. 1-6, 25-28 Oct. 2008.
5. S. Stotas, and A. Nallanathan, "Enhancing the Capacity of Spectrum Sharing Cognitive Radio Networks," *IEEE Transactions on Vehicular Technology*, vol.60, no.8, pp. 3768-3779, Oct. 2011.
6. C.-K. Yu, K.-C. Chen, and S.-M. Cheng, "Cognitive Radio Network Tomography," *IEEE Transactions on Vehicular Technology*, vol.59, no.4, pp. 1980-1997, May 2010.
7. S. Sengupta, and K.P. Subbalakshmi, "Open research issues in multi-hop cognitive radio networks," *IEEE Communications Magazine*, vol.51, no.4, pp. 168-176, April 2013.
8. B. Wang, and K.J.R. Liu, "Advances in cognitive radio networks: A survey," *IEEE Journal of Selected Topics in Signal Processing*, vol. 5, no. 1, pp. 5-23, Feb. 2011.
9. M. Naeem, A. Anpalagan, M. Jaseemuddin, and D.C. Lee, "Resource Allocation Techniques in Cooperative Cognitive Radio Networks," *IEEE Communications Surveys & Tutorials*, vol. 16, no. 2, pp. 729-744, Second Quarter 2014.
10. J. Mitola, *Cognitive Radio: an Integrated Agent Architecture for Software Defined Radio*, Ph.D. dissertation, Royal Institute of Technology, Stockholm, Sweden, 2000.
11. A.S. Zahmati, S. Hussain, X. Fernando, and A. Grami, "Cognitive Wireless Sensor Networks: Emerging Topics and Recent Challenges," in *Proc. of IEEE International Conference on Science and Technology for Humanity (TIC-STH)*, 2009 Toronto, pp.593-596, September26-27, 2009.
12. N. S. Shankar, C. Cordeiro, K. Challapali, "Spectrum Agile Radios: Utilization and Sensing Architectures," in *Proc. of 1st IEEE International Symposium on New Frontiers in Dynamic Spectrum Access Networks, DySPAN*, pp. 160-169, November 2005.
13. E. Bidr, and M. Ibnkahla, "Performance Modeling of Cognitive Wireless Sensor Networks Applied to Environmental Protection," in *Proc. of IEEE Global Telecommunications Conference (Globecom)*, Honolulu, December 30-January 4, 2009, Honolulu, Hawaii, USA.
14. G. Vijay, E. Ben Ali Bdira, and M. Ibnkahla, "Cognition in WSNs: a Perspective," *IEEE Sensor Journal*, Vol. 11 Issue 3, March 2011.

15. L. Reznik, and G. Von Pless, "Neural Networks for Cognitive Sensor Networks," in Proc. of IEEE International Joint Conference on Neural Network, IJCNN, pp. 1235–1241, 2008.
16. F. Aalamifar, G. Vijay, P. A. Khozani, and M. Ibnkahla, "Cognitive Wireless Sensor Networks for Highway Safety," in Proc. of ACM DIVANET, 2011.
17. K. Romer, and F. Mattern, "The Design Space of Wireless Sensor Networks," IEEE Wireless Communications, Vol. 11, Issue 6, pp. 54- 61, 2004.
18. D. Cavalcanti, S. Das, W. Jianfeng, and K. Challapali, "Cognitive Radio based Wireless Sensor Networks," in Proc. of 17th International Conference on Computer Communications and Networks (ICCCN), pp. 1–6, August 2008.
19. S. Gao, L. Qian, D. R. Vaman, and Q. Qu, "Energy Efficient Adaptive Modulation in Wireless Cognitive Radio Sensor Networks," in Proc. of IEEE International Conference on Communications 2007 (ICC), pp. 3980–3986, June 2007.
20. S. Byun, I. Balasingham, and X. Liang, "Dynamic Spectrum Allocation in Wireless Cognitive Sensor Networks: Improving Fairness and Energy Efficiency," in Proc. of 68th IEEE Vehicular Technology Conference (VTC), pp. 1–5, September 2008.
21. I. F. Akyildiz, W. Lee, M. C. Vuran, and S. Mohanty, "NeXt Generation/Dynamic Spectrum Access/Cognitive Radio Wireless Networks: A Survey," Computer Networks, vol. 50, pp. 2127-2159, September 2006.
22. P. Punchongharn, E. Hossain, D. Niyato, and S. Camorlinga, "A Cognitive Radio System for E-health Applications in a Hospital Environment," IEEE Wireless Communications, vol. 17, no. 1, pp. 20–28, February 2010.
23. K. S. Kwak, S. Ullah, and N. Ullah, "An Overview of IEEE 802.15.6 standard," in Proc. of 3rd International Symposium of Applied Science and Biomedical and Communication Technologies, Rome, Italy, November 2010.
24. C. Otto, A. Milenkovic, C. Sanders, and E. Jovanov, "System Architecture of a Wireless Body Area Sensor Network for Ubiquitous Health Monitoring," Journal of Mobile Multimedia, vol. 1, no. 4, pp. 307–326, 2006.
25. <http://www.ieee802.org/15/pub/TG6.html>
26. Y. Qin, and Z. He, "A communication Monitor for Wireless Sensor Networks based on Software Defined Radio," SICS Technical Report T2011:03, ISRN: SICS-T-2011/03-SE, January 26, 2011.
27. C. Zhang, X. Wang, and J. Li, "Cooperative Cognitive Radio with Priority Queuing Analysis," in Proc. of IEEE International Conference on Communications (ICC), pp. 4672-4676, 2009.
28. I. Suliman, and J. Lehtomaki, "Queueing Analysis of Opportunistic Access in Cognitive Radios," in Proc. of CogART'09, May 2009, pp. 153–157.
29. Y. Gao, and Y. Jiang, "Performance Analysis of a Cognitive Radio Network with Imperfect Spectrum Sensing," in Proc. of IEEE INFOCOM'10, March 2010, pp. 1–6.
30. O.B. Akan, O.B. Karli, and O. Ergul, "Cognitive Radio Sensor Networks," IEEE Networks, 2009, 23, pp. 34-40.
31. G. B. Marković, and M. L. Dukić, "Cooperative AMC Schemes Using Cumulants with Hard and Soft Decision Fusion," in Proc. of 20th Telecommunications forum TELFOR 2012, Serbia, Belgrade, November 20-22, 2012.

32. M.-J. Ho, S.M. Berber, and K.W. Sowerby, "Sensor Network Controlled Indoor Cognitive Radio Systems," in Proc. of Telecommunication Networks and Applications Conference (ATNAC), 2012 Australasian, vol., no., pp.1-6, November 7-9, 2012.
33. K. L. A. Yau, P. Komisarczuk, and P. D. Teal, "Cognitive Radio-based Wireless Sensor Networks: Conceptual Design and Open Issues," in Proc. of the IEEE 34th Conference on Local Computer Networks (LCN '09), pp. 955-962, October 2009.
34. C. H. W. Oey, I. Christian, and S. Moh, "Energy- and Cognitive-Radio-Aware Routing in Cognitive Radio Sensor Networks," Hindawi Publishing Corporation International Journal of Distributed Sensor Networks Volume 2012, Article ID 636723, 11 pages.
35. A. Al-Ali, and K. R. Chowdhury, "Simulating Dynamic Spectrum Access using ns-3 for Wireless Networks in Smart Environments," IEEE SECON Workshop on Self-Organizing Wireless Access Networks for Smart City, Singapore, June 2014.
36. D. Cavalcanti, S. Das, J. Wang, and K. Challapali, "Cognitive Radio based Wireless Sensor Networks," in Proc. of the 17th International Conference on Computer Communications and Networks (ICCCN), pp. 491-496, August 2008.
37. <http://netlab.boun.edu.tr/opnet.html>, accessed on-line on 06-March-2014.
38. A. Araujo, E. Romero, J. Blesa, and O. N. Taldriz, "Cognitive Wireless Sensor Networks Framework for Green Communications Design", in Proc. of the 2nd International Conference on Advances in Cognitive Radio, COCORA, 2012.
39. J. Zhong and J. Li, Cognitive Radio Cognitive Network Simulator, Michigan Tech University, 2009, <http://stuweb.ee.mtu.edu/~jlialian/>.
40. J. Wang, M. Ghosh, and K. Challapali, "Emerging Cognitive Radio Applications: A Survey," IEEE Communications Magazine, vol.49, no.3, pp.74-81, March 2011.
41. G. P. Joshi, S. Y. Nam, and S. W. Kim, "Cognitive Radio Wireless Sensor Networks: Applications, Challenges and Research Trends," Sensors 2013, 13, pp. 11196-11228.
42. S. L. Cotton, and W. G. Scanlon, "Characterization and Modeling of the Indoor Radio Channel at 868 MHz for a Mobile Bodyworn Wireless Personal Area Network," IEEE Antennas and Wireless Propagation Letters, vol. 6, 2007.
43. A. Çalhan, and S. Atmaca, "A new Network Coordinator Node Design Selecting the Optimum Wireless Technology for Wireless Body Area Networks," KSII Transactions on Internet and Information Systems, vol. 7, no. 5, May 2013.
44. V. Loscrì, P. Pace, and R. Surace, "Multi-objective Evolving Neural Network Supporting SDR Modulations Management," in Proc. of the IEEE 24th International Symposium on Personal, Indoor and Mobile Radio Communications: Mobile and Wireless Networks, PIMRC, 2013.
45. <http://sourceforge.net/p/frevo/wiki/Tutorials/>

46. S. Hedetniemi, and A. Liestman, "A Survey of Gossiping and Broadcasting in Communication Networks," *Networks*, Vol. 18, No. 4, pp. 319-349, 1988.
47. K. Akkaya, and M. Younis, "A Survey on Routing Protocols for Wireless Sensor Networks," *Ad Hoc Networks*, Vol. 3, Issue 3, pp. 325-349, May 2005.
48. W. Heinzelman, J. Kulik, and H. Balakrishnan, "Adaptive Protocols for Information Dissemination in Wireless Sensor Networks," in Proc. of the 5th Annual ACM/IEEE International Conference on Mobile Computing and Networking (MobiCom'99), Seattle, WA, August 1999.
49. C. Intanagonwiwat, R. Govindan, and D. Estrin, "Directed Diffusion: a Scalable and Robust Communication Paradigm for Sensor Networks," in Proc. of the 6th Annual ACM/IEEE International Conference on Mobile Computing and Networking (MobiCom'00), Boston, MA, August 2000.
50. R. Shah, and J. Rabaey, "Energy Aware Routing for Low Energy Ad Hoc Sensor Networks," in Proc. of the IEEE Wireless Communications and Networking Conference (WCNC), Orlando, FL, March 2002.
51. D. Braginsky, and D. Estrin, "Rumor Routing Algorithm for Sensor Networks," in Proc. of the 1st Workshop on Sensor Networks and Applications (WSNA), Atlanta, GA, October 2002.
52. C. Schurgers, and M.B. Srivastava, "Energy Efficient Routing in Wireless Sensor Networks," in Proc. of MILCOM Communications for Network-Centric Operations: Creating the Information Force, McLean, VA, 2001.
53. N. Sadagopan, B. Krishnamachari, and A. Helmy, "The ACQUIRE Mechanism for Efficient Querying in Sensor Networks," in Proc. of the 1st International Workshop on Sensor Network Protocol and Applications, Anchorage, Alaska, May 2003.
54. W. Heinzelman, A. Chandrakasan, and H. Balakrishnan, "Energy-efficient communication protocol for wireless sensor networks," in Proc. of the Hawaii International Conference System Sciences, Hawaii, January 2000.
55. S. Lindsey, and C. S. Raghavendra, "PEGASIS: Power Efficient Gathering in Sensor Information Systems," in Proc. of the IEEE Aerospace Conference, Big Sky, Montana, March 2002.
56. S. Lindsey, C. S. Raghavendra, and K. Sivalingam, "Data Gathering in Sensor Networks using the Energy Delay Metric," in Proc. of the IPDPS Workshop on Issues in Wireless Networks and Mobile Computing, San Francisco, CA, April 2001.
57. A. Manjeshwar, and D. P. Agrawal, "TEEN: A Protocol for Enhanced Efficiency in Wireless Sensor Networks," in Proc. of the 1st International Workshop on Parallel and Distributed Computing Issues in Wireless Networks and Mobile Computing, San Francisco, CA, April 2001.
58. V. Rodoplu, and T.H. Ming, "Minimum Energy Mobile Wireless Networks," *IEEE Journal of Selected Areas in Communications*, Vol. 17, No. 8, pp. 1333-1344, 1999.
59. Y. Xu, J. Heidemann, and D. Estrin, "Geography-informed Energy Conservation for ad hoc Routing," in Proc. of the 7th Annual ACM/IEEE International Conference on Mobile Computing and Networking (MobiCom'01), Rome, Italy, July 2001.
60. Y. Yu, D. Estrin, and R. Govindan, "Geographical and Energy-Aware Routing: A Recursive Data Dissemination Protocol for Wireless Sensor Networks,"

UCLA Computer Science Department Technical Report, UCLA-CSD TR-01-0023, May 2001.

61. FCC, ET Docket No. 03-222 Notice of proposed rule making and order, December 2003.
62. Q. Zhao, L. Tong, A. Swami, and Y. Chen, "Decentralized Cognitive MAC for Opportunistic Spectrum Access in ad hoc Networks: A POMDP framework," *IEEE Journal on Selected Areas in Communications*, 25(3):589-600, 2007.
63. S. Park, S. Lee, B. Kim, D. Hong, and J. Lee, "Energy-efficient Opportunistic Spectrum Access in Cognitive Radio Networks with Energy Harvesting," in *Proc. of the ACM 4th International Conference on Cognitive Radio and Advanced Spectrum Management*, 2011.
64. K. Chowdhury, and M. Di Felice, "SEARCH: A Routing Protocol for Mobile Cognitive Radio ad-Hoc Networks," in *Proc. of IEEE Sarnoff Symposium*, March 30–April 1, 2009.
65. A. Pantelopoulos, and N.G. Bourbakis, "A Survey on Wearable Sensor-based Systems for Health Monitoring and Prognosis," *IEEE Transactions on Systems, Man, and Cybernetics, Part C: Applications and Reviews*, 40(1):1-12, 2010.
66. M. Chen, S. Gonzalez, A. Vasilakos, H. Cao, and V.C.M. Leung, "Body Area Networks: A Survey," *Mobile Networks and Applications*, 16(2):171-193, 2011.
67. B. Latre, B. Braem, I. Moerman, C. Blondia, and P. Demeester, "A Survey on Wireless Body Area Networks," *Wireless Networks*, 17(1):1-18, 2011.
68. C.C. Wang, C.Y. Yang, and C.C. Huang, "Personal Gateway Design for Portable Medical Devices Used in Body Area Networks," *IEEE Digest of Technical Papers International Conference on Consumer Electronics (ICCE)*, 2010, pp. 189-190, 2010.
69. J. Rousselot, and J.D. Decotignie, "Wireless Communication Systems for continuous Multiparameter Health Monitoring," in *Proc. of IEEE International Conference on Ultra-Wideband, ICUWB 2009*, pp. 480-484, 2009.
70. F. F. Forouzandeh, O. A. Mohamed, M. Sawan, and F. Awwad, "TBCD-TDM: Novel Ultra-Low Energy Protocol for Implantable Wireless Body Sensor Networks," in *Proc. of IEEE Global Telecommunications Conference (GLOBECOM)*, pp. 1–6, 2009.
71. G. Fang, and E. Dutkiewicz, "BodyMAC: Energy Efficient TDMA-based MAC Protocol for Wireless Body Area Networks," in *Proc. of the IEEE 9th International Symposium on Communications and Information Technology, ISCIT 2009*, pp. 1455–1459, 2009.
72. K. Ghaboosi, K. Pahlavan, and C.A. Pomalaza-Raez, "A Cooperative Medical Traffic Delivery Mechanism for Multi-Hop Body Area Networks," in *Proc. of the IEEE 22nd International Symposium on Personal Indoor and Mobile Radio Communications (PIMRC)*, pp. 2239–2243, 2011.
73. B. Braem, B. Latre, I. Moerman, C. Blondia, E. Reusens, W. Joseph, L. Martens, and P. Demeester, "The Need for Cooperation and Relaying in Shortrange High Path Loss Sensor Networks," in *Proc. of the IEEE International Conference on Sensor Technologies and Applications, SensorComm 2007*, pp. 566–571, 2007.

74. B. Braem, B. Latre, C. Blondia, I. Moerman, and P. Demeester, "Improving Reliability in Multi-hop Body Sensor Networks," in Proc. of the IEEE 2nd International Conference on Sensor Technologies and Applications (SENSORCOMM), pp. 342–347, 2008.
75. M. Quwaider, and S. Biswas, "On-body Packet Routing Algorithms for Body Sensor Networks," in Proc. of the IEEE 1st International Conference on Networks and Communications (NETCOM), pp. 171–177, 2009.
76. A. Kailas, "Power Allocation Strategies to Minimize Energy Consumption in Wireless Body Area Networks," in Proc. of Annual International Conference of the IEEE In Engineering in Medicine and Biology Society (EMBC), pp. 2204–2207, IEEE, 2011.
77. P. Ferrand, M. Maman, C. Goursaud, J.M. Gorce, and L. Ouvry, "Performance Evaluation of Direct and Cooperative Transmissions in Body Area Networks," *Annals of Telecommunications*, 66(3):213–228, 2011.
78. R. D'Errico, R. Rosini, and M. Maman, "A Performance Evaluation of Cooperative Schemes for On-body Area Networks based on Measured Time-variant Channels," in Proc. of IEEE International Conference on Communications (ICC), pp. 1–5, 2011.
79. J.M. Gorce, C. Goursaud, G. Villemaud, R. D'Errico, and L. Ouvry, "Opportunistic Relaying Protocols for Human Monitoring in BAN," in Proc. of the IEEE 20th International Symposium on Personal, Indoor and Mobile Radio Communications (PIMRC), pp. 732–736, 2009.
80. S. Hara, D. Anzai, K. Yanagihara, K. Takizawa, and K. Hamaguchi, "A Cooperative Transmission Scheme for Real-time Data Gathering in a Wireless Body Area Network," in Proc. of the IEEE 22nd International Symposium on Personal, Indoor and Mobile Radio Communications (PIMRC), pp. 2254–2258, 2011.
81. A. Maskooki, C. B. Soh, E. Gunawan, and K. S. Low, "Adaptive Routing for Dynamic On-Body Wireless Sensors," *IEEE Journal of Biomedical and Health Informatics (IEEE Transactions on Information Technology in Biomedicine)*, no. 99, 2014.
82. K. Y. Yazdandoost and K. Sayrafian-Pour, "Channel Model for Body Area Network (BAN)," doc: IEEE P802.15-08-0780-09-006, April, 2009.
83. H. Viittala, M. Hämäläinen, and J. Linatti, "Impact of Difference in WBAN Channel Models on UWB System Performance," in Proc. of the IEEE 11th International Symposium on Spread Spectrum Techniques and Applications (ISITA), pp.175–180, October 17–20, 2010.
84. M. Särestöniemi, T. Tuovinen, M. Hämäläinen, K. Y. Yazdandoost, and J. Linatti, "Channel Modeling for UWB WBAN on-off Body Communication Link with Finite Integration Technique," in Proc. of the 7th International Conference on Body Area Networks (BodyNets), September 24–26, 2012, Oslo, Norway.
85. E. Marpanaji, B. R. Trilaksono, A. Z.R. Langi, A. Kurniawan, A. Mahendra, and T. Liung, "Experimental Study of DQPSK Modulation on SDR Platform," *ITB Journal of Information and Communication Technology*, vol. 1, No.2, 2007, pp. 84–98.
86. <http://castalia.research.nicta.com.au/index.php/en/>
87. <http://www.omnetpp.org>

88. P.Pace, V. Loscri, "OpenBTS: a step forward in the cognitive direction," in Proc. of 21st IEEE International Conference on Computers Communications and Networks (ICCCN), 2012.
89. V. Loscri, "A queue based dynamic approach for the Coordinated Distributed scheduler of the IEEE 802.16," in Proc. of IEEE Symposium on Computers and Communications (ISCC), 2008.
90. V. Loscri, "A new distributed scheduling scheme for wireless mesh networks," in Proc. of IEEE 18th International Symposium on Personal, Indoor and Mobile Radio Communication (PIMRC), 2007.
91. M. Baumgarten, and M. Mulvenna, "Cognitive sensor networks: Towards self-adapting ambient intelligence for pervasive healthcare," in Proc. of IEEE 5th International Conference on Pervasive Computing Technologies for Healthcare (PervasiveHealth), 2011, pp.366-369, 23-26 May 2011.
92. S. Maleki, A. Pandharipande, and G. Leus, "Energy-Efficient Distributed Spectrum Sensing for Cognitive Sensor Networks," IEEE Sensors Journal, vol.11, no.3, pp.565-573, March 2011.