



HAL
open science

Restoration of grasping functions through assistive orthoses for individuals with arm paralysis

Clément Trotobas

► **To cite this version:**

Clément Trotobas. Restoration of grasping functions through assistive orthoses for individuals with arm paralysis. Automatic Control Engineering. Université de Montpellier, 2023. English. NNT : . tel-04455138v1

HAL Id: tel-04455138

<https://inria.hal.science/tel-04455138v1>

Submitted on 13 Feb 2024 (v1), last revised 15 Mar 2024 (v2)

HAL is a multi-disciplinary open access archive for the deposit and dissemination of scientific research documents, whether they are published or not. The documents may come from teaching and research institutions in France or abroad, or from public or private research centers.

L'archive ouverte pluridisciplinaire **HAL**, est destinée au dépôt et à la diffusion de documents scientifiques de niveau recherche, publiés ou non, émanant des établissements d'enseignement et de recherche français ou étrangers, des laboratoires publics ou privés.



Distributed under a Creative Commons Attribution 4.0 International License

THÈSE POUR OBTENIR LE GRADE DE DOCTEUR DE L'UNIVERSITÉ DE MONTPELLIER

En Systèmes Automatiques et Microélectroniques

École doctorale I2S

Unité de recherche CAMIN

Restoration of grasping functions through assistive orthoses for
individuals with arm paralysis

Présentée par Clément TROTOBAS
le 28 Août 2023

Sous la direction de Christine AZEVEDO
et Andrew MURRAY

Devant le jury composé de

Marie BABEL
Christian DURIEZ
David GASQ
Philippe FRAISSE
Christine AZEVEDO
Andrew MURRAY

Professeure
Directeur de recherche
MCU-PH
Professeur
Directrice de recherche
Professeur

INSA de Rennes
Inria (Lille)
CHU de Toulouse
Université de Montpellier
Inria (Montpellier)
Université de Dayton, Ohio

Rapporteure
Rapporteur
Examineur
Président du jury
Directrice de Thèse
Co-directeur de Thèse



UNIVERSITÉ
DE MONTPELLIER

Contents

1	Introduction	25
1.1	Context and biology basics	26
1.1.1	Motor control	26
1.1.2	Biomechanics of upper limbs	26
1.1.2.a	Muscles and bones of upper limbs	26
1.1.2.b	Upper limbs movements	27
1.1.3	Everyday hand use	28
1.1.3.a	Non-prehensile movements	28
1.1.3.b	Prehensile movements	29
1.2	Paralysis	30
1.2.1	Spinal cord injury	30
1.3	Functional solutions	32
1.3.1	Surgical solutions	32
1.3.2	Assistive technologies	34
1.3.2.a	Assistive hand orthoses	34
1.3.2.b	Functional Electrical Stimulation	36
2	Key grip assistance : Exofinger a low-cost and open source orthosis	39
2.1	Key grip orthosis	39
2.1.1	Key grip basics	39
2.1.2	Existing key grip orthoses	40
2.2	Humanlabs	44
2.2.1	Fab Labs	44

2.2.2	Humanlab philosophy	44
2.2.3	Humanlab Inria	45
2.3	Exofinger, from Fabrikarium to experimental research protocol	46
2.3.1	The event and its preparation	46
2.3.2	Contribution of the thesis	47
2.4	Device	47
2.4.1	Principle	48
2.4.2	Exomotor: control unit	49
2.4.3	Glove	49
2.4.4	Interface modalities	52
2.5	Experimental protocol	53
2.5.1	Participant recruitment	54
2.5.2	Experimental protocol	54
2.5.3	Outcome measures	56
2.6	Results	58
2.6.1	Participants	58
2.6.2	Key grip force	58
2.6.3	Task results	59
2.6.4	Evaluations through questionnaires results	61
2.7	Discussion	63
2.7.1	Perspective for this device	65
2.8	Conclusion	66
3	Power grasp assistance: Grasphyb a hybrid orthosis	69
3.1	Hybrid orthoses	70
3.1.1	Existing upper-limbs hybrid orthoses	70
3.1.2	Expected properties of a hybrid orthosis for assisting power grasp	71
3.2	Components of the hybrid orthosis	72
3.2.1	The mechanical orthosis: Aufratech wrist and hand orthosis	72
3.2.1.a	Mechanical properties	73
3.2.1.b	Limits	73
3.2.1.c	Power source	74
3.2.1.d	Control	74

3.2.2	Vivaltis	74
3.2.2.a	Properties	75
3.2.2.b	Limits	76
3.2.2.c	Control	76
3.2.3	Python controller for the hybrid orthosis	76
3.2.3.a	Principle	76
3.2.3.b	Python API for mechanical orthosis	77
3.2.3.c	State machine cycle and event handler	77
3.2.3.d	GUI and settings	78
3.3	Preliminary experimental validation	80
3.3.1	Purpose	81
3.3.2	Participants	81
3.3.3	Protocol	81
3.3.4	Results	82
3.4	Pilot study	86
3.4.1	Purpose	86
3.4.2	Participant	86
3.4.3	Protocol	86
3.4.4	Results	88
3.4.4.a	Grasp holding and fatigue	88
3.4.4.b	Feedback	89
3.4.5	Discussion	90
3.4.6	Conclusion	92
3.5	Clinical trials	93
3.5.1	Purpose	93
3.5.2	Participants	93
3.5.3	Clinical protocol	94
3.6	Discussion	94
3.6.1	Perspectives	95
3.7	Conclusion	95
4	Kinematic Synthesis of a Spherical Mechanism for Assisting Wrist Pronation and Supination	97

4.1	Forearm pronation and supination	98
4.1.1	Biomechanics	98
4.1.2	Assistive orthoses	99
4.1.3	A spherical mechanism for a prono-supination assistive orthosis	102
4.1.3.a	Suitability as a prono-supination orthosis	105
4.2	Synthesis of the device	105
4.2.1	Synthesis of a single mechanism	105
4.2.2	Coupling mechanisms into a device	108
4.2.2.a	Degrees of Freedom	109
4.2.2.b	Reducing <i>DegreeOfFreedom</i> (DOF) from 3 to 1	110
4.2.3	Determining the transfer function of the mechanism	110
4.3	Toward the design of an orthosis	111
4.3.1	Concept for the orthotic device	112
4.3.2	Prototypes	113
4.3.2.a	Initial prototype	113
4.3.2.b	Mannequin-mounted prototype	114
4.4	Discussion	116
4.4.1	Perspectives	117
4.5	Conclusion	118
5	General Discussion - Conclusion	121
5.1	Discussion	121
5.1.1	Examining choices made	121
5.1.1.a	Assistive orthoses or assistive robots	121
5.1.1.b	Grip assistance choices	122
5.1.1.c	Focusing on a limb or function and not on a more global view	122
5.1.1.d	Evaluation difficulties	123
5.1.2	Customization and accessibility	125
5.1.3	Vision of a generic concept of (hybrid) modular assistive orthosis with soft materials	126
5.1.3.a	Principle	126
5.1.3.b	Hand particularity	128

5.1.3.c	Actuation sizing and cable design through simulation and optimisation	129
5.1.3.d	Control of such modular orthosis	129
5.2	Conclusion	131
Appendices		155
A	Tree diagram for a categorization of upper limb orthosis	156
B	Protocols	161
B.1	Exofinger	161
B.1.a	Flowchart of the Exofinger protocol	161
B.1.b	Ethics committee approval	163
B.1.c	Blank forms	168
B.2	Grasphyb	173
B.2.a	Flowchart of the Grasphyb pilot study protocol	173
B.2.b	Ethics committee approval for preliminary assessments	174
B.2.c	Ethics committee approval for clinical trials	178
B.2.d	Blank forms	183

Les causes d'une paralysie des membres supérieurs peuvent être multiples. La paralysie peut être due à une maladie entraînant un déficit musculaire, comme la myopathie par exemple, ou survenir au cours de la vie. Cela peut être un accident vasculaire cérébral, première cause de handicap dans le monde, ou un accident traumatique médullaire, endommageant la moelle épinière. Près de la moitié des personnes ayant subi un traumatisme médullaire souffrent de tétraplégie à la suite d'un choc violent au niveau des cervicales. Celui-ci intervient dans la plupart des cas au cours d'un accident de la route ou d'une chute.

Le contrôle moteur humain peut se présenter par cette analogie d'ingénierie : le cerveau et la moelle épinière peuvent être considérés comme un système de contrôle, c'est-à-dire *l'intelligence* du corps, les nerfs constituant quant à eux, le système nerveux périphérique qui joue le rôle de transmission de données. Les muscles sont alors les actionneurs et les tendons assurent la transmission de l'énergie mécanique vers les membres.

Une lésion de la moelle épinière entraîne une discontinuité dans la transmission des données. Dans le cas d'une lésion complète, les parties du corps dont les nerfs prennent racine après la lésion, dites infralésionnelles, sont coupées du système nerveux central. Comme les commandes motrices sont émises par le système nerveux central, une lésion médullaire complète entraîne la paralysie des membres infralésionnels. De même, les informations sensibles émises au niveau des de ces membres n'atteignent plus le cerveau, ce qui entraîne une perte globale de sensation.

Il est évident que la faible autonomie dans la réalisation des tâches de la vie quotidienne impacte significativement et négativement la qualité de vie. Ces personnes nécessitent l'assistance d'un tiers presque toute la journée.

Pour des personnes ayant une paralysie des membres supérieurs, des solutions chirurgicales existent et peuvent conduire à une amélioration fonctionnelle, et donc de leur autonomie. Les procédures courantes comprennent les transferts tendineux pour restaurer des mouvements actifs, les opérations de ténodèse pour renforcer l'effet ténodèse, permettant une préhension par l'extension du poignet, et les interventions de stabilisation articulaire. Si peu de muscles sont disponibles, une chirurgie de transfert de nerfs peut être proposée.

Cependant, de nombreux patients ne bénéficient toujours pas de ces chirurgies pour

diverses raisons, notamment d'accessibilité et d'éligibilité. En effet, ces opérations nécessitent des ressources musculaires suffisantes, comme la redondance de muscles puissants ayant une contraction volontaire. De plus le processus détériore les fonctions des muscles, ce qui se traduit par la récupération d'une force souvent limitée. Quelles solutions sont alors disponibles pour améliorer l'autonomie des personnes ayant une paralysie des bras ?

Afin de gagner en capacité fonctionnelle, les personnes paralysées peuvent utiliser des aides techniques. Il existe notamment des adaptations d'objets comme des porte-stylos ou porte-fourchettes. Il s'agit d'outils que les personnes apprennent à utiliser en complément des stratégies compensatoires au cours de la phase de rééducation. Le constat est que la presque totalité des objets du quotidien ont besoin d'être adaptés, et que ces aides techniques sont majoritairement abandonnées. En cause, le gain fonctionnel qui ne dépasse pas le coût de leur utilisation : il est trop lourd au quotidien d'avoir un outil différent pour chaque objet de la vie courante.

Une aide technique permettant de réaliser une fonction plutôt qu'une tâche spécifique a plus de probabilité d'être acceptée sur le long terme.

Parallèlement au développement des prothèses, pour remplacer un membre manquant, les orthèses d'assistance, ont émergé avec l'ambition de répondre à cette problématique.

Si les prothèses ne sont actuellement pas capables de remplacer un bras en termes d'apport fonctionnel, cela est d'autant plus vrai pour les orthèses d'assistance. En effet, il semble que pour réaliser des tâches de la vie courante, le développement d'orthèses pour les personnes ayant un membre déficient est très en moins avancé par rapport au développement de prothèses. Cela peut s'expliquer par la difficulté à réaliser des dispositifs portables acceptables, où la taille, le poids et les besoins en énergie associés sont des facteurs critiques. Alors qu'une prothèse utilise l'espace et le poids du membre manquant, une orthèse s'ajoute forcément au membre déficient, augmentant donc la masse et le volume. Ces critères constituent des défis techniques et scientifiques importants dans la conception d'orthèses efficaces. Même si des recherches significatives sur la conception et l'analyse de nouveaux systèmes mécaniques sont en cours pour aider à répondre à ces défis.

Des études précédentes montrent que les fonctions de saisie sont les premières fonctions que les personnes ayant une tétraplégie souhaitent recouvrir. Cela peut s'expliquer par le fait que les mains sont notre principal moyen d'interagir avec notre environnement et permettent de réaliser la plupart des tâches de la vie courante. Dans le cas d'un traumatisme médullaire, en fonction du niveau de la lésion, les mains peuvent être paralysées mais pas les mouvements plus proximaux comme le coude ou l'épaule.

La présente thèse propose d'explorer des approches de restauration des fonctions de saisie pour des personnes ayant une paralysie des membres supérieurs, notamment dans le contexte de la tétraplégie, grâce à des orthèses d'assistance. Améliorer l'autonomie de ces personnes est essentielle pour améliorer leur qualité de vie.

Afin de répondre à ces attentes, il convient d'envisager une orthèse légère et accessible. La prise de type key-grip, utilisée pour saisir des objets fins entre le pouce et les doigts repliés, nécessite peu de mouvement et peu de force par rapport aux autres types de saisie. En effet, les doigts longs ont seulement besoin d'être fléchis de

manière à ce que la flexion du pouce en abduction puisse plaquer l'objet contre la face latérale de l'index. D'ailleurs, l'effet ténodèse, provoqué par l'extension du poignet, permet de réaliser un key-grip avec peu de force.

Cette thèse a repris le travail, initié dans le cadre du Humanlab Inria, sur une orthèse d'assistance à la flexion du pouce pour assister la key-grip.

Les Humanlabs sont des Fab Labs dédiés à la conception et à la fabrication d'aides techniques pour, et avec, les personnes en situation de handicap. Ces espaces collaboratifs proposent des aides techniques documentées en ligne et réalisables à bas coûts. Les procédés de fabrications nécessaires sont disponibles dans tous les Fab Labs, et ainsi reproductibles et personnalisables par les *makers*. Cette personnalisation est d'autant plus marquée car les personnes concernées portent leur projet et pilotent le processus de fabrication dès la phase de conception.

Le projet Exofinger a été lancé dans le cadre d'un événement de trois jours de type hackaton organisé par le réseau des Humanlabs, rassemblant également l'Inria et ArianeGroup. Le principe de ces événements est de réunir des personnes de différents domaines, chercheurs, ingénieurs, *makers*, autour d'un porteur de projet en situation de handicap. L'équipe de dix personnes a alors trois jours pour proposer une ou plusieurs aides techniques pour répondre à la problématique du porteur de projet. Celui du projet Exofinger a une tétraplégie et souhaitait pouvoir signer des documents grâce à une orthèse d'assistance à la key-grip.

Deux concepts à base de moteurs linaires et de câbles ont été prototypés lors de cet événement. Le développement a été poursuivi par le Humanlab Inria et fait l'objet de ces travaux de thèse.

L'orthèse développée est composée d'un gant adapté en cuir souple et d'un boîtier de commande attaché sur l'avant-bras. Un câble passe du boîtier à travers une gaine jusqu'au gant, puis à travers des gaines à l'intérieur du gant jusqu'au bout du pouce. Par une commande, via un bouton sans fil adapté, le moteur enroule le câble sur une bobine dans le boîtier de commande pour produire la fermeture du pouce. Le gant est conçu pour s'enrouler autour de la main, à la manière des gants de propulsion de fauteuil roulant manuel, de sorte que des mains, disposant de peu de force, puissent le revêtir et l'enlever sans aide extérieure. Le boîtier de commande est composé d'une batterie, d'une carte Adafruit feather nRF52840 express intégrant du Bluetooth Low Energy, d'un driver et d'un petit moteur enroulant, ou déroulant, le câble sur un tambour.

Ce dispositif a initialement été développé pour un individu en particulier en se concentrant sur la réalisation d'une tâche spécifique. Nous avons émis l'hypothèse que ce dispositif, bien que simple dans son concept puisse être utile à d'autres personnes dans la réalisation de diverses tâches de la vie courante.

Dans l'objectif de vérifier cette hypothèse, un protocole expérimental a été établi et des participants avec diverses déficiences motrices des mains, ont été recrutés.

Le protocole consiste à la réalisation de cinq tâches de la vie courante impliquant une saisie en key-grip, répétées trois fois, avec et sans le dispositif. La réalisation de ces tâches a été évaluée et elles ont également été chronométrées. De plus, la force de serrage en key-grip a été mesurée avec et sans Exofinger.

Par ailleurs, comme les aides techniques sont généralement abandonnées, il convient

de se centrer sur les besoins et les attentes des utilisateurs. Des questionnaires et des évaluations ont été proposés aux participants visant à donner un retour sur l'utilisabilité et les fonctionnalités du dispositif. Malgré un apport de force trop faible, les retours des utilisateurs sont prometteurs. Il est d'ailleurs prévu de poursuivre le développement du dispositif au sein du Humanlab Inria. Cette approche atypique d'une aide dédiée à un individu spécifique vers une population plus large s'avère pertinente dans ce contexte. La distribution de ce genre d'aide technique à bas coût permettrait d'accroître l'accessibilité à un gain fonctionnel

Une limite notable d'Exofinger, est la nécessité d'avoir les doigts longs fléchis. Lorsque ce n'est pas le cas, la key-grip est un échec. Il serait envisageable de motoriser la fermeture des doigts longs. Dès lors, le système perdrait l'avantage de portabilité de la key-grip et il serait alors probablement préférable de réaliser un saisis demandant davantage de mouvement.

Les prises cylindriques, ou digito-palmaire, nécessitent la flexion des cinq doigts et permettent de réaliser d'avantage de tâches de la vie courante que ce que le permet une key-grip. En termes de masse et de volume, donc de portabilité, actionner l'intégralité des doigts représente un réel verrou technique. Afin de répondre à ce défi, nous avons proposé une orthèse d'assistance à la prise palmaire utilisant des moteurs ainsi que la stimulation électrique fonctionnelle.

La stimulation électrique permet de provoquer la contraction des muscles innervés y compris ceux situés sous la lésion médullaire et donc paralysés. Il s'agit d'appliquer via des électrodes des trains de faibles impulsions électriques à destination des nerfs, reproduisant de manière plus ou moins grossière les commandes motrices du système nerveux central. La stimulation électrique fonctionnelle est principalement utilisée pour la rééducation, bien qu'elle ait fait ses preuves en tant qu'aide technique. En effet, il est possible de se servir de ces contractions musculaires pour réaliser des tâches diverses. Malheureusement, cette méthode d'activation des muscles, lorsque qu'utilisée via des électrodes de surface collées sur la peau, manque de sélectivité des muscles et les fatigue de manière prématurée. De nouvelles stratégies de stimulation ont émergé et continuent d'être développées afin de contrôler au mieux la stimulation électrique, en jouant sur les paramètres de stimulation (intensité, fréquence, largeur des impulsions, nombre de contact des électrodes...). Une solution pour réduire ces défauts de sélectivité et de fatigue est d'implanter des électrodes directement sur les muscles ou autour des nerfs au cours d'une chirurgie. Pour le contrôle des membres supérieurs, cette méthode a produit des résultats prometteurs et des travaux récents sont en cours, notamment au sein de l'équipe CAMIN.

L'utilisation de la stimulation électrique fonctionnelle permet donc d'utiliser les actionneurs biologiques à partir d'impulsions électriques de faible amplitude. Ces impulsions peuvent être générées par une petite batterie pour induire un mouvement alors qu'un actionneur externe nécessiterait une source d'énergie plus encombrante et lourde. Ainsi, d'un point de vue technique, la stimulation électrique s'impose comme une méthode d'actionnement de choix, en ajoutant une masse et un volume très réduit par rapport aux autres méthodes plus classiques, comme les moteurs électriques et les actionneurs à fluide.

Comme une orthèse d'assistance à la prise cylindrique nécessite une puissance qui

impliquerait une masse et un volume conséquent avec des méthodes d'actionnement traditionnels, nous avons développé une orthèse hybride utilisant des moteurs et la stimulation électrique. L'idée est de générer le mouvement par la stimulation électrique, assistée par de petits moteurs, et de guider le mouvement et verrouiller en position par une action mécanique. L'hypothèse est qu'une telle orthèse hybride permettrait d'améliorer le geste et la durée de préhension en diminuant la fatigue musculaire. Grasphyb, l'orthèse hybride développée au cours de cette thèse, est constituée d'une orthèse mécanique et d'un stimulateur électrique.

Des spécifications ont été rédigées et la conception d'une orthèse mécanique, prévue pour fonctionner de concert avec la stimulation électrique, a été sous-traitée à la startup Aufratech. Il en résulte une orthèse de main et de poignet visant la prise cylindrique. Elle comprend deux moteurs à courant continu avec codeurs incrémentaux, l'un pour l'extension et la flexion du poignet, et l'autre pour la flexion des cinq doigts. L'extension des doigts est assistée par des bandes élastiques situées sur la partie dorsale. Il s'agit d'une orthèse entraînée par câble, ce qui signifie que les moteurs tirent ou relâchent des câbles, à l'image des tendons, et déplacent ainsi les membres. Ces câbles passent par des bagues semi-rigides au niveau des doigts, une par phalange. Les boîtiers ont été imprimés en 3D, renforcés à la fibre de carbone. Les câbles passent dans plusieurs gaines afin de réduire les pertes par friction et suivent le chemin biologique des tendons. Les blocs motoréducteurs ont été dimensionnés pour travailler de concert avec les muscles, ils ne sont donc pas assez puissants pour générer à eux seuls un mouvement. Cela accroît la sécurité d'utilisation et réduit le poids et le volume global.

La conception de l'orthèse mécanique par notre fournisseur n'intégrait pas la partie commande. Un driver moteur L298N a été choisi pour sa robustesse et simplicité et la carte de contrôle est une Adafruit feather nRF52840 express. Son module Bluetooth Low Energy qui pourrait permettre de déporter la partie commande. A ce stade du développement, l'intégration de la partie commande n'est pas nécessaire, notamment puisque l'orthèse mécanique a été conçue pour réaliser des expérimentations et non pour un usage en environnement écologique. L'orthèse développée est alimentée sur secteur. Les moteurs sont contrôlés par un code Arduino utilisant une bibliothèque C++ dédiée.

Le stimulateur sélectionné est le Phenix Neo, il est composé d'une base connectée à un ordinateur et de jusqu'à trois pods de stimulation sans fil. L'orthèse hybride nécessite trois paires d'électrodes de surface, pour l'extension et pour la flexion des doigts longs et pour la flexion du pouce. Chaque pod dispose de deux canaux de stimulation et chaque canal est relié à une paire d'électrodes de surface. Ainsi l'orthèse hybride nécessite deux pods. Ceux-ci communiquent avec leur base via un module Bluetooth dédié connecté à un ordinateur par un protocole de communication série.

Une interface graphique utilisateur multi-thread a été développée en Python. Elle gère la communication avec la carte de contrôle (orthèse mécanique) et la base (stimulateur) via des communications séries. Celle-ci permet de réaliser le paramétrage de l'orthèse hybride et de prendre les commandes. Le contrôleur est une machine à états qui gère l'orthèse ou le stimulateur seul ou les deux ensembles. Il dispose de trois états : neutre, ouverture et fermeture. Les événements sont gérés par l'application Python

et des logs sont générés automatiquement. Un bouton poussoir adapté, qui a été dérivé de celui développé pour Exofinger, a été mis en place pour que le participant déclenche lui-même les changements d'état.

Le fonctionnement du contrôleur de Grasphyb, la cohérence et la faisabilité entre la configuration développée et le protocole clinique conçu ont été validés par des expérimentations avec quatre participants dits valides. Ensuite une étude pilote a été réalisée avec un participant ayant une tétraplégie. Celle-ci semble valider le concept d'orthèse hybride via l'évaluation de tâches fonctionnelles et de questionnaires visant à structurer les retours du participant. L'étude pilote nous a permis de légèrement modifier le protocole et nous encourage à poursuivre l'étude avec une grande population. Afin de vérifier l'hypothèse, une étude clinique est prévue avec des participants tétraplégiques en collaboration avec l'Université Fédérale de Minas Gerais au Brésil.

Au cours des protocoles expérimentaux d'Exofinger et de Grasphyb, certaines tâches n'ont pas pu être réalisées à cause d'un défaut d'orientation de la main par rapport à l'objet à saisir au cours des manipulations. En effet, pour attraper une bouteille il est nécessaire que l'avant-bras soit en position neutre, alors que pour attraper une balle ou un pion, une position de pronation est nécessaire. Les fonctions de saisie nécessitent une prise mais aussi un bon placement et une bonne orientation de la main.

Ceci est d'autant plus important pour les personnes ayant une déficience de la préhension puisqu'ils se servent de la prono-supination comme stratégie compensatoire. En effet, quand cela est possible, ils utilisent la supination pour orienter la paume de main vers le ciel et laisser le poids de l'objet reposer dans celle-ci. Cela permet de limiter l'effort sur les doigts et ainsi porter des objets plus lourds et plus longtemps qu'en position neutre. La prono-supination joue donc un rôle essentiel dans la réalisation des tâches de la vie courante, notamment chez les personnes ayant un handicap des mains.

Pourtant, il s'agit d'un mouvement qui semble faire l'objet de moins de travaux de recherche que la main. Son utilité est moins évidente bien que primordiale dans la réalisation des tâches de la vie courante. De plus, il est moins direct à modéliser que celui d'articulations comme le coude, notamment car la prono-supination est la rotation de deux os dans l'avant-bras, l'ulna et le radius, qui se croisent en pronation et se décroisent en supination. Cela entraîne un mouvement de rotation du poignet par rapport au coude ; le long de l'avant-bras cette rotation est graduelle, sans mouvement au niveau du coude et une pleine amplitude au niveau du poignet.

Ainsi, toujours dans l'objectif de proposer des aides techniques permettant d'améliorer les fonctions de saisie de personnes paralysés des membres supérieurs, nous proposons une nouvelle approche en vue de la conception d'une orthèse d'assistance à la prono-supination basée sur un système sphérique.

Ce type de mécanisme a été considéré pour sa capacité à avoir un centre creux, laissant l'espace pour l'avant-bras, et à produire des trajectoires suivant des arcs de cercle sur une sphère afin de produire un mouvement de rotation. Aussi, il s'agit d'un mécanisme à faible degré de liberté permettant de limiter le nombre d'actionneurs. Enfin, comme le mouvement est prescrit par des angles plutôt que des longueurs, le champ des possibles concernant les formes des solides composant le mécanisme sphérique est très large. Ces propriétés permettent notamment de fonctionner autour d'un volume.

Une optimisation a été réalisée sous MATLAB afin de générer un système quatre barres sphérique permettant de suivre un arc de 45° de latitude. En agençant trois instances de ce système, de sorte à former un mécanisme composé de trois systèmes répartis à 120° par rapport à l'axe central, une rotation de 80° est obtenue. Le mécanisme produit est alors complété par un anneau à chaque extrémité, relié par les trois systèmes. Le couplage de trois systèmes en un mécanisme change les propriétés de celui-ci, notamment sa cinématique. Des liaisons rotules et glissières ont besoin d'être ajoutées afin de coupler les systèmes à l'anneau formant approximativement un cercle de latitude 45° . Ce mécanisme a trois degrés de liberté, un pour chaque sous-système. Cependant, chacun des trois sous-systèmes ayant exactement le même mouvement, il est possible de coupler leur actionnement afin de réduire le nombre d'actionneur à un. Afin d'obtenir une orthèse pouvant assister plus de 80° de rotation en pronosupination, la mise en série de deux de ces mécanismes a été envisagée. L'anneau de sortie du premier mécanisme étant également l'anneau d'entrée du second mécanisme. En empilant les mécanismes de la sorte, le second mécanisme ajoute son mouvement de rotation à celui du premier, atteignant ainsi les 160° .

Ce mécanisme a été prototypé pour une validation préliminaire. Les premiers résultats sont prometteurs pour l'application à une orthèse d'assistance de pronosupination. L'encombrement est limité car les solides bougent en suivant la surface d'une sphère, et l'amplitude du mouvement permet la réalisation des tâches de la vie courante. La possibilité d'empiler ces mécanismes les uns sur les autres, permet d'élargir le champ des applications possibles.

En définitive, la présente thèse a exploré différentes solutions visant à restaurer les fonctions de préhension pour des personnes ayant une paralysie des membres supérieurs grâce à des orthèses d'assistance. L'objectif in-fine est de contribuer à améliorer la qualité de vie de ces personnes en leur permettant de recouvrir une certaine autonomie. Différentes approches ont été proposées, en essayant d'apporter un regard nouveau que ce soit au niveau des concepts, des conceptions ou des fonctions visées.

List of Figures

1.1	The muscles (left) and main bones (right) of the upper limb.	27
1.2	Bones and joints of the human hand.	28
1.3	Non-prehensile movements of the hand.	29
1.4	Prehensile movements of the hand divided into power, intermediate and precision grasps.	29
1.5	Limb parts affected by a spinal cord injury depending on the level of the lesion.	31
1.6	Example of a passive tenodesis.	33
1.7	Tool adapter for people with tetraplegia (left) and doorknob extender (right).	34
2.1	A key grip used to hold a piece of paper.	40
2.2	A passive assistive orthosis that enhances the tenodesis effect.	41
2.3	Devices focusing on key grip and whether they are research devices or available.	43
2.4	Framework for most projects developed in Fabrikarium events.	45
2.5	Both Exofinger concepts developed during Fabrikarium 2020.	47
2.6	A participant wearing Exofinger on the right hand with the push button located on the opposite armrest.	48
2.7	The Exofinger principle is enacted through the positioning of the cable to create appropriate thumb action.	48
2.8	Control unit components: FreeCAD model (left) and opened prototype (right).	50
2.9	Routage of the cable inside the glove: palmar side on the left, dorsal side on the right.	50
2.10	A propulsion glove wraps around the hand to be donned.	51
2.11	The Exofinger unfolded (left) is donned by wrapping (right) it around the hand.	51
2.12	Web interface for the glove sewing pattern.	52
2.13	Schematic of designed push buttons.	53
2.14	Round and rectangular buttons for triggering Exofinger, closed and opened.	54
2.15	Android application to adjust and use Exofinger.	55
2.16	The experimental protocol for Exofinger.	55

2.17	<i>Commander Echo Console and pinch sensor from Jtech medical</i>	57
2.18	Key grip force with and without the device for each participant.	59
2.19	P6 and P7 using balancing to hold the pen.	60
2.20	P7's writing a) with the device, b) without the device.	60
2.21	P2's writing: on top without the device, on bottom with the device.	60
2.22	Writing task results where no time shown means that the task was not completed.	61
2.23	The three scores by participant.	63
3.1	Declination of power grasps.	69
3.2	A prototype of hybrid orthosis for assisting in power grasp	71
3.3	The mechanical hand and wrist orthosis from Aufratech.	73
3.4	Example electrode placement.	75
3.5	The Vivaltis Phenix electrical stimulator.	75
3.6	Graphical User Interface of the controller.	79
3.7	Example of ball manipulation with the hybrid orthosis.	83
3.8	Example of timeline produced after a full cycle of grasping during the experiment. From top to bottom: state of stimulation for extension, for flexion, position of the hand module, of the wrist module.	84
3.9	Mean holding time, including the mean time of first evidence of fatigue (yellow) for each session of the pilot study.	89
3.10	Mean rating of the perceived exertion by the participant of the pilot study.	90
3.11	Example of ball manipulation with Functional Electrical Stimulation (FES) only.	93
4.1	P7 of Exofinger holding the bottle for 7 seconds in neutral position (left) and more than 30 seconds using supination (right).	97
4.2	Bones and muscles of the forearm as it pronates and supines.	99
4.3	The red arrow is tangent to the forearm envelop, maximizing torque production, and the green arrow follows the forearm length, minimising encumbrance.	102
4.4	Example of distances between lines of action and center of rotation (left) and redirection of the pulling axis for elbow extension (right).	103
4.5	A pulley fixed to the forearm, redirects the pulling axis of a cable (red) which is anchored to the forearm as well. The velocity vector field shows that a pronation would result in a similar motion of the pulley and the anchor point. Pronation movement is considered as proportional along the forearm length.	104
4.6	Test with wristbands and cables: winding cable around the forearm (left) and angle redirection utilizing a pulley (right).	104
4.7	A spherical four-bar mechanism is desired to follow the path points \vec{P}_i along the line of latitude at 45° above the equator.	106
4.8	The axes of a spherical four-bar mechanism intersect at a common point.	107
4.9	A SOLIDWORKS model of the results of the optimization.	108
4.10	A SOLIDWORKS model of the general mechanical concept.	109
4.11	The torque ratio over a 35° sweep.	111
4.12	The design concept under consideration stacks the proposed device to extend from adjacent to the elbow to in-line with the wrist.	113
4.13	Required input torque for Activities of Daily Living (ADLs) with a single-layer mechanism over a 35° crank motion.	113

4.14	A rapid prototype for gauging the Range Of Motion (ROM) and test actuation via cables.	114
4.15	Human-sized version of the device with an opening in the rings in order to don and remove from the forearm.	115
4.16	Modified splint to connect the top ring to the wrist (left) and the resulting device on a forearm (right).	115
4.17	A mock-up of the device verified functionality at human scale.	116
5.1	Three tripods with different mechanical properties. The middle and right components have anisotropy leading to a rotation when each segment of the tripod is brought together.	123
5.2	Design of anisotropic thin prisms which allow bending in only one direction. Blue lines show the axis of anisotropy, yellow areas refer to higher density.	124
5.3	Larger anisotropic thin prism with channels for cable sheaths.	124
5.4	Sketch of a concept of modular assistive orthosis.	126
5.5	A flexion-extension orthosis using Boa technology ratchets.	128
5.6	Different configurations of cables and anchor points for assisting in elbow flexion.	130
5.7	Intricate <i>weaving</i> of McKibben actuators in a hand orthosis.	130

List of Tables

2.1	Type of disability and time since it occurred for Exofinger participants. .	58
2.2	Key pinch force (N) per participant	59
2.3	System Usability Scale (SUS) Score by item for each participant. Items are details below.	61
2.4	Overall satisfaction score.	62
2.5	Criteria scores by participant.	63
3.1	Mean time (ms) for the hybrid orthosis to achieved a state, for each par- ticipant.	85
3.2	Electrical stimulation parameters during each session of the pilot study.	88
3.3	Quebec User Evaluation of Satisfaction with Assistive Technol- ogy (QUEST) score by item for pilot study participant.	90
3.4	SUS score by item for pilot study participant. Items are detailed in Chap- ter 2.	91
4.1	Table of characteristics of several prono-supination orthoses.	101
4.2	The vectors defining the design of the spherical mechanism determined via the optimization.	108
5.1	Summary of the contributions of this thesis.	133

Abbreviations

DOF Degree Of Freedom	6
FES Functional Electrical Stimulation	18
ROM Range Of Motion	19
ADLs Activities of Daily Living	18
QUEST Quebec User Evaluation of Satisfaction with Assistive Technology	21
SUS System Usability Scale	21
CNS Central Nervous System	26
PNS Peripheral Nervous System	26
CMC CarpoMetaCarpal	27
MCP MetaCarpoPhalangeal	27
IP InterPhalangeal	27
PIP Proximal InterPhalangeal	27
DIP Distal InterPhalangeal	27
SCI Spinal Cord Injury	30
ASIA American Spinal Injury Association	30
MS Multiple Sclerosis	30
ISO International Organization for Standardization	34
WHO World Health Organization	34
ES Electrical Stimulation	36
SMA Shape Memory Alloy	36
DEA Dielectric Elastomer Actuator	36

FSR Force-Sensing Resistor	41
DIY Do It Yourself	42
MIT Massachusetts Institute of Technology	44
HLI HumanLab Inria	45
BLE Bluetooth Low Energy	48
DC Direct Current	35
IMU Inertial Measurement Unit	52
EEG ElectroEncephaloGraphy	52
EMG ElectroMyoGraphy	52
COERLE <i>Comité Opérationnel d'Evaluation des Risques Légaux et Ethiques</i>	54
USSAP <i>Union Sanitaire et Sociale Aude Pyrénées</i>	54
RCT Randomized Control Trial	70
ACT Advanced Conventional Therapy	70
GPIOs General Purpose Inputs/Outputs	74
API Application Programming Interface	76
GUI Graphical User Intergace	51
PID Proportional Integral Derivative	77
PWM Pulse Width Modulation	77
ID IDentifier	80
VAS Visual Analog Scale	86
RPE Rating of Perceived Exertion	87
UFMG <i>Universidade Federal de Minas Gerais</i>	93
R Revolute	109
P Prismatic	109
S Spherical	109
C Cylindric	110
F-T Fermat-Toricelli	110
CAD Computer-Aided Design	122
TPU Thermoplastic PolyUrethane	122
ULPA Upper Limb Performance Assessment	123
ARAT Action Research Arm Test	123

CHAPTER 1

Introduction

The human body is a complex machine. Even seemingly simple daily tasks, such as grabbing a bottle of water from a table, require the activation of multiple muscles to properly initiate the movement of limbs and accomplish the task with varying degrees of complexity and precision. However, this intricate organism is susceptible to inherent flaws or can be impaired as a result of accidents or diseases which can lead to complete or partial paralysis. The upper limbs, particularly our hands, serve as the primary means through which we interact with our environment. Therefore, any impairment results in a major deficiency. Individuals suffering from upper-limb paralysis require the assistance of a third party. Autonomy being a key factor in the quality of life, the significant and negative impact in terms of autonomy or carrying out the tasks of daily life is obvious.

Various solutions are available to address motor deficiencies resulting from paralysis. Rehabilitative training plays a crucial role in improving functionality after an injury [1, 2]. Unfortunately, not all patients are able to recover enough of their own motor function. Surgical interventions are a main way of recovering some autonomy by restoring upper limb functions [3, 4, 5, 6, 7, 8, 9, 10]. For patients who do not undergo surgery, or as a complement to those who do, technical aids have been developed to assist in task completion [11]. The most prevalent approach for individuals with upper limbs paralysis is to adapt tools to suit their specific needs [12]. More recent assistive devices aim at function restoration instead of specific task completion [13, 14, 15].

This thesis focuses on the development of technical aids for the restoration of upper limb function. To understand how assistive technologies improve autonomy of people with paralysis, a brief overview of the changes that occur in the body as a result of the disease or injury is also required.

1.1 Context and biology basics

This section provides a brief overview on the execution of a motion by the human body. The focus is made on upper limbs; their anatomy and biomechanics are presented.

1.1.1 Motor control

The Central Nervous System (**CNS**), comprised of the brain and spinal cord, generates and transmits electrical impulses as moving commands to the Peripheral Nervous System (**PNS**). This system consists of nerves that connect the spinal cord to various organs, including muscles. Upon receiving the electrical command, muscles contract, leading to a change in their length. This contraction, in turn, exerts force on a tendon, which connects the muscle to a bone, resulting in joint movement. For more details see [16, 17].

In an engineering analogy, the **CNS** can be viewed as a control system, while the **PNS** serves mainly as the data transmission system. The muscles would be the actuators, with their tendons being power transmission components. Therefore, limb parts would be the end-effectors.

Nerves - The upper limbs feature three main nerves, median, radial and ulnar, which represent the pathway for information. A nerve is composed of nerve fibers, to some extent like a sheath encompassing a collection of data cables. The nerve fibers responsible for the transmission of a command from the **CNS** to an organ, such as a muscle, are called efferent or motor nerves. On the other hand, nerve fibers defined as afferent or sensory carry information from the body's sensory receptors to the **CNS**. These stimuli can be, for example, somatosensation which includes mechanoreception, thermoreception, nociception and proprioception. Thus, a nerve branches out to deliver information to a variety of organs, including muscles.

1.1.2 Biomechanics of upper limbs

The upper limbs begin with the shoulders and end with the hands. As depicted on the left of Figure 1.1, each upper limb includes a shoulders, arm, elbow, forearm, wrist and hand.

1.1.2.a Muscles and bones of upper limbs

Muscles are organs that are contracted by stimuli on an efferent nerve. They are composed of fascicles that encompass muscles fibers which can be of different type. Upon the reception of a stimuli from the nerve, muscle fibers contract accordingly.

Most of the time, muscles are antagonistic, meaning that they work as a pair of muscles or group of muscles to produce opposite actions around a joint. For example, elbow flexion is induced by biceps contraction and its extension by triceps contraction. When the biceps contracts, it shortens, and on the opposite side of the arm, the triceps relaxes and lengthens to allow the movement. This coordinated action is necessary not only to allow motion but to also ensure smoothness by maintaining balance. Also, co-contraction of both antagonistic muscle groups enables changes in joint rigidity.

Some muscles responsible for shoulder movements and most of the hand muscles are extrinsic muscles, which means that they are located outside the body part. For

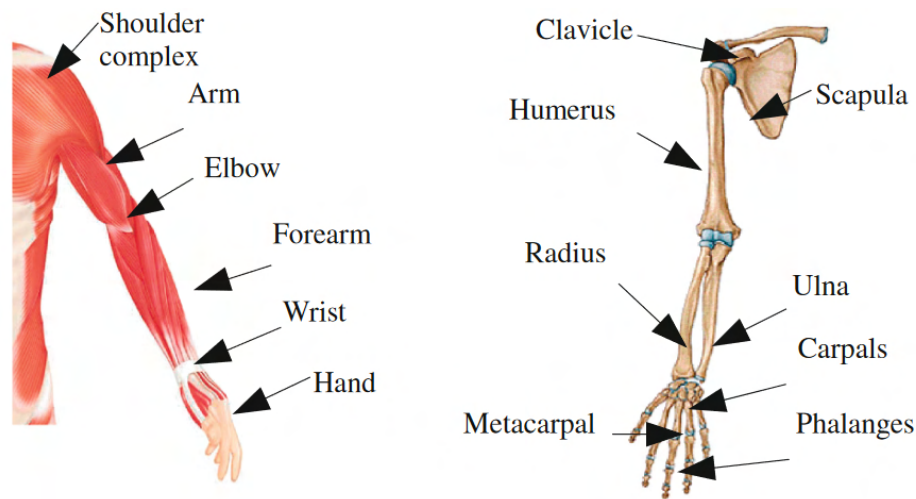

Figure 1.1: The muscles (left) and main bones (right) of the upper limb. *source [18]*

example, muscles responsible for controlling finger flexion-extension movements are located in the forearm, while those responsible for abduction-adduction are located within the hand.

In order to produce motion, or stiffness, these muscles pull on tendons that attach to bones.

The main bones of the upper limbs are shown on the right in Figure 1.1. The shoulder is composed of the clavicle and the scapula. together with the humerus they constitute the shoulder joint, which includes the glenohumeral joint and the scapular joint [20, 21]. The arm is composed of the humerus, which is linked to the radius and ulna forming the elbow joint. The latter two bones constitute the forearm. Their interaction with the eight carpals bones forms the wrist joint. As depicted in Figure 1.2, the hand is comprised of carpals, metacarpals and phalanges which can be proximal, intermediate or distal.

For the thumb, a carpal and a its metacarpal form the CarpoMetaCarpal (CMC) joint at its base, followed by the MetaCarpoPhalangeal (MCP) joint constituted by the metacarpal and proximal phalanx. Finally, the proximal phalanx and distal phalanx make the InterPhalangeal (IP). Long fingers also feature the MCP joint. However, long fingers having three phalanges, the distal phalanx and the proximal phalanx are not connected. Instead, the proximal phalanx form the Proximal InterPhalangeal (PIP) joint by meeting the intermediate phalanx, which constitute the Distal InterPhalangeal (DIP) joint together with the distal phalanx. While unconstrained, PIP and DIP motion are coupled by the anatomical arrangement of their tendons [22].

More detail on upper limb anatomy is found in [18, 19, 20, 21].

1.1.2.b Upper limbs movements

The research community, with health professionals, has developed kinematic models for every upper limb movement, which vary in complexity depending on the use [23, 24]. Human joints are polycentric which means that their center of rotation moves along the movement. Depending of the required fidelity, different models have been proposed featuring monocentric or polycentric joints [25].

In this thesis, upper limbs are considered to include 29 DOF. A tree diagram, [available in appendix](#), has been established to synthesize upper limbs movements, which

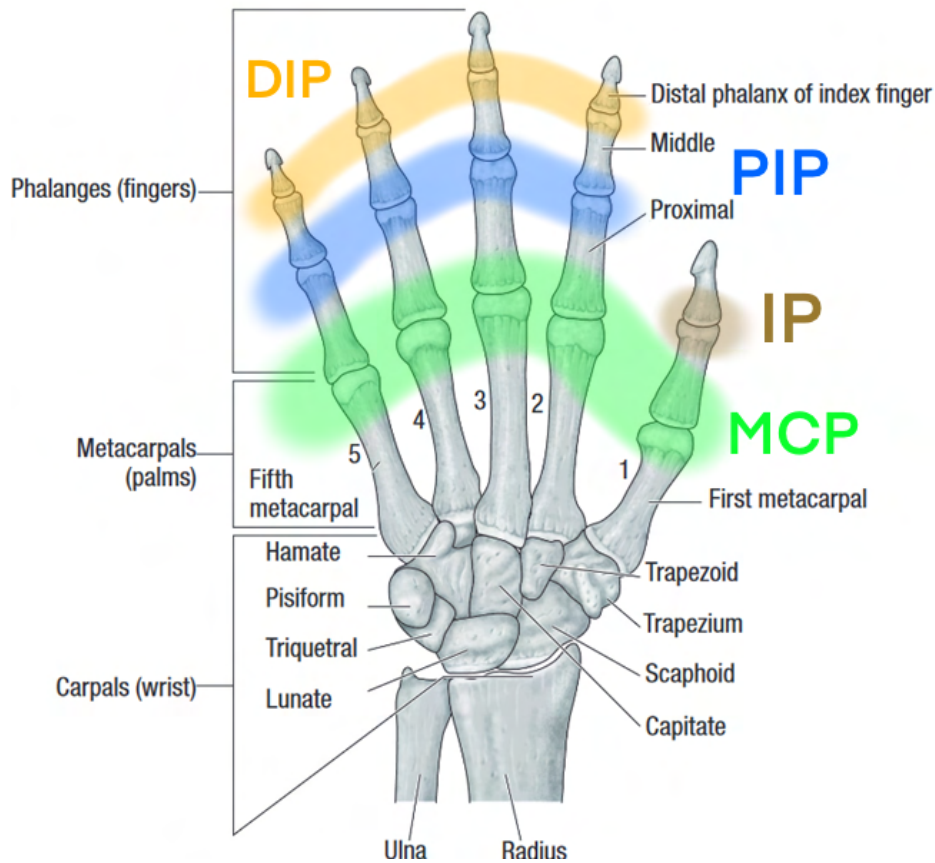

Figure 1.2: Bones and joints of the human hand. *modified from [19]*

are sorted by limb part and joint. Basically, the shoulder has three **DOF** in rotation and two **DOF** in translation. The elbow features only a rotation, flexion-extension. The forearm pronates or supines, leading to one **DOF**. The wrist includes two rotational **DOF**, flexion-extension and ulnar or radial deviation. The thumb's **CMC** joint, as well as the **MCP** joint for the long fingers, feature two **DOF**, flexion-extension and abduction-adduction. Finally, **PIP**, **DIP**, **IP** and the thumb's **MCP** joints have one **DOF**, flexion-extension.

1.1.3 Everyday hand use

Upper limbs can be conceptualized as a sequential robotic system, where the hands serve as the end-effectors. In practice, the movements of the upper limbs primarily involve positioning the hands through reaching actions or manipulating objects held by the hands. Hands play an essential role in everyday life as they are the primary means of interacting. Human hand movements can be divided into two groups, prehensile and non-prehensile movements [11, 26].

1.1.3.a Non-prehensile movements

Non-prehensile movements refer to the positioning of fingers and palm to complete a non-grasping task, as depicted in Figure 1.3. Examples are pushing, lifting or interacting with digital devices such as keyboards, mice or touchscreens. Hands are also used for communication including, of course, sign language, but also for hand

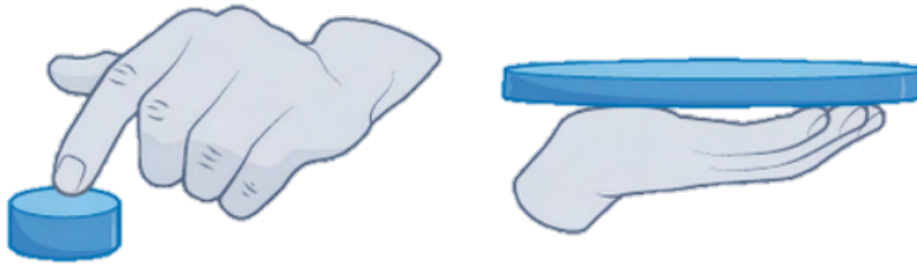

Figure 1.3: Non-prehensile movements of the hand. *source [11]*

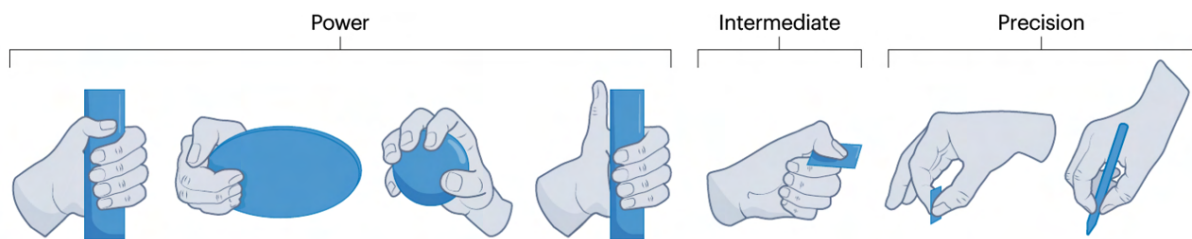

Figure 1.4: Prehensile movements of the hand divided into power, intermediate and precision grasps. *source [11]*

gesture while speaking or waving for example [11, 26, 27].

1.1.3.b Prehensile movements

Prehensile movements are prevalent [26]. The research community developed various classifications. Lately a consensus seems to be emerging within a classification of grasps as one of 33 types [11, 28].

This variety of grasps can be classified into three main categories, power, intermediate or precision, shown in Figure 1.4. However, according to a study performed on housemaids and machinists, only a few are used in everyday life, with five grasps representing 80 percent of the grasps used in 29 types of tasks for housemaids, and ten types of grasps to perform 31 tasks for machinists [29].

During *ADLs*, precision grasps are the most commonly used, followed by power grasps, then intermediate ones [26, 30].

The average functional *ROM* of the hand, which is sufficient to perform more than 90% of *ADLs*, at *MCP*, *PIP*, and *DIP* are 52, 64, and 54°, respectively [31], with increasing functional *ROM* for ulnar fingers [32]. While the thumb moves relatively independently, the four long fingers move more together during grasping tasks, specially at the *DIP* and *PIP* joints as they are anatomically coupled [33].

As for forces, one study concluded that most of *ADLs* require less than 10.5 N, except for unplugging from an outlet [34]. The force distribution among fingers and palm depends on the type of grasp with, for example, radial fingers prevailing over ulnar fingers in cylindrical grasps and the contrary in spherical grasps.

1.2 Paralysis

Hands serve as the primary means of interacting with our surroundings and are used continuously. Unfortunately, dysfunction of the human body can result in paralysis of the upper limbs. This dysfunction can manifest itself at various stages of the motion generation process, from command creation through transmission to actuation. A defective **CNS** can impede the creation of commands necessary for movement; a damage to the **CNS** or **PNS** can prevent the transmission of this command; an absence or a deterioration of muscle-tendon units can also result in no functional motion.

Paralysis can occur at birth or later in life, resulting from a health condition or an accident. Stroke can cause paralysis and is the leading cause of this disability worldwide [35]. Stroke can result in hemiplegia, the paralysis of half of the limbs. Frequently, in this case, the disabled hand is abandoned and stroke survivors often use only the healthy side, making it difficult to achieve bi-manual tasks [36, 37]. Some rare diseases can also lead to paralysis, such as Guillan-Barré syndrome or Multiple Sclerosis (**MS**). They both can lead to major motor disability resulting in tetraplegia, literally the paralysis of all four limbs.

1.2.1 Spinal cord injury

An Spinal Cord Injury (**SCI**) can damage the spinal cord and break the connection between the brain and the **PNS**. Since the damaged area prevents the transmission of electrical signals, **SCI** leads to muscle paralysis. As, infralesional¹ muscles are paralyzed, the higher the lesion in the spinal cord, the broader the range of body areas are affected, as shown by Figure 1.5.

In 2006, a literature survey reported that 223–755 per million inhabitants represents a worldwide estimate of individuals with **SCI**. The reported incidence per year of **SCI** would lie between 10.4 and 83 per million inhabitants [38]. Considering a worldwide population of eight billion, we estimate that approximately 1.8 million to 6 million people lives with **SCI**, and the incidence per year to be between 83 thousands and 664 thousands. Causes include vehicular accidents (38%), violence (26%), falls (22%), as well as sports accidents (7%) [39].

Around a third of individuals with **SCI** are diagnosed tetraplegic and two thirds paraplegic, which means the lesion is low enough to not paralyze the upper limbs [38]. However, impairments caused by **SCI** are difficult to simply define. The community of health professionals has developed several classifications, such as the American Spinal Injury Association (**ASIA**) classification [40]. Often, the level of the lesion is used and refers to the damaged vertebrae, which can be cervical 1–8 (C1–C8), thoracic 1–12 (T1–T12), lumbar 1–5 (L1–L5) or sacral (S1–S5). This is supplemented by whether the lesion is deemed complete or incomplete, i.e. whether all connections are broken at the level of the lesion or some connections still work properly. Thereby, an individual with an incomplete **SCI** can have sensation or voluntary movement under the level of the lesion. Half of **SCI** result in a complete lesion [38].

Even if paralysis is the most obvious effect of **SCI**, other consequences affect quality of life. Indeed, individuals with **SCI** can experience dysesthesia, which is a sensory disorder that affects somatosensation, and spasticity, which is increased muscle tone,

¹Medical term to refer to areas or structures located below the level of the spinal cord lesion.

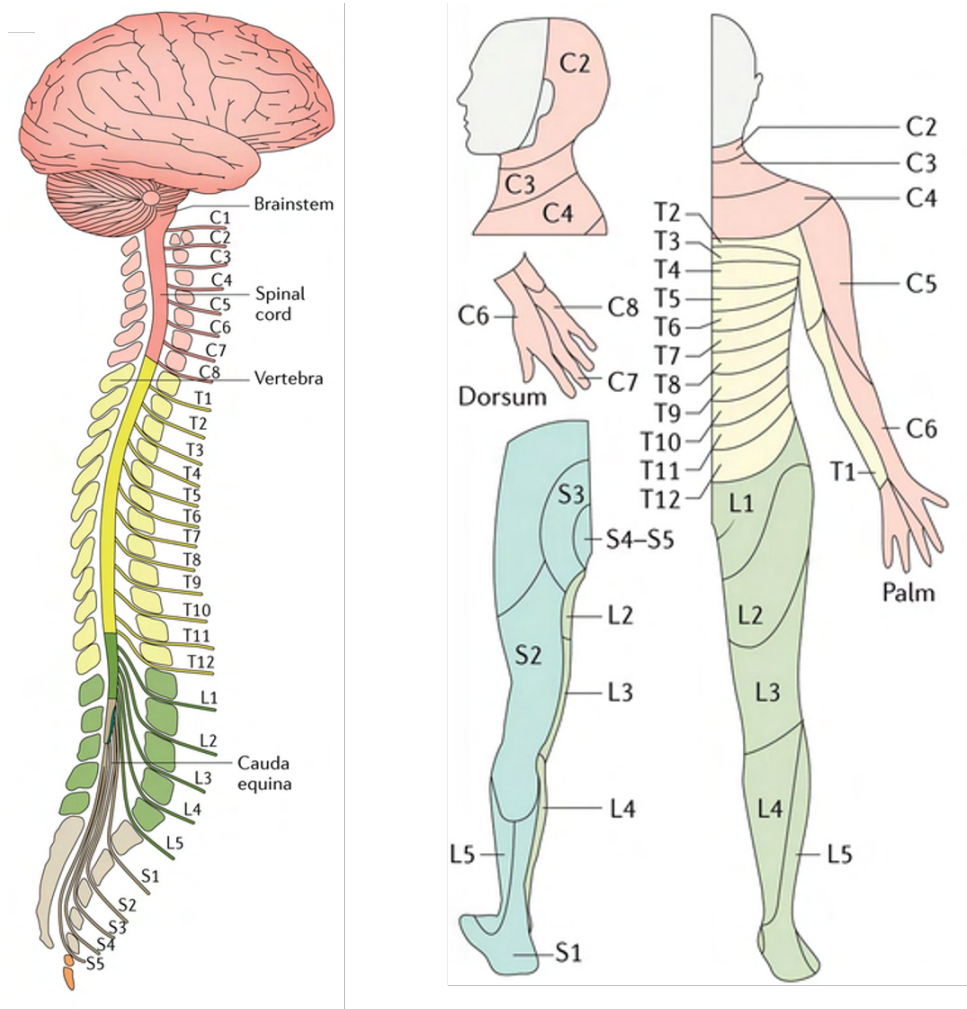

Figure 1.5: Limb parts affected by a spinal cord injury depending on the level of the lesion. *modified from [1]*

stiffness and/or involuntary contraction. The muscles responsible for bladder and bowel functions may also be paralyzed, significantly impacting the quality of life. In the past centuries, an SCI reduced considerably the life expectancy as any local infection could lead to death [41]. In addition, the injury can affect only a part of a set of antagonistic muscles, leading to unbalanced constraints.

As impairments resulting from SCI depend on several parameters, including but not limited to the completeness and the level of the lesion, to some extent we can say that each individual with SCI experiences a different impairment. That said, according to a survey performed on 395 participants with tetraplegia, 48.7% indicated that regaining arm and hand function would most improve their quality of life, over other choices including bowel-bladder, sexual functions, decreased pain, and the ability to walk [42]. This can be explained by the fact that, as previously mentioned, the hands are the main way of interacting with the environment. Regaining arm and hand function allows performing many other functions autonomously.

In this context, the primary focus of this thesis lies in the development of assistive technological solutions to restore hand functions. Moreover, considering the variability in impairments even among individuals with SCI, we decided to focus on tetraplegia, although any condition resulting in arm paralysis can benefit from the same assistive technologies.

For more details on SCI, please see reference [43].

1.3 Functional solutions

An SCI is followed by an acute phase of six to nine months. As for stroke survivors, this phase is a critical time when the body reacts to the injury by trying to contain the damage and promote healing. Rehabilitation following the months after the injury is critical and enables regaining some functionality [44, 45]. During this time, people with SCI are taught compensatory techniques, such as using the tenodesis effect and supinating to limit the required grasp strength. The tenodesis effect consists of a passive grasp of the thumb on the lateral side of the index, as shown in Figure 1.6.

Once the acute phase is over, individuals with SCI can recover some autonomy by undergoing surgeries and/or using technical aids [5, 46].

1.3.1 Surgical solutions

Upper limb functional surgery in patients with tetraplegia has been performed for more than 30 years. 70% of the population with SCI are eligible for hand and elbow surgery [5], with the commonly undertaken procedures as follows:

1. tendon transfers of synergistic muscles to restore active movements: finger extension, grasp and key pinch;
2. tenodesis surgical procedures to strengthen a hand's; tenodesis effect when too few muscles are available for transfers
3. joint stabilization procedures.

Otherwise, in the case where there are few active residual muscles available, a nerve transfer surgery can be considered [3]. Its principle is based on the reinnervation of one or more distal muscle(s) denervated by the SCI thanks to a proximal *donor*



Figure 1.6: Example of a passive tenodesis. *source [5]*

nerve emanating from the supraspinal part of the spinal cord. The nerve suture is performed as close as possible to the target muscle without an intercalary graft. Similar to tendon transfers, nerve transfer surgery involves using a donor nerve whose function is not essential or that can be supplanted by another nerve and using it to *activate* a recipient nerve.

With plasticity and practice, the patient learns to drive the proper function [7]. Nerve transfers can be done differently on both hands, in order to restore different function. For example one hand can perform precise grasps and the other hand power grasps [8].

Numerous studies have reported that restoration of arm and hand function was a high priority for people with tetraplegia [42, 47, 48, 49]. Intriguingly, there are still many patients who have not benefited from upper-extremity reconstructive surgery [9, 10].

Reasons are various: some **SCI** patients are not managed in specialized **SCI** units; some **SCI** units have not established any collaboration with a surgeon involved in upper extremity reconstruction; arguments used to persuade patients to undergo a surgical program may be discouraging them from undergoing reconstructive surgery, including immobilization after surgeries [50]; disappointing results observed in previous patients, as the resulting forces can be weak [51].

As a complement or an alternative, assistive technologies are often proposed in rehabilitation centers.



Figure 1.7: Tool adapter for people with tetraplegia (left) and doorknob extender (right). source: *arthritissupplies.com*

1.3.2 Assistive technologies

In order to maintain their autonomy, individuals with SCI can use assistive technologies. These devices come in various forms, as defined by World Health Organization (WHO) [52]:

Assistive technology is the application of organized knowledge and skills related to assistive products, including systems and services. Assistive technology is a subset of health technology. An assistive product is any external product (including devices, equipment, instruments or software), especially produced or generally available, the primary purpose of which is to maintain or improve an individual's functioning and independence, and thereby promote their well-being.

In the context of tetraplegia, assistive technologies can be as simple as a tool adaptation enabling a paralyzed hand to manipulate objects, or adaptations of the environment, such as doorknob extenders or thickeners, shown in Figure 1.7. Splints are also used to help position limb parts, notably the thumb in opposition. However, the functional gain is dedicated to a very specific task or object and even if an assistive technology gives a benefit, a functional gain to its user, taking into account the cost in time and mental burden of using such device is crucial. [12].

Other assistive technologies provide functional gains to individuals with SCI; assistive orthoses and FES provide function rather than only task completion.

1.3.2.a Assistive hand orthoses

Assistive orthoses are devices worn over impaired limbs to assist movement, aid recovery, and produce autonomy. They are defined by the International Organization for Standardization (ISO) 8549:2020 and to some extent, assistive orthoses are the counterpart of prostheses for people with limb paralysis. However, in terms of technical and scientific progress, the development of orthotics lags well behind the field of prosthetic development for people missing a limb [53]. Unlike prostheses, assistive orthoses utilize the space around the affected limb, making their portability, size, weight, and power requirements critical factors in their design. These criteria comprise significant technical and scientific challenges in the design of an effective

prosthetic or orthosis. Significant research into the design and analysis of new mechanical systems is occurring to help respond to these challenges. This is particularly true for hand assistive orthoses because they target a distal part of the limb.

A perfect hand assistive orthosis does not exist. Indeed, as with any other assistive technology, or any device, each end-user can desire a different product. The reasons for disapproving of a device can be the size, the design, the functionality, or many other reasons. In addition, as stated previously, two SCI's are not likely to lead to the same impairments. This can explain why the research community has produced plenty of hand orthosis prototypes, along with the difficulty of the challenge. A study in 2016 covering dynamic hand orthoses reviewed 165 devices [14]. This study includes a categorization that highlights hand orthosis variety in terms of use, actuation, design and control. The latter encompasses the selected control strategy, user feedback and the command signal. The input to the controller can be brain activity, muscle activation, movement, eye contact, voice, or pressure on a button, for example [14]. Given the large number of hand orthoses, this thesis cannot be exhaustive and tries to examine the main trends in design. That is why we extended the categorization from hand to upper limbs by adding other upper limb motions. The resulting categorization is [available in appendices](#) and has been used in [54]. The following section only cites references published in 2016 or later.

Some devices do not fall into our scope of assistive hand orthoses, as they are designed for rehabilitation [55, 56, 57, 58, 59, 60]. While portability might not be necessary for those devices used in clinical settings, the same cannot be said for orthoses designed to assist in performing ADLs. In fact, the weight is one of the most important features to take into account when designing a hand orthosis and its threshold for acceptance has been identified to be in the range of 400–500 g [61, 62]. To achieve this criterion, most devices are designed to place the actuation at a distance from the hand. This reduces the encumbrance to the work space and moves the extra inertia/mass to a more proximal body part.

For upper limb assistive orthoses, Direct Current (DC) motors and pneumatic actuators are the actuation methods of choice. The advantages of pneumatics include the high power to volume ratio and compatibility with soft architectures [59, 63, 64, 65, 66, 67]. The downside is the need for a compressor or pressurized gas storage tank and, adding in those components, results in heavier overall systems than those that rely on batteries. Control-wise, pneumatic actuators naturally allow for two basic configurations, pressurized or empty, and can prove to be too slow with their activation time failing to match the speed of the user's movements [68, 69]. Alternately, electromagnetic actuators are faster, but produce limited torques at high speeds so their rotational movement must be modified for use on human joints [62, 70, 71, 72, 73, 74, 75, 76, 77, 78, 79, 80, 81, 82].

Compliant architecture orthoses can offer the advantage of accommodating the natural movements of the human body in a simpler manner. Indeed, as human joints are polycentric, devices including hard joints with corresponding expectations for human body joints can be problematic. The rigidity of the device constraining the joint's motion could readily lead to internal stresses. Depending on regularity of use and the force involved, discomfort or pain could occur [83]. Therefore,

jointless architectures ensure that the device does not impose a motion that could injure the joints [63, 64, 67, 72, 73, 76, 78, 79, 82, 84, 85]. Another solution is to design a mechanism performing self-alignment of the orthosis with the human joints [86].

As long as the actuation is deported, the transmission aspect assumes a critical role in the overall design process. Frequently, when electromagnetic actuators are used, gearing is involved. Sometimes, the non backdrivable feature of gearing can lock a device position without continued power consumption. Multi-bar linkages are also a common force transmission solution allowing for coupled joint motions or fully controlled movements [68, 74, 80, 81, 87, 88]. Cables, being compatible with soft architectures, also get used [72, 73, 75, 76, 77, 78, 79, 82]. Noting that the pretensioning of the cables can produce discomfort for the wearer and additional friction within the device.

To achieve transmission as well as actuation, Shape Memory Alloys (SMAs) are used, especially of the twisted and coiled polymer type. Even if the portability is highly improved, this solution is not suitable for daily use because of temperature issues. Indeed, by contracting, they produce a lot of heat, reaching 150°C and then require 30 seconds to cool down [89, 90]. Dielectric Elastomer Actuators (DEAs) exhibit similar advantages and the limitation of being incompatible with human use due to the high voltage requirement, which can reach up to 1230 V [91].

In order to gain portability, several orthoses feature fewer actuators than assisted motion, resulting in an actuators supporting more than one movement [58, 62, 71, 74, 76, 78]. This underactuation can be performed between fingers or on a finger by biomimicking, or taking advantage of, the biological coupling of DIP and PIP in long fingers. Of course, this depends on the targeted functions that are to be assisted. Only the thumb can be assisted, or at the opposite, only long fingers. Each degree of freedom offers a different option for an assistive orthosis; whether to assist adduction, abduction, flexion or extension of each finger is a choice made depending on the targeted grasp and population.

Others devices are not actuated at all and rely on the user's remaining voluntary motion [77, 88], especially taking advantage of the tenodesis effect [92].

In the end, the feature that matters most is neither the weight nor the assisted power but the power-weight ratio. The assistive technology with the best potential of maximizing this quantity is likely to be the electrical stimulation.

1.3.2.b Functional Electrical Stimulation

FES is the application of electrical impulses to nerves via electrodes positioned on the surface of the skin or invasively through direct contact with nerves or muscles in order to induce muscle contractions. Thereby, for individuals with SCI, Electrical Stimulation (ES) enables infralesional muscles contraction. With a proper command signal, FES can bypass the injury.

An electrical stimulator sends to the electrodes a train of impulse that is mainly characterized by its shape, usually biphasic rectangular, the frequency (usually in Hz)

between two impulses, the amplitude of an impulse (in mA) and its duration, referred as pulse width (usually in μs).

Although implanted stimulation requires surgery, it comes with a wider possibility in muscle selectivity leading to better gesture quality [93]. Indeed, external stimulation relies on surface electrodes which not only need to be placed correctly but are also limited in precision; surface stimulation does not allow control of the deep muscles without stimulating all muscles in-between the deep muscles and the electrodes on the skin. The main drawback with FES is the induced early muscle fatigue due to the nature of impulses that do not recruit the same muscle fibers as a stimuli for a volitional contraction [94]. This fatigue limits the effectiveness of both the gesture and its duration [95]. A wise choice in the set of parameters, especially the frequency, can limit the fatigue [94, 96]. In addition, FES is used for rehabilitation purposes and global health conditioning, including vascular effects, warmth or treatment to prevent muscle atrophy [97].

As an assistive technology, FES makes generating movement possible with a biological actuator from low-amplitude electrical impulses generated by a small battery. Compared to an external actuator, FES has a better power-weight ratio, especially with muscle training. However, the use of FES is not accessible to all individuals with SCI, because of health condition leading to contraindications. For more details on the use of FES within the SCI population, please refer to [International FES society website](#).

Whether the technical aid is FES or assistive orthoses, accessibility seems to be a major barrier to access [52]. The WHO and Unicef report that 2.5 billion people worldwide require at least one assistive product, such as wheelchairs or hearing aids, and one billion do not have access to them [52].

For individuals with SCI, assistive technologies are a main way to recover some autonomy. However, when they have access to a technical aid, the long term acceptance is poor [12]. This shows that currently available developed solutions are not sufficient, maybe because the basic ones are dedicated to a single task or are not adapted to the needs. In addition, when an assistive technology needs maintenance, the user usually has to return it to the manufacturer and be deprived of its autonomy gain for some months. The variety of hand assistive orthoses in the literature can also be explained by user impairment heterogeneity and the complexity of rating one device over another.

This thesis is intended to be exploratory and has the ambition to propose different approaches to improving the autonomy of people with hand impairments by restoring grasping functions through assistive orthoses.

Key grip assistance : Exofinger a low-cost and open source orthosis

The key grip is deemed an intermediate grip between precision and power [11]. People with tetraplegia are more likely to use the key grip instead of the power and precision grasp. In addition, the key grip has the advantage of requiring less movement, by mobilizing just the thumb in the case that long fingers can be flexed by spasticity. The fingers don't need to have strength as they are used only as a surface for the thumb to press the object against. An orthosis that assists a single finger is more likely to be light weight and discrete compared to assistive orthoses for power or precision grasps. For these reasons, a key grip assistive orthosis was considered.

In the end, the objective is to propose an assistive device enabling people with hand impairments to recover some autonomy by performing intermediate grasps. As an exploratory phase, this chapter presents the progress on an open source project to design a key grip orthosis with a very simple concept. The project was initially intended for a particular individual suffering from tetraplegia. A research protocol has been carried out to evaluate the usability and the efficiency of this orthosis.

2.1 Key grip orthosis

2.1.1 Key grip basics

A key grip refers to the gripping motion used to manipulate a key. This kind of grasp is also called a lateral key pinch, illustrated in Figure 2.1. This grip involves radial abduction of the thumb and flexion of the long fingers, allowing the thumb fingertip to contact the lateral part of the intermediate phalanx of the index finger. However, individuals with flexed long fingers and spasticity may experience different contacts between the thumb and the index, such as the thumb and the proximal phalanx of the index finger, or even the thumb's proximal phalanx and the index.

The nerve fibers responsible for wrist movements are located higher on the spinal cords than those responsible for hand movements. As a result, individuals with



Figure 2.1: A key grip used to hold a piece of paper. *source [11]*

tetraplegia due to [SCI](#) are more likely to have voluntary wrist movements than finger movements. Furthermore, voluntary wrist extension can be achieved through functional surgery. Given the frequent occurrence of flexed long fingers in individuals with tetraplegia and their likeliness to have voluntary wrist movements [98], the key grip seems to be more adapted to individuals with tetraplegia. As the tendons controlling finger flexion pass through the carpal tunnel on the palmar side of the wrist, an extension of the wrist causes a biomechanical closing of the fingers, known as the tenodesis effect. Therefore, this biological key grip does not require any voluntary finger or hand movements, only a voluntary extension of the wrist.

In order to be strong enough to achieve most of simple [ADLs](#), the grip must have a strength of 10 N [34].

2.1.2 Existing key grip orthoses

Some passive orthoses exist that focus on enhancing the tenodesis effect. This can be done through the proper positioning of a rigid-body linkage, passively enhancing the effect [92], as seen in [Figure 2.2](#). This wrist-driven orthosis is available open source and, notably, due to its passive nature, requires only very inexpensive materials. The tenodesis effect can be mimicked using cables that serve as external tendons. This allows for the adjustment of their lengths, and thus the degree of wrist extension, to obtain a finer or more powerful key grip. Other passive methods have been tried [99], as well as active methods involving a box on the dorsal side of the forearm with a linear motor that induces wrist extension and amplifies the tenodesis effect [76].

As the key grip requires only the thumb to exert force, a one-finger orthosis is worth considering. For rehabilitation purposes, a design proposed by the research community uses a linear actuator and a rigid-body linkage in order for each phalanges to bend properly [100]. Also, the device can be customized to fit the wearer finger size due to a set of adjustable parameters. This design is not well adapted for the thumb, as the radial abduction/adduction significantly changes the axis of the linear actuator. Moreover, this orthosis is designed for a long finger, using the space at the dorsal side of the hand. For the thumb, the space is limited, at the expense of hindering wrist deviations.

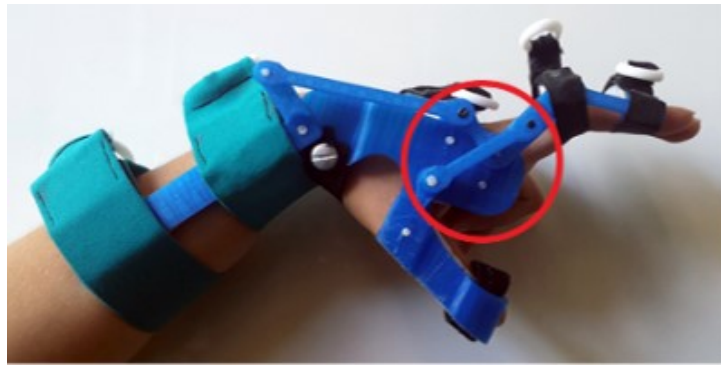

Figure 2.2: A passive assistive orthosis that enhances the tenodesis effect. *source [92]*

The orthoses previously cited in Chapter 1 also perform key grips. Although the key grip may not be the primary purpose of these assistive orthoses, they include radial abduction of the thumb, making key grips possible. One such orthosis is the Exo-Glove PM [66]. Having the ability to perform both the palmar grasp and the key grip is a note-worthy feature. However, for those interested in only key grip assistance, an entire assistive device is likely too much, particularly in terms of usability and portability.

Considering assistive devices available on the market, BioservoTechnologies developed assistance gloves, specifically designed for use by workers. The SEM Glove is one of them. This motorized glove is worn on the middle and ring fingers and the thumb, and incorporates Force-Sensing Resistor (FSR) sensors on each digit to detect contact [101]. When contact is detected on a digit, the signal is transmitted to a control unit located at the waist. The control unit then evaluates whether the contact is sufficient to trigger the closing of the glove. Once the glove is closed, the object being handled cannot be dropped due to the non-backdrivability of the device. The control unit constantly monitors the level of contact at the fingertips, and allows the hand to open, giving slack only when the contact is sufficiently light indicating the user is trying to release the grip. A research protocol confirmed the contribution of the SEM Glove in terms of force for 30 subjects with hand impairment [82]. However, it would be worth investigating whether paralyzed hands are capable of triggering the opening and closing of the glove, with a tenodesis effect for instance. The same company has also developed the IronHand, a five-fingered glove that operates on the same principle as the SEM Glove [102]. The control unit, which can be disconnected from the glove, is linked to it by a five-rail connector whose length equals the winding cable length. An application allows the user to adjust the force applied to each finger. The IronHand seems very effective in reducing the strain experienced by workers when using tools. However, this technology is not designed for individuals with hand impairments, at least not paralyzed ones, as the donning would be particularly challenging and the input command requires finger movements.

Tendo offers an orthosis designed to assist individuals with hand impairment, specifically targeting those who lack strength or have paralysis resulting from SCI, stroke, or MS. In order to promote portability and autonomy, the Tendo OneGrip concept focuses on key grip assistance [103]. The orthosis features a control unit on the arm that detects *small movements of the wrist*, triggering the grip or release functions. The startup claims that the grip can be maintained without consuming

power resources, suggesting that the device is likely non-backdrivable. This promising orthosis appears to prioritize the needs of patients. While a functional device has been presented, this device remains unavailable for purchase after three years since the completion of this Ph.D. Moreover, as the device is patented, gathering information about the device is challenging, and to date no experimental research evidence has been gathered to support the claimed usability and efficiency of the device.

On the other hand, the Do It Yourself (DIY) community has presented open-source projects as alternate solutions. Among these projects is a fully printed hand orthosis that uses stepper motors and belts, sliding parts, and rigid-body linkages to transmit proper movement to each of the phalanges of the five fingers [104, 105]. Additionally, there are projects that enable finger amputees to use the tenodesis effect. The Talon ratchet hand is an example of a prosthetic hand that can close fingers with wrist extension, and it does not require the wrist to remain extended to maintain grip [106, 107]. Although this device is a prosthesis, this project could potentially benefit individuals with hand impairment and long flexed fingers, considering the size of the artificial hand.

Figure 2.3 summarizes cited devices focusing on key grip and whether they are research devices or available for the end-user.

This overview reveals a lack of orthoses that focus on assisting key grip. Research prototypes that enhance or take advantage of the tenodesis effect to increase the resulting force appear to be the most promising for potential use in everyday life. Nevertheless, these prototypes are either unavailable to end-users, excessively bulky, or too conspicuous to be utilized. From the marketing side, Tendo OneGrip shows great promise; however, this device is not yet available for purchase and its price may pose a barrier to widespread adoption [52]. Moreover, the extent to which this startup can develop ancillary services around the product remains to be seen. Post-sale service management, including repair and maintenance, is critical for persons with disabilities, as repair typically necessitates a considerable amount of time during which these individuals lose the autonomy linked to the technical aid. A patented product will likely impede users or their network from repairing the device themselves.

In conclusion, there is currently a lack of available solutions that assist with key grip and are suitable for everyday use by the general public.

To promote the acceptance of assistive technology among individuals with disabilities, involving them in the design process from the outset seems crucial. Otherwise, the technology may be abandoned due to issues such as bulkiness, lengthy installation time, or aesthetics, resulting in the technology becoming more of a hindrance than a help. Therefore, involving these individuals in the validation phases of the technology is a necessity to ensure proposed devices meet their specific needs while minimizing any potential constraints.

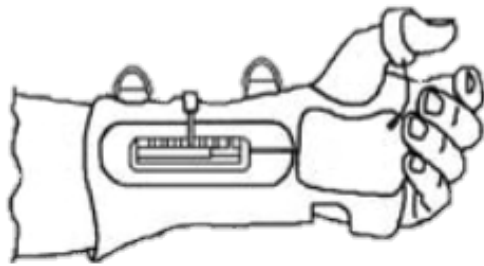

(a) Passive orthosis enhancing the tenodesis effect. This is a research device [99].

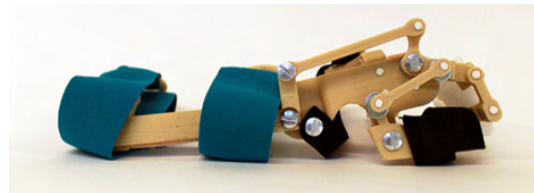

(b) Passive orthosis enhancing the tenodesis effect. This research device is available as a [DIY project](#) [92].

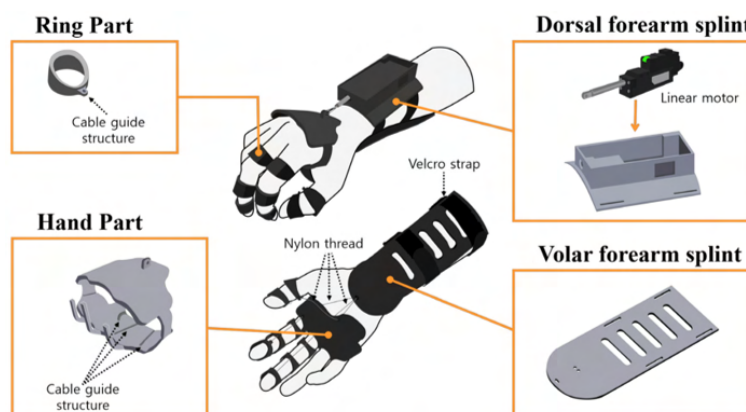

(c) Motorized orthosis for wrist extension, enhancing the tenodesis effect. This is a research device [76].



(d) Motorized thumb orthosis for key grip assistance. This device is expected to be available on the market at some point [108].

Figure 2.3: Devices focusing on key grip and whether they are research devices or available.

2.2 Humanlabs

2.2.1 Fab Labs

Fab labs - fabrication laboratories - are collaborative fabrication places. They are regulated by Massachusetts Institute of Technology (MIT) and the FabFoundation, which identifies a fabrication place as a Fab lab based on defined guidelines and the physical and digital equipment available. The Fab lab spirit is similar to the maker spirit and the DIY and open-source movements. As such, a Fab lab is a place of learning and sharing skills towards realizing innovation. Members can use common digital tools and fabrication equipment such as 3D-printers, laser cutting machines, soldering irons - and more - to build technical project of their own design, or a documented one.

2.2.2 Humanlab philosophy

Humanlabs are Fab Labs dedicated to technical aids for people with disabilities. They aim at self-repair by involving volunteers and technical, medical and engineering professionals around a project leader with a disability to develop a customized technical aid. Some Humanlabs hold a weekly open house for the public to discover what they do. This open house also provides the opportunity for people with disabilities to bring their ideas or problems.

The DIY objects are not medical devices. Their approach is to customize or complement what is commercially available - or address a requirement that industries may overlook because of their limited market potential. To ensure that the devices built in Humanlabs can be replicated by anyone who needs them, they are designed to be low-cost and to require only equipment that can commonly be found in Fab Labs. Additionally, the designs and instructions are documented online as open-source.

Partly due to this approach, the Humanlab network has expanded since the creation of My Human Kit, the first Humanlab in Rennes, France in 2017. They have spread the Humanlab philosophy, leading to the creation of other Humanlabs, such as the Humanlab Saint-Pierre in Palavas-les-Flots. The network maintains strong relationships between stakeholders, including Humanlabs, schools, manufacturers, and research institutes. Sharing of documentation, projects, and participation at *Fabrikariums* strengthens these relationships. A *Fabrikarium* is a hackathon-type event where multidisciplinary teams are formed around a project owner with a disability, and work for several days on their project. Most of the time, projects in progress during *Fabrikariums* are prepared beforehand to ensure a working prototype is produced within a couple of days, and these projects are continued after the event, as depicted by 2.4. These events are important opportunities for people to meet and share ideas. Additionally, they create excitement for projects that are intended to be worked on both before and after the event.

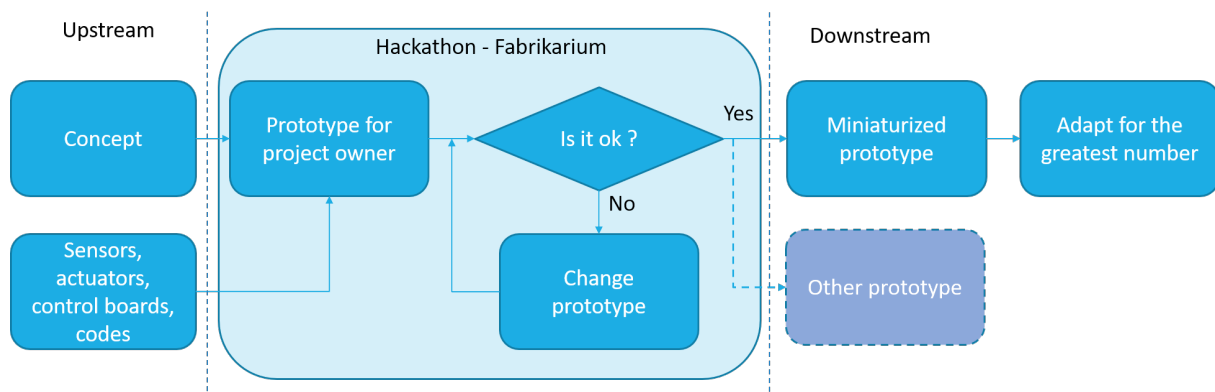

Figure 2.4: Framework for most projects developed in Fabrikarium events.

In the Humanlab philosophy, the process of creating a device is at least as important as the device itself. A person with a disability being the project leader enables them to guide the entire design of the artifact, and by doing so they become more familiar with their own technical aid and even their disability. Thus, they understand the functioning of the created device, how to use it as intended and, if necessary, how to fix it or make it evolve. Because of this, Humanlabs are not just places for prototyping and innovation, but also for socialisation and reappropriation of the stakes of a disability.

2.2.3 Humanlab Inria



Inria joined the Humanlab network in 2021 due to the efforts of Christine Azevedo¹ and Roger Pissard-Gibollet². As the HumanLab Inria (HLI) is distributed across different Inria centers, it is not a place one can visit. Its work includes preparation and participation in Fabrikariums and other hackathon-type events related to disability, where it brings innovative research technologies, devices, skills, and approaches. The Humanlab philosophy also brings to Inria a reproducible and open-source approach for implementing specific needs from people with disabilities. Besides having a direct societal impact, researchers from HLI believe that needs addressed by Humanlabs could be good for research as they are expressed directly by the people concerned, and are kept in the development process. This reason made me join HLI at its creation to lead the Exofinger project.

To ensure that the public can replicate our work, we employ open-source design software such as Kicad for electronics and Freecad for mechanics. The machines used for manufacturing are found in common Fab Labs and include 3D-printers, laser-cutting machines and sewing machines. The chosen hardware is also accessible, e.g., Arduino or RaspberryPi for controllers. These control boards are meant to be connected to sensors or actuators to interact with the environment.

¹CAMIN team, Montpellier, Inria Université Côte d'Azur

²SED, Inria Grenoble

2.3 Exofinger, from Fabrikarium to experimental research protocol

2.3.1 The event and its preparation

The Exofinger project was conceived to meet the need of Bastien, who has complete C6 tetraplegia. He expressed the need to grasp objects with a key grip, with a focus on grasping a pen to sign a document. He has voluntary wrist extension but does not have the use of his hands and his long fingers are flexed with spasticity. Bastien became the project owner for Exofinger, which was featured in the 2020 Fabrikarium in Rennes, organized by My Human Kit. Members of the future [HLI](#) participated along with those from Humanlab Saint-Pierre and engineers from ArianeGroup.

Before the event, Bastien and Inria members drafted specifications and selected team members to ensure diverse and complementary skills and expertise. A scientific and technical review was performed on research articles as well as [DIY](#) open-source projects. A simple cable driven concept and actuators, sensors and control boards were separately tested in order to make the most of the available time during the event.

This three-day prototyping workshop gathered nine people around Bastien. Over that short time period, two Exofinger prototypes were produced. Both are cable driven and work on the same principle: by pressing a simple push button, the control unit commands the linear motor, which pulls or releases a cable connected to the thumb, closing the grasp or giving slack to manually open the thumb. One prototype is composed of a 3D printable part that is donned like a ring on the four long fingers where a small motor is placed, on the right in [Figure 2.5](#). This device pulls the cable up to a ring on the thumb. The other one, on the left in [Figure 2.5](#) is made of a custom made textile glove and a control unit on the forearm. The cable passes from the control unit through a sheath to the glove and then through sheaths inside the glove.

Although both prototypes had obvious drawbacks (such as lack of stroke, size and power needs), both were functional. The project owner can don the device, use a pen, and remove it autonomously. Thus, he had the opportunity to choose between these two concepts. The glove version was selected as it is more discrete and the user is familiar with using propulsion gloves for his wheelchair.

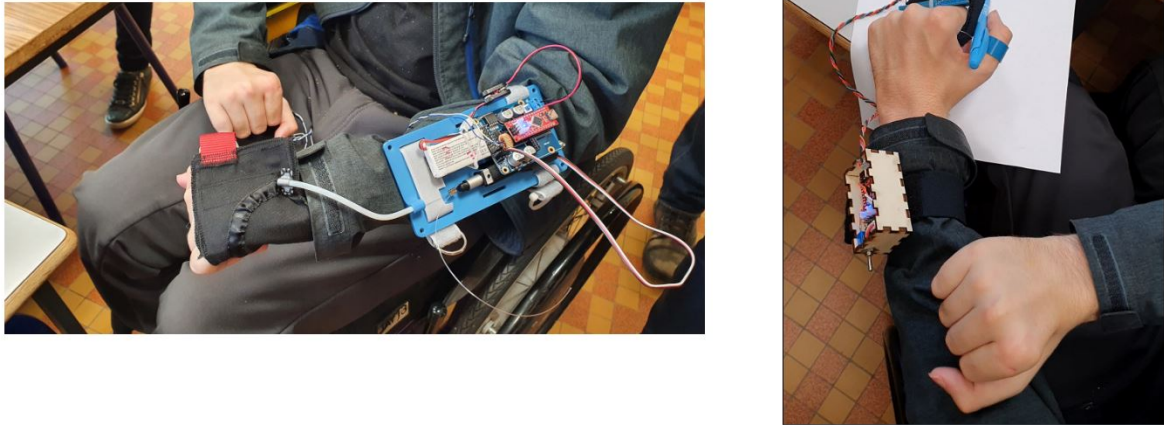

Figure 2.5: Both Exofinger concepts developed during Fabrikarium 2020.

In addition, open source documentation³ was produced and continues to be updated to allow access to the public.

2.3.2 Contribution of the thesis

Based on this experience and the prototype developed for a specific user, we developed a generic solution. As individual needs can generate new research problems, we also considered other potential device users. By starting with a [DIY](#) system, we aimed to generalize it to meet a class of needs and measure its technical and clinical effectiveness.

The proposed solution included a technical upgrade to reduce the device size, increase practicality, improve power efficiency, and reduce the overall cost. Moreover, for a single task such as holding a pen, a passive orthosis may be more appropriate. As the advantage of an active orthosis is its versatility in different tasks, we decided to explore various activities of daily living too.

As a result, we designed a second version of the Exofinger device with various upgrades and proposed an experimental protocol with the primary objective of determining the usefulness of the approach for other users with different profiles, and elaborate on the modifications required to meet those needs.

2.4 Device

The objective is for this assistive technology to be genuinely used in the daily lives of individuals with hand paralysis. To this end, the proposed orthosis design is documented online, can be made at low cost, and uses readily available manufacturing processes found in Fab Labs/Humanlabs. Thus, the design is straightforwardly reproducible by *makers*.

³[https://wikilab.myhumankit.org/index.php?title=Projets:Exofinger\\$:_:_\\$Thumb](https://wikilab.myhumankit.org/index.php?title=Projets:Exofinger$:_:_$Thumb)



Figure 2.6: A participant wearing Exofinger on the right hand with the push button located on the opposite armrest.

2.4.1 Principle

The orthosis includes a custom-made flexible leather glove and a control unit on the forearm. A cable runs from the control unit through a sheath to the glove, then through channels inside the glove to the tip of the thumb. The actuator is triggered by a push button. The principle is illustrated in Figure 2.7.

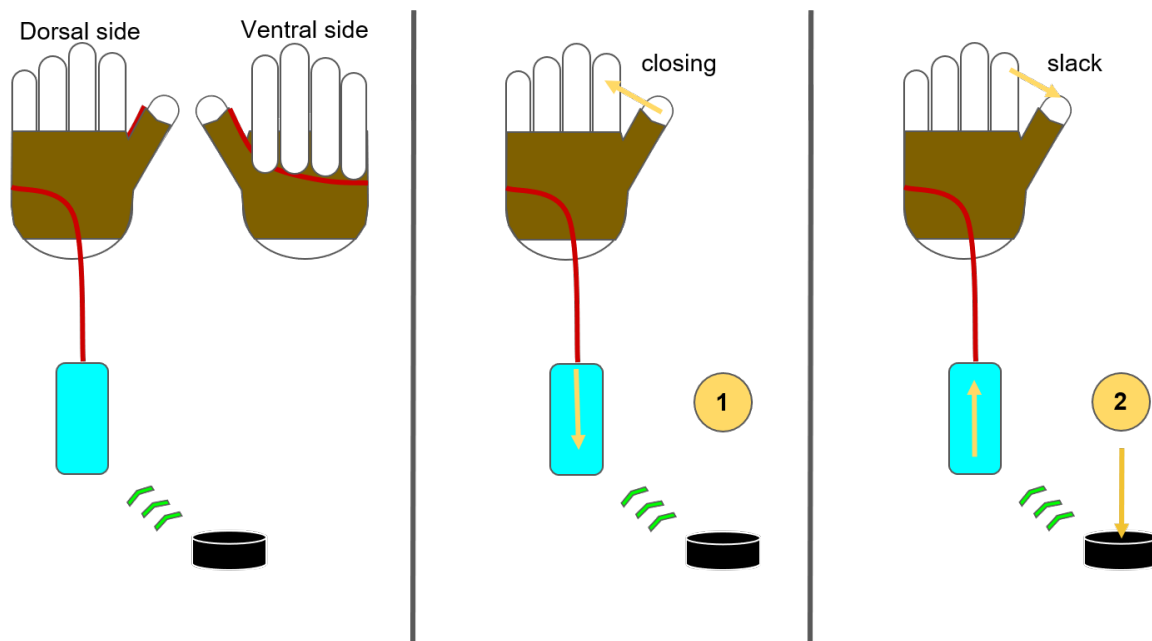

Figure 2.7: The Exofinger principle is enacted through the positioning of the cable to create appropriate thumb action.

The glove is designed to wrap around the hand, like a propulsion glove, so that individuals with paralyzed hands can don and remove them without assistance. The control unit consists of a battery, a control board with Bluetooth Low Energy (BLE), a motor driver, and a small motor that winds or unwinds the cable on a drum. By using a wireless push button as input, the motor winds the cable and produces a grip between the flexed thumb and the radial surface of the index finger.

The operation is as follows:

Upon command, the motor winds the cable onto the drum, causing the thumb to close.

The control is made in position and the target is predefined at 4 cm of winding. With a new press, the motor unwinds the cable until it returns to its initial position, giving slack to manually open the thumb.

2.4.2 Exomotor: control unit

The control unit includes intelligence, actuation, and power requirements. The positioning is designed to minimize the required space. The control board is an Adafruit Feather nRF52840 Express, chosen for its user-friendly programming in Arduino, which is widely used in Fab Labs/Humanlabs. Additionally, despite its small volume (51 mm x 23 mm x 7.2 mm), it incorporates BLE, which enables wireless connection for inputs while minimizing energy consumption. The Adafruit board is connected to a Renata ICP303450PA, 3.7 V, 500 mAh Li-Po battery. This control board sends motor commands via a Pololu DRV8838 motor driver, which was also selected for its size (10.16 mm x 12.7 mm) and reliability. The actuator is a DC motor with an operating range of 3-6 V, making it compatible with the voltage levels of the control board and driver without the need for additional components. This motor is lightweight and relatively small (24 mm x 26 mm). The 500:1 reduction ratio allows the actuator to be non-backdrivable, maintaining grip without consuming energy. Its nominal rotation speed is 10 rpm and its nominal torque is 9.8 N-cm. The cable is a 0.60 mm diameter nylon fishing line with a 21.6 kg traction, which is sufficient when compared to the power of the actuator. This cable exits the control unit via a pneumatic connector allowing the sheath to be plugged in.

The box is attached to the forearm thanks to a Velcro strap originally intended to attach equipment to a bicycle. A metal ring has been added to the end to facilitate donning for people with upper limb impairments. A micro USB-B magnetic connector is directly connected to the Adafruit board. This allows for easy connection and is necessary for recharging the unit. To improve the autonomy of the device, an on/off switch has been implemented. To avoid standby power consumption, the device can be turned off (and on) with a switch located on the side of the control unit. The connection is made in such a way that charging the battery is possible even if the button is in the off position. All components and their positioning are shown in Figure 2.8.

The box is 3D-printed and consists of three parts: the body, the lid, and a separation that prevents direct contact between the battery and the control board, while also securing the latter. As part of the protocol, three control units were manufactured.

2.4.3 Glove

A sheath housed in the glove allows the cable to reach the thumb. The path of the cable is illustrated in Figure 2.9, and the cable enters through a 5 mm (inner diameter) sheath on the back of the hand. A pneumatic connector identical to the one on the control unit, along with a 3D-printed component, allows adjustment to the sheath's size. The sheath, which has an inner diameter of 1 mm, follows a circular path to the palm's ventral side, passing through the outer side. On the ventral side, the cable travels straight up the palm and halts until it reaches the distal phalanx of the thumb. If there were no interruption, the sheath would obstruct closing.

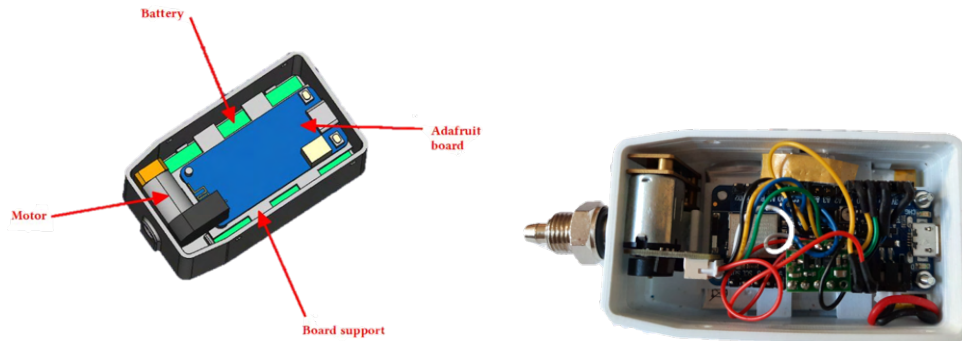

Figure 2.8: Control unit components: FreeCAD model (left) and opened prototype (right).

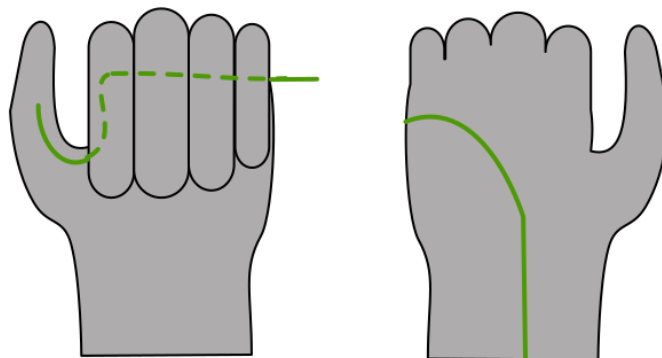

Figure 2.9: Routage of the cable inside the glove: palmar side on the left, dorsal side on the right.



Figure 2.10: A propulsion glove wraps around the hand to be donned.



Figure 2.11: The Exofinger unfolded (left) is donned by wrapping (right) it around the hand.

The gloves were made from soft leather, such as deer. After testing various materials including jeans and leathers of varying thicknesses, the selected material being supple enough to allow movement emerged as crucial. Leather was chosen for its durability and comfort, like propulsion gloves which can be seen unfolded in Figure 2.10. As with the latter, the user can put on the glove by wrapping it around the hand instead of slipping it on, enabling donning without external aid. Figure 2.11 shows the glove unfolded and wrapped.

Putting a glove on a paralyzed hand is extremely difficult, if not impossible for a spastic hand (that causes finger stiffness, typically in flexion). A metal ring is also provided at the end of the glove, like on the control unit, to assist donning.

The sewing pattern of the glove positions the thumb in the open position. An adequate fit between the glove and the morphology of the user's hand is crucial. To achieve this, a pattern generator has been developed by Laurence Boissieux⁴. A customized sewing pattern is generated from eleven hand measurements. A Graphical

⁴Inria SED Grenoble, [HLI](#) member

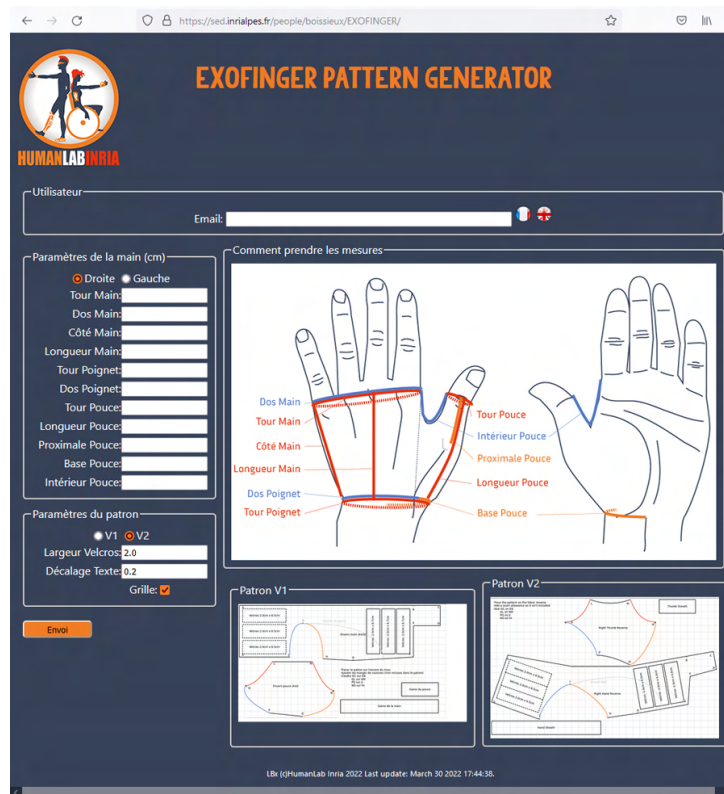

Figure 2.12: Web interface for the glove sewing pattern.

User Interface (GUI) under Python is available for generation of the pattern. A web site allows people to request a pattern without the need for Python (Figure 2.12).

In order to test the device on various participants, three sizes of glove were made, as providing a custom-fit glove for each protocol participant was not feasible. The three gloves were dimensioned to accommodate "small," "medium," and "large" hand sizes. In total, six gloves were manufactured accounting for both the left and right hands. Without modifications, this would require six control units. In addition, a glove attached to the motor unit is difficult to wash. Thus, to simplify the washing of the gloves and decrease the number of control units required for the protocol, a system was implemented to detach the gloves from a single motor unit. For this, a cylindrical screw clasp - generally used for jewelry - was added to the cable between the glove and the motor unit.

2.4.4 Interface modalities

Users command devices through various sensors, resulting in interface modalities that can vary significantly in nature, encompassing tongue commands, ElectroMyoGraphy (EMG) readings of voluntary muscle contractions, basic push buttons, Inertial Measurement Unit (IMU), ElectroEncephaloGraphy (EEG), voice commands, and more.

The first user from the Fabrikarium requested a wireless push button. Considering the Humanlab context, this simple solution is appropriate. However, the push button needs to be of reasonable size and sufficiently sturdy and reliable to be suitable for different types of disabilities. The idea is for the button to be placed as desired by users, such as on an armrest of a wheelchair, behind the head, or on a table for instance. The designed button is composed of three microswitches that send the

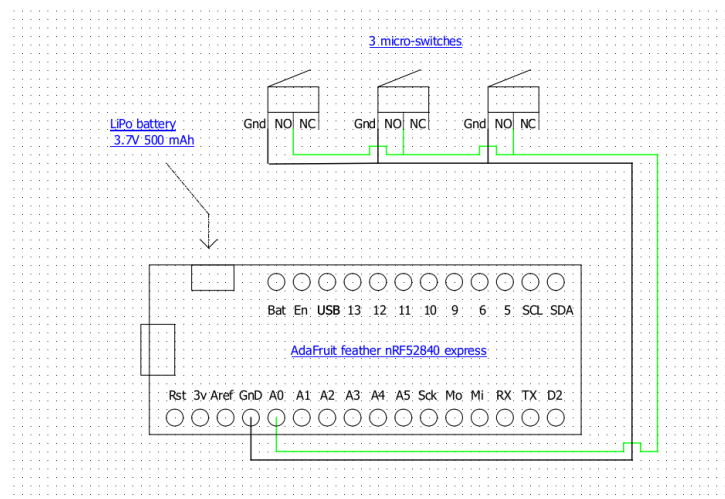

Figure 2.13: Schematic of designed push buttons.

tightening/loosening command to the control unit when one of them is pressed. The schematic is presented in Figure 2.13.

Signals are processed by the same type of control board as that used for the motor unit. The communication is then carried out using the BLE of the control board. The Adafruit nRF52840 Express is powered by an identical battery to that used for the control unit. These choices help to reduce the number of different components and thereby simplify the replication of the device. Two versions of the button have been designed, one with a round shape and one with a rectangular one, allowing it to better fit into different possible locations. The two designs are presented in Figure 2.14.

An Android application using Bluetooth has also been implemented as a substitute for the button (Figure 2.15). This application allows, via a slider, adjusting the cable length which is initially set to 4 cm. By defining the zero position, the application allows a shift on the cable winding, thus increasing the customization of the device. The battery level of the motor unit is displayed on the top right of the screen. The application is necessary for attaching or detaching the control unit and the glove. Indeed, for this, the clasp must be accessible, completely pulled out of the sheath, which necessarily requires more than a displacement of 4 cm.

2.5 Experimental protocol

The main objective is to determine if this type of solution provides functional benefits to individuals with hand deficiencies. All types of deficiencies were considered, and determining the profile of users that could benefit from such a device was of particular interest. Along with functionality, usability is essential, especially given that technical aids are often abandoned.

The protocol utilizes two sessions. The first session enables participants to familiarize themselves with the device, while the second session is dedicated to functional evaluations and device critique. As participant feedback is very valuable, an open discussion was proposed at the end of the protocol.

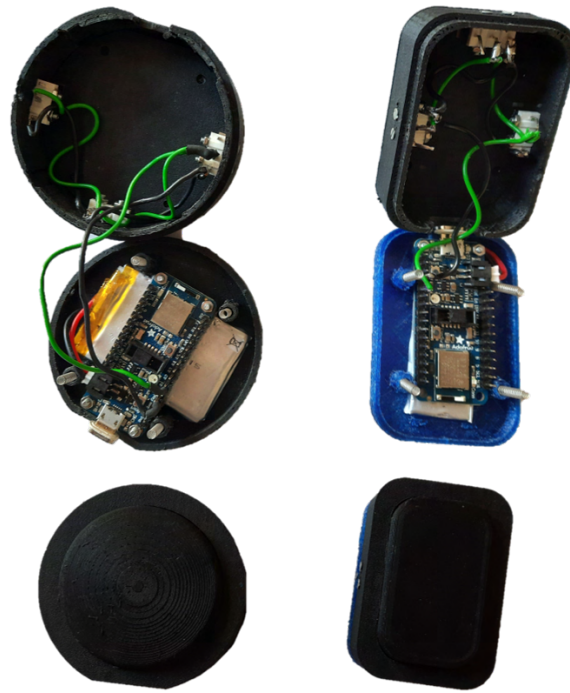

Figure 2.14: Round and rectangular buttons for triggering Exofinger, closed and opened.

Figure 2.16 illustrates the protocol, [a more detailed flowchart is available](#). This experimental protocol has been approved by the Inria ethics committee *Comité Opérationnel d'Evaluation des Risques Légaux et Ethiques (COERLE)* ([authorization n° 2021-47](#)).

2.5.1 Participant recruitment

As one of the main objectives of this protocol was to determine which populations could benefit from such a device, the inclusion criteria were modest: participants needed to be able to understand simple instructions and have a grasping deficiency in their key grip. Recruitment was conducted at Humanlab Saint-Pierre in Palavas-les-flots and Centre Bouffard Vercelli *Union Sanitaire et Sociale Aude Pyrénées (USSAP)* Perpignan.

2.5.2 Experimental protocol

In the first session, participant data is collected, and the device is introduced along with an explanation of the protocol. Participants are then given the opportunity to freely perform tasks with the device. Different evaluations through questionnaires and an open discussion conclude the session. The functional tasks considered for this protocol were determined based on a brief literature review [92, 30, 55]. The challenge is to identify daily activities that rely solely on key grip or allow for its use without involving the arm, while maintaining the practical sense of the task. The five resulting tasks are the following:

1. Hold a credit card



Figure 2.15: Android application to adjust and use Exofinger.

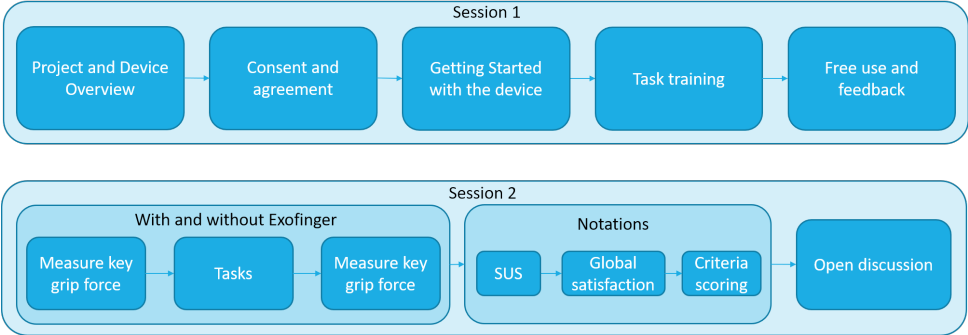

Figure 2.16: The experimental protocol for Exofinger.

2. Take a credit card to insert it in a reader then, withdraw the card to put it back at the start position
3. Hold a pen
4. Write with the pen
5. Hold a bottle (25 cl)

Tasks 1, 3, and 5 exclusively require thumb movement, enabling us to assess the performance of the Exofinger device without any bias from participants' disability to perform other movements associated with the upper limb. To prevent arm fatigue, participants are provided with an arm support for these tasks, which are repeated three times. On the other hand, tasks 2 and 4 involve everyday movements that require actions beyond the thumb and are performed only once. These tasks evaluate the potential device's adaptability for every-day use by individuals. For tasks 3 and 4, a thickener may be used depending on participants capabilities; evaluations with and without the device are performed under identical conditions.

To compare the results, the tasks are performed with and without the device. A random draw determines whether the device is used first or second to avoid any biases related to learning or fatigue. The second session involves the functional evaluation and usability assessment of the system. The grip strength in the *key pinch grip* position is measured three times, at the beginning and end of the manipulation, with and without the orthosis. Then, the participants perform the functional tasks in order, from 1 to 5, starting with or without the device, depending on the random draw. After completing the tasks under both conditions, they are asked to rate the device by three means. First, the SUS is performed. Second, participants are asked to provide an overall satisfaction rating. Third, they rate the device according to five criteria. Finally, there is an open discussion regarding the use, improvements, and any other remarks.

Blank forms used in the Exofinger protocol are [shown in appendices](#).

2.5.3 Outcome measures

Key grip force, with and without the device, is measured with a dynamometer (Jtech medical's device shown in Figure 2.17). The objective is to determine whether Exofinger improves, deteriorates, or has no effect on gripping strength.



Figure 2.17: *Commander Echo Console and pinch sensor* from Jtech medical

For functional tasks, the impact of the device is quantified by two results per task: success or failure (binary) and completion time. For tasks 1, 3, and 5, the gripping time corresponds to the time during which participants hold the object with only their hand without dropping it. The task is considered successful if the object can be gripped for more than 5 seconds. After 30 seconds, participants are asked to put down the object (not part of the task).

Task 2 is considered successful if participants have succeeded in grasping the card, inserting it into the reader, releasing it, picking it up again, removing it from the reader, and then putting the card back. All steps are counted in the time.

Task 4, writing, is considered successful if participants are able to form the letters of the phrase "I am happy to be here"⁵ in a legible manner. The time taken is the time required to write this sentence.

The feedback provided by participants is crucial in developing a device that addresses their specific needs effectively. That is why the qualitative evaluation comprises three parts:

- the [SUS](#);
- a simple overall notation out of ten;
- a score over 5 selected criteria.

The [SUS](#) questionnaire is a well-known and accepted tool used by health professionals to assess participants' agreement on statements related to ease of use, confidence in the device, and ease of learning. This questionnaire consists of rating the agreement of participants on a 5-point scale to 10 statements about usability.

The overall satisfaction rating provides a direct indication of participants' thoughts on the device, rated from 1 to 10. Additionally, the rating on criteria such as size,

⁵In French: "Je suis content.e d'être ici"

Participant number	Disability	Time since disability
1	Tetraplegia C6-C7	26 years
2	Tetraplegia C6-C7	38 years
3	Tetraplegia C6-C7	52 years
4	Plexopathy	18 months
5	Hemiplegia	4 months
6	Tetraplegia C5	18 months
7	Hemiplegia	1 months
8	Tetraplegia (Guillain-Barré)	3 years
9	Tetraplegia C4	4 years

Table 2.1: Type of disability and time since it occurred for Exofinger participants.

weight, aesthetics, comfort, and functionality can help identify potential areas for improvement, with each criterion being rated from 1 to 5.

2.6 Results

2.6.1 Participants

Nine participants were recruited. Table 2.1 presents their type of disability and the length of time they have had the disability. Six participants have tetraplegia, two have hemiplegia, and one has plexopathy. The durations of participants' disabilities ranges from 1 month to 52 years (624 months). Notably, P1 underwent tendon transfer surgery and has a highly efficient voluntary key grip. As a result, while using the device, P1 was asked not to use his voluntary key grip as much as possible, allowing the device to perform the key grip alone. Additionally, P2 and P3 underwent the first session twice due to their feedback that the device lacked sufficient power. Consequently, the reduction ratio of the actuator was modified to increase the device's power. After 10 months, P2 and P3 participated in the first session again with the same device as the other participants. The second session was conducted immediately after the first session for each participant.

All participants used the medium-sized gloves. Out of the nine participants, 5 used the left and 4 the right. As the dominant hand of P4 is fully functional, P4 used the device on his non-dominant hand.

2.6.2 Key grip force

The data did not reveal any significant difference in key grip force between measurements before and after task completion. Thus, Figure 2.18 only presents data from before. Except for P1 - who had undergone a tendon transfer surgery resulting in a notably strong voluntary key grip - only P5 experienced a decrease in key grip force with the device, whereas the other seven participants demonstrated a benefit from Exofinger in terms of key grip force. Notably, P3 displayed no force at all without the device.

Participant number	Force (N)		
	without	with	difference
1	18.9	3.9	-15.0
2	2.3	3.9	1.6
3	0	2.3	2.3
4	10.5	12.1	1.6
5	4.3	3.9	-0.4
6	1.5	3.9	2.4
7	1.6	2.9	1.3
8	1.0	2.0	1.0
9	1.0	2.0	1.0

Table 2.2: Key pinch force (N) per participant

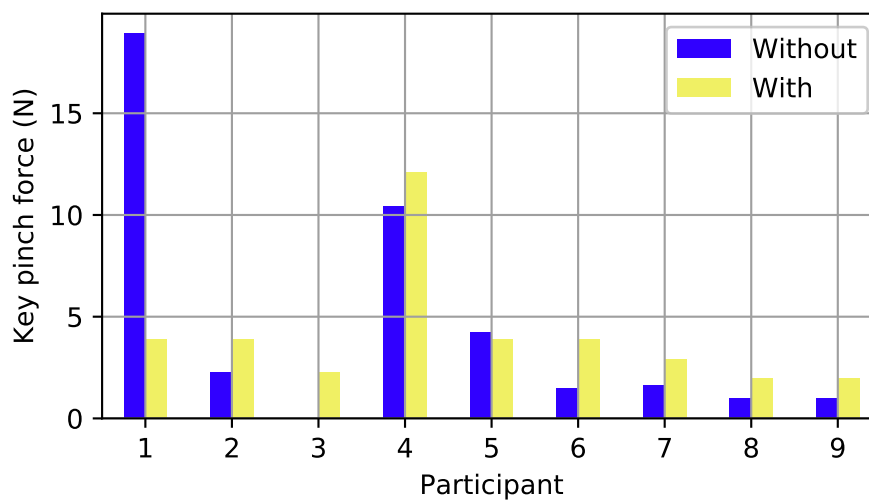

Figure 2.18: Key grip force with and without the device for each participant.

2.6.3 Task results

Task 1: Hold a credit card - All participants were able to hold a credit card with and without Exofinger, except for P6 who was unable to complete the task without the device and P7 who had two failures and one success without the orthosis.

Task 2: Insert and withdraw the card into/from a reader - Five participants were able to complete task 2 without the device, including P5 who was unable to do so with Exofinger. Among those who did not succeed in the task with the device, all but one were unable to withdraw the card from the reader. In terms of completing the task, only P8 benefited from the device by successfully inserting the card into the reader, which was not possible without the device.

Task 3: Hold a pen - All of the participants were able to hold a pen for 30 seconds, three times. Four of them required a thickener to do so. When not using the device,

two participants used balancing to hold the pen, especially through supination, as seen in Figure 2.19.



Figure 2.19: P6 and P7 using balancing to hold the pen.

Task 4: Write with the pen - Regarding writing, the device did not affect completion of the task. However, it did affect the required time for the six participants who were able to write the sentence. For five of them, the device was a disadvantage ($+11 \pm 5$ seconds), while P7 greatly benefited from the device, with a gain of 64 seconds. These results are shown in Figure 2.22. Furthermore, P7 was able to improve the quality of their writing (Figure 2.20), whereas there were no noticeable differences for four of the participants, and P2 experienced a disadvantage with the device (Figure 2.21). Without the device, P2 used the pen between the proximal phalanges of the index and middle fingers, while using the device the pen was held between the thumb and the index.

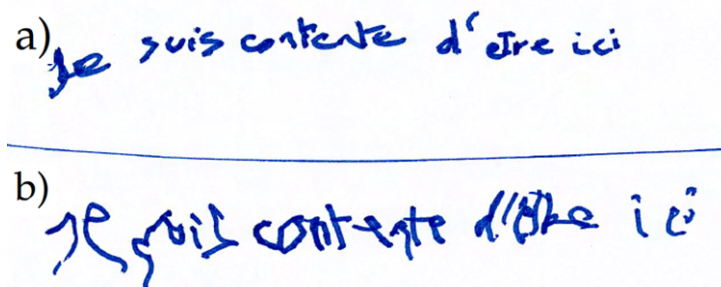

Figure 2.20: P7's writing a) with the device, b) without the device.

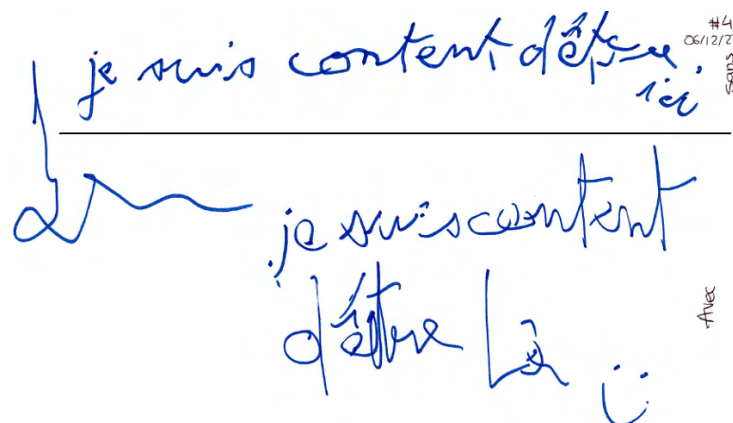

Figure 2.21: P2's writing: on top without the device, on bottom with the device.

Task 5: Hold a bottle (25 cl) - Exofinger did not impact the task of holding a bottle, seven participants succeed with and without the orthosis. P7 used supination to hold the bottle without the device.

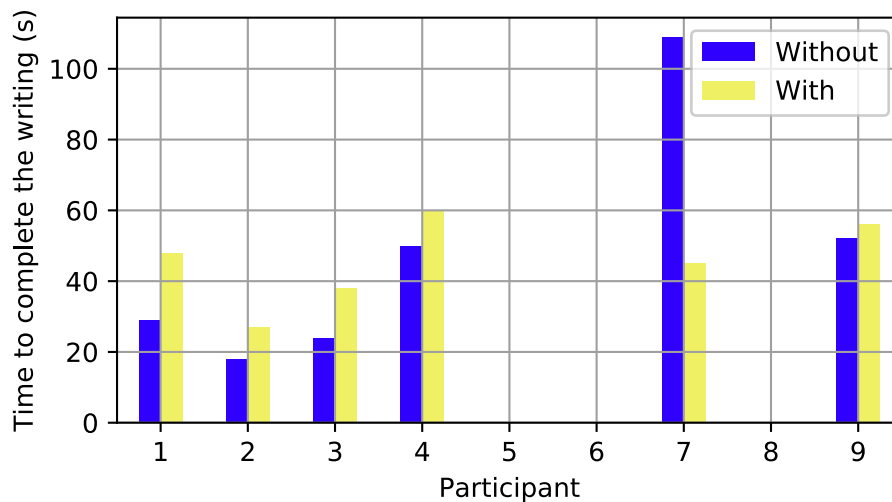

Figure 2.22: Writing task results where no time shown means that the task was not completed.

2.6.4 Evaluations through questionnaires results

SUS score - According to [109], in order to calculate the **SUS** score, the first step is to sum the score contributions from each item. Each item's score ranges from 0 to 4. For items with odd numbers, the score contribution is the scale position minus 1. For items with even numbers, the score contribution is 5 minus the scale position. Multiplying the sum of the scores by 2.5 gives the total value of **SUS**. Thus, the lower the score of an item, the less usable the equipment. Total **SUS** scores have a range of 0 to 100.

Table 2.3 shows scores by participant and by item. The mean total score is 71.67 ± 14.1 .

Participant number	Item number										Score
	1	2	3	4	5	6	7	8	9	10	
1	0	2	1	4	3	4	4	3	4	4	72.5
2	0	0	0	0	2	0	4	4	4	4	45
3	0	0	4	2	2	0	4	4	4	0	50
4	3	1	4	2	4	3	4	4	4	4	82.5
5	0	3	2	2	3	4	3	4	3	4	70
6	3	4	4	0	2	4	4	4	2	3	75
7	3	4	4	1	3	4	4	3	4	3	82.5
8	4	4	4	0	4	4	4	2	4	1	77.5
9	4	4	4	0	4	4	4	4	4	4	90
Average	1.9	2.4	3	1.2	3	3	3.9	3.6	3.7	3	71.7

Table 2.3: **SUS** Score by item for each participant. Items are details below.

Items of **SUS** was enunciated as follow⁶:

⁶In French

Participant number	Score
1	2.2
2	0
3	4.4
4	7.8
5	0
6	5.6
7	8.9
8	7.8
9	10
Average	5.2

Table 2.4: Overall satisfaction score.

1. I think that I would like to use this system frequently.
2. I found the system unnecessarily complex.
3. I thought the system was easy to use.
4. I think that I would need the support of a technical person to be able to use this system.
5. I found the various functions in this system were well integrated.
6. I thought there was too much inconsistency in this system.
7. I would imagine that most people would learn to use this system very quickly.
8. I found the system very cumbersome to use.
9. I felt very confident using the system.
10. I needed to learn a lot of things before I could get going with this system.

Overall satisfaction score - Because the overall satisfaction was evaluated from 1 to 10, the values have been decreased by 1 and multiplied by $\frac{10}{9}$ to have a score out of 10, allowing proper comparison with other score. Table 2.4 presents the score given by each participant. The mean value of the overall satisfaction is 5.2 ± 3.6 .

Criteria score - The criteria scores range from 1 to 5 for each of the 5 criteria. To obtain a score out of 5, the values has been decreased by 1 and multiplied by $\frac{5}{4}$. Table 2.5 presents the score by participant and by criteria. The average overall score is 3.4 ± 0.9 .

Score summary - The criteria scores and the overall satisfaction rating were transformed to a 100-point scale to enhance visualization of the difference between scores. Figure 2.23 presents an overview of these scores for all participants.

Participant number	dimensions	weight	aesthetic	comfort	functioning	Average
1	2.5	2.5	1.2	2.5	2.5	2.2
2	3.8	3.8	3.8	3.8	3.8	3.8
3	3.8	3.8	1.2	3.8	3.8	3.2
4	5	5	5	5	5	5
5	2.5	1.2	2.5	2.5	3.8	2.5
6	2.5	2.5	2.5	3.8	1.2	2.5
7	2.5	2.5	1.2	3.8	3.8	2.8
8	3.8	3.8	5	5	3.8	4.2
9	3.8	3.8	5	5	5	4.5
Average	3.3	3.2	3.1	3.9	3.6	3.4

Table 2.5: Criteria scores by participant.

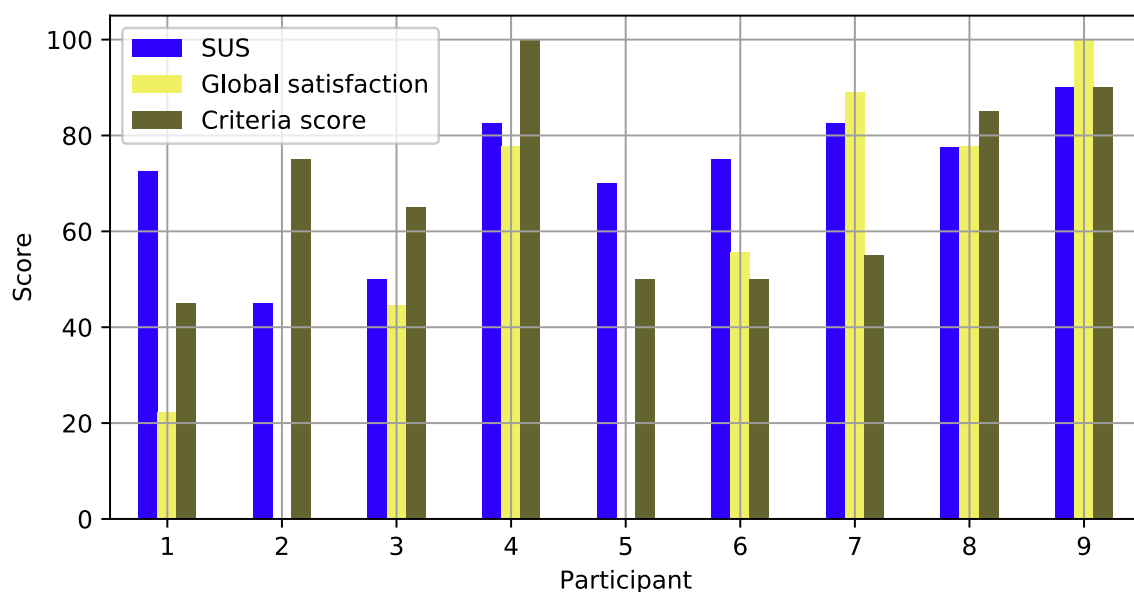

Figure 2.23: The three scores by participant.

2.7 Discussion

Regardless of the scoring method, P4, P8, and P9 gave the highest scores to the device. This is a positive outcome, especially as P4 does not have the same disability as P8 and P9, indicating that a wider range of users could benefit from Exofinger. However, no real conclusion can be drawn from the two participants with hemiplegia. The small sample size precludes drawing any conclusive findings. A larger sample size would enable more reliable conclusions to be drawn regarding user profiles. Additionally, P8, P7, P6, and P2 were not able to correctly flex the long fingers to provide a stable basis for applying the thumb, which is necessary for a key grip. It would be conceivable to add a passive orthosis to force the MCP flexion of the long fingers, allowing the thumb to come into contact with them for key-grip holds. This idea was actually suggested by a participant during the open discussion.

A trend appears to emerge in relation to the time since participants have been

living with their disability. Indeed, the first three participants had respectively more than 300, 450, and 600 months since their spinal cord injuries (compared to a maximum of 56 months for the other participants). During the open discussion, the caregiver of P3 expressed that the device would be beneficial for individuals with a recent SCI, particularly if the device was waterproof. On the contrary, individuals who have been living with tetraplegia for an extended period of time may have already developed compensatory techniques and may not find the device as useful. Their experience has enabled them to develop compensatory strategies to perform daily tasks independently without external assistance. For example, by holding a pen between the proximal phalanges of the index and middle fingers and using their other hand, they are perfectly capable of writing. When performing tasks with both hands or with the help of their mouth, the usefulness of a device like Exofinger becomes questionable. To justify its use, the device should provide a substantial functional benefit, which was not the case during the experiments for the three first participants. However, P2 expressed interest in using a similar device with more power for activities such as DIY or painting, if the device could secure grips on tools. Nonetheless, these three participants have been recruited through the Humanlab Saint Pierre, which they usually frequent. They are very active members and might not be representative, thus the previous reasoning could be biased.

Regarding tasks 2 and 4, some participants encountered difficulties as they required movements other than thumb flexion such as positioning of the hand through prono-supination and elbow and shoulder movements. During the open discussion, participants P5 and P8 suggested the need to assist other movements, particularly arm movements, to improve positioning. In relation to task 4, the results for writing were found to be highly variable, with some participants showing promising results. It is worth noting that some participants did not use their dominant hand or their preferred grasp method. Additionally, when the thickener was used, it raised concerns about the ecological validity of the task. One of the main advantages of orthoses over other technical aids, that adapt objects, is their versatility, enabling their use across multiple tasks. However, if the device requires a specific technical aid to be used, its practicality and usability become limited, and the device seems to be doomed to abandonment.

To improve functional assistance, adding the capacity to open in addition to closing is worth considering. Based on the experiments conducted, none of the nine participants requested assistance with opening, as they naturally used pressure on an object to position the thumb. The glove is designed with an open default position, which is advantageous for return. During the open discussion, P4 stated that the glove helped him with his voluntary opening of the thumb. However, this default position is also a significant flaw, making it difficult to close on the leather aggregate, which also likely exerts pressure on the sheath and cable.

Ultimately, this open position is likely an impediment to closure, causing power loss, and power is precisely what the device lacks the most. P6 benefits the most from the device in terms of key grip force, achieving only 2.45 N, far from the desired 10 N for performing daily tasks. Except for P4, the key grip force is roughly constant among participants with a mean of 3.1 N and a standard deviation of 0.86 N. We believe the difference in P4 force data relies on the positioning of the force sensor, that was not the

same as for other participants. Obviously P1's tendon transfer surgery overshadowed the device as seen in Figure 2.18.

None of the participants raised concerns about the device being too noisy. Discretion represents a significant reason for abandonment, making it worth considering in the design of technical aids. On the other hand, eight out of nine participants stated during the open discussion that the device did not provide enough power. More power would lead to more power consumption and the autonomy - and lifespan - of the device have yet to be tested. It should be noted that the same control unit was used throughout all experiments and preliminary development tests, and the fishing line appears to be slightly worn.

Finally, the SUS scores indicate that the device is easily adopted by users, as evidenced by the results of items 3, 7, and 10 regarding ease of use. Participants only received a few minutes of training before the evaluation. It would be interesting to investigate if more training would eliminate the time disadvantage of using the device and its impact on task completion. Furthermore, the installation process of the device, particularly for the control unit with the strap that requires passing a loop around the arm, makes it very difficult for individuals with paralysis in both upper limbs to install it on their own. We believe that this factor largely contributes to the score of item 4 of SUS, which indicates the need for a third party to use the device.

2.7.1 Perspective for this device

The lack of power is clearly the most important drawback to be addressed. To enhance grip strength, several solutions could be explored:

- Change the sewing to set the default position of the glove to closed position. This could help with closing and avoid having too much matter obstructing the closing.
- It could be interesting to add a level shifter to deliver more voltage to the current motor. The latter is effective on the range 3-6 V and, as the motor is directly wired to the battery, barely reaches 3.7 V.
- Otherwise, a more powerful actuator is necessary. This would lead to an overall change in the control unit becoming bulkier and heavier.

To reduce overall weight, it would be advisable to design the gloves to include a 3D-printed pneumatic connector. As solid metal components, their current weight is significant. Additionally, the connector could be lengthened to avoid potential lifting of the glove at the cable entry point. By reducing movements and deformations, power losses can be reduced. That being said, the downside of cable-driven orthoses is precisely these losses. Friction can cause power loss estimated at 30% of total power, despite low-friction sheaths. Moreover, the jewelry clasp likely increases friction in the sheath between the control unit and the glove, and it requires a sheath length at least as long as the desired winding. Finally, the rigidity of the sheath size can hinder wrist movements.

Furthermore, the adhesion at the thumb does not appear to be sufficient, despite the addition of an anti-slip patch. It would probably be preferable to leave the fingertip

free from the glove. This would allow for the use of natural contact surfaces and adhesion while also potentially providing sensory feedback.

With regards to the control system, despite the control position being set to a 4 cm winding, the current motor power is insufficient to achieve this position. A more suitable solution would be to adopt a control scheme similar to the one used in Grasphyb. Therefore, the control of Exofinger could be executed without a position target on closing, i.e. without position control. When a closing input is received, the control board would save the current position, which is likely to be 0, and continue closing at maximum speed/power until the position does not vary fast enough. By adjusting this threshold, it could be ensured that the device closes as much as possible without causing any undue force once the grasp is complete, thus avoiding additional power consumption. The opening mechanism would remain a position control to return to the initial position.

Regarding the input, P7 mentioned that the device contains too many elements. It may be feasible to eliminate the activation button. In fact, some participants have expressed their opinion that the button is too bulky and suggested that an alternative method to trigger the command, such as a smaller push button or foot movement, when possible, would be preferable.

2.8 Conclusion

While the limited number of participants does not allow for rigorous conclusions, this exploratory phase has proven to be fruitful in terms of identifying potential uses and users and better understanding individual needs. We note that the device would be better used, and accepted, for specific activities and not for the entire day. Also, we know that individuals with tetraplegia could benefit from the device, and that ones with plexopathy and hemiplegia could also be interested, suggesting that other user profiles should be considered.

The current study serves as a proof of concept that Humanlabs projects have the potential to lead to interesting research and that a device designed to fulfill the need expressed by a single individual can prove to be useful for a greater number.

As for the device itself, improvements have to be made to enable its daily use. The user comments, as limited as they are, provide useful guidelines for these improvements. Interestingly, two participants asked the medical doctor, Charles Fattal, when the current version of the device would become available for their personal use. In light of the demand, the [HLI](#) intends to pursue this development.

Moreover, as an open-source project, the Exofinger concept could be adapted by *makers* to meet the specific needs of a user. Detailed documentation has been prepared to facilitate the replication and modification of the device by non-experts. The Arduino codes and FreeCAD 3D files are available online, and an assembly guide has also been prepared, which includes a list of the necessary materials and equipment, along with step-by-step instructions.

Exofinger supports the idea and the possibility of generalizing a device originally dedicated to a single individual. Also, meeting a class of needs and measuring its technical and clinical effectiveness is doable by starting with a [DIY](#) system.

Furthermore, this approach allows us to explore the balance between the complexity of the technical aid and the level of fulfillment of a requirement. The concept of only pulling a cable is straightforward and, depending on participants, the functional benefits is limited. Nonetheless, positive scores and enthusiasm from some participants suggest that we may be moving in a promising direction. This may indicate a gap between what the research and industry sectors aim to achieve and actual user needs.

The Exofinger project validates the use of cables for assisting grasping functions, as the concept used in Exofinger is simple yet effective. We are interested by enhancing the concept with more developed materials. From then on, the approach is significantly different, as the considered orthoses no longer falls in the Humanlabs' scope.

In addition, the limit - but also the initial hypothesis - of the key grip performed by Exofinger remains in whether the long fingers are flexed. We believe that assistance of the long fingers in key grip makes less sense than an assistive orthosis for another grasp also requiring long finger movements, such as power grasps.

Power grasp assistance: Grasphyb a hybrid orthosis

While a key grip is well adapted to grasping flat and thin objects and/or objects requiring fine motor control, its effectiveness decreases on bigger and heavier objects such as bottles. For such objects, a power grip is better adapted: the palm is in contact with the object and the fingers are firmly wrapped around it. Figure 3.1 depicts different types of power grips. Also, a power grasp provides a strong, secure and stable grip that is ideal for tasks such as holding tools.

If performing a key grip only requires thumb assistance (with a flexed position of the long fingers), a power grip requires the movement of more fingers. Specifically, in order to position the object in contact with the palm, preliminary extension of all fingers is convenient. Subsequently, in order to grasp the object, the thumb must be placed in opposition to the long fingers, after which all fingers should be flexed to securely encircle the object.

Consequently, any assistive orthosis designed to support this type of grip needs to support a greater number of degrees of freedom, which will likely result in a heavier or bulkier device. To avoid the need for additional motors to control finger extension, thumb opposition, and overall finger closure, various solutions can be proposed. For example, one approach could involve using elastic components that store energy to assist only in closing or opening, with the actuator assisting in the opposite direction [63]. However, as the power-to-weight ratio being a crucial factor for portable devices, any solution implemented is likely to add bulk and weight compared to electrical stimulation.

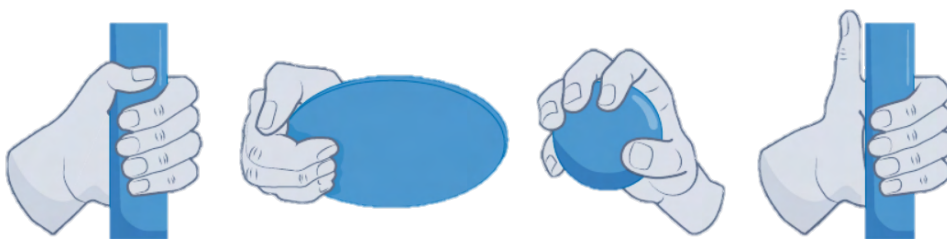

Figure 3.1: Different types of power grasps [11].

Indeed, compared to other solutions, electrical stimulation has been found to be a highly effective option. With just a small battery and electrodes, FES can produce considerable power while adding minimal weight to a device. Furthermore, this approach leverages the body's existing actuators, making it an efficient approach. However, the control of joint movements with surface electrical stimulation can be challenging due to various factors, including non-linearities, mechanical delays in muscle actuation, and proper and isolated muscle stimulation, especially for those lying deep under the skin.

3.1 Hybrid orthoses

An active orthosis paired with ES results in a hybrid orthosis. As with other orthoses, they can have various applications including assistance or rehabilitation.

3.1.1 Existing upper-limbs hybrid orthoses

Several hybrid orthoses have been developed that incorporate brakes to maintain the limb in a fixed position, allowing motion to be induced by FES while the stimulation can be switched off. These systems operate in a coordinated manner, alternating between FES action and brake action. This principle has been applied in lower-limb hybrid orthoses [110, 111, 112], as well as in upper-limb orthoses targeting the elbow [113], and both the elbow and the shoulder [114, 115]. While these devices can provide functional benefits, they are primarily designed for rehabilitation purposes to allow repetition of movements with a training perspective [116, 117]. A multicenter Randomized Control Trial (RCT), comparing a hybrid system with Advanced Conventional Therapy (ACT) in terms of frequency and duration, demonstrated a significantly greater improvement in arm function and dexterity among stroke survivors who used the hybrid system [114].

A hybrid orthosis designed to assist power grasping was developed in 2010 [118], as depicted in Figure 3.2. The purpose of this orthosis was to alleviate fatigue caused by FES in individuals with SCI or for stroke rehabilitation. The design of the orthosis was based on the observation that FES contractions result in uneven grasping force among the fingers, with the middle finger typically exerting more force, thereby compromising the stability of the grasp. The device aimed to distribute the force generated by FES equally among all the fingers. The movement was initiated by FES, while a solenoid was utilized to maintain the position. However, the study involved only five healthy subjects and did not demonstrate any reduction in fatigue induced by FES.

Moreover, certain devices, such as the OrthoJacket, a hybrid orthosis concept designed for individuals with paralyzed upper limbs, do not utilize both FES and actuators on the same joints [119]. Hand movements are facilitated through the use of FES, while elbow and shoulder movements are assisted by dedicated actuators — a fluid actuator for the elbow and two motors for the shoulder. The complete orthotic device, encompassing the actuators, energy storage components, and control unit, is designed to be mounted on a wheelchair, rendering it to the *not portable* category.

To the best of our knowledge, there is currently no portable hybrid orthosis available that specifically targets the assistance or restoration of hand grasping in individu-



Figure 3.2: Prototype of a hybrid orthosis for assisting the power grasp from [118].

als with hand paralysis. As a result, we developed a solution that combines the use of electrical muscle stimulation to elicit arm movements and employs electric motors to mechanically lock the hand in desired positions, including grasping.

3.1.2 Expected properties of a hybrid orthosis for assisting power grasp

FES has proven its feasibility in grasping tasks in individuals with upper limb paralysis by activating muscles [93, 120, 121]. However, the effectiveness and duration of such gestures are constrained by the onset of early muscle fatigue induced by FES [95]. Conversely, assistive orthoses that do not incorporate FES require additional mass and pose challenges in terms of encumbrance. To address these limitations, hybrid orthoses have been developed by integrating FES with active mechanical orthoses, aiming to combine the strengths of both approaches [122, 123]. An advantage FES offers is using small batteries to generate high forces compared to motorized exoskeletons or orthoses [124]. However, FES also presents disadvantages, including the induction of early muscle fatigue and gestures typically of a poor quality [123].

In our proposed solution, we intend to develop a hybrid orthosis that employs electrical stimulation to elicit movements in arm muscles, while motors are utilized to help produce motion and to lock mechanically at specific positions, including grasping. The mechanical architecture of the orthosis is intended to guide the movement. The primary aim of this hybrid orthosis is to mitigate muscle fatigue and enhance the quality of grasping gestures compared to using FES alone. Furthermore, by simultaneously activating FES and external actuators, the latter can be undersized, capitalizing on the force produced by the muscles themselves. This approach should result in a significantly reduced device size and weight, thereby promoting enhanced portability [124].

3.2 Components of the hybrid orthosis

The initial step in designing a hybrid orthosis involves determining the mechanical components and the electrical stimulator to be used. However, given the time constraints associated with a thesis project, developing a custom electrical stimulator and mechanical orthosis from the early stages of design is not feasible. Consequently, a decision was made to select an existing electrical stimulator from the available options. Conversely, finding a mechanical orthosis specifically designed for integration into a hybrid orthosis, particularly considering the sizing requirements for research experiments, is not readily available in the market. Therefore, the design of the mechanical component of the hybrid orthosis was outsourced to a subcontractor.

To complete the hybrid orthosis, a controller was developed to effectively manage both the actuators and the FES.

3.2.1 The mechanical orthosis: Aufratech wrist and hand orthosis

A motorized mechanical wrist and finger brace was developed by the startup Aufratech based on our specifications. The resulting device is called *Main Exo*¹. Specifications are as follows. The mechanical orthosis is designed to perform a power grasp, with passive positioning of the thumb in opposition. Assistance is required for all five fingers and the wrist. To limit encumbrance and weight, the actuation needed to be sized to work with FES, meaning the actuators should not be strong enough to induce motion on their own, also leading to a reduced weight. The joints are required to be capable of locking their position, enabling power consumption to stop once the desired position is reached for both the wrist and fingers. As the device is intended for experimentation with various participants, customization is necessary to ensure a proper fit for each participant's hand and forearm.

The resulting design, Figure 3.3, is a cable-driven orthosis. Another feature, utilizing cables, as already discussed in a previous chapter, allows for the relocation of the additional mass of the actuators to more proximal parts of the limb. This design choice reduces the overall mass of the device, resulting in lower power and energy requirements, while also preventing workspace encumbrance.

This orthosis incorporates two motor units, each responsible for actuating specific movements. One motor unit is dedicated to wrist flexion-extension, while the other is designed for 5-finger flexion. For finger extension assistance, rubber bands are utilized. The orthosis comprises three braces that can be adjusted according to the user's morphology, specifically for the hand, wrist, and forearm. To accommodate varying finger lengths, half rings are attached to the cables and rubber bands. These half rings can be positioned on each phalanx and securely fastened using Velcro straps. To ensure optimal mechanical strength, the solid components of the orthosis are fabricated using 3D printing technology, with the incorporation of carbon fiber to enhance their mechanical properties. The total weight of the orthosis is 251 g excluding the power source and control board.

While the mechanical orthosis was developed via contract, the design lacked the necessary drivers, power source, and control unit to enable proper movement. These

¹<https://aufratech.com/fr/orthese-de-main-motorisee/>

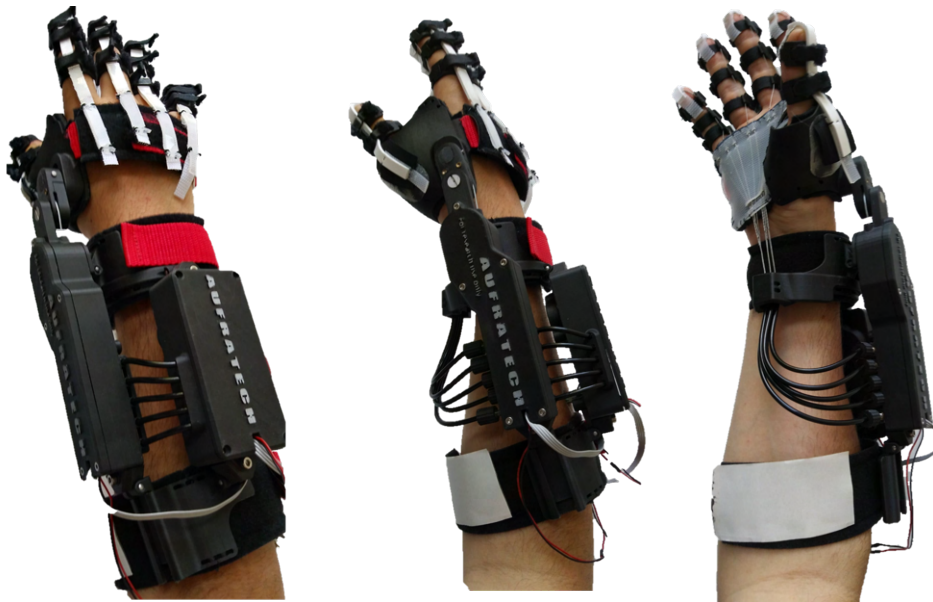

Figure 3.3: The mechanical hand and wrist orthosis from Aufratech.

components have been selected to ensure functionality of the orthosis. Furthermore, Aufratech manufactured only a single mechanical orthosis, making us the first to test it, and having no replacement. Our testing revealed some limitations and potential areas for improvement.

3.2.1.a Mechanical properties

The two motor units integrated into the orthosis consist of a 3 W DC motor (12 V, with a maximum current of 500 mA), a reduction stage, and an encoder. The reduction ratio of the system is designed to be sufficiently high, ensuring non-backdrivability and effectively locking the joints. This implies that the position of the wrist or hand is solely determined by the motor units and cannot be altered by external factors. For example, even if there is an external force, such as a deformable object attempting to cause movement, it will not affect the position of the fingers.

The sizing of the actuators in this mechanical orthosis has been specifically tailored to work in conjunction with FES. As such, motor units are not designed or sized to generate movement on their own. They require assistance from stimulated muscles or voluntary movements to induce motion. The maximum force exerted on each digit is approximately 10 N. For more detailed information, please refer to the documentation provided by the manufacturer.

3.2.1.b Limits

The current grasp mechanism exhibits imperfections, particularly when attempting to grasp non-deformable objects, resulting in failure. We have formulated two hypotheses to explain this issue:

- There appears to be a small amount of "play" in the grasp once it is initiated. This play causes the fingers to move away from the object, resulting in a loss of grasp. Interestingly, when grasping deformable objects, this play seems to contribute to a more successful grasp. We are uncertain whether increasing the power of the actuators would completely resolve this issue.

- It is possible that one finger remains in contact with the object, preventing the actuator unit from further winding the cables and thus preventing other fingers from establishing contact with the object. We hypothesize that incorporating a differential mechanism in the reel that rolls the cables from all five fingers simultaneously could address this problem.

To enhance the grasp capability of the mechanical orthosis, we decided to employ the tenodesis effect without necessitating any modifications to the orthosis architecture. As the device already assists with wrist extension, utilizing the tenodesis effect could be seamlessly integrated. The tenodesis effect takes advantage of the natural anatomical design, where the lengthening of tendons during wrist extension causes the fingers to passively close and grip objects. In essence, by leveraging the tenodesis effect, the power generated by the wrist actuator is utilized for grasping in conjunction with the hand actuator, maximizing the overall grasping capability of the orthosis without requiring additional materials or design changes.

3.2.1.c Power source

Currently, power is provided by a power source plugged into an outlet. Embedding a 12 V battery is an alternate power option. A small study would be required to estimate the required capacity. That said, as the current device is designed for experimentation, estimating the autonomy needed for every day use is not a priority.

3.2.1.d Control

The mechanical orthosis is controlled by an Adafruit Feather nrf52840 control board, which is coupled with a [DC](#) double-channel driver (L298N). The control board is cost-effective and reliable. It can be programmed using Arduino code and offers various features such as [BLE](#) (although currently unused), General Purpose Inputs/Outputs ([GPIOs](#)), and hardware encoder management. The two encoders of the mechanical orthosis are connected to input pins on the control board to receive signals and are powered by the board itself. To facilitate control and communication, the microcontroller is connected to a computer via a serial communication protocol. This allows the mechanical orthosis to be controlled using keyboard inputs. Positions can be set, saved, and the orthosis can be moved to these predefined positions or adjusted incrementally. Regarding the power source, while the focus has not been primarily on portability, the chosen control board is suitable for portable devices. For example, the Exofinger also utilizes this board. To further optimize space without compromising performance, the driver could be replaced with a Pololu DRV8835. Overall, the control system of the mechanical orthosis provides flexibility, ease of control, and the potential for portability if desired.

3.2.2 Vivaltis

The chosen electrical stimulator for the hybrid orthosis is the Vivaltis Phenix Neo. As illustrated in [Figure 3.5](#), the stimulator consists of wireless pods and a base controller. This stimulator was selected for its portability and familiarity within the CAMIN

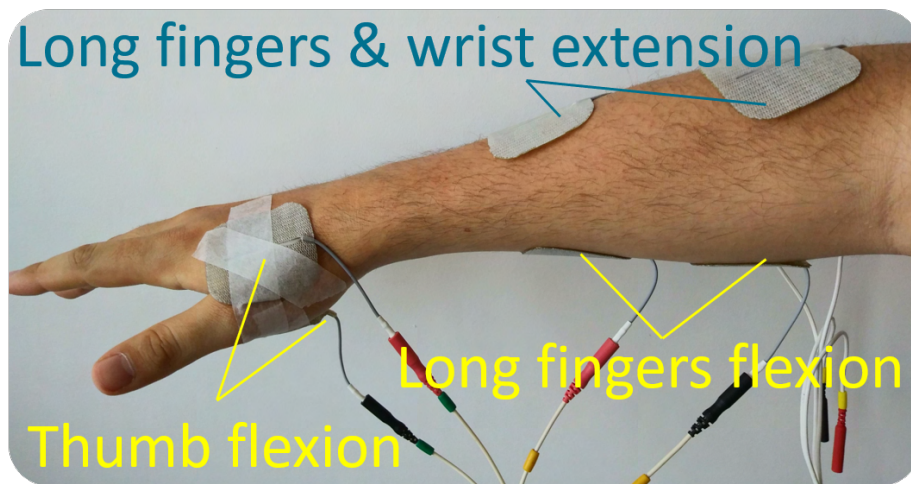

Figure 3.4: Example electrode placement.



Figure 3.5: The Vivaltis Phenix electrical stimulator.

team, as the team participated in its development [125].

In this setup, three pairs of surface electrodes are required: one pair for stimulating the long fingers and wrist extension (extensor carpi ulnaris + extensor digitorum), one for long finger flexion (opponens pollicis muscle; flexor pollicis brevis muscle; abductor pollicis brevis muscle), and one for thumb flexion (flexor digitorum superficialis). An example of the electrode placement is shown in figure 3.4. The base is connected to the computer with a serial communication protocol.

3.2.2.a Properties

This setup requires two pods, each featuring two channels or four surface electrodes. The pods communicate with the base using integrated Bluetooth. The pulse width, frequency, and intensity stimulation parameters can be adjusted within the range of [20;1600] μs , [1;125] Hz and [1;100] mA, respectively. Pulse width modulation is also possible.

3.2.2.b Limits

The interaction between the two wireless pods of the Vivaltis Phenix stimulator causes certain limitations in its functioning. To prevent any undesired behavior or potential system failures, it is advisable to only modify the stimulation parameters when neither pod is actively stimulating. This approach disables pulse width modulation, as it appears to be incompatible with the simultaneous use of two pods. Regardless of the specific configuration, both channels operate at the same frequency.

3.2.2.c Control

The CAMIN team has previously developed libraries to control the Vivaltis pods using various programming languages such as MATLAB, C++, and Python. For the current project, the Python version of the controller was chosen due to its ease of development and the ability to create a GUI efficiently. Additionally, Python is widely compatible and versatile in different applications. Updates were made to the existing Python version of the controller to accommodate the use of two pods in the hybrid orthosis setup.

The Application Programming Interface (API) provided with the Vivaltis Phenix stimulator allows for various operations. These include setting parameters, triggering and stopping the stimulation on selected channels, as well as linking or unlinking pods to their base. The API facilitates control and management of the stimulation process for the intended use within the hybrid orthosis system.

3.2.3 Python controller for the hybrid orthosis

A dedicated controller has been developed to effectively manage the three FES channels and the two motors. Its primary function is to synchronize the commands and feedback signals from both the mechanical orthosis and the stimulator. This controller empowers the operator to configure the stimulation parameters for each channel of the two pods and establish the neutral, open, and tenodesis positions for the mechanical orthosis.

3.2.3.a Principle

A multi-threaded GUI has been created using Python to facilitate the control and coordination of the orthosis and stimulator. The GUI manages the communication between the control board/orthosis and the base controller/stimulator via Serial COM (communication port).

The controller operates as a state machine, allowing independent control of the orthosis or stimulator, as well as the simultaneous control of both devices based on the selected settings. The controller has three primary states: *neutral*, *open*, and *close*. Events within the system are efficiently handled by the Python software, ensuring smooth operation. Additionally, the software automatically generates logs to provide a record of the system's activity. The transition from one state to the next can be initiated either by the operator using a dedicated button on the GUI or by the participant themselves by pushing a button.

The push button used in the current setup is an alternate version of the open-source push button developed for Exofinger. It consists of three microswitches in parallel and four springs mounted in three 3D printed parts. Participants can push the button to trigger the change of state, as it is connected to the control board, which relays the command to a thread of the Python software. The push button is readily replaced by another input device to provide the best input modality for a user, such as by head movement or a muscle contraction.

3.2.3.b Python API for mechanical orthosis

The mechanical orthosis is controlled by embedded Arduino code running on the Adafruit board, which establishes communication with the computer through a serial COM. To facilitate control of the mechanical orthosis via the GUI, a Python API has been developed providing seamless integration between the GUI and the Arduino code.

The orthosis incorporates two sensors which are rotary encoders, one per actuator. The Arduino code calculates the relative position of both the wrist actuator and the hand actuator. However, the number of rotations of the actuator are reported rather than the precise angle of the device. The Arduino code utilizes a custom C++ library, specifically an object class called *AufraMotor*. This class simplifies pin declarations and incorporates essential functions such as position updating and direction settings.

To ensure flexibility and safety, the Arduino code continuously evaluates the input signals, allowing a dynamic response and preventing motion blockage if the desired position cannot be achieved. Moreover, it includes a safety measure for halting the motion at any given time.

Although a Proportional Integral Derivative (PID) controller was implemented and tested, the device's behavior with the PID controller closely resembled that of an on/off controller. For the sake of simplicity, the PID controller was not employed. As a result, the control mechanism is straightforward, employing full Pulse Width Modulation (PWM) when a command is given and no PWM when the current position falls within a predefined interval centered around the desired position.

3.2.3.c State machine cycle and event handler

The controller implemented in the system functions as a state machine with four states. However, it can be viewed as a three-state state machine, as two states of the cycle can be the same depending on the specific settings. Transitions between states can be triggered by either pressing a physical push button or by using the corresponding controls on the GUI.

Events, such as timers and sensor feedback, are utilized either within a particular state to control specific actions or as conditions that authorize the transition to the next state. The cycle is the following:

- **Neutral:** This is the rest position. The controller stops extension stimulation and puts back the hand module in neutral position by winding cables.
- **Open:** This state is used to open the hand in order to place the object in the palm. The controller starts extension stimulation and slacks the hand cables until reaching the predefined *open position*.

- **Close:** The fingers close to grasp the object. The controller stops extension stimulation and starts both flexion stimulation channels while winding hand cables as much as possible. The stop condition is composed of two criteria: position-wise and time-wise. The controller identifies closing is finished once the position of the hand cables do not change quickly enough, this is the position stop condition. On triggering, the actuators need to initiate the movement, at this moment the change in position may not vary quickly enough and the stop condition can be fulfilled. A timer is set to avoid this early stop condition. Once the two conditions are fulfilled, the controller stops flexion stimulation as well as the hand motors and triggers the tenodesis movement, if selected in the settings. The tenodesis movement is performed by the wrist unit, and helped by extension stimulation. Current mechanical orthoses often require the tenodesis effect to tighten the grasp on the object. Once the predefined *tenodesis position* is reached, the stimulation, as well as the wrist unit, stops. At this stage, the grasp is intended to be held passively, letting the user hold the object for as long as desired.
- **Open (again):** The second open state, that follows closing, depends on the tenodesis settings. If the tenodesis was not used in the close state, this open state is the same as previously. Otherwise, the controller first puts the wrist back in its predefined *neutral position* by activating the wrist unit. As the hand cables are pulling the wrist back in position, no stimulation is required to return to the neutral position.

To ensure safety and prevent prolonged or unintended stimulation, watchdogs have been incorporated into each state of the system. These watchdogs act as safeguards by monitoring the duration of the state and preventing any stimulation from persisting beyond the intended time frame. Additionally, the watchdogs also control the mechanical orthosis, ensuring that it is deactivated when the timer associated with the state expires.

Upon entering each state, a dedicated thread is created, along with a corresponding timer. This timer is responsible for triggering the deactivation of both the electrical stimulation and the mechanical orthosis once the specified time for that state has elapsed. This mechanism adds an extra layer of protection.

3.2.3.d GUI and settings

The GUI, shown in Figure 3.6, includes the features needed to setup, operate, and process the results of the functioning orthosis. As the device is intended for use by healthcare professionals, ensuring user-friendliness is essential in a control interface. The GUI was validated by an occupational therapist to ensure its effectiveness and usability.

The explication of each front-end component is the following:

- **Connect buttons:** Connect the Python software to the control board and the Vivaltis base through the serial COM by selecting the number of the corresponding COM ports.
- **Check boxes** for every module, i.e. channel or actuator units. Only the checked module can perform an action. For example, to use only the stimulation, simply deselect the Hand and Wrist module on the Aufratech side of the GUI.

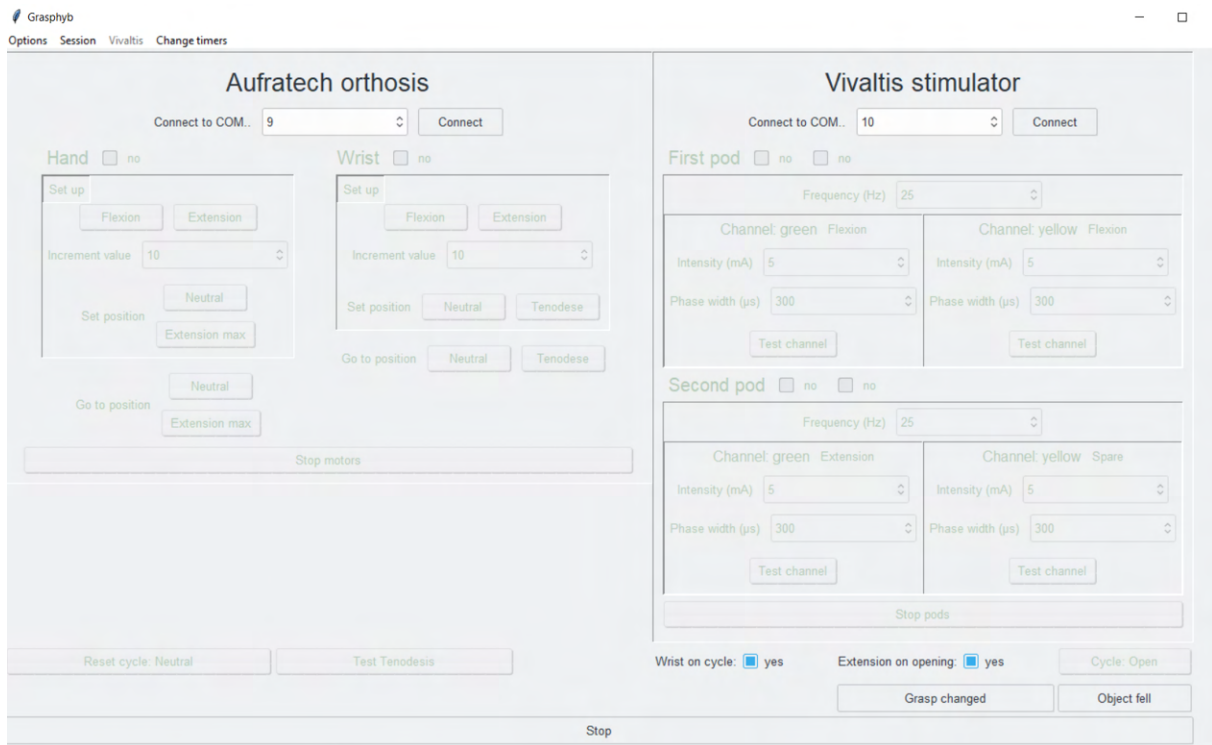

Figure 3.6: Graphical User Interface of the controller.

- **Aufratech setup:** Choose the increment value for the motion of the hand and wrist induced by actuators. Move by this increment in flexion or in extension. When the desired positions are achieved, set the current position as a predefined position.
- **Aufratech test:** Move the hand or the wrist to the predefined positions.
- **Vivaltis setup:** Choose the stimulation parameters, frequency for the pods and intensity and pulse width for the channels.
- **Stimulation channel test:** Trigger the channel to test the electrode positioning and its parameters. The *Test channel* label changes to a *Stop* label while the stimulation is active on the corresponding channel.
- **Reset cycle & Cycle:** Force the neutral state, then reset the cycle. *Cycle* triggers the transition to the next state.
- **Wrist on cycle checkbox:** Choose whether the tenodesis will trigger or not. We believe that, depending on the object to be grasped and the participant, tenodesis could enhance or deteriorate the grasp.
- **Extension on opening checkbox:** Choose whether the stimulation of the extensors in the *Open* state triggers.
- **Test Tenodesis button:** Test the tenodesis position (triggering the extension stimulation and moving the wrist to the predefined *tenodesis position*).
- **Object fell & Grasp changed:** Used by the operator to time the evidence of fatigue of the participant, by slipping of the object for example and when the object is no

longer held. Those buttons add a line to the logs - which as other log entries is timestamped. Thus, logs can be used as another way of verification, if needed.

- **Stop buttons** are used to either stop the stimulation, the actuators, or both at the same time.

Some options and settings are included in the menus. Those are not linked to the control but rather to the overall functioning such as manage Vivaltis pod connections. The menu structure is the following:

- **Options:**
 - *Open console:* Open a console. This interface displays output from the software, notably logs.
 - *Kill software:* Full termination of the software.
- **Session:** Gathers options that are related to the name of the log files and the saving of the parameters.
 - *Change object:* Enables the choice of which object is being used: Miscellaneous, Ball, Fork, Bottle or Free Task. The object will be included in the log file name.
 - *Change participant number:* The operator can enter the number of the participant, which will be included in the log file name.
 - *New session:* Increments the session number that will result in another log file. The session number is included in the log file name.
 - *Save parameters:* Enables a save of the stimulation parameters and the predefined positions of the Aufratech orthosis as a text file.
 - *Import parameters:* Chooses which parameters to import.
 - *Reset Aufratech parameters:* The option can be used depending of the position of the mechanical orthosis at the time of importing the parameters. This is because the positions are relative and not absolute.
- **Vivaltis:**
 - *List pods:* Lists the available Vivaltis pods within Bluetooth range of the base.
 - *Link pod:* Uses the pod Identifier (**ID**) to link the pod to the base.
 - *Unlink pod:* Uses the pod ID to disconnect the pod from the base.
- **Change timers:** Enables a change between the open, close and tenodesis timers for the watchdogs triggering the turn-off of stimulation.

3.3 Preliminary experimental validation

Before processing to a clinical protocol involving individuals with [SCI](#), the overall functionality of the developed setup was tested. In this regard, the controller's performance, as well as the consistency and feasibility of the implemented setup and the designed protocol, have been tested through experiments involving four healthy participants. These experiments were conducted under the approval of the [COERLE \(authorization n° 2023-14\)](#).

3.3.1 Purpose

The objective of these experiments was to validate three key aspects:

- The overall functionality of the hybrid orthosis controller, including state transitions, event handling, and the behavior of the stimulation and actuation. This evaluation aims to ensure that the controller functions as intended and performs reliably.
- The usability of the mechanical orthosis for different participants, focusing on their ability to properly don and adjust the device. This assessment seeks to determine if the orthosis can be easily customized and comfortably fitted to individuals with varying hand sizes.
- The compatibility and practicality of the developed setup with specific components of the protocol designed for individuals with [SCI](#).

3.3.2 Participants

Three men and one woman participated in this experiment. Their measurements vary significantly in order to test the adjustment of the mechanical orthosis and if size impacts the behaviour of the mechanical orthosis. The height for the tallest participant being 1.8 m and 1.6 the smallest participant. Correlations have been proven between height and hand lengths [126, 127].

3.3.3 Protocol

The protocol involved a one-hour session per participant during which experimental data was collected through functional tests. Participants were seated in a chair in front of a table. The session proceeds as follows:

1. **Electrical stimulation setup:** The implementation of electrical stimulation involved the placement of three pairs of stimulation electrodes on the skin over the target muscles, including the wrist and finger flexors and extensors, as well as the thumb flexors. The stimulation parameters will be adjusted based on the comfort threshold of each participant. Initially, the stimulation wstarted at low levels and gradually increase to allow participants to become accustomed to functional electrical stimulation.

During the experimentation, participants were guided through several repetitions of wrist, finger, and thumb flexion and extension movements. These movements will be performed both individually and simultaneously to assess the coordination and effectiveness of the electrical stimulation in eliciting the desired muscle contractions. Additionally, participants were instructed to grasp and hold various objects that require a power grip, allowing for the evaluation of the orthosis' ability to facilitate functional grasping tasks.

The push button was be provided to trigger changes between different states in the state machine controller. This enabled participants to initiate and navigate through the predefined movements.

- 2. Mechanical orthosis setup:** During the adjustment phase of the mechanical orthosis, the stimulation electrodes used for electrical stimulation remained in place on the participant's forearm to maintain their positioning and settings. The electrical stimulation was temporarily turned off during this phase. The mechanical orthosis was placed on the participant's right forearm, as the prototype has only been developed for this side.

The adjustment process involved customizing the orthosis to fit the participant's individual dimensions. Predefined positions were established. Starting from the participant's chosen neutral position, the orthosis, with voluntary assistance from the participant's healthy muscles, gradually moved the wrist into extension in small increments. This process continued until a suitable tenodesis position was achieved. Similarly, for the hand module, a neutral position and a position of maximum extension were defined.

The participant had the opportunity to activate the orthosis movements using the push button, allowing them to become familiar with the devices and validate their setup.

- 3. Evaluation:** The final phase of the evaluation involved assessing the performance of the hybrid orthosis, combining electrical stimulation and mechanical activation, during object grasping and holding tasks. The functional capabilities of the participants were evaluated by observing their ability to successfully grasp and hold common objects that required a power grip.

Several objects were used for this evaluation, including a cylindrical bottle of 0.5 L, a tennis ball, and a fork adapted with a thickener. Participants were instructed to hold each object and drop it into a box. The use of the contralateral hand was only allowed for initial stabilization of the object.

Each task was repeated five times, with the order of the objects presented in a random sequence to minimize the potential influence of learning or fatigue. A 30-second rest period was provided between each attempt to allow participants to recover. The performance of the hand in grasping and holding the objects was determined by the number of successful attempts for each functional task. This outcome measure is the most commonly used outcome measure for validating hybrid systems. [115]. Additionally, the time required to complete each task was recorded through the logs of the controller.

3.3.4 Results

Every participant achieved in donning and adjusting the mechanical orthosis. For this particular task, it seems that the difficulty remains in the half rings for fingers. On one hand, for participants with larger finger joints, it was necessary to rotate the rings by a quarter turn to facilitate the sliding of the half rings along the fingers. On the other hand, the length of the three half rings exceeded the length of their little finger, of one participant, resulting in restricted motion for that specific finger.

Each participant successfully completed five repetitions of the grasp and release task using the hybrid orthosis with three different objects. Participants were given the choice of utilizing the tenodesis effect or disabling it for the task. Interestingly, two participants preferred to disable the tenodesis effect specifically for the ball task.

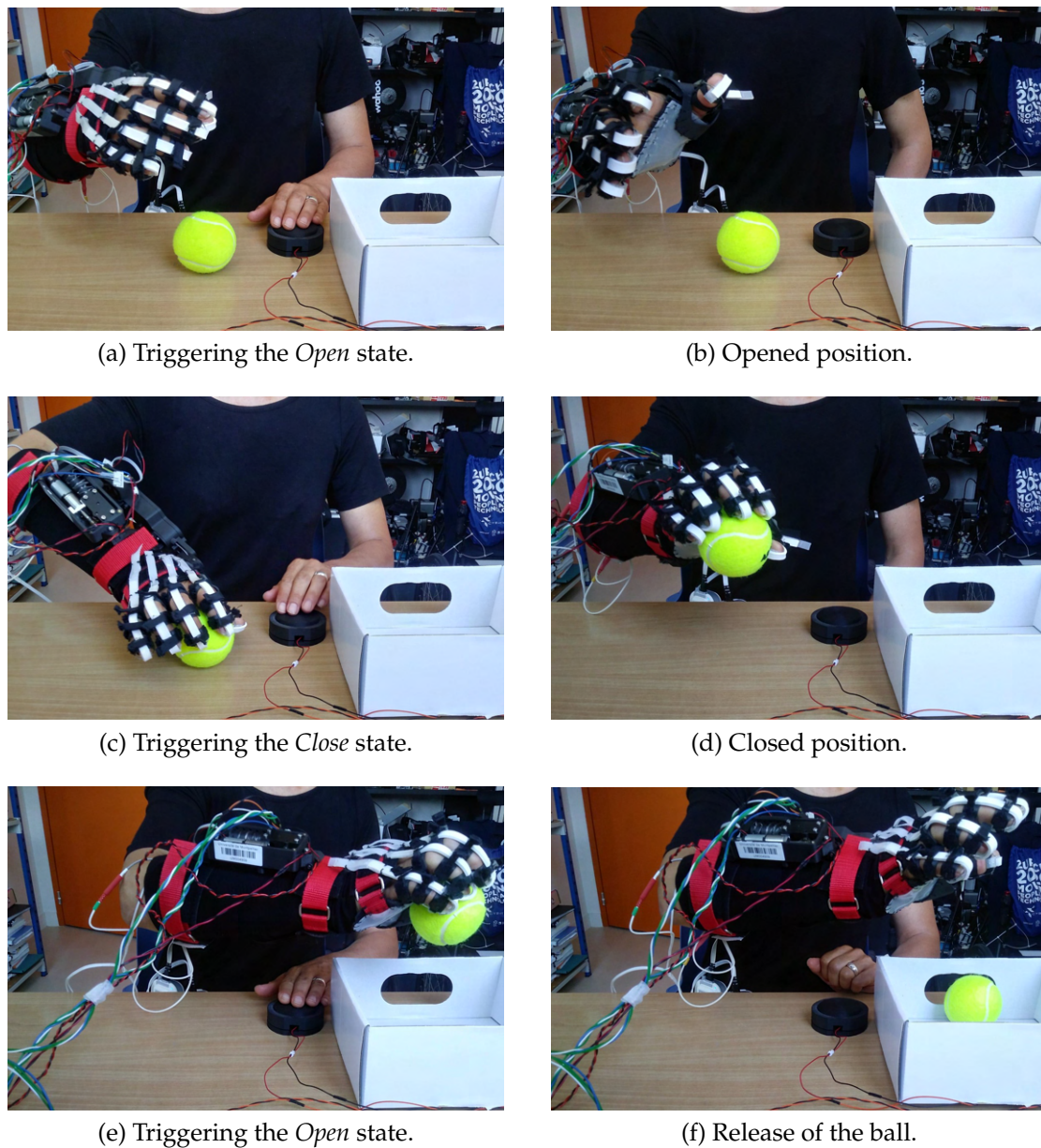

Figure 3.7: Example of ball manipulation with the hybrid orthosis.

Figure 3.7 provides an example of manipulation with the hybrid orthosis, illustrating the successful execution of the task.

The controller behaved as intended throughout the experiments. A Python script was developed to generate timelines of the events. Figure 3.8 shows an example of such timeline, without tenodesis.

The time taken to reach each state was recorded and analyzed. Table 3.1 presents the results for the ball. Results for the fork and the bottle are similar. The time required to complete each state was found to be within an acceptable range for all objects [128].

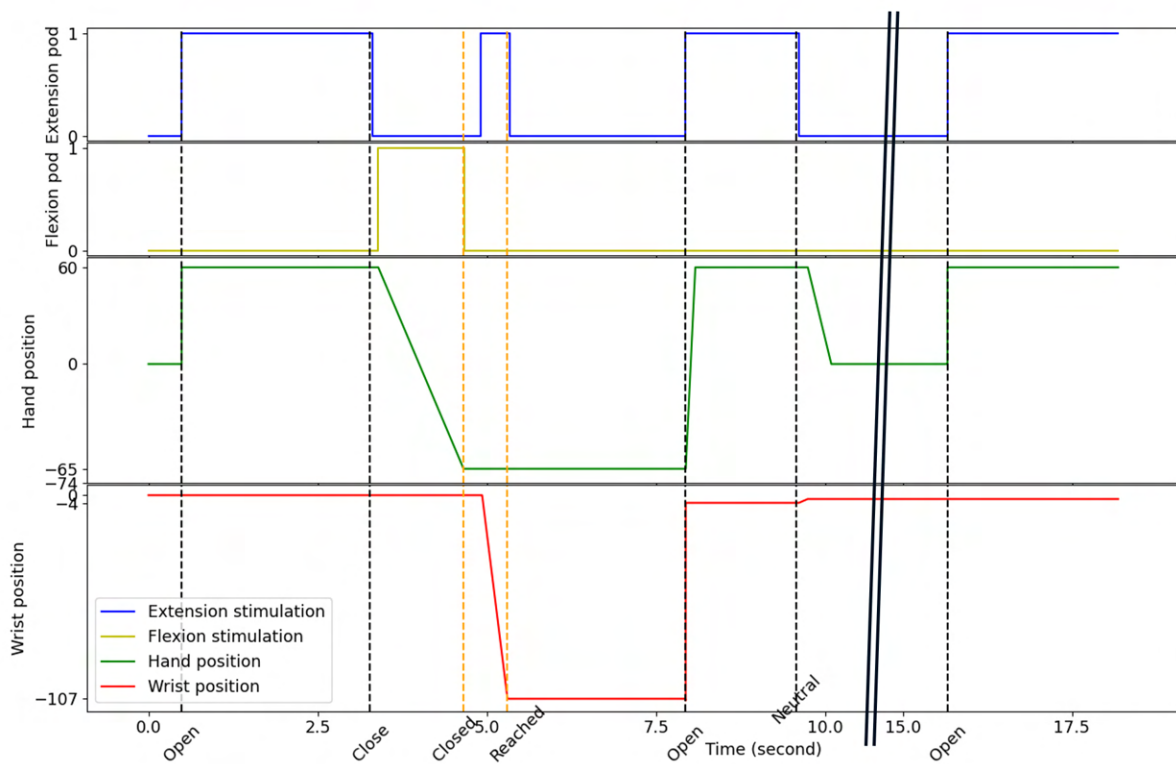

Figure 3.8: Example of timeline produced after a full cycle of grasping during the experiment. From top to bottom: state of stimulation for extension, for flexion, position of the hand module, of the wrist module.

Cycle state	Open (from neutral)	Close	Tenodesis	Open (from closed)	Neutral
P1	494 ± 4.93	1536 ± 280	714 ± 117	754 ± 36.7	502 ± 15.9
P2	484 ± 14.9	1649 ± 125	Not reached	878 ± 125	598 ± 95.2
P3	482 ± 11.9	1643 ± 281	X	804 ± 85.6	152 ± 11.3
P4	478 ± 15.9	1739 ± 333	X	990 ± 108	169 ± 4.50
Total	485 ± 13.9	1636 ± 272	714 ± 117	856 ± 130	355 ± 204

Table 3.1: Mean time (ms) for the hybrid orthosis to achieved a state, for each participant.

These results were presented at the Rehabweek conference in Rotterdam 2022 [129]. The outcome showed no issues and encouraged us to move to the next step, which is experimentation with participants with SCI. evaluate the use of a hybrid orthosis according to reducing muscle fatigue in grasping.

3.4 Pilot study

The correct functioning of the device with the ability to perform wrist and fingers flexion and extension movements efficiently and safely was analyzed with four healthy participants.

We conducted a pilot study to confirm the previous validation with an individual with SCI. The COERLE accepted this preliminary experimentation under the same agreement (n° 2023-14).

3.4.1 Purpose

This pilot study had multiple goals. First, it aimed at confirming the validation of the hybrid orthosis of the previous study with an individual with SCI. Second, as a pilot study, it aimed to identify potential problems and challenges in the protocol or setup design in order to refine for upcoming clinical trials. Third, we collected the feedback on the device by the means of the technological part of the QUEST [130], the SUS [109] and an open discussion.

3.4.2 Participant

The participant is aged 18 years or older with a diagnosis of complete tetraplegia more than 6 months. The neurological level of lesion is up to C7. The participant has a complete passive ROM of the hand, wrist, and finger joints enabling free ROM through the orthosis and feature a visible muscle response in the wrist, finger and thumb during electrical stimulation with surface electrodes. He tolerated the use of the Aufratech orthosis and demonstrated skills to follow instructions to perform motor tasks and to provide feedback on the use of the device.

The participant had no health conditions or comorbidity that make clinical testing impossible.

It is worth noticing that the participant had an active wrist extension inducing a tenodesis effect and has not been trained for FES (actually he never used FES before).

3.4.3 Protocol

This pilot study consisted of three sessions. A team of two researchers with engineering backgrounds and one with a occupational therapy background, was involved in the data collection process. We utilized the Visual Analog Scale (VAS) [131] to assess pain levels and potential adverse events. The VAS will be administered both during and after the use of the device in each session.

In all sessions the participant remained in front of a table with adjustable height and the device was attached on his right upper limb. Anatomical adjustments, possible pressure points on the skin, redness, discomfort, tingling, paresthesia, postural

adequacy, safety, and comfort were checked.

The tasks were similar to the ones conducted in the previous study, notably using the same three objects, a tennis ball, a fork with a thickener and a cylindrical water bottle, in a randomly determined order. As the focus was made on the ability to hold an object in power grasp, the hold-and-release task remains. Thus, the evaluated tasks consisted of picking up the object placed in front of him and holding it up in the air for 30 seconds, then releasing the grasp. Each grasp was followed by a 30-second rest. This task was repeated three times for each object, with a two-minute rest between each object. The number of successful attempts, the object's holding time, the time of first evidence of fatigue and the intensity of the perceived physical effort by the Borg's Rating of Perceived Exertion (RPE) scale was collected. Also, the scoring of the gesture was based on a system comprising three categories: 0 points for an unsuccessful attempt, 1 point for an acceptable attempt, and 2 points for a fully functional, successful attempt [115]. To ensure objectivity in the evaluation, three experts from the research team have independently scored the gestures based on videos, after which the scores was reviewed to ensure agreement among the experts.

The schedule of sessions was as follow:

- **Session 1:** The participant's data were collected and his eligibility criteria were checked, especially the possibility to produce a functional motion with ES and to don the orthosis. The region most responsive to electrical stimulation was identified. Electrodes were placed using a motor point chart and a mapping of the muscle motor. A photo was taken, and a mark was made with a pen to keep the same positioning of the electrode in the following sessions. Stimulation parameters were be established based on the participant's threshold, beginning with low intensity. Afterward, several repetitions of the opening and closing hand movement and the grasping and holding of the three objects were performed with FES only. This allowed the participants to become familiar and safe when using the equipment, ensuring that they could tolerate the use. The team conducting the experimentation made sure that this previous step does not induce too much fatigue in the participant's muscles. Especially because evaluation was conducted right after this set up. In this first session, the functional evaluation was performed while using FES only.
- **Session 2:** The mechanical orthosis was added, following the same protocol as the previous study. The time to don and adjust the device was noted. The same training and evaluation were performed as in the previous session. The time to remove the device was also noted. After the functional evaluation, the acceptability and usability of the device were evaluated, as well as the degree of comfort, satisfaction, and acceptance of the user regarding the use of the equipment through an interview, applying the QUEST, the SUS and a open discussion for feedback collection. Finally, at the end of the session, the participant was able to perform some free tasks by trying to hold objects of all kinds he wants and simulate the activity of daily living. This free task phase was not evaluated.
- **Session 3:** This session involves only the training and evaluation part of the first session, therefore using only FES again. The data from this session was the one to be compared to the data from session 2, with the hybrid orthosis, to avoid training bias. Depending of the results, the maximum time to hold each object

Session	Parameters	Flexion (long fingers)	Flexion (thumb)	Extension
1	Frequency (Hz)	40		40
	Intensity (mA)	34	20	22
	Pulse width (μ s)	400	350	350
2	Frequency (Hz)	40		40
	Intensity (mA)	28	22	20
	Pulse width (μ s)	400	350	350
3	Frequency (Hz)	40		40
	Intensity (mA)	28	22	20
	Pulse width (μ s)	400	350	350

Table 3.2: Electrical stimulation parameters during each session of the pilot study.

(i.e. how long the user can sustain the power grasp) was collected. This was performed only if the participant was able to hold an object for the whole duration for each repetition.

Blank forms used in this pilot study are [shown in appendices](#).

3.4.4 Results

The participant was able to perform the grasping of the three objects without any assistance using wrist extension and its induced tenodesis.

He worn the hybrid orthosis for 1h 35 min and the visual inspection performed by the occupational therapist revealed that the use of FES and wearing of the orthosis did not cause any bruising or other injuries of the sort. During attempts with the ball and the bottle, the participant asked for a neutral state between the opening and the closing. With the help of the controlateral hand, it enabled him to position correctly his fingers around the object before the closing. This was done with and without the orthosis. The neutral position of the forearm (handshake position) required to hold the bottle lead to issue for the participant. Indeed, the FES induced supination and the orthosis accentuated this phenomenon. He needed to restrain the supination with his controlateral hand.

Scoring of the gesture shows no difference between the three evaluation phases. The stimulation parameters used in the three sessions are shown in Table 3.2, same parameters were used in session 2 and 3.

The participant's feedback, including but not limited to the QUEST and the SUS questionnaire, were essential in this stage.

Concerning donning and doffing times, two persons placed the mechanical orthosis on the participant's right arm twice during this pilot study. The required times to do so were 6 min 12 s and 4 min 48 s. The removing of the mechanical orthosis took 1 min 47 s and 1 min 30 s.

3.4.4.a Grasp holding and fatigue

The participant achieved in grasping the ball and the fork for 30 seconds at each attempt in session 1, consequently we decided to ask for 60 seconds in session 2 and 3. However, the participant achieved in holding the grasp for 60 seconds. Keeping in

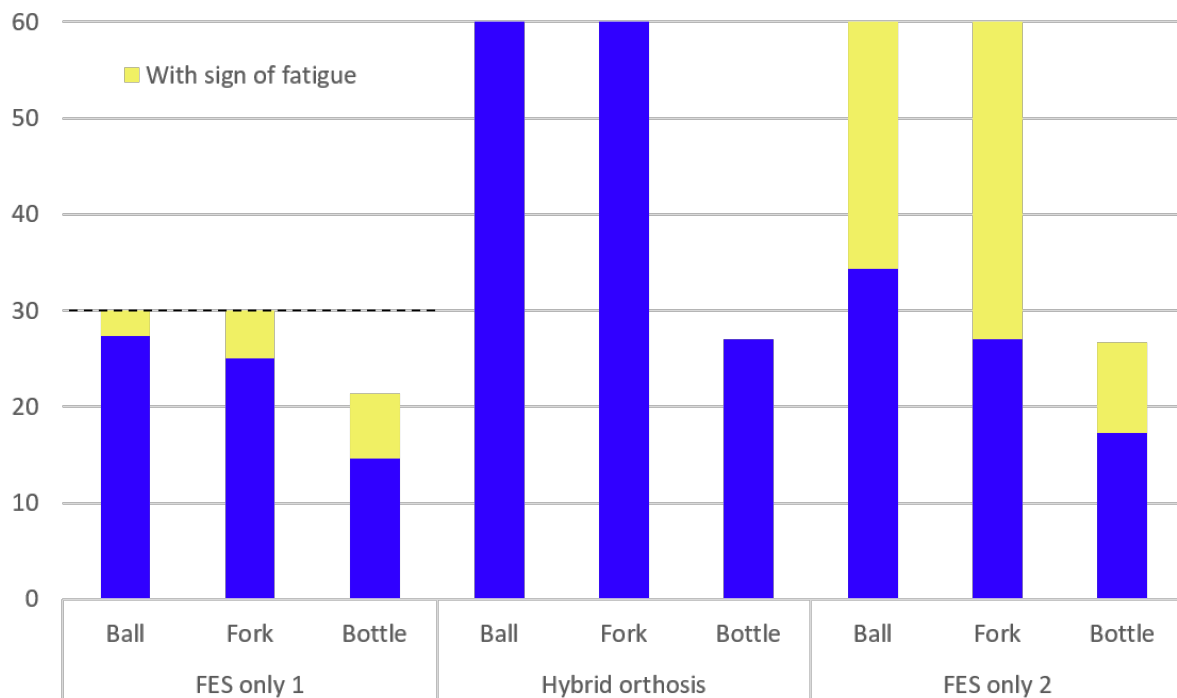

Figure 3.9: Mean holding time, including the mean time of first evidence of fatigue (yellow) for each session of the pilot study.

mind that the participant has an active tenodesis, we decided not to ask for longer. As for the bottle, the participant did not achieve in holding the bottle of 0.5 L for 30 seconds with and without the mechanical orthosis. Figure 3.9 summarizes the holding times and the times of first evidence of fatigue. These latter have been determined by the team member with an occupational therapist background.

All attempts with the ball and the fork reached the maximum time asked in the task. The participant was asked to hold the ball for as long as possible, he achieved to hold the grasp on the ball for 225 seconds. AS for the fork, we believe that the participant could hold the fork for a very long time, so we did not performed the measurement of the longest hold for the fork. Finally, considering the bottle, attempts did not achieve the asked holding times, thus it was not necessary to perform another attempt to determine his maximum holding time with the bottle.

Time in holding tasks does not reveal any difference between FES only and hybrid orthosis. However, there was no change in hand position evidencing fatigue while donning the device.

Also, fatigue can be reflected by the RPE, Figure 3.10 presents the RPE which was averaged by repetitions in each session. The bottle shows no significant difference between the three sessions. However about the ball and the fork, the perceived exertion is lower in session 3 than in session 1 and even lower with the hybrid orthosis.

3.4.4.b Feedback

During the open discussion, the participant stated that a radial movement of the wrist would be beneficial, even with passive adjustment. The two questionnaires were performed in their French version.

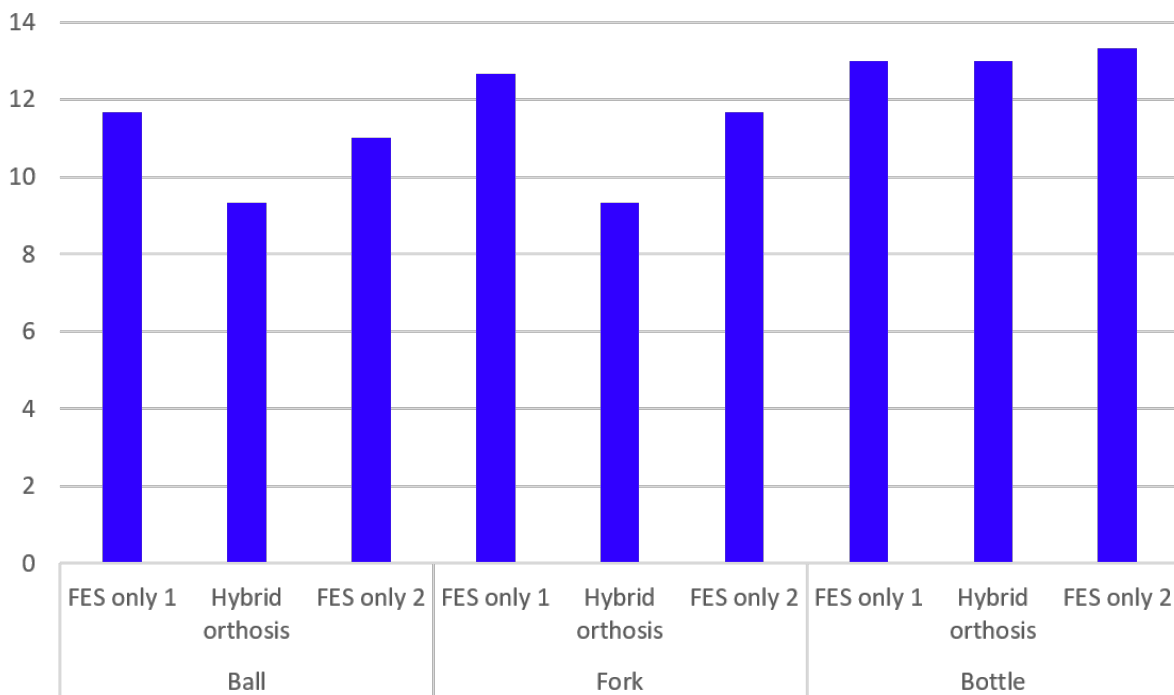

Figure 3.10: Mean rating of the perceived exertion by the participant of the pilot study.

Item	Score
Dimensions	3
Weight	3
Ease in adjusting	1
Safe and secure	4
Durability	3
Easy to use	3
Comfortable	3
Effective	4
Total	3

Table 3.3: [QUEST](#) score by item for pilot study participant.

QUEST - Only the technological part of the [QUEST](#) was performed. It includes eight items ranging from "not satisfied at all" to "very satisfied". The global score is the mean value of these eight items, the participant gave an overall [QUEST](#) score of 3, [Table 3.3](#) details this score.

SUS - The [SUS](#) score ranges from 0 to 100, it is composed of ten items. Score calculation and item descriptions were explicated in the Exofinger chapter [2.6.4](#). The participant of the pilot study gave a [SUS](#) score of 50, [Table 3.4](#) details this score, items are detailed [here](#).

3.4.5 Discussion

Results in [Figure 3.1](#) reveal that the holds on objects were better with the orthosis; as a matter of fact, the participant stated feeling more confident while grasping with the device.

Item number										Score
1	2	3	4	5	6	7	8	9	10	
0	2	1	0	1	4	3	3	3	3	50

Table 3.4: **SUS** score by item for pilot study participant. Items are detailed in Chapter 2.

Even if it can be seen in the holding time, the participant was not able to hold the object for different reasons. With **FES** only, the object was too heavy for his muscles whereas with the hybrid orthosis, the bottle slowly slipped down because of the rigid splint of the thumb and the fewer surface of contact on the bottle. This denotes another limit of the mechanical orthosis.

Mechanical orthosis limits - Indeed, the solid part around the thumb, intended to position it in opposition, slightly hinders the power grasp of large objects such as the bottle. This solid part makes contact with the object, and to ensure that the fingers can also establish contact, precise positioning of the hand is necessary.

Additionally, the inclusion of a palm pad, velcro, and rubber bands on each digit significantly reduces somatosensation. Considering that the target users have experienced spinal cord injuries, their somatosensation is likely to be greatly diminished or absent. However, if there is some remaining somatosensation, the device is likely to nullify it. Individuals with spinal cord injuries heavily rely on their remaining somatosensation, which further emphasizes the impact of this drawback.

To conclude on the mechanical orthosis, this device was designed to be adjustable for various hand sizes. However, the drawbacks lie in the time and complexity required to don, adjust, or remove the orthosis. Currently, external assistance is necessary for these tasks. However, the time required to don the mechanical orthosis significantly decreases from the first time to the second one (-33.6%), the time required to remove the device show fewer decrease (-16%). This suggest that the two persons helping to don the device benefited from the first time and thus a training could significantly reduce the time required. Also, we believe this time depends a lot on the participant measurements.

Holding times The increase of the time asked to hold the grasp from 30 seconds in session 1 to 60 seconds in session 2 and 3 was not sufficient considering the participant capabilities. It would be better to perform the maximum holding time before the evaluations in order to scale the required holding time. Therefore it would be necessary to do so for every object. That being said, we should keep in mind that the participant of the pilot study has an active tenodesis.

The participant did better in the second session with **FES** only (session 3) compared to the first (session 1). We do not believe this to be due to the learning or training but simply a better response to ES, it might be because of a better global physical condition. This hypothesis can be drawn on by the fact that stimulation parameters were globally lower in session 3 than in session 1, and yet leading to better performance.

Fatigue and perceived exertion - As shown in Figure 3.9, no evidence of fatigue were noticed while wearing the device. Also, except from attempts with the bottle, the RPE from Figure 3.10 shows that the participant perceived less exertion while wearing the device than with FES only. More participant are required to infer about the capacity of the device to reduce muscle fatigue but results from this pilot study are promising.

Evaluations through questionnaires The SUS questionnaire, considering usability, and the QUEST, pertains to satisfaction, result in scores in the very mean value of their respective range. Discussing the details in scores.

For the QUEST, only three items were not scored to 3, which are *Ease in adjusting*, scored to 1 and *Safe and secure* and *Effective* scored to 4. The participant is not satisfied at all by the ease of adjusting, which was expected, as the device was designed to fit various participants' measurements and not a single user. However, the participant is quite satisfied with the effectiveness and the security of the device which is promising for clinical trials and the mechanical orthosis itself. For a first prototype and considering the participant was able to achieve the tasks without assistance using compensatory strategies, the mean value in other items seems acceptable.

About the SUS, items' score show that the ease of use seems acceptable but not the ease of donning, notably requiring help from a tiers person. The participant thinks that the device has not *too much inconsistency*, on the other hand he believes that functionalities could be better exploited. We express this rating as the concept is good but the device itself might need a improved version, which is acceptable for a prototype.

3.4.6 Conclusion

A pilot study with the designed hybrid orthosis was performed with a individual with SCI. no arm to the participant

The pilot study confirmed the previous validation of the hybrid othosis functioning. It points out that a predefined cycle (*Open-Close-Open-Neutral*) is not optimal for every participant nor every object and it would be interesting to let participants build their own cycle, such as what was done the tenodesis option.

Concerning the protocol, the pilot study revealed that the choice of object is not the most efficient for this specific participant. The current mechanical orthosis does not permit to hold correctly the bottle. Also, the ball shape is interesting but we believe that the ball is mainly held by friction, as it can be seen in Figure 3.11, only three fingers are involved with the ball and the thumb and index fingertips are not even in contact. A attempt with a weighted ball (+200 g) lead to the same result as the bottle. A ball of a size of a tennis ball but weighting between 50 g and 200 g is yet to determine for the clinical trials. The objective is to reach fatigue. For this particular participant, 30 seconds of holding the grasp was not sufficient, it turned out that 60 seconds was not either. This is why we decided to time the maximum holding duration in the first session instead of the last one, ensuring that the participant reach a fatigue during evaluation by scaling the holding time according to the participant's record.

The overall feedback is promising and encourage us to move the clinical trials with a slightly modified protocol.

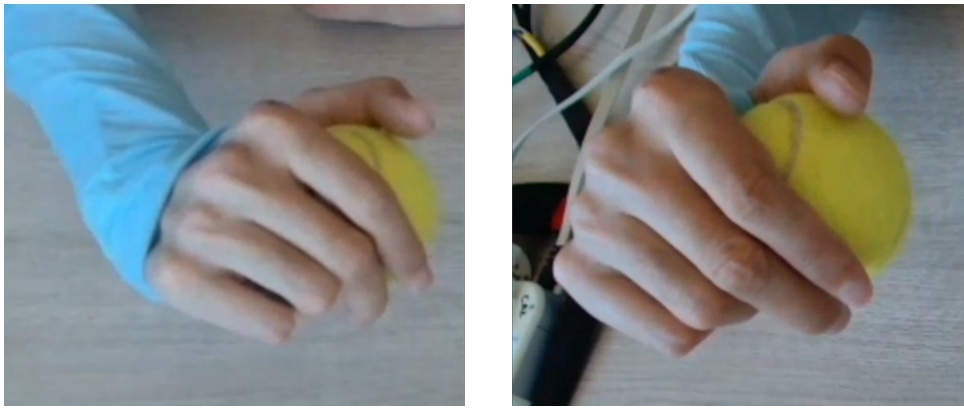

Figure 3.11: Example of ball manipulation with [FES](#) only.

3.5 Clinical trials

The final step of experimentations on the hybrid orthosis will include at least eight participants with [SCI](#). In the context of the associate team GOIABA between CAMIN and *Universidade Federal de Minas Gerais (UFMG)*, this clinical trials is planned in Belo Horizonte, Brazil. This clinical protocol was approved by Ethics Committee of the [UFMG \(CAAE Registry: 53757521.3.0000.5149\)](#). Unfortunately, for various reasons including covid situation, health issue and package shipments, experimentations in Belo Horizonte are still planned.

3.5.1 Purpose

The main objective is to determine whether the hybrid orthosis can reduce the early muscle fatigue due to [FES](#). For this we will analyze the contribution of the hybrid equipment in avoiding muscle fatigue compared to electrical stimulation applied alone by the comparison of time of first evidence of fatigue while holding various object. In addition, the intensity of the physical effort will be evaluated by the Borg's [RPE](#)) scale. As for the pilot study, a scoring of the efficiency of the gesture will be done to determine whether the use of a mechanical orthosis, combined with [FES](#), can improve the gesture compared to [FES](#) alone. Finally, the ease of installation and operation of the equipment will be checked (the time to fix, adjust, configure, and remove the equipment) and the degree of comfort, satisfaction, and acceptance of the user regarding the use of the equipment was assessed through an interview, applying the [QUEST](#) and [SUS](#).

3.5.2 Participants

Participants will be recruited from rehabilitation centers, hospitals, and social media at Belo Horizonte, Minas Gerais, Brazil. Participants will be selected according to the inclusion and exclusion criteria and will be informed about the study's objectives. The inclusion criteria for this study will be individuals aged 18 years or older with a diagnosis of complete tetraplegia for more than 6 months, neurological level of lesion up to C7, complete passive [ROM](#) of the hand, wrist, and finger joints enabling free [ROM](#) through the orthosis, visible muscle response in the wrist, finger and thumb during electrical stimulation with surface electrodes but no active muscle contractions of wrist and fingers, ability to tolerate the use of the Aufratech orthosis, demonstrating

skills to follow instructions to perform motor tasks, and to provide feedback on the use of the device.

Individuals will be excluded with health conditions or comorbidity that make clinical testing impossible, such as: current clinical instability, uncontrolled convulsions, excessive spasticity in the right upper limb (Modified Ashworth Scale ≥ 3) [132], clonus or major spasm that interferes with data collection, present any clinical contraindication for the use of electrostimulation, such as: cardiac arrhythmia or cardiac pacemakers, cardiovascular conditions, pregnancy, severe additional orthopedic or rheumatological impairment before injury preventing or limiting the use of the orthosis, pain that prevents participation in the study, open lesions on the skin where the device will be attached, do not tolerate the minimum intensity of electric current necessary to stimulate muscle contraction.

3.5.3 Clinical protocol

The clinical protocol is an adaptation of the pilot study protocol. Notably, as the bottle is not adapted to the current mechanical orthosis, this object is removed from the protocol. In contrast, a ball with of similar dimensions to the tennis ball but with a weight of 100 g is now considered. Also, previous session 1 is now split in two sessions, to avoid fatigue bias during evaluation. Therefore, the clinical protocol will be composed of 4 sessions, with at least a 24h-rest between each session.

- **Session 1:** Corresponds to the first part of the session 1 of the pilot study, i.e. checking the participants' eligibility criteria, electrode placements and getting started with the device. No evaluation is done in this session, except for the longest time the participant can hold the grasp using **FES** only on the objects.
- **Session 2:** Evaluates the participants capability of holding the three objects with **FES** only. The participant will be asked to hold the object for a range of 30 seconds to 120 seconds, depending of the maximum grasping time achieved in session 1.
- **Session 3:** Evaluates the participants' capability of holding the three objects with the hybrid orthosis. The same time as in session 2 will be asked and the same object order will be performed. The **QUEST** and **SUS** will be applied at the end of the session.
- **Session 4:** Evaluates again the participants capability of holding the three objects with **FES** only.

A flowchart of this protocol is [available in appendices](#).

3.6 Discussion

Setting up experimental protocols including human participants, especially with disabilities is as complex as time consuming. We have designed two protocols which received the agreement of ethics committees, however the trials with a group of participants with **SCI** is still to be performed. Indeed, the protocol and its consistency with the designed hybrid orthosis has only been tested with one participant with motor

impairment during the pilot study. However, evidence on whether the orthosis contributes to improved gestures and reduced fatigue needs further participant inclusions.

Other than inherent limits of the mechanical orthosis and the electrical stimulator, FES seems to be an outstanding actuating scheme for individual with paralysis, from an engineering point of view but also for health considerations. However, not everyone can use ES due for example to dysesthesia or denervated muscles.

About the controller, a custom cycle of the state machine would be an improvement in the customization of the control. Also, security wise, there is currently no handshaking process between the GUI back-end and the control of the mechanical orthosis by the Adafruit board.

3.6.1 Perspectives

The current prototype of the mechanical orthosis was designed for experimental purposes. It would be very interesting to design a new version of the mechanical orthosis customized to an individual based on feedback from users and experimenters in clinical trials. The hybrid orthosis composed of this future mechanical orthosis could be a portable device. In order to do so, the current driver could be replaced by a Pololu DRV8835, and the control box embedded. The communication between the computer and the control board could be done through the embedded BLE of the Adafruit. The concern remains on the power source, depending of the intend use, a little study would be necessary to estimate the power need. As the power consumption is stopped while the orthosis is positioned, the power need is relatively low (12 V and 350-450 mA for a few seconds).

3.7 Conclusion

A hybrid orthosis was presented as a solution to assist grasping by associating FES and a mechanical orthosis. The objective is to induce finger and wrist joint movements by activating muscles using FES and locking the joints in desired positions using electrical motors to reduce muscle fatigue. A controller was designed with a GUI in Python. Its global functioning was tested with four healthy participants and a dedicated protocol.

This hybrid orthosis has then undergo a pilot study with an individual with SCI, after which the setup and a modified protocol has been validated. Experiments with a larger population remains future work. The functionality and acceptability of the hybrid orthosis will be assessed with individuals with upper limb motor impairment due to SCI. Evaluation will be done based on the number of successful attempts and the holding time of different objects; the RPE scale, and the acceptability by the QUEST and the SUS.

Current conclusions include that the orthosis enables to secure a power grasp. Cables seem to be a proper solution to relocate the mass of actuators. Current mechanical orthosis' limits suggest that the design process should continue with another iteration, especially concerning the materials on the palmar side of the hands, including the fingers, that could hinder the grasping, and the necessity of using the tenodesis effect. However, the concept seems to deliver on its promises. The concept of joint locking is

particularly relevant for the hand, as it enables a secure grip while minimizing energy consumption. In addition, the mechanical orthosis guides the movement induced by FES.

In the two previous chapters, we investigated the feasibility of assisting key grip and power grasp through orthoses, which are intended to be lightweight. The restoration of grasping functions are limited by the positioning of the hand, as stated in the introduction, more proximal movements are required in order to obtain a proper positioning of the hand while grasping and manipulating objects.

Pursuing the objective of restoring grasping functions for individuals with paralysis, we considered an assistive orthosis for orientating the hand through supination and pronation.

Kinematic Synthesis of a Spherical Mechanism for Assisting Wrist Pronation and Supination

Full use of the upper limb is necessary to carry out most tasks of daily life. ADLs typically utilize the entire upper-limb kinematic chain including shoulder, elbow, forearm, wrist movements, and hand grasping [133, 134]. Experiments from previous chapters pointed out that the simple act of gripping is not sufficient for autonomy gain without additional proximal movement and proper hand positioning. In the majority of cases, the challenge of grasping extends beyond simple hand closure or opening. To effectively benefit from devices designed for object manipulation, forearm, elbow and shoulder movements are required.

Pronation and supination, the turning of the wrist relative to the elbow, are crucial to position the hand and manipulate objects in tasks such as feeding. Notably, individuals with tetraplegia often use pronation and supination as a compensatory strategy, as stated by the participant of the pilot study of the hybrid orthosis 3.4: the prono-supination is necessary, especially for objects as heavy as a bottle (0.5 L). Indeed, this movement is particularly beneficial for individuals with weak grasp as it allows transfer of an object's weight to the palm for better grip. Figure 4.1 shows an example for a participant of the Exofinger protocol.



Figure 4.1: P7 of Exofinger holding the bottle for 7 seconds in neutral position (left) and more than 30 seconds using supination (right).

The comparison between the usefulness of this movement and the required power is of great interest; since rotation is the primary means of positioning and the mass is relatively close to the center of rotation, minimal power is required. Given these findings, it seems relevant to consider designing an orthotic device to assist with pronation and supination, as a complement to existing devices for the hand and wrist.

4.1 Forearm pronation and supination

Assistive orthoses are a potential method for restoring some autonomy. However, pronation and supination, which allow for hand positioning and object manipulation, seems to receive less focus than other joint movements in the arm. First, the utility of this degree-of-freedom in the arm is less obvious. Second, when compared to flexion and extension of the elbow, wrist prono-supination is a more complex motion. Due to the combined movement of the ulna and the radius bones as they cross and uncross in the forearm, the axis of rotation is inside the body, with a gradual rotation along the forearm [135].

This chapter presents initial work in the design of a mechanism for a portable assistive orthosis that is expected to include powered prono-supination. We explored spherical mechanism architecture as a possible solution to address the problem. Indeed, the capacity of these mechanisms to have a hollow center and to produce paths that follow arcs on spheres make them worth consideration in this application. A MATLAB optimization was used to perform path generation of a single spherical four-bar with the intent of replicating it three times to create the device proposed in this work. The designed mechanism's concept was modeled in SOLIDWORKS and printed to gauge its potential. A concept of assistive orthosis for pronation and supination is proposed.

4.1.1 Biomechanics

Unlike many other movements, such as elbow flexion-extension, the center of rotation for prono-supination is not as well-defined. This movement involves the crossing and uncrossing of two bones, the ulna and the radius, in the forearm, as depicted in Figure 4.2. Models of the movement have been developed with varying degrees of accuracy [23, 24]. The basic model is to consider prono-supination as a rotation of the wrist along the forearm axis relative to the elbow, with gradual rotation along the length of the forearm producing a full ROM at the wrist. This basic model is the one considered in this thesis, as in many other works a simple description of joints is sufficient for general operation [136].

One study has assessed an upper bound of maximum pronation and supination torques of 13.0 Nm and 14.8 Nm respectively [138]. Another study has shown the lower bound of maximum torques to be 2.72 Nm and 3.08 Nm, respectively, in some individuals [139]. The observed differences in torque values are attributed to variations in study participants and protocols such as gender, dominant hand, position of the forearm, and position of the elbow joint. The ROM for pronation and supination, respectively, varies from 77.23° to 81.2° and from 82.4° to 93.13° from the neutral position, i.e. hand-shake position, depending on age, gender, and measurement method [140, 141]. Additionally, the median maximal velocities for supination and pronation were found to be 428°.s⁻¹ and 406°.s⁻¹, respectively, depending on gender,

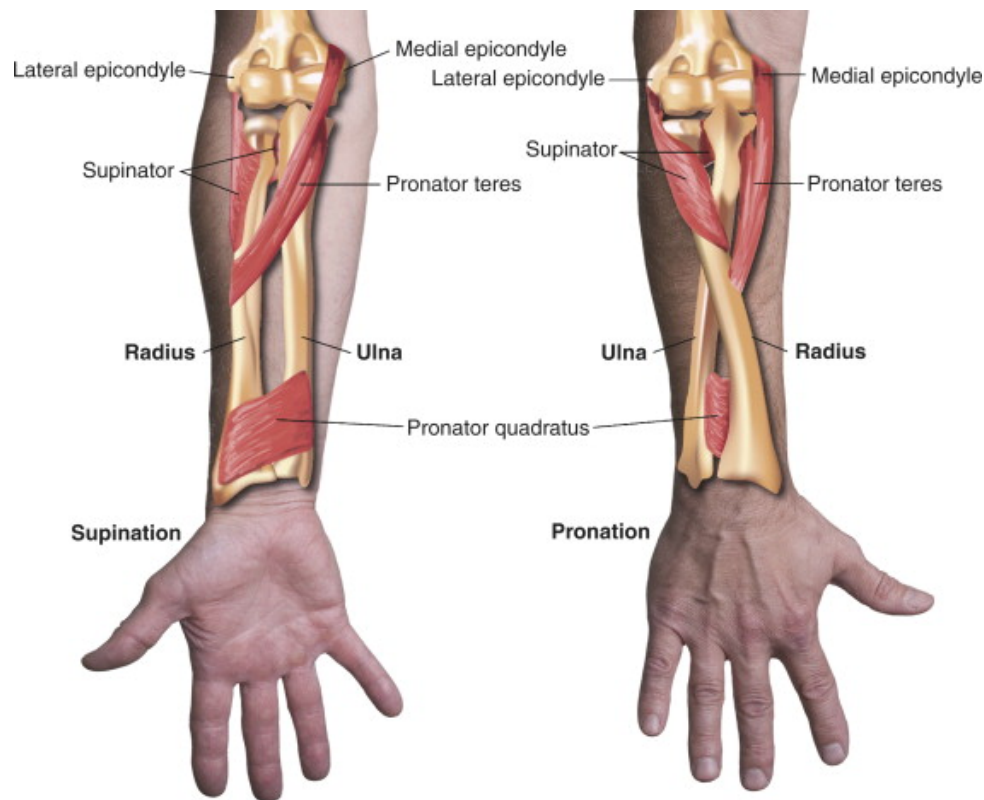

Figure 4.2: Bones and muscles of the forearm as it pronates and supines. *source: [137]*

dominant hand, and position of the elbow [142].

4.1.2 Assistive orthoses

While assistive devices can help to restore some autonomy for those with disabilities, they rarely offer a complete solution in terms of torque or ROM for example. Assistive orthoses are designed to provide functional gains, but there are few portable options available for pronation and supination. Indeed, most devices that take into account pronation-supination are dedicated to rehabilitation, where portability is preferred but not required. These rehabilitation systems for pronation-supination typically come in the form of a handle to be grasped with a palmar grip, often with a support for the forearm. The user is then required to force in pronation or in supination, against or in concert with the system depending on the targeted exercises [143, 144].

Regarding orthoses that take into account pronation-supination in addition to other movements, they are likely to be full upper limb exoskeletons, thus not portable, even if restricted to assistive orthosis for other upper limb motion, such as MyoPro [145]. This market-available orthosis is dedicated to patients with post-stroke hemiplegia. It assists elbow flexion and extension, along with grasp functions. However, the basic version of this device does not assist the pronation-supination movement. An option, the Multi-Articulated Wrist Unit, is necessary to simply allow free wrist movements, including pronation and supination. Another example is an orthosis that assists hand grasping, while including passive elbow positioning and passive hand positioning in pronation and supination [62].

To produce a rotation of the wrist relative to the elbow while being portable, an

assistive prono-supination orthosis must not have any components inside the forearm space, with minimized encumbrance and weight. As a result, most prono-supination portable devices employ relocation of the actuator, power supply and control unit away from the arm.

Pneumatic actuators possess high power-to-weight ratio and are compatible with soft architectures in orthoses, such as fabric-based helical actuators [64] or McKibben actuators [56]. However, as experienced in hand orthosis design, pneumatic actuation requires a compressor or air tank, considerably increasing the size and weight of the equipment [69]. And with only inflated or not inflated configurations, some positions can be challenging to reach. Pneumatic actuators can also prove too slow and fail to match user speed-of-movement.

Electromagnetic actuators are faster but produce limited torques at high speeds, essentially requiring the use of additional gears or linkages. Alternately, non-backdrivable gearing elements can lock a device position without continued power consumption, which could lead to lighter batteries. Although gears or linkage-based transmissions enable complex mechanism designs, the result is typically a heavier and bulkier device. Cables are frequently used with electromagnetic actuation. They are lightweight, flexible, strong, and are compatible with soft architectures. Implemented as external tendons, cables can be used as a transmission to drive machine components, such as links or pulleys. In a prono-supination orthosis they can vary the lengths of rods and cause wrist rotation [146] or turn the wrist utilizing a C-shaped cuff along the forearm [75, 147]. A pair of cables twisted around each other has been shown to produce high torques with low speed movements [148]. These “twisted string actuators” need no significant reduction stage resulting in relatively lightweight devices. Additionally, the drawback is that small diameter cables only pull and cannot push. As such, they frequently require a pair of cables working antagonistically and being pretensioned causing potential discomfort for the user and additional friction in the device.

Table 4.1 shows the ROM, torque, mass and actuation schemes of several prono-supination orthoses.

Reference	ROM	Torque	Mass	Actuation
Barlett [56]	78°	80 N actuator	2.26 kg (0.22 kg of wearable part)	Pneumatic, McKibben
Realmuto [64]	95°	1.5 Nm	0.2 kg without control system and air tank	Pneumatic, fabric based
Dias [75]	150°	?	0.145 kg without electromagnetic actuation	DC motor and bowden cable
Dežman [146]	180°	?	?	DC motor, cable and rod
Buongiorno [147]	146°	6.25 Nm	2.9 kg (including all wrist movements)	DC motor and cable
Tsabedze [148]	118°	?	?	DC motor and twisted cable

Table 4.1: Table of characteristics of several prono-supination orthoses.

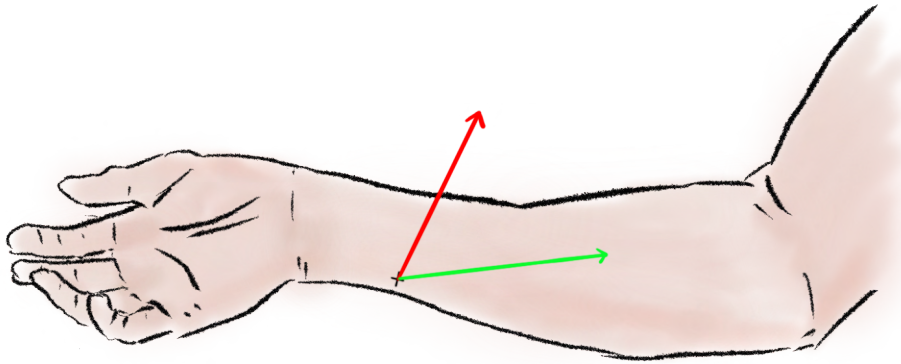

Figure 4.3: The red arrow is tangent to the forearm envelop, maximizing torque production, and the green arrow follows the forearm length, minimising encumbrance.

There have been relatively few assistive orthoses developed that focus on prono-supination, especially in comparison to those designed for the hand as seen in previous chapters [14].

In terms of ROM, these orthoses present considerable variation, with the greater ROM being more than twice as much than the lower ROM. Interestingly, the emphasis on providing assistance torque does not seem to be the primary focus of these orthosis developments, as only two of them mention torque values, while one refers to the force of an actuator. Regarding weight, there appears to be a consensus of approximately 200 g for the distal part, with an additional approximate weight of 2 kg for the actuation and control unit.

All of these devices relocate the actuation and control mechanisms to minimize the distal weight. This approach aids in reducing bulkiness around the forearm, as they work around it to produce a torque inducing rotation of the forearm.

4.1.3 A spherical mechanism for a prono-supination assistive orthosis

On the basis of our previous work, we intend to relocate the actuation by utilizing cables. However, achieving wrist rotation relative to the elbow while pulling cables and limiting obstruction is a non-trivial task. In fact, to maximize the torque produced by the pulling force, the force should be tangent to the wrist. Conversely, to minimize obstruction, the cable should run along the forearm. Figure 4.3 shows this issue, the red arrow is tangent to the forearm envelop, maximising torque production, and the green arrow follows the forearm length, minimising encumbrance.

A simpler case is elbow flexion, which is an example that is going to be developed for better understanding the complexity of prono-supination assistance. As shown by Figure 4.4, to maximize the flexion torque by pulling on a cable, one anchor point would need to be placed at the wrist and another at the shoulder, i.e., as far away from the axis of rotation as possible. However, this approach is not feasible for assistive elbow flexion orthoses due to the resulting high obstruction and incompatibility with pronation and supination when the anchor point is placed at the wrist. Consequently, a trade-off exists between cable obstruction and the transmission efficiency of cable

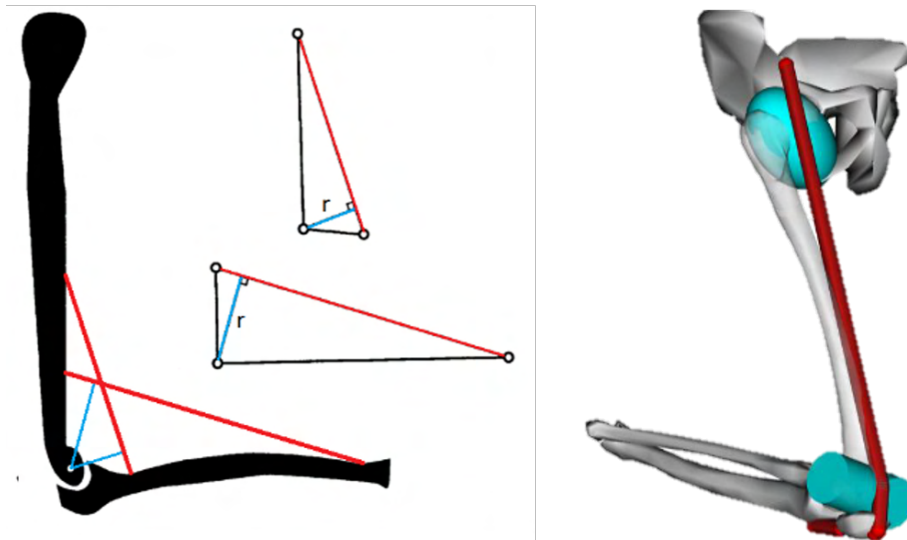

Figure 4.4: Example of distances between lines of action and center of rotation (left) and redirection of the pulling axis for elbow extension (right). *source [?]*

tension in producing bending torque [79].

The distinguishing difference between prono-supination and elbow flexion is that the axis of rotation runs longitudinally along the limb, as opposed to transversely. This characteristic poses a challenge in achieving a perpendicular force to the axis of rotation, which is necessary to generate maximal torque, while minimizing the bulkiness that would be required to overcome this challenge.

In the case of elbow extension, the human body developed a *wrapping* which represent a biomechanical solution that redirect the pulling axis, in some extend akin to a pulley, as shown by Figure 4.4. This change in the pulling axis can be referred as angle redirection.

This innovative approach enables a reduction in bulkiness while simultaneously optimizing transmission efficiency.

Regarding pronation-supination, achieving this solution is not straightforward. The continuous nature of the rotational movement along the forearm prevents the possibility redirecting the pulling axis via an appropriate mechanical element such as a pulley placed on the forearm. Figure 4.5 shows that a pulley fixed to the forearm, as well as the anchor point of the cable, would be affected by the same motion. Thereby, the pulley does not enable to create a motion relative to the anchor point.

Two main solutions remain. The first solution involves oversizing the actuators to adequately compensate for transmission losses associated with the axis of cable pulling. Indeed, when the cable axis is parallel to the rotation axis, no movement occurs, imposing only constraints on the forearm. As the cable becomes more perpendicular to the rotation axis, the transmission efficiency improves, but it must extend towards a proximal body part for mass deportation, thereby tending to align parallel to the forearm's rotation axis. The resulting enticement is to wrap the cable around the forearm, facilitating a pulling axis that is closer to perpendicular while extending towards the elbow. However, this introduces a new trade-off between transmission

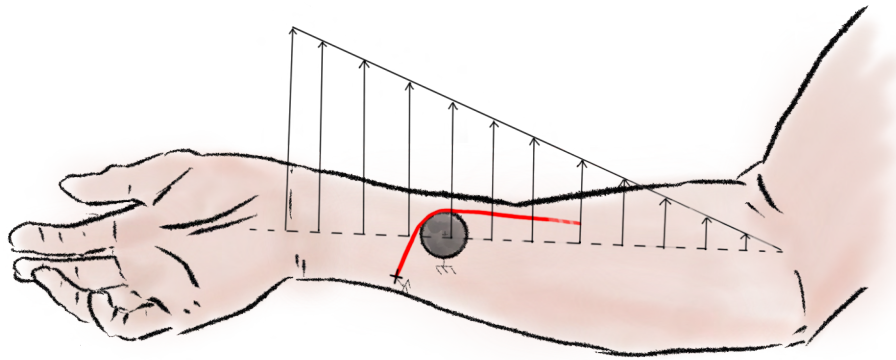

Figure 4.5: A pulley fixed to the forearm, redirects the pulling axis of a cable (red) which is anchored to the forearm as well. The velocity vector field shows that a pronation would result in a similar motion of the pulley and the anchor point. Pronation movement is considered as proportional along the forearm length.



Figure 4.6: Test with wristbands and cables: winding cable around the forearm (left) and angle redirection utilizing a pulley (right).

efficiency and the use of cable winding around the forearm, if such an approach is deemed viable.

To this end, simple cable tests were conducted to examine the feasibility of pronation-supination using cables, with and without cable winding around the forearm, and with and without a pulley for angle redirection. Figure 4.6 shows these tests and that cables apply too many constraints on the forearm tissues. In conclusion, angle redirection proves ineffective for pronation-supination and cable winding around the arm is not suitable for orthotic applications due to the excessive constraints imposed on the forearm since at least two cables are required for pronation and supination.

The second solution involves integrating a mechanism that can be actuated by a cable and can produce a force tangent to the wrist. In this context, the possibility of using a spherical mechanism is considered.

A spherical mechanism is a type of spatial linkage composed of rigid bodies interconnected by revolute joints. They are used to exert force on an object within a

three-dimensional space. The primary distinction between spherical mechanisms and planar mechanisms is the orientation of their respective axes of revolution. While planar mechanisms usually have parallel axes, all axes in a spherical mechanism intersect at a common point. As a result, a spherical mechanism's configuration is defined by the angles between its axes rather than their distances.

4.1.3.a Suitability as a prono-supination orthosis

A spherical mechanism was selected for investigation into an assistive orthotic design for several reasons. First, as their motion is prescribed by angles instead of lengths, spherical mechanisms can be designed to operate *around* a task, as seen in conceptualizations of the sort in [149] and [150], in the case of prono-supination, operating around the forearm is convenient space-wise, minimizing the encumbrance around the forearm while having a hollow center. Second, the point of a path on the coupler of a spherical four-bar mechanism follows a trivariate quartic curve [151] that can be designed to pass through nine points exactly [152] and many more than that to satisfying levels of accuracy [153, 154]. This versatility of the spherical four-bar could produce a force close to be tangent direction aligned with the wrist movement. Third, spherical mechanisms have been considered in a variety of applications including the agile eye [155], wrists [156], assembly operations [157], grippers [158], surgical robots [159], and wings [160], attesting to the versatility of spherical mechanisms. Finally, a pronation-supination orthosis only needs one degree of freedom in its output, and low degree-of-freedom mechanisms are readily synthesized that are capable of producing complex motions [149].

4.2 Synthesis of the device

This section focuses on the kinematic synthesis of the mechanism, it does not take into account any orthotic considerations. First, the synthesis of a single four-bar mechanism is presented. The goal is to follow a trajectory that closely matches a constant line of latitude. Then, three such four-bar mechanisms are coupled into a single mechanical system producing a rotational movement.

4.2.1 Synthesis of a single mechanism

The synthesis of a spherical four-bar mechanism has been done via optimization to identify a coupler point that closely matches points over an 80° sweep on a constant line of latitude at 45° above the equator, as shown in Figure 4.7. MATLAB's *fmincon* was utilized with both equality and inequality constraints, detailed below.

The location of the desired path points are given by

$$\vec{P}_i = \begin{Bmatrix} \cos(45^\circ) \cos(\theta_i) \\ \cos(45^\circ) \sin(\theta_i) \\ \sin(45^\circ) \end{Bmatrix} \quad (4.1)$$

where θ_i are the values from -40° to 40° evaluated on 4° increments. That is, $\theta_1 = -40^\circ$, $\theta_2 = -36^\circ$, ... $\theta_{11} = 0^\circ$, and $\theta_{21} = 40^\circ$. This defines a path synthesis problem and, having more than nine path points, optimization is used.

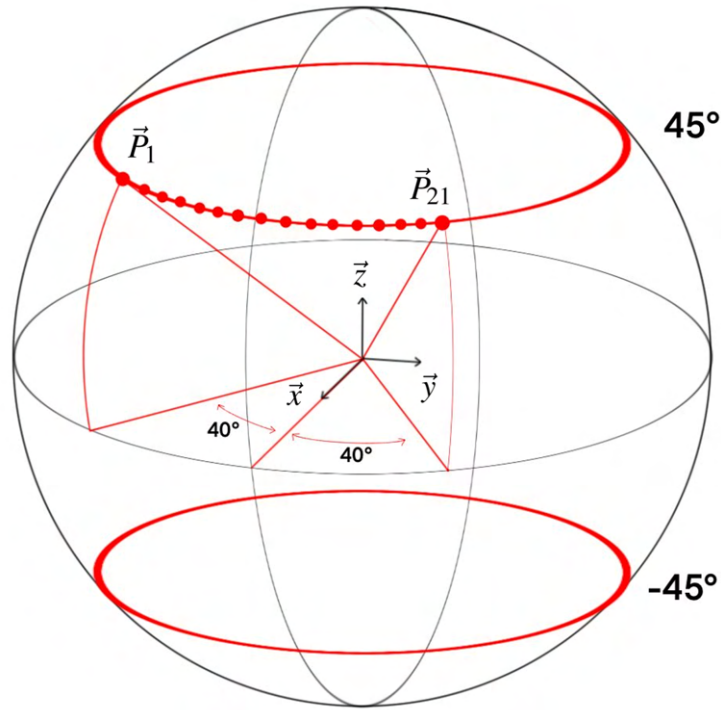

Figure 4.7: A spherical four-bar mechanism is desired to follow the path points \vec{P}_i along the line of latitude at 45° above the equator.

The fixed revolute joint axes of a spherical mechanism are \vec{G}_1 and \vec{G}_2 , as seen in Fig. 4.8. The moving revolute joint axes of a spherical mechanism are $\vec{Z}_{1,i}$ and $\vec{Z}_{2,i}$, when specified relative to the fixed frame with respect to the i^{th} location of a mechanism. For these axes to define a spherical four-bar mechanism, the axes connected by a link of a mechanism must remain constant:

$$\cos(\eta) = \vec{Z}_{1,i} \cdot \vec{Z}_{2,i}, \quad (4.2)$$

$$\cos(\gamma) = \vec{G}_1 \cdot \vec{G}_2, \quad (4.3)$$

$$\cos(\alpha) = \vec{G}_1 \cdot \vec{Z}_{1,i}, \quad (4.4)$$

$$\cos(\beta) = \vec{G}_2 \cdot \vec{Z}_{2,i}, \quad (4.5)$$

where all vectors are assumed to be of unit length. The coupler point of the mechanism, \vec{Q}_i in Figure 4.8, needs to be located to come as close as possible to the \vec{P}_i as the mechanism moves. The approach taken here is to not determine the point \vec{Q}_i as part of the optimization, but to determine this afterward once an ideal mechanism has been found. Instead the optimization seeks to minimize J where

$$J = \sum_{i=1}^{20} \left| \vec{P}_i \cdot \vec{Z}_{1,i} - \vec{P}_{i+1} \cdot \vec{Z}_{1,i+1} \right| + \left| \vec{P}_i \cdot \vec{Z}_{2,i} - \vec{P}_{i+1} \cdot \vec{Z}_{2,i+1} \right| \quad (4.6)$$

which is observed to minimize to the angle being nearly constant between the moving axes and the desired coupler point over the sweep of the mechanism. Also noted is that this makes every location i of $\vec{Z}_{1,i}$ and $\vec{Z}_{2,i}$ optimization variables. Admittedly, most of these variables could be eliminated through a more sophisticated approach, but acceptable results were obtained via the proposed method and implemented in the design.

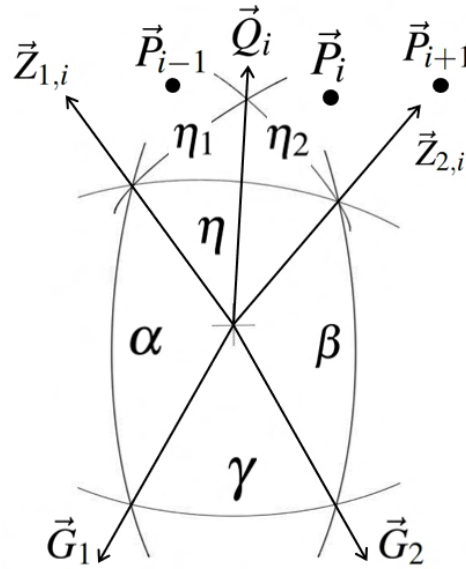

Figure 4.8: The axes of a spherical four-bar mechanism intersect at a common point.

For equality constraints, equations 4.2 - 4.5, are enforced over the range of i . Additionally, the requirement that all vectors be of unit length is introduced as a constraint. A desirable mechanism was deemed to be one with ring-like structures of the same size at both the $+45^\circ$ latitude circle for the coupler point and at the -45° latitude circle for the fixed pivots, as seen in the SOLIDWORKS modeled results of the kinematic synthesis shown in in Figure 4.9. As such, the z -components of \vec{G}_1 and \vec{G}_2 are constrained to be -0.7071 to keep them on the lower circle shown in Figure 4.7. The desired path points are specified along one line of latitude, and the z -components of the fixed axes on a different line of latitude, because the intended use of the device requires that the vertical distance between the fixed axes and the coupler point remain roughly constant.

Finally, as inequality constraints,

$$25^\circ \leq \alpha, \beta, \gamma, \eta \leq 90^\circ \quad (4.7)$$

are introduced for the sole purpose of constraining the mechanism to occupy a reasonable part of the surface area of the design sphere.

The optimization produced values of $\alpha = 65.5^\circ$, $\beta = 65.7^\circ$, $\gamma = 61.3^\circ$ and $\eta = 64.2^\circ$ defining the four-bar mechanism. Other notable results of the optimization are listed in Table 4.2.

The final step is the determination of η_1 and η_2 to complete the coupler and locate accurately the coupler point of the four-bar. This is done by averaging the angle found between the locations \vec{P}_i and the corresponding moving axis locations $\vec{Z}_{1,i}$ and $\vec{Z}_{2,i}$, respectively:

$$\eta_1 = \cos^{-1} \left(\frac{\sum_{i=1}^{21} \vec{P}_i \cdot \vec{Z}_{1,i}}{21} \right), \quad (4.8)$$

$$\eta_2 = \cos^{-1} \left(\frac{\sum_{i=1}^{21} \vec{P}_i \cdot \vec{Z}_{2,i}}{21} \right). \quad (4.9)$$

These angles are calculated to be $\eta_1 = 81.7^\circ$ and $\eta_2 = 81.7^\circ$.

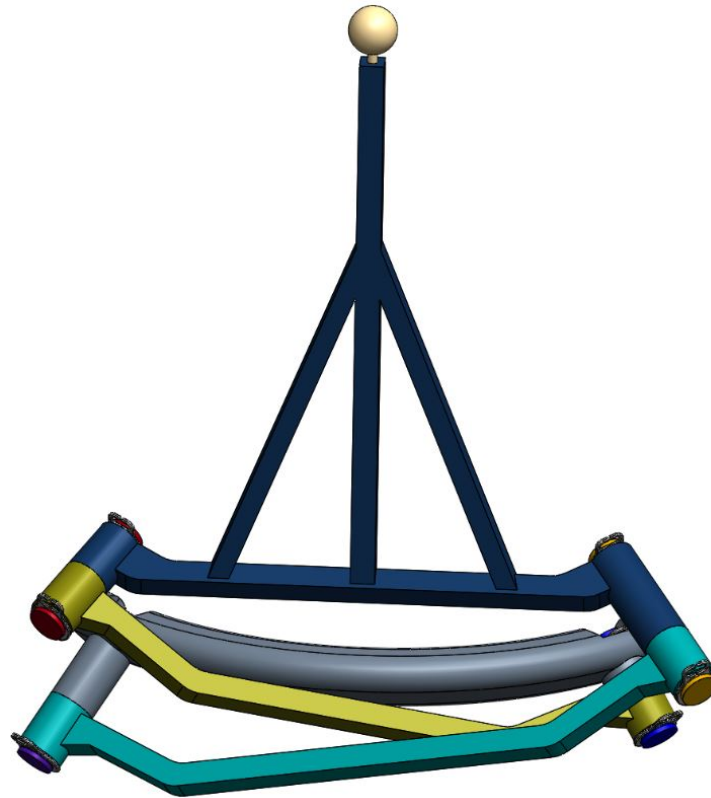

Figure 4.9: A SOLIDWORKS model of the results of the optimization.

4.2.2 Coupling mechanisms into a device

The result is a single spherical four-bar mechanism that includes a coupler point that tracks an 80 degree arc along the circle at 45° latitude. Now, the issue of implementing this mechanism into the overall design is considered, as depicted in Figure 4.10. As can be seen, the mechanism is repeated three times by rotating it in its entirety by 120° about the central (z -) axis located through the center of the rings. Three mechanisms are used to create stability of the top ring akin to a tripod. The design of the bottom ring is observed as straightforward, as it simply constrains the fixed axes of the three individual four-bar mechanisms. The design of the top ring is seen to be more challenging.

Vector	x -component	y -component	z -component
\vec{G}_1	0.4933	-0.5066	-0.7071
\vec{G}_2	0.4863	0.5134	-0.7071
$\vec{Z}_{1,1}$	0.8936	0.3816	-0.2363
$\vec{Z}_{1,11}$	0.6723	0.5412	-0.5051
$\vec{Z}_{1,21}$	-0.2704	0.5634	0.5678
$\vec{Z}_{2,1}$	0.5677	-0.5631	-0.6005
$\vec{Z}_{2,11}$	0.7118	-0.5211	-0.4709
$\vec{Z}_{2,21}$	0.8946	-0.3767	-0.2404

Table 4.2: The vectors defining the design of the spherical mechanism determined via the optimization.

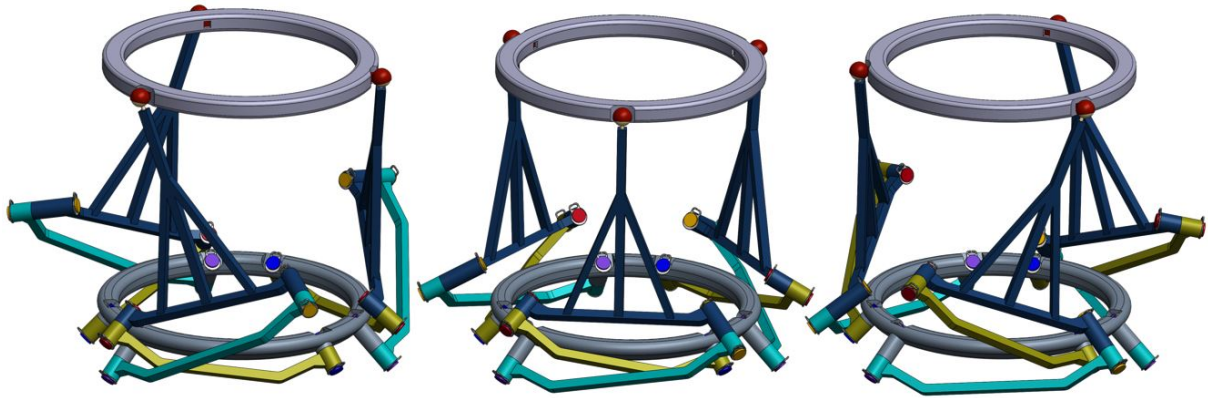

Figure 4.10: A SOLIDWORKS model of the general mechanical concept.

The coupler point on each mechanism follows the same trajectory along a spherical path by rotating said trajectory by 120° about the central axis of the device. As such, the distance between these points changes, even if the three four-bars move in perfect unison. For the synthesis, as performed on a unit sphere, the distance between the coupler point and the center of the circle at their current (and common) latitude varies over the motion from 0.7050 to 0.7109, for a total variation of 0.0059. Note that this is not stated as the location relative to the circle at 45° latitude because the plane defined by the three coupler points rises and falls slightly relative to that plane over the proposed ROM of the device. By positioning a sphere radius of 50 mm (closer to the eventual size of the proposed device), the movement inward and outward is seen to be 0.296 mm. Connecting the three coupler points with a single part requires compensating for this change in distance. Although different options can be considered for compensating for this modest change, the introduction of Spherical (S) joints at each coupler point with a Prismatic (P) joint between each and the common ring, seen in Figure 4.10, are introduced to allow the necessary motion inward and outward from the center of the circle.

One additional observation about connecting the coupler points is warranted. Although the distance from a common circle center varies, if all three mechanisms move together, the angle from the circle center to any two of the coupler points stays constant at 120° . As such, the top ring is designed to constrain the axes of the three P joints to be separated by an angle of 120° .

4.2.2.a Degrees of Freedom

A spherical four-bar mechanism has one DOF. Three of them, uncoupled, will have $\text{DOF} = 3$. The design proposes to couple the three four-bars, but in a way that no longer uses a strictly spherical architecture. The ball and prismatic joints allow motion of the bodies not on spheres concentric about the center point. Applying the standard spatial formalism to the proposed device, the number of bodies is $L = 14$ including 1 fixed link, 9 links in the three four-bars, 3 spherical joint to prismatic joint connections, and 1 coupling ring connecting the prismatic points. Having 12 Revolute (R) joints, 3 P joints, and 3 S joints,

$$\text{DOF} = 6 \times (14 - 1) - 5 \times (15) - 3 \times (3) = -6. \quad (4.10)$$

This general spatial counting misses the idea that each spherical four-bar connects the R joints with intersecting axes, thereby creating a degree of freedom. A common trick

for addressing this is to regard a spherical four-bar as a collection of one **R** joint with 3 Cylindric (**C**) joints, changing 9 of joints from a single degree of freedom to two degrees of freedom. The calculation becomes

$$\text{DOF} = 6 \times (13) - 5 \times (6) - 4 \times (9) - 3 \times (3) = 3. \quad (4.11)$$

Based on interacting with the SOLIDWORKS model, 3 degrees of freedom for the device appears correct.

To conclude $\text{DOF} = 3$ is correct, the *Fermat-Toricelli (F-T)* point was considered [161, 162]. The **F-T** point is the unique point such that the sum of the distances from each of a triangle's three vertices to this unique point is minimized. In the case where the largest vertex angle of the triangle is $\leq 120^\circ$, this **F-T** point also views the three sides of the triangle in an angle of exactly 120° . This concept applies for three reasons. First, the top ring housing the 3 **P** joints is designed to require the joints act along lines separated by an angle of 120° . Second, moving the four-bar mechanisms independently identifies three unique locations for the **S** joints in space. Finally, as each **S** joint only moves over a limited **ROM** on the sphere, the triangle connecting the three points always has vertices forming angles of less than 120° . In conclusion, defining the locations of the **S** joint at each mechanism's coupler point independently, and introducing the requirement for the floating ring to separate the **P** joint axes by 120° , a spatial triangle results with a unique **F-T** point. Thus, $\text{DOF} = 3$ is the appropriate conclusion for the overall device that included the ring coupling the three four-bar mechanisms.

4.2.2.b Reducing **DOF** from 3 to 1

Although the device as proposed has 3**DOF**, the additional motion capacity is not desirable with the intended use being pronosupination. Lowering the **DOF** can be achieved through the observation that the three component four-bar mechanisms should all be driven following precisely the same protocol. As such, a single actuator mechanically connected to the three inputs reduces the **DOF** from 3 to 1. This is understood to be a trade between increased design complexity in order to reduce encumbrance, weight, and control complexity.

4.2.3 Determining the transfer function of the mechanism

This analysis aims to determine the transfer function of the mechanism, mainly torque-wise, for the purpose of sizing. The input torque, T_{input} , is considered as applied to one crank. The output torque, T_{output} , is the torque supplied by the device at the output ring. The transfer function, torque-wise, is the torque ratio.

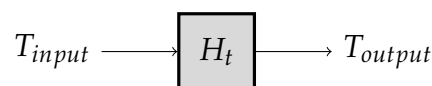

A kinetostatic analysis was performed with data collected from a kinetic analysis in SOLIDWORKS. The input crank was driven at 1 rpm over its 35° **ROM**. This angular velocity, called Ω_{input} , results in a 80° motion at the output ring of the device. The analysis provided the linear velocity V_{output} , of the coupler point (identical to the location of the **S** joint) over the motion.

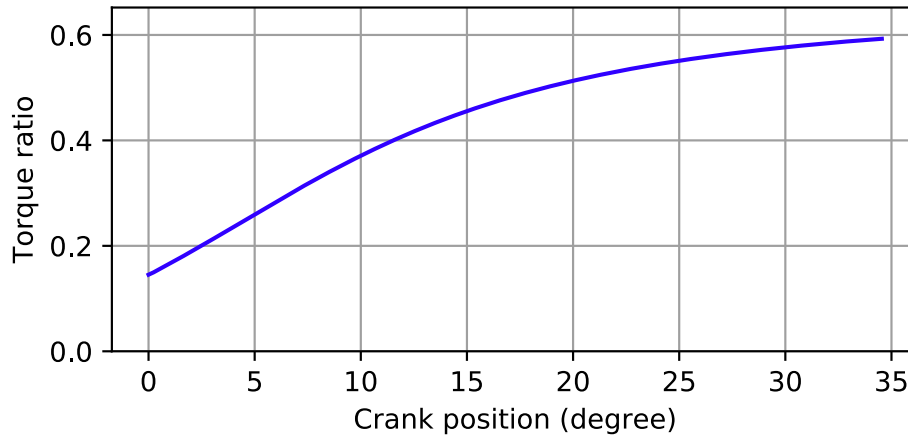

Figure 4.11: The torque ratio over a 35° sweep.

Considering the conversation of power between input and output of the mechanism, the following equation can be written:

$$P = F_{output} \cdot V_{output} = T_{input} \cdot \Omega_{input} \quad (4.12)$$

with P being the power, the output being a coupler point, its force and its linear velocity noted respectively F_{output} and V_{output} , the input being one of the bars linked to the bottom ring, its torque and its angular velocity noted respectively Ω_{input} and T_{input} . The output torque and angular velocity depend on the radius of the top ring, R_{ring} . The relations are:

$$T_{output} = F_{output} \cdot R_{ring} \quad (4.13)$$

$$\Omega_{output} = V_{output} \cdot R_{ring} \quad (4.14)$$

Thus, the transfer function in torque is:

$$T_{input} \longrightarrow \boxed{H_t = \frac{\Omega_{input}}{V_{output}} \cdot R_{ring}} \longrightarrow T_{output}$$

The transfer function, velocity-wise, is the inverse of the torque-wise transfer function.

$$\Omega_{input} \longrightarrow \boxed{H_v = \frac{1}{H_t}} \longrightarrow \Omega_{output}$$

The kinematic analysis on SOLIDWORKS was performed on a ring diameter of 70.72 mm.

It turns out that the linear velocity of a coupler point changes over position, consequently all the other quantities also vary, including transfer functions. Figure 4.11 shows that the torque ratio increases along the crank rotation, from 0.15 to 0.59. Thereby, the mechanism applies a torque reduction.

4.3 Toward the design of an orthosis

To consider this device as a component in a prono-supination orthosis, some technical requirement of assisting in ADLs must be considered.

The prono-supination movement primarily serves to position the hand, noting that the maximal torque, ROM, and velocity are not needed to achieve ADLs. An investigation of 19 ADLs determined that the maximum required torque for supination was 0.06 Nm and less than 0.05 Nm for pronation [134]. An earlier study revealed that only 100° of forearm rotation was needed for ADLs [163]. Although certain tasks may require a significant pronation or supination, recent research indicates that the maximum displacement arc of prono-supination for ADLs is $103 \pm 34^\circ$ and was observed when using a fork [164]. One study suggest that the arm is so adaptive that its specific motions during tasks is less important to understand than the start and end points for the task [133].

This section presents a concept for a device proposed as a prono-supination assistive orthosis. To determine the feasibility of this orthosis and the properties of the device, a rapid prototype of the mechanism designed in the previous section was created as a real-life proof of concept. The initial prototype was subsequently adapted to a mannequin-mounted prototype.

4.3.1 Concept for the orthotic device

The device composed of three mechanisms was designed to produce a limited ROM of 80°. Although some ADLs lie within this range, it is insufficient for accomplishing all ADLs. In addition, the orthosis must be sized to fit the user's forearm dimensions, in radius at the elbow side and at the wrist and the distance between them, while minimizing encumbrance.

The orthotic concept proposed herein is to connect end-to-end, or stack, two such devices keeping the outer radius of the orthotic only modestly larger than the arm, as seen in the concept depicted in Figure 4.12. The two layers would include three rings and results in a combined motion. One ring would be at the proximal end of the forearm attached near the elbow, one at the distal end connected to the wrist, and one between them and not attached to the forearm. Indeed, it is essential to avoid imposing motion on multiple areas, as this could result in conflict between the biological movement of the forearm and the motion imposed by the orthosis.

The idea of stacking two such devices doubles the achievable ROM to 160°, well beyond the 100° specified for ADLs. Moreover, the stacking of layers in the mechanism provides flexibility in sizing to fit the user's dimensions, as each layer can be configured with a distinct set of parameters.

Driving the top device is expected to be performed mechanically through a connection to the bottom device, keeping the degrees of freedom of the system at 1. This raises the question of designing the original mechanism to simply achieve the required 100° sweep. The device was designed to achieve only 80° of motion because an increase results in the coupler point travelling a greater distance along z , especially given the other constraints on the design.

In terms of torque, the required torque for achieving ADLs is found to be 0.06 Nm. For a single-layer mechanism, this results to a input torque ranging from 0.41 Nm to 0.10 Nm, as shown in Figure 4.13.

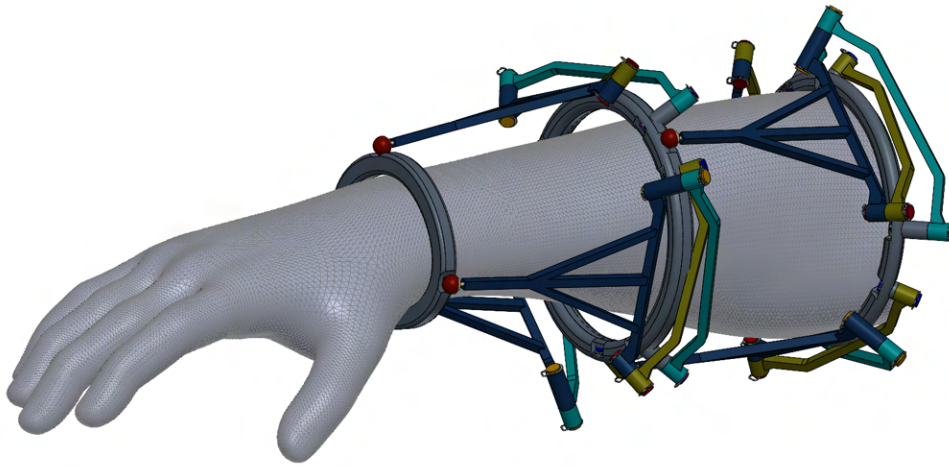

Figure 4.12: The design concept under consideration stacks the proposed device to extend from adjacent to the elbow to in-line with the wrist.

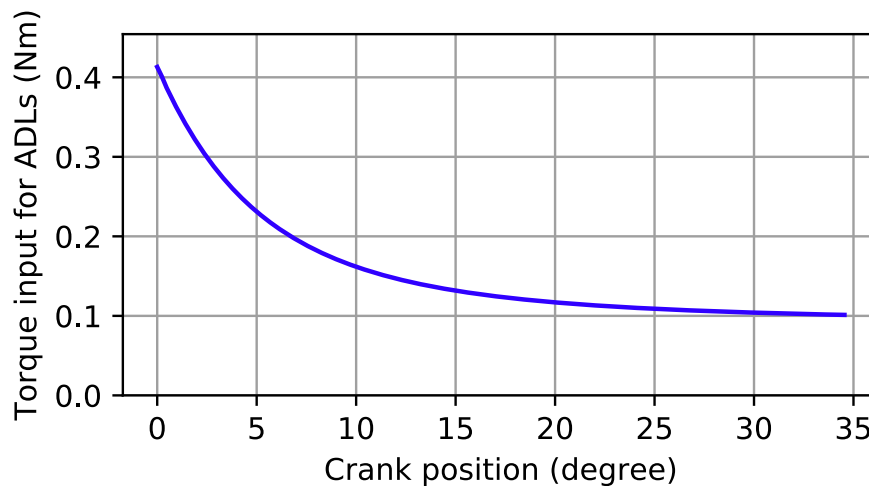

Figure 4.13: Required input torque for ADLs with a single-layer mechanism over a 35° crank motion.

4.3.2 Prototypes

To verify the properties of the mechanism and thus the feasibility of this concept, two prototypes of a one-layer mechanisms were created.

4.3.2.a Initial prototype

A prototype of an early model is shown in Figure 4.14, 3D-printed to confirm the ROM, degrees of freedom, and to test actuation schemes. The rapid prototype was not tested rigorously, but a single actuator was successfully connected via cables and pulleys to the three inputs of the individual four-bar mechanisms, successfully reducing the input DOF to 1. In the case of a single mechanism, a cable runs from the link connected to the bottom ring at $\vec{G}1$ around a pulley and then connects to the link connected at $\vec{G}2$. A torque applied to the pulley tensions the cable in one of the two connects causing a rotation of the spherical four-bar link which, in turn, causes the motion of the spherical joint along the circular arc. Reversing the pulley direction reverses the motion of the spherical joint.



Figure 4.14: A rapid prototype for gauging the ROM and test actuation via cables.

The experimental results confirm that a single actuator, with appropriate components, can actuate all three mechanisms in both directions. Another outcome concerns the motion of the three coupler points inward and outward from the center of the top ring, seen to be 0.296 mm for a 50 mm sphere radius. While prismatic joints were introduced in the kinematic synthesis to offset this minor displacement, the rapid prototype does not require any prismatic joints. As a matter of fact, the change in the distance is insignificant enough to be included in the global play of the device. However, the poor quality of this rapid prototype leads to a lot of play, no strut has been used and the mechanism seems to collapse under its own weight.

To assess that any of these properties are still valid on a proper real life mechanism, a human sized proof of concept needs to be manufactured with a better quality.

4.3.2.b Mannequin-mounted prototype

A smaller version of the device has also been manufactured. The main objective is to verify that its properties are scalable with a rapid prototype of human size. The prototype's purpose is for testing on a mannequin rather than a human forearm.

In order to don and remove the device around a forearm, the design must be modified. A version with an opening in both rings has been proposed [4.15](#).

A modified splint has been used to connect the top ring to the wrist while a strap connects the bottom ring to the forearm. The modified splint and the result are shown in [Figure 4.16](#). The actuation is produced with a pulley and six cables. This device was not actuated on human forearm. An Arduino Uno and a driver controlled a stepper coupled to the pulley. Two switches enable choosing the direction and the activation of the movement.

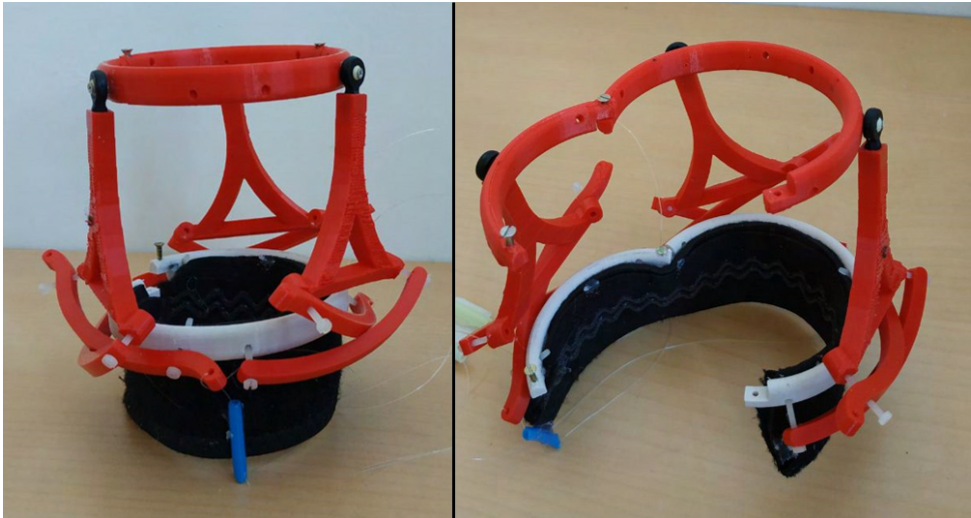

Figure 4.15: Human-sized version of the device with an opening in the rings in order to don and remove from the forearm.

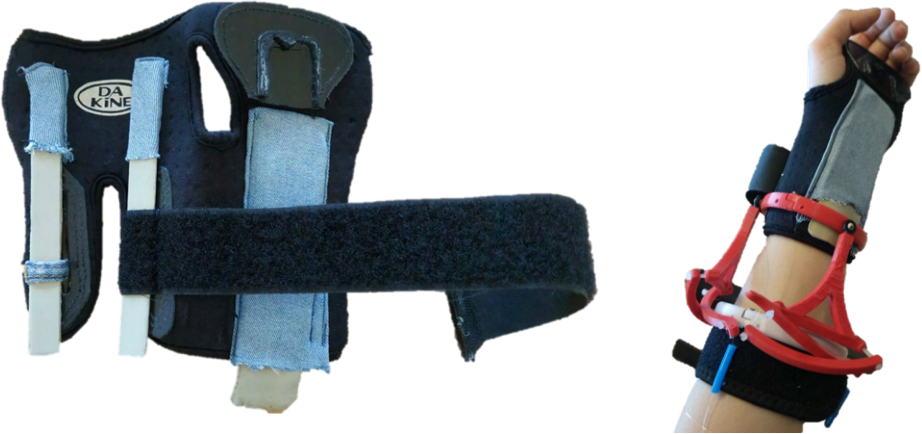

Figure 4.16: Modified splint to connect the top ring to the wrist (left) and the resulting device on a forearm (right).

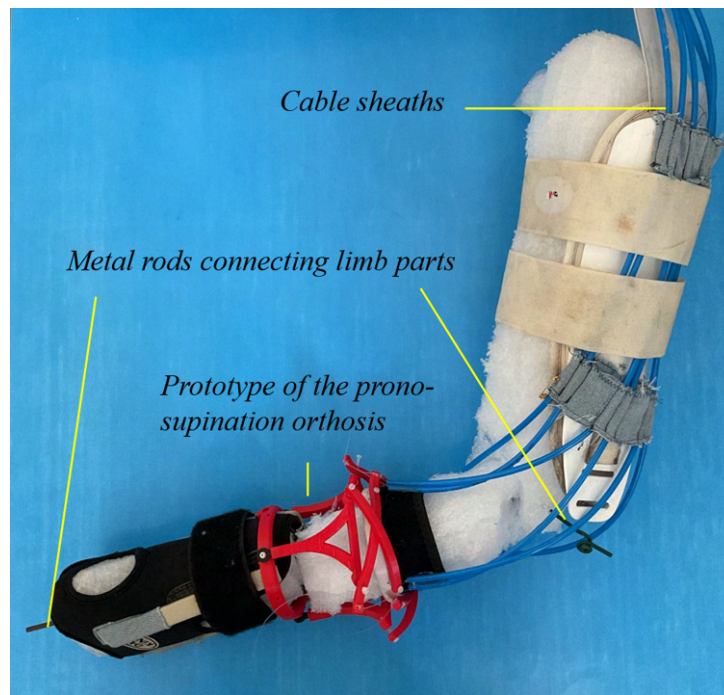

Figure 4.17: A mock-up of the device verified functionality at human scale.

A crude polystyrene mannequin was created that comprised a torso, arm, elbow, forearm and wrist. The prono-supination movement, as the elbow joint, consists of a single metal rod that connects the limb parts, as shown by Figure 4.17. Thus, the movement here is considered as a pure rotation along the forearm axis. The dimensions of the limb parts have been selected to resemble those found in human anatomy. As no dynamics has yet been considered in this study, sizing has not been done. The actuator and required driver, cables and sheaths were determined arbitrarily, and were over-sized to ensure functionality. The resulting setup is shown in Figure 4.17.

Those properties verified on the initial prototype have also been confirmed on the mannequin-mounted prototype. Notably, the quality of the movement appears to have improved, attributed to both the smaller scale of the mannequin-mounted prototype and the superior quality of the materials used, particularly the spherical joints. We believe that the mannequin-mounted prototype is a promising representation of the performance of the orthosis.

4.4 Discussion

Feasibility and utility of the mechanism are yet to be demonstrated, especially as a prono-supination orthosis. This is particularly true given that the current device is based on kinematic studies, with no consideration for dynamic factors. Thus, it is not excluded that dynamic matters would abort the project, requiring for example the use of heavy components or a significant input torque to generate adequate output torque, which would likely render the mechanism unsuitable for portability. That being said, this consideration is highly related to the actuation scheme, which has not yet been fully determined. In addition, the torque required for assisting in ADLs being as low as 0.06 Nm, required power consumption and power needs are limited.

Considering the ROM, the current mechanism achieves 80° of motion. While this ROM is sufficient for some ADLs, 100° are required in order to complete all ADLs, including using a fork. Solutions include but are not limited to:

- Designing the original mechanism to simply achieve the required 100° sweep. With the current optimization constraints, an increase in sweep range results in the coupler point travelling a greater distance along z , which is not currently acceptable. Whether a sliding mechanism should be added to nullify this rise and fall movement on the forearm or a new set of constraints should be determined. This solution has not been explored.
- Positioning the mechanism closer to the elbow. since the natural rotation of the prono-supination motion is gradual along the forearm, implementing an 80° rotation of the proximal part of the forearm in relation to the elbow could potentially provide a sufficient improvement in ROM at the wrist. However, this would likely necessitate a higher required torque and could potentially cause discomfort for the user. As such, this approach has not been deemed satisfactory.
- The stacking solution was chosen for several reasons. Firstly, the proposed solution achieves a motion of 160° . Secondly, this approach offers the advantage of facilitating the fitting process for users of different dimensions. Specifically, the two layers would be produced using distinct sets of parameters resulting in differing sizes, which would be better suited to the wearer's forearm dimensions. Additionally, the use of smaller layers would reduce the overall bulk of the device, since the movement of the part follows the surface of a sphere, a larger radius would increase the device's encumbrance. However, it should be noted that until slaving between the layers is complete, two separate actuators would be required. This could potentially compromise the device's portability. We remain confident since the movement of each layer is identical with an 80° difference, it appears feasible to develop a slaving mechanism that would enable the use of a single actuator. Moreover, the possibility to stack layers of the designed mechanism, slaved or not, would broaden the application fields of the device.

Although a two-layer device has not yet been prototyped, a prototype of a single-layer device has been tested. Given that the proposed orthosis is based on two identical mechanisms, a properly actuated two-layer prototype is expected to function as intended.

Both the initial and the mannequin-mounted prototypes were manufactured in a limited time by a student whose focus was on rapid realization, without changing SOLIDWORKS parts to optimize their functionality for actual use. These prototypes, especially the one on the mannequin, are sufficient to verify the designed mechanism's properties and considered actuation scheme. However, the modified splint hinders wrist extension, flexion and deviations. Measurement and further studies were not considered on these prototypes because the quality, notably part shapes and the absence of struts, won't permit usable design inferences.

4.4.1 Perspectives

The next steps in this project involve designing the slaving mechanism for a two-layer device and a dynamic study to enable shape optimization of each part. The goal is to

determine the required forces and select materials that minimize the overall weight and encumbrance of the device. Spherical mechanisms only require the revolution axes to intersect at the center of the sphere. This allows for a wide range of shapes to be considered during the shape optimization process.

As for the orthotic concept, we focused this preliminary investigation on the feasibility of synthesizing a spherical mechanism aimed at assisting prono-supination. We did not consider all aspects of an assistive orthosis. Specifically, we do not address control strategies, input commands, or user feedback, which are well-developed areas of research in their own right. In terms of input commands, the various options mentioned in previous chapters are still available.

We believe that a tower made of stacked mechanisms may prove to be a compelling concept, particularly when considering variations in ring radius along the structure. Note, however, that our study considered the designed mechanism within a limited ROM of $\pm 40^\circ$ from its neutral position. Beyond this range, the coupler points - and by extension, the top ring - begin to fall along z . Upon a full rotation of the input crank, the top ring exhibits a rise-and-fall movement, along with the rotation, that warrants further investigation. Any attempt to explore this intriguing motion would require significant effort to ensure that collisions between parts are avoided, if that is even feasible.

Finally, a new prototype with a proper quality is a work in progress. The design of most parts have been greatly improved since the rapid prototyping. Notably, struts will be used to limit power losses due to non secant axes of the spherical mechanism.

FES was not considered in this work. Selective FES on pronation and supination is a complex issue. From an engineering standpoint, it may not be necessary to utilize FES in order to reduce the required actuator torque, given the low torque requirements for activities of daily living. Nonetheless, FES can be implemented on the hand and wrist. As noted previously, achieving ADLs with a functional hand, even with the aid of FES, Grasphyb or Exofinger, is challenging due to the positioning of the hand. Therefore, this prono-supination orthosis is primarily intended to be used in conjunction with those - or other - technical aids.

4.5 Conclusion

The focus of this work was on the kinematic synthesis of a mechanism that could be used in a prono-supination orthotic. First, a spherical four-bar mechanism was synthesized for creating the rotation of a ring component that stays close to a 45° line of latitude. Second, three of these four-bar mechanisms were combined into a single device. The device, being able to create an 80° ROM at the top ring relative to the bottom ring, while holding the top ring at a nearly fixed distance from the bottom ring, shows promising motion properties in this application. To accomplish all ADLs, an additional 20° of motion is necessary. One proposal for accomplishing this, and providing the wrist something akin to its full ROM, would be to attach two of these devices end-to-end. Two prototypes were created, verifying some of the properties of the designed mechanism.

This work also evaluated the proposed concept in terms of the state of the art in orthotic design and the corresponding biomechanical requirements. Portability imposes many design requirements that are difficult for any individual design to address. Intriguingly, for this specific part of a more complex arm orthotic, the torque requirements for assisting in ADLs are exceedingly low at 0.06 Nm. Thus, this part of the orthotic can focus on comfort, usability, developing the kinematics of the motion and minimizing the encumbrance of the system as opposed to focusing on the powering and actuation needs. A device composed of a spherical four-bar mechanisms seems well-suited for an assistive orthosis, encumbrance-wise. This work presented some of the initial investigation into these topics. As such, this work does not encompass many of the facets of an assistive arm orthosis and feasibility of the mechanism as a prono-supination component in an orthosis is yet to be demonstrated.

General Discussion - Conclusion

5.1 Discussion

The aim of this thesis was to explore the design of assistive orthoses to help people with SCI recover some autonomy by restoring grasping functions. The focus was made on avoiding distal weight by utilizing cable driven systems. Since matters specific to each previous chapter have already been discussed, more global concerns are discussed here, such as the choice of considering assistive orthoses for functional gain or the accessibility of such devices.

5.1.1 Examining choices made

5.1.1.a Assistive orthoses or assistive robots

On the market, technologies for people with SCI are often assistive robots such as feeding robots rather than assistive orthoses.

A feeding robot's goal is to assist the user in feeding - actually in every task requiring raising the hand to the head - without the need of a third party [60, 165]. These devices are mounted on wheelchairs or beds, so there is no need for fitting the user's morphology, unlike assistive orthoses.

If a mounted external robot is acceptable for task completion, a robot arm with a least 6 axes and a proper gripper would enable completion of most ADLs [166]. However, the added mass and encumbrance of such a robot is likely to be more significant than a device taking advantage of the human body, whose mass is present in both cases. A mounted robot is difficult to dedicate to people without motorized wheelchairs as the portability would readily impair their mobility. That said, the research community has developed extra-limbs, such as a limb to grip [167], a third thumb [168, 169] or a protrusion on the palm to help hold an object [170].

These type of devices, along with assistive robots, constitute a parallel approach to the development of assistive orthoses, toward the goal of autonomy. In our designs, we only considered FES and assistive orthoses, rather than assistive robots. This choice

was based on the fact that these technologies empower individuals to perform tasks autonomously using their own bodies.

5.1.1.b Grip assistance choices

This thesis was intended to explore new solutions for restoring grasping functions through orthoses. We focused on the key grip and power grasp. This choice is now discussed.

While pinch manipulations are the common kind of grasp used for [ADLs](#), designing a proper assistive device proves challenging, especially considering portability. The same is true for non-prehensile movements. In order to encompass the majority of non-prehensile and precise grasps, actuation is likely to be required for every digit and likely separately to include the various movements. Our hypothesis is that the trade-off functional gain - variety of movement, is better for the key grip and power grasp.

After having examined both grasps, a single assistive hand orthosis could encompass key grip and power grasp assistance. Such an orthosis would include flexion-extension of the long fingers, thumb flexion-extension and thumb positioning in opposition can be passively performed, i.e. without actuation. As for the Aufratech orthosis, an actuator dedicated to the long fingers can have a differential enabling each digit to be in contact with objects of various shapes. The thumb flexion-extension would be actuated by another actuator. On one hand, flexing all the fingers, a power grasp is performed. On the other hand, flexing long fingers first ensures that the flexion of the thumb could result in a contact with the lateral side of the index finger, performing a key grip.

5.1.1.c Focusing on a limb or function and not on a more global view

Most current assistive orthoses focus on a limb part or a function. In fact, the [ISO](#) classifies orthoses according to the limb part considered. Even orthoses that include two limb parts considered each part separately. This begs the question of synergy in movements. A study exploring the synergy in motion of different joints during [ADLs](#) could draw guidelines for designing assistive orthoses with coupled motions. For example, a drinking task requires forearm pronation, elbow flexion and shoulder medial rotation. As a matter of fact, some upper limb functional surgeries couple two motions, including pronation and elbow flexion [[171](#)].

We considered using soft anisotropic 3D-printed components to realise the coupling of forearm pronation and elbow flexion. [Figure 5.1](#) presents a 3D-printed part in which the anisotropy was positioned such that a tripod results in a rotation of the center [[172](#), [173](#)].

As a proof of concept, a thin rectangular prism was printed in Thermoplastic PolyUrethane (TPU) with IceSL which is a Computer-Aided Design (CAD) software and a slicer. The anisotropy is placed in the middle along its length consisting of a stretch of porous template. Both side extremities have higher density. This proof of concept, as well as a longer version are shown in [Figure 5.2](#). On one hand, the anisotropy enables the prisms to bend easily in a direction. On the other hand, the

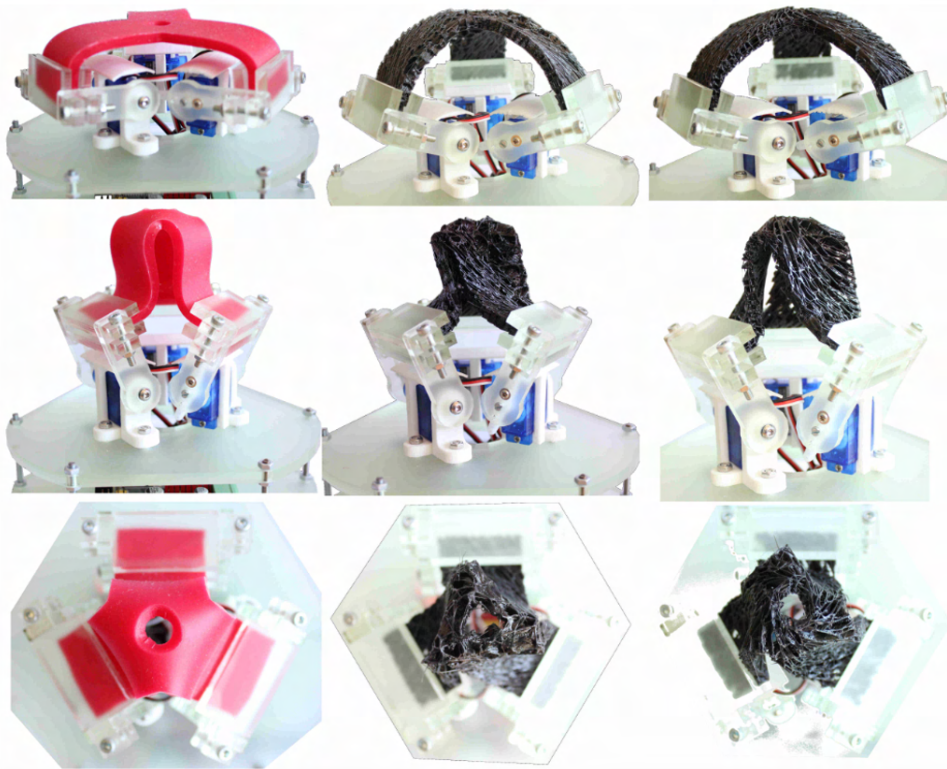

Figure 5.1: Three tripods with different mechanical properties. The middle and right components have anisotropy leading to a rotation when each segment of the tripod is brought together. *source: [173]*

higher density on both side extremities ensures that the bending is not possible in other directions.

Then, a larger component was designed and printed to ensure that scaling is possible. Also, channels were designed inside higher density areas, with the intention of passing sheaths through the component, as shown in Figure 5.3.

In the context of this thesis, we did not explore further the use of such 3D-printed soft anisotropic components in an assistive orthosis. Designing such components for performing the coupling of two motions, such as pronation and elbow flexion would require more work. Also, as the main drawback of tool adaptations is their single task design, we were concerned that an assistive orthosis with a coupled motion could lead to a single task use, and thus to abandonment as well. However, this innovative use of 3D printing results in a lightweight and rapidly manufactured component. In addition, this process is cheap and can be widely reproduced with a 3D-printer, leading to better accessibility. For these reasons, we believe this is worth exploring further.

5.1.1.d Evaluation difficulties

The wide variety of hand orthoses in literature shows that a consensus has not been met on a specific device. In fact, very few devices are on the market. The difficulty in rating one device relative to another is partly responsible. Objective functional tests have been proposed, including the Action Research Arm Test (ARAT), Box and Block and Upper Limb Performance Assessment (ULPA) tests [174, 175, 176] but they are

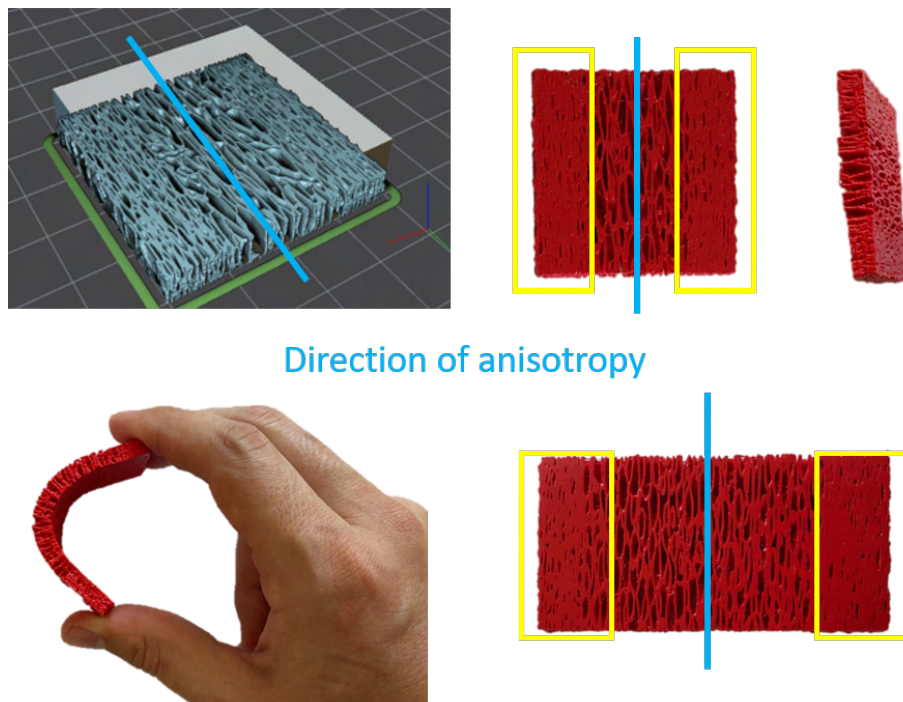

Figure 5.2: Design of anisotropic thin prisms which allow bending in only one direction. Blue lines show the axis of anisotropy, yellow areas refer to higher density.

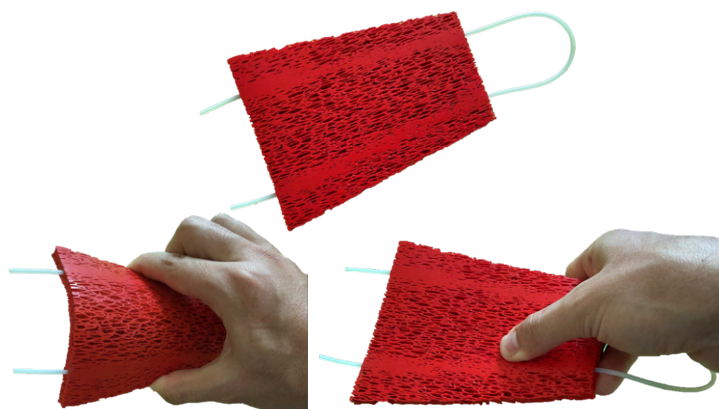

Figure 5.3: Larger anisotropic thin prism with channels for cable sheaths.

not widely used by hand orthosis designers. Reasons include the difficulty in setting up the tests because of the required standardized equipment and the participant recruitment. As a matter of fact, a majority of hand orthoses are not tested on people actually having hand impairments.

Ultimately, only end-users can rate an assistive device. Toward this goal, surveys resulting in scores have been designed. The [SUS](#) is one of them and because it is quite widespread we employed it in this work. However, its construction has been criticized. According to an empirical study, the [SUS](#) score should be interpreted as having the median value of 70 - and not 50 - out of 100 [177]. This would result in considering devices with a score below 70 as not acceptable. Any way of rating an assistive device is likely to be criticized as they are either subjective or not adapted to a specific combination of device and impairment.

Involving end-users at every step of the design and validation seems to be the best approach to acceptance [178, 179]. In order to collect end-users requirements for hybrid orthosis, we participated in the design of an online questionnaire [180].

As for validation of a design or concept, we believe that only end-users are qualified for doing so. Thus, we recommend that assistive orthosis design include validation with people with hand impairments, despite the difficulty in recruitment and ethics committee procedures. The remaining difficulties could be to address the variety of feedback resulting from experiments with a large population. From then on, customization plays a crucial role.

5.1.2 Customization and accessibility

Customization appears to be critical for assistive technology adoption by people with [SCI](#), due to large variation in needs and impairments.

Most assistive devices which can be accessed are likely to be available on the market. There is a high demand for assistive devices for people with [SCI](#), but there is not a large market for it. Developed devices are expensive to acquire. Indeed, the notions of customization and accessibility are likely to be seen as opposing. This is market and business related. On one hand, a device being dedicated to a narrow type of need results in few potential users, and the price of the device is likely to be high to ensure a profit that covers development cost. On the other hand, a generic device is adapted to no one. This trade-off seems to be a serious challenge to the industry and can explain the lack of a widely adopted assistive orthosis on the market for people with [SCI](#).

Alternatively, the numerous research prototypes for restoration of upper-limb function proves that the research community is active and proactive in the field. However, on most occasions, developed prototypes are not intended to be on the market, and they are likely not to be suitable for market for the same reason as for industry. Even for low cost prototypes, research has no means of distribution.

Humanlabs could be an alternate solution for both this customization-accessibility trade-off and the distribution issue. The developed devices are open-source, available online and can be manufactured in every Fab lab, which are increasingly accessible

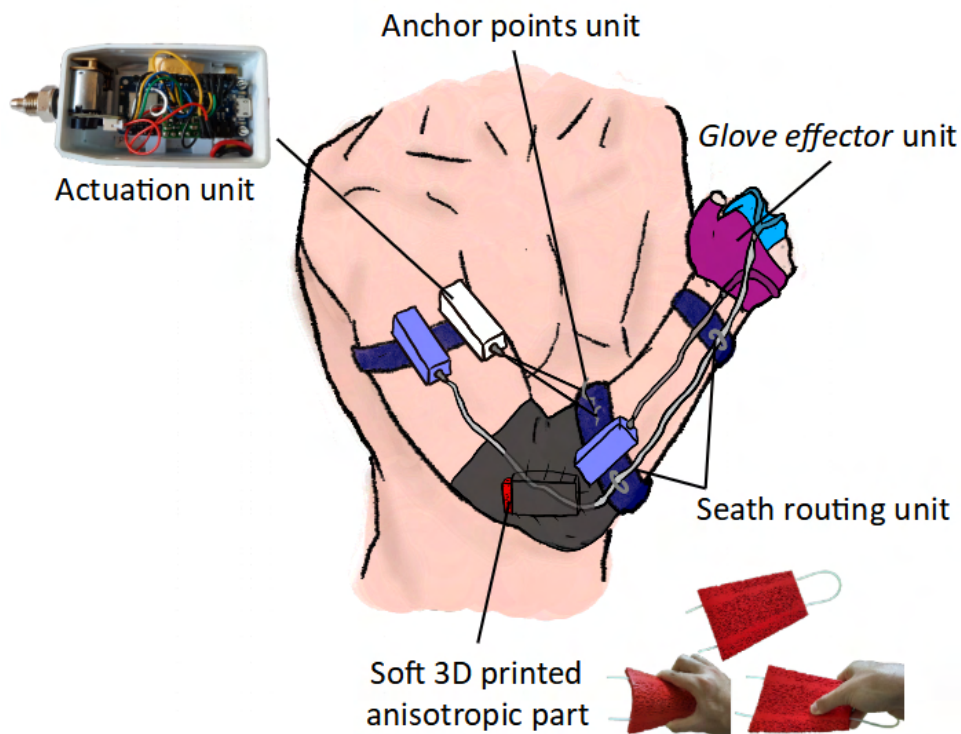

Figure 5.4: Sketch of a concept of modular assistive orthosis.

worldwide. In addition, customization is possible within a Fab lab/Humanlab to better fit a particular user's need. However, like industry and research, Humanlabs suffers from limitations. As with most systems based on open-source, Humanlabs rely on donations, and public funding plays a central role. In addition, only *simple* devices can be manufactured in Humanlabs, to be low cost and compatible with equipment available in Fab labs.

The Exofinger project displayed that a simple device can be sufficient to provide a functional gain. Nevertheless, solutions from Humanlabs face the challenge of insufficient public awareness. Establishing collaborations with clinics, rehabilitation centers, and healthcare professionals in general would enable awareness and, eventually, distribution of cost-effective and individualized solutions. Due to their medical expertise, health professionals could target individuals who would benefit from such devices.

5.1.3 Vision of a generic concept of (hybrid) modular assistive orthosis with soft materials

This section presents a concept combining explored and unexplored leads that we believe are promising. Its realisation might not be possible at the moment but could be in the near future. Figure 5.4 presents a sketch of such concept.

5.1.3.a Principle

This concept is based on the actuation unit of Exofinger. The idea is to size different modules following the same concept as the one of Exofinger in order to adapt its use for different movements. As previously developed, customization of assistive devices is crucial when it comes to impairments. That is why the concept herein is a modular

orthosis. A particular individual can choose which module to use depending on the impaired motions. For example if an individual is willing to get assistance for elbow flexion and thumb flexion, they would wear two devices, one for the thumb and one for the elbow.

The Exofinger project showed that a simple concept can lead to a) functional gain, b) lightweight so wearable orthosis, c) low cost and available device in Humanlabs, d) soft and jointless architecture, e) orthosis capable of locking in position without energy consumption due to an appropriately selected reduction ratio.

As for Exofinger, the actuation unit is ideally placed on a proximal part of the upper limb, while anchor points are located on the limb part. In order to manage the cables and limit the encumbrance in the case of elbow flexion for example, path guidance modules between the actuation and anchor points could be added. Thus, this concept of modular orthosis would feature four types of modules:

- actuation unit
- anchor points module for fixing cable to limb parts
- path guidance module for cable management
- coupling and/or guiding soft and anisotropic 3D-printed components (thereafter referred as soft guiding module)

While the first three modules could be placed on straps or braces, enabling a user with hand impairments to don the device autonomously, the soft guiding parts could be placed on sockets sewn on sleeves for example.

Actuation unit - The actuation unit considered is similar to the actuation unit of Exofinger being a simple concept that is easily scalable for different powers. It would include a DC motor with a high ratio reduction stage, coupled to a drum for cable winding and unwinding. The control board could be the same Adafruit board as it integrates BLE. The battery would come with a level shifter depending on the sizing of the actuator and the power needs.

A cable reel would be added to the actuation unit, along with a system based on a torsional spring, to some extent like a badge reel, in order to setup and adjust cable lengths to each user's need. On one hand, the setup requires the cable reel to be free from constraint, on the other hand the functioning requires the cable reel to be fixed, otherwise the actuation would just unwind the cable reel. A simple mechanism for locking and unlocking the cable reel would be considered. Boa technology ratchets seem to be a promising solution for its compatibility with Fab labs. Also, as shown in Figure 5.5, this technology has already been used in an orthosis [181].

As for the orthoses developed in this thesis, cables would not be attached to anchor points. Indeed, to avoid knots or crimps on moving parts that would concentrate constraints, making a loop is preferred. Thus, both ends of the cable would be in the actuation unit, one fixed to the drum and one to the cable reel. The challenge remains in the positioning of sheaths.

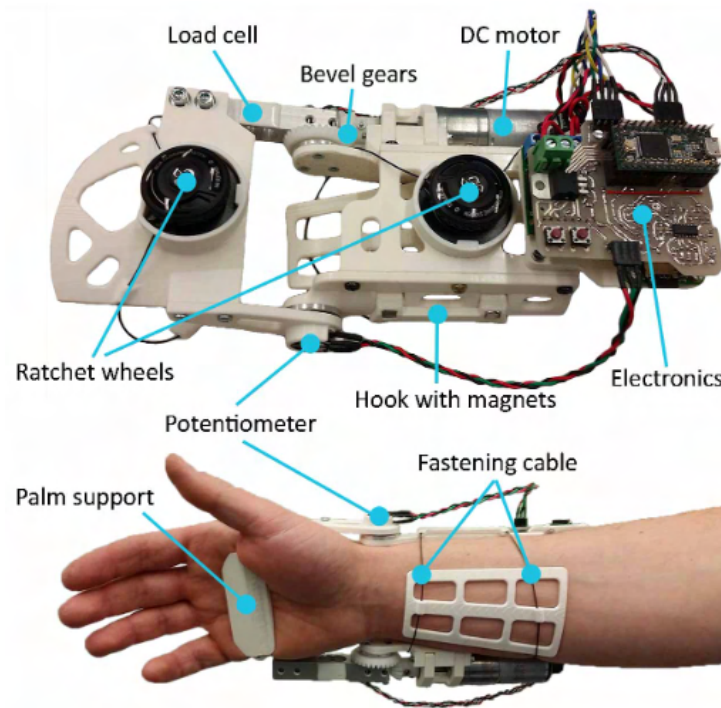

Figure 5.5: A flexion-extension orthosis using Boa technology ratchets. *source [182]*

Anchor points module - This module would be intended to be placed on the limb part that is to be moved. The anchor points module would simply consist of two snap hooks fixed on a strap. During the setup, the user would place the cable inside the snap hooks, as anchor points.

Path guidance module - This module would be intended to guide the pathway of cables along limb parts. This could be accomplished by little hooks. For example, in the case of assistance for elbow flexion, a path guidance module would be placed on the forearm near the elbow to limit encumbrance.

Soft guiding module - The soft anisotropic components previously presented in 5.1.1.c could be included as another module in this concept of modular orthosis. Those components could guide movements while limiting the encumbrance, weight and overall cost of the device. Also, as previously hypothesized, such anisotropic components could enable joint coupling. Nonetheless, it could be challenging to attach soft guiding modules on straps without compromising their motion guidance properties. Sockets sewn in sleeves could be an option.

5.1.3.b Hand particularity

Most of the upper limb's degrees of freedom are included in the hands. In addition, limiting the encumbrance on and near the hands is crucial. For these reasons, coupling the motion of the fingers' joints, or underactuation between fingers, should be considered. To couple the motions, straps, rings or glove-type fabric based components could be wisely placed and linked, in order to perform, for example, a power grasp with a single actuation unit.

5.1.3.c Actuation sizing and cable design through simulation and optimisation

Sizing of actuation modules - When considering customizing such a device for a particular user, a set of data could be collected including the weight and length of the limb parts. The sizing framework would involve simulation of the limb and the orthosis. To determine the optimal placement of modules and their sizing, an optimisation could be conducted on rigid bodies with, for example, Bioptim for BioRBD [183]. Then, the framework would select from a list the proper components including the actuator, driver, battery and cases. This approach would enable the modular orthosis to be adapted to each user's measurements and could even include children.

A hybrid option could be added enabling an undersized actuation unit, considering that FES will contribute to the motion. However, purchasing a stimulator considerably increases the cost. In addition, placing the electrodes is not an easy task and, at the moment, is likely to require the assistance of a third party. Current research has been done on an array of electrodes, including electrodes sewn into fabric [184, 185, 186]. Such technologies could facilitate the autonomous use of FES.

Cable management - In this thesis, cable management has not been discussed. Indeed, only single cables were considered. The research community is putting effort into finding an optimal set of anchor points and cables, as shown in Figure 5.6. Also, more intricate cable configurations could be explored. In the idea shown in Figure 5.7, thin McKibben pneumatic actuators are *woven* [63]. Such optimisation could be made for the concept of modular orthoses. Simulation and optimisation could be done within the Sofa framework [187].

5.1.3.d Control of such modular orthosis

This modular orthosis can be composed of an undetermined number of actuation units, assisting multiple upper limb motions. Henceforth, the control of such an orthosis can be complex, especially considering that users are likely to have only a few volitional controls.

For an intuitive control, higher level controls could be explored. This control method is currently being developed for soft robots with reinforcement learning [189].

Since every actuation unit includes a control board with integrated BLE, one of them, or a dedicated one, could include the interface and manage all units.

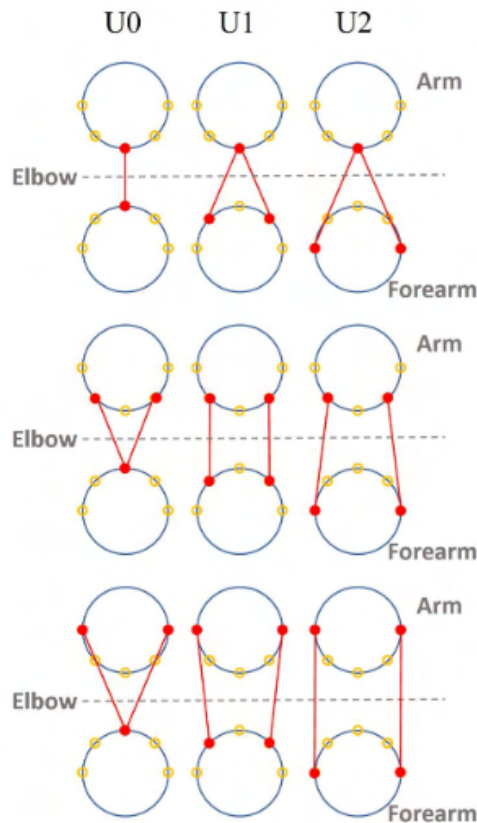

Figure 5.6: Different configurations of cables and anchor points for assisting in elbow flexion. *source [188]*

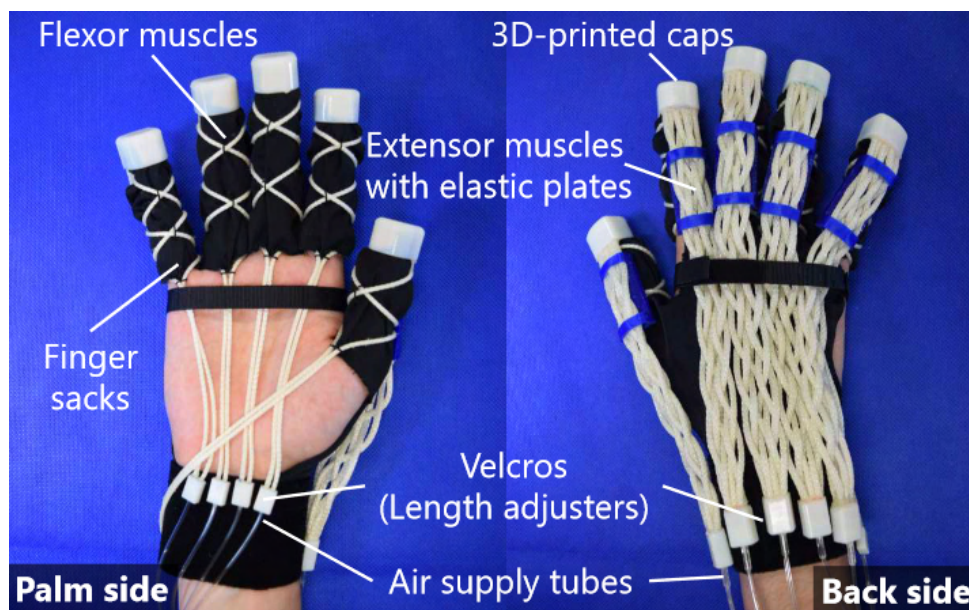

Figure 5.7: Intricate *weaving* of McKibben actuators in a hand orthosis. *source [63]*

5.2 Conclusion

This thesis explored various solutions aimed at restoring grasping functions for individuals with upper limb paralysis, especially tetraplegia, through assistive orthoses. The objective is to improve the quality of life of these individuals through assisting the recovering of some autonomy. Different approaches were proposed, including concepts, designs, and targeted functions.

One approach consisted of designing a low cost orthosis for key-grip assistance. This work was initiated in the context of Humanlabs, where the device was dedicated to a specific need of a particular user. We hypothesized that such device with a simple concept with mass relocation due to a cable, could prove to be useful for a broader population. An experimental protocol was designed. As end-users provide the most useful feedback on the usability and functionality of a prototype, the experimental protocol was conducted with individuals with various impairments resulting in hand paralysis. The usability and the potential functional gain were assessed through functional tasks, with and without the device, and different feedback including the [SUS](#) questionnaire and open discussions.

Outcomes are promising and show that this approach can lead to interesting research. In light of the observation of a real demand from individuals with hand impairments the development of the Exofinger device was pursued. Its accessibility through Humanlabs enables its use for a wide scope of users.

Another approach focused on power grasp assistance which requires more actuation. In order to reduce weight and encumbrance of this actuation, a hybrid orthosis was developed. It uses [FES](#) to extract benefit from biological actuators. The goal was to determine whether a hybrid orthosis, using [FES](#) along with [DC](#) motors, could improve the gesture by guiding the movement and reduce the fatigue induced by [FES](#) via joint locking.

A controller was developed to coordinate the electrical stimulator and the mechanical orthosis. Experimental protocols were designed to validate the functioning of the hybrid orthosis and verify the hypothesis. A pilot study, conducted with an individual with tetraplegia, validated the designed protocol and encourage us to move to clinical trials. They will include assessment of functional tasks, with and without the device, and collection of feedback through the use of the [SUS](#) and [QUEST](#) questionnaires and open discussion.

Finally, a third approach aiming at improving grasping function focused on prono-supination assistance. Indeed, grasping functions are not limited to hand movements as proper positioning and orientation of the hand are crucial to achieve [ADLs](#). Experiments conducted in the context of this thesis highlighted the importance of pronation and supination in hand movements, especially for individuals with grip impairments who use it in compensatory strategies.

A spherical mechanism was considered in a prono-supination assistive orthosis. Through an optimization, a four-bar spherical mechanism was developed. By combining three such mechanisms, the device is capable of producing an 80° rotation. Stacking two devices results in a 160° rotation. This range of motion is sufficient

to perform every [ADLs](#) which is promising for considering this mechanism for an assistive orthosis.

Table [5.1](#) summarizes the contributions of this thesis.

In the coming years, we suggest exploring the possibility of designing modular orthoses in order to meet the need of a variety of users with impairments. A generic concept is likely to improve the accessibility of assistive orthoses for people with upper limb paralysis.

Contributions	Section
Simple concept of hand assistive orthosis can lead to acceptance and functional gain	
Design and fabrication of an open-source and low cost orthosis for key-grip assistance: EXOFINGER	2.4
Development of the controller of the orthosis and the push button	2.4
Design of an experimental protocol	2.5
Experimental protocol with 9 participants with hand impairments and data processing	2.6
Hybrid concept of hand and wrist assistive orthosis	
Design and implementation of a hybrid orthosis embedding mechanical and FES assistance: GRASPHYB	3.2
Development of the controller for the hybrid orthosis handling events and managing parameters through a GUI	3.2
Design of an experimental protocol for validating the functioning	3.3
Experimental protocol with 4 participants and data processing	3.3
Design of an experimental protocol to assess the impact of a hybrid orthosis on gesture quality and muscle fatigue	3.4
Pilot study with a participant with an SCI and data processing	3.4
Cable-driven orthoses with two concepts with different approach	
Validation of joint locking through high-ratio reduction stage	2.4 & 3.1
Validation of mass relocation of actuators thanks to cable transmission	2.4 & 3.1
Spherical mechanism for assistance of prono-supination	
Design of a four-bar spherical mechanism able to follow the trajectory of a latitude on the surface of a sphere	4.2.1
Design of a device composed of three spherical mechanisms performing a rotation of 80°	4.2.2
Compatibility of this device for a prono-supination assistive orthosis for ADLs completion	4.3.1
Manufacture of initial prototype	4.3.2

Table 5.1: Summary of the contributions of this thesis.

List of publications

Trotobas C, Azevedo C, Murray AP. Design of (Hybrid) Assistive Orthoses for Upper Limbs, Application to Tetraplegia. In Lyon Cyber Days 2021.

Trotobas C, M.R.M. Ferreira F, Resende HM, Murray AP, Azevedo C. Development of a hybrid orthosis solution to reduce fatigue during grasping. In Rehabweek 2022, IFESS. Available from : <https://inria.hal.science/hal-03666816>

Trotobas C, Azevedo C, Murray AP. The Kinematic Synthesis of a Spherical Mechanism for Assisting in Wrist Pronation and Supination. IDETC-CIE 2023 International Design Engineering Technical Conferences & Computers and Information in Engineering Conference

M.R.M. Ferreira F, O. Fonseca L, Le Guillou R, Trotobas C, Fattal C, Gasq D, et al. User Requirements for Upper Limb Hybrid Motor Neuroprosthesis. In Rehabweek 2023, IFESS.

Trotobas C, Azevedo C, Murray AP. An Informal Survey of Upper-Limb Exoskeletons, Orthotics and Prosthetics featured in the ASME Journal of Mechanisms and Robotics. LinkedIn Journal of Mechanisms and Robotics. In 2022. Available from : <https://lnkd.in/dBCbYxAH>

Bibliography

- [1] Ahuja CS, Wilson JR, Nori S, Kotter MRN, Druschel C, Curt A, et al. Traumatic spinal cord injury. *Nature Reviews Disease Primers*. 2017 Apr;3(1):1-21. Number: 1 Publisher: Nature Publishing Group. Available from: <https://www.nature.com/articles/nrdp201718>. 25, 31
- [2] Keci A, Tani K, Xhema J. Role of Rehabilitation in Neural Plasticity. *Open Access Macedonian Journal of Medical Sciences*. 2019 May;7(9):1540-7. Available from: <https://www.ncbi.nlm.nih.gov/pmc/articles/PMC6542405/>. 25
- [3] Javeed S, Greenberg JK, Zhang J, Dibble C, Khalifeh JM, Wilson TJ, et al. 146 Functional Priorities in High Cervical Spinal Cord Injury: Implications for Upper Limb Nerve Transfer Surgery. *Neurosurgery*. 2023 Apr;69(Supplement_1):38. Available from: https://journals.lww.com/neurosurgery/Abstract/2023/04001/146_Functional_Priorities_in_High_Cervical_Spinal.57.aspx. 25, 32
- [4] Dengler J, Mehra M, Steeves JD, Department of Defense (DOD) Group, European Multicenter Study of Spinal Cord Injury (EMSCI) Group, Fox IK. Evaluation of Functional Independence in Cervical Spinal Cord Injury: Implications for Surgery to Restore Upper Limb Function. *The Journal of Hand Surgery*. 2021 Jul;46(7):621.e1-621.e17. 25
- [5] Dunn JA, Sinnott KA, Rothwell AG, Mohammed KD, Simcock JW. Tendon Transfer Surgery for People With Tetraplegia: An Overview. *Archives of Physical Medicine and Rehabilitation*. 2016 Jun;97(6):S75-80. Available from: <https://linkinghub.elsevier.com/retrieve/pii/S0003999316001878>. 25, 32, 33
- [6] Krasuski M, Kiwerski J. An analysis of the results of transferring the musculocutaneous nerve onto the median nerve in tetraplegics. *Archives of Orthopaedic and Trauma Surgery*. 1991 Dec;111(1):32-3. Available from: <http://link.springer.com/10.1007/BF00390190>. 25
- [7] Bazarek S, Brown JM. The evolution of nerve transfers for spinal cord injury. *Experimental Neurology*. 2020 Nov;333:113426. Available from: <https://linkinghub.elsevier.com/retrieve/pii/S0014488620302570>. 25, 33

- [8] Zyl Nv, Hill B, Cooper C, Hahn J, Galea MP. Expanding traditional tendon-based techniques with nerve transfers for the restoration of upper limb function in tetraplegia: a prospective case series. *The Lancet*. 2019 Aug;394(10198):565-75. Publisher: Elsevier. Available from: [https://www.thelancet.com/journals/lancet/article/PIIS0140-6736\(19\)31143-2/fulltext?utm_campaign=lancet&utm_source=youtube&utm_medium=social](https://www.thelancet.com/journals/lancet/article/PIIS0140-6736(19)31143-2/fulltext?utm_campaign=lancet&utm_source=youtube&utm_medium=social). 25, 33
- [9] Khalifeh JM, Dibble CF, Voorhis AV, Doering M, Boyer MI, Mahan MA, et al. Nerve transfers in the upper extremity following cervical spinal cord injury. Part 1: Systematic review of the literature. *Journal of Neurosurgery: Spine*. 2019 Jul;31(5):629-40. Publisher: American Association of Neurological Surgeons Section: Journal of Neurosurgery: Spine. Available from: <https://thejns.org/spine/view/journals/j-neurosurg-spine/31/5/article-p629.xml>. 25, 33
- [10] Khalifeh JM, Dibble CF, Voorhis AV, Doering M, Boyer MI, Mahan MA, et al. Nerve transfers in the upper extremity following cervical spinal cord injury. Part 2: Preliminary results of a prospective clinical trial. *Journal of Neurosurgery: Spine*. 2019 Jul;31(5):641-53. Publisher: American Association of Neurological Surgeons Section: Journal of Neurosurgery: Spine. Available from: <https://thejns.org/spine/view/journals/j-neurosurg-spine/31/5/article-p641.xml>. 25, 33
- [11] Losanno E, Mender M, Chestek C, Shokur S, Micera S. Neurotechnologies to restore hand functions. *Nature Reviews Bioengineering*. 2023 Apr:1-18. Publisher: Nature Publishing Group. Available from: <https://www.nature.com/articles/s44222-023-00054-4>. 25, 28, 29, 39, 40, 69
- [12] DiPasquale-Lehnerz P. Orthotic Intervention for Development of Hand Function With C-6 Quadriplegia. *The American Journal of Occupational Therapy*. 1994 Feb;48(2):138-44. Available from: <https://doi.org/10.5014/ajot.48.2.138>. 25, 34, 37
- [13] Dunning AG, Herder JL. A review of assistive devices for arm balancing. In: 2013 IEEE 13th International Conference on Rehabilitation Robotics (ICORR); 2013. p. 1-6. ISSN: 1945-7901. 25
- [14] Bos RA, Haarman CJW, Stortelder T, Nizamis K, Herder JL, Stienen AHA, et al. A structured overview of trends and technologies used in dynamic hand orthoses. *Journal of NeuroEngineering and Rehabilitation*. 2016 Jun;13(1):62. Available from: <https://doi.org/10.1186/s12984-016-0168-z>. 25, 35, 102
- [15] Kapsalyamov A, Hussain S, Jamwal PK. State-of-the-Art Assistive Powered Upper Limb Exoskeletons for Elderly. *IEEE Access*. 2020;8:178991-9001. Conference Name: IEEE Access. 25
- [16] Rosenbaum DA. *Human Motor Control*. Academic Press; 2009. Google-Books-ID: MsFmds_ACBwC. 26
- [17] Pfaff DW, Volkow ND, Rubenstein JL. *Neuroscience in the 21st Century: From Basic to Clinical*. Springer Nature; 2022. Google-Books-ID: TfeVEAAQBAJ. 26

- [18] Leal-Naranjo JA, Ceccarelli M, Torres-San Miguel CR. Mechanical Design of a Prosthetic Human Arm and its Dynamic Simulation. In: Rodić A, Borangiu T, editors. *Advances in Robot Design and Intelligent Control*. vol. 540. Cham: Springer International Publishing; 2017. p. 482-90. Series Title: *Advances in Intelligent Systems and Computing*. Available from: http://link.springer.com/10.1007/978-3-319-49058-8_52. 27
- [19] Maw J, Wong KY, Gillespie P. Hand anatomy. *British Journal of Hospital Medicine*. 2016 Mar;77(3):C34-40. Available from: <http://www.magonlinelibrary.com/doi/10.12968/hmed.2016.77.3.C34>. 27, 28
- [20] Miniato MA, Anand P, Varacallo M. Anatomy, Shoulder and Upper Limb, Shoulder. In: *StatPearls*. Treasure Island (FL): StatPearls Publishing; 2023. Available from: <http://www.ncbi.nlm.nih.gov/books/NBK536933/>. 27
- [21] Wong M, Kiel J. Anatomy, Shoulder and Upper Limb, Acromioclavicular Joint. In: *StatPearls*. Treasure Island (FL): StatPearls Publishing; 2023. Available from: <http://www.ncbi.nlm.nih.gov/books/NBK499858/>. 27
- [22] Leijnse JNAL, Quesada PM, Spoor CW. Kinematic evaluation of the finger's interphalangeal joints coupling mechanism—variability, flexion–extension differences, triggers, locking swanneck deformities, anthropometric correlations. *Journal of Biomechanics*. 2010 Aug;43(12):2381-93. Available from: <https://www.sciencedirect.com/science/article/pii/S0021929010002332>. 27
- [23] Laitenberger M, Raison M, Périé D, Begon M. Refinement of the upper limb joint kinematics and dynamics using a subject-specific closed-loop forearm model. *Multibody System Dynamics*. 2015 Apr;33(4):413-38. Available from: <http://link.springer.com/10.1007/s11044-014-9421-z>. 27, 98
- [24] Pennestrì E, Stefanelli R, Valentini PP, Vita L. Virtual musculo-skeletal model for the biomechanical analysis of the upper limb. *Journal of Biomechanics*. 2007 Jan;40(6):1350-61. Available from: <http://www.sciencedirect.com/science/article/pii/S0021929006001679>. 27, 98
- [25] Gustus A, Stillfried G, Visser J, Jörntell H, Van Der Smagt P. Human hand modelling: kinematics, dynamics, applications. *Biological Cybernetics*. 2012 Dec;106(11-12):741-55. Available from: <http://link.springer.com/10.1007/s00422-012-0532-4>. 27
- [26] Vergara M, Sancho-Bru JL, Gracia-Ibáñez V, Pérez-González A. An introductory study of common grasps used by adults during performance of activities of daily living. *Journal of Hand Therapy*. 2014 Jul;27(3):225-34. Publisher: Elsevier. Available from: [https://www.jhandtherapy.org/article/S0894-1130\(14\)00052-0/fulltext](https://www.jhandtherapy.org/article/S0894-1130(14)00052-0/fulltext). 28, 29
- [27] Kapandji AI. La Préhension dans la Main Humaine. *Annales de Chirurgie de la Main*. 1989 Jan;8(3):234-41. Available from: <https://www.sciencedirect.com/science/article/pii/S0753905389800602>. 29
- [28] Feix T, Romero J, Schmiedmayer HB, Dollar AM, Kragic D. The GRASP Taxonomy of Human Grasp Types. *IEEE Transactions on Human-Machine Systems*.

- 2016 Feb;46(1):66-77. Conference Name: IEEE Transactions on Human-Machine Systems. 29
- [29] Bullock IM, Zheng JZ, De La Rosa S, Guertler C, Dollar AM. Grasp Frequency and Usage in Daily Household and Machine Shop Tasks. *IEEE Transactions on Haptics*. 2013 Jul;6(3):296-308. Conference Name: IEEE Transactions on Haptics. 29
- [30] Sollerman C, Ejeskär A. Sollerman Hand Function Test: A Standardised Method and its Use in Tetraplegic Patients. *Scandinavian Journal of Plastic and Reconstructive Surgery and Hand Surgery*. 1995 Jan;29(2):167-76. Available from: <http://www.tandfonline.com/doi/full/10.3109/02844319509034334>. 29, 54
- [31] Bain GI, Polites N, Higgs BG, Heptinstall RJ, McGrath AM. The functional range of motion of the finger joints. *Journal of Hand Surgery (European Volume)*. 2015 May;40(4):406-11. Available from: <http://journals.sagepub.com/doi/10.1177/1753193414533754>. 29
- [32] Hayashi H, Shimizu H. Essential motion of metacarpophalangeal joints during activities of daily living. *Journal of Hand Therapy: Official Journal of the American Society of Hand Therapists*. 2013;26(1):69-73; quiz 74. 29
- [33] Liu M, Xiong C. Synergistic Characteristic of Human Hand during Grasping Tasks in Daily Life. In: Zhang X, Liu H, Chen Z, Wang N, editors. *Intelligent Robotics and Applications. Lecture Notes in Computer Science*. Cham: Springer International Publishing; 2014. p. 67-76. 29
- [34] Smaby N, Johanson ME, Baker B, Kenney DE, Murray WM, Hentz VR. Identification of key pinch forces required to complete functional tasks. *The Journal of Rehabilitation Research and Development*. 2004;41(2):215. Available from: <http://www.rehab.research.va.gov/jour/04/41/2/smaby.html>. 29, 40
- [35] World Health Organization Regional Office for Europe. Global atlas on cardiovascular disease prevention and control: published by the World Health Organization in collaboration with the World Heart Federation and the World Stroke Organization. World Health Organization. Regional Office for Europe; 2011. Available from: <https://apps.who.int/iris/handle/10665/329516>. 30
- [36] Tashiro S, Kuroki M, Okuyama K, Oshima O, Ogura M, Hijikata N, et al. Factors related to daily use of the paretic upper limb in patients with chronic hemiparetic stroke—A retrospective cross-sectional study. *PLOS ONE*. 2021 Mar;16(3):e0247998. Publisher: Public Library of Science. Available from: <https://journals.plos.org/plosone/article?id=10.1371/journal.pone.0247998>. 30
- [37] Michielsen ME, Selles RW, Stam HJ, Ribbers GM, Bussmann JB. Quantifying nonuse in chronic stroke patients: a study into paretic, nonparetic, and bimanual upper-limb use in daily life. *Archives of Physical Medicine and Rehabilitation*. 2012 Nov;93(11):1975-81. 30
- [38] Wyndaele M, Wyndaele JJ. Incidence, prevalence and epidemiology of spinal cord injury: what learns a worldwide literature survey? *Spinal Cord*. 2006 Sep;44(9):523-9. Available from: <http://www.nature.com/articles/3101893>. 30

- [39] Dobkin BH, Havton LA. Basic Advances and New Avenues in Therapy of Spinal Cord Injury. *Annual review of medicine*. 2004;55:255-82. Available from: <https://www.ncbi.nlm.nih.gov/pmc/articles/PMC4164205/>. 30
- [40] Maynard FM, Bracken MB, Creasey G, Ditunno JF, Donovan WH, Ducker B, et al. International Standards for Neurological and Functional Classification of Spinal Cord Injury. 30
- [41] Donovan WH. Spinal Cord Injury-Past, Present, and Future. *The Journal of Spinal Cord Medicine*. 2007 Jan;30(2):85-100. Available from: <https://www.tandfonline.com/doi/full/10.1080/10790268.2007.11753918>. 32
- [42] Anderson KD. Targeting Recovery: Priorities of the Spinal Cord-Injured Population. *Journal of Neurotrauma*. 2004 Oct;21(10):1371-83. Available from: <http://www.liebertpub.com/doi/10.1089/neu.2004.21.1371>. 32, 33
- [43] Silva NA, Sousa N, Reis RL, Salgado AJ. From basics to clinical: A comprehensive review on spinal cord injury. *Progress in Neurobiology*. 2014 Mar;114:25-57. Available from: <https://www.sciencedirect.com/science/article/pii/S0301008213001196>. 32
- [44] Burns AS, Ditunno JF. Establishing Prognosis and Maximizing Functional Outcomes After Spinal Cord Injury: A Review of Current and Future Directions in Rehabilitation Management. *Spine*. 2001 Dec;26(Supplement):S137-45. Available from: <http://journals.lww.com/00007632-200112151-00023>. 32
- [45] Waters RL, Adkins RH, Yakura JS, Sie I. Motor and sensory recovery following complete tetraplegia. *Archives of Physical Medicine and Rehabilitation*. 1993 Mar;74(3):242-7. Publisher: Elsevier. Available from: [https://www.archives-pmr.org/article/0003-9993\(93\)90131-S/fulltext](https://www.archives-pmr.org/article/0003-9993(93)90131-S/fulltext). 32
- [46] Bryden A, Sinnott A, Mulcahey MJ. Innovative Strategies for Improving Upper Extremity Function in Tetraplegia and Considerations in Measuring Functional Outcomes. *Topics in Spinal Cord Injury Rehabilitation*. 2005 Apr;10(4):75-93. Available from: <https://meridian.allenpress.com/tscir/article/doi/10.1310/LN94-NMVK-59V3-CC1F>. 32
- [47] Hanson RW, Franklin MR. Sexual loss in relation to other functional losses for spinal cord injured males. *Archives of Physical Medicine and Rehabilitation*. 1976 Jun;57(6):291-3. 33
- [48] Estores IM. The consumers perspective and the professional literature: What do persons with spinal cord injury want? *The Journal of Rehabilitation Research and Development*. 2003;40(4s):93. Available from: <http://www.rehab.research.va.gov/jour/03/40/4/sup/pdf/Estores.pdf>. 33
- [49] Pylatiuk C, Kargov A, Schulz S, Döderlein L. Distribution of grip force in three different functional prehension patterns. *Journal of Medical Engineering & Technology*. 2006 May;30(3):176-82. Publisher: Taylor & Francis Ltd. Available from: <https://search.ebscohost.com/login.aspx?direct=true&db=aph&AN=21143906&lang=fr&site=ehost-live&scope=site>. 33

- [50] Dimitrijevic MR. Restorative Neurology of Spinal Cord Injury. Oxford University Press, USA; 2012. Google-Books-ID: v17YJZjF0CgC. 33
- [51] Johanson ME, Murray WM. The unoperated hand: the role of passive forces in hand function after tetraplegia. *Hand Clinics*. 2002 Aug;18(3):391-8. Available from: <https://www.sciencedirect.com/science/article/pii/S0749071202000355>. 33
- [52] Organization WH, UNICEF. Global Report on Assistive Technology. 34, 37, 42
- [53] Kuiken TA, Dumanian GA, Lipschutz RD, Miller LA, Stubblefield KA. The use of targeted muscle reinnervation for improved myoelectric prosthesis control in a bilateral shoulder disarticulation amputee. *Prosthetics and Orthotics International*. 2004 Dec;28(3):245-53. Publisher: SAGE Publications Ltd STM. Available from: <https://journals.sagepub.com/doi/abs/10.3109/03093640409167756>. 34
- [54] Trotobas C, Azevedo C, Murray A. An Informal Survey of Upper-Limb Exoskeletons, Orthotics and Prosthetics featured in the ASME Journal of Mechanisms and Robotics. *LinkedIn Journal of Mechanisms and Robotics*. 35
- [55] Susanto EA, Tong RK, Ockenfeld C, Ho NS. Efficacy of robot-assisted fingers training in chronic stroke survivors: a pilot randomized-controlled trial. *Journal of NeuroEngineering and Rehabilitation*. 2015 Apr;12(1):42. Available from: <https://doi.org/10.1186/s12984-015-0033-5>. 35, 54
- [56] Bartlett NW, Lyau V, Raiford WA, Holland D, Gafford JB, Ellis TD, et al. A Soft Robotic Orthosis for Wrist Rehabilitation1. *Journal of Medical Devices*. 2015 Sep;9(3):030918. Available from: <https://asmedigitalcollection.asme.org/medicaldevices/article/doi/10.1115/1.4030554/448058/A-Soft-Robotic-Orthosis-for-Wrist-Rehabilitation1>. 35, 100, 101
- [57] HandTutor device user guide - En - v1.pdf;. 35
- [58] Park S, Fraser M, Weber LM, Meeker C, Bishop L, Geller D, et al. User-Driven Functional Movement Training with a Wearable Hand Robot after Stroke. *IEEE Transactions on Neural Systems and Rehabilitation Engineering*. 2020:1-1. Available from: <https://ieeexplore.ieee.org/document/9186719/>. 35, 36
- [59] Wang J, Liu Z, Fei Y. Design and Testing of a Soft Rehabilitation Glove Integrating Finger and Wrist Function. *Journal of Mechanisms and Robotics*. 2019 Feb;11(1):011015. Available from: <https://asmedigitalcollection.asme.org/mechanismsrobotics/article/doi/10.1115/1.4041789/401370/Design-and-Testing-of-a-Soft-Rehabilitation-Glove>. 35
- [60] Lenzo B, Fontana M, Marcheschi S, Salsedo F, Frisoli A, Bergamasco M. Trackhold: A Novel Passive Arm-Support Device. *Journal of Mechanisms and Robotics*. 2016 Apr;8(2):021007. Available from: <https://asmedigitalcollection.asme.org/mechanismsrobotics/article/doi/10.1115/1.4031716/473050/Trackhold-A-Novel-Passive-ArmSupport-Device>. 35, 121

- [61] Aubin PM, Sallum H, Walsh C, Stirling L, Correia A. A pediatric robotic thumb exoskeleton for at-home rehabilitation: The Isolated Orthosis for Thumb Actuation (IOTA). In: 2013 IEEE 13th International Conference on Rehabilitation Robotics (ICORR); 2013. p. 1-6. ISSN: 1945-7901. [35](#)
- [62] Gasser BW, Martínez A, Sasso-Lance E, Kandilakis C, Durrough CM, Goldfarb M. Preliminary Assessment of a Hand and Arm Exoskeleton for Enabling Bimanual Tasks for Individuals With Hemiparesis. *IEEE Transactions on Neural Systems and Rehabilitation Engineering*. 2020 Oct;28(10):2214-23. Conference Name: IEEE Transactions on Neural Systems and Rehabilitation Engineering. [35](#), [36](#), [99](#)
- [63] Koizumi S, Chang TH, Nabae H, Endo G, Suzumori K, Mita M, et al. Soft Robotic Gloves with Thin McKibben Muscles for Hand Assist and Rehabilitation. In: 2020 IEEE/SICE International Symposium on System Integration (SII); 2020. p. 93-8. ISSN: 2474-2325. [35](#), [36](#), [69](#), [129](#), [130](#)
- [64] Realmuto J, Sanger T. A robotic forearm orthosis using soft fabric-based helical actuators. In: 2019 2nd IEEE International Conference on Soft Robotics (RoboSoft); 2019. p. 591-6. [35](#), [36](#), [100](#), [101](#)
- [65] Li M, Zhuo Y, He B, Liang Z, Xu G, Xie J, et al. A 3D-printed soft hand exoskeleton with finger abduction assistance. In: 2019 16th International Conference on Ubiquitous Robots (UR). Jeju, Korea (South): IEEE; 2019. p. 319-22. Available from: <https://ieeexplore.ieee.org/document/8768611/>. [35](#)
- [66] Yun SS, Kang BB, Cho KJ. Exo-Glove PM: An Easily Customizable Modularized Pneumatic Assistive Glove. *IEEE Robotics and Automation Letters*. 2017 Jul;2(3):1725-32. Available from: <http://ieeexplore.ieee.org/document/7872427/>. [35](#), [41](#)
- [67] Yap HK, Lim JH, Nasrallah F, Yeow CH. Design and Preliminary Feasibility Study of a Soft Robotic Glove for Hand Function Assistance in Stroke Survivors. *Frontiers in Neuroscience*. 2017;11. Publisher: Frontiers. Available from: <https://www.frontiersin.org/articles/10.3389/fnins.2017.00547/full>. [35](#), [36](#)
- [68] Refour EM, Sebastian B, Chauhan RJ, Ben-Tzvi P. A General Purpose Robotic Hand Exoskeleton With Series Elastic Actuation. *Journal of Mechanisms and Robotics*. 2019 Dec;11(6):060902. Available from: <https://asmedigitalcollection.asme.org/mechanismsrobotics/article/doi/10.1115/1.4044543/958406/A-General-Purpose-Robotic-Hand-Exoskeleton-With>. [35](#), [36](#)
- [69] Refour E, Sebastian B, Ben-Tzvi P. Two-Digit Robotic Exoskeleton Glove Mechanism: Design and Integration. *Journal of Mechanisms and Robotics*. 2018 Apr;10(2):025002. Available from: <https://asmedigitalcollection.asme.org/mechanismsrobotics/article/doi/10.1115/1.4038775/369800/TwoDigit-Robotic-Exoskeleton-Glove-Mechanism>. [35](#), [100](#)
- [70] Lee SW, Landers KA, Park HS. Development of a Biomimetic Hand Exotendon Device (BiomHED) for Restoration of Functional Hand Movement Post-Stroke. *IEEE Transactions on Neural Systems and Rehabilitation Engineering*.

- 2014 Jul;22(4):886-98. Conference Name: IEEE Transactions on Neural Systems and Rehabilitation Engineering. 35
- [71] In H, Cho KJ, Kim K, Lee B. Jointless structure and under-actuation mechanism for compact hand exoskeleton. In: 2011 IEEE International Conference on Rehabilitation Robotics; 2011. p. 1-6. ISSN: 1945-7901. 35, 36
- [72] Kang BB, Choi H, Lee H, Cho KJ. Exo-Glove Poly II: A Polymer-Based Soft Wearable Robot for the Hand with a Tendon-Driven Actuation System. *Soft Robotics*. 2019 Apr;6(2):214-27. Available from: <https://www.liebertpub.com/doi/10.1089/soro.2018.0006>. 35, 36
- [73] Randazzo L, Iturrate I, Perdakis S, Millan JdR. mano: A Wearable Hand Exoskeleton for Activities of Daily Living and Neurorehabilitation. *IEEE Robotics and Automation Letters*. 2018 Jan;3(1):500-7. Available from: <http://ieeexplore.ieee.org/document/8100925/>. 35, 36
- [74] Vanteddu T, Ben-Tzvi P. Stable Grasp Control With a Robotic Exoskeleton Glove. *Journal of Mechanisms and Robotics*. 2020 Dec;12(6):061015. Available from: <https://asmedigitalcollection.asme.org/mechanismsrobotics/article/doi/10.1115/1.4047724/1085046/Stable-Grasp-Control-With-a-Robotic-Exoskeleton>. 35, 36
- [75] Dias EA, de Andrade R. Design of a Cable-driven Actuator for Pronation and Supination of the Forearm to Integrate an Active Arm Orthosis. In: Proceedings of 1st International Electronic Conference on Actuator Technology: Materials, Devices and Applications. Sciforum.net: MDPI; 2020. p. 8511. Available from: <http://sciforum.net/conference/IeCAT2020/paper/8511>. 35, 36, 100, 101
- [76] Yoo HJ, Lee S, Kim J, Park C, Lee B. Development of 3D-printed myoelectric hand orthosis for patients with spinal cord injury. *Journal of NeuroEngineering and Rehabilitation*. 2019 Dec;16(1):162. Available from: <https://doi.org/10.1186/s12984-019-0633-6>. 35, 36, 40, 43
- [77] Gerez L, Chen J, Liarokapis M. On the Development of Adaptive, Tendon-Driven, Wearable Exo-Gloves for Grasping Capabilities Enhancement. *IEEE Robotics and Automation Letters*. 2019 Apr;4(2):422-9. Available from: <https://ieeexplore.ieee.org/document/8601355/>. 35, 36
- [78] Meeker C, Park S, Bishop L, Stein J, Ciocarlie M. EMG pattern classification to control a hand orthosis for functional grasp assistance after stroke. In: 2017 International Conference on Rehabilitation Robotics (ICORR). London: IEEE; 2017. p. 1203-10. Available from: <https://ieeexplore.ieee.org/document/8009413/>. 35, 36
- [79] Chiaradia D, Xiloyannis M, Antuvan CW, Frisoli A, Masia L. Design and embedded control of a soft elbow exosuit. In: 2018 IEEE International Conference on Soft Robotics (RoboSoft); 2018. p. 565-71. 35, 36, 103
- [80] Conti R, Allotta B, Meli E, Ridolfi A. Development, design and validation of an assistive device for hand disabilities based on an innovative mechanism. *Robotica*. 2017 Apr;35(4):892-906. Available from: https://www.cambridge.org/core/product/identifier/S0263574715000879/type/journal_article. 35, 36

- [81] Ben-Tzvi P, Danoff J, Ma Z. The Design Evolution of a Sensing and Force-Feedback Exoskeleton Robotic Glove for Hand Rehabilitation Application. *Journal of Mechanisms and Robotics*. 2016 Oct;8(5):051019. Available from: <https://asmedigitalcollection.asme.org/mechanismsrobotics/article/doi/10.1115/1.4032270/384007/The-Design-Evolution-of-a-Sensing-and>. 35, 36
- [82] Hashida R, Matsuse H, Bekki M, Omoto M, Morimoto S, Hino T, et al. Evaluation of Motor-Assisted Gloves (SEM Glove) for Patients with Functional Finger Disorders: A Clinical Pilot Study. *The Kurume Medical Journal*. 2018 Jun;65(2):63-70. Available from: https://www.jstage.jst.go.jp/article/kurumemedj/65/2/65_MS652007/_article. 35, 36, 41
- [83] Esmaeili M, Gamage K, Tan E, Campolo D. Ergonomic considerations for anthropomorphic wrist exoskeletons: A simulation study on the effects of joint misalignment. In: 2011 IEEE/RSJ International Conference on Intelligent Robots and Systems; 2011. p. 4905-10. ISSN: 2153-0866. 35
- [84] Xu K, Zhao J, Qiu D, Wang Y. A Pilot Study of a Continuum Shoulder Exoskeleton for Anatomy Adaptive Assistancess. *Journal of Mechanisms and Robotics*. 2014 Nov;6(4):041011. Available from: <https://asmedigitalcollection.asme.org/mechanismsrobotics/article/doi/10.1115/1.4027760/377307/A-Pilot-Study-of-a-Continuum-Shoulder-Exoskeleton>. 36
- [85] Galiana I, Hammond FL, Howe RD, Popovic MB. Wearable soft robotic device for post-stroke shoulder rehabilitation: Identifying misalignments. In: 2012 IEEE/RSJ International Conference on Intelligent Robots and Systems; 2012. p. 317-22. ISSN: 2153-0866. 36
- [86] Awad MI, Hussain I, Ghosh S, Zweiri Y, Gan D. A Double-Layered Elbow Exoskeleton Interface With 3-PRR Planar Parallel Mechanism for Axis Self-Alignment. *Journal of Mechanisms and Robotics*. 2021 Feb;13(1):011016. Available from: <https://asmedigitalcollection.asme.org/mechanismsrobotics/article/doi/10.1115/1.4048428/1086983/A-Double-Layered-Elbow-Exoskeleton-Interface-With>. 36
- [87] Casas R, Sandison M, Chen T, Lum PS. Clinical Test of a Wearable, High DOF, Spring Powered Hand Exoskeleton (HandSOME II). *IEEE Transactions on Neural Systems and Rehabilitation Engineering*. 2021;29:1877-85. Conference Name: IEEE Transactions on Neural Systems and Rehabilitation Engineering. 36
- [88] Tan GR, Robson NP, Soh GS. Motion Generation of Passive Slider Multiloop Wearable Hand Devices. *Journal of Mechanisms and Robotics*. 2017 Aug;9(4):041011. Available from: <https://asmedigitalcollection.asme.org/mechanismsrobotics/article/doi/10.1115/1.4036611/473125/Motion-Generation-of-Passive-Slider-Multiloop>. 36
- [89] Saharan L, Wu L, Tadesse Y. Modeling and Simulation of Robotic Finger Powered by Nylon Artificial Muscles. *Journal of Mechanisms and Robotics*. 2019 Oct;12(014501). Available from: <https://doi.org/10.1115/1.4044740>. 36

- [90] Sutton L, Moein H, Rafiee A, Madden JDW, Menon C. Design of an assistive wrist orthosis using conductive nylon actuators. In: 2016 6th IEEE International Conference on Biomedical Robotics and Biomechatronics (BioRob); 2016. p. 1074-9. ISSN: 2155-1782. 36
- [91] Behboodi A, DeSantis C, Lubsen J, Lee SCK. A Mechanized Pediatric Elbow Joint Powered by a De-Based Artificial Skeletal Muscle*. In: 2020 42nd Annual International Conference of the IEEE Engineering in Medicine Biology Society (EMBC); 2020. p. 4930-5. ISSN: 2694-0604. 36
- [92] Portnova AA, Mukherjee G, Peters KM, Yamane A, Steele KM. Design of a 3D-printed, open-source wrist-driven orthosis for individuals with spinal cord injury. PLOS ONE. 2018 Feb;13(2):e0193106. Available from: <https://dx.plos.org/10.1371/journal.pone.0193106>. 36, 40, 41, 43, 54
- [93] Coste CA, William L, Fonseca L, Haiarrassary A, Andreu D, Geffrier A, et al. Activating effective functional hand movements in individuals with complete tetraplegia through neural stimulation. Scientific Reports. 2022 Oct;12(1):16189. Number: 1 Publisher: Nature Publishing Group. Available from: <https://www.nature.com/articles/s41598-022-19906-x>. 37, 71
- [94] Chae J, Kilgore K, Triolo R, Creasey G. Functional Neuromuscular Stimulation in Spinal Cord Injury. Physical Medicine and Rehabilitation Clinics of North America. 2000 Feb;11(1):209-26. Available from: <https://www.sciencedirect.com/science/article/pii/S1047965118301554>. 37
- [95] Kesar T, Binder-Macleod S. Effect of frequency and pulse duration on human muscle fatigue during repetitive electrical stimulation. Experimental Physiology. 2006;91(6):967-76. _eprint: <https://physoc.onlinelibrary.wiley.com/doi/pdf/10.1113/expphysiol.2006.033886>. Available from: <https://physoc.onlinelibrary.wiley.com/doi/abs/10.1113/expphysiol.2006.033886>. 37, 71
- [96] Bajd T, Munih M. Basic functional electrical stimulation (FES) of extremities: An engineer's view. Technology and Health Care. 2010 Jan;18(4-5):361-9. Publisher: IOS Press. Available from: <https://content.iospress.com/articles/technology-and-health-care/thc00588>. 37
- [97] Howlett OA, Lannin NA, Ada L, McKinstry C. Functional Electrical Stimulation Improves Activity After Stroke: A Systematic Review With Meta-Analysis. Archives of Physical Medicine and Rehabilitation. 2015 May;96(5):934-43. Available from: <https://linkinghub.elsevier.com/retrieve/pii/S0003999315000441>. 37
- [98] Brodwin M. Medical, Psychosocial and Vocational Aspects of Disability. 3; 2009. 40
- [99] An Improved Lateral Key-Pinch Grip Orthosis For Tetraplegics With Wrist Extension;. Available from: <https://www.resna.org/sites/default/files/legacy/conference/proceedings/2007/Practice/Other/King.html>. 40, 43

- [100] Curtin University. Exoskeleton Robotic Finger Orthosis - Biorobotics Research Lab; 2015. Available from: <https://www.youtube.com/watch?v=TFTN1020v7U>. 40
- [101] BioservoTechnologies. SEM™ Glove - what it is and how to use it; 2015. Available from: <https://www.youtube.com/watch?v=5GH4wtG1M2c>. 41
- [102] BioservoTechnologies. Ironhand Virtual Demonstration example; 2020. Available from: <https://www.youtube.com/watch?v=ecN4rNSgjPc>. 41
- [103] THE TECH | Tendo - For people, not symptoms | Sweden;. Available from: <https://www.tendoforpeople.se/tendo>. 41
- [104] Vasya Pupkin. , prosthetic servo hand.; 2018. Available from: <https://www.youtube.com/watch?v=BgNpE0LJN5g>. 42
- [105] com T. Prosthetic servo glove ver 0.1 by max09ru;. Available from: <https://www.thingiverse.com/thing:2799080>. 42
- [106] Shawn Mathiesen. Talon Ratchet Hand; 2019. Available from: <https://www.youtube.com/watch?v=4vWE3Bn5seU>. 42
- [107] com T. Talon Ratchet Hand by shawnmathiesen;. Available from: <https://www.thingiverse.com/thing:3910988>. 42
- [108] Sofie Woge, CEO and Founder, Tendo; 2018. Available from: https://www.youtube.com/watch?v=AkdQWOMN_mw. 43
- [109] Brooke J. SUS - A quick and dirty usability scale. 61, 86
- [110] Goldfarb M, Durfee WK. Design of a controlled-brake orthosis for FES-aided gait. *IEEE Transactions on Rehabilitation Engineering*. 1996 Mar;4(1):13-24. Available from: <http://ieeexplore.ieee.org/document/486053/>. 70
- [111] Kagaya H, Shimada Y, Sato K, Sato M, Iizuka K, Obinata G. An electrical knee lock system for functional electrical stimulation. *Archives of Physical Medicine and Rehabilitation*. 1996 Sep;77(9):870-3. Available from: <https://linkinghub.elsevier.com/retrieve/pii/S0003999396902725>. 70
- [112] del Ama AJ, Koutsou AD, Moreno JC, de-los Reyes A, Gil-Agudo n, Pons JL. Review of hybrid exoskeletons to restore gait following spinal cord injury. *The Journal of Rehabilitation Research and Development*. 2012;49(4):497. Available from: <http://www.rehab.research.va.gov/jour/2012/494/pdf/delama494.pdf>. 70
- [113] Rohm M, Schneiders M, Müller C, Kreiling A, Kaiser V, Müller-Putz GR, et al. Hybrid brain-computer interfaces and hybrid neuroprostheses for restoration of upper limb functions in individuals with high-level spinal cord injury. *Artificial Intelligence in Medicine*. 2013 Oct;59(2):133-42. Available from: <https://www.sciencedirect.com/science/article/pii/S0933365713001176>. 70
- [114] Ambrosini E, Gasperini G, Zajc J, Immick N, Augsten A, Rossini M, et al. A Robotic System with EMG-Triggered Functional Electrical Stimulation for Restoring Arm Functions in Stroke Survivors. *Neurorehabilitation and Neural Repair*. 2021 Apr;35(4):334-45. 70

- [115] Pedrocchi A, Ferrante S, Ambrosini E, Gandolla M, Casellato C, Schauer T, et al. MUNDUS project: MULTImodal Neuroprosthesis for daily Upper limb Support. *Journal of NeuroEngineering and Rehabilitation*. 2013 Jul;10(1):66. Available from: <https://doi.org/10.1186/1743-0003-10-66>. 70, 82, 87
- [116] Ferreira FMRM, Rúbio GdP, Dutra RMA, Petten AMVNV, Vimieiro CBS. Development of portable robotic orthosis and biomechanical validation in people with limited upper limb function after stroke. *Robotica*. 2022 Dec;40(12):4238-56. Publisher: Cambridge University Press. Available from: <https://www.cambridge.org/core/journals/robotica/article/abs/development-of-portable-robotic-orthosis-and-biomechanical-validation-in-people-52650751CBCC28AE5C1B4F43E0C1EEFB>. 70
- [117] Ferreira FMRM, Rúbio GdP, Fonseca LO, Fattal C, Petten AMVNV, Vimieiro CBS, et al. Effectiveness of hybrid robotic rehabilitation system on upper limb recovery of people with central injuries: a systematic review with meta-analysis. 2021 Jan. Available from: <https://inria.hal.science/hal-03130770>. 70
- [118] Leeb R, Gubler M, Tavella M, Miller H, Millan JdR. On the road to a neuroprosthetic hand: A novel hand grasp orthosis based on functional electrical stimulation. In: 2010 Annual International Conference of the IEEE Engineering in Medicine and Biology. Buenos Aires: IEEE; 2010. p. 146-9. Available from: <https://ieeexplore.ieee.org/document/5627412/>. 70, 71
- [119] Schill O, Wiegand R, Schmitz B, Matthies R, Eck U, Pylatiuk C, et al. OrthoJacket: an active FES-hybrid orthosis for the paralysed upper extremity. *Biomedizinische Technik/Biomedical Engineering*. 2011 Jan;56(1):35-44. Available from: <https://www.degruyter.com/view/j/bmte.2011.56.issue-1/bmt.2010.056/bmt.2010.056.xml>. 70
- [120] Hara Y, Ogawa S, Muraoka Y. Hybrid power-assisted functional electrical stimulation to improve hemiparetic upper-extremity function. *American Journal of Physical Medicine & Rehabilitation*. 2006 Dec;85(12):977-85. 71
- [121] Bajd T, Črt M, Munih M. Functional electrical stimulation with surface electrodes. *Journal of Automatic Control*. 2008;18(2):3-9. Available from: <https://doiserbia.nb.rs/Article.aspx?id=1450-99030802003B>. 71
- [122] Dunkelberger N, Scheerer EM, O'Malley MK. A review of methods for achieving upper limb movement following spinal cord injury through hybrid muscle stimulation and robotic assistance. *Experimental Neurology*. 2020 Jun;328:113274. Available from: <https://linkinghub.elsevier.com/retrieve/pii/S0014488620301059>. 71
- [123] Resquín F, Cuesta Gómez A, Gonzalez-Vargas J, Brunetti F, Torricelli D, Molina Rueda F, et al. Hybrid robotic systems for upper limb rehabilitation after stroke: A review. *Medical Engineering & Physics*. 2016 Nov;38(11):1279-88. Available from: <https://linkinghub.elsevier.com/retrieve/pii/S1350453316302016>. 71
- [124] Stewart AM, Pretty CG, Adams M, Chen X. Review of Upper Limb Hybrid Exoskeletons. *IFAC-PapersOnLine*. 2017 Jul;50(1):15169-78. Available from: <https://www.sciencedirect.com/science/article/pii/S2405896317330616>. 71

- [125] Andreu D, Sijobert B, Toussaint M, Fattal C, Azevedo-Coste C, Guiraud D. Wireless Electrical Stimulators and Sensors Network for Closed Loop Control in Rehabilitation. *Frontiers in Neuroscience*. 2020;14:117. 75
- [126] Guerra RS, Fonseca I, Pichel F, Restivo MT, Amaral TF. Hand length as an alternative measurement of height. *European Journal of Clinical Nutrition*. 2014 Feb;68(2):229-33. Number: 2 Publisher: Nature Publishing Group. Available from: <https://www.nature.com/articles/ejcn2013220>. 81
- [127] Pn P, Ja T, Sd K. Correlation between Hand Length and Various Anthropometric Parameters. 81
- [128] Boser QA, Dawson MR, Schofield JS, Dziwenko GY, Hebert JS. Defining the design requirements for an assistive powered hand exoskeleton: A pilot explorative interview study and case series. *Prosthetics & Orthotics International*. 2021 Apr;45(2):161-9. Available from: <https://journals.lww.com/10.1177/0309364620963943>. 83
- [129] Trotobas C, Ferreira F, Resende HM, Murray A, Coste CA. Development of a hybrid orthosis solution to reduce fatigue during grasping; 2022. Available from: <https://inria.hal.science/hal-03666816>. 86
- [130] Demers L, Weiss-Lambrou R, Ska B. The Quebec User Evaluation of Satisfaction with Assistive Technology (QUEST 20): An overview of recent progress. *Techll<>logy and Disability*. 2002 Jan;14. 86
- [131] Langley GB, Sheppard H. The visual analogue scale: its use in pain measurement. *Rheumatology International*. 1985;5(4):145-8. 86
- [132] Bohannon RW, Smith MB. Interrater reliability of a modified Ashworth scale of muscle spasticity. *Physical Therapy*. 1987 Feb;67(2):206-7. 94
- [133] Buckley MA, Yardley A, Johnson GR, Cams DA. Dynamics of the Upper Limb during Performance of the Tasks of Everyday Living—A Review of the Current Knowledge Base. *Proceedings of the Institution of Mechanical Engineers, Part H: Journal of Engineering in Medicine*. 1996 Dec;210(4):241-7. Available from: http://journals.sagepub.com/doi/10.1243/PIME_PROC_1996_210_420_02. 97, 112
- [134] Perry JC, Rosen J, Burns S. Upper-Limb Powered Exoskeleton Design. *IEEE/ASME Transactions on Mechatronics*. 2007 Aug;12(4):408-17. Conference Name: IEEE/ASME Transactions on Mechatronics. 97, 112
- [135] Soubeyrand M, Assabah B, Bégin M, Laemmel E, Dos Santos A, Crézé M. Pronation and supination of the hand: Anatomy and biomechanics. *Hand Surgery and Rehabilitation*. 2017 Feb;36(1):2-11. Available from: <https://linkinghub.elsevier.com/retrieve/pii/S2468122916301591>. 98
- [136] Valentini PP, Vita L. David — A Multibody Virtual Dummy for Vibrational Comfort Analysis of Car Occupants. In: Schiehlen W, Valášek M, editors. *Virtual Nonlinear Multibody Systems*. NATO ASI Series. Dordrecht: Springer Netherlands; 2003. p. 253-62. Available from: https://doi.org/10.1007/978-94-010-0203-5_14. 98

- [137] Day JS. Chapter 10 - The Clinical Performance of UHMWPE in Elbow Replacements. In: Kurtz SM, editor. UHMWPE Biomaterials Handbook (Second Edition). Boston: Academic Press; 2009. p. 137-52. Available from: <https://www.sciencedirect.com/science/article/pii/B9780123747211000109>. 99
- [138] O'Sullivan LW, Gallwey TJ. Upper-limb surface electro-myography at maximum supination and pronation torques: the effect of elbow and forearm angle. *Journal of Electromyography and Kinesiology*. 2002 Aug;12(4):275-85. Available from: <https://linkinghub.elsevier.com/retrieve/pii/S1050641102000147>. 98
- [139] Matsuoka J, Berger RA, Berglund LJ, An KN. An Analysis of Symmetry of Torque Strength of the Forearm Under Resisted Forearm Rotation in Normal Subjects. *The Journal of Hand Surgery*. 2006 May;31(5):801-5. Available from: <https://linkinghub.elsevier.com/retrieve/pii/S0363502306003030>. 98
- [140] Cimatti B, Marcolino AM, Barbosa RI, De Cássia Registro Fonseca M. A study to compare two goniometric methods for measuring active pronation and supination range of motion. *Hand Therapy*. 2013 Jun;18(2):57-63. Available from: <http://journals.sagepub.com/doi/10.1177/1758998313495151>. 98
- [141] Soucie JM, Wang C, Forsyth A, Funk S, Denny M, Roach KE, et al. Range of motion measurements: reference values and a database for comparison studies. *Haemophilia*. 2011;17(3):500-7. eprint: <https://onlinelibrary.wiley.com/doi/pdf/10.1111/j.1365-2516.2010.02399.x>. Available from: <https://onlinelibrary.wiley.com/doi/abs/10.1111/j.1365-2516.2010.02399.x>. 98
- [142] Rahman HA, Fai YC, Ming ESL. Analysis of Human Hand Kinematics: Forearm Pronation and Supination. *Journal of Medical Imaging and Health Informatics*. 2014 Apr;4(2):245-9. Available from: <http://openurl.ingenta.com/content/xref?genre=article&issn=2156-7018&volume=4&issue=2&spage=245>. 99
- [143] Gupta A, O'Malley MK, Patoglu V, Burgar C. Design, Control and Performance of *RiceWrist*: A Force Feedback Wrist Exoskeleton for Rehabilitation and Training. *The International Journal of Robotics Research*. 2008 Feb;27(2):233-51. Available from: <http://journals.sagepub.com/doi/10.1177/0278364907084261>. 99
- [144] Krebs HI, Volpe BT, Williams D, Celestino J, Charles SK, Lynch D, et al. Robot-Aided Neurorehabilitation: A Robot for Wrist Rehabilitation. *IEEE Transactions on Neural Systems and Rehabilitation Engineering*. 2007 Sep;15(3):327-35. Conference Name: IEEE Transactions on Neural Systems and Rehabilitation Engineering. 99
- [145] MyoPro; 2016. Available from: <https://exoskeletonreport.com/product/myopro/>. 99
- [146] Dežman M, Asfour T, Ude A, Gams A. Exoskeleton Arm Pronation/Supination Assistance Mechanism With A Guided Double Rod System. In: 2019 IEEE-RAS 19th International Conference on Humanoid Robots (Humanoids); 2019. p. 559-64. ISSN: 2164-0580. 100, 101

- [147] Buongiorno D, Sotgiu E, Leonardis D, Marcheschi S, Solazzi M, Frisoli A. WRES: A Novel 3 DoF WRist ExoSkeleton With Tendon-Driven Differential Transmission for Neuro-Rehabilitation and Teleoperation. *IEEE Robotics and Automation Letters*. 2018 Jul;3(3):2152-9. Conference Name: IEEE Robotics and Automation Letters. 100, 101
- [148] Tsabedze T, Hartman E, Brennan C, Zhang J. A Compliant Robotic Wrist Orthosis Driven by Twisted String Actuators. In: 2021 International Symposium on Medical Robotics (ISMR); 2021. p. 1-7. 100, 101
- [149] McCarthy JM, Soh GS. *Geometric Design of Linkages*. Springer Science & Business Media; 2010. Google-Books-ID: jv9mQyjRIw4C. 105
- [150] Essomba T, Nguyen Vu L. Kinematic analysis of a new five-bar spherical decoupled mechanism with two-degrees of freedom remote center of motion. *Mechanism and Machine Theory*. 2018 Jan;119:184-97. Available from: <https://www.sciencedirect.com/science/article/pii/S0094114X1630670X>. 105
- [151] Bai S. Algebraic coupler curve of spherical four-bar linkages and its applications. *Mechanism and Machine Theory*. 2021 Apr;158:104218. Available from: <https://www.sciencedirect.com/science/article/pii/S0094114X20304353>. 105
- [152] Chiang CH. Synthesis of spherical four-bar path generators. *Mechanism and Machine Theory*. 1986 Jan;21(2):135-43. Available from: <https://www.sciencedirect.com/science/article/pii/0094114X86900030>. 105
- [153] Chu J, Sun J. Numerical atlas method for path generation of spherical four-bar mechanism. *Mechanism and Machine Theory*. 2010 Jun;45(6):867-79. Available from: <https://www.sciencedirect.com/science/article/pii/S0094114X09002286>. 105
- [154] Penunuri F, Peon-Escalante R, Villanueva C, Cruz-Villar CA. Synthesis of Spherical 4R Mechanism for Path Generation using Differential Evolution. *Mechanism and Machine Theory*. 2012 Nov;57:62-70. ArXiv:1112.2954 [cs]. Available from: <http://arxiv.org/abs/1112.2954>. 105
- [155] Gosselin CM, Hamel JF. The agile eye: a high-performance three-degree-of-freedom camera-orienting device. In: *Proceedings of the 1994 IEEE International Conference on Robotics and Automation*; 1994. p. 781-6 vol.1. 105
- [156] Hess-Coelho TA. A Redundant Parallel Spherical Mechanism for Robotic Wrist Applications. *Journal of Mechanical Design*. 2006 Sep;129(8):891-5. Available from: <https://doi.org/10.1115/1.2735645>. 105
- [157] Murray AP, Pierrot F. Design of a High-Speed Spherical Four-Bar Mechanism for Use in a Motion Common in Assembly Processes. In: *Volume 8: 31st Mechanisms and Robotics Conference, Parts A and B*. Las Vegas, Nevada, USA: ASMEDC; 2007. p. 511-8. Available from: <https://asmedigitalcollection.asme.org/IDETC-CIE/proceedings/IDETC-CIE2007/48094/511/361805>. 105
- [158] Kocabas H. Gripper Design With Spherical Parallelogram Mechanism. *JOURNAL OF MECHANICAL DESIGN*. 2009;131(7). Available from: <https://avesis.itu.edu.tr/yayin/0d15b30a-cd14-4a7d-99b6-fb82cea724fd/gripper-design-with-spherical-parallelogram-mechanism>. 105

- [159] Wu C, Liu XJ, Wang L, Wang J. Optimal Design of Spherical 5R Parallel Manipulators Considering the Motion/Force Transmissibility. *Journal of Mechanical Design*. 2010 Mar;132(3):031002. Available from: <https://asmedigitalcollection.asme.org/mechanicaldesign/article/doi/10.1115/1.4001129/466988/Optimal-Design-of-Spherical-5R-Parallel>. 105
- [160] McDonald M, Agrawal SK. Design of a Bio-Inspired Spherical Four-Bar Mechanism for Flapping-Wing Micro Air-Vehicle Applications. *American Society of Mechanical Engineers Digital Collection*; 2009. p. 945-53. Available from: <https://asmedigitalcollection.asme.org/IDETC-CIE/proceedings-abstract/IDETC-CIE2008/43260/945/321993>. 105
- [161] Fermat point; 2023. Page Version ID: 1137763262. Available from: https://en.wikipedia.org/w/index.php?title=Fermat_point&oldid=1137763262. 110
- [162] Spain PG. The Fermat Point of a Triangle. *Mathematics Magazine*. 1996 Apr;69(2):131-3. Publisher: Taylor & Francis _eprint: <https://doi.org/10.1080/0025570X.1996.11996409>. Available from: <https://doi.org/10.1080/0025570X.1996.11996409>. 110
- [163] Morrey BF, Askew LJ, Chao EY. A biomechanical study of normal functional elbow motion. *JBJS*. 1981 Jul;63(6):872. Available from: https://journals.lww.com/jbjsjournal/Abstract/1981/63060/A_biomechanical_study_of_normal_functional_elbow.2.aspx. 112
- [164] Sardelli M, Tashjian RZ, MacWilliams BA. Functional Elbow Range of Motion for Contemporary Tasks. *JBJS*. 2011 Mar;93(5):471. Available from: https://journals.lww.com/jbjsjournal/Abstract/2011/03020/Functional_Elbow_Range_of_Motion_for_Contemporary.8.aspx. 112
- [165] AYURA.pdf;. Available from: <https://ergo-diffusion.com/wp-content/uploads/2018/04/AYURA.pdf>. 121
- [166] Maheu V, Archambault PS, Frappier J, Routhier F. Evaluation of the JACO robotic arm: Clinico-economic study for powered wheelchair users with upper-extremity disabilities. In: 2011 IEEE International Conference on Rehabilitation Robotics; 2011. p. 1-5. ISSN: 1945-7901. 121
- [167] Liang X, Cheong H, Chui CK, Yeow CH. A Fabric-Based Wearable Soft Robotic Limb. *Journal of Mechanisms and Robotics*. 2019 Jun;11(3):031003. Available from: <https://asmedigitalcollection.asme.org/mechanismsrobotics/article/doi/10.1115/1.4043024/727687/A-FabricBased-Wearable-Soft-Robotic-Limb>. 121
- [168] 3D printed Third Thumb lends an extra finger; 2017. Available from: <https://www.3dnatives.com/en/3d-printed-third-thumb130720174/>. 121
- [169] Shafti A, Haar S, Mio R, Guillemot P, Faisal AA. Playing the piano with a robotic third thumb: assessing constraints of human augmentation. *Scientific Reports*. 2021 Nov;11(1):21375. Number: 1 Publisher: Nature Publishing Group. Available from: <https://www.nature.com/articles/s41598-021-00376-6>. 121

- [170] Gerez L, Dwivedi A, Liarokapis M. A Hybrid, Soft Exoskeleton Glove Equipped with a Telescopic Extra Thumb and Abduction Capabilities:7. 121
- [171] Hentz VR, LeClercq C. Surgical Rehabilitation of the Upper Limb in Tetraplegia. 1st ed. Saunders Ltd.; 2002. 122
- [172] Tricard T, Tavernier V, Zanni C, Martínez J, Hugron PA, Neyret F, et al. Freely orientable microstructures for designing deformable 3D prints. *ACM Transactions on Graphics*. 2020 Nov;39(6):1-16. Available from: <https://dl.acm.org/doi/10.1145/3414685.3417790>. 122
- [173] Vanneste F, Goury O, Martinez J, Lefebvre S, Delingette H, Duriez C. Anisotropic Soft Robots Based on 3D Printed Meso-Structured Materials: Design, Modeling by Homogenization and Simulation. *IEEE Robotics and Automation Letters*. 2020 Apr;5(2):2380-6. Available from: <https://ieeexplore.ieee.org/document/8972411/>. 122, 123
- [174] ULPA | Occupational Performance Model - OPM Australia;. Available from: <http://www.occupationalperformance.com/assessments/biomechanical-and-motor-component/ulpa/>. 123
- [175] McDonnell M. Action Research Arm Test. *Australian Journal of Physiotherapy*. 2008;54(3):220. Available from: <https://linkinghub.elsevier.com/retrieve/pii/S0004951408700345>. 123
- [176] Mathiowetz V, Volland G, Kashman N, Weber K. Adult Norms for the Box and Block Test of Manual Dexterity. *The American Journal of Occupational Therapy*. 1985 Jun;39(6):386-91. Available from: <https://doi.org/10.5014/ajot.39.6.386>. 123
- [177] Bangor A, Kortum P, Miller J. An Empirical Evaluation of the System Usability Scale. *International Journal of Human-Computer Interaction*. 2008 Aug;24(6):574-94. Publisher: Taylor & Francis Ltd. Available from: <https://search.ebscohost.com/login.aspx?direct=true&db=buh&AN=33402155&lang=fr&site=ehost-live>. 125
- [178] Ommeren ALv, Smulders LC, Prange-Lasonder GB, Buurke JH, Veltink PH, Rietman JS. Assistive Technology for the Upper Extremities After Stroke: Systematic Review of Users' Needs. *JMIR Rehabilitation and Assistive Technologies*. 2018 Nov;5(2):e10510. Company: JMIR Rehabilitation and Assistive Technologies Distributor: JMIR Rehabilitation and Assistive Technologies Institution: JMIR Rehabilitation and Assistive Technologies Label: JMIR Rehabilitation and Assistive Technologies Publisher: JMIR Publications Inc., Toronto, Canada. Available from: <https://rehab.jmir.org/2018/2/e10510>. 125
- [179] Sivan M, Gallagher J, Holt R, Weightman A, Levesley M, Bhakta B. Investigating the International Classification of Functioning, Disability, and Health (ICF) Framework to Capture User Needs in the Concept Stage of Rehabilitation Technology Development. *Assistive Technology*. 2014 Jul;26(3):164-73. Publisher: Taylor & Francis _eprint: <https://doi.org/10.1080/10400435.2014.903315>. Available from: <https://doi.org/10.1080/10400435.2014.903315>. 125

- [180] M R M Ferreira F, O Fonseca L, Le Guillou R, Trotobas C, Fattal C, Gasq D, et al. USER REQUIREMENTS FOR UPPER LIMB HYBRID MOTOR.pdf; 2023. . 125
- [181] Lambelet C, Temiraliuly D, Siegenthaler M, Wirth M, Woolley DG, Lambercy O, et al. Characterization and wearability evaluation of a fully portable wrist exoskeleton for unsupervised training after stroke. *Journal of NeuroEngineering and Rehabilitation*. 2020 Oct;17(1):132. Available from: <https://doi.org/10.1186/s12984-020-00749-4>. 127
- [182] Lambelet C, Lyu M, Woolley D, Gassert R, Wenderoth N. The eWrist - A wearable wrist exoskeleton with sEMG-based force control for stroke rehabilitation. *IEEE International Conference on Rehabilitation Robotics : [proceedings]*. 2017 Jul;2017:726-33. 128
- [183] Michaud B, Bailly F, Charbonneau E, Ceglia A, Sanchez L, Begon M. Bioptim, a Python Framework for Musculoskeletal Optimal Control in Biomechanics. *IEEE Transactions on Systems, Man, and Cybernetics: Systems*. 2023 Jan;53(1):321-32. Conference Name: IEEE Transactions on Systems, Man, and Cybernetics: Systems. 129
- [184] Popovic-Bijelic A, Bijelic G, Jorgovanovic N, Bojanic D, Popovic MB, Popovic DB. Multi-Field Surface Electrode for Selective Electrical Stimulation. *Artificial Organs*. 2005 Jun;29(6):448-52. Available from: <https://onlinelibrary.wiley.com/doi/10.1111/j.1525-1594.2005.29075.x>. 129
- [185] De Marchis C, Santos Monteiro T, Simon-Martinez C, Conforto S, Gharabaghi A. Multi-contact functional electrical stimulation for hand opening: electrophysiologically driven identification of the optimal stimulation site. *Journal of NeuroEngineering and Rehabilitation*. 2016 Mar;13(1):22. Available from: <https://doi.org/10.1186/s12984-016-0129-6>. 129
- [186] Koutsou AD, Moreno JC, Ama AJd, Rocon E, Pons JL. Advances in selective activation of muscles for non-invasive motor neuroprostheses. *Journal of NeuroEngineering and Rehabilitation*. 2016;13(1). Available from: <https://link.springer.com/epdf/10.1186/s12984-016-0165-2>. 129
- [187] Faure F, Duriez C, Delingette H, Allard J, Gilles B, Marchesseau S, et al. SOFA: A Multi-Model Framework for Interactive Physical Simulation. In: Payan Y, editor. *Soft Tissue Biomechanical Modeling for Computer Assisted Surgery*. vol. 11. Berlin, Heidelberg: Springer Berlin Heidelberg; 2012. p. 283-321. Series Title: *Studies in Mechanobiology, Tissue Engineering and Biomaterials*. Available from: https://link.springer.com/10.1007/8415_2012_125. 129
- [188] Bardi E, Ambrosini E, Pirelli A, Pedrocchi A, Braghin F, Covarrubias M, et al. Upper limb exosuit cable routing optimization. In: *2022 International Conference on Rehabilitation Robotics (ICORR)*; 2022. p. 1-6. ISSN: 1945-7901. 130
- [189] Schegg P, Ménager E, Khairallah E, Marchal D, Dequidt J, Preux P, et al. SofaGym: An Open Platform for Reinforcement Learning Based on Soft Robot Simulations. *Soft Robotics*. 2023 Apr;10(2):410-30. Publisher: Mary Ann Liebert, Inc., publishers. Available from: <https://www.liebertpub.com/doi/abs/10.1089/soro.2021.0123>. 129

Appendices

A Tree diagram for a categorization of upper limb orthosis

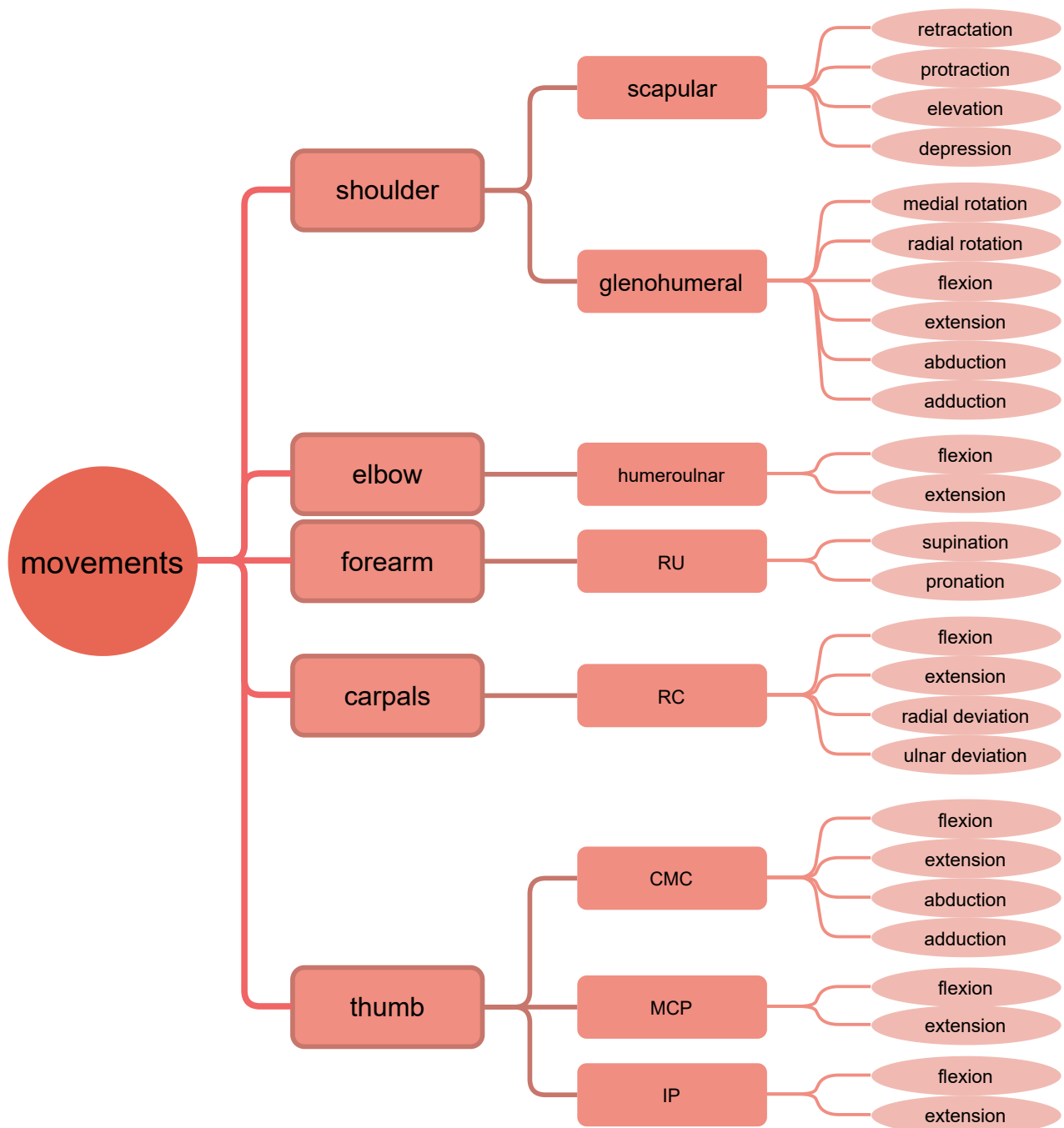

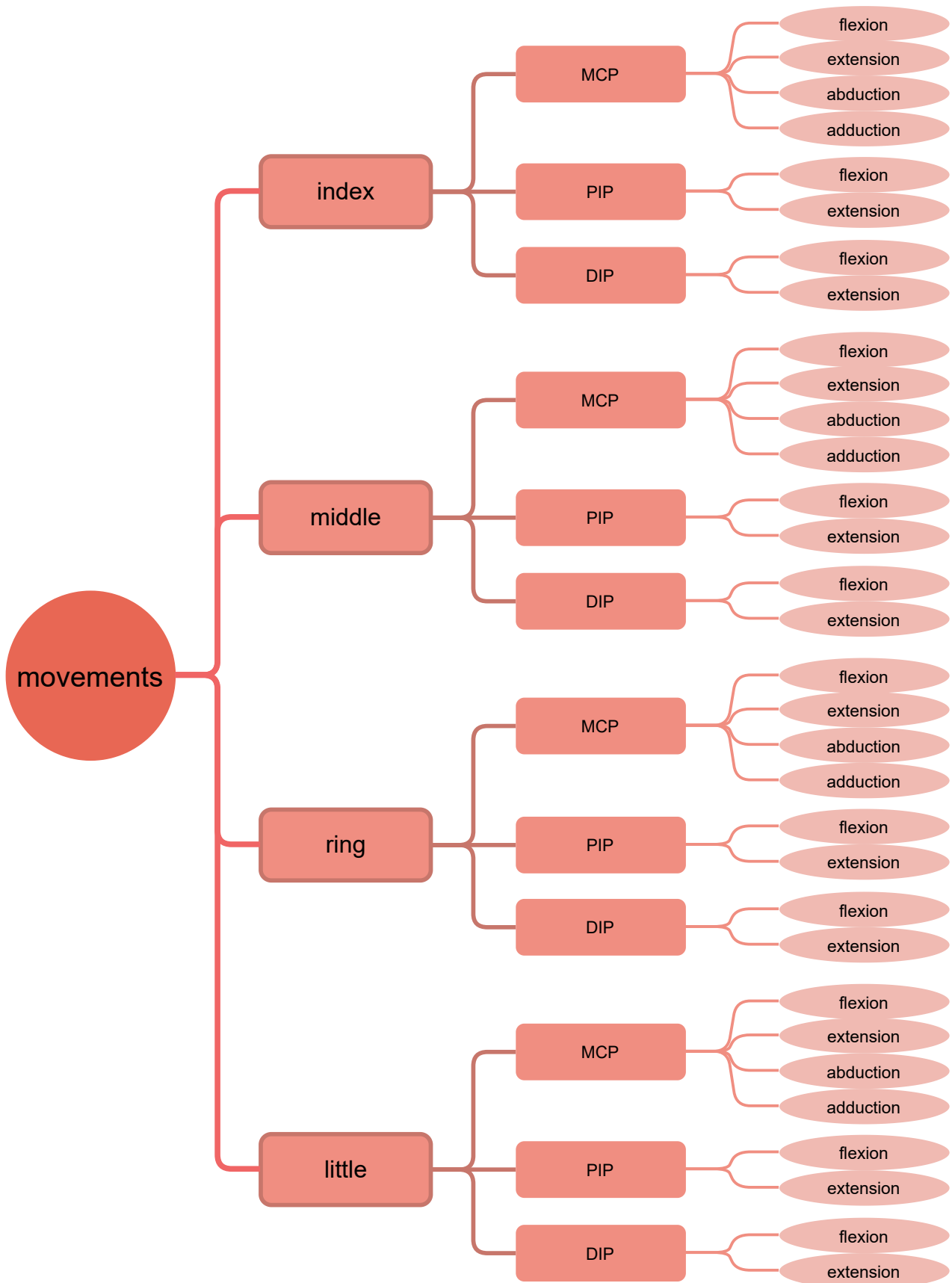

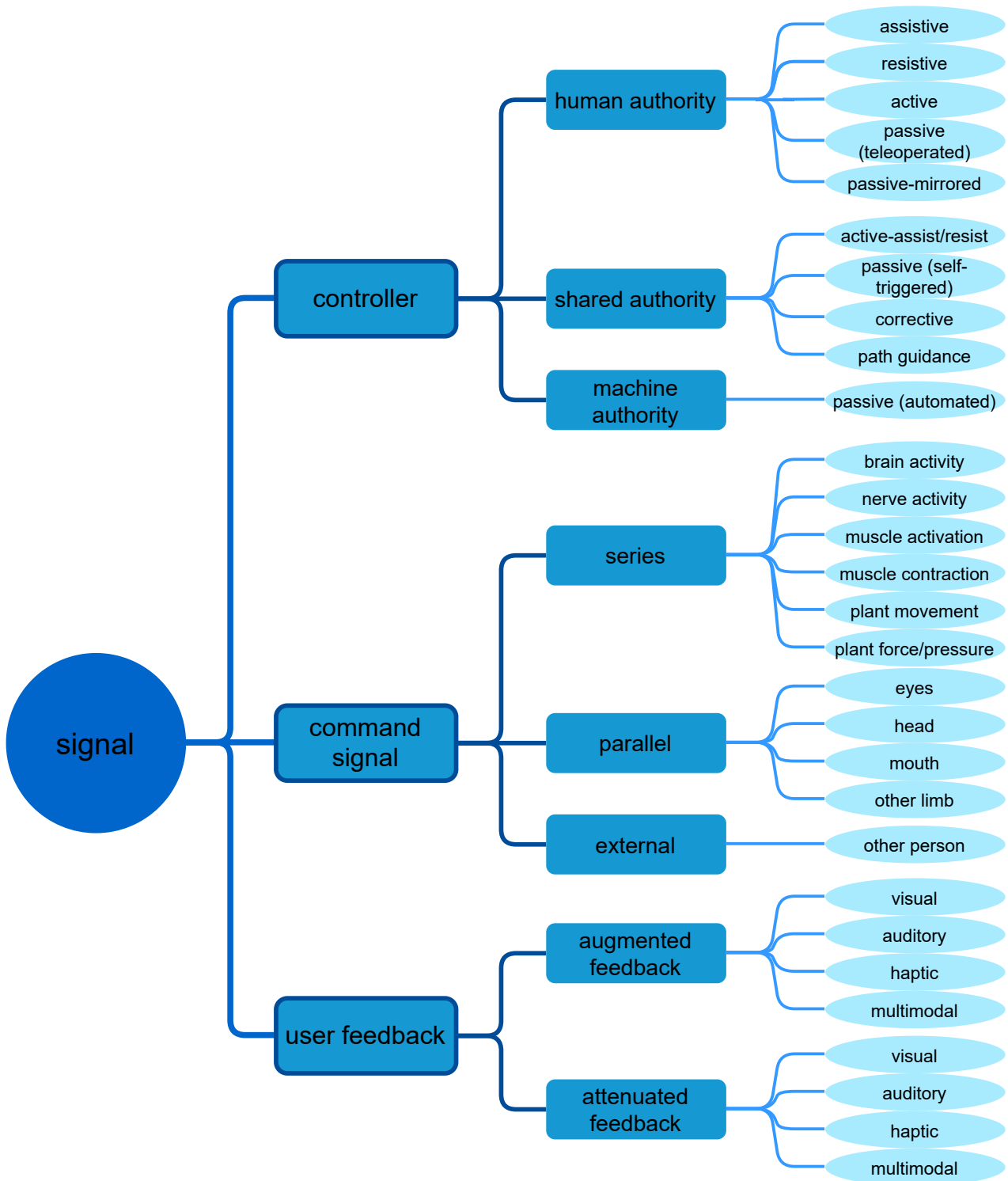

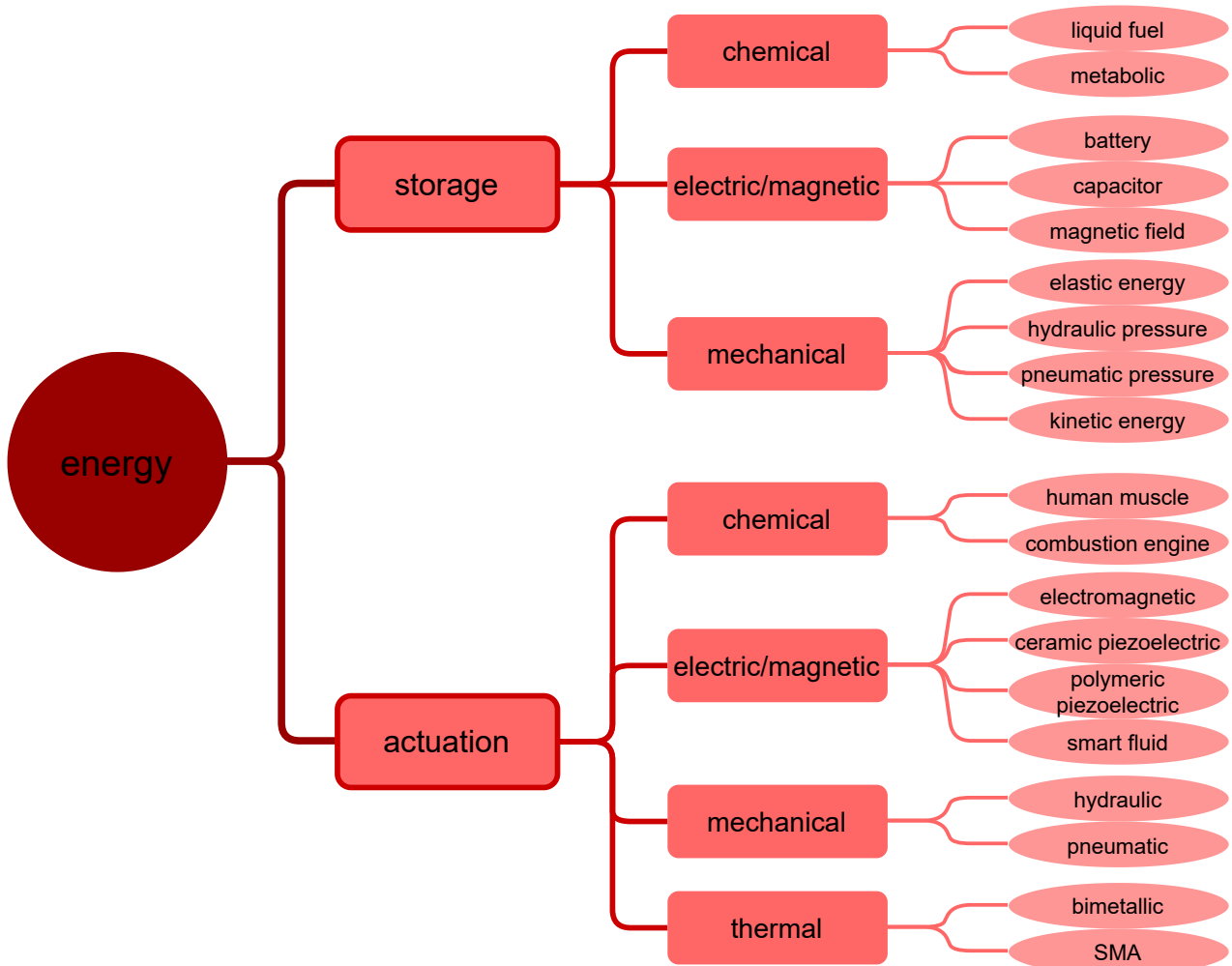

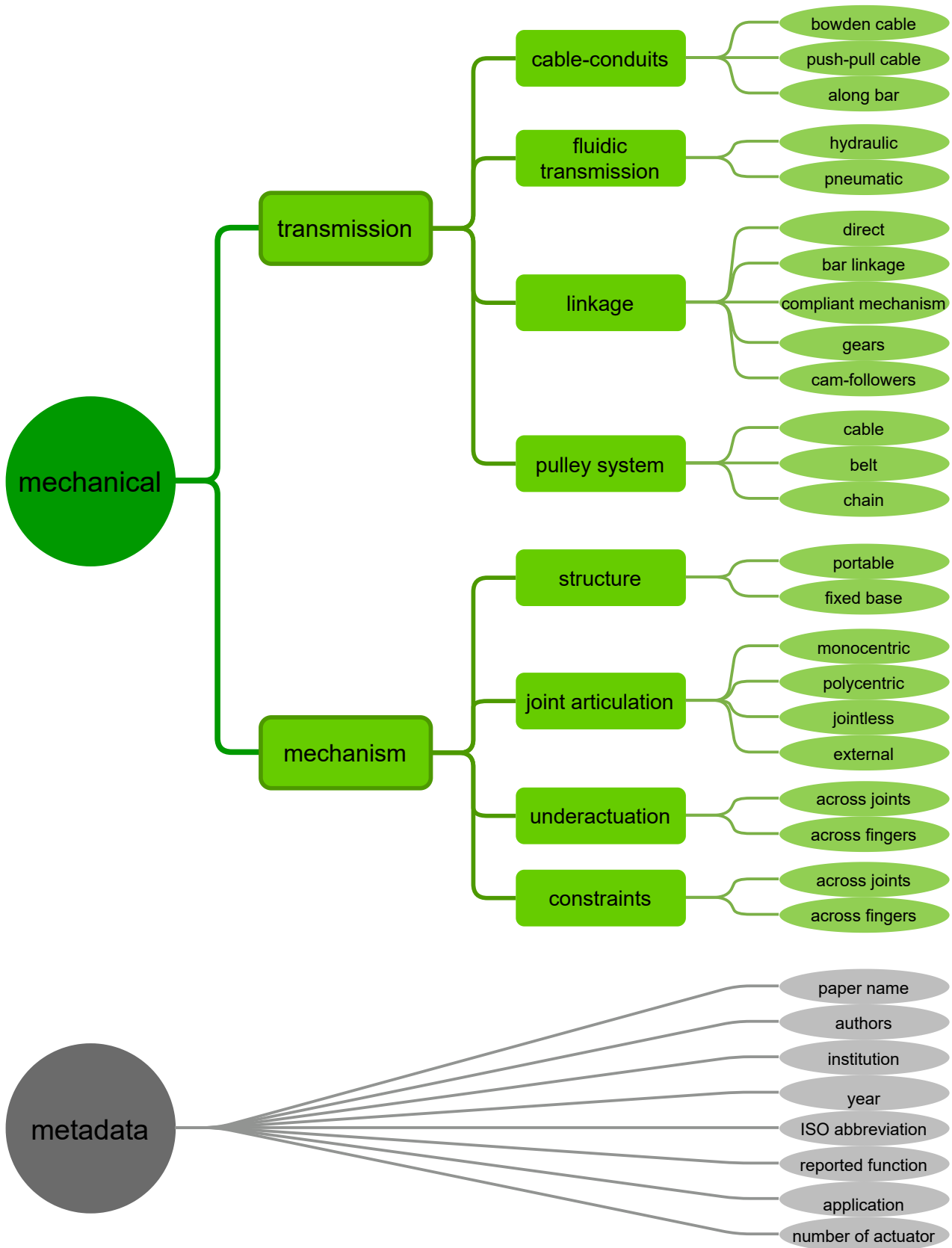

B Protocols

B.1 Exofinger

B.1.a Flowchart of the Exofinger protocol

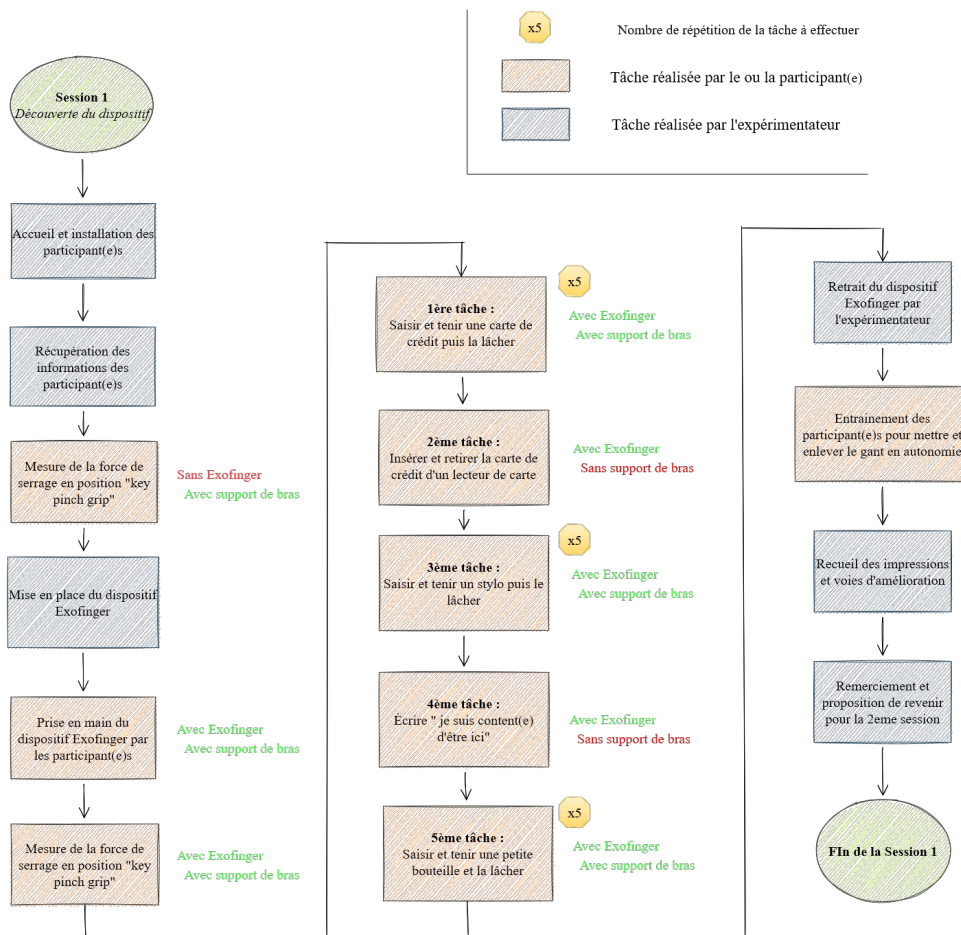

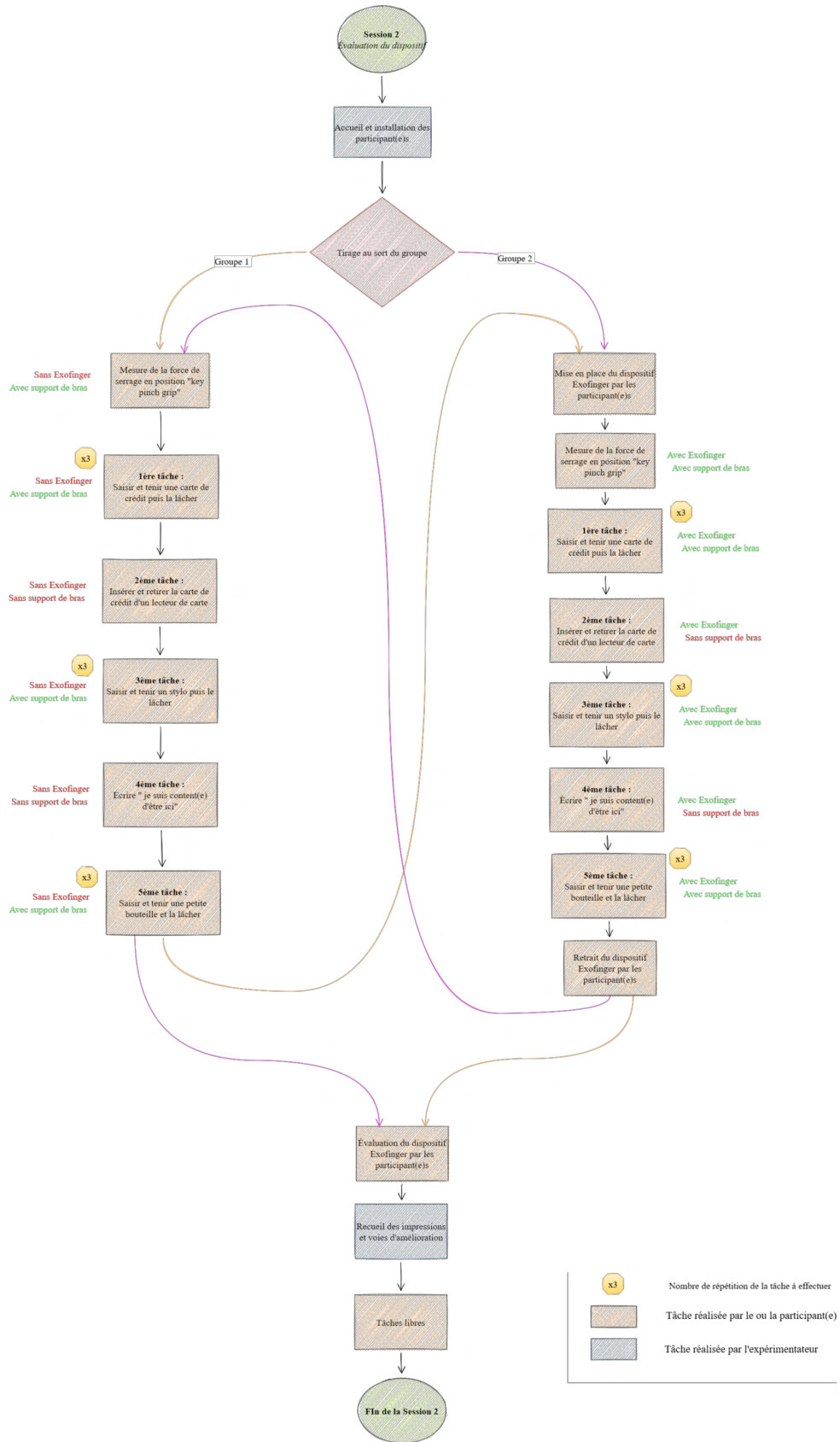

B.1.b Ethics committee approval **Président – Directeur général**

Rocquencourt, le 8 janvier 2022

Destinataires : Christine AZEVEDO COSTE,
Christophe BRAILLON, Charles FATTAL, Marie
GHEKIERE, Roger PISSARD-GIBOLLET, Benoît
SIJOBERT, Clément TROTOBASCopie : COERLE, correspondants COERLE,
Maureen CLERC, Pierre ALLIEZ**Objet : autorisation d'une expérimentation scientifique (autorisation n° 2021-47)**

Chers Collègues,

Suite à votre demande portant sur l'expérimentation « **Exofinger : outil pour la saisie d'objets** » (référence SICOERLE : n° 156), et suivant l'avis rendu par le COERLE en date du 07/01/2022 que vous voudrez bien trouver en pièce jointe, je vous informe que :

- J'autorise sans réserve le démarrage de l'expérimentation.
- J'autorise le démarrage de l'expérimentation sous réserve que les recommandations formulées par le COERLE soient mises en œuvre dans les délais impartis.
- Je refuse le démarrage de l'expérimentation.

Je vous remercie de bien vouloir tenir le COERLE informé des dates de début et de fin de l'expérimentation et de veiller à lui adresser un point sur son déroulement dans un court rapport 6 mois après son démarrage.

Enfin, je vous rappelle la nécessité de se conformer aux consignes pour prévenir les risques professionnels liés à la pandémie, relatives aux expérimentations notamment, données sur l'intranet :

<https://intranet.inria.fr/Inria/Gestion-de-crise/Gestion-nationale/Prevention/Prevention-des-risques-professionnels-lies-a-la-pandemie>

Bruno SPORTISSE



SIÈGE
Domaine de Voluceau
Rocquencourt – BP 105
78153 Le Chesnay Cedex France
Tél. : +33 (0)4 76 61 52 00
www.inria.fr



COERLE
COMITÉ OPÉRATIONNEL D'ÉVALUATION
DES RISQUES LÉGAUX ET ÉTHIQUES

Rocquencourt, le 7 janvier 2022

AVIS n° 2021-47

du Comité Opérationnel d'Évaluation des Risques Légaux et Éthiques (COERLE)

Le présent avis est rendu suite à la saisine du COERLE faite le 13 octobre 2021 par Maureen Clerc, directrice du centre Inria Sophia Antipolis – Méditerranée.

Cette saisine est intitulée : « **Exofinger : outil pour la saisie d'objets** » (référence SICOERLE : n° 156). Il s'agit d'une saisine spécifique.

Les scientifiques impliqués dans les équipes-projets et les services, à qui cet avis est prioritairement destiné, sont :

- Christine Azevedo Coste, directrice de recherche Inria, équipe-projet Camin (porteuse),
- Charles Fattal, médecin à l'USSAP Perpignan (établissement hospitalier), équipe-projet Camin,
- Benoît Sijobert, manager du Humanlab Saint-Pierre, équipe-projet Camin,
- Christophe Braillon, ingénieur de recherche, SED Rhône-Alpes,
- Roger Pissard-Gibollet, ingénieur de recherche, SED Rhône-Alpes,
- Marie Ghekiere, stagiaire, équipe-projet Camin,
- Clément Trotobas, doctorant, équipe-projet Camin.

Est également associée à l'expérimentation Karine Patte, médecin à l'Institut Saint-Pierre, spécialiste en médecine physique et de réadaptation.

Pour formuler son avis, le COERLE a disposé :

- du dossier de demande d'autorisation,
- d'un document explicitant le protocole d'expérimentation,
- du formulaire d'information et de consentement éclairé, en français.

Contexte et objectif de l'étude

Exofinger est un outil permettant à une personne n'ayant pas de flexion volontaire du pouce de saisir un objet. La solution consiste en un moteur électrique tirant un câble à travers un gant qui vient positionner le pouce contre les doigts repliés (pince pouce-index ou « *key pinch grip* »). Le moteur est inséré dans un boîtier porté sur l'avant-bras. L'utilisateur déclenche l'ouverture et la fermeture via l'actionnement d'un bouton sans fil. Une application pour smartphone permet de régler la course du câble.

Exofinger a été développé dans l'esprit et la philosophie des HumanLabs, qui sont des espaces collaboratifs de fabrication numérique ou de réparation d'objets ouverts à des personnes présentant un handicap pour leur permettre de s'approprier la technologie pour leur usage propre. Tous les projets qui y sont réalisés sont totalement documentés afin de les rendre répliquables par le plus grand nombre.



COERLE
COMITÉ OPÉRATIONNEL D'ÉVALUATION
DES RISQUES LÉGAUX ET ÉTHIQUES

Plus spécifiquement, Exofinger a été développé pour un utilisateur précis atteint de tétraplégie dans le cadre d'un hackathon organisé par le HumanLab MyHumanKit et ArianeGroup auquel s'est associée l'action exploratoire HLI (HumanLab Inria) mise en place pour inscrire Inria dans le réseau des HumanLabs. L'objectif de la saisine est d'évaluer, qualitativement et quantitativement, la pertinence et l'efficacité de l'outil pour la saisie d'objets auprès d'autres utilisateurs présentant une faiblesse ou une paralysie des muscles fléchisseurs du pouce.

Description de l'expérimentation

L'expérimentation durera 8 mois. Elle se déroulera dans les locaux du HumanLab Saint-Pierre de Palavas ou à l'USSAP de Perpignan, sous contrôle médical. Elle mobilisera des participants majeurs, au nombre de 5 à 20, présentant une difficulté à appliquer la face antérieure du pouce sur le côté de l'index replié avec le reste des doigts avec une force suffisante pour saisir des objets (par exemple pour tenir une clef). Ces participants seront identifiés via un appel auprès des adhérents du HumanLab Saint-Pierre et via un ciblage de divers patients de l'USSAP de Perpignan au profil jugé adéquat pour participer à l'étude.

Le projet permettra de valider le fonctionnement du dispositif auprès d'un panel d'utilisateurs, d'observer l'utilisation du dispositif et de recueillir l'avis des participants pour déterminer des axes possibles d'amélioration et s'assurer de la pertinence d'une recherche de généralité. Il s'agira en particulier d'analyser l'installation par l'utilisateur du système et la saisie et la manipulation d'objets courants. L'expérimentation consistera en une première séance de 2h permettant aux participants de découvrir et de se familiariser avec le dispositif et une seconde séance de 2h30, optionnelle, d'évaluation du dispositif.

La première séance se déroulera schématiquement de la façon suivante :

- recueil du consentement et collecte de quelques données ;
- installation du participant assis devant une table ajustable en hauteur, le bras reposant sur un support ;
- mise en place du dispositif Exofinger par les expérimentateurs et première prise en main ;
- réalisation de 5 tâches (saisir et tenir une carte de crédit donnée par l'expérimentateur ; saisir et tenir une carte de crédit posée sur un support et l'insérer dans un lecteur de carte ; saisir un stylo donné par l'expérimentateur ; etc.), répétées plusieurs fois, avec réglage à chaque fois de la course du câble pour l'adapter à la taille de l'objet à saisir
- retrait du dispositif par l'expérimentateur ;
- entraînement du participant à mettre et retirer lui-même le dispositif ;
- recueil des impressions et des idées d'amélioration.

La seconde séance se déroulera schématiquement de la même façon avec une composante supplémentaire d'évaluation, et notamment :

- réalisation des 5 tâches, avec ou sans dispositif Exofinger (dans un ordre aléatoire), avec mesure du temps de réalisation de la tâche ;
- mise en place et retrait du dispositif par le participant, avec chronométrage du temps nécessaire ;
- évaluation de l'utilisabilité du dispositif en 10 points (complexité, facilité d'utilisation, etc.) et des aspects taille, poids, confort, etc., sur une échelle de 1 à 5 ;
- réalisation de tâches libres et recueil des idées d'amélioration.



COERLE
COMITÉ OPÉRATIONNEL D'ÉVALUATION
DES RISQUES LÉGAUX ET ÉTHIQUES

Les données collectées comprendront :

- type, ancienneté et sévérité du handicap, utilisation préalable d'une orthèse motorisée, main dominante, main équipée du dispositif (au choix du participant) ;
- les données expérimentales (temps de réalisation des tâches, mesure des forces de serrage, etc.) ;
- les réponses aux questionnaires d'utilisabilité ;
- les idées d'amélioration ;
- des vidéos des bras des participants durant la réalisation des tests, pour une analyse postérieure des gestes.

Les données seront pseudonymisées et conservées au maximum 2 ans.

Analyse du COERLE

La saisine décrit de façon complète et très claire l'étude permettant d'avoir une vision globale du projet. Les chercheurs sont formés aux questions éthiques. Les bonnes pratiques en matière d'information et de recueil de consentement sont suivies. Les possibilités de découverte fortuite sont quasi-inexistantes et l'étude présente des risques très limités pour les participants, d'autant plus qu'elle bénéficie d'un accompagnement médical.

Le COERLE ne voit aucun point important à soulever. Il souhaite simplement faire part des commentaires suivants :

- A. La phrase « *aucune table de correspondance avec le nom du participant ne sera gardée* » est assez étrange puisque dans le cadre d'une pseudonymisation c'est ce qui permet de faire le lien entre le pseudonyme et l'identité réelle de chaque participant et de donner suite à des demandes d'exercice de droits. On pourrait à la limite arguer que les données ne permettent pas la réidentification des participants, et dans ce cas il n'y aurait besoin ni de pseudonymisation ni de table de correspondance, mais ici, au vu notamment des informations de santé demandées, il est préférable de considérer qu'il y a bien données à caractère personnel.
- B. On ne comprend pas forcément bien ce que signifie « *Type de handicap, ancienneté et sévérité (optionnel)* ». Soit ces informations sont importantes pour l'évaluation des résultats et l'amélioration du dispositif, et alors la participation à l'expérimentation doit être « assujettie » à leur fourniture. Soit ce n'est pas le cas, et alors il ne faut simplement pas les demander, dans une logique de minimisation des données (RGPD).
- C. Il en est de même pour la phrase : « *Les participants peuvent ne pas donner leur accord pour [...] être filmés* ». On n'est pas ici dans un cadre d'images utilisées ultérieurement à des fins d'illustration, ce qui nécessiterait la signature là optionnelle d'un formulaire de droit à l'image distinct du formulaire de consentement. Ici, si les vidéos sont indispensables pour mener à bien le travail d'évaluation et d'amélioration du dispositif, il ne doit pas être possible de prendre part à l'expérimentation en refusant leur captation, et cela doit être dit clairement dans le formulaire d'information et de consentement. (Au passage, ces vidéos ne sont pas optionnelles dans la version actuelle du formulaire.)
- D. L'affirmation faite aux participants, relative à leur participation, que « *aucun bénéfice n'est attendu pour vous* » est un peu bizarre puisqu'on peut imaginer que certains d'entre eux seront de potentiels futurs utilisateurs.



COERLE
COMITÉ OPÉRATIONNEL D'ÉVALUATION
DES RISQUES LÉGAUX ET ÉTHIQUES

E. Il n'est pas dit clairement que les deux séances ne seront pas réalisées l'une à la suite de l'autre. C'est vraisemblablement le cas au vu de leur durée, mais cela mériterait d'être précisé.

Avis du COERLE

Le COERLE donne un avis favorable à la mise en place de cette expérimentation sous réserve de la prise en compte des remarques ci-dessus et de la transmission d'éléments complémentaires et d'une mise à jour du document de saisine le cas échéant.

Les dates de début puis de fin de l'expérimentation devront être notifiées au COERLE. De plus, à des fins de suivi, un court rapport faisant le point sur le déroulement de l'expérimentation sera adressé au COERLE au plus tard 6 mois après son démarrage.

Le président du COERLE

A handwritten signature in black ink, appearing to read "Sylvain PETITJEAN".

Sylvain PETITJEAN

B.1.c Blank forms

Code participant·e :

Session 1

.....

Fiche participant·e

 Le formulaire de consentement à t-il bien été signé en début de séance ? Oui Non

Partie I.

De quel type de handicap êtes vous porteur ? (optionnel)

Quel est la sévérité de ce handicap ? (optionnel)

Depuis combien de temps êtes vous porteur de ce handicap ? (optionnel)

Quel est votre main dominante ?

Sur quelle main souhaitez vous porter le dispositif Exofinger ?

Avez vous déjà porté une orthèse ?

Si oui, était-elle motorisée ?

Partie II.Valeur moyenne de la force de serrage : **sans Exofinger****avec Exofinger****Partie III.**

Remarques :

Code participant·e :

Session 2

.....

Partie IV.Valeur moyenne de la force de serrage : **sans Exofinger****avec Exofinger****Partie V.****Saisir et tenir une carte de crédit donnée par l'expérimentateur pendant une durée supérieure à 30 sec puis la lâcher. x3**

Tâche 1: Carte	Réussite : Oui/Non ?	Temps de saisie	Réussite : Oui/Non ?	Temps de Saisie	Réussite : Oui/Non ?	Temps de Saisie
Sans Exofinger						
Avec Exofinger						

Numéro fichier vidéo :(sans Exofinger)(avec Exofinger)

Saisir et tenir la carte de crédit disposée sur un support de telle sorte qu'une partie de la carte soit dans le vide pour l'attraper et que le support bloque le déplacement de la carte pour ne pas qu'elle glisse lors de la saisie; Puis, l'insérer dans le lecteur de carte fixé sur la table devant lui/elle et la lâcher. Attraper de nouveau la carte située dans le lecteur, la retirer du lecteur et la remettre sur le support. x1

Tâche 2: Carte	Réussite : Oui/Non ?	Temps total
Sans Exofinger		
Avec Exofinger		

Numéro fichier vidéo :(sans Exofinger)(avec Exofinger)

Code participant·e :

Session 2

.....

Saisir un stylo donné par l'expérimentateur et le tenir dans le vide pendant une durée supérieure à 30 sec puis le lâcher x 3

Tâche 3: Stylo	Réussite : Oui/Non ?	Temps de saisie	Réussite : Oui/Non ?	Temps de Saisie	Réussite : Oui/Non ?	Temps de Saisie
Sans Exofinger						
Avec Exofinger						

Numéro fichier vidéo :(sans Exofinger)(avec Exofinger)

Saisir un stylo placé sur un support devant lui de telle sorte que la partie basse du stylo soit dans le vide. Se placer au dessus de la feuille placé devant lui et écrire la phrase "Je suis content(e) d'être ici". Replacer le stylo sur le support et le lâcher. x1

Tâche 4: Stylo	Réussite : Oui/Non ?	Temps total
Sans Exofinger		
Avec Exofinger		

Numéro fichier vidéo :(sans Exofinger)(avec Exofinger)

Saisir une petite bouteille d'eau (25cl) donnée par l'expérimentateur et la tenir dans le vide pendant une durée supérieure à 30 sec puis la reposer et la lâcher x3

Tâche 5: Bouteille	Réussite : Oui/Non ?	Temps de saisie	Réussite : Oui/Non ?	Temps de Saisie	Réussite : Oui/Non ?	Temps de Saisie
Sans Exofinger						
Avec Exofinger						

Numéro fichier vidéo :(sans Exofinger)(avec Exofinger)

Partie VI.

Chronométrage temps pour mettre le gant :

Chronométrage temps pour retirer le gant :

Code participant·e :

Session 2

.....

Numéro fichier vidéo :(mettre)(enlever)

Partie VII.

Évaluation du dispositif

Note entre 1 et 5 (1 pas du tout d'accord et 5 tout a fait d'accord)

1. Je pense que je vais utiliser le dispositif exofinger fréquemment
2. Je pense que le dispositif exofinger est inutilement complexe
3. Je pense que le dispositif exofinger était facile d'utilisation
4. Je pense que je vais devoir faire appel à l'aide d'un tiers pour pouvoir utiliser le dispositif exofinger
5. Je pense que les fonctionnalités du dispositif exofinger sont bien exploitées.....
6. Je pense qu'il y a beaucoup trop d'incohérences dans le dispositif exofinger.....
7. Je pense que la plupart des gens apprendront très rapidement à utiliser le dispositif exofinger
8. Je pense que le dispositif exofinger est vraiment très lourd à utiliser.....
9. Je me suis senti très confiant en utilisant le dispositif exofinger.....
10. J'ai dû apprendre beaucoup de choses avant de pouvoir utiliser le dispositif exofinger

Note entre 1 et 10 (1 pas du tout d'accord et 5 tout a fait d'accord)

Pourriez-vous évaluer, sur une échelle de dix points, votre satisfaction globale à l'égard de l'utilisation du dispositif Exofinger

.....

Note entre 1 et 5 (1 pas du tout satisfait et 5 tout a fait satisfait)

1. Taille
2. Poids
3. Esthétique
4. Confort
5. Fonctionnement

Code participant·e :

.....

Session 2

Partie VIII.

Remarques :

B.2 Grasphyb

B.2.a Flowchart of the Grasphyb pilot study protocol

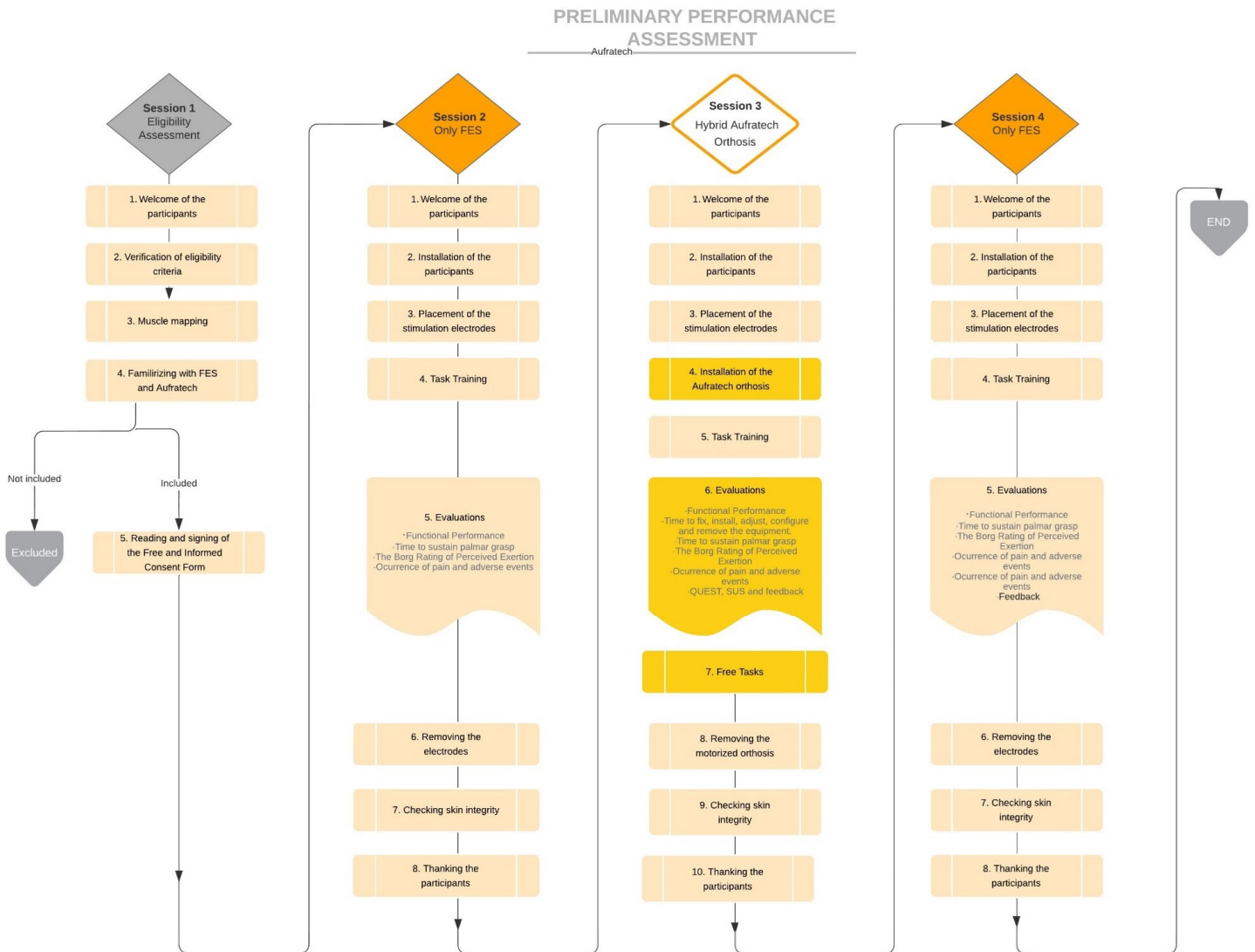

B.2.b Ethics committee approval for preliminary assessments



Président – Directeur général

o çÀèi ÉaÀçi èl-É-P-èi èèMCP

a Éiá~í~áÉ~W ÜáááÉ^ wbsbal ð l pqbl=
cÉá~àÇ~èl aofdr bpçboobfo^èl mbpl=
` Éá Éáiçol ql _^p

` çéá~W l boi blAçéÉéçàÇ-áieð l boi bl=
j ~i ÉÉá= i bo` la~í Ç= l r aboç

Objet : autorisation d'une expérimentation scientifique (autorisation n° 2023-14)

` ÜÉèè= çãÖ Éèl

pl áÉ ± ñçíÉÉ ÇÉá ~áÇÉ ççè~ái èi è ãÉnéYéè Éái~íçá « GRASP-HYB » ÈYÍKpf l boi b~W
áYQNH-Éi-èi á ~ái-á-i ç-ÉáÇ ç-è-é= l boi b-Éá-Ç-íÉ-Çi PNMPLMCP-èi Éñçì èñçì ÇÉè-ÁÉá
íççì íÉè-Éá-èèÁÉççáíÉ çÉñçì è-èNéè É-èi É~W

□ ç~i íçèÉÉ-è-èè-èYéÉá É-É-ÇYá ~è-ÖÉ-ÇÉ-áÉnéYéè Éái~íçáK

☑ g~i íçèÉÉ-É-É-ÇYá ~è-ÖÉ-ÇÉ-áÉnéYéè Éái~íçá ççì è-èYéÉá É èi É-Éè-ÉÉçá á ~áÇ-íçáè
Néè i áYÉè-é-é-é= l boi b-èçááí-á èÉè-Éá=í íÉ-Ç-áè-É-ÇYá è-è é-èèK

□ çÉ-ÉNéÉ-É-ÇYá ~è-ÖÉ-ÇÉ-áÉnéYéè Éái~íçáK

gÉñçì è-Éá ÉÁÉ-ÇÉ-ÁÉá ñçì ççè-Éáè-é= l boi b-èNéè Y-ÇÉè-Ç-íÉè-ÇÉ-ÇYÁi í-Éi-ÇÉ-èè-ÇÉ
áÉnéYéè Éái~íçá-Éi-ÇÉ-ÉáÉ-É-á-ÇÉéèÉè à-èçáí-èi èççá-ÇYçì Éá Éái-Ç-áèè à-Áçì é-è-ééçè
S-á ççè-éèè-èççá-ÇYá ~è-ÖÉK

_è áççml oqfppb

SIÈGE
Domaine de Voluceau
Rocquencourt —BP 105
78153 Le Chesnay Cedex France
Tél. : +33 (0)4 76 61 52 00
www.inria.fr



COERLE
COMITÉ OPÉRATIONNEL D'ÉVALUATION
DES RISQUES LÉGAUX ET ÉTHIQUES

Rocquencourt, le 31 mars 2023

AVIS n° 2023-14

du Comité Opérationnel d'Évaluation des Risques Légaux et Éthiques (COERLE)

Le présent avis est rendu suite à la saisine du COERLE faite le 6 février 2023 par Maureen Clerc, directrice du centre Inria d'Université Côte d'Azur.

Cette saisine est intitulée : « **GRASP-HYB** » (référence SICOERLE : n° 219). Il s'agit d'une saisine spécifique.

Les scientifiques impliqués dans les équipes-projets et les services, à qui cet avis est prioritairement destiné, sont :

- Christine Azevedo Coste, directrice de recherche Inria, équipe-projet Camin (porteur),
- Fernanda Rodrigues Ferreira Lopes, postdoctorante, équipe-projet Camin,
- Clément Trotobas, doctorant, équipe-projet Camin.

Pour formuler son avis, le COERLE a disposé :

- du dossier de demande d'autorisation,
- du formulaire d'information et de consentement éclairé, en français.

Contexte et objectif de l'étude

Le projet s'inscrit dans la thématique générale de l'assistance au mouvement de la main (doigts et poignets) pour des personnes présentant une paralysie du membre supérieur. Les chercheurs s'intéressent à deux grandes familles d'approches : d'un côté, la stimulation électrique fonctionnelle (SEF) qui consiste à appliquer de petites impulsions électriques sur un ou plusieurs muscles pour déclencher sa contraction. La SEF requiert une source d'énergie très simple (une pile) mais entraîne à la longue une fatigue de l'utilisateur. D'un autre côté, des orthèses actives (appelées aussi exosquelettes) qui, placées sur le membre paralysé, entraînent des mouvements précis et que l'on peut répéter mais qui nécessitent une source d'énergie plus importante.

L'objectif du projet est de combiner les deux approches pour bénéficier de leurs avantages respectifs ; concrètement, le mouvement est déclenché par la SEF, puis est guidé par une orthèse en mode passif (pas de force appliquée) qui bloque l'articulation dans la position finale. Cette combinaison permet de réduire la taille des moteurs (et donc leur consommation électrique) tout en limitant la fatigue musculaire.

Un prototype d'une telle orthèse hybride a été développé par la société Aufratech pour répondre aux besoins des chercheurs qui, de leur côté, ont développé un contrôleur pour piloter les moteurs et les synchroniser avec la SEF. À terme, cette orthèse a vocation à être testée sur des patients atteints de tétraplégie dans le cadre d'une étude clinique. Auparavant, il faut valider le bon fonctionnement de l'architecture mécanique et logicielle ainsi que la robustesse et la stabilité du contrôleur dans le cadre d'une étude avec des sujets sains ; c'est l'objet de cette saisine.



COERLE
COMITÉ OPÉRATIONNEL D'ÉVALUATION
DES RISQUES LÉGAUX ET ÉTHIQUES

Description de l'expérimentation

L'expérimentation durera 6 mois. Elle se déroulera au sein de l'antenne Inria à Montpellier. Elle mobilisera des participants adultes non-vulnérables, recrutés dans l'environnement professionnel immédiat en s'assurant qu'ils ne soient pas en situation de subordination vis-à-vis des expérimentateurs. Ils ne seront pas compensés pour les contraintes subies du fait de leur participation.

Pour l'expérimentation, les participants seront assis sur une chaise devant une table après avoir pris connaissance du formulaire de consentement éclairé et l'avoir signé. La session se déroulera en plusieurs phases :

1. *Mise en place du dispositif de SEF.* Trois paires d'électrodes seront placées sur l'avant-bras du participant, puis un calibrage par intensité croissante permettra de définir le seuil de stimulation le plus efficace sans causer d'inconfort. Plusieurs mouvements (flexion et extension ainsi que la saisie et le maintien d'objets) seront alors répétés.
2. *Ajout de l'orthèse.* Tout en conservant les électrodes sur la peau pour ne pas perdre le calibrage réalisé, mais en coupant l'alimentation électrique, l'orthèse sera placée sur l'avant-bras et réglée aux bonnes dimensions, puis aux amplitudes maximales du poignet tout en conservant une marge de sécurité pour éviter une éventuelle hyperextension.
3. *Familiarisation.* Le participant pourra alors déclencher lui-même les mouvements via un bouton poussoir de façon à se familiariser avec le comportement du système. Plusieurs points seront vérifiés : éventuels points de pression sur la peau, inconfort, adéquation posturale, etc.
4. *Évaluation.* Le participant devra finalement réaliser un ensemble de tâches (répétées 5 fois) de saisie et de maintien d'objets (bouteille, balle, fourchette) avant de les faire tomber dans une boîte.

Un bouton d'arrêt d'urgence permettra de mettre fin instantanément au mouvement de l'orthèse en cas de difficulté. Chaque session durera environ 1 heure.

Outre les données de contact, les données collectées se limiteront aux données expérimentales suivantes : changements d'état des moteurs et de la stimulation, temps d'exécution des tâches, indicateurs de réussite des tâches. Elles seront pseudonymisées et conservées au maximum 18 mois.

Analyse du COERLE

La saisine décrit de façon complète et très claire l'étude permettant d'avoir une vision globale du projet. L'expérimentation est parfaitement justifiée en regard de l'objectif visé. Les chercheurs sont formés aux questions éthiques. Les bonnes pratiques en matière d'information et de recueil de consentement sont suivies. La saisine présente clairement et de façon très détaillée les risques théoriques et explique clairement les mesures mises en place pour empêcher qu'ils ne se réalisent (limitation des couples appliqués, angles maximaux bloquants, vitesse réduite, moteur appliqué uniquement en flexion des doigts, bouton d'arrêt d'urgence). Les procédures utilisées étant non-invasives les risques posés à la santé des participants sont minimes.

Le COERLE ne voit aucun point important à soulever. Il se borne à relever les points mineurs suivants :



COERLE
COMITÉ OPÉRATIONNEL D'ÉVALUATION
DES RISQUES LÉGAUX ET ÉTHIQUES

- A. Il n'est pas fait état dans les documents de critères d'exclusion pour la participation à l'étude alors qu'il est probable qu'il en existe (par exemple : antécédents de troubles musculosquelettiques ou neurologiques pouvant affecter le comportement moteur de la main).
- B. Indiquer le nombre de participants à l'expérimentation.
- C. Il est suggéré de mentionner explicitement dans le formulaire de consentement que le participant peut actionner un bouton d'arrêt d'urgence pour stopper immédiatement le fonctionnement de l'orthèse en cas de besoin.

Avis du COERLE

Le COERLE donne un avis favorable à la mise en place de cette expérimentation sous réserve de la prise en compte des remarques ci-dessus et de la transmission d'éléments complémentaires et d'une mise à jour du document de saisine le cas échéant.

Les dates de début puis de fin de l'expérimentation devront être notifiées au COERLE. De plus, à des fins de suivi, un court rapport faisant le point sur le déroulement de l'expérimentation sera adressé au COERLE au plus tard 6 mois après son démarrage.

Le président du COERLE

Sylvain PETITJEAN

B.2.c Ethics committee approval for clinical trials

UNIVERSIDADE FEDERAL DE
MINAS GERAIS



PARECER CONSUBSTANCIADO DO CEP

DADOS DO PROJETO DE PESQUISA

Título da Pesquisa: Validação de um conceito de órtese motorizada de punho e mão

Pesquisador: HENRIQUE RESENDE MARTINS

Área Temática:

Versão: 4

CAAE: 53757521.3.0000.5149

Instituição Proponente: UNIVERSIDADE FEDERAL DE MINAS GERAIS

Patrocinador Principal: Financiamento Próprio

DADOS DO PARECER

Número do Parecer: 5.517.869

Apresentação do Projeto:

Trata-se de resposta ao parecer CEP/UFMG Nº 5.463.340 referente à apreciação ética do Projeto: Validação de um conceito de órtese motorizada de punho e mão. Foi desenvolvida uma órtese motorizada de punho e mão com vantagens em relação aos equipamentos disponíveis no Brasil e no exterior. Nesse contexto, este projeto visa avaliar a aplicabilidade e funcionalidade desse dispositivo em indivíduos com comprometimento motor de membro superior decorrente de lesão da medula espinhal (tetraplegia). Serão selecionados 10 participantes a fim de realizar testes experimentais para investigar a habilidade de executar com eficiência e segurança a movimentação de punhos e dedos, a preensão palmar repetitiva de diferentes objetos, bem como a contribuição do equipamento em evitar a fadiga muscular em comparação com a FES aplicada isoladamente. Além disso, será verificado a facilidade de instalação e operação do equipamento e o grau de satisfação e aceitação dos usuários, analisando a necessidade de mudanças e adaptações no dispositivo. Espera-se com esse estudo validar o funcionamento da órtese motorizada de punho e mão, permitindo lançar um equipamento com alto diferencial de mercado (inovador, com tecnologia de ponta e com acoplamento de funcionalidades não disponíveis nos sistemas híbridos existentes). Dessa forma, será capaz de auxiliar na realização de tarefas funcionais diárias de indivíduos com tetraplegia, aumentando sua participação social e qualidade de vida.

Objetivo da Pesquisa:

O objetivo geral deste projeto é avaliar a aplicabilidade e funcionalidade de um conceito de órtese

Endereço: Av. Presidente Antonio Carlos, 6627 ç 2º. Andar ç Sala 2005 ç Campus Pampulha

Bairro: Unidade Administrativa II **CEP:** 31.270-901

UF: MG **Município:** BELO HORIZONTE

Telefone: (31)3409-4592

E-mail: coep@prpq.ufmg.br

UNIVERSIDADE FEDERAL DE
MINAS GERAIS

Continuação do Parecer: 5.517.869

motorizada de punho e mão em indivíduos com comprometimento motor de membro superior decorrente de lesão da medula espinal.

Objetivo Secundário:

O projeto tem como objetivos específicos:

- Avaliar a habilidade de executar com eficiência e segurança os movimentos de flexão e extensão de punho e dedos, bem como o correto funcionamento da estrutura;
- Avaliar a habilidade de realizar a preensão palmar de diferentes objetos e sustentá-los;
- Validar a contribuição da órtese híbrida para evitar a fadiga muscular e auxiliar na movimentação em comparação com a estimulação elétrica aplicada isoladamente;
- Verificar a facilidade de instalação e operação do equipamento;
- Verificar a escolha dos graus de liberdade assistidos fornecidos pelo dispositivo, ou seja, se eles atendem os objetivos propostos de realizar a preensão de objetos;
- Avaliar o grau de conforto, satisfação e aceitação do usuário quanto ao uso do equipamento e adquirir opinião quanto as possíveis melhorias;
- Gerar e incorporar novos conhecimentos (biomecânica, neurofisiologia) úteis para o desenvolvimento de novas formas de tratamento, recuperação de lesões e novos produtos;
- Proporcionar integração entre as áreas de conhecimento envolvidas (bioengenharia, biomecânica, engenharia, eletrônica, neurofisiologia) criando um ambiente saudável de cooperação mútua e inovação tecnológica.

Avaliação dos Riscos e Benefícios:

Segundo os pesquisadores os riscos que o projeto da validação da órtese híbrida de punho e mão oferecem à saúde dos participantes são mínimos, uma vez que todos os procedimentos utilizados são não invasivos. É garantido aos participantes que danos e desconfortos previsíveis serão evitados. Os possíveis riscos da pesquisa estão relacionados ao participante sentir dor ou cansaço durante o uso da órtese híbrida, visto que o dispositivo pode gerar desconforto e o período necessário para teste laboratorial pode demandar posturas eventualmente incômodas. Nesse contexto, a solução será utilizar parâmetros baixos da FES (diminuir a intensidade da corrente de acordo com a tolerância do participante, de forma que a contração muscular seja estimulada sem provocar dor) e menor angulação da órtese robótica e, se necessário, interrupção do teste. Caso o participante não tolere a intensidade mínima da corrente elétrica necessária para estimular a

Endereço: Av. Presidente Antonio Carlos, 6627 ç 2º. Andar ç Sala 2005 ç Campus Pampulha
Bairro: Unidade Administrativa II **CEP:** 31.270-901
UF: MG **Município:** BELO HORIZONTE
Telefone: (31)3409-4592 **E-mail:** coep@prpq.ufmg.br

UNIVERSIDADE FEDERAL DE
MINAS GERAIS



Continuação do Parecer: 5.517.869

contração muscular, ele não participará do estudo. As necessidades e o possível medo dos participantes serão sempre respeitados. Além disso, o participante será informado antes do ingresso na pesquisa que ele poderá interromper sua participação em qualquer etapa do procedimento sem nenhum prejuízo. Vale ressaltar que devido à alteração de sensibilidade que esses indivíduos apresentam abaixo do nível da lesão, serão utilizadas frequências, largura de pulso e intensidade de corrente adequadas para que não acarrete nenhum tipo de lesão. Deve-se destacar que todas as condições serão ajustadas de forma a proporcionar o uso seguro e confortável das interfaces em estudo. Os benefícios segundo os pesquisadores são a aquisição de um novo e promissor sistema robótico híbrido para reabilitação de membro superior capaz de auxiliar na recuperação das habilidades motoras e funcionais após uma lesão medular. Como consequência, o engajamento mais independentemente em atividades de vida diária, de lazer, vocacionais, promovendo maior reintegração social, melhorando a autoestima e qualidade de vida de pessoas com deficiência. Além disso, o estudo irá contribuir para o melhor entendimento do uso de dispositivos híbridos na reabilitação motora e funcional de membro superior, sendo úteis para o desenvolvimento de novas formas de tratamento, recuperação de lesões e novos produtos.

Comentários e Considerações sobre a Pesquisa:

- 1) O projeto possui coparticipante
- 2) Pesquisadora responsável é pós-doutoranda na Universidade de Montpellier na França
- 3) No Projeto Básico é especificada previsão de gastos para este projeto
- 4) Não há pedido de dispensa do TCLE
- 5) A população desta pesquisa será constituída por indivíduos com idade igual ou superior a 18 anos com diagnóstico de lesão alta da medula espinhal (tetraplegia), classificados como grau A ou B segundo a American Spinal Injury Association Impairment Scale (ASIA);

Considerações sobre os Termos de apresentação obrigatória:

INFORMAÇÕES_BÁSICAS_DO_PROJETO_

INRIA_english.pdf

Carta_resposta

Carta_INRIA

TCLE

Conclusões ou Pendências e Lista de Inadequações:

Somos, S.M.J favoráveis à aprovação do projeto uma vez que todas as pendências apontadas pelo CEP foram superadas e solicitações atendidas.

Endereço: Av. Presidente Antonio Carlos, 6627 ç 2º. Andar ç Sala 2005 ç Campus Pampulha

Bairro: Unidade Administrativa II **CEP:** 31.270-901

UF: MG **Município:** BELO HORIZONTE

Telefone: (31)3409-4592

E-mail: coep@prpq.ufmg.br

UNIVERSIDADE FEDERAL DE
MINAS GERAIS



Continuação do Parecer: 5.517.869

Considerações Finais a critério do CEP:

Tendo em vista a legislação vigente (Resolução CNS 466/12), o CEP-UFMG recomenda aos Pesquisadores: comunicar toda e qualquer alteração do projeto e do termo de consentimento via emenda na Plataforma Brasil, informar imediatamente qualquer evento adverso ocorrido durante o desenvolvimento da pesquisa (via documental encaminhada em papel), apresentar na forma de notificação relatórios parciais do andamento do mesmo a cada 06 (seis) meses e ao término da pesquisa encaminhar a este Comitê um sumário dos resultados do projeto (relatório final).

Este parecer foi elaborado baseado nos documentos abaixo relacionados:

Tipo Documento	Arquivo	Postagem	Autor	Situação
Informações Básicas do Projeto	PB_INFORMAÇÕES_BÁSICAS_DO_PROJETO_1856932.pdf	04/07/2022 06:15:23		Aceito
Solicitação registrada pelo CEP	CARTA_RESPOSTA.pdf	04/07/2022 06:14:55	FERNANDA MARCIA RODRIGUES FERREIRA LOPES	Aceito
Declaração de Instituição e Infraestrutura	INRIA_English.pdf	28/06/2022 10:27:54	FERNANDA MARCIA RODRIGUES FERREIRA LOPES	Aceito
Declaração de Instituição e Infraestrutura	carta_INRIA.pdf	28/06/2022 10:27:43	FERNANDA MARCIA RODRIGUES FERREIRA LOPES	Aceito
TCLE / Termos de Assentimento / Justificativa de Ausência	TCLE.pdf	28/06/2022 10:25:20	FERNANDA MARCIA RODRIGUES FERREIRA LOPES	Aceito
Projeto Detalhado / Brochura Investigador	Projeto_Detalhado.docx	09/03/2022 07:30:26	FERNANDA MARCIA RODRIGUES FERREIRA LOPES	Aceito
Parecer Anterior	Parecer_Validacao_de_um_conceito_de_ortese_motorizada_de_punho_e_mao.pdf	26/11/2021 11:38:03	FERNANDA MARCIA RODRIGUES FERREIRA LOPES	Aceito
Folha de Rosto	folhaDeRosto_Projeto_Orteses.pdf	25/11/2021 12:43:37	FERNANDA MARCIA RODRIGUES FERREIRA LOPES	Aceito

Situação do Parecer:

Aprovado

Necessita Apreciação da CONEP:

Não

Endereço: Av. Presidente Antonio Carlos, 6627 ç 2º. Andar ç Sala 2005 ç Campus Pampulha
Bairro: Unidade Administrativa II **CEP:** 31.270-901
UF: MG **Município:** BELO HORIZONTE
Telefone: (31)3409-4592 **E-mail:** coep@prpq.ufmg.br

UNIVERSIDADE FEDERAL DE
MINAS GERAIS



Continuação do Parecer: 5.517.869

BELO HORIZONTE, 08 de Julho de 2022

Assinado por:
Críssia Carem Paiva Fontainha
(Coordenador(a))

Endereço: Av. Presidente Antonio Carlos, 6627 e 2º. Andar e Sala 2005 e Campus Pampulha
Bairro: Unidade Administrativa II **CEP:** 31.270-901
UF: MG **Município:** BELO HORIZONTE
Telefone: (31)3409-4592 **E-mail:** coep@prpq.ufmg.br

B.2.d Blank forms

APPENDIX I

ELIGIBILITY ASSESSMENT

I- IDENTIFICATION ET DONNEES DEMOGRAPHIQUES

INFORMATIONS PERSONNELLES :

Évaluateur :

Participant :

Accompagnant :

Date : ____ / ____ / ____

Téléphone :

Email :

Sexe : () F () M

Date de naissance : ____ / ____ / ____

Âge :

Scolarité :

Profession :

Type d'handicap :

Date de lésion :

Niveau de lésion :

Temps de l'évolution :

Lésion : () complète () incomplète

AIS-score :

Main dominante :

Médicaments utilisés :

Pathologies associées :

() HAS non contrôlée

() implant métallique dans les membres supérieurs

() problèmes cardiaques (infarctus du myocarde dans les 12 mois)

() problème de vision

() convulsions non contrôlées (épisode dans les 3 mois)

() problème orthopédique et/ou rhumatologique

() arythmie

() antécédents de dysréflexie autonome significative - prend des médicaments

() utilisation d'un pacemaker

() tumeur cancéreuse dans la zone de stimulation électrique

() maladie musculaire

() fracture non cicatrisée dans le membre supérieur

() grossesse

Avez-vous déjà utilisé ou utilisez-vous actuellement des orthèses et/ou des dispositifs d'assistance ? ()

Observations :

oui () non

... des orthèses motorisées ? () oui () non

Observations :

... de SEF () oui () non

Quand ?

... du Botox () oui () non

Quand ?

II- EXAMEN PHYSIQUE

Amplitude de mouvement passive :	
Poignet :	
Doigts :	
Pouce :	
Coude :	
Tonus : (Modified Ashworth Scale <3)	
0 = pas d'augmentation du tonus musculaire	() fléchisseurs des doigts
1 = légère augmentation du tonus musculaire, manifestée par une contraction et une relaxation ou par une résistance minimale à la fin du mouvement.	() extenseurs des doigts
1+ = contraction associée à une résistance minimale pendant le reste (moins de la moitié) de l'amplitude de mouvement.	() fléchisseurs du pouce
2 = augmentation plus prononcée du tonus musculaire pendant la plus grande partie de l'ADM, mais le mouvement passif est facilement réalisé.	() extenseurs du pouce
3 = augmentation considérable du tonus musculaire et le mouvement passif est réalisé avec difficulté.	() fléchisseurs du poignet
4 = articulation affectée rigide en flexion ou en extension.	() extenseurs du poignet
Douleur (Visual Analogue Scale <8)	
Doigts :	
Pouce :	
Poignet :	
Contractilité de stimulation : assurer la contractilité sous électrostimulation.	
<ul style="list-style-type: none"> Amplitude : niveau maximal tolérable jusqu'à 60 mA - durée de l'impulsion de 300 µs, 	() doigts
<ul style="list-style-type: none"> Fréquence de 25 Hz. 	() pouce
	() poignet
Tolérance de stimulation : assurer la tolérance à l'électrostimulation.	
Configurations	() doigts
<ul style="list-style-type: none"> Amplitude : niveau maximal tolérable jusqu'à 60 mA - durée de l'impulsion de 300 µs, 	() pouce
<ul style="list-style-type: none"> Fréquence de 25 Hz. 	() poignet
Tonus ou spasmes (Penn Spasm Frequency Score (PSFS))	
0 = Pas de spasmes	() doigts
1 = Spasmes induits par stimulation	() pouce
2 = Spasmes se produisant moins d'une fois par heure	() poignet
3 = Spasmes se produisant plus d'une fois par heure	
4 = Spasmes se produisant plus de 10 fois par heure	
Inspection de la peau	
Lésions ouvertes :	
Peau dévitalisée :	

Observations :

**APPENDIX III
CHECKLIST**

Session	Concluded
Patient:	
Session 1 - Eligibility Assessment (2h)	Date:
1. Welcome of the participants (10 min): explanation of the objectives of the protocol and the course of the tests sessions	()
2. Collection of information from the participants and verification of eligibility criteria (Appendix I) (40 min)	()
3. Muscle mapping (30 min): Mapping of the muscle motor point, fixed electrodes and take photo and mark with pen 1) extensor digitorum 2) flexor digitorum superficialis 3) thenar eminence muscles (opponens pollicis muscle; flexor pollicis brevis muscle; abductor pollicis brevis muscle). Taking photo Marking with pen Establish the stimulation parameters based on each participant's threshold. Parameters: Intensity _____ mA (<60), pulse duration _____ μ s, frequency _____ Hz	() () () () ()
4. Familiarizing with FES (with objects and with button) (15 min) repetitions- as many times as necessary Open Hand Close Hand Hold Bottle (open, close, and open): Hold Ball (open, close, and open): Hold Fork (open, close, and open):	() () () () ()
5. Familiarizing with FES + Aufratech (with objects and with button) (15 min) repetitions- as many times as necessary Open Hand Close Hand Hold Bottle (open, close, and open) Hold Ball (open, close, and open) Hold Fork (open, close, and open)	() () () () ()
6. Reading and signing of the Free and Informed Consent Form (Appendix II) (10min)	()
Comments:	

Session 2 - Only FES (1h30 – 2h)	Date:
1. Welcome of the participants (5 min): detailed explanation of the test procedures	()
2. Installation of the participants (5 min): (table and arm support)	()
3. Placement of the stimulation electrodes (5 min): Look at the photo and the mark of the electrode location Parameters: Intensity _____ mA (<60), pulse duration _____ μ s, frequency _____ Hz	()
4. Task Training (30 min): forearm in a neutral position. 5 repetitions each movement. 2s rest between each repetition and 2 min between each object. It is not necessary hold the object for a long time (time is not important)	()
Tennis Ball	()
Tennis Ball	()
Tennis Ball	()
Tennis Ball	()
Tennis Ball	()
Fork adapted with thickener	()
Fork adapted with thickener	()
Fork adapted with thickener	()
Fork adapted with thickener	()
Fork adapted with thickener	()
Water Bottle	()
Water Bottle	()
Water Bottle	()
Water Bottle	()
Water Bottle	()
5. Evaluations (45 min): forearm in a neutral position. - 5 repetitions each movement. Hold 30s. Rest 30s between each repetition and 2 min between each object. - 5 min rest (or more) every 20 min. - Random order to minimize systematic errors due to learning or fatigue. - The participant picks up the object, placed in front of him, holds it up in the air, then places it back on the table/support	()
1.Tennis Ball	()
2.Tennis Ball	()
3.Tennis Ball	()
1.Fork	()
2.Fork	()
3.Fork	()
1.Water Bottle	()
2.Water Bottle	()
3.Water Bottle	()

EVALUATION OF THE PERFORMANCE FUNCTIONAL									
Test	Task	Sub-action							Mean Score (SD)
		Reach target	Open hand	Grasp object	Keep Position	Open hand	Return to table	Go back to rest	
1	Tennis ball								
2	Tennis ball								
3	Tennis ball								
1	Fork								
2	Fork								
3	Fork								
1	Water bottle								
2	Water bottle								
3	Water bottle								

Legenda: 0 unsuccessful; 1 acceptable; 2 successful

TIME OF THE PERFORMANCE FUNCTIONAL				
Test	Task	Time to sustain the palmar grasp	Time that evidenced fatigue	Time the object dropped
1	Tennis ball			
2	Tennis ball			
3	Tennis ball			
1	Fork			
2	Fork			
3	Fork			
1	Water bottle			
2	Water bottle			
3	Water bottle			

EVALUATION OF THE INTENSITY OF PHYSICAL EFFORT (BORG)		
1	Tennis ball	()
2	Tennis ball	()
3	Tennis ball	()
1	Fork	()
2	Fork	()
3	Fork	()
1	Water bottle	()
2	Water bottle	()
3	Water bottle	()

ASSESSMENT OF THE OCCURRENCE OF PAIN:		
1	Tennis ball	()
2	Tennis ball	()
3	Tennis ball	()
1	Fork	()
2	Fork	()
3	Fork	()
1	Water bottle	()
2	Water bottle	()
3	Water bottle	()
		()
6. Removing the electrodes (3 min)		
7. Checking skin integrity (2 min) If necessary, use Visual Analog Scale (VAS)		()
8. Thanking the participants (2 min)		()
Comments:		

Session 3 – Hybrid Orthosis (2h):	Date:
1. Welcome of the participants (5 min): detailed explanation of the test procedures	()
2. Installation of the participants (5 min): (table and arm support)	()
3. Placement of the stimulation electrodes (5 min): Look at the photo and the mark of the electrode location Parameters: Intensity _____ mA (<60), pulse duration _____ μ s, frequency _____ Hz	()
4. Installation of the Aufratech orthosis (20 min): will be attached on the participants' right upper limb by experimenters and will be checked for anatomical adjustments. Time: _____ Fix: _____, Adjust: _____, Configure: _____ Discomfort: () oui () non	() () ()
5. Task Training (30 min): forearm in a neutral position. 5 repetitions each movement. 2s rest between each repetition and 2 min between each object. It is not necessary hold the object for a long time (time is not important) 1.Tennis Ball 2.Tennis Ball 3.Tennis Ball 1.Fork 2.Fork 3.Fork 1.Water Bottle 2.Water Bottle 3.Water Bottle	() () () () () () () () ()
6. Evaluations (45 min): forearm in a neutral position. - 3 repetitions each movement. Hold 30s. Rest 30s between each repetition and 2 min between each object. - 5 min rest (or more) every 20 min. - Random order to minimize systematic errors due to learning or fatigue. - The participant picks up the object, placed in front of him, holds it up in the air, then places it back on the table/support 1.Tennis Ball 2.Tennis Ball 3.Tennis Ball 1.Fork 2.Fork 3.Fork 1.Water Bottle 2.Water Bottle 3.Water Bottle	() () () () () () () () () ()

EVALUATION OF THE PERFORMANCE FUNCTIONAL									
Test	Task	Sub-action							Mean Score (SD)
		Reach target	Open hand	Grasp object	Keep Position	Open hand	Return to table	Go back to rest	
1	Tennis ball								
2	Tennis ball								
3	Tennis ball								
1	Fork								
2	Fork								
3	Fork								
1	Water bottle								
2	Water bottle								
3	Water bottle								

Legenda: 0 unsuccessful; 1 acceptable; 2 successful

TIME OF THE PERFORMANCE FUNCTIONAL				
Test	Task	Time to sustain the palmar grasp	Time that evidenced fatigue	Time the object dropped
1	Tennis ball			
2	Tennis ball			
3	Tennis ball			
1	Fork			
2	Fork			
3	Fork			
1	Water bottle			
2	Water bottle			
3	Water bottle			

EVALUATION OF THE INTENSITY OF PHYSICAL EFFORT (BORG)		
1	Tennis ball	()
2	Tennis ball	()
3	Tennis ball	()
1	Fork	()
2	Fork	()
3	Fork	()
1	Water bottle	()
2	Water bottle	()
3	Water bottle	()

ASSESSMENT OF THE OCCURRENCE OF PAIN:		
1	Tennis ball	()
2	Tennis ball	()
3	Tennis ball	()
1	Fork	()
2	Fork	()
3	Fork	()
1	Water bottle	()
2	Water bottle	()
3	Water bottle	()
7. Free Tasks (10 min)		
Activity of daily living (drink from a water bottle).		()
8. Evaluation of satisfaction with the device:		
QUEST		()
SUS		()
Feedback		()
9. Removing the motorized orthosis (5 min)		
Time: _____, Fix: _____, Adjust: _____, Configure: _____		()
		()
9. Checking skin integrity (2 min): If necessary, use Visual Analog Scale (VAS)		()
10. Thanking the participants (2 min)		()
Comments:		

Session 4 - Only FES (1h30 – 2h)	Date:
1. Welcome of the participants (5 min): detailed explanation of the test procedures	()
2. Installation of the participants (5 min): (table and arm support)	()
3. Placement of the stimulation electrodes (5 min): Look at the photo and the mark of the electrode location Parameters: Intensity _____ mA (<60), pulse duration _____ μ s, frequency _____ Hz	()
4. Task Training (20 min): forearm in a neutral position. 5 repetitions each movement. 2s rest between each repetition and 2 min between each object. It is not necessary hold the object for a long time (time is not important)	()
Tennis Ball	()
Tennis Ball	()
Tennis Ball	()
Tennis Ball	()
Tennis Ball	()
Fork adapted with thickener	()
Fork adapted with thickener	()
Fork adapted with thickener	()
Fork adapted with thickener	()
Fork adapted with thickener	()
Water Bottle	()
Water Bottle	()
Water Bottle	()
Water Bottle	()
Water Bottle	()
5. Evaluations (45 min): forearm in a neutral position. - 5 repetitions each movement. Hold 30s. Rest 30s between each repetition and 2 min between each object. - 5 min rest (or more) every 20 min. - Random order to minimize systematic errors due to learning or fatigue. - The participant picks up the object, placed in front of him, holds it up in the air, then places it back on the table/support	()
1.Tennis Ball	()
2.Tennis Ball	()
3.Tennis Ball	()
1.Fork	()
2.Fork	()
3.Fork	()
1.Water Bottle	()
2.Water Bottle	()
3.Water Bottle	()

EVALUATION OF THE PERFORMANCE FUNCTIONAL									
Test	Task	Sub-action							Mean Score (SD)
		Reach target	Open hand	Grasp object	Keep Position	Open hand	Return to table	Go back to rest	
1	Tennis ball								
2	Tennis ball								
3	Tennis ball								
1	Fork								
2	Fork								
3	Fork								
1	Water bottle								
2	Water bottle								
3	Water bottle								

Legenda: 0 unsuccessful; 1 acceptable; 2 successful

TIME OF THE PERFORMANCE FUNCTIONAL				
Test	Task	Time to sustain the palmar grasp	Time that evidenced fatigue	Time the object dropped
1	Tennis ball			
2	Tennis ball			
3	Tennis ball			
1	Fork			
2	Fork			
3	Fork			
1	Water bottle			
2	Water bottle			
3	Water bottle			

EVALUATION OF THE INTENSITY OF PHYSICAL EFFORT (BORG)		
1	Tennis ball	()
2	Tennis ball	()
3	Tennis ball	()
1	Fork	()
2	Fork	()
3	Fork	()
1	Water bottle	()
2	Water bottle	()
3	Water bottle	()

ASSESSMENT OF THE OCCURRENCE OF PAIN:		
1	Tennis ball	()
2	Tennis ball	()
3	Tennis ball	()
1	Fork	()
2	Fork	()
3	Fork	()
1	Water bottle	()
2	Water bottle	()
3	Water bottle	()
Feedback		()
6. Removing the electrodes 35 min)		()
7. Checking skin integrity (2 min): If necessary, use Visual Analog Scale (VAS)		()
points on the skin		()
redness		()
discomfort		()
tingling		()
paresthesia		()
discomfort		()
8. Thanking the participants (2 min)		()
Comments:		

Borg Rating of Perceived Exertion Scale

6	No exertion at all
7	Extremely light
8	Very light
9	Light
10	Light
11	Light
12	Light
13	Somewhat hard
14	Somewhat hard
15	Hard (heavy)
16	Hard (heavy)
17	Very hard
18	Very hard
19	Extremely hard
20	Maximal exertion

© Gunnar Borg, 1970, 1985, 1998

Visual Analogue Scale

Orientação para a utilização da Escala Analógica Visual

Após a leitura da régua de 10 cm, onde a marca da esquerda representa ausência de dor e a marca da direita representa a pior dor suportável, marque com um ponto ao longo da linha vertical o local que melhor identifique a sua dor.

Escala Analógica Visual

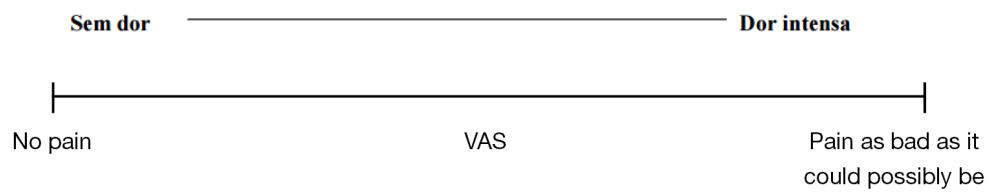

Visual Analogue Scale – Faces

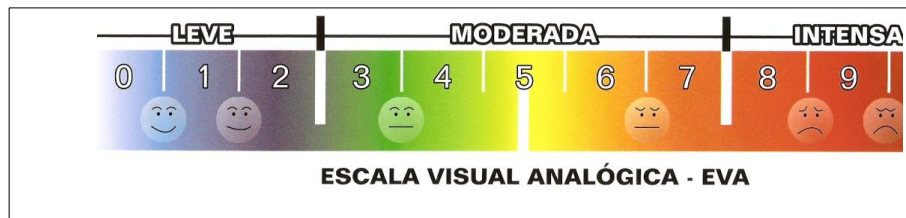

**QUEBEC USER EVALUATION OF SATISFACTION WITH ASSISTIVE
TECHNOLOGY (QUEST 2.0)**

Évaluation de la Satisfaction envers une Aide Technique

ÉSAT (Version 2.0)

Aide technique: _____

Nom de l'utilisateur: _____

Date : _____

Le questionnaire ÉSAT a pour but d'évaluer votre satisfaction envers votre aide technique et les services qui y sont rattachés. Le questionnaire comprend 12 énoncés de satisfaction.

- Pour chacun des 12 énoncés, nous vous demandons d'indiquer votre degré de satisfaction sur une échelle de 1 à 5.

1	2	3	4	5
Pas satisfait(e) du tout	Peu satisfait(e)	Plus ou moins satisfait(e)	Assez satisfait(e)	Très satisfait(e)

- Encerclez le chiffre qui décrit le mieux votre degré de satisfaction pour chacune des 12 énoncés.
- S'il-vous-plaît, répondez à toutes les questions.
- Si vous n'êtes pas tout à fait satisfait(e) de certains aspects mentionnés dans les questions, inscrivez vos commentaires dans l'espace prévu.

Merci.

APPENDIX IX**SYSTEM USABILITY SCALE (SUS)**

Note entre 1 et 5 (1 pas du tout d'accord et 5 tout à fait d'accord)

1. Je pense que je vais utiliser le dispositif grasphyb fréquemment
2. Je pense que le dispositif grasphyb est inutilement complexe
3. Je pense que le dispositif grasphyb était facile d'utilisation
4. Je pense que je vais devoir faire appel à l'aide d'un tiers pour pouvoir utiliser le
5. Je pense que les fonctionnalités du dispositif grasphyb sont bien exploitées
6. Je pense qu'il y a beaucoup trop d'incohérences dans le dispositif grasphyb
7. Je pense que la plupart des gens apprendront très rapidement à utiliser le dispositif grasphyb
8. Je pense que le dispositif grasphyb est vraiment très lourd à utiliser
9. Je me suis senti très confiant en utilisant le dispositif grasphyb
10. J'ai dû apprendre beaucoup de choses avant de pouvoir utiliser le dispositif grasphyb

FEEDBACK :

