



HAL
open science

Clinical Laboratory Optimization

Sohrab Faramarzi Oghani

► **To cite this version:**

Sohrab Faramarzi Oghani. Clinical Laboratory Optimization. Operations Research [math.OC]. Université Lille 1 - Sciences et Technologies, 2018. English. NNT: . tel-02005590

HAL Id: tel-02005590

<https://inria.hal.science/tel-02005590>

Submitted on 4 Feb 2019

HAL is a multi-disciplinary open access archive for the deposit and dissemination of scientific research documents, whether they are published or not. The documents may come from teaching and research institutions in France or abroad, or from public or private research centers.

L'archive ouverte pluridisciplinaire **HAL**, est destinée au dépôt et à la diffusion de documents scientifiques de niveau recherche, publiés ou non, émanant des établissements d'enseignement et de recherche français ou étrangers, des laboratoires publics ou privés.

Thèse présentée pour obtenir le grade de docteur

Université de Lille

Faculté des Sciences et Technologies
École doctorale Sciences pour l'ingénieur (SPI)

Discipline : Informatique et applications

Clinical Laboratory Optimization

Par : **Sohrab Faramarzi Oghani**

Date de soutenance : le **17 Décembre 2018**

Membres du jury :

Monsieur El-Ghazali Talbi, Directeur de thèse

Professeur, Université de Lille & Inria, France

Monsieur Yves Crama, Rapporteur

Professeur, Université de Liège, Belgique

Madame Alice Yalaoui, Rapporteur

Maître de conférence-HDR, Université de Technologie de Troyes, France

Madame Greet Vanden Berghe, Examinatrice

Professeur, Katholieke Universiteit Leuven, Belgique

Monsieur David Duvivier, Examineur, Président du jury

Professeur, Université Polytechnique Hauts-de-France, France

Monsieur Eric Varlet, Membre invité

PhD, Beckman Coulter Company, France

Abstract

This thesis focuses on the optimization of clinical laboratory design and operating decisions. A clinical laboratory is an organization gathering human and machinery resources to analyze blood samples. In this thesis, a decision support tool including mathematical models, a heuristic algorithm and a customized simulation model is developed to aid decision makers for the main strategic, tactical and operational problems in clinical laboratory design and operations management. This decision support tool follows a top-down stepwise framework starting from strategic problems and ending with operational ones, including a recursive loop for modification and improvement. In this thesis, machine selection and facility layout are studied as the main strategic problems, analyzer configuration as the tactical problem, and assignment, aliquoting and scheduling as the principal operational problems. In order to deal with the machine selection problem for a clinical laboratory, a mathematical model is proposed which aids to select the most appropriate machines to equip the system. To tackle the physical arrangement of instruments within the laboratory area, a heuristic approach is developed. The proposed heuristic comprises the key constraints of laboratory layout design. To address the analyzer configuration problem which mainly deals with the assignment of chemical materials to the analyzers in a clinical laboratory, a bi-objective mathematical model is developed. In addition, to determine an efficient assignment of sample tubes to the analyzers, a mathematical model with three objectives is proposed. A customized, flexible, and fine-grained simulation model is developed in FlexSim to study the clinical laboratory designed through the outputs of developed mathematical models and layout algorithm. Simulation model plays a key role in the proposed framework as it is used for many purposes. The simulation model helps the designer to construct and analyze a complete clinical laboratory taking into account all major features of the system. This simulation attribute provides the ability to scrutinize the system behaviour and to find out whether the designed system is efficient. System performance analysis through simulation and resulting key performance indicators give helpful feedback for system improvement. Furthermore, the simulation model can be fruitful to decide on scheduling, aliquoting and staffing problems through the evaluation of various scenarios proposed by the decision maker for each of these problems. To verify the validity of the proposed framework, data extracted from a real case is used. The output results seal on the applicability and the efficiency of the proposed framework as well as competency of proposed techniques to deal with each optimization problem. To the best of our knowledge, this thesis is one of the leading studies on the optimization of clinical laboratories.

Keywords: Clinical laboratory, optimization, machine selection problem, facility layout problem, analyzer configuration problem, assignment problem, aliquoting problem, scheduling problem, mathematical modeling, heuristic algorithm, computer simulation, FlexSim.

To

My sweetheart, Parisa

My parents, Maman and Baba

My brother, Saeed

My grand-parents

All my family members, friends, teachers, and

My loneliness

Acknowledgment

Finally, the last section of my thesis came, the hardest but the sweetest!

I would like to express my sincere gratitude to my supervisor Prof. El-Ghazali Talbi for his continuous support and invaluable guidance and also, for providing a pleasant working environment during three years. I learnt a lot from him and always enjoyed working with him.

I would like to express my special appreciation to Dr. Eric Varlet for sharing his invaluable knowledge and experiences on clinical laboratories during three years. We always put our minds together to solve a problem. Thanks for always pushing me to be the best I can be.

I would like to thank my jury members: Prof. Yves Crama, Dr. Alice Yalaoui, Pr. Greet Vanden Berghe, and Prof. David Duvivier for reviewing my thesis and their insightful comments and critics.

I'm grateful to my colleagues in BONUS (previously DOLPHIN) and INOCS teams, specially to Martin Bué for his support, sympathy and cooperation during three years. I also would like to thank Othman Touijer for his valuable contributions on simulation aspect of this project.

I also would like to take this opportunity to thank my wife, Parisa, for her kind and endless support and encouragement. Thanks for having my back!

Last but not least, I would like to thank my parents, my brother, my grand-parents and all my family members and friends and of course my teachers.

Table of Contents

Chapter 1: Introduction to Clinical Laboratory Optimization	1
1.1. Introduction to clinical laboratory optimization project	2
1.1.1. Motivation and significance	2
1.1.2. Project foundation and research collaboration	2
1.2. Introduction to clinical laboratory organization	3
1.2.1. Terminology	3
1.2.2. Clinical laboratory structure	4
1.2.3. Patient sample workflow: from sample collection to tests result preparation	5
1.3. Introduction to clinical laboratory main decision problems	9
1.4. Application of operations research in clinical laboratory optimization: a survey	11
1.5. Proposed framework for clinical laboratory optimization	12
1.6. Sources of information and case study	14
1.6.1. Case study	15
1.7. Data management	16
1.8. Thesis main contributions	17
1.9. Thesis structure	17
Chapter 2: Machine Selection Problem for Clinical Laboratories.....	19
2.1. Introduction to machine selection problem in industries	20
2.2. Machine selection for clinical laboratories	24
2.3. Proposed mathematical model	25
2.3.1. Definitions and problem assumptions	25
2.3.2. Notations	27
2.3.3. Mathematical model	29
2.4. Model variation.....	30
2.4.1. Multi-part analyzers (Multi-discipline analyzers)	30
2.5. Model decomposition	33
2.6. Model validation	34
2.6.1. Description of the case study.....	34
2.6.2. Numerical results.....	35
2.7. Conclusion	36
Chapter 3: Facility Layout Problem for Clinical Laboratories.....	38
3.1. Introduction and literature review.....	39
3.1.1. FLP variations	39
3.1.1.1. System characteristics impacting the FLP.....	39

3.1.1.2. Static vs. dynamic FLP.....	41
3.1.1.3. Discrete vs. continuous FLP.....	41
3.1.1.4. Single-objective vs. multi-objective FLP.....	42
3.1.2. Modeling approaches for the FLP.....	42
3.1.3. Resolution approaches for the FLP.....	44
3.2. Facility layout design for clinical laboratories with a standalone sorter.....	47
3.2.1. Definitions and problem assumptions.....	47
3.2.1.1. Laboratory area-related definitions and assumptions.....	47
3.2.1.2. Facility-related definitions and assumptions.....	48
3.2.2. Objective function.....	48
3.2.3. Problem constraints.....	49
3.3. Resolution approach.....	49
3.3.1. Generation of initial solutions.....	50
3.3.1.1. Facility sorting.....	50
3.3.1.2. Facility placement.....	50
3.3.2. Selection of diverse solutions.....	53
3.3.3. Improvement of the selected solutions.....	53
3.4. Experimental results.....	54
3.5. Conclusion.....	57

Chapter 4: Analyzer Configuration Problem for Clinical Laboratories..... 59

4.1. Introduction.....	60
4.2. Analyzer configuration problem.....	61
4.3. First proposed mathematical model.....	61
4.3.1. Assumptions.....	62
4.3.2. Notations.....	63
4.3.3. Mathematical formulation.....	65
4.4. Model variations.....	54
4.4.1. Analyzer configuration problem with reagent disposal minimization.....	66
4.4.2. Analyzer configuration problem with multi suppliers.....	66
4.5. Second proposed mathematical model.....	68
4.5.1. Assumptions.....	69
4.5.2. Notations.....	70
4.5.3. Mathematical formulation.....	72
4.6. Resolution approach and computational results.....	73
4.6.1. Solution procedure.....	73
4.6.2. Case study and numerical results.....	74
4.7. Conclusion.....	77

Chapter 5: Operational Problems of Clinical Laboratories	78
5.1. General introduction to operational problems in clinical laboratories.....	79
5.2. Assignment problem for clinical laboratories.....	79
5.2.1. Introduction to the assignment problem.....	79
5.2.1.1. The classic assignment problem.....	80
5.2.1.1.1. Mathematical model.....	80
5.2.1.1.2. Graph model.....	80
5.2.1.2. The generalized assignment problem (GAP).....	81
5.2.2. Assignment problem description for clinical laboratories.....	82
5.2.3. Proposed mathematical model.....	82
5.2.3.1. Assumptions.....	84
5.2.3.2. Notations.....	85
5.2.3.3. Mathematical formulation.....	87
5.2.3. Resolution approach and computational results.....	91
5.3. Aliquoting problem for clinical laboratories.....	94
5.3.1. Introduction to the aliquoting problem.....	94
5.3.2. Proposed global frameworks for the aliquoting problem.....	96
5.3.2.1. First proposed framework for the aliquoting problem.....	96
5.3.2.2. Second proposed framework for the aliquoting problem.....	98
5.4. Scheduling problem for clinical laboratory.....	99
5.4.1. Introduction to the scheduling problem.....	99
5.4.1.1. Scheduling theory vs. scheduling practice.....	101
5.4.1.2. Widely used approaches for the scheduling problems in practice.....	101
5.4.1.2.1. Dispatching rules.....	102
5.4.2. Description of the clinical laboratory scheduling problem.....	102
5.4.3. Proposed approach for the clinical laboratory scheduling problem.....	104
5.5. Conclusion.....	104
Chapter 6: Clinical Laboratory Simulation Modeling and Analysis	106
6.1. Introduction to computer simulation.....	107
6.1.1. Types of simulation models.....	107
6.1.2. Important concepts in simulation studies.....	108
6.1.3. How to conduct a successful simulation model?.....	109
6.2. Toward a customized environment for clinical laboratory simulation modeling.....	111
6.2.1. Customized simulation environment main characteristics.....	112
6.3. Clinical laboratory simulation modeling.....	113
6.3.1. General standalone clinical laboratory workflow.....	113
6.3.2. Simulation model inputs and assumptions.....	117

6.3.2.1. Measurement units	117
6.3.2.2. System components.....	118
6.3.2.2.1. System components: facilities.....	118
6.3.2.2.2. System components: operators	122
6.3.2.3. System entities	124
6.3.2.4. System layout.....	125
6.3.2.5. Assignment, aliquoting and scheduling in clinical laboratory	125
6.3.2.6. Other assumptions	125
6.3.3. Key performance indicators (KPIs).....	126
6.3.4. Simulation model in FlexSim.....	126
6.4. Simulation output results	129
6.5. Conclusion	138
Chapter 7: General Conclusion and Future Perspectives	140
7.1. General conclusion	141
7.2. Future perspectives	142
7.3. List of publications and scientific productions	144
References.....	145

List of Tables

1-1. Main sources of information used for data extraction in each step of the project	15
1-2. Statistical status of the tests requested by each class of tubes in the case study.....	15
2-1. Notations used in the proposed mathematical model	27
2-2. Modifications required to add multi-part analyzers.....	31
2-3. Numerical results.....	35
3-1. All clinical laboratory instruments	55
4-1. Notations used in the first proposed mathematical model.....	63
4-2. Modifications required to build the multi-supplier analyzer configuration model	67
4-3. Notations used in the second proposed mathematical model	70
4-4. Extreme values of each objective function.....	75
4-5. Value of objective functions under different importance factors	76
4-6. A portion of analyzer configuration solution.....	76
5-1. Notations used in the proposed mathematical model	85
5-2. Extreme values of each objective function.....	91
5-3. Values of objective functions under different sets of importance factors	92
5-4. Assignment of tubes to the analyzers	92
5-5. Assignment of tubes' tests to the analyzers.....	93
5-6. Assignment output results.....	93
6-1. Clinical laboratory instruments.....	118
6-2. The number and duties of operators in the clinical laboratory	123
6-3. A portion of raw data extracted from a simulation run.....	132
6-4. A portion of the main clinical laboratory KPIs.....	133
6-5. A portion of the main clinical laboratory KPIs for dynamic tube arrival.....	137

List of Figures

1-1. Clinical laboratory network	5
1-2. Schematic of patient sample flow	8
1-3. Main steps of operations in examination site.....	8
1-4. Clinical laboratory main design and planning decision problems	10
1-5. Procedure applied to tackle optimization problems.....	13
1-6. Proposed framework for efficient CL design	14
1-7. Control panel of the developed Excel-based tool for data management	16
2-1. Equipment selection problem resolution approaches	24
2-2. Example of an analyzer with two parts and useful notations.....	31
2-3. Model decomposition procedure	33
2-4. Selected machines to equip the clinical laboratory.....	36
3-1. Regular and irregular facility shapes	40
3-2. (a) Flow patterns and FLP. (b) Facility pick-up and drop-off locations. (c) backtracking and bypassing	41
3-3. Multi-floor layout	41
3-4. Euclidean and rectilinear norms	42
3-5. Facility layout problem representation tree	46
3-6. Example of a laboratory area.....	47
3-7. Illustration of facility placement via the proposed algorithm.....	51
3-8. Illustration of generating more solutions through considering more potential points in the neighbourhood.	52
3-9. An illustrative example for the tree of possibilities in the placement procedure.....	53
3-10. Laboratory area.....	54
3-11. Laboratory layout design considering entrance $E1$	56
3-12. Laboratory layout design considering entrance $E2$	56
3-13. Final clinical laboratory layout design	57
4-1. Analyzer configuration problem (ACP) in clinical laboratory	60
5-1. A weighted bipartite network for a matching problem with $ N_1 = N_2 = 5$	81
5-2. A feasible solution for the example	81
5-3. Optimal balanced assignment of the illustrative example	84
5-4. Impact of aliquoting on the number of tubes in a clinical laboratory	94
5-5. All possible aliquoting options for the illustrative example	95
5-6. Global scheme of the first proposed approach for the aliquoting problem.	97
5-7. Effect of aliquoting on the assignment output matrices	97
5-8. Global picture of the second proposed framework for the aliquoting problem.	98
5-9. Gantt chart of two jobs on two machines.	99

5-10. Standards used to address a scheduling problem in the literature	100
6-1. Types of simulation models.....	109
6-2. Framework for a successful simulation study	110
6-3. Comparison of simulation software tools	112
6-4. Automate components	116
6-5. General standalone clinical laboratory workflow.....	117
6-6. Registration desk (a) and Rack-making desk for centrifuges (b).	118
6-7. Components of AU480 analyzer modeled in FlexSim.....	120
6-8. Components of AU5822 analyzer modeled in FlexSim.....	121
6-9. Components of DxI600 analyzer modeled in FlexSim.....	122
6-10. Types of flow items used in clinical laboratory simulation modeling.....	124
6-11. Schematic view of general steps to create clinical laboratory simulation model in FlexSim....	128
6-12. Simulation model of the designed clinical laboratory in FlexSim.....	129
6-13. Snapshots of different sections and operations of the running simulation model in FlexSim...	130
6-14. TAT of all tubes in the clinical laboratory.....	133
6-15. Utilization of analyzers in the laboratory	135
6-16. Utilization of operators in the laboratory.....	135
6-17. Waiting times at several queues of the laboratory	136
6-18. Dynamic tube arrival to the laboratory	137

Chapter 1

Introduction to Clinical Laboratory Optimization

1.1. Introduction to clinical laboratory optimization project

1.1.1. Motivation and significance

A clinical analysis laboratory is an organization gathering human and machinery resources to analyze human fluid samples such as blood and urine. These laboratories are noticed as one of the principal and preliminary blocks in health services where most of the medical diagnoses and treatments depend on. Therefore, efficiency and effectiveness of these organizations have straight impact on the performance of other dependent health sectors. Furthermore, reducing operating costs in laboratories decreases the cost of treatment and eventually increases patient satisfaction.

Surveying the current situation of clinical laboratories implies the trend of fusion among these organizations which on one side, decreases the number of clinical laboratories and on the other side, enlarges the magnitude of the emerging laboratories and imposes more tasks to these organizations. This pervasive phenomenon which is mainly the consequence of financial pressures done by reimbursement organizations addresses the clinical laboratories as huge organizations which require profound and precise scientific efforts while designing and planning such complex systems.

Although, a wide number of studies has been carried out to improve and optimize healthcare systems [see (Onar et al., 2018) and (Brailsford and Vissers, 2011)], optimization of clinical laboratories still can be spotted as a virgin domain of research where only a few dispersed studies are observed in the literature of operations research. In addition, a lack of customized and intelligent decision support tool is fully appreciated to aid clinical laboratories (CLs) designers and managers facing strategic, tactical and operational decision problems.

Concluding the above discussion, a need for a smart decision tool is fully appreciated to facilitate the design process of clinical laboratories. Hence, clinical laboratory optimization research project has been launched with the aim to firstly address the principal strategic, tactical and operational problems of clinical laboratories design and planning and secondly, to provide a customized decision support tool to efficiently deal with the identified decision problems.

1.1.2. Project foundation and research collaboration

The clinical laboratory optimization (CLO) research project has been carried out in the BONUS (previously DOLPHIN) research team of Inria Lille-Nord Europe under supervision of Prof. El-Ghazali Talbi.

Originally, the CLO project has been founded by Normand-Info company, a Beckman Coulter subsidiary, to improve CLs performance. Generally, Normand-Info provides information technology (IT) solutions for CLs and Beckman Coulter is a huge international company, mainly manufacturing human biology analyzers and equipment.

1.2. Introduction to clinical laboratory organization

1.2.1. Terminology

In this section, definitions of frequently used terms and phrases in this thesis are briefly expressed.

- **Laboratory information system (LIS)** is used by the laboratory staff to fill in the prescriptions and the information on the sample. LIS transmits orders to the data manager and receives results from it. LIS creates the result forms and transmits them to the ordering physicians and to the patients.
- **Data manager (DM)** is a software that consolidates patient test information from multiple instruments in the laboratory. It enhances the LIS, empowering laboratory personnel to access and manage information from a single workstation. Also, DM offers customized rules where the laboratory personnel expertise could be compiled in order to automate the laboratory workflow. Applying automated rules reduce significantly user actions and decision on each sample or result.
- **Analysis (Test)** is a set of process steps to establish the value or the characteristics of one property. Triglyceride is an example for test.
- **STAT** is the name given to a test with urgent request. It comes from a Latin word '*statim*', which means instantly or immediately.
- **Complementary analysis (Reflex)** is an analysis added to the original prescribed order. They are generally requested when initial analysis results indicate a suspicion of pathology. The complementary analysis allows confirming or refuting the suspected pathology.
- **Rerun** implies to the test repetition. When for any reason, the quality of a result is under question, the same analysis is performed again. It is generally performed on the same instrument, but according to the suspicion, another instrument could be chosen to perform the rerun.
- **Discipline** refers to a set of tests. Immunology, Chemistry, Hematology and Coagulation are some examples for discipline.
- **Prescription (Order)** is a list of analysis prescribed by a physician.
- **Sample (Specimen)** is a portion of fluid drawn from the patient (blood sample, urine sample, etc.) and placed in a tube. A tube could contain adjuvants to allow a better conservation of the sample. The type of tube (according to the adjuvants) is generally materialized by the cap color.
- **Sample delivery** involves packaging and transportation of samples from the drawing sites to the analysis sites. Sample delivery is also used for transportation in-between analysis sites, or when specific analysis is performed by a sub-contractor laboratory.
- **Tube** is a container for specimen of a patient. The terms '*tube*' and '*sample*' are used interchangeably in this thesis.

- **Rack** is a net-like container in which tubes are placed. Generally, racks are used by staff for tube sorting and transportation, and by some machines for processing. Various types of rack exist in a laboratory for different applications.
- **Analyzer** refers to the machines utilized to perform the tests on samples.
- **Registration** is the act of recording prescription and sample information into the LIS. It is also where sample conformity to the requested tests is checked.
- **Centrifugation** is the act of separating blood into its components done by a centrifuge machine.
- **Aliquoting** is the act of making more tubes out of one. Aliquot is a part of the sample drawn from a primary tube and placed in a secondary tube.
- **Reagent** is a chemical substance used by the analyzers to perform tests.

1.2.2. Clinical laboratory structure

In general, a classic clinical laboratory is made of two sites: collection site and examination site. **Collection site** also known as *drawing site*, is a sector of a laboratory which receives patients. Nurses of the laboratory draw samples from the patients. The nature of the samples, the volumes, and the tube types used to collect the samples are defined according to the ordered tests. Each drawn sample is then labelled to be identified later for the next operations. Finally, tubes are packed and delivered to the examination sites. **Examination site** also known as *analysis site*, is an area of the laboratory where instruments are used to prepare and perform tests on samples.

An examination site might serve one or more remote collection sites. In better words, an examination site may receive tubes from several collection sites. Nowadays, due to some cost-related reasons, examination sites are growing and getting bigger to serve more collection sites. This trend is making an examination site as a huge organization where many crucial tasks must be done properly and many decisions must be made efficiently. [Figure 1-1](#) illustrates the emerging network of clinical laboratories where a few examination sites give services to many collection sites.

In this thesis, the main focus is on the examination site. Hereafter, the term '*laboratory*' refers to the examination site. According to the type of material handling system used in a laboratory, three types of clinical laboratory can be identified:

- **Clinical laboratory with standalone sorter** where tubes are transported within the racks by laboratory staff. In this type of laboratories, no automated system is used to convey the rack of tubes.
- **Automated clinical laboratory** where an automation line is used to convey the tubes between different points in the laboratory.
- **Hybrid clinical laboratory** where only some points of the laboratory is connected through automation line and the remaining tube transportations are carried out by personnel.

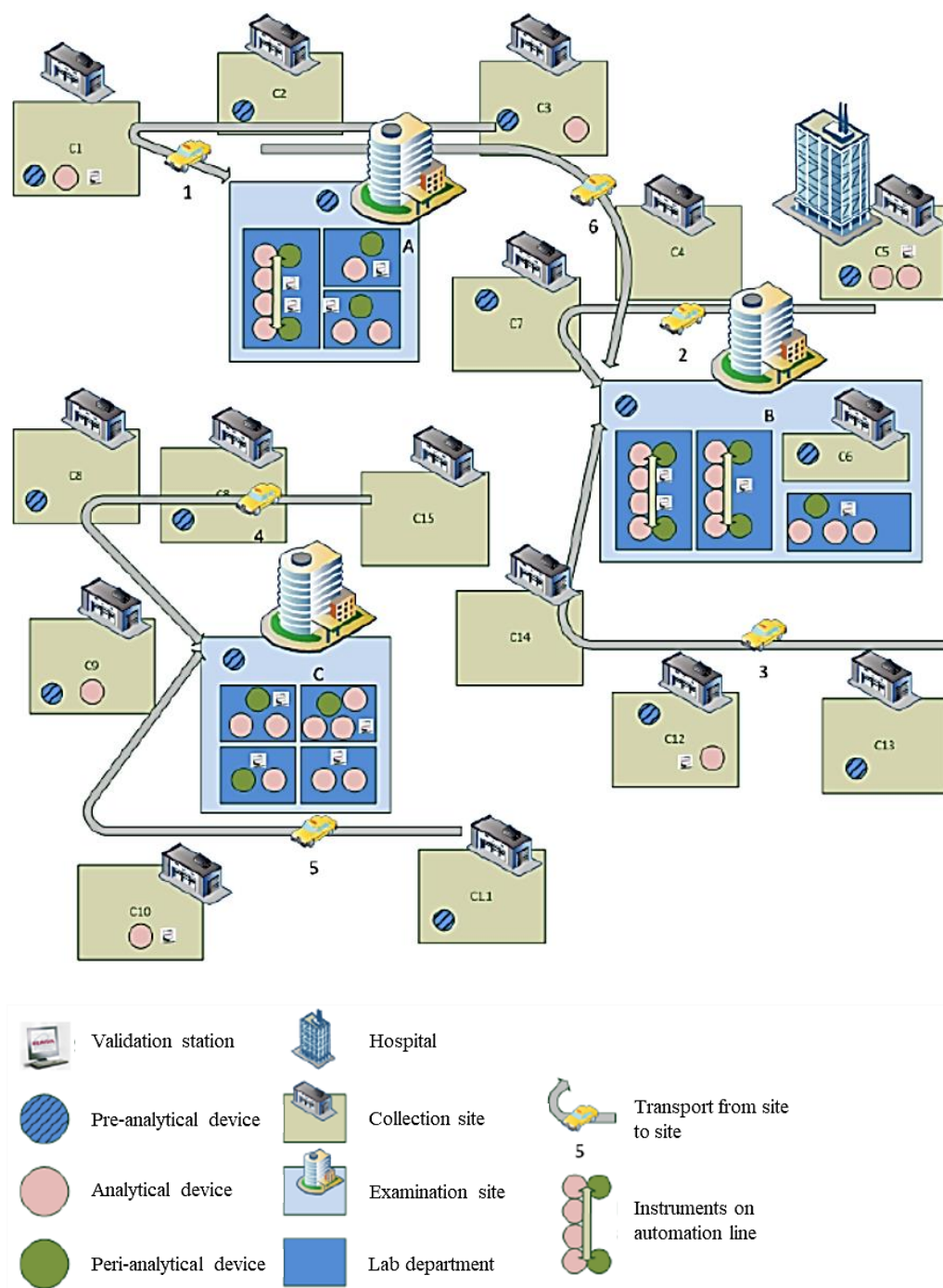

Figure 1-1. Clinical laboratory network.

1.2.3. Patient sample workflow: from sample collection to tests result preparation

In this section, patient sample workflow is described from collection sites where samples are created till tests analysis and result validation and preparation in examination site.

1. Sample drawing: Part of the samples is drawn by laboratory personnel: nurses or lab technicians in the collection site of the laboratory. Another part is drawn by doctors or nurses at their office or at patient's home. At last, a part is draw by medical staff in hospitals. All the drawn samples arrive at laboratory collection sites or at the examination site. According to the prescription, several samples

could be drawn from a patient and placed in different tubes. The tube type depends on the tests to be done. Each tube is identified by a unique identifier on a barcode label. This unique identifier allows the electronic association with the patient order (prescription) in the LIS, and further in the DM or the laboratory device. The quantity of the drawn sample could be adapted according to the organization of the laboratory workflow. Some laboratories are drawing more samples per patient to avoid having to create aliquot later and to have a unique destination instrument per tube.

2. Packaging (sample delivery): Samples are grouped in racks. Racks are placed in carrier cases. Carrier cases could be refrigerated when required. Both racks and carrier cases generally have a unique barcode label.

3. Transportation to the examination site: Carrier cases are conveyed by courier to the examination sites. The job of the courier is generally organized in the form of tours.

4. Receipt of the samples (identification, quality, volume, and associated prescription are controlled): When arrived, samples are checked. The tube types, their volumes and aspects are reviewed to ensure the needed quality of the sample for the prescribed tests. When reviewed, part or all of a prescription could be rejected if the quality of the samples is not good enough to perform the tests. If the quality of the sample is not optimal, but could allow some analysis, non-conformity comments will be indicated in the electronic records of the order and will be indicated on the final report (sent to the physician). At the end of the receipt phase the samples are sorted and placed on racks according to their workflow and associated pre-analytical steps.

5. Rack building according to the pre-analytical steps: Racks are generally specific to each manufacturer or to a family of instruments of one manufacturer. A sample will be moved from a rack to another according to the devices on their workflow path.

6. Carrying samples to the pre-analytical devices: Several pre-analytical steps could be needed to get the sample preparation completed. The sample is generally moved to different pre-analytical devices to perform these steps.

7. Sample preparation for the requested tests:

- a) **Aliquoter:** For some analysis the primary tube cannot be used directly. For example, a dilution could be requested. Aliquoting is also used to avoid cross contamination between tests. Furthermore, aliquoting is used to simplify and optimize the workflow of samples. If one sample must be run on two instruments, creating an aliquot allows to perform in parallel the analysis, one is done on the aliquot while the other is done on the primary tube. In addition, aliquots are created to be sent to other specialized laboratories for some specific tests.

- b) Centrifuge: Some tests are performed on blood plasma (or serum). Plasma is obtained by centrifugation of the blood sample. Centrifugation separates the blood cells from the plasma. Serum is obtained by blood coagulation.
- c) Sorter: According to the prescribed analysis, samples are placed on racks dedicated to the analyzers chosen to perform the tests.
- d) Decapper (optional): Some instruments cannot draw a sample through the tube cap. In such case, the tube cap is removed by one of the de-cappers before being placed on the analyzer.

8. Moving samples to the analyzers: Once the samples prepared, racks are moved to the instruments and placed in their input regions. Some instruments have a sequential access to the sample (a queue of racks is built). In this case, the samples are analyzed one by one according to the order in which they are loaded into the instrument. Other instruments could access samples in any order and could prioritize the tubes according to their emergency. In this case, STAT samples could be analyzed first. Actually, the instrument may have a specific input region for STAT tubes.

9. Analysis on the instrument: Once drawn by the instrument, the samples are placed in an output region. Some instruments have a waiting zone allowing the sample to be drawn again to perform a rerun test before unloading the sample. The rerun test is generally requested by the data manager or by the LIS if the result is suspicious or the first result is out of the range of the analyzer.

10. Moving the sample to other instruments: To complete the order, a sample might be moved from one instrument to another. The remaining analyses are done following the same schema, from step 8 to 9.

11. Recapping (Optional): To avoid pouring the samples, tubes might be recapped.

12. Transportation of the samples to the storage: Samples with all tests done are transported to the storage.

13. Storage of the sample in fridges (archiving): Once all analysis done, samples are stored in a fridge, usually for a few days. This allows requesting eventual rerun or reflex. There are two kinds of storage:

- a) Short period storage: Samples are stored for one to seven days in fridges. The organization of the fridge should allow retrieving any sample rapidly. The location of the sample in the fridge is generally materialized by a fridge ID, a shelf ID, a rack ID and a position in the rack.
- b) Long period storage (serum banks): Some samples must be stored for a longer amount of time according to the applicable regulation rules. Serum bank is a storage location of serums in the laboratory. Stability of a sample is maintained by freezing.

14. Complementary analysis (Reflex): According to the test result, one or more complementary tests might be requested by the physician or by the laboratory biologist. To handle Reflex tests, steps 8 to 14 must be followed again.

Figure 1-2 schematically depicts patient sample flow throughout the laboratory organization.

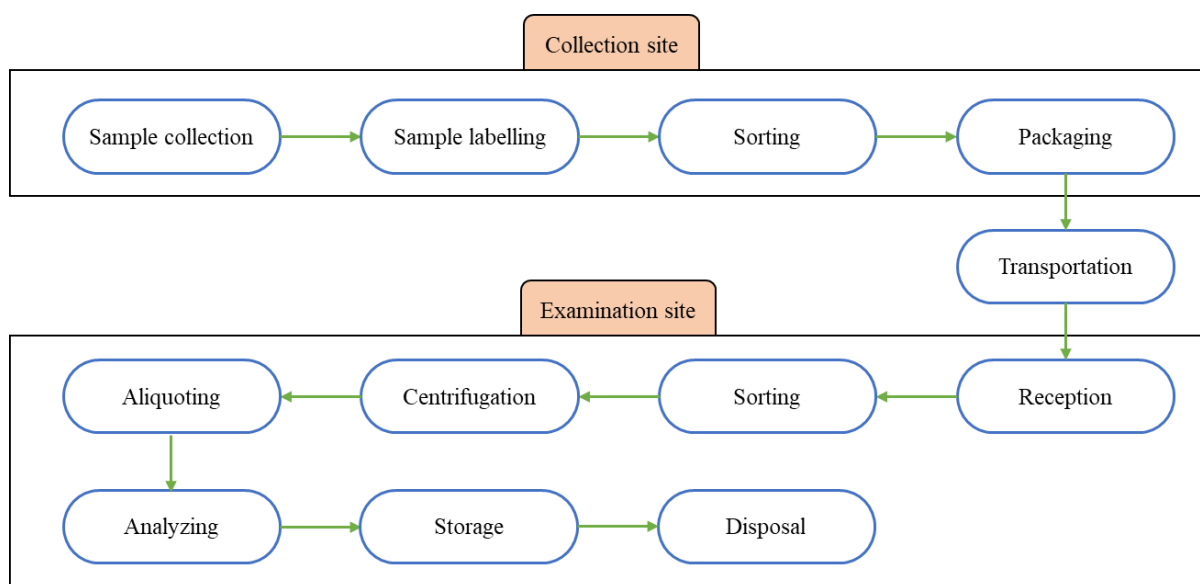

Figure 1-2. Schematic of patient sample flow.

Focusing only on examination site operations, the process can be classified into three steps: Pre-analytical, analytical and post-analytical. Pre-analytical step includes tube registration, centrifugation, sorting and aliquoting. Analytical step indicates to the phase when tubes are analyzed by analyzers. Post-analytical step refers to tube storage and result validation and preparation. It is noteworthy that tube transportation is also a key operation in the laboratory which interconnects different steps of the process. Figure 1-3 illustrates the principal steps of operations in the examination site.

Alongside the patient sample flow, information flow plays an important role in a clinical laboratory. As a part of the information exchange, analyzers transmit test results to the validation consoles where results are checked and validated by specialists. Generally, a portion of the results are validated automatically through the customized rules defined in DM and the remaining must be validated by specialists. Validated results are then prepared to be sent to the physicians and the patients.

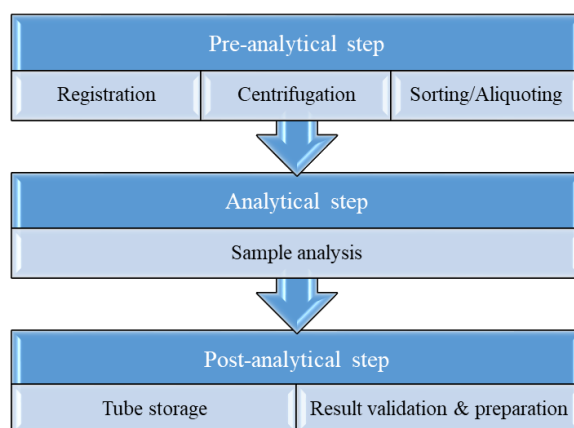

Figure 1-3. Main steps of operations in examination site.

1.3. Introduction to clinical laboratory main decision problems

Designing a modern clinical laboratory as a complex system is a difficult challenge. Generally, designing a complex system to achieve a number of strategic objectives involves making a series of complicated decisions over time (Hayes and Wheelwright, 1979). Making these decisions in a way that supports the system's high-level goals requires full and detailed understanding of design issues interactions as well as their impact on the system's ultimate goals. In systems engineering literature, numerous approaches have been addressed to manage the manufacturing system design. Axiomatic design (AD) methodology has been introduced as a systematic, scientific approach to deal with complex system design (Suh, 1990). This approach focuses on the generation of system requirements and selection of means for achievement (Cochran et al., 2002). In AD, objectives are stated as functional requirements (FRs) and solutions as design parameters (DPs). Briefly, the AD starts from the high-level FRs and decompose them into the lower-level FRs and in order to fulfil each of them, a DP is proposed. Concepts of the AD is helpful to understand the main objectives of the design and consequently, decompose the complex design problem into sub-problems.

With regards to the axiomatic design principles and profound investigation of clinical laboratories requirements, as well as comparing clinical laboratories with service and manufacturing systems, the following problems are listed as the main decision issues for design and planning of a clinical laboratory.

Machine selection problem - In order to equip a laboratory, type and quantity of required equipment have to be determined. Machine selection problem deals with the specification of the type and number of required analyzers and non-analytical machines inside the laboratory to satisfy the demand with the aim of optimizing one or more objectives under certain constraints.

Personnel requirements problem - Along with the laboratory equipment selection problem, employee requirements is essential to be addressed. Determining the number of full-time employees and in the next step, tasks assignment are crucial problems for clinical laboratories.

Facility layout problem - Specification of the location of each instrument in the laboratory is a key design problem. The facility layout problem is defined as the placement of facilities in a laboratory with the aim of determining the most effective arrangement according to one or more objectives under specific constraints.

Analyzer configuration problem - In clinical laboratories, analyzers require reagent to be able to perform a test. Analyzer configuration problem deals with the specification of the type and quantity of reagent bottles placed into each analyzer with the aim of optimizing one or more objectives under certain constraints.

Assignment and scheduling problem - Normally, there are more than one eligible analyzer to analyze a test of a sample. Efficient assignment of tubes and tests of tubes to the analyzers in a clinical laboratory is known as the assignment problem. Scheduling problem deals with determining the sequence of tubes on different operational processes.

Aliquoting problem - In clinical laboratories, there is an option to make more tubes out of one which is called aliquoting. In one hand, beside the costs of aliquoting, it generates more tubes in the laboratory which complicates tube handling; one the other hand, it provides the opportunity to simplify the sample workflow throughout the laboratory by dispatching the primary and its aliquoted tubes to different destinations for analysis simultaneously instead of sending a tube to different destinations sequentially. To characterize and resolve the aliquoting problem following questions must be answered: Which tubes must be aliquoted? How many aliquots must be created from each aliquoting candidate? How tests must be assigned to the aliquoted tubes?

Vehicle routing problem - Patient samples are taken in the collection sites and then, delivered to the examination site by special vehicles. Optimal routing and timing of these vehicles is known as the *vehicle routing problem (VRP)*. This problem has been broadly investigated in the literature even for clinical laboratories. [Yücel et al. \(2013\)](#) introduced the problem of specimen collection for a clinical laboratory from a dispersed number of sites, as a collection for processing problem (CFPP) with the aim of maximizing the total number of samples processed during the day as well as minimizing the daily transportation costs.

Figure 1-4 summarizes the principal optimization problems of clinical laboratory design and planning and their associated decision making level.

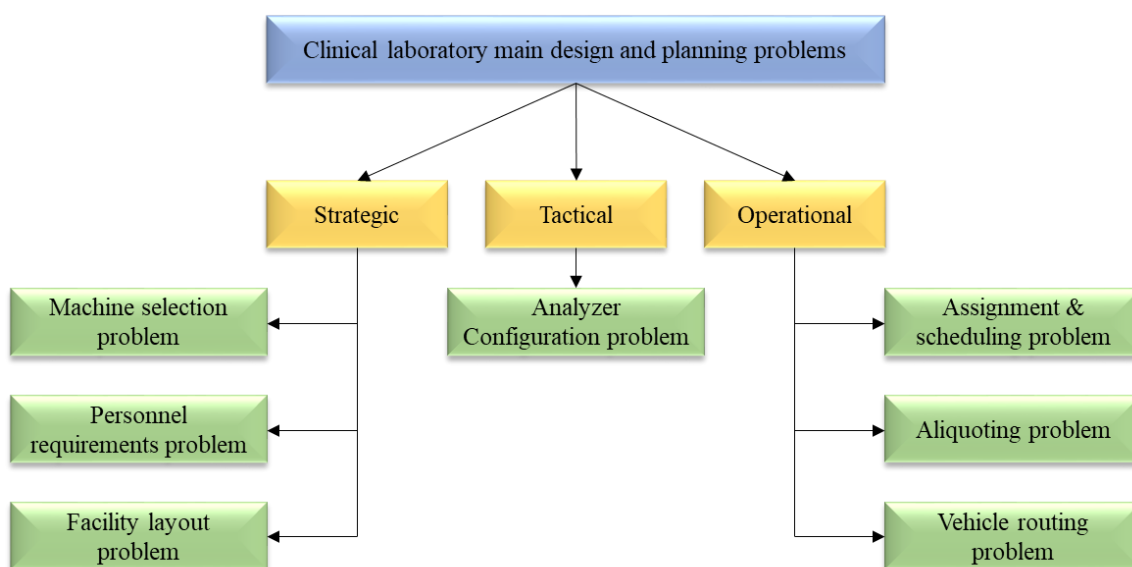

Figure 1-4. Clinical laboratory main design and planning decision problems.

Alongside the aforementioned problems, determining an efficient maintenance policy for machines and a suitable sample drawing policy in collections sites can be considered as other important clinical laboratory optimization problems.

1.4. Application of operations research in clinical laboratory optimization: a survey

Most of the research efforts concerning the application of operations research (OR) methods in improvement and optimization of clinical laboratories have been started since the advent of ‘The OpenLabs’ project (O’Moore et al., 1994). This project is concerned with the use of advanced information science and telematics for the optimization of clinical laboratory services (O’Moore et al., 1996). As part of this project, Merode et al. (1996) developed a simulation module for laboratory capacity planning. Introducing computerised validation systems within the clinical laboratories to automatically validate patient results is also one of the remarkable advances related to The OpenLabs program (Boran et al., 1996). To optimize the structure of a clinical laboratory, Merode et al. (1998) proposed a mathematical programming model to cluster workstations to minimize the maximum idle time of staff while assigning them to the clusters. Elena et al. (2006) introduced a mathematical model to help improving the laboratory organization in relation with staff assignment and specification of samples analyzing method decisions. To efficiently schedule the personnel in laboratories, Franses and Post (2003) developed an algorithm to find an acceptable matching between the workers and tasks in different periods. Concerning the planning and scheduling of patient tests in laboratories, Marinagi et al. (2000) proposed a scheduling system for hospital laboratories to support the continual and dynamic nature of the problem.

Simulation modeling is the most-used tool to analyze, evaluate and improve the planning and design of clinical laboratories over the past years. Computer simulation as a powerful and versatile tool is suitable for full understanding of a complex system, bottleneck identification, change management, scenario analysis and projection. To make a wise decision on automating the central processing laboratory in Mayo clinic, Dankbar et al. (1992) developed several simulation models to evaluate the effect of different vendor proposals on system performance. Berchtold et al. (1994) endeavoured to develop a generalized flexible simulation model to assess arbitrary changes in the structure and configuration of the clinical laboratories. They expressed average turnaround time, resource utilization and average queue length as three significant performance measures in clinical laboratories studies. Lote et al. (2009) emphasized on the use of discrete-event simulation with other industrial engineering techniques to improve medical testing laboratories. As a part of the paper, optimizing courier routes and evaluating the impact of such improvement on operational performance of the laboratory as well as levelling utilization of resources to achieve optimal resource allocation were studied on a medical laboratory located in the eastern part of the United States. Luangmul et al. (2012) developed a simulation model of a hospital’s clinical laboratory in Thailand focusing only on the complete blood cell (CBC) test

through using ARENA simulation software. The aim of the study was to verify the impact of potential changes like physical layout alternation by a verified and validated simulation model. Biochemistry and hormone test laboratories of a university hospital in Turkey were studied via simulation modeling by [Kadi et al. \(2016\)](#). The aims of the study were firstly, to achieve a full understanding of the current system and identify possible existing bottlenecks and secondly, to conduct scenario analysis in order to improve the current state of the system. Improvement scenarios were made based on process analysis solutions and resource alternation decisions. ARENA simulation software was used to develop the simulation model and to capture the average time in system of a patient as the main performance measure of this study. For more studies on the application of simulation modeling for clinical laboratories improvement and optimization see [[Vogt et al., 1994](#)], [[Groothuis et al., 2002](#)] and [[Bodtker et al., 1993](#)].

Investigating the literature of clinical laboratory optimization reveals the lack of coherence among the research activities in this field. There are a few studies demonstrating the application of operations research, mainly mathematical programming in medical laboratory decision making problems. In addition, simulation studies have been conducted on a specific problem for a given case.

Since clinical laboratories are being merged, the advent of giant laboratories is inevitable in near future. Therefore, new generation clinical laboratories require productive decisions concerning the planning and design processes to efficiently create and manage such a complex system on one hand, and reduce the costs, on the other hand.

1.5. Proposed framework for clinical laboratory optimization

As discussed in [section 1.3](#), due to the complexity of clinical laboratory design and planning activity, this problem is decomposed into several decision problems. According to some reasons such as problem necessity and applicability in current status of clinical laboratories, and also data availability, machine selection, facility layout, analyzer configuration and assignment are identified as optimization problems in this study, implying that a systematic approach is applied to characterize each of these problems and to search the solution space in order to find optimum or near-optimal solutions. [Figure 1-5](#) presents the procedure applied to deal with each identified optimization problem. Solutions of these selected problems only create a part of a clinical laboratory. For the remaining part, other decision problems must be tackled. A knowledge-based policy is initially used to answer these problems. For instance, the number of full-time employees can be determined based on the opinion of a group of experts. Although a simple calculation might support the selected policies for the remaining decision problems, there is no guarantee for the efficiency of these policies.



Figure 1-5. Procedure applied to tackle optimization problems.

To organize the structure of the clinical laboratory optimization problem, a systematic, top-down, stepwise methodology is proposed (Figure 1-6). In this methodology, optimization problems are sequentially tackled from the strategic to the operational level respecting the interactions between the problems. In better words, machine selection is firstly tackled then, facility layout, after that analyzer configuration and finally, assignment. The main step of this framework is to use a fine-grained, flexible and at the same time reliable simulation model which not only includes all the resulting solutions from solving the defined optimization problems but also, all the laboratory policies and decisions made by experts neglected in the previous steps of the framework to approximately imitate the behaviour of the designed system and also to evaluate critical performance measures. Hence, the number of full-time employees and their duties as well as sample drawing, aliquoting and scheduling policies are decided by the experts through either rough computation or simple policy selection.

A simulation model as a virtual description of a real system plays a decisive role in the proposed framework which provides the opportunity to evaluate and check the satisfaction of key performance indicators (KPIs) and if needed, assess various scenarios made of former solutions modification. Therefore, a modification loop can be assumed whether to each optimization or decision problem to modify some parameters of the system which may improve the system performance and create more satisfaction form the designer point of view. A simulation model is able to provide a clear insight to the designed system through presenting the system bottlenecks and its components statistics which all help the decision maker recognizing target problems for making loops and performing better changes to either the problem solution or description. Furthermore, to scrutinize a decision problem in this framework, it can be defined as an optimization problem. The bi-directional arrow between optimization and decision problems in Figure 1-6 shows this possible movement.

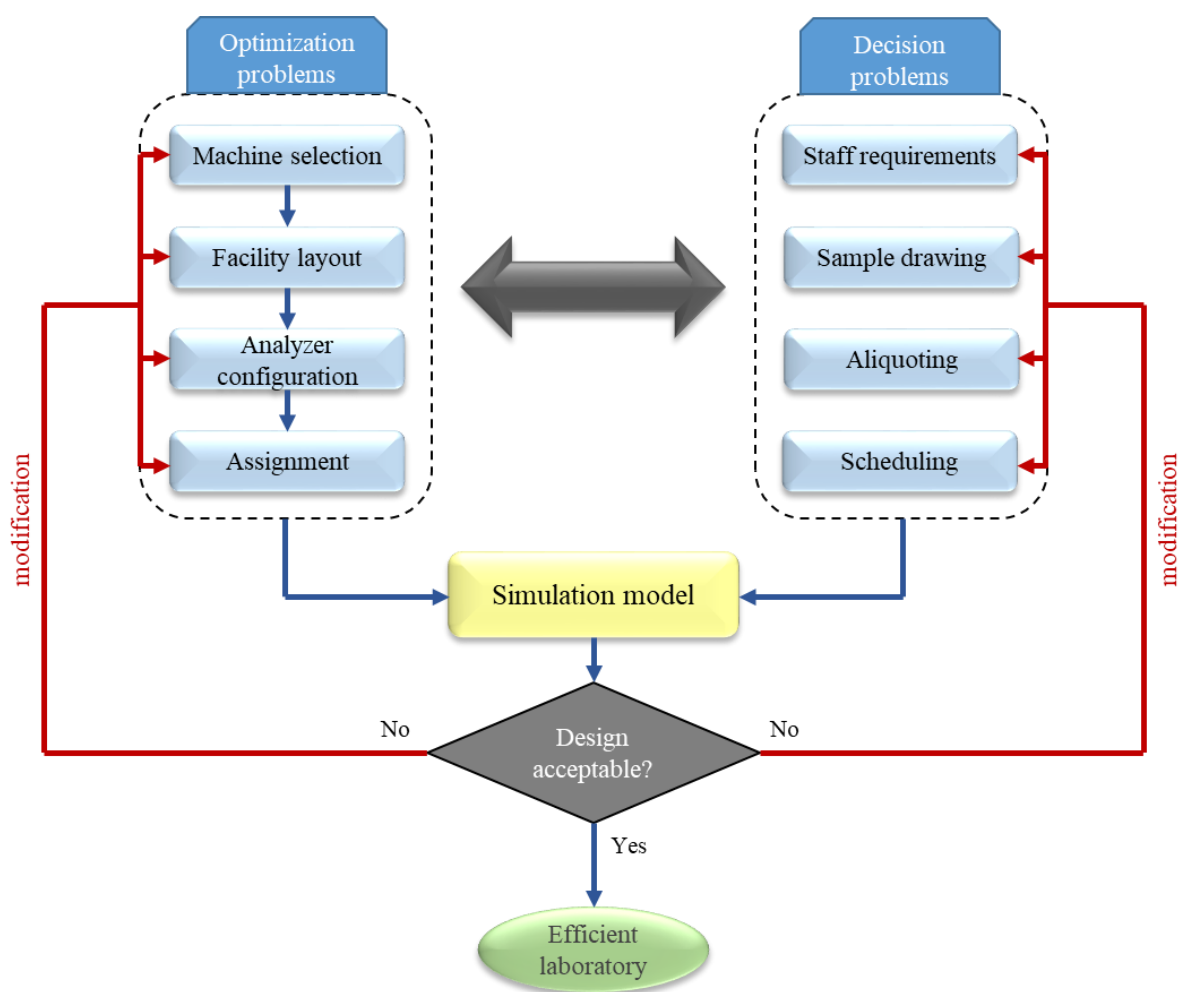

Figure 1-6. Proposed framework for efficient CL design.

1.6. Sources of information and case study

In this thesis, five main sources of information were used for different aspects of the project. In the first phase, regular weekly meetings with an expert provided useful information to understand the clinical laboratory organization, its features and characteristics. In addition, laboratory visits had a key effect on better system comprehension. These two sources, namely expert knowledge and laboratory visits, as well as literature of the complex system design played the most important roles in problem identification and consequently, problem description. In order to understand the behaviour of clinical laboratory components, mainly machines, a customized simulation tool called '*LabSim*' which belongs to Beckman Coulter Company had the bold role; however, experts' explanations, laboratory visits and a machines manufacturer website helped a lot for better receipt. Necessary data for both mathematical and simulation modeling were mainly extracted from a real laboratory database, '*LabSim*' simulation tool and machines manufacturer website. Additionally, some missing data were provided by the experts. [Table 1-1](#) presents the main sources of information used to obtain the necessary information and data in different steps of the project.

Table 1-1. Main sources of information used for data extraction in each step of the project.

<u>Sources of information</u>	<u>Project main activities</u>			
	<i>CL understanding</i>	<i>CL components understanding</i>	<i>Problem identification & description</i>	<i>Modeling and validation</i>
<i>Expert knowledge</i>	×	×	×	×
<i>Laboratory visit</i>	×	×	×	
<i>'LabSim' simulation tool</i>		×		×
<i>Machine manufacturer website</i>		×		×
<i>Laboratory database</i>				×

It is worth noting that due to the confidentiality aspects, data has been unnamed and in some cases encrypted. In the next section, the case study used to validate the proposed framework is briefly described.

1.6.1. Case study

In this thesis, Database of a real-world clinical laboratory is used to extract real data for validating the proposed framework. This clinical laboratory mainly focuses on Immunology and Chemistry tests. This laboratory covers thirty-two different Immunology tests and forty different Chemistry tests. Therefore, the total number of test types treated by this laboratory is seventy-three tests. For a normal day, the total number of arriving tubes is 3,847 on average. This total is made of 458 Immunology tubes, 1,657 Chemistry tubes and 1,732 Immunology-Chemistry tubes in average. Furthermore, the total number of requested tests of the arriving tubes is 28,632 which is made of 4,591 Immunology tests and 24,041 Chemistry tests averagely. The daily average number of requested tests for each test type is given. Additionally, the requested tests of each tube are known which are demonstrated by Tube-Test matrix. [Table 1-2](#) presents the statistical status of the tests requested by each class of tubes.

In each chapter, the proposed models are validated through using these data. Other necessary data associated to each specific problem is described in the respective chapter.

Table 1-2. Statistical status of the tests requested by each class of tubes in the case study.

	<i>Immunology</i>	<i>Chemistry</i>	<i>Immunology-Chemistry</i>
	<u>tubes</u>	<u>tubes</u>	<u>tubes</u>
<i>Total number of tests requested</i>	991	9,474	18,176
<i>Average number of tests requested by a tube</i>	2.164	5.718	10.494
<i>Minimum number of tests requested by a tube</i>	1	1	2
<i>Maximum number of tests requested by a tube</i>	22	22	30

1.7. Data management

In this thesis, many data are involved. As previously discussed in [section 1.6](#), required data have been collected from different sources of information including a real laboratory database, website of a machine manufacturer, 'LabSim' simulation tool and experts' knowledge. All these data create our database and are used as the input for the proposed optimization approaches. On the other hand, solving each proposed model provides new information that might be used as input data for other optimization problems. For instance, solving the machine selection problem leads to a set of selected machines which are used as a part of the input for the analyzer configuration problem.

To simplify the management of all these data in the optimization process of clinical laboratory design and planning, an Excel-based tool has been developed. Generally, this tool is able to prepare all the required input data for each defined problem and also for the simulation model from the created database. Each time a model is solved, the output results are added to the database either keeping the same format or transforming to the proper format as they can be used afterwards by the other models.

[Figure 1-7](#) shows the control panel of the developed Excel-based tool for data management in which each colored block presents a button. After filling all the required sheets by the user which are mainly related to laboratory demand data, the developed tool automatically prepares all data required to solve the machine selection problem by pressing the 'Generate dataset MSP' button. To solve the machine selection problem, the only thing to do is to press the 'Run model MSP' button which launches GAMS software. Finally, pressing 'MSP result retrieval' button retrieves the output results of the machine selection problem in the required format to be used as the input of other problems. This instruction can be generalized to the other buttons embedded in this tool to manage other optimization problems and finally, prepare the input of the simulation model.

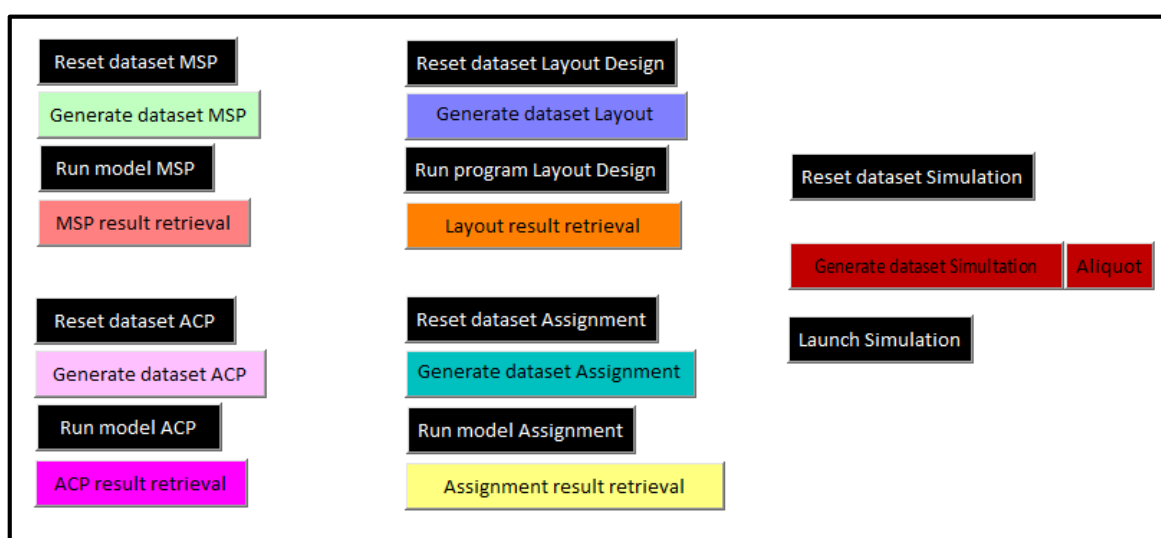

Figure 1-7. Control panel of the developed Excel-based tool for data management.

1.8. Thesis main contributions

The main contributions of this research work are listed as follows:

- A comprehensive study is carried out to explore the clinical laboratory organization, its characteristics, and more importantly, the most significant decision problems.
- A general stepwise framework is proposed to systematically deal with the optimization of clinical laboratory design and operating decisions. The proposed framework is validated using data from a real-world case study.
- The machine selection problem is specifically defined for clinical laboratory. Additionally, a novel mathematical model is developed to tackle this problem. The objective of the proposed model is to minimize the daily machine-related operating costs in the laboratory.
- The facility layout problem is specifically defined for standalone clinical laboratory considering physical, technical and organizational constraints. To cope with this problem, a heuristic approach is developed which is able to propose diverse efficient solutions to decision makers.
- To the best of our knowledge, the analyzer configuration problem for clinical laboratories is described for the first time in this thesis. Two new mathematical models are proposed to deal with this problem. The first proposed model has been inspired from the machine selection model and only focuses on cost-related objectives while the second proposed model is a bi-objective model which has a look to the operational issues inside the laboratory and tries to minimize tubes movements as well as analyzers configuration costs.
- A mathematical model with three objectives is developed to face the assignment problem in a clinical laboratory. In this model, the first two objectives balance the load among the analyzers in terms of number of tubes and tests assigned to each analyzer and the third objective minimizes the tubes' movements within the laboratory.
- To the best of our knowledge, aliquoting problem for clinical laboratory is described for the first time in this thesis. Two general approaches are proposed to deal with this problem.
- A customized, flexible and fine-grained simulation model is developed in this thesis in which nearly all the main clinical machines of a specific manufacturer have been modeled in details.
- The use of simulation modeling to evaluate clinical laboratory performance measures and also, for system understanding and bottleneck identification is performed in this thesis.

1.9. Thesis structure

The rest of this thesis is organized as follows:

Chapter 2: Machine selection problem for clinical laboratories - This chapter starts with a comprehensive literature review on machine selection problem. Then, machine selection problem for clinical laboratory is detailed. Assumptions, notations and mathematical model proposed to tackle this problem are fully described afterwards. Finally, the model is validated through a case study and the chapter is terminated by a conclusion.

Chapter 3: Facility layout problem for clinical laboratories - This chapter starts with a survey on facility layout problem. Then, facility layout problem is specifically described for standalone clinical laboratory. In order to deal with this problem a heuristic approach is developed. Finally, the problem is solved for a real case through the proposed heuristic and the chapter is terminated by a conclusion.

Chapter 4: Analyzer configuration problem for clinical laboratories - This chapter starts with an introduction on analyzer configuration problem in clinical laboratory. Then, the analyzer configuration problem is detailed. To tackle this problem, two mathematical models are developed afterwards. Finally, regarding the case study, the second proposed model is applied to solve the configuration problem. The chapter ends with a conclusion.

Chapter 5: Operational problems of clinical laboratories: Assignment, aliquoting and scheduling - This chapter covers the principal operational problems of a clinical laboratory. Assignment problem is firstly described and tackled by a mathematical model. Then, aliquoting problem is addressed and two general frameworks are proposed to deal with this problem. Finally, unique features of the clinical laboratory scheduling problem are described. This chapter is terminated by a conclusion.

Chapter 6: Clinical laboratory simulation modeling and analysis - In this chapter, a customized simulation library is developed to model a standalone clinical laboratory in FlexSim¹ simulation software. The simulation incorporates all the main characteristics of a clinical laboratory and is used to model and evaluate the clinical laboratory designed through the outputs of the previous chapters. A detailed qualitative and quantitative analysis of simulation results is performed which provides useful insights for further system improvements.

Chapter 7: General conclusion and future perspectives - In this chapter, the thesis achievements are described and a general conclusion is given. Furthermore, potential future directions are discussed.

¹ FlexSim is a simulation software developed by FlexSim Software Products, Inc.

Chapter 2

Machine Selection Problem for Clinical Laboratories

Highlights:

- A part of this chapter has been filed as a US patent entitled '*Laboratory instrument selection and configuration*'.
- A part of this chapter has been presented in *OR2018* Conference in Brussels, Belgium, entitled '*A mathematical model for machine selection problem in clinical laboratories*'.

2.1. Introduction to machine selection problem in industries

Industrial system design activity comprises many decision problems such as specifying the type and number of different facilities to use, their operating characteristics and their layout. Among all these problems, machine selection is one of the initial strategic decision problems tackled typically right after the facility location problem. Nowadays, there are several types of machines in the market which are capable to perform a particular operation or set of operations with different requirements and operating characteristics. Purchase price, operating speed, capacity, accuracy, size, operator requirement, support equipment requirement, energy consumption, fuel used, maintenance requirement, safety, user-friendliness and other features are different from one machine to another. Hence, it is reasonable and essential to make smart decisions on selecting the type and the number of machines to efficiently equip a system in which, on one side, the selected machines are capable enough to satisfy the needs within the planning horizon and on the other side, impose the minimum costs. In general, the problem of determining the type and number of machines required to maintain a process within a system is known as the machine selection problem (Miller and Davis, 1977). This problem is also referred as machine requirements problem, equipment selection problem and more broadly, resource selection problem. Equipment selection is the problem of selecting the required types and quantities of production and support equipment (Heragu, 2008).

The specific definition of the machine selection problem for an application relies directly on the nature of the system being applied, as well as management goals and constraints imposed on the decision. Hereupon, the machine selection problem can be defined as the specification of the type and quantity of machines used in a system to support a process or meet the demands while one or more objectives are satisfied respecting the existing constraints. Minimizing the total machine purchase costs, the total operating costs, the cost of manufacturing each product or the number of machines selected are some of the interesting objectives for the machine selection problem. As a strategic decision problem, the machine selection problem deals mainly with capacity, budget and space related constraints. The right selection of quantity and type of machines increases machines utilization and makes efficient use of budget and available space (Heragu and Kusiak, 1987).

The selection of required machines to equip a system has considerable impacts on the other facility design decision problems such as material-handling system design and facility layout design (Miller and Davis, 1977). Due to such an inevitable interconnection, two different global approaches have been addressed in the literature to face the machine selection problem: (i) those only focusing on the machine selection problem and (ii) those integrating this problem at least with one other interacting problem. Various aspects of the machine selection problem have been extensively introduced by Miller and Davis (1977).

There are several approaches to deal with the machine selection problem. [Heragu \(2008\)](#) shortly introduced a traditional model, a linear integer programming model and a queueing model to tackle equipment selection problem for manufacturing systems comprising both production and material handling equipment. [Davis and Miller \(1978\)](#) proposed a mathematical model to determine the number of machines in each stage of a multi-stage manufacturing system. The proposed model minimizes daily operating costs of the system. To overcome the problem of equipment selection in a just-in-time manufacturing system, [Gunasekaran et al. \(1993\)](#) proposed a mathematical model where the objective function was to minimize the total yearly costs incurred due to the selected machines. [Jain et al. \(1991\)](#) proposed a mathematical model to determine the type and quantity of machines and tools in a flexible manufacturing system (FMS) to manufacture various part families. The objective function of the proposed model was made of three terms denoting the annual cost of processing all the part families in the system, the annual amortized cost on machine investment and the annual cost of tooling. Furthermore, three other model variations were introduced in which the underutilization of machines and tools were noted. [Cao et al. \(2005\)](#) proposed a mathematical model to simultaneously tackle the problem of selecting and scheduling parallel machines to minimize the sum of machine holding cost and job tardiness cost. To overcome the complexity of the proposed model, a tabu search based heuristic was developed. A similar study was also carried out by [Alidaee and Lee \(2014\)](#) in which minimizing total machine time costs was considered along with machine holding cost and total tardiness costs. [Chen et al. \(2009\)](#) developed a fuzzy goal programming model to solve the problem of equipment purchasing for a flexible manufacturing cell (FMC) where four fuzzy and conflicting goals were noticed. Suitability of the proposed approach to configure an FMC was illustrated by an example.

Multi-criteria decision making (MCDM) approaches have been widely used in the literature for production and material handling equipment selection problem. [Çakır \(2016\)](#) proposed an integrated approach comprising fuzzy simple multi-attribute rating technique (SMART) and fuzzy weighted axiomatic design (FWAD) approach to specify the optimal continuous fluid bed tea dryer for a private plant in Turkey. In this study, fuzzy SMART approach was firstly used to compute the evaluation criteria and then, FWAD was applied to rank the existing alternatives in terms of their overall performance. [Hodgett \(2016\)](#) carried out a comparative study to find out the advantages and limitations of three MCDM methods, namely, analytical hierarchy process (AHP), multi-attribute range evaluations (MARE) and elimination et choix traduisant la réalité trois (ELECTRE III) to select the most proper equipment in Fujifilm company. The results showed that MORE is the preferred method from the decision makers point of view and AHP is comparatively more time-consuming. [Yazdani-Chamzini and Yakhchali \(2012\)](#) described tunnel boring machine (TBM) selection as an MCDM problem in a fuzzy environment. An integrated approach composed of fuzzy AHP and fuzzy technique for order performance by similarity to ideal solution (TOPSIS) was developed to aid decision makers in proper TBM selection where triangular fuzzy numbers were used to parametrize linguistic variables. In this

article, fuzzy AHP was used to make the structure of the TBM selection problem and to characterize weights of the evaluation criteria and fuzzy TOPSIS was applied to determine the ranking of competing alternatives. The effectiveness of the proposed approach was finally demonstrated by a real-life case study. [Paramasivam et al. \(2011\)](#) applied three multi-attribute decision making methods, namely digraph and matrix approach, AHP and analytical network process (ANP), to determine the most appropriate milling machine for a specific manufacturing environment. This study was concluded by the comparison of the different methods applied. [Dağdeviren \(2008\)](#) employed an integrated MCDM approach including AHP and preference ranking organization method for enrichment evaluations (PROMETHEE) to select the most suitable milling machine in an international company among all existing ones. The proposed approach was identified applicable with satisfactory results from the management perspective. [Ertuğrul and Güneş \(2007\)](#) presented a fuzzy TOPSIS approach to deal with the machine selection problem in a company. [Chakraborty and Banik \(2006\)](#) applied the AHP method to select the optimal material handling equipment for a system with a specific environment. The results show the advantage of this approach in comparison with simple scoring techniques as it includes all significant performance criteria. [Deb et al. \(2002\)](#) described a methodology based on MCDM to surmount the material handling equipment selection problem in a fuzzy environment. Ability to deal with both objective and subjective factors is one of the advantages of the proposed approach. To tackle the machine selection problem, [Lin and Yang \(1996\)](#) applied the AHP method. Taking both deterministic and uncertain factors into account, presenting a complicated evaluation in an acceptable manner to decision makers, dynamic group discussion and ability to provide alternatives evaluation in a short time were listed as the main advantages of using AHP for the machine selection problem. [Myint and Tabucanon \(1994\)](#) proposed a two-stage framework to cope with the machine selection problem in a flexible manufacturing system (FMS). In the first stage of the proposed approach, AHP technique is applied to limit the number of possible configurations. In the second stage, a goal programming model is employed to determine the most appropriate alternative from the remaining shortlisted configurations.

Integrating a knowledge-based expert system with an analytical approach to deal with the machine selection problem has been noticed by many researchers. [Guldogan \(2011\)](#) introduced a hybrid model integrating the knowledge-based expert system and the genetic algorithm to tackle machine selection and operation allocation in a work center. The proposed approach provides the ability to take both quantitative and qualitative attributes into the decision making process. The applicability of the proposed procedure was illustrated by a real world case study at an advertisement company. [Chan \(2002\)](#) introduced a smart material handling equipment selection system called MHESA (Material Handling Selection Equipment Advisor) to provide an intelligent and automatic tool to help system designers opting the most suitable material handling system. The proposed approach integrates a knowledge-based expert system with an AHP model where the first one is applied for material handling equipment selection and the second one is employed to choose the most desirable equipment type. To

select the most proper material handling equipment and to evaluate the performance of the selected equipment for a manufacturing system, [Park \(1996\)](#) presented an intelligent knowledge-based expert system, called ICMESE which comprises four main modules: (i) a knowledge-based system to choose the most suitable equipment type; (ii) an MCDM approach to select the most desirable existing commercial model of the selected equipment type; (iii) a database containing the list of all existing commercial models of equipment types with their specifications; and (iv) a simulator to assess the performance of the selected material handling equipment for movement and storage of materials in a manufacturing system. [Tabucanon et al. \(1994\)](#) designed and developed a prototype decision support system for intelligent selection of the most satisfactory machine for a CNC turning center based on the integration of an MCDM model, namely AHP, and a rule-based expert system. [Kusiak and Heragu \(1988\)](#) introduced a knowledge based system, called KBSES, for the equipment selection problem. The proposed system includes two mathematical models characterizing the problem, a database presenting required data for the model and a knowledge base consisting declarative and procedural knowledge. In this approach, a suitable model is firstly selected by the knowledge-based system. Then, the knowledge is used to data stored in the database to generate a set of proper data for the selected model. Finally, the created model is solved using a suitable algorithm. Generally, such an expert system is known as a model-based expert system ([Kusiak and Heragu, 1988](#)).

The application of computer simulation is seen to evaluate the performance of the selected equipment in a manufacturing system and to provide tangible proofs for intelligent decision making. An integrated simulation-expert-system-based approach was proposed by [Masmoudi et al \(2007\)](#) to tackle machine and labor sizing problem for a manufacturing system. In this approach, the manufacturing system is firstly simulated through a computer simulation model. Then, the created simulation model uses input data including manufacturing system data and demand data to imitate the behavior of the system. System performance measures are simulation outputs which form a part of expert system input as well as performance constraints, manufacturing system data and demand data. Afterwards, reasoning procedure of the expert system is performed in two hierarchy stages where in the first stage only machine sizing is only taken into account and in the second stage labor sizing is determined in accordance with the result of the previous stage. [Chtourou et al. \(2005\)](#) coupled the simulation modeling tool with an expert system to tackle the machine selection problem for a manufacturing system. The main use of the expert system was to organize the search mechanism and to avoid the trial and error aspects.

[Figure 2-1](#) summarizes the introduced approaches in the literature to cope with the equipment selection problem. Note that all these methods can be integrated with a knowledge-based system to make the input data more suitable for the models. Among all these techniques, MCDM models have been mostly utilized due to their capability to take both quantitative and qualitative factors into account and practicability as numerous data is not necessarily needed. Simulation-based approaches are able to

involve dynamicity and stochasticity into the problem, nevertheless, they have been less attended. What is clear is that a hybrid approach is more effective and reliable for the equipment selection problem in comparison with the proposed individual techniques and should take more attentions.

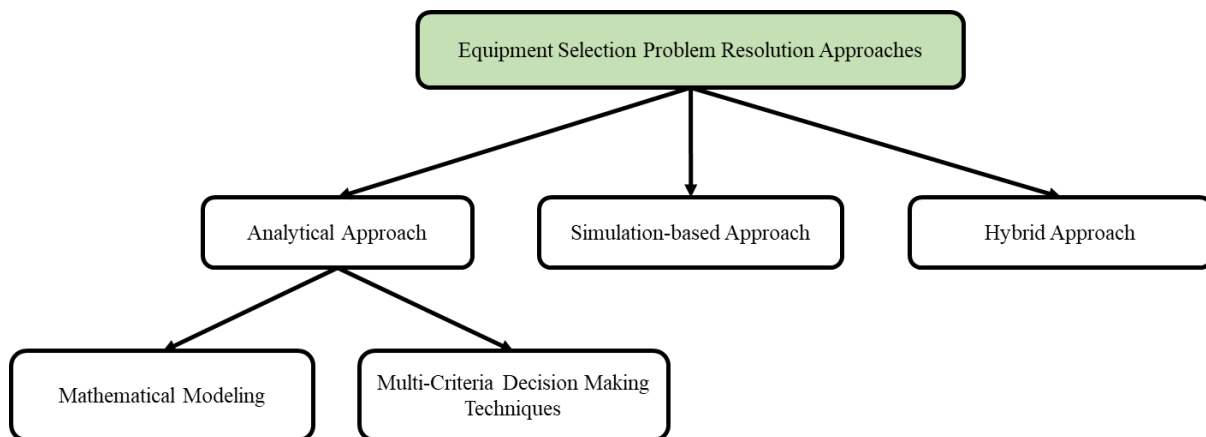

Figure 2-1. Equipment selection problem resolution approaches.

The rest of this chapter is organized as follows: [Section 2.2](#) introduces the problem of machine selection for clinical laboratories. The proposed mathematical model to tackle this problem is described in [section 2.3](#). A useful model variation is then explained in [section 2.4](#). At last, the proposed model is validated through a case study in [section 2.5](#).

2.2. Machine selection for clinical laboratories

Machine selection is one of the most important strategic problems for clinical laboratory design. Improper selection of machines can reduce the productivity, flexibility, responsiveness capabilities and finally, increase the operating costs of the laboratory.

To equip a clinical laboratory, two types of machines have to be addressed: analyzers and non-analytical machines. Analyzers are the machines which are responsible for performing tests on samples. Non-analytical machines are the machines used in the pre-analytical step to prepare samples for analysis. This type of machines comprises centrifuge and sorter. Hence, machine selection problem for clinical laboratory is defined as the problem of specifying the type and quantity of both analyzers and non-analytical machines with the aim of minimizing the total daily machines operating costs under certain constraints. The operating cost of a machine in a clinical laboratory is made of three components: (i) a fixed cost implying the cost of having the machine in the laboratory; (ii) a configuration cost implying the total cost of reagents used in the machine to analyze the tests; and (iii) a calibration cost implying the total cost of calibrating each test type on the machine. The daily cost of having a machine in the laboratory is a fixed cost which is calculated based on machine purchase cost, machine lifespan and the total number of laboratory working days per year. In better words, this cost is the normalized form of the machine purchase cost. The daily cost of an analyzer configuration is a variable cost depending on

the type and number of reagent bottles used in the analyzer to satisfy the daily demand. The daily calibration cost of an analyzer is also a variable cost relying on the type of reagents used in the analyzer. It is worth mentioning that only the machine purchase cost is meaningful for non-analytical machines as no analysis is performed by them and consequently, no reagent is needed. Demand, laboratory space, budget available and machines capacity are considered as the main constraints of the problem.

In the next section, the machine selection problem for clinical laboratories is mathematically formulated.

2.3. Proposed mathematical model

Description of the proposed mathematical model to tackle the machine selection problem for clinical laboratory is managed in the three following sub-sections. [Section 2.3.1](#) introduces the useful definitions and assumptions on which the model is built. [Section 2.3.2](#) depicts the notations used in the mathematical model. Finally, [section 2.3.3](#) presents the proposed mathematical model as well as the explanations of the equations.

2.3.1. Definitions and problem assumptions

- The general term '*machine*' is used to indicate to both analyzers and non-analytical machines such as centrifuge and sorter (Automate¹).
- Analyzers belong to only one test discipline. Main disciplines are Immunology, Chemistry, Hematology and Coagulation.
- There must be a sufficient capacity in the laboratory to meet all the requested tests within a working day.
- Some of the tubes in the laboratory only require pre-analytical operations such as centrifugation and sorting in the sorter and they are sent to the other external sites to be analyzed. The load of these tubes on pre-analytical machines is taken into account in order to be more precise in capacity planning.
- It is assumed that each Automate used in a lab is accompanied with an aliquoting machine; so, there is no need to determine the number of aliquoting machines separately. An aliquoting machine (aliquoter) is used to make aliquots from samples in some cases.
- Fixed cost of having machine j in the laboratory for a day is defined based on the machine purchase cost (PC_j), machine lifespan (LS_j) stated in year and total laboratory working days (TWD) per year, and is calculated using $\{FC_j = PC_j / (TWD \times LS_j)\}$ formula.

¹ Automate is a Trademark for one of the Beckman Coulter's sorting machines.

- In order to analyze each test type, a specific reagent is required. Generally, reagents are the material used by the analyzers to perform the test.
- The capacity of each analyzer in terms of tests number relies on the analyzer technical features and the amount of reagent bottles positioned into the analyzer. The Following formula is proposed to consider the daily Analyzer Operational Capacity (AOC):

$$AOC_j = \min\{\tau_j g_j u_j, \sum_{h=1}^o \sum_{s=1}^q \delta_{hsj} x_{hsj}\}$$

According to the proposed formula, the daily operational capacity of the analyzer equals the minimum daily nominal capacity of the analyzer and the total number of tests that can be analyzed by the analyzer regarding the number of reagent bottles assigned to that analyzer ($\sum_{h=1}^o \sum_{s=1}^q \delta_{hsj} x_{hsj}$). Nominal capacity of an analyzer is computed based on the multiplication of the analyzer capacity (g_j) provided by the manufacturer in terms of the number of tests per hour to the total daily available working hours (τ_j).

- Each non-analytical machine has a certain capacity in terms of number of tubes that can be processed by the machine per hour.
- The total available working time for each machine implies the time the machine is available for operating and analyzing. So, times required for calibration, maintenance and refilling reagents are reduced from this time.
- Each analyzer has a certain number of reagent positions to room reagent bottles.
- Each reagent bottle occupies certain number of positions in the analyzer depending on the reagent type and bottle size.
- The reagent bottle cost relies on the reagent type, bottle size and the analyzer in which the reagent bottle is used.
- The number of tests that can be analyzed using a bottle of reagent depends on the reagent type, bottle size and the analyzer in which the reagent bottle is used.
- Calibration is performed per test type on each analyzer. So, the calibration cost depends on the test and analyzer type and it is computed per test type on each analyzer neglecting the number and size of reagent bottles used for the test type in the analyzer. This cost is estimated based on the time required to perform calibration tests as well as amount of reagent required to perform these tests.

2.3.2. Notations

All notations used in the proposed mathematical formulation are described in [Table 2-1](#).

Table 2-1. Notations used in the proposed mathematical model.

Sets

D	set of disciplines (Immunology, Chemistry, Hematology, Coagulation)
M	set of machines (analyzers and non-analytical machines); $M = M^A \cup M^{NA} = M^A \cup M^{NA-C} \cup M^{NA-AT}$
M^A	set of analyzers (analytical machines); $M^A \subset M$
M^d	set of analyzers in discipline d ; $M^d \subset M^A$
M^{NA}	set of non-analytical machines; $M^{NA} = M^{NA-C} \cup M^{NA-AT}$ & $M^{NA} \subset M$
M^{NA-C}	set of centrifugation machines; $M^{NA-C} \subset M$
M^{NA-AT}	set of sorter (Automate) machines; $M^{NA-AT} \subset M$
H	set of tests (Calcium, Potassium, Chloride, etc.)
H^d	set of tests in discipline d ; $H^d \subset H$
Q	set of reagent bottle sizes (small, medium, large)

Indices

d	index of discipline; $d \in D = \{1, 2, \dots, l\}$
j	index of machine; $j \in M = \{1, 2, \dots, m\}$
h	index of test; $h \in H = \{1, 2, \dots, o\}$
s	index of reagent bottle size; $s \in Q = \{1, 2, \dots, q\}$

Parameters

HM_{hj}	$HM_{hj} = 1$, if test h can be potentially done by analyzer j ; otherwise $HM_{hj} = 0$
PC_j	the purchase cost of machine j
FC_j	the fixed cost of having machine j for a day in the laboratory
RC_{hsj}	the cost of a reagent bottle with size s used for test h in analyzer j

CC_{hj}	the calibration cost of test h on analyzer j
σ_{hj}	the average number of test h required to calibrate analyzer j
τ_j	the daily available working hours of machine j
g_j	the hourly capacity of analyzer j in terms of test (average number of tests that can be analyzed by analyzer j per hour)
φ_j	the average number of tubes that can be processed by non-analytical machine j per hour
TTC	the average number of daily requested tubes requiring centrifugation
TTA	the average number of daily requested tubes requiring sorting in the Automate
η	the average number of times that a tube passes through the Automate
RK_j	the reagent capacity of analyzer j (number of available reagent bottle positions)
δ_{hsj}	the average number of tests type h that can be analyzed using one bottle of reagent size s in analyzer j
λ_{hs}	the number of reagent positions occupied by reagent bottle h with size s
F_h	the average number of tests type h requested through all the daily requested tubes
ψ_j	the space required for machine j
A	the total space available
β	the total budget available

Decision variables

u_j	$u_j = 1$, if machine j is selected; otherwise $u_j = 0$
AOC_j	the operational capacity of analyzer j per day
x_{hsj}	the number of reagent bottles for test type h with size s positioned into analyzer j
y_{hj}	$y_{hj} = 1$, if test h is available on analyzer j ; otherwise $y_{hj} = 0$

2.3.3. Mathematical model

Minimize

$$\sum_{j \in M} FC_j u_j + \sum_{h \in H} \sum_{s \in Q} \sum_{j \in M^A} RC_{hsj} x_{hsj} + \sum_{h \in H} \sum_{j \in M^A} CC_{hj} y_{hj} \quad (1)$$

$$\text{Subject to } AOC_j \leq \tau_j g_j u_j ; \quad \forall j \in M^A \quad (2)$$

$$AOC_j \leq \sum_{h \in H} \sum_{s \in Q} \delta_{hsj} x_{hsj} ; \quad \forall j \in M^A \quad (3)$$

$$\sum_{j \in M^d} AOC_j \geq \sum_{h \in H^d} (F_h + \sum_{j \in M^d} \sigma_{hj} y_{hj}) ; \quad \forall d \in D \quad (4)$$

$$\sum_{j \in M^A} \sum_{s \in Q} \delta_{hsj} x_{hsj} \geq F_h + \sum_{j \in M^A} \sigma_{hj} y_{hj} ; \quad \forall h \in H \quad (5)$$

$$\sum_{h \in H} \sum_{s \in Q} \lambda_{hs} x_{hsj} \leq RK_j u_j ; \quad \forall j \in M^A \quad (6)$$

$$\sum_{s \in Q} \lambda_{hs} x_{hsj} \leq RK_j y_{hj} ; \quad \forall j \in M^A, h \in H \quad (7)$$

$$y_{hj} \leq HM_{hj} ; \quad \forall j \in M^A, h \in H \quad (8)$$

$$\sum_{j \in M^{NA-c}} \tau_j \phi_j u_j \geq TTC \quad (9)$$

$$\sum_{j \in M^{NA-AT}} \tau_j \phi_j u_j \geq \eta \cdot TTA \quad (10)$$

$$\sum_{j \in M} \psi_j u_j \leq A \quad (11)$$

$$\sum_{j \in M} PC_j u_j \leq \beta \quad (12)$$

$$u_j \in \{0,1\} ; \quad \forall j \in M \quad (13)$$

$$AOC_j \geq 0 ; \quad \forall j \in M^A \quad (14)$$

$$x_{hsj} \geq 0 \text{ and integer} ; \quad \forall h \in H, s \in Q, j \in M^A \quad (15)$$

$$y_{hj} \in \{0,1\} ; \quad \forall h \in H, j \in M^A \quad (16)$$

Equation (1) is the objective function minimizing the total daily operating costs of a laboratory including the cost of having machines, the machines configuration cost and the machines calibration cost. **Constraints (2) and (3)** demonstrate the operational capacity of each analyzer which can neither be more than the analyzer's nominal capacity [**Constraint (2)**], nor more than the capacity created by the number of reagent bottles assigned to the analyzer denoting the total number of tests that can be processed by the analyzer [**Constraint (3)**]. **Constraint (4)** assures that there is a sufficient capacity (capability to analyze a certain number of tests) in the laboratory to handle all the daily requested tests from different disciplines as well as the tests required for machines calibration. **Constraint (5)** guarantees that there are sufficient reagents in the selected analyzers to analyze each test. **Constraint (6)** assures that the number of reagent bottles positioned into each analyzer must not exceed the available number of reagent positions on each analyzer. **Constraint (7)** demonstrates whether test h is available on analyzer j or not, to provide useful information to compute the calibration cost of each test on the analyzers. **Constraint (8)** presents the potential eligibility of each analyzer to perform a test. Analyzers of each discipline are only able to analyze the tests belonging to the associated discipline. **Constraint (9) and Constraint (10)** are applied respectively to specify the number of centrifuge and Automate machines used in the laboratory to assure that there is enough capacity for pre-analytical operations on the tubes. **Constraint (11)** assures that the total space occupied by the machines must be less than the total available space in the lab. **Constraint (12)** guarantees that the total investment on machines must not exceed the total budget available. Finally, **Constraints (13) to (16)** imply the type of decision variables used in the model.

2.4. Model variation

The model proposed in the previous section is a general model to deal with the machine selection optimization problem for clinical laboratories. This model can be extended either by adding new constraints to the model or by relaxing an assumption. In this section, a practical variation is described in which the assumption on analyzer discipline is relaxed to take into account analyzers belonging to two disciplines.

2.4.1. Multi-part analyzers (Multi-discipline analyzers)

This model variation covers the case where analyzers belonging to more disciplines exist. In this state, each analyzer may have one or more parts indicating the analyzer discipline(s). For instance, an analyzer which belongs to both Immunology and Chemistry disciplines is considered as a single analyzer with two different parts in which tests of Immunology are analyzed by one part and the other part is responsible to analyze Chemistry tests. In addition, each part of an analyzer has a certain capacity for reagent bottles. [Figure 2-2](#) illustrates this instance.

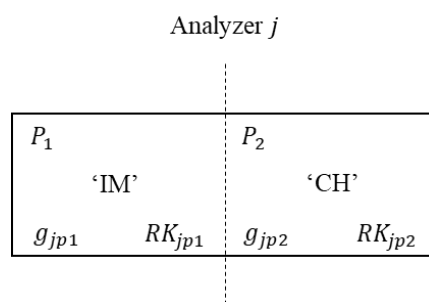

Figure 2-2. Example of an analyzer with two parts and useful notations.

To model this case, index p is defined to indicate the analyzer part. The capacity of each analyzer in terms of the eligibility to averagely perform a certain number of tests per hour and the number of positions to room reagent bottles are defined for each analyzer part through parameters g_{jp} and RK_{jp} , respectively. In addition, variables x_{hsjp} and y_{hjp} replace variables x_{hsj} and y_{hj} . It is worth noting that instead of defining the operational capacity for each analyzer, this term is defined for each part of the analyzer and characterized based on the following formula:

$$APOC_{jp} = \min\{\tau_j g_{jp} u_j, \sum_{h=1}^o \sum_{s=1}^q \delta_{hsj} x_{hsjp}\}$$

Where $APOC_{jp}$ denotes the operational capacity of part p of analyzer j in terms of the number of tests per hour.

Table 2-2 presents all the parameters and variables modified in the multi-part model variation in comparison with the initial proposed model.

Table 2-2. Modifications required to add multi-part analyzers.

<i>Notations used in</i>		<i>Explanation</i>
<i>initial model</i>	<i>multi-part model</i>	
g_j	g_{jp}	the average number of tests that can be analyzed by part p of analyzer j per hour.
RK_j	RK_{jp}	the number of reagent bottle positions in part p of analyzer j
HM_{hj}	HMP_{hjp}	$HMP_{hjp} = 1$, if test h can be potentially done by part p of analyzer j ; otherwise $HMP_{hjp} = 0$.
x_{hsj}	x_{hsjp}	the number of reagent bottle for test type h with size s assigned to part p of analyzer j .
y_{hj}	y_{hjp}	$y_{hjp} = 1$, if test h is available on part p of analyzer j ; otherwise $y_{hjp} = 0$.
AOC_j	$APOC_{jp}$	the operational capacity of part p of analyzer j per day.

In the following, the proposed mathematical model of the machine selection problem for clinical laboratory considering multi-discipline analyzers is presented. To fully understand the equations, refer to [section 2.3.3](#).

Minimize

$$\sum_{j \in M} FC_j u_j + \sum_{h \in H} \sum_{s \in Q} \sum_{j \in M^A} \sum_{p \in P} RC_{hsj} x_{hsjp} + \sum_{h \in H} \sum_{j \in M^A} \sum_{p \in P} CC_{hj} y_{hjp} \quad (17)$$

$$\text{Subject to } APOC_{jp} \leq \tau_j g_{jp} u_j ; \quad \forall j \in M^A, p \in P \quad (18)$$

$$APOC_{jp} \leq \sum_{h \in H} \sum_{s \in Q} \delta_{hsj} x_{hsjp} ; \quad \forall j \in M^A, p \in P \quad (19)$$

$$\sum_{j \in M^d} \sum_{p \in P} APOC_{jp} \geq \sum_{h \in H^d} (F_h + \sum_{j \in M^d} \sum_{p \in P} \sigma_{hj} y_{hjp}) ; \quad \forall d \in D \quad (20)$$

$$\sum_{j \in M^A} \sum_{p \in P} \sum_{s \in S} \delta_{hsj} x_{hsjp} \geq F_h + \sum_{j \in M^A} \sum_{p \in P} \sigma_{hj} y_{hjp} ; \quad \forall h \in H \quad (21)$$

$$\sum_{h \in H} \sum_{s \in Q} \lambda_{hs} x_{hsjp} \leq RK_{jp} u_j ; \quad \forall j \in M^A, p \in P \quad (22)$$

$$\sum_{s \in Q} \lambda_{hs} x_{hsjp} \leq RK_{jp} y_{hjp} ; \quad \forall h \in H, j \in M^A, p \in P \quad (23)$$

$$y_{hjp} \leq HMP_{hjp} ; \quad \forall h \in H, j \in M^A, p \in P \quad (24)$$

$$\sum_{j \in M^{NA-C}} \tau_j \varphi_j u_j \geq TTC \quad (25)$$

$$\sum_{j \in M^{NA-AT}} \tau_j \varphi_j u_j \geq \eta \cdot TTA \quad (26)$$

$$\sum_{j \in M} \psi_j u_j \leq A \quad (27)$$

$$\sum_{j \in M} PC_j u_j \leq \beta \quad (28)$$

$$u_j \in \{0,1\} , \forall j \in M \quad (29)$$

$$APOC_{jp} \geq 0 , \forall j \in M^A, p \in P \quad (30)$$

$$x_{hsjp} \geq 0 \text{ and integer} , \forall h \in H; s \in Q; j \in M^A, p \in P \quad (31)$$

$$y_{hjp} \in \{0,1\} , \forall h \in H; j \in M^A, p \in P \quad (32)$$

2.5. Model decomposition

Prior to solving the proposed mathematical model, a particular decomposition approach is introduced in this section which is originated from the model structure. This approach provides the possibility to decompose the main presented mathematical model into sub-models. As a result, the generated sub-models can be solved separately which might reduce the computational time. This decomposition is performed based on machines including analyzers and non-analytical machines and also within analyzers based on disciplines. To be able to decompose the main presented model in [section 2.3.3](#) into sub-models, [constraint \(11\)](#) and [constraint \(12\)](#) must be relaxed which link all machines to each other. Relaxing these constraints provides the possibility to decompose the model first based on machines and then within analyzers based on disciplines. Hence, number of sub-models is equal to the number of disciplines plus one. [Figure 2-3](#) presents the decomposition procedure.

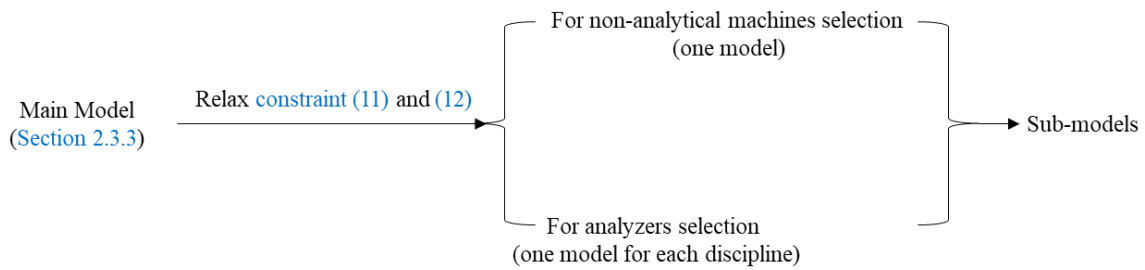

Figure 2-3. Model decomposition procedure.

Following the decomposition procedure, the next sub-model is used for non-analytical machines selection.

Minimize

$$\sum_{j \in M^{NA}} FC_j u_j \quad (33)$$

$$\text{Subject to } \sum_{j \in M^{NA-C}} \tau_j \varphi_j u_j \geq TTC \quad (34)$$

$$\sum_{j \in M^{NA-AT}} \tau_j \varphi_j u_j \geq \eta \cdot TTA \quad (35)$$

$$u_j \geq 0 \text{ and integer } , \forall j \in M^{NA} \quad (36)$$

In this sub-model, unlike the main model, decision variable u_j is a non-negative integer.

Additionally, the following model is used for each discipline to decide on the type and quantity of the selected analyzers. As there are four main disciplines, set of analyzer M^A is split into M^{IMM} , M^{CHEM} , M^{HEM} and M^{COAG} subsets denoting respectively Immunology, Chemistry, Hematology and

Coagulation set of analyzers. In the following model, each of these subsets can be applied instead of set X used in the model. In addition, set H^d denotes the set of tests belonging to discipline d .

Minimize

$$\sum_{j \in X} FC_j u_j + \sum_{h \in H^d} \sum_{s \in Q} \sum_{j \in X} RC_{hsj} x_{hsj} + \sum_{h \in H^d} \sum_{j \in X} CC_{hj} y_{hj} \quad (37)$$

$$\text{Subject to } AOC_j \leq \tau_j g_j u_j ; \quad \forall j \in X \quad (38)$$

$$AOC_j \leq \sum_{h \in H} \sum_{s \in Q} \delta_{hsj} x_{hsj} ; \quad \forall j \in X \quad (39)$$

$$\sum_{j \in X} AOC_j \geq \sum_{h \in H^d} (F_h + \sum_{j \in X} \sigma_{hj} y_{hj}) ; \quad d = IMM \text{ or } CHEM \text{ or } HEM \text{ or } COAG \quad (40)$$

$$\sum_{j \in X} \sum_{s \in Q} \delta_{hsj} x_{hsj} \geq F_h + \sum_{j \in X} \sigma_{hj} y_{hj} ; \quad \forall h \in H \quad (41)$$

$$\sum_{h \in H} \sum_{s \in Q} \lambda_{hs} x_{hsj} \leq RK_j u_j ; \quad \forall j \in X \quad (42)$$

$$\sum_{s \in Q} \lambda_{hs} x_{hsj} \leq RK_j y_{hj} ; \quad \forall j \in X, h \in H \quad (43)$$

$$y_{hj} \leq HM_{hj} ; \quad \forall j \in X, h \in H \quad (44)$$

$$u_j \in \{0,1\} ; \quad \forall j \in X \quad (45)$$

$$AOC_j \geq 0 ; \quad \forall j \in X \quad (46)$$

$$x_{hsj} \geq 0 \text{ and integer} ; \quad \forall h \in H, s \in Q, j \in X \quad (47)$$

$$y_{hj} \in \{0,1\} ; \quad \forall h \in H, j \in X \quad (48)$$

2.6. Model validation

2.6.1. Description of the case study

In this section, the aim is to find out the most proper machines to equip a clinical laboratory in which the daily average demand pattern is similar to the one described in chapter one, [section 1.6.1](#). According to the case study, the laboratory intends to cover only Immunology and Chemistry tests focusing on thirty-two different Immunology tests and forty different Chemistry tests. It is estimated that for a normal day, the total number of arriving tubes is 3,847 in average. This total is made of 458 Immunology tubes, 1,657 Chemistry tubes and 1,732 Immunology-Chemistry tubes on average.

Furthermore, the total number of requested tests of the arriving tubes is 28,632 which is made of 4,591 Immunology tests and 24,041 Chemistry tests averagely. The daily average number of requested tests for each test type is also given. Additionally, the requested tests of each tube are known which is demonstrated as Tube-Test matrix.

Although a market survey presents many options for Immunology and Chemistry machines, laboratory managers prefer to focus on nine different alternatives for Chemistry analyzers, and only two different alternatives for Immunology analyzers which are all single-discipline analyzers. In addition, for non-analytical machines, namely Centrifuge and Automate, two alternatives exist. All data related to machines such as purchasing price, test capability, test capacity, efficiency, and reagent bottle capacity are extracted from the machine manufacturer website and brochures.

Furthermore, bottles of reagent are available in two sizes for each test type. All required features of the reagent bottles are also extracted from brochures provided by the suppliers. It is worth noting that each reagent type is supplied by a single supplier.

2.6.2. Numerical results

As only single-discipline analyzers are of interest, the first mathematical model proposed in [section 2.3.3](#) is applied to select the most appropriate machines to equip the laboratory. The model is coded in GAMS 24.1.3 and CPLEX as a promising solver for mixed integer linear problems is used to solve the proposed model.

As the daily working hours of the laboratory have a direct impact on the machines capacity and consequently, on the system's total capacity, the model is solved for different daily working hours to provide useful insights for decision makers. [Table 2-3](#) presents the output results of solving the proposed mathematical model for three different daily working hours. According to the results, increase of daily working hours leads to less required machines to handle the total daily demand which brings less daily machine-related costs to the system.

Table 2-3. Numerical results.

	<u>Laboratory daily working hours</u>		
	<u>7 hours</u>	<u>8 hours</u>	<u>9 hours</u>
<i>Selected Immunology analyzers</i>	2 DxI800	1 DxI600 1 DxI800	1 DxI600 1 DxI800
<i>Selected Chemistry analyzers</i>	1 AU480 1 AU5822	1 AU480 1 AU5822	1 AU480 1 AU5822
<i>Selected Centrifuges</i>	5 CentrifugeT1	5 CentrifugeT1	4 CentrifugeT1
<i>Selected Automates</i>	2 AutomateT1	1 AutomateT1	1 AutomateT1
<i>Objective function value</i>	51.766	51.071	50.983

It is assumed that the clinical laboratory intends to work for eight hours per day. Figure 2-4 illustrates the selected machines² to equip the laboratory. In the following chapters, these selected machines constitute a part of the input data for the facility layout, analyzer configuration and assignment problems.

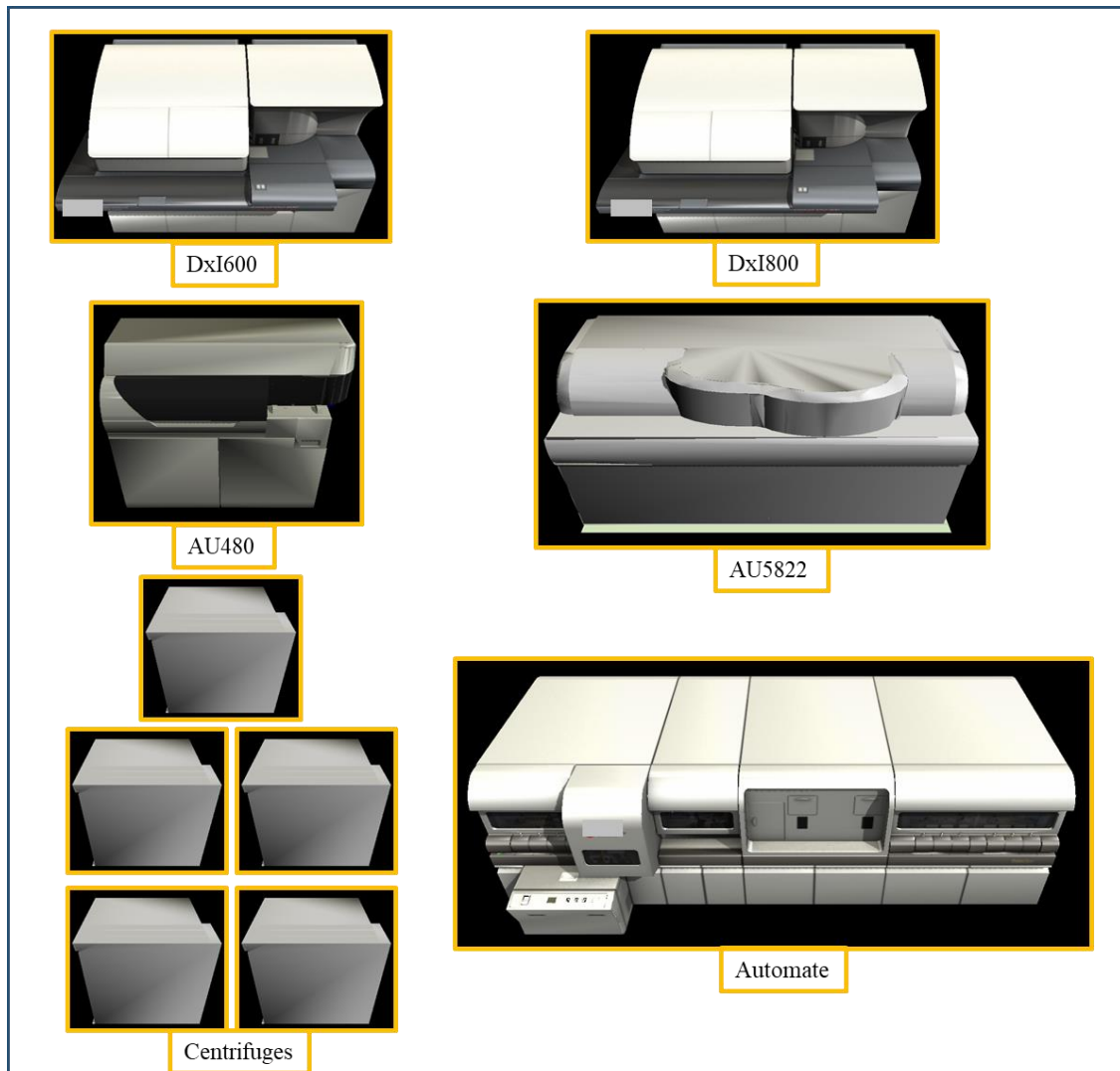

Figure 2-4. Selected machines to equip the clinical laboratory.

2.7. Conclusion

Machine selection is one of the most significant strategic problems for clinical laboratory design. Improper selection of machines can reduce the productivity, flexibility, responsiveness capabilities and finally, increase the operating costs of the laboratory. In this chapter, the machine selection problem for clinical laboratory was addressed with the aim of minimizing the total daily average machine-related costs of the system. Machine-related costs in a clinical laboratory are mainly made of total cost of

² DxI600, DxI800, AU480, AU5422, and Automate are Trademarks for machines manufactured by Beckman Coulter Company. Also, Machines' 3-D frames dedicate to Beckman Coulter company.

having the machines in the laboratory as well as total daily costs of analyzers' configuration and calibration. In order to tackle this problem, a single-objective linear mathematical model was proposed. The feasibility and validity of the proposed model was verified through a real case study. The output results provide a helpful insight for decision makers dealing with machine selection problem to efficiently equip a clinical laboratory.

To increase system reliability and flexibility, it is sometimes recommended to have a number of extra analyzers for a specific or all disciplines in the laboratory known as back-up analyzers. Finding out the best back-up alternatives while selecting the analyzers is a promising extension to the proposed mathematical model.

Chapter 3

Facility Layout Problem for Clinical Laboratories

Highlights:

- A part of this chapter has been filed as a US patent entitled '*System and method for clinical laboratory layout design*'.
- A part of this chapter has been accepted in *META2018* Conference in Marrakesh, Morocco, entitled '*A heuristic approach for standalone clinical laboratory layout design*'.

3.1. Introduction and literature review

Physical arrangement of facilities within an industrial system is one of the significant design problems which has a great effect on the efficiency and productivity of the system. This problem is known as the facility layout problem (FLP) and has been broadly investigated in the literature. In better words, FLP is defined as the placement of facilities in a plant area, with the aim of determining the most effective arrangement according to some criteria or objectives under certain constraints, such as shape, size, orientation, and pick-up/drop-off point of the facilities (Hosseini-Nasab et al., 2018). There have been some discussions on the nature of the layout problem among specialists. Some experts believe that the facility layout is exclusively a design problem as only a satisfying solution is interesting. While others are interested to find the optimal layout conceiving the facility layout as an optimization problem. Heragu (2008) describes the facility layout as a problem owning the characteristics of both optimization and design problem. In this respect, a two-phase approach has been introduced where the layout problem is considered as an optimization problem in the first phase and some preliminary solutions are generated using optimization techniques; then, in the second phase, factors ignored by the optimization method are included to modify the initial solutions in a proper manner.

Many variations of the FLP have been introduced and studied over the last six decades (Drira, 2007). Section 3.1.1 describes several types of FLP in brief. Afterwards, modeling and resolution approaches to tackle this problem are illustrated in section 3.1.2 and section 3.1.3, respectively.

3.1.1. FLP variations

Many factors take part in characterizing the FLP. System specifications, the decision maker's viewpoint over the planning horizon (static vs. dynamic), layout representation (discrete vs. continuous) and distance calculation (rectilinear, Euclidean) and finally, the number of target objectives (single-objective vs. multi-objective) are the most important influencing factors on the FLP characterization (Drira, 2007).

3.1.1.1. System characteristics impacting the FLP

An inevitable relation exists between the layout problem and system attributes. Hence, the FLP is affected by the shape and dimensions of facilities, type of material handling system, pick-up and drop-off locations of facilities, the existence of bypassing and backtracking in the flow line of material and the number of floors in the plant area (Hosseini-Nasab et al., 2018). Each of these issues is briefly discussed in the following:

Facility shape and dimensions - Generally, two different facility shapes are identified: regular and irregular (Figure 3-1). Regular shapes are mostly modelled by rectangles (Kim and Kim, 2000) and irregular ones by polygons containing at least a 270° angle (Lee and Kim, 2000). In addition, a facility

can be considered as a rigid block with given dimensions described by a fixed length and a fixed width (Chwif et al., 1998), or can be defined by its area, its aspect ratio, an upper bound and a lower bound (Meller et al., 1999).

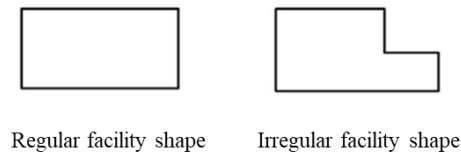

Figure 3-1. Regular and irregular facility shapes [Drira et al., 2007].

Material handling system - Movement and delivery of materials in a production system is carried out by material handling system. Facility layout and material handling equipment selection are two interconnected problems as they can be decided jointly (Co et al., 1989); however, due to the computational complexity of the integrated model, sequential approaches have been mostly used to determine the most suitable layout as well as material handling equipment (Hassan, 1994). The type of material handling system and flow of material through the system have a great impact on the facility layout as facilities are arranged along with the material flow paths (Devise and Pierreval, 2000). In this regard, single-row, multi-row, loop and open-field layouts are distinguished (Figure 3-2 (a)).

Pick-up and drop-off locations - Points from which a system's entities enter or leave a facility are known as pick-up and drop-off locations (Figure 3-2 (b)). Potentially, these points can be considered at different places of a facility (Kim and Kim, 2000) but, to reduce the problem complexity, many researchers narrow down the possible positions (Rajasekharan et al., 1998).

Backtracking and bypassing - In flow-line layouts where entities follow consecutive production stages one after another, two particular movements might occur, called backtracking and bypassing (Figure 3-2 (c)). Backtracking is a movement of an entity from one stage to one of the preceding stages in a flow-line arrangement (Braglia, 1996). Minimizing such movements has been addressed as production line formation problem (Zhou, 1998).

Bypassing is a movement of a part from one stage to a stage ahead skipping one or more stages in between (Chen et al., 2001). These specific movements can affect the FLP.

Multi-floor layout - According to the number of floors in the plant area, the facility layout can be addressed as a single-floor or multi-floor problem (Ahmadi et al., 2017). Basically, multi-floor layouts are created due to the limitation of available horizontal space in the workshop. Therefore, facilities can be placed vertically in multi floors which imposes vertical transportation in the system and consequently, a need for vertical transportation devices such as elevator. Figure 3-3 depicts a multi-floor layout problem.

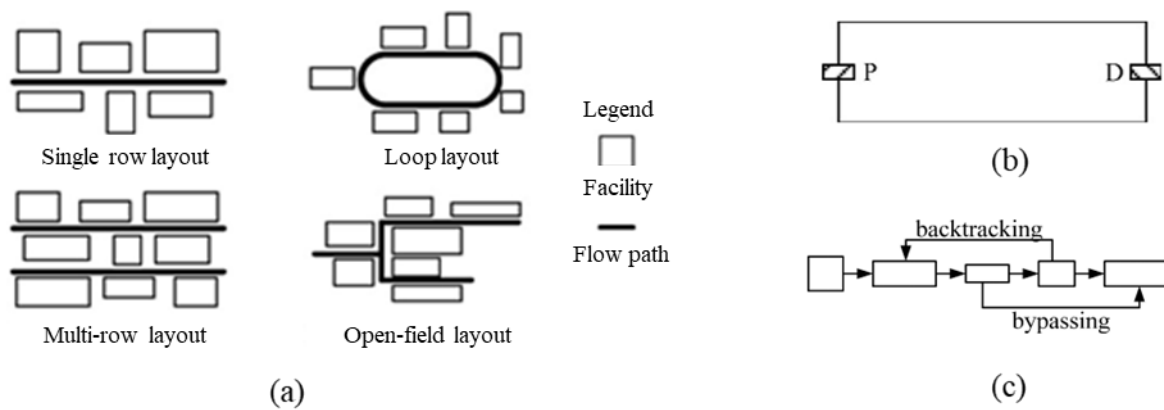

Figure 3-2. (a) Flow patterns and FLP. (b) Facility pick-up and drop-off locations. (c) backtracking and bypassing [Drira et al., 2007].

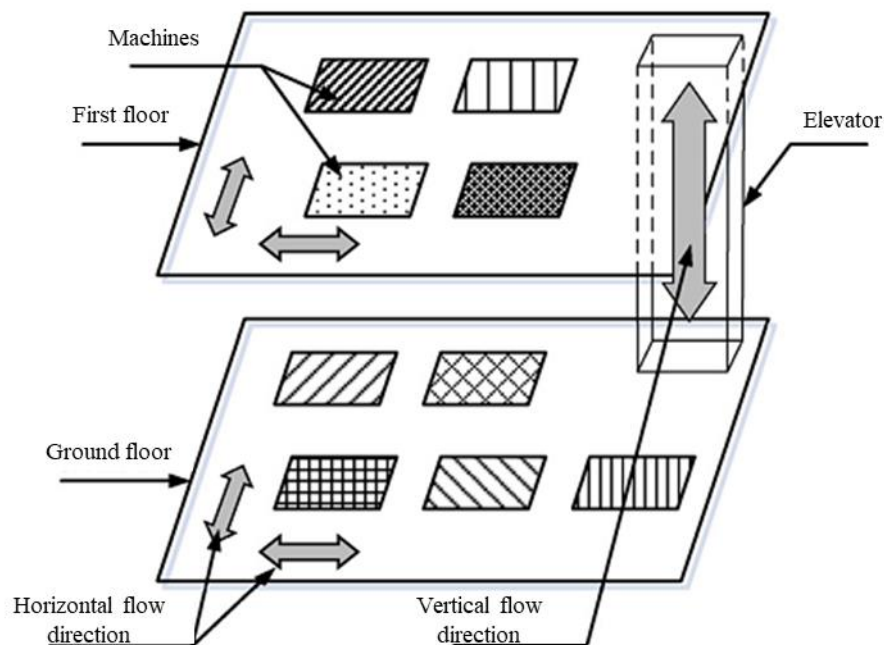

Figure 3-3. Multi-floor layout [Drira et al., 2007].

3.1.1.2. Static vs. dynamic FPL

FLP is one of the strategic decision problems for industrial system design. Layout transformation imposes excessive expenses to the system; nevertheless, facility layout alteration is justifiable for some cases to respond quickly to changes in demand, production volume and product mix. Hence, unlike the static FLP which brings a fixed layout for the whole planning horizon, the dynamic FLP divides the planning horizon into time periods and attempts to find out the most appropriate layout for each period taking into account the rearrangement costs between the periods (Balakrishnan and Cheng, 1998).

3.1.1.3. Discrete vs. continuous FLP

In discrete layout representation, the plant area is discretized into a certain number of rectangular blocks with the same area and shape and then, each facility is assigned to one block for facilities with equal

areas or to more blocks for facilities with unequal areas. Due to the rigid assumptions and limitations of discrete layout representation, such kind of modeling is not suitable for practical problems. In other words, discrete representation of FLP is unable to determine the exact location of each facility within the plant area and cannot model the clearance and orientation constraints. Therefore, the continuous representation has been attended by several scholars which is more suitable for practical cases (Das, 1993; Dunker et al., 2005). Continuous FLP are often characterized as mixed integer programming problems (Das, 1993).

In the continuous representation, to compute the distance between two facilities, facility centroid (x_i, y_i) or facility pick-up point (x_i^p, y_i^p) and drop-off point (x_i^d, y_i^d) are considered as the reference points. Basically, two norms are applied to calculate the distance between two facilities: the Euclidean norm and the rectilinear norm (Figure 3-4).

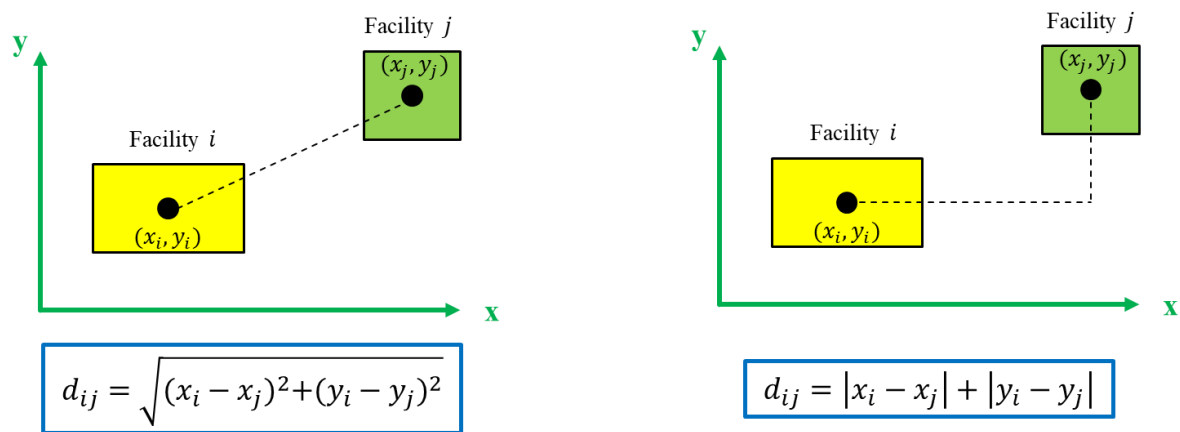

Figure 3-4. Euclidean and rectilinear norms.

3.1.1.4. Single-objective vs. multi-objective FLP

Minimizing the total material handling costs is the most-used objective function among the researchers tackling the FLP. Beside this objective, some other objectives such as maximization of an adjacency function have been considered to address the facility layout as a multi-objective optimization problem (Aiello et al., 2006).

3.1.2. Modeling approaches for the FLP

To formulate the FLP, various mathematical models have been developed in the literature which can be classified into following seven classes (Hosseini-Nasab et al., 2018):

- Quadratic Assignment Problem (QAP)
- Quadratic Set covering Problem (QSP)
- Linear Programming (LP)
- Integer Programming (IP)

- Mixed Integer Programming (MIP)
- Nonlinear Programming (NLP)
- Graph Theoretic Problem (GTP)

Quadratic assignment problem (QAP) presented by Koopmans and Beckman is one of the earliest efforts to specify the best location of each facility in the plant area through assigning the facilities to the pre-specified locations with equal sizes (Koopmans and Beckmann, 1957). The mathematical formulation of this problem is presented as follows:

$$\begin{aligned} \text{Minimize} \quad & \sum_{i=1}^n \sum_{j=1}^n \sum_{\substack{k=1 \\ i \neq k}}^n \sum_{\substack{l=1 \\ j \neq l}}^n f_{ik} c_{jl} x_{ij} x_{kl} \\ \text{Subject to} \quad & \sum_{j=1}^n x_{ij} = 1; \quad i = 1, 2, \dots, n \\ & \sum_{i=1}^n x_{ij} = 1; \quad j = 1, 2, \dots, n \\ & x_{ij} \in \{0, 1\}; \quad i, j = 1, 2, \dots, n \end{aligned}$$

Where the notations used are defined as follows:

Parameters

n	total number of facilities and locations
f_{ik}	flow of material from facility i to facility k
c_{jl}	cost of transporting unit material from location j to location l

Decision Variable

x_{ij}	takes 1, if facility i is assigned to location j ; otherwise, takes 0
----------	---

Although different variations of QAP have been proposed in the literature, this modeling approach is not suitable for practical cases. The following reasons make the QAP an improper approach to deal with a layout problem for a real-life case:

- In QAP, facilities have regular shapes with equal areas but, in real instances, facilities might have irregular shapes with different unequal areas.
- In QAP, the plant area has been discretized into a certain number of locations with equal areas; however, the way of discretization is a problem by itself.
- QAP is not able to determine the exact location of the facilities and only provides a relative layout; however, in practice, the exact location of facilities is demanding.

- QAP cannot handle clearance and orientation constraints which are of importance from a decision maker's perspective.

To overcome the QAP drawbacks, several other mathematical models were developed. QSP deals with the layout problem with unequal-sized facilities and discrete representation (Moslemipour et al., 2012). To cope with a layout problem with continuous representation and unequal-sized facilities, MIP is an appropriate model to formulate the FLP. Heragu (2008) proposed nonlinear mathematical models to formulate the FLP considering facilities with equal or different areas in single-row or multi-row layout. For more information about the application of different mathematical formulations for FLP refer to (Anjos and Vieira, 2017).

3.1.3. Resolution approaches for the FLP

Approaches developed to cope with single-objective FLP, either quantitative or qualitative, can be widely classified into the following four groups (Singh and Sharma, 2006):

Exact approaches - Exact approaches are useful to find optimal solutions only for small-scale problems. Branch and bound, dynamic programming, cutting plane algorithm and semidefinite programming are examples of exact algorithms for FLPs.

Stochastic approaches - Stochastic approaches provide near-optimal solutions with high probability. Discrete event simulation (DES) is an example for a stochastic approach. Generally, simulation studies are mostly used to evaluate the performance of given layouts (Aleisa and Lin, 2005). As some instances for the application of this approach for FLP, a simulation optimization approach based on a genetic algorithm and computer simulation was proposed by Wang et al. (2008). Efficiency of the proposed approach was evaluated through a case study. To resolve a layout problem in a job-shop manufacturing environment, Azadeh et al. (2011) developed an integrated approach based on computer simulation and data envelopment analysis (DEA). In this study, a simulation model was applied to measure the performance of different layout alternatives and DEA was used to rank the evaluated alternatives to determine the best layout design. In another study, Azadeh et al. (2015) introduced an integrated computer simulation-stochastic DEA to cope with the job-shop facility layout problem considering safety and environmental factors.

Approximated approaches - The complexity of the FLP is known as NP-complete indicating that exact algorithms are not efficient for medium and large scale instances (Kusiak and Heragu, 1987). Therefore, approximated approaches have been developed to provide reliable sub-optimal solutions within a reasonable amount of time. Generally, approximated approaches are classified into three categories:

- Construction algorithms: These heuristic algorithms are used to create an initial solution from scratch. Most of these algorithms follow a procedure including ordering and placing facilities

until a complete layout with all existing facilities is acquired. These algorithms provide only one solution with no guarantee for optimality. Hence, the result of these algorithms is considered as an initial solution for improvement algorithms. The automated layout design program (ALDEP) (Seehof and Evans, 1967), the computerized relationship layout planning (CORELAP) (Lee and Moore, 1967) and the programming layout analysis and evaluation technique (PLANET) (Tompkins and Reed, 1976) are examples of construction algorithms.

- Improvement algorithms: These heuristic algorithms start with an initial solution and try to improve the quality of the solution, mainly through exploring feasible swaps. Pair-wise exchange, the computerized relative allocation of facilities technique (CRAFT) (Armour and Buffa, 1963), insertion neighborhood, the Lin–Kernighan neighborhood, and computerized facility aided design (COFAD) (Tompkins and Reed, 1976) are some of the well-known examples of improvement algorithms in FLP literature (Hosseini-Nasab et al., 2018).
- Meta-heuristic algorithms: These algorithms are able to find optimal or near-optimal solutions in a reasonable period of time. Tabu search, ant colony optimization, genetic algorithm and simulated annealing are the most-used meta-heuristics for FLP (Kundu and Dan, 2012). For instance, to solve a stochastic multi-period FLP, Moslemipour et al. (2018) developed an integrated approach in which a simulated annealing algorithm starts with a population of acceptable initial solutions generated by combining ant colony, clonal selection and robust layout design approaches. Guan and Lee (2016) proposed a hybrid algorithm based on variable neighborhood search and ant colony optimization to solve a single-row facility layout problem. Sharma and Singhal (2016) investigated the application of various meta-heuristic approaches for FLP and published the results as a survey article.

Artificial intelligence approaches - Expert systems and artificial neural networks are the most significant artificial intelligence approaches used for FLP (Hosseini-Nasab et al., 2018).

Figure 3-5 summarizes various aspects of the FLP as well as different resolution approaches.

The rest of this chapter is organized as follows: The problem of facility layout design for clinical laboratories with a standalone sorter is comprehensively described in section 3.2. In Section 3.3, the proposed heuristic approach to tackle the problem is explained. Section 3.4. includes the experimental results obtained from solving the layout design problem for the case study introduced in chapter one using the proposed heuristic algorithm. Finally, section 3.5 concludes the chapter.

Before introducing the FLP for standalone Automate clinical laboratory, it is worthy to remind that in laboratories using standalone sorter (Automate), tubes and racks movements are done by laboratory staff.

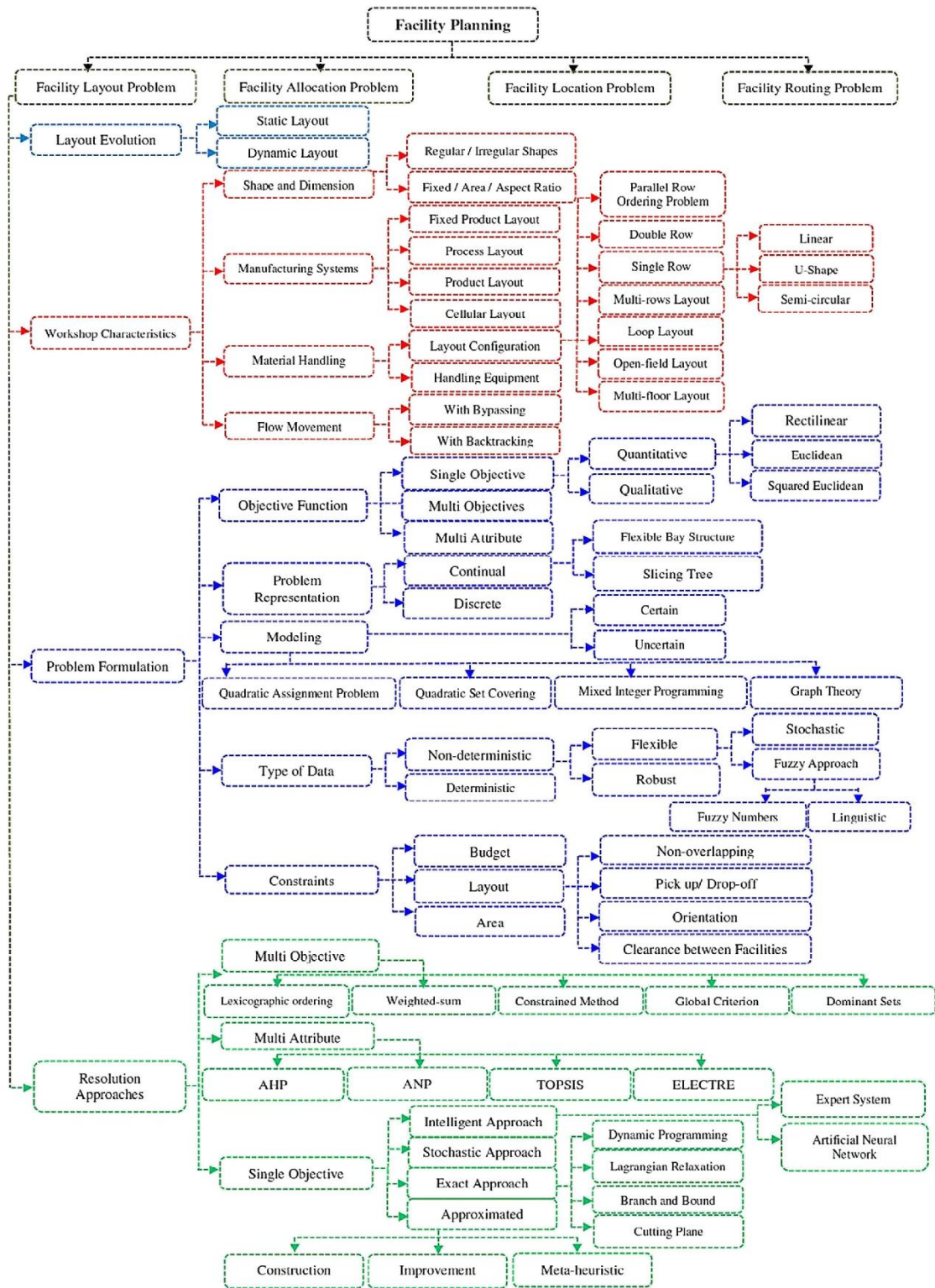

Figure 3-5. Facility layout problem representation tree [Hosseini-Nasab et al., 2018].

3.2. Facility layout design for clinical laboratories with a standalone Automate

Generally, the facility layout problem deals with the physical arrangement of facilities within an area. The physical arrangement of facilities comprises the specification of location and orientation of each facility to optimize one or more objectives respecting different types of constraints. Specifically, the layout design problem of a standalone clinical laboratory is defined as specifying the location and orientation of each instrument within the laboratory area to minimize the total traveling distance satisfying physical, technical and organizational constraints. Hereafter, the layout design problem of a standalone clinical laboratory is described with more attention to details.

3.2.1. Definitions and problem assumptions

In this section, related definitions and problem assumptions are discussed in the form of two classes: laboratory area-related and facility-related definitions and assumptions.

3.2.1.1. Laboratory area-related definitions and assumptions

- Laboratory area is a single-floor place where facilities are arranged. This area is given and can have any shape either simple or complex polygons. To create a real-shape laboratory area, a discretized rectangular area is first considered. Then, some places are removed to obtain the real shape.
- The positions of occupied areas within the laboratory area is given. In better words, positions occupied by pillars, pre-located facilities, etc. are known, so that no other facilities can be placed there.
- The entrance is a place where tubes are brought into the laboratory. The location of the entrance is given. The entrance can be any place among the laboratory area boundaries or even any place in the middle of the laboratory. Generally, for the case where entrance is located in the middle, a pneumatic system is used to deliver the arriving tubes.

Figure 3-6 presents an example of a discretized laboratory area where facilities can be only placed on white cells indicating free places.

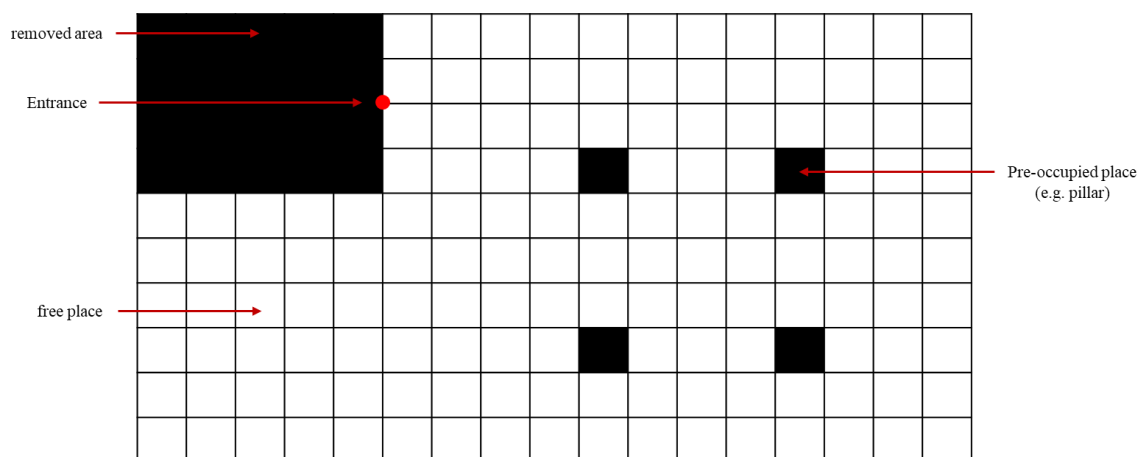

Figure 3-6. Example of a laboratory area.

3.2.1.2. Facility-related definitions and assumptions

- Facility is a general term referring to workstation, machine, instrument, workbench, etc. In this chapter, the aim is to efficiently arrange facilities with different sizes within the laboratory area.
- All facilities are considered rectangular with known dimensions. Each facility is discretized based on the discretization scale so that a facility may occupy one or more free places within the discretized laboratory area. Once a facility is placed within the laboratory area, a cell is considered as the connecting point (I/O) of the facility with the other facilities. This cell of the facility is called centroid, which can be any cell of the facility block and is used for distance computation between facilities.
- A clearance is defined for each facility. This clearance is simply added to the size of the facility.
- The orientation of each facility is not known a priori and is determined by the algorithm. It is worth noting that only two orientations are possible for a facility: horizontal and vertical.
- Each facility is associated with a discipline implying that facilities with the same discipline must place adjacent enough in one site in a way that at least each facility is neighbour with a facility with a similar discipline.
- The distance between centroids of any two facilities is the rectilinear distance (the Manhattan distance) as it fits more realistic while presenting staff movements between facilities inside the laboratory.
- The relationship between each pair of facilities is demonstrated by a quantitative asymmetric flow matrix. The values of this matrix could present the average number of tubes transported from one point to another or the average time an operator travels between two points.

3.2.2. Objective function

The objective is to arrange all facilities within the laboratory area in a way that the total traveling distance among facilities is minimized. The total traveling distance among facilities is calculated by [equation \(1\)](#):

$$\sum_{e \in E} \sum_{\substack{e' \in E \\ e' \neq e}} f(e, e') * d(c_e, c_{e'}) \quad (1)$$

Where E is the set of facilities; e and e' denote the facilities as the members of E ; c_e and $c_{e'}$ imply the centroids of facilities e and e' , respectively; parameter $f(e, e')$ denotes the flow between the facility pair (e, e') ; variable $d(c_e, c_{e'})$ denotes the distance between the centroids of facility pair $(c_e, c_{e'})$ which directly depends on the locations of facilities e and e' .

3.2.3. Problem constraints

The problem constraints are discussed in three groups: physical, technical and organizational constraints. Hereafter, each of these constraints is presented:

- *Physical constraints* imply that overlapping is not acceptable between each pair of facilities and between each facility and a pre-occupied place.
- *Technical constraints* deal with the required clearance for each facility which must be respected from a technical or safety point of view.
- *Organizational constraints* deal with the adjacency of facilities with similar disciplines in the proposed layout; hence, it is also called '*adjacency constraints*'. According to this constraint, all facilities of the same discipline must be placed adjacent enough in one site of the laboratory area in a way that at least each facility is neighbour with a facility with similar discipline. Unlike two other constraints which are mostly common for most of facility layout problems, this constraint originates from the clinical laboratory organization.

3.3. Resolution approach

Since the facility layout problem lies in NP-complete class in terms of problem complexity, mathematical programming approaches are not efficient for large-scale problems. Hence, in this thesis, a heuristic approach is developed to tackle the facility layout problem in a standalone Automate clinical laboratory. This heuristic has been inspired from the computerized relationship layout planning (CORLAP) algorithm. CORELAP is a qualitative construction algorithm by which an initial solution is proposed for FLP (Lee and Moore, 1967). In this study, an enumerative construction method is firstly applied to reach initial efficient solutions. This method is the integration of a construction method inspired from CORELAP and the Branch and Bound (B&B) algorithm. Secondly, initial solutions are compared with the best available solution and consequently, a certain number of diverse solutions are excerpted which look differently in the final arrangement. Finally, the selected solutions are improved through 2-opt algorithm. In brief, the proposed approach is constructed based on the following three steps:

- Generation of initial solutions
- Selection of diverse solutions
- Improvement of the selected solutions

Steps of the proposed heuristic approach is described in the following sections with more attention to details.

3.3.1. Generation of initial solutions

Basically, generating initial solutions includes two phases: (i) facility sorting, (ii) facility placement.

3.3.1.1. Facility sorting

The first step is to sort the list of all facilities to specify the order of their placement in the laboratory area to build the layout. Basically, this order follows the way material (tubes, information) flows through the system. In addition, information flow implies the test results communicated between the analyzers and the corresponding validation consoles which causes operator movement between them. Subsequent rules are used to characterize this order:

1. The facility '*registration*' lies always in the head of the sorting list. In fact, '*registration*' is a place where arriving tubes are registered to the laboratory information system (LIS).
2. Considering the latest facility added to the sorting list, the facility which has the most connections (from and to) with the previous one is then selected. If no connection is found, rule 3 is triggered.
3. The facility with the highest total closeness rating (TCR) is selected. The term '*TCR*' has been introduced in the CORELAP algorithm (Lee and Moore, 1967) and it is computed from the flow matrix, as the sum of input and output flows for each facility. In a case of a tie, a facility is selected randomly.
4. Rules 2 and 3 are iterated until all facilities are sorted.

After the sorting phase, facilities are selected one after another from the sorting list and placed within the laboratory area respecting the existing constraints.

3.3.1.2. Facility placement

This phase is composed of a construction algorithm combined with a B&B method. The aim of this combination is to generate diverse initial solutions to provide alternatives for decision makers. Following rules must be respected in order to achieve feasible efficient solutions:

1. Facility '*registration*' which is always first in the sorting list is placed next to the entrance.
2. Once facilities are placed, a neighbourhood is created around the located facilities. This neighbourhood area indicates the possible places to put the centroid of the new coming facility into the layout. Regarding the type of new coming facility, the existing neighbourhood may be reduced to the free places which are next to the pre-located facilities with the same discipline to meet the adjacency constraints. For each place of the neighbourhood, a score is computed considering distance and flow between the new coming facility and the other already placed ones. Note that the lowest score shows the best place to locate the centroid of the facility.

3. The neighbourhood of the selected place is searched to verify if there is enough space to room the facility or not. If there is sufficient room, then, the facility is placed and the required places are occupied. Finally, the score of the partial solution is updated. Note that this score is the value of the objective function.

4. Rules 2 and 3 are iterated until all facilities are placed within the laboratory area.

To illustrate how facilities are placed via the proposed algorithm, take the following example. Suppose that three blue, green and purple facilities have been placed and facilities blue and green belong to the same discipline (Figure 3-7 (a)). Now, the aim is to place the red facility which also belongs to the same discipline as blue and green. Figure 3-7 (b) presents the neighbourhood on which the centroid of the red facility can be potentially placed. To maintain the adjacency constraint among facilities of the same discipline, only free cells in the neighbourhood of the blue and the green facility are dotted as the potential places for the centroid of the red facility. To find out the best place of the centroid of the red facility, the score of all the potential places must be calculated through equation (1). In Figure 3-7 (c), Considering A , B , and C black circles as the centroids of blue, green and purple facilities respectively, the scores of potential places D and E are computed as $S_D = 3f_{AD} + 2f_{BD} + 3f_{CD}$, and $S_E = 3f_{AE} + 4f_{BE} + f_{CE}$, respectively. Suppose that $S_E < S_D$, so, cell E is the best candidate to locate the centroid of the red facility. To locate the red facility there, both horizontal and vertical orientations are possible (Figure 3-7 (d)). If possible, the horizontal orientation is selected by default. Once a facility is placed, the locations used are set as occupied.

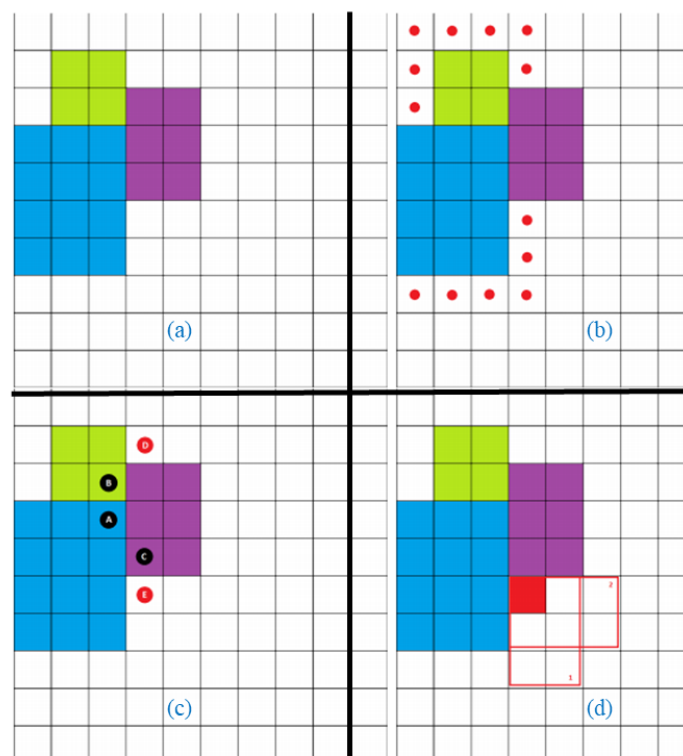

Figure 3-7. Illustration of facility placement via the proposed algorithm.

It is worth noting that always selecting the best location for facility placement might lead to an infeasible solution or in the best state, to a single solution. In order to generate more initial solutions, the aforementioned placement algorithm is integrated with a B&B method. To do so, instead of placing a facility's centroid in the best place of the neighbourhood in rule 2, the set of suitable places in the neighbourhood is selected, far enough from one another to maintain diversity and to control combinatorial expansion of the tree of possibilities and then, from all of these potential places, a partial solution is created. Take Figure 3-8 as an instance. In Figure 3-8 (a), three points of the neighbourhood have been selected to place the centroid of the next facility and in Figure 3-8 (b), possible placements of the next facility which is brown is shown.

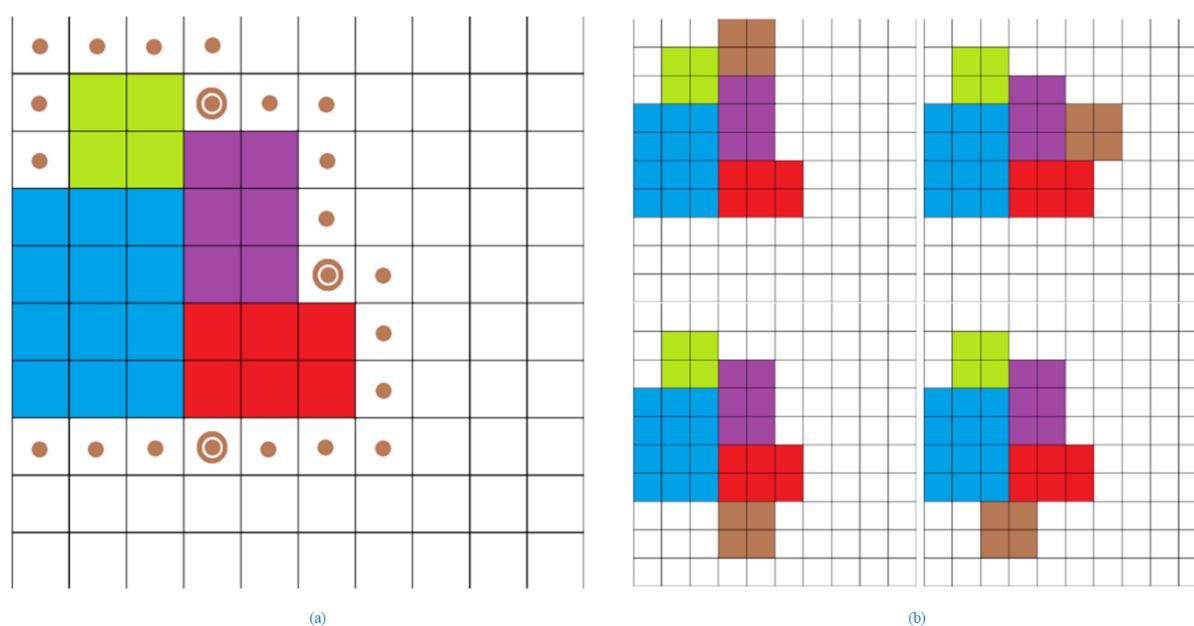

Figure 3-8. Illustration of generating more solutions through considering more potential points in the neighbourhood.

Different parameters control the expansion of partial solutions enumeration. The first one is the number of possible places in the neighbourhood from which the solution can be extended. The second one is the minimum distance between two selected possible points to do the extension. Furthermore, once a place is selected to locate the centroid of the facility, the facility may take horizontal or vertical orientation which is considered as one of the third expansion possibility.

For each generated partial solution, the score is computed through equation (1). All the generated partial solutions are extended from the best to the worst one until either they reach a final solution or terminate with one of the stop criteria. Partial solution expansion is stopped for a branch (the branch is cut) if the score of this solution is worse than another existing solution with more facilities. In addition, once not enough space is available to fit the new coming facility, the branch is terminated. Figure 3-9 presents a tree of possibilities resulting from the integration of the branch and bound method to the proposed algorithm to generate several solutions.

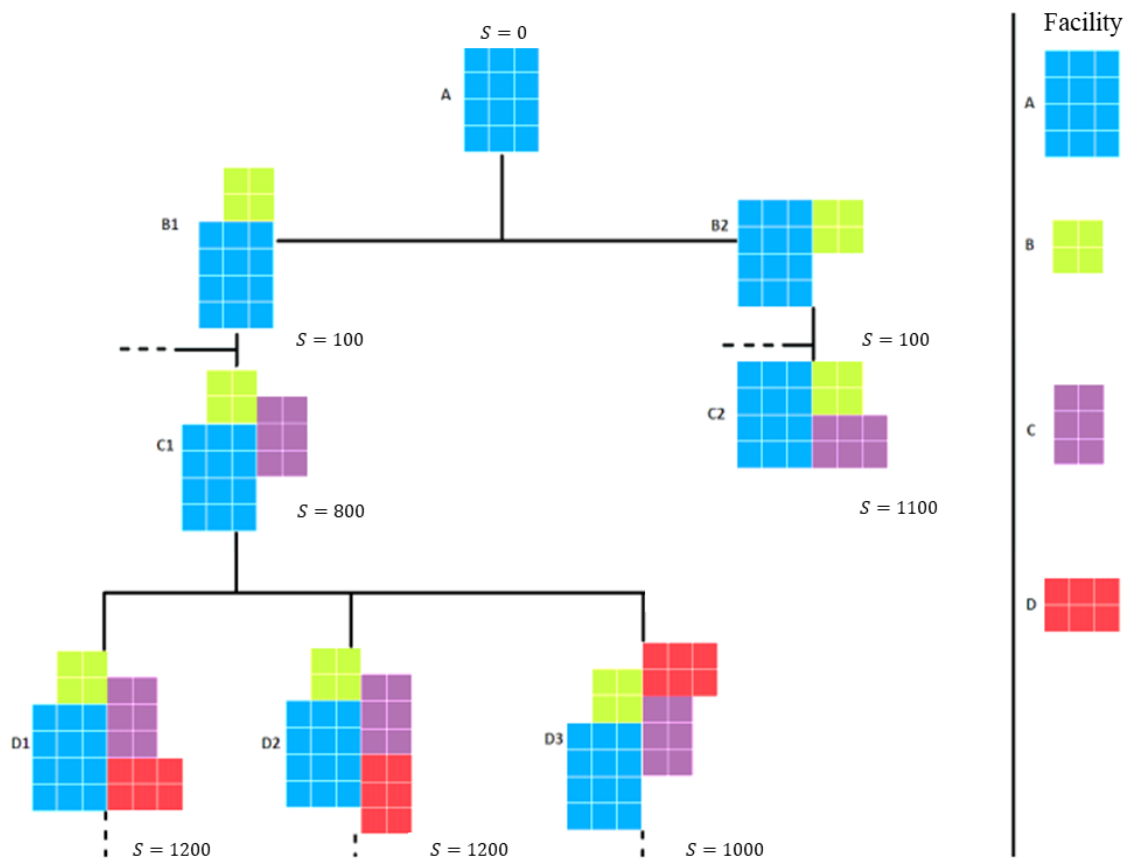

Figure 3-9. An illustrative example for the tree of possibilities in the placement procedure.

3.3.2. Selection of diverse solutions

Most of the generated initial solutions look similar. To provide decision makers efficient solutions with more diversity, solutions are compared based on a diversity measure. This measure is defined as the sum of distances between gravity centers of each discipline in two different solutions.

To avoid comparing each pair of solutions, the best solution is automatically selected. Then, from the second best to the other solutions, solutions which are diverse enough compared to the ones already selected are excerpted. These comparison and selection actions continue until all solutions are investigated.

3.3.3. Improvement of the selected solutions

In this step, all the selected solutions are improved through a 2-opt algorithm. This algorithm deals with swapping facilities with equal sizes. In other words, only facilities which occupy the same number of free cells within the discretized laboratory area can be swapped. A swap is acceptable if it leads to a solution with better value for the objective function. All possible swaps are done until no more swap is possible.

To maintain the discipline adjacency constraint without checking all facilities neighbourhood for each swap, for each discipline, an adjacency graph is maintained. Each facility of a discipline is a node of this graph and the adjacency between facilities is an edge between the two associated nodes. When switching facilities from different disciplines in the laboratory, the associated graphs are modified. Fulfilment of the adjacency constraint among the facilities of a similar discipline is verified through checking if the associated graph is still connected or not, once a swap is made.

3.4. Experimental results

In this section, the aim is to propose an efficient layout for clinical laboratory instruments within the laboratory area in which the total traveling distance of the operators is minimized respecting all three physical, technical and organizational constraints. Figure 3-10 presents the plan of the laboratory area. Two potential entrances ($E1$ and $E2$) are proposed for the laboratory. Therefore, for each entrance option, a layout design is proposed.

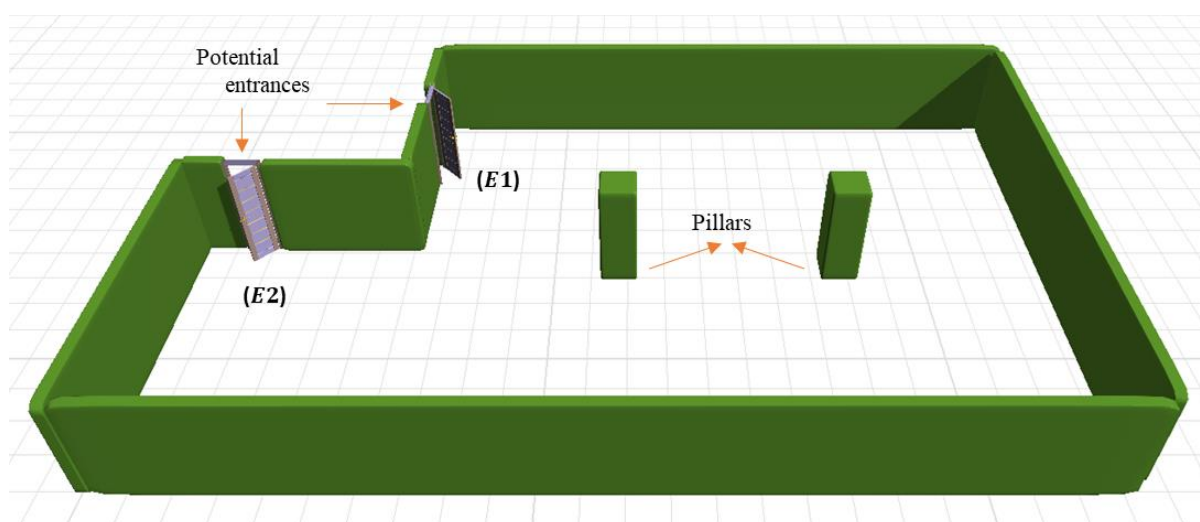

Figure 3-10. Laboratory area.

Laboratory instruments include the selected machines in the previous chapter as well as other necessary facilities to construct a complete laboratory. In better words, a complete laboratory needs more facilities than analytical and non-analytical machines. These extra facilities are registration desks, rack-making desks, validation consoles, and a fridge as tube storage. The registration desk is a place where arriving tubes are checked and registered to the laboratory information system. The rack-making desk is a place where the tubes are racked. The validation station is a place where the tests result is verified by specialists. Generally, number of validation stations in a laboratory equals the number of test disciplines covered by the laboratory. Finally, fridge is a place where treated tubes are stored for a certain period of time for potential rerun request before being disposed. Table 3-1 contains all the facilities required to be arranged within the clinical laboratory. All facilities are rectangular with fixed length and width. The clearance required for each facility is given.

Table 3-1. All clinical laboratory instruments.

<i>Facility</i>	<i>Number</i>	<i>Length (cm)</i>	<i>Width (cm)</i>	<i>Clearance (cm)</i>
<i>Registration desk</i>	2	150	110	50
<i>Rack-making desk_C</i>	1	150	100	50
<i>Centrifuge</i>	5	100	100	70
<i>Re-racking desk_A</i>	1	180	100	50
<i>Automate</i>	1	450	170	100
<i>AU480</i>	1	145	77	100
<i>AU5822</i>	1	366	158	100
<i>DxI600</i>	1	171	97	100
<i>DxI800</i>	1	171	97	100
<i>Validation station_I</i>	1	150	110	50
<i>Validation station_C</i>	1	150	110	50
<i>Fridge</i>	1	200	200	100

In a standalone clinical laboratory, tube racks are transported among the facilities by the operators either by hand or by trolley. Generally, operators move within the laboratory for two purposes: (i) rack transportation and (ii) test validation. Relations between facilities are demonstrated through a flow matrix in which the elements represent the average number of operator movements between two facilities either for rack transportation or test validation taking into account the main flow of tubes within the system. In most cases, the flow of tubes starts at registration and after passing through rack-making desk, centrifuge machine, re-racking desk, sorter (Automate) and analyzers, it ends at fridge. A usual backtracking exists between analyzers and re-racking desk where the tube racks are changed to be sent to the sorter again.

The aim of layout design is to minimize the total staff movement within the laboratory area satisfying all the existing constraints. To propose a feasible efficient layout design, the proposed heuristic algorithm introduced in the previous section is applied. The algorithm is coded and run in Java programming language and takes a few seconds to provide solution. [Figure 3-11](#) and [Figure 3-12](#) present the best found solution for the layout optimization problem considering point (*E1*) and (*E2*) respectively as the entrance for the laboratory area. Since the proposed algorithm specifies the relative location of facilities in a descrittized area, a transformation is applied to find out the exact position of each facility within the laboratory area respecting all constraints.

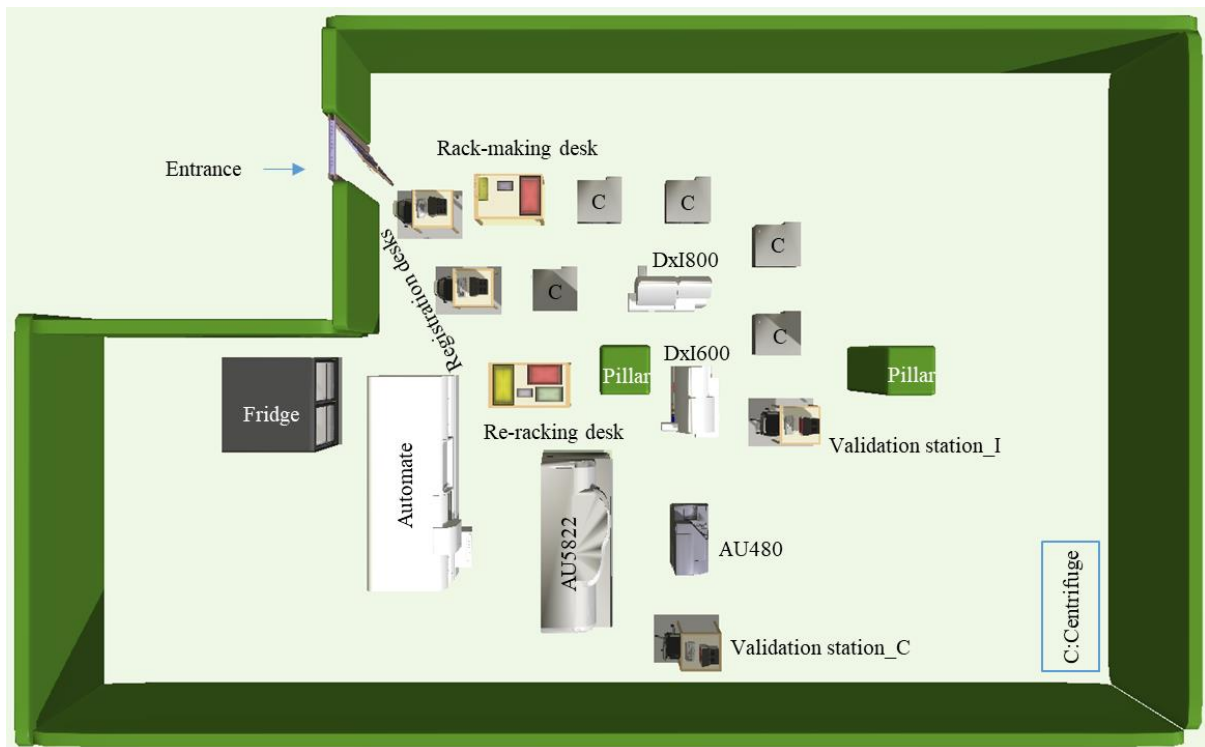

Figure 3-11. Laboratory layout design considering entrance E1.

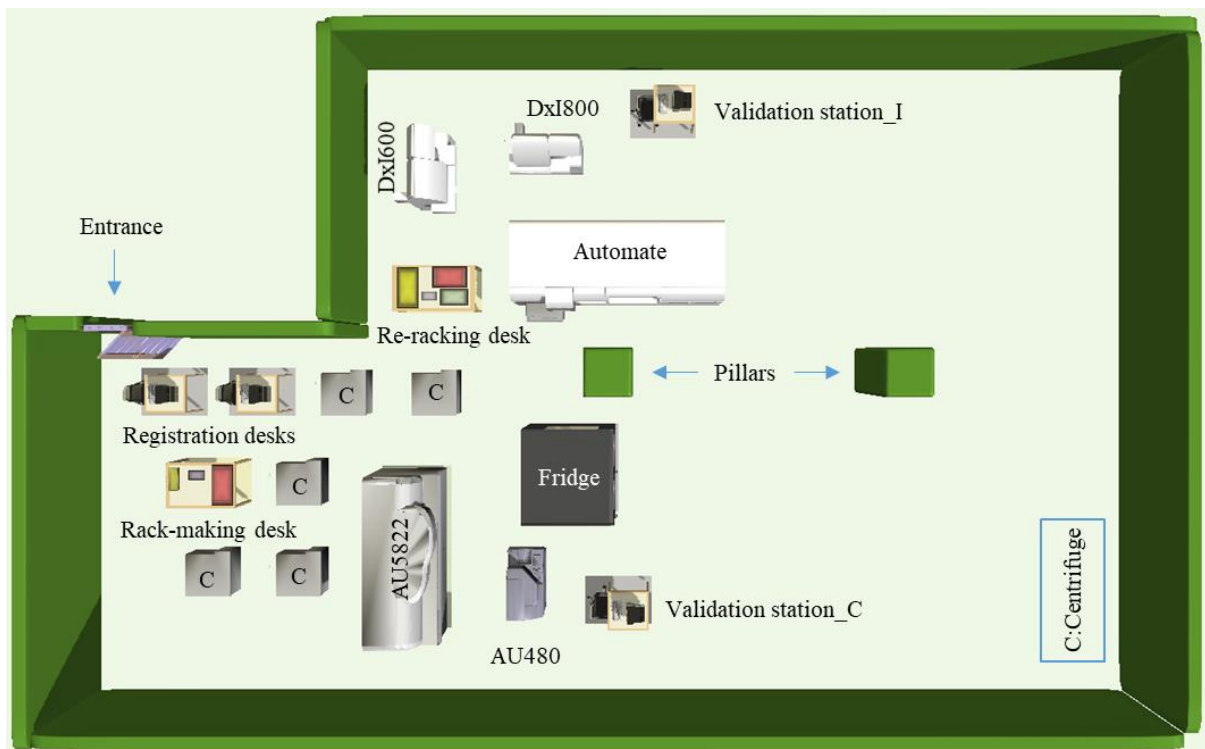

Figure 3-12. Laboratory layout design considering entrance E2.

Regarding the values of the objective function for both solutions, the first proposed layout imposes less operator movement within the laboratory in average. Obviously, in both proposed layouts, the facilities arrangement is compact and the whole available area has not been used due to minimization of operators' total traveling distance. As previously discussed, the facility layout is a problem owning the characteristics of both optimization and design problem. Through the application of the proposed heuristic, the optimization aspect is covered to propose feasible and efficient solutions which provide fruitful insight for designer(s) on how a complete layout could be; however, the design aspect encompassing the neglected issues in the optimization part must be handled by the designer to make the final design more satisfactory.

Figure 3-13 depicts the final layout of the clinical laboratory which is originated from Figure 3-11 with some modifications. In this layout, it has been endeavoured to keep the same relative position of instruments as in Figure 3-11 and to create a suitable space for operators' activities in each workstation and corridors for movements. To support manual modifications for layout design in FlexSim, a mechanism to maintain solution feasibility and to compute the score of the solution is appreciated.

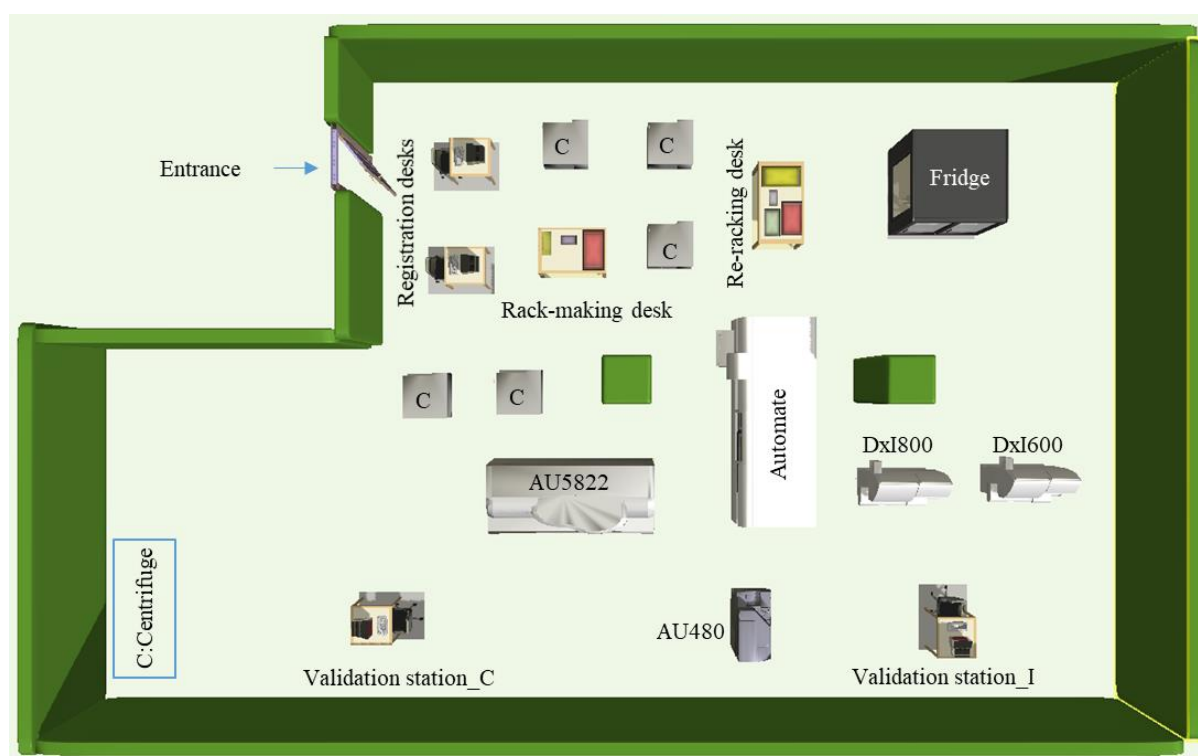

Figure 3-13. Final clinical laboratory layout design.

3.5. Conclusion

The physical arrangement of facilities within a clinical laboratory is one of the significant design problems which has a great effect on the efficiency and productivity of the system. In this chapter, the facility layout problem for a standalone clinical laboratory was fully addressed. A heuristic approach in

which a construction heuristic is integrated with a B&B method was developed to tackle this problem. This approach aids to provide efficient and diverse solutions respecting physical, technical and organizational constraints. To evaluate the efficiency of the proposed approach, the layout of a real clinical laboratory was designed where 17 facilities had to be placed within an area with pre-occupied places. The results present a feasible and a satisfactory design from the expert's point of view.

Applying the proposed approach with different discretization scales is an interesting future research as in one hand, less discretization scale brings more details into design; but, on the other hand, it increases problem complexity and probably makes the problem expensive to be solved. Furthermore, as the proposed approach provides various efficient solutions in terms of total traveling distance, a computer simulation model is proposed to be applied in order to precisely evaluate the selected solutions in terms of other key performance indicators (KPIs) disregarded in this study. Such simulation model can be spotted as a complementary tool for decision making on the layout design.

Chapter 4

Analyzer Configuration Problem for Clinical Laboratory

Highlights:

- A part of this chapter has been filed as a US patent entitled '*Laboratory instrument selection and configuration*'.
- A part of this chapter has been accepted in *MOSIM2018* Conference in Toulouse, France, entitled '*Optimization of analyzers configuration in a clinical laboratory: a mathematical model*'.

4.1. Introduction

In clinical laboratories, reagents are the most important consumable materials which include the main part of the test cost. Reagents are chemical materials used by analyzers to perform clinical tests. In better words, analyzers require reagents to be able to perform tests on patients' samples. These reagents are provided in bottles with different sizes. Normally, for each test type, a specific type of reagent is needed. Assigning reagent bottles to the analyzers in a clinical laboratory in order to satisfy the daily test demand is a challenging issue as in one side, it imposes configuration costs to the organization and on the other side, it directly affects the operational decisions such as tube-analyzer assignment and consequently, operational activities such as tubes movement within the laboratory. Analyzer configuration costs include the costs of different reagent bottles used in the analyzers as well as costs of calibrating each available test type on each analyzer. Generally, specifying the type and the quantity of reagent bottles used in each analyzer in a clinical laboratory to satisfy the daily test demand is addressed as the analyzer configuration problem (ACP). Figure 4-1 schematically illustrates the ACP where different types of reagents with various bottle sizes are assigned to the existing analyzers¹ with different test capabilities and reagent bottle capacities. To the best of our knowledge, this study is the first attempt to characterize and model the ACP for clinical laboratories in operations research literature.

The rest of this chapter is organized as follows: Section 4.2 details the analyzer configuration problem for clinical laboratory. To tackle this problem two mathematical models are described in section 4.3 and section 4.5, respectively. The first proposed model focuses only on cost-related objectives while the second proposed model has a look to the operational problems and tries to control and optimize the tube movements inside the laboratory as well as minimizing a cost-related objective function. Two practical model variations are proposed in section 4.4, each of which has been developed based on the first proposed mathematical model. Finally, section 4.6 concludes the chapter which model validation through a case study.

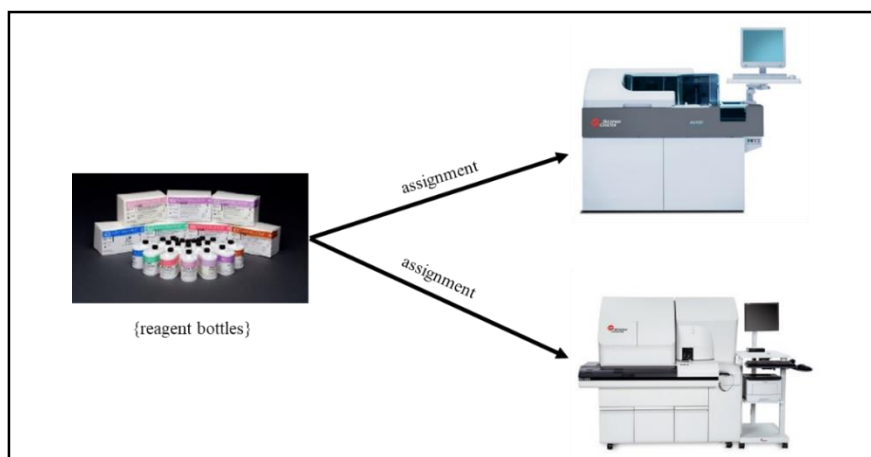

Figure 4-1. Analyzer configuration problem (ACP) in clinical laboratory.

¹ Analyzers' 3-D frames dedicate to Beckman coulter company.

4.2. Analyzer configuration problem

In clinical laboratories, analyzers are used to perform the tests on patient's samples. Each analyzer belongs to one or more test disciplines which implies the potential capability of an analyzer to perform clinical tests. In better words, analyzers are able to do the tests of a discipline to which they belong. For instance, a Chemistry analyzer is potentially able to carry out only Chemistry tests. To practically equip an analyzer to a test, a matching reagent is required in the analyzer. For instance, to equip a Chemistry analyzer to Triglyceride test which is a Chemistry test, the Triglyceride reagent must be available on the analyzer. Reagents are materials used by the analyzers to conduct the tests on patient's samples. Normally, for each test type, a specific type of reagent is needed. Reagents are available in bottles with different sizes. It is worth noting that each analyzer has only a certain number of positions to room reagent bottles. Reagent bottles with different sizes occupy different positions in analyzers. In addition, the efficiency of analyzers in terms of reagent consumption to perform a test is different. Furthermore, the cost of a reagent bottle relies on the test type, bottle size, and analyzer in which the bottle is loaded. Each available test type on an analyzer must be calibrated which imposes a cost to the system, called calibration cost. Analyzer configuration is the problem of specifying the type and quantity of reagent bottles in each analyzer to satisfy the daily average demand optimizing one or more objectives. In this respect, objectives can be defined as minimizing the total cost of reagent bottles used in the analyzers as well as analyzers calibration costs, and minimizing the total number (cost) of tube movements within the laboratory.

In the following sections, two different mathematical models are proposed to deal with the analyzer configuration problem. The first proposed model has been inspired from the machine selection model and only focuses on cost-related objectives. The second proposed model is a bi-objective model which has a look to the operational issues inside the laboratory and tries to minimize tube movements as well as minimizing analyzer configuration costs. Additionally, the nature of input data used for each proposed model is different as the first one uses test-based data while the second one uses tube-based data. In test-based data, the demand is expressed for each test type and it is assumed that average daily demand is given for each test type. In this case, no information is available about the arriving tubes to the system; however, in tube-based data, the daily demand pattern is described through a tube-test matrix in which the requested tests of each arriving tube to the laboratory are known in advance.

4.3. First proposed mathematical model

In this section, assumptions considered to formulate the problem are firstly described. Then, notations used in the proposed mathematical model are introduced. The mathematical formulation and related explanations terminate this section. It is worth noting that test-based data are used to construct the mathematical model proposed in this section.

4.3.1. Assumptions

Definitions and assumptions used to characterize and model the ACP are as follows:

- The number and type of existing analyzers in the clinical laboratory is given.
- Analyzers only belong to one test discipline. Disciplines are Immunology, Chemistry, Hematology, Coagulation, etc.
- In order to analyze each test type, a specific reagent is required. Generally, reagents are chemical material used by the analyzers to perform the test.
- To provide reagents required for a specific test only one supplier exists.
- The capacity of each analyzer in terms of number of tests relies on the analyzer's technical features and the number of reagent bottles positioned into the analyzer. The following formula is proposed to consider the daily average analyzer operational capacity (AOC):

$$AOC_j = \min\{\tau_j g_j, \sum_{h \in H} \sum_{s \in Q} \delta_{hsj} x_{hsj}\}$$

According to this formula, the daily average operational capacity of analyzer j equals the minimum of daily average nominal capacity of the analyzer and the total number of tests that can be analyzed by the analyzer regarding the number of reagent bottles assigned to that analyzer ($\sum_{h \in H} \sum_{s \in Q} \delta_{hsj} x_{hsj}$). The nominal capacity of an analyzer is computed based on the multiplication of the analyzer capacity (g_j) provided by the manufacturer in terms of the average number of tests per hour by the total daily available working hours (τ_j).

- The total daily available working time for each analyzer implies the time that the analyzer is available for operating and analyzing.
- Each analyzer has a certain number of reagent positions to room reagent bottles.
- Each reagent bottle occupies a certain number of positions in the analyzer depending on the reagent type and bottle size.
- A Reagent bottle cost relies on the reagent type, bottle size and the analyzer in which the reagent bottle is used.
- The number of tests that can be analyzed using a bottle of reagent depends on the reagent type, bottle size and the analyzer in which the reagent bottle is used.
- Calibration is performed per test type on each analyzer. So, the calibration cost depends on the test and analyzer type and is computed per test type on each analyzer neglecting the number and size of

reagent bottles used for the test type in the analyzer. This cost is estimated based on the time required to perform calibration tests as well as the amount of reagent required to perform these tests.

- There must be a sufficient capacity in the clinical laboratory to meet all the requested tests within a working day.
- Reagents are loaded at the beginning of the day and no reloading is allowed during the working hours.
- The configuration of the analyzers is performed on the daily basis and is independent from previous days implying that the remaining reagents in the analyzers are discarded at the end of the day.

4.3.2. Notations

All notations used in the proposed mathematical formulation are described in [Table 4-1](#).

Table 4-1. Notations used in the first proposed mathematical model.

Sets

D	set of disciplines
M	set of analyzers
M^d	set of analyzers in discipline d ; $M^d \subset M$
H	set of tests
H^d	set of tests in discipline d ; $H^d \subset H$
Q	set of reagent bottle sizes

Indices

d	index of discipline; $d \in D = \{1, 2, \dots, l\}$
j	index of analyzer; $j \in M = \{1, 2, \dots, m\}$
h	index of test; $h \in H = \{1, 2, \dots, o\}$
s	index of reagent bottle size; $s \in Q = \{1, 2, \dots, q\}$

Parameters

HM_{hj}	$HM_{hj} = 1$, if test h can be potentially done by analyzer j ; otherwise $HM_{hj} = 0$
RC_{hsj}	the cost of a reagent bottle with size s used for test h in analyzer j
CC_{hj}	the calibration cost of test h on analyzer j

σ_{hj}	the average number of test h required to calibrate analyzer j
τ_j	the daily available working hours of analyzer j
g_j	the average number of tests that can be analyzed by analyzer j per hour
RK_j	the reagent capacity of analyzer j
δ_{hsj}	the average number of tests type h that can be analyzed using one bottle of reagent size s in analyzer j
λ_{hs}	the number of reagent positions occupied by reagent bottle h with size s
F_h	the average number of test h requested per day

Decision variables

AOC_j	the operational capacity of analyzer j per day
x_{hsj}	the number of reagent bottles for test h with size s assigned to analyzer j
y_{hj}	$y_{hj} = 1$, if test h is available on analyzer j ; otherwise $y_{hj} = 0$

The proposed mathematical model is introduced in the following section.

4.3.3. Mathematical formulation

Minimize

$$\sum_{h \in H} \sum_{s \in Q} \sum_{j \in M} RC_{hsj} x_{hsj} + \sum_{h \in Q} \sum_{j \in M} CC_{hj} y_{hj} \quad (1)$$

$$\text{Subject to } AOC_j \leq \tau_j g_j ; \quad \forall j \in M \quad (2)$$

$$AOC_j \leq \sum_{h \in H} \sum_{s \in Q} \delta_{hsj} x_{hsj} ; \quad \forall j \in M \quad (3)$$

$$\sum_{j \in M^d} AOC_j \geq \sum_{h \in H^d} (F_h + \sum_{j \in M^d} \sigma_{hj} y_{hj}) ; \quad \forall d \in D \quad (4)$$

$$\sum_{j \in M} \sum_{s \in Q} \delta_{hsj} x_{hsj} \geq F_h + \sum_{j \in M} \sigma_{hj} y_{hj} ; \quad \forall h \in H \quad (5)$$

$$\sum_{h \in H} \sum_{s \in Q} \lambda_{hs} x_{hsj} \leq RK_j ; \quad \forall j \in M \quad (6)$$

$$\sum_{s \in Q} \lambda_{hs} x_{hsj} \leq RK_j y_{hj} ; \quad \forall j \in M, h \in H \quad (7)$$

$$y_{hj} \leq HM_{hj} ; \quad \forall j \in M, h \in H \quad (8)$$

$$AOC_j \geq 0 ; \quad \forall j \in M \quad (9)$$

$$x_{hsj} \geq 0 \text{ and integer} ; \quad \forall h \in H, s \in Q, j \in M \quad (10)$$

$$y_{hj} \in \{0,1\} ; \quad \forall h \in H, j \in M \quad (11)$$

Equation (1) is the objective function which minimizes the total costs of reagent bottles used in the analyzers and the total calibration costs of each test type on each analyzer. Constraint (2) and constraint (3) demonstrate the daily operational capacity of each analyzer which can neither be more than the analyzer's nominal capacity [constraint (2)], nor more than the capacity created by the number of reagent bottles assigned to the analyzer denoting the total number of tests that can be processed by the analyzer [constraint (3)]. Constraint (4) assures that there is a sufficient capacity (capability to analyze a certain number of tests) in the laboratory to handle all the daily requested tests from different disciplines. Constraint (5) guarantees that there are sufficient reagents in the existing analyzers to calibrate the analyzers and to analyze each requested test within a day. Constraint (6) assures that the number of reagent bottles positioned into each analyzer must not exceed the available number of reagent positions on each analyzer. Constraint (7) demonstrates whether test h is available on analyzer j or not to provide useful information to compute calibration cost of each test type on the analyzers. Constraint

(8) presents the potential eligibility of each analyzer to perform a test. Analyzers of each discipline are only able to analyze the tests which belong to the associated discipline. Constraints (9) to (11) imply the type of decision variables used in the model.

It is worth noting that the proposed model can be applied for a case where multi-part analyzers exist in the laboratory through considering each part of an analyzer as an independent analyzer with certain test and reagent capacity.

4.4. Model variations

4.4.1. Analyzer configuration problem with reagent disposal minimization

In the previous model, it has been assumed that the remaining reagents at the end of the day are discarded which imposes many costs to the organization. To minimize this amount, in this section, a model is developed based on the previous one. In this model variation, reagent disposal assumption is maintained but, minimizing the total amount of remaining reagents at the end of the day which leads to total reagents disposal minimization is intended. To calculate the amount of remaining reagent for each test type at the end of the day, following formula is proposed:

$$W_h = \sum_{j \in M} \sum_{s \in Q} \delta_{hsj} x_{hsj} - F_h - \sum_{j \in M} \sigma_{hj} y_{hj} ; \quad \forall h$$

Where W_h denotes the amount of remaining reagent for test type h at the end of the day in all the existing analyzers. In order to minimize the total amount of remaining reagents at the end of the day, the following objective function needs to be added to the previous model:

$$\text{Min} \sum_{h \in H} W_h$$

4.4.2. Analyzer configuration problem with multi suppliers

In the previous model, it has been assumed that each reagent type is provided by a specific supplier; however, in reality, there might be more than one supplier to supply reagent bottles. Reagent bottles for a specific test from various suppliers might differ in price, efficiency and size.

In this section, a mathematical model is proposed to take into account different types of reagent bottles for a specific test provided by various suppliers. Actually, this model is developed based on the model proposed in the previous section. In this model, index r is used to indicate the supplier. Table 4-2 presents all the necessary modifications in notations of the previous model to construct the new one.

It is worth mentioning that in the multi-supplier model, calibration is required for each test type provided by each supplier on each analyzer. In better words, if for a specific test type on an analyzer, reagents

from two different suppliers exist, this test type must be calibrated for both reagents provided by two different suppliers.

Table 4-2. Modifications required to build the multi-supplier analyzer configuration model.

<i>Notations used in</i>		
<i>initial model</i>	<i>multi-supplier model</i>	<i>Explanation</i>
x_{hsj}	$x_{hrs j}$	the number of reagent bottle type h from supplier r with size s assigned to analyzer j
δ_{hsj}	$\delta_{hrs j}$	the average number of test h that can be analyzed using one bottle of reagent provided by supplier r with size s in analyzer j
λ_{hs}	λ_{hrs}	the number of reagent positions occupied by reagent bottle h provided by supplier r with size s
y_{hj}	y_{hrj}	$y_{hrj} = 1$, if reagent type h provided by supplier r is available on analyzer j ; otherwise $y_{hrj} = 0$
σ_{hj}	σ_{hrj}	the average number of test h provided by reagents from supplier r required to calibrate analyzer j
CC_{hj}	CC_{hrj}	the calibration cost of test h provided by supplier r on analyzer j
RC_{hsj}	$RC_{hrs j}$	the cost of a reagent bottle type h provided by supplier r with size s used in analyzer j

The proposed mathematical model for ACP with multi suppliers is formulated as follows:

Minimize

$$\sum_{h \in H} \sum_{r \in R} \sum_{s \in Q} \sum_{j \in M} RC_{hrs j} x_{hrs j} + \sum_{h \in Q} \sum_{r \in R} \sum_{j \in M} CC_{hrj} y_{hrj} \quad (12)$$

$$\text{Subject to } AOC_j \leq \tau_j g_j ; \quad \forall j \in M \quad (13)$$

$$AOC_j \leq \sum_{h \in H} \sum_{r \in R} \sum_{s \in Q} \delta_{hrs j} x_{hrs j} ; \quad \forall j \in M \quad (14)$$

$$\sum_{j \in M^d} AOC_j \geq \sum_{h \in H^d} (F_h + \sum_{j \in M^d} \sum_{r \in R} \sigma_{hrj} y_{hrj}) ; \quad \forall d \in D \quad (15)$$

$$\sum_{j \in M} \sum_{r \in R} \sum_{s \in Q} \delta_{hrs} x_{hrs} \geq F_h + \sum_{j \in M} \sum_{r \in R} \sigma_{hrj} y_{hrj} ; \quad \forall h \in H \quad (16)$$

$$\sum_{h \in H} \sum_{r \in R} \sum_{s \in Q} \lambda_{hrs} x_{hrs} \leq RK_j ; \quad \forall j \in M \quad (17)$$

$$\sum_{s \in Q} \lambda_{hrs} x_{hrs} \leq RK_j y_{hrj} ; \quad \forall j \in M, h \in H, r \in R \quad (18)$$

$$y_{hrj} \leq HM_{hj} ; \quad \forall j \in M, h \in H, r \in R \quad (19)$$

$$AOC_j \geq 0 ; \quad \forall j \in M \quad (20)$$

$$x_{hrs} \geq 0 \text{ and integer} ; \quad \forall h \in H, r \in R, s \in Q, j \in M \quad (21)$$

$$y_{hrj} \in \{0,1\} ; \quad \forall h \in H, r \in R, j \in M \quad (22)$$

4.5. Second proposed mathematical model

The focus of the first mathematical model proposed in the previous sections is mainly on minimizing the total costs of configuration in the laboratory. Such a cost-based configuration only minimizes configuration costs which might lead to excessive operational costs in the system. For instance, a cost-based configuration might assign reagent bottles to the analyzers in a way that arriving tubes have to be moved many times from one analyzer to another until all their ordered tests be analyzed. Suppose that after configuring analyzers through solving the first proposed model, tests a , b and c have been assigned to three different analyzers in order to minimize the total configuration costs. In this case, all the tubes which require tests a , b and c have to be transported among these three analyzers to be completely analyzed. Generally, tube movements inside a laboratory increases operational costs and reduces tube traceability in the system. In addition, excessive tube movements affect operational issues such as job and operator scheduling and increases test turnaround time in the system. As a result, to avoid excessive tube movements inside the laboratory, it is essential to take this issue into consideration while configuring the analyzers.

To configure analyzers considering both configuration costs and tube transfer minimization inside the laboratory, a bi-objective model is proposed in this section. Unlike the first proposed mathematical model for ACP, this model uses tube-based data implying that the average number of tubes with their ordered tests construct the demand input data. In this model, tests of tubes are assigned to the analyzers, then, to support this assignment, required reagents are assigned to the analyzers.

In the following of this section, assumptions considered to formulate the problem are firstly described. Then, notations used in the proposed mathematical model are introduced. A mathematical formulation and related explanations terminate this section.

4.5.1. Assumptions

Definitions and assumptions used to characterize and model the ACP are as follows:

- The number and type of existing analyzers in the clinical laboratory is given.
- Analyzers only belong to one test discipline. Disciplines are Immunology, Chemistry, Hematology, Coagulation, etc.
- In order to analyze each test type, a specific reagent is required. Generally, reagents are chemical material used by the analyzers to perform the test.
- To provide reagents required for a specific test only one supplier exists.
- The total number of tests assigned to each analyzer must not exceed the analyzer's capacity.
- The total daily available working time for each analyzer implies the time that the analyzer is available for operating and analyzing.
- Each analyzer has a certain number of reagent positions to room reagent bottles.
- For each existing analyzer, there must be a minimum amount of reagent available by which the analyzer can perform a portion of the demand proportional to the capacity of the analyzer.
- The daily demand is characterized by the number of tubes and their requested tests. The tube-test matrix is a matrix with binary elements where requested tests of each tube is determined.
- Each requested test of a tube must be analyzed by a specific analyzer.
- In this problem, only tube transfer between the analyzers is of interest. Tube transfer between the analyzers occurs once a tube is assigned to more than one analyzer. Hence, minimizing the total number of tube-analyzer assignments leads to the total tube transfer minimization within the laboratory.
- Each reagent bottle occupies certain positions in the analyzer depending on the reagent type and bottle size.
- The reagent bottle cost relies on the reagent type, bottle size and the analyzer in which the reagent bottle is used.
- The number of tests that can be analyzed using a bottle of reagent depends on the reagent type, bottle size and the analyzer in which the reagent bottle is used.

- Calibration is performed per test type on each analyzer. So, the calibration cost depends on the test and analyzer type and it is computed per test type on each analyzer neglecting the number and size of reagent bottles used for the test type in the analyzer. This cost is estimated based on the time required to perform calibration tests as well as the amount of reagent required to perform these tests.
- There must be a sufficient capacity in the clinical laboratory to meet all the requested tests within a working day.
- Reagents are loaded at the beginning of the day and no reloading is allowed during the working hours.
- Configuration of the analyzers is performed on a daily basis and is independent of previous days implying that the remaining reagents in the analyzers are discarded at the end of the day.

4.5.2. Notations

All notations used in the proposed mathematical formulation are described in [Table 4-3](#).

Table 4-3. Notations used in the second proposed mathematical model.

Sets

D	set of disciplines
M	set of analyzers
M^d	set of analyzers in discipline d ; $M^d \subset M$
N	set of tubes
H	set of tests
H^d	set of tests in discipline d ; $H^d \subset H$
Q	set of reagent bottle sizes

Indices

d	index of discipline; $d \in D = \{1,2, \dots, l\}$
i	index of tube; $i \in N = \{1,2, \dots, n\}$
j	index of analyzer; $j \in M = \{1,2, \dots, m\}$
h	index of test; $h \in H = \{1,2, \dots, o\}$
s	index of reagent bottle size; $s \in Q = \{1,2, \dots, q\}$

Parameters

TH_{ih}	$TH_{ih} = 1$, if tube i requests test h ; otherwise $TH_{ih} = 0$
HM_{hj}	$HM_{hj} = 1$, if test h can be potentially done by analyzer j ; otherwise $HM_{hj} = 0$
RC_{hsj}	the cost of a reagent bottle size s used for test h in analyzer j
CC_{hj}	the calibration cost of test h on analyzer j
σ_{hj}	the average number of tests type h required to calibrate analyzer j
τ_j	the daily available working time of analyzer j
g_j	the average number of tests that can be analyzed by analyzer j per hour
RK_j	the reagent capacity of analyzer j
F_h	the average number of tests type h requested through all the daily requested tubes
θ_d	the capacity adjustment factor for analyzers of discipline d
δ_{hsj}	the average number of tests type h that can be analyzed using one bottle of reagent size s in analyzer j
λ_{hs}	the number of reagent positions occupied by reagent bottle type h with size s

Decision variables

x_{ij}	$x_{ij} = 1$, if tube i is assigned to analyzer j ; otherwise $x_{ij} = 0$
y_{hij}	$y_{hij} = 1$, if test h of tube i is assigned to analyzer j ; otherwise $y_{hij} = 0$
w_{hsj}	the number of reagent bottles of type h with size s assigned to analyzer j
z_{hj}	$z_{hj} = 1$, if test h is available on analyzer j ; otherwise $z_{hj} = 0$

The proposed bi-objective mathematical model is formulated in the following section.

4.5.3. Mathematical formulation

Minimize

$$F1 = \sum_{h \in H} \sum_{s \in Q} \sum_{j \in M} RC_{hsj} w_{hsj} + \sum_{h \in H} \sum_{j \in M} CC_{hj} z_{hj} \quad (23)$$

$$F2 = \sum_{i \in N} \sum_{j \in M} x_{ij} \quad (24)$$

$$\text{Subject to } \sum_{j \in M} y_{hij} = TH_{ih} ; \forall i \in N, h \in H \quad (25)$$

$$y_{hij} \leq x_{ij} ; \forall i \in N, j \in M, h \in H \quad (26)$$

$$\sum_{h \in H} \sum_{s \in Q} \lambda_{hs} w_{hsj} \leq RK_j ; \forall j \in M \quad (27)$$

$$\sum_{s \in Q} \lambda_{hs} w_{hsj} \leq RK_j z_{hj} ; \forall j \in M, h \in H \quad (28)$$

$$z_{hj} \leq HM_{hj} ; \forall j \in M, h \in H \quad (29)$$

$$\sum_{i \in N} y_{hij} \leq \sum_{s \in Q} \delta_{hsj} w_{hsj} - \sigma_{hj} z_{hj} ; \forall j \in M, h \in H \quad (30)$$

$$\sum_{h \in H^d} \sum_{i \in N} y_{hij} \geq \left(\frac{g_j}{\sum_{j \in M^d} g_j} - \theta_d \right) \times \sum_{h \in H^d} F_h ; \forall d \in D, j \in M^d \quad (31)$$

$$\sum_{h \in H} \sum_{i \in N} y_{hij} \leq \tau_j g_j ; \forall j \in M \quad (32)$$

$$x_{ij} \in \{0,1\}, \forall i \in N; j \in M \quad (33)$$

$$y_{hij} \in \{0,1\}, \forall h \in H; i \in N; j \in M \quad (34)$$

$$w_{hsj} \geq 0 \text{ and integer}, \forall h \in H; s \in Q; j \in M \quad (35)$$

$$z_{hj} \in \{0,1\}, \forall h \in H; j \in M \quad (36)$$

This model consists of two objectives where the first one minimizes the total daily configuration and calibration costs while the second one attempts to minimize the total tube movements within the clinical

laboratory. Equations (23) and (24) describe these objective functions. Constraint (25) assures that each test of a tube must be analyzed by an analyzer. Thus, if test h is requested by tube i ($TH_{ih} = 1$), this test must be done by a capable analyzer. Constraint (26) presents that a test can be assigned to an analyzer only if the associated tube is assigned to that analyzer. Constraint (27) assures that the number of reagent bottles positioned into each analyzer must not exceed the available number of reagent positions of that analyzer. Constraint (28) presents which tests are analyzed by which analyzer(s) to provide us computing the calibration cost of the tests on the analyzers. A test is analyzed by an analyzer only if there is at least one reagent bottle of that test in the analyzer. Constraint (29) demonstrates whether test h is potentially analyzed by analyzer j or not. This is the eligibility constraint to avoid assigning a test to an analyzer which is not able to analyze that test. Constraint (30) presents that the total number of tests of type h done by the analyzer j must not exceed the total available reagents assigned to the analyzer for test h . Note that for each test type on each analyzer, a portion (σ_{hj}) is used for calibration. Constraint (31) assures that each analyzer of a discipline in the laboratory receives a minimum number of tests proportional to the analyzer capacity so that a minimum amount of reagent must be assigned to the analyzer. In this constraint, coefficient $\left(\frac{g_j}{\sum_{j \in M^d} g_j} - \theta_d\right)$ is the factor implying the minimum number of tests that must be handled by analyzer j belonging to discipline d which is proportional to analyzer capacity (g_j). Additionally, parameter θ_d denotes the level of deviation from analyzer relative capacity in receiving tests and is expressed in percent. Constraint (32) presents that the total number of tests assigned to an analyzer must not exceed the analyzer capacity which is defined in terms of the total average number of tests that can be done by the analyzer per day. Constraints (33) to (36) imply the type of decision variables used in the model.

4.6. Resolution approach and computational results

In this section, the solution procedure to deal with the proposed bi-objective mathematical model is firstly introduced in section 4.6.1. Then, the case study is illustrated for which the proposed model is solved and numerical results are presented in section 4.6.2.

4.6.1. Solution procedure

Multi-objective optimization has been extensively investigated in the literature (Coello, 2006). Generally, approaches proposed to deal with multi-objective problems are divided into two classes. The first class of methods attempts to scalarize multiple objectives into a single objective, while the evolutionary approaches intend to solve multi-objective problems as they are (Deb, 2014). Weighted sum approaches, goal programming, goal attainment, and ε -constraint methods are the techniques which use aggregating functions (Coello, 1999). Although there are many types of techniques proposed in the literature to cope with multi-objective optimization problems [Coello (1999) and Marler and Arora (2004)], discussion on this issue is out of the scope of this thesis.

In this thesis, the weighted sum method as the most commonly used approach to tackle multi-objective problems is applied to validate the feasibility of the proposed model. Although this approach is weak to detect the optimal solutions in non-convex regions (Kim and De Weck, 2006), the possibility to give different importance factors to each objective has made this method one of the most useful and promising multi-objective approaches.

Generally, a multi-objective model can be shown as follows:

$$\text{Min}_{x \in X} (f_1(x), \dots, f_K(x))$$

Where K is the number of objectives and X denotes the feasible region.

In order to solve such a multi-objective problem through the weighted sum method, all the objectives are aggregated in a way to make the model as single-objective as follows:

$$\text{Min}_{x \in X} \sum_{k=1}^K \pi_k f'_k$$

Where f'_k is the normalised value of the k th objective function and π_k is the weight of k th objective function implying the importance of objective k . Value π_k varies in $[0,1]$ interval and $\sum_{k=1}^K \pi_k = 1$.

Since the value of objective functions vary in different scales, objectives need to be normalised. To obtain the normalised value of the objective functions, each objective function should be optimized separately for both minimization and maximization directions to find out the extreme points. For a minimization objective function (f_k), the best found solution is called positive ideal solution and is denoted by *PIS* or f_k^{min} . Furthermore, the worst found solution is called negative ideal solution and is denoted by *NIS* or f_k^{max} . Consequently, the normalised value of a minimization objective function is computed using the following formula:

$$f'_k = \frac{f_k - f_k^{min}}{f_k^{max} - f_k^{min}}$$

In the next section, the application of this method is presented through solving the proposed bi-objective mathematical model.

4.6.2. Case study and numerical results

In this section, the aim is to find out the most appropriate assignment of different reagent bottles to the selected analyzers in chapter two, knowing that the daily average demand of the clinical laboratory is similar to the one described in chapter one, section 1.6.1. In better words, the type and quantity of reagent bottles assigned to each analyzer is determined considering the two objectives which are (i)

minimizing the total configuration costs, and (ii) minimizing the total tube movements among the analyzers within the laboratory.

Considering the output of the machine selection problem in chapter two, four analyzers have been selected. DxI600 and DxI800 are the selected Immunology analyzers and AU480 and AU5822 are the selected Chemistry analyzers. Potential test capability, test capacity and reagent capacity of each analyzer is extracted from the analyzers manufacturer website. The daily available working time of each analyzer is fixed to eight hours.

Concerning the reagents, each reagent type is supplied by a single supplier and for each type, two bottle sizes are available. Cost of each reagent bottle type for different sizes have been extracted from brochure provided by reagent suppliers. In addition, efficiency of each analyzer in terms of reagent consumption for a test has been adapted from analyzers manufacture website.

In order to solve this analyzer configuration problem with two objectives, the mathematical model proposed in section 4.5.3 is applied. The model is coded in GAMS 24.1.3 and CPLEX solver is used to solve the problem. The weighted sum method explained in the previous section is used to tackle this problem. Since the values of the objective functions vary in different scales, objectives need to be normalised. To find the normalised value of each objective, each objective is optimized separately. Table 4-4 presents the extreme values for each objective function where F_1 implies total configuration costs, and F_2 denotes total tube movements among analyzers within the laboratory.

Table 4-4. Extreme values of each objective function.

	F_1	F_2	CPLEX time (sec)
F_1	48.799*	11,158	10.67
F_2	65.547	5,579*	575.08
F^{min}	48.799	5,579	----
F^{max}	65.547	11,158	----

Considering these extreme values, normalised objective functions are obtained as follows:

$$F'_1 = \frac{F_1 - F_1^{min}}{F_1^{max} - F_1^{min}} = \frac{F_1 - 48.799}{65.547 - 48.799} = \frac{F_1 - 48.799}{16.748}$$

$$F'_2 = \frac{F_2 - F_2^{min}}{F_2^{max} - F_2^{min}} = \frac{F_2 - 5,579}{11,158 - 5,579} = \frac{F_2 - 5,579}{5,579}$$

Consequently, the model is converted to a single-objective in which the objective function is defined as follows:

$$OF = \pi F'_1 + (1 - \pi) F'_2 \rightarrow$$

$$OF = \pi \frac{F_1 - 48.799}{16.748} + (1 - \pi) \frac{F_2 - 5,579}{5,579}$$

where $\pi \in [0,1]$. To determine the value of π which implies the importance of objective functions, expert opinion is taken into account, so that values noted in Table 4-5 are proposed. The model is solved for each proposed importance factor and the values of objective functions are obtained. Table 4-5 illustrates the value of each objective function for each weight.

Table 4-5. Value of objective functions under different importance factors.

π	F_1	F_2	Relative gap (%)	Run time (sec)
0	65.547	5,579	0	169.45
0.3	49.191	5,602	2.38	10,800
0.5	49.067	5,607	2.11	10,800
0.7	48.997	5,690	2.57	10,800
1	48.799	11,158	0	19.78

Considering final expert opinion, it's been decided to give the same importance to both objective functions. So, solution found under $\pi = 0.5$ is taken to configure the analyzers. Consequently, values of decision variable w_{hsj} which indicate the type and number of reagent bottles assigned to each analyzer are used for analyzer configuration. Table 4-6 presets a portion of the obtained solution.

Table 4-6. A portion of analyzer configuration solution.

Test/Reagent type	Bottle size	Analyzers			
		AU480	AU5822	DxI600	DxI800
ALT	Small	1	6		
AST	Small	1	6		
UricAcidu	Small	1			
UricAcid	Small		2		
CK	Small		1		
Calcium	Large		3		
Creatinine	Small	1	2		
CRP	Large		2		
Triglyceride	Small		6		
UREA	Small	1	1		
...
freePSA	small			1	1
PSA-Hyb	small			1	7
FRT3	small			1	1
FRT4	small			1	5
Testo	small			1	
GToxo	small			4	1
IgM-Toxo	small			4	1
TropI	small				1
TSH	small			2	10
...

4.7. Conclusion

Reagent and calibration costs constitute a huge part of clinical laboratory operating costs. In this chapter, the analyzer configuration problem in clinical laboratories was introduced as the allocation of different types and sizes of reagents to several analyzers in an efficient manner under certain constraints. To tackle this problem, two mathematical models were developed. The first proposed model only focuses on cost-related objectives while the second proposed model is a bi-objective model which has a look to the operational issues inside the laboratory and tries to minimize tubes movements as well as minimizing analyzers configuration costs. A clinical laboratory with four analyzers were then configured through solving the bi-objective model considering real data. Experimental results demonstrate the validity and usefulness of the proposed model to deal with ACP.

To increase system reliability and flexibility in tests demand satisfaction, some specific tests need to be available on more than one analyzer. These tests are known as mirror tests. Incorporating these mirror tests in analyzer configuration model is a favourable extension. In addition, in the proposed models of this chapter, it has been assumed that configuration is done on a daily basis so that remaining reagents are discarded at the end of the working day. Although this assumption is true for some laboratories, it can be relaxed so that proposing a dynamic multi-period model could be meaningful for future studies.

Chapter 5

Operational Problems of Clinical Laboratories: Assignment, Aliquoting, and Scheduling

Highlights:

A part of this chapter has been filed and published as a US patent entitled '*Intelligent handling of materials*' [<https://patents.google.com/patent/WO2018111721A1/en>]

5.1. General introduction to operational problems in clinical laboratories

In recent years, clinical laboratories are getting bigger regarding to the phenomenon of mutualisation. Clinical laboratories fusion leads us to the expression: “The bigger the organization, the more works to handle”; therefore, each laboratory receives more tubes and must treat them with the available resources in a specific period of time. On one hand, the number of arriving tubes is numerous and the requested tests are different; on the other hand, the number of analyzers is limited and their capabilities and capacities are different. Thus, assigning tubes and tests of the tubes to the analyzers in clinical laboratories is appreciated as a crucial emerging problem. Additionally, ordering and prioritizing tubes operations on the analyzers knowing as the scheduling problem is considered as a complementary operational issue to the assignment problem in clinical laboratories. Furthermore, the possibility to make aliquots out of tubes can be an efficient way to properly manage samples flow in the laboratory, and is spotted as a challenging issue as it directly affects assignment and scheduling problems. As a summary, the main operational problems of a clinical laboratory are summarized to assignment, scheduling and aliquoting. Efficient decisions for these issues cause cost and turnaround time reduction and throughput growth.

In this chapter, these three problems are discussed. [Section 5.2](#) is dedicated to the assignment problem in clinical laboratories. [Section 5.3](#) addresses the problem of aliquoting in clinical laboratories and finally, [section 5.4](#) briefly explains the scheduling problem in clinical laboratories.

5.2. Assignment problem for clinical laboratories

5.2.1. Introduction to the assignment problem

Generally, the assignment problem (AP) deals with assigning a certain number of tasks to proper resources with the aim of optimizing one or more objectives under certain constraints ([Pentico, 2007](#)). Although the term ‘*assignment problem*’ has appeared for the first time in the paper published by [Votaw and Orden \(1952\)](#) for personnel assignment, what is commonly recognized as the beginning point for solution methods development and variations proposition on the classic assignment problem is the article published by [Kuhn \(1955\)](#) in which the proposed solution method is known as the Hungarian method. In operations research references, the assignment problem is defined as a special type of transportation problem in which each supply point can only supply one good and each demand point can only demand for one good. While, in the graph theory literature, the assignment problem is known as a bipartite weighted matching problem. Generally, assignment problems are split into three categories:

- *One-to-one assignment problem*: In this problem, each task is assigned to a different agent and each agent is assigned to at most one task. In the case where the number of agents and tasks are equal, each

agent is assigned to exactly one task. When the number of tasks are more than agents the problem cannot be defined as one-to-one assignment problem.

- *One-to-many assignment problem*: In this problem, each task is assigned to exactly one agent but an agent can be assigned to more than one task.

- *Many-to-many assignment problem*: This problem allows one task to be undertaken by many, but different, agents and allows one agent to perform many, but different, tasks (Zhu et al., 2016).

5.2.1.1. The classic assignment problem

In this section, mathematical model for the classic assignment problem is introduced and an example of the bipartite assignment graph is presented.

5.2.1.1.1. Mathematical model

The classic assignment problem is to find a one-to-one matching between n tasks and n agents (assignees) with respect to minimizing the total cost of assignment. Some applications of this problem are to assign jobs to machines, personnel to offices, etc. The mathematical model for the classic assignment problem may be given as:

$$\begin{aligned}
 &\text{Minimize} && \sum_{i=1}^n \sum_{j=1}^n c_{ij} x_{ij} \\
 &\text{Subject to} && \sum_{i=1}^n x_{ij} = 1 \quad \forall j = 1, 2, \dots, n \\
 &&& \sum_{j=1}^n x_{ij} = 1 \quad \forall i = 1, 2, \dots, n \\
 &&& x_{ij} \in \{0, 1\}; \quad \forall i = 1, 2, \dots, n; j = 1, 2, \dots, n
 \end{aligned}$$

Where x_{ij} is a binary variable which implies the assignment of agent i to task j when its value is 1 and c_{ij} is the cost of this assignment. The first set of constraints ensures that every task is assigned to only one agent and the second set of constraints guarantees that every agent is assigned to a task. The objective is to minimize the total cost of assignment.

5.2.1.1.2. Graph model

Another possible modeling approach of the assignment problem is to find the lightest perfect matching in a weighted bipartite graph $G = (N_1 \cup N_2, A)$ with $|N_1| = |N_2|$ and arc weights c_{ij} . It is assumed that G is a directed graph so, for each arc $(i, j) \in A, i \in N_1$ and $j \in N_2$. This problem is known as the

assignment problem in operations research literature. Figure 5-1 presents a weighted bipartite network for a matching problem with $|N_1| = |N_2| = 5$.

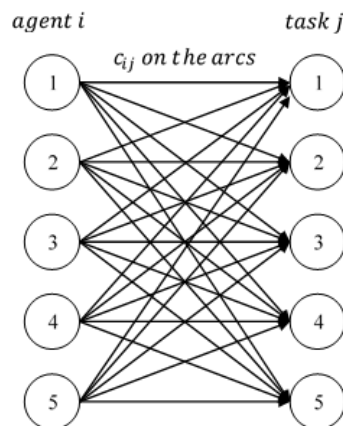

Figure 5-1. A weighted bipartite network for a matching problem with $|N_1| = |N_2| = 5$.

Figure 5-2 shows a feasible solution for the aforementioned example which is a perfect matching.

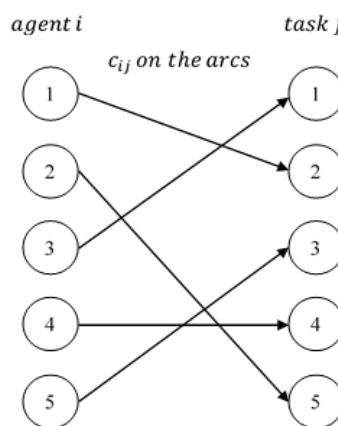

Figure 5-2. A feasible solution for the example.

5.2.1.2. The generalized assignment problem (GAP)

The most basic version of the AP that allows an agent to be assigned to multiple tasks is the generalized assignment problem or GAP. In this problem, a limited capacity is defined for each agent which is used for the assigned tasks. In other words, each task uses an amount of an agent's capacity. The mathematical model of GAP is as follows:

$$\begin{aligned} &\text{Minimize} && \sum_{i=1}^m \sum_{j=1}^n c_{ij} x_{ij} \\ &\text{Subject to} && \sum_{i=1}^m x_{ij} = 1 \quad \forall j = 1, 2, \dots, n \end{aligned}$$

$$\sum_{j=1}^n a_{ij}x_{ij} \leq b_i \quad \forall i = 1, 2, \dots, m$$

$$x_{ij} \in \{0, 1\}; \quad \forall i = 1, 2, \dots, m; j = 1, 2, \dots, n$$

Where x_{ij} is a binary variable which implies the assignment of agent i to task j when its value is 1, c_{ij} is the cost of assignment agent i to task j , b_i is the limited capacity of agent i and a_{ij} is the amount of capacity which is used by task j from total capacity of agent i .

5.2.2. Assignment problem description for clinical laboratories

Medical laboratories receive a large number of tubes with a high diversity in test requests. On the other side, a limited number of analyzers with different test capabilities exist in the laboratory. Assigning tubes and tests of the tubes to the existing analyzers in a clinical laboratory to optimize one or more objectives under some constraints is known as the assignment problem. To be more clear, the aim of the assignment problem in a clinical laboratory is to find the optimal analyzer for each requested test of the tubes in order to minimize tube transfer through the system and also to balance the load among the analyzers which may lead to high system efficiency. Analyzer load balancing can be defined in terms of the total number of tests assigned to each analyzer or in terms of the total number of tubes assigned to each analyzer.

In the next section, a mathematical model with three objectives is proposed to characterize and model the assignment problem for a clinical laboratory.

5.2.3. Proposed mathematical model

Two matrices play the most important role in the assignment problem: the tube-test matrix and the analyzer-test matrix. Tube-test matrix is an $n \times o$ matrix with binary elements which includes all the requested tests of the tubes (n and o are the number of tubes and tests, respectively). The elements of this matrix are noted by parameter TH_{ih} in the proposed mathematical model following this section. The analyzer-test matrix is an $m \times o$ matrix with whole numbers (\mathbb{Z}^+) which states the average number of tests that can be analyzed by each analyzer thanks to the existing reagents (m and o are the number of analyzers and tests, respectively). The elements of this matrix are noted by RK_{jh} in the proposed mathematical model. After each assignment run, these two matrices must be updated according to the real-time laboratory status.

As previously mentioned, the main objective of this problem is to balance the load among the analyzers. Load balancing is meaningful for the analyzers of the same discipline and can be defined in terms of the total number of tubes assigned to each analyzer or the total number of tests assigned to each analyzer.

To balance the total number of tubes assigned to the analyzers of each discipline, tubes are firstly classified into different classes based on the disciplines to which their requested tests belong. Consequently, five classes exist considering four main disciplines as Immunology, Chemistry, Hematology, and Coagulation. These classes are listed as follows:

- CLASS I: Tubes which request only Immunology tests.
- CLASS II: Tubes which request only Chemistry tests.
- CLASS III: Tubes which request only Hematology tests.
- CLASS IV: Tubes which request only Coagulation tests.
- CLASS V: Tubes which request both Immunology and Chemistry tests.

In addition, analyzers are classified into four classes based on their discipline: Immunology, Chemistry, Hematology and Coagulation. The aim is to balance the load between the analyzers of each discipline in terms of number of tubes received from each class of tube. It is worth noting that Immunology analyzers can only receive tubes from CLASS I and CLASS IV, Chemistry analyzers can only receive tubes from CLASS II and CLASS IV, Hematology analyzers can only receive tubes from CLASS III, and Coagulation analyzers can only receive tubes from CLASS IV.

The advantage of analyzer load balancing on each class of tubes reveals when allocating tubes which request both Immunology and Chemistry (CLASS V) to Immunology and Chemistry analyzers. These tubes must be first sent to the Immunology analyzers and then to the Chemistry analyzers because of cross contaminations and other medical/technical issues. Meanwhile, there are also some tubes which request only Immunology (CLASS I) or Chemistry (CLASS II) tests. In this condition, if all the CLASS II tubes are assigned to a Chemistry analyzer and all the CLASS V tubes to another Chemistry analyzer while the number of these tubes are the same, the Chemistry analyzer receiving CLASS V tubes will remain idle at the beginning as CLASS V tubes need to be sent to the Immunology analyzers first. Considering the proposed objective for the balanced assignment, such condition is avoided which probably leads to better scheduling decisions in the next phase. Take the following example for more explanation.

Assume that there are four analyzers in the laboratory: two Immunology (DxI800) with the same test capability and also two Chemistry (AU680) with the same test capability. Tubes received by the laboratory are classified into three classes: Immunology tubes (100), Chemistry tubes (100) and tubes which need both Immunology and Chemistry tests (100). The numbers in the parentheses show the number of tubes in each class. [Figure 5-3](#) represents the optimal balanced assignment solution of this problem.

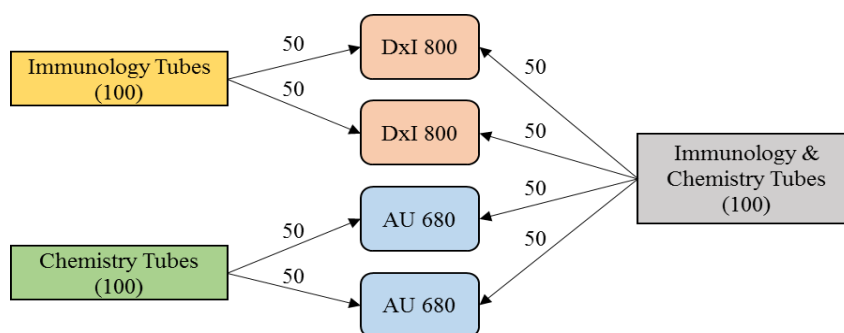

Figure 5-3. Optimal balanced assignment of the illustrative example.

Furthermore, another important aim of the assignment is to balance the total number of tests assigned to each analyzer considering the speed and the capacity of the analyzers. The third objective for the assignment is to minimize the tubes' movements in the clinical laboratory.

In the rest of this section, assumptions considered to formulate the problem are firstly described. Then, notations used in the proposed mathematical model are introduced. The mathematical formulation and related explanations terminate this section.

5.2.3.1. Assumptions

In the following, assumptions used to characterize and model the assignment problem for clinical laboratories are described.

- The type and quantity of existing analyzers in the laboratory are given.
- Analyzers only belong to one test discipline. Main test disciplines are Immunology, Chemistry, Hematology, and Coagulation.
- The amount of available reagent for each test type on each analyzer is given which is illustrated by the analyzer-test matrix.
- The average capacity of each analyzer is expressed based on the number of tests per hour. In order to compute the daily capacity of each analyzer, the hourly capacity of the analyzer has to be multiplied by the daily available working hours.
- The tests requested by each tube are given which is presented by the tube-test matrix.
- Each test of a tube must be analyzed by an analyzer.
- For each test type, the total number of tests assigned to an analyzer must not exceed the total available reagents on that analyzer.
- The total number of tests assigned to each analyzer must not exceed the available capacity of that analyzer.

5.2.3.2. Notations

Table 5-1 presents all the notations used in the proposed mathematical model.

Table 5-1. Notations used in the proposed mathematical model.

Sets	
M	set of analyzers; $M = M^{IMM} \cup M^{CHEM} \cup M^{HEM} \cup M^{COAG}$
M^{IMM}	set of Immunology analyzers ; $M^{IMM} \subset M$
M^{CHEM}	set of Chemistry analyzers; $M^{CHEM} \subset M$
M^{HEM}	set of Hematology analyzers; $M^{HEM} \subset M$
M^{COAG}	set of Coagulation analyzers; $M^{COAG} \subset M$
N	set of tubes; $N = CL^{IMM} \cup CL^{CHEM} \cup CL^{HEM} \cup CL^{COAG} \cup CL^{IMCH}$
CL^{IMM}	set of tubes that only requires Immunology tests; $CL^{IMM} \subset N$
CL^{CHEM}	set of tubes that only requires Chemistry tests; $CL^{CHEM} \subset N$
CL^{HEM}	set of tubes that only requires Hematology tests; $CL^{HEM} \subset N$
CL^{COAG}	set of tubes that only requires Coagulation tests; $CL^{COAG} \subset N$
CL^{IMCH}	set of tubes that requires both Immunology and Chemistry tests; $CL^{IMCH} \subset N$
H	set of tests
Indices	
i	index of tube $i \in N = \{1, 2, \dots, n\}$
j	index of analyzer $j \in M = \{1, 2, \dots, m\}$
h	index of test $h \in H = \{1, 2, \dots, o\}$
Parameters	
TH_{ih}	$TH_{ih} = 1$, if tube i requests test h ; otherwise $TH_{ih} = 0$
RK_{jh}	the average number of test h that can be analyzed by analyzer j thanks to reagent availability
g_j	the average number of tests that can be analyzed by analyzer j per hour

- k_j the average number of tubes that can be analyzed by analyzer j per hour
- τ_j the daily available working hours of analyzer j
- c_i the cost of movement for tube i between analyzers within the laboratory

Decision variables

- x_{ij} $x_{ij} = 1$, if tube i is assigned to analyzer j ; otherwise $x_{ij} = 0$
- y_{hij} $y_{hij} = 1$, if test h of tube i is assigned to analyzer j ; otherwise $y_{hij} = 0$
- α_j the number of Immunology tubes assigned to Immunology analyzer j
- β_j the number of Chemistry tubes assigned to Chemistry analyzer j
- γ_j the number of Hematology tubes assigned to Hematology analyzer j
- δ_j the number of Coagulation tubes assigned to Coagulation analyzer j
- λ_j the number of Immunology-Chemistry tubes assigned to Immunology analyzer j
- η_j the number of Immunology-Chemistry tubes assigned to Chemistry analyzer j
- ρ_j the number of tests assigned to Immunology analyzer j
- φ_j the number of tests assigned to Chemistry analyzer j
- ζ_j the number of tests assigned to Hematology analyzer j
- ψ_j the number of tests assigned to Coagulation analyzer j
- $z_{jj'}$ integer variable used for linearization
- $v_{jj'}$ integer variable used for linearization
- $w_{jj'}$ integer variable used for linearization
- $\mu_{jj'}$ integer variable used for linearization
-

5.2.3.3. Mathematical formulation

Minimize

$$F1 = \sum_{j,j' \in M^{IMM}} (z_{jj'} + v_{jj'}) + \sum_{j,j' \in M^{CHEM}} (z_{jj'} + w_{jj'}) + \sum_{j,j' \in M^{HEM}} z_{jj'} + \sum_{j,j' \in M^{COAG}} z_{jj'} \quad (1)$$

$$F2 = \sum_{j,j' \in M^{IMM}} \mu_{jj'} + \sum_{j,j' \in M^{CHEM}} \mu_{jj'} + \sum_{j,j' \in M^{HEM}} \mu_{jj'} + \sum_{j,j' \in M^{COAG}} \mu_{jj'} \quad (2)$$

$$F3 = \sum_{i \in CL^{IMM}} \sum_{j \in M} c_i x_{ij} + \sum_{i \in CL^{CHEM}} \sum_{j \in M} c_i x_{ij} + \sum_{i \in CL^{IMCH}} \sum_{j \in M} c_i x_{ij} + \sum_{i \in CL^{HEM}} \sum_{j \in M} c_i x_{ij} + \sum_{i \in CL^{COAG}} \sum_{j \in M} c_i x_{ij} \quad (3)$$

$$\text{Subject to } \sum_{j \in M} y_{hij} = TH_{ih} ; \forall i \in N, h \in H \quad (4)$$

$$y_{hij} \leq x_{ij} ; \forall i \in N, j \in M, h \in H \quad (5)$$

$$\sum_{i \in N} y_{hij} \leq RK_{jh} ; \forall j \in M, h \in H \quad (6)$$

$$\sum_{i \in N} \sum_{h \in H} y_{hij} \leq g_j \tau_j ; \forall j \in M \quad (7)$$

$$\sum_{i \in CL^{IMM}} x_{ij} = \alpha_j ; \forall j \in M^{IMM} \quad (8)$$

$$\sum_{i \in CL^{CHEM}} x_{ij} = \beta_j ; \forall j \in M^{CHEM} \quad (9)$$

$$\sum_{i \in CL^{HEM}} x_{ij} = \gamma_j ; \forall j \in M^{HEM} \quad (10)$$

$$\sum_{i \in CL^{COAG}} x_{ij} = \delta_j ; \forall j \in M^{COAG} \quad (11)$$

$$\sum_{i \in CL^{IMCH}} x_{ij} = \lambda_j ; \forall j \in M^{IMM} \quad (12)$$

$$\sum_{i \in CL^{IMCH}} x_{ij} = \eta_j ; \quad \forall j \in M^{CHEM} \quad (13)$$

$$\sum_{h \in H} \sum_{i \in N} y_{hij} = \rho_j ; \quad \forall j \in M^{IMM} \quad (14)$$

$$\sum_{h \in H} \sum_{i \in N} y_{hij} = \varphi_j ; \quad \forall j \in M^{CHEM} \quad (15)$$

$$\sum_{h \in H} \sum_{i \in N} y_{hij} = \varsigma_j ; \quad \forall j \in M^{HEM} \quad (16)$$

$$\sum_{h \in H} \sum_{i \in N} y_{hij} = \psi_j ; \quad \forall j \in M^{COAG} \quad (17)$$

$$\begin{cases} \frac{1}{k_j} \alpha_j \leq z_{jj'} \\ \frac{1}{k_{j'}} \alpha_{j'} \leq z_{jj'} \end{cases} ; \quad \forall j, j' \in M^{IMM}, j < j' \quad (18)$$

$$\begin{cases} \frac{1}{k_j} \beta_j \leq z_{jj'} \\ \frac{1}{k_{j'}} \beta_{j'} \leq z_{jj'} \end{cases} ; \quad \forall j, j' \in M^{CHEM}, j < j' \quad (19)$$

$$\begin{cases} \frac{1}{k_j} \gamma_j \leq z_{jj'} \\ \frac{1}{k_{j'}} \gamma_{j'} \leq z_{jj'} \end{cases} ; \quad \forall j, j' \in M^{HEM}, j < j' \quad (20)$$

$$\begin{cases} \frac{1}{k_j} \delta_j \leq z_{jj'} \\ \frac{1}{k_{j'}} \delta_{j'} \leq z_{jj'} \end{cases} ; \quad \forall j, j' \in M^{COAG}, j < j' \quad (21)$$

$$\begin{cases} \frac{1}{k_j} \lambda_j \leq v_{jj'} \\ \frac{1}{k_{j'}} \lambda_{j'} \leq v_{jj'} \end{cases} ; \quad \forall j, j' \in M^{IMM}, j < j' \quad (22)$$

$$\begin{cases} \frac{1}{k_j} \eta_j \leq w_{jj'} \\ \frac{1}{k_{j'}} \eta_{j'} \leq w_{jj'} \end{cases} ; \quad \forall j, j' \in M^{CHEM}, j < j' \quad (23)$$

$$\begin{cases} \frac{1}{g_j} \rho_j \leq \mu_{jj'} \\ \frac{1}{g_{j'}} \rho_{j'} \leq \mu_{jj'} \end{cases} ; \forall j, j' \in M^{IMM}, j < j' \quad (24)$$

$$\begin{cases} \frac{1}{g_j} \varphi_j \leq \mu_{jj'} \\ \frac{1}{g_{j'}} \varphi_{j'} \leq \mu_{jj'} \end{cases} ; \forall j, j' \in M^{CHEM}, j < j' \quad (25)$$

$$\begin{cases} \frac{1}{g_j} \varsigma_j \leq \mu_{jj'} \\ \frac{1}{g_{j'}} \varsigma_{j'} \leq \mu_{jj'} \end{cases} ; \forall j, j' \in M^{HEM}, j < j' \quad (26)$$

$$\begin{cases} \frac{1}{g_j} \psi_j \leq \mu_{jj'} \\ \frac{1}{g_{j'}} \psi_{j'} \leq \mu_{jj'} \end{cases} ; \forall j, j' \in M^{COAG}, j < j' \quad (27)$$

$$x_{ij} \in \{0,1\}; \forall i \in N, j \in M \quad (28)$$

$$y_{hij} \in \{0,1\}; \forall i \in N, j \in M, h \in H \quad (29)$$

$$\alpha_j \geq 0, integer ; \forall j \in M^{IMM} \quad (30)$$

$$\beta_j \geq 0, integer ; \forall j \in M^{CHEM} \quad (31)$$

$$\gamma_j \geq 0, integer ; \forall j \in M^{HEM} \quad (32)$$

$$\delta_j \geq 0, integer ; \forall j \in M^{COAG} \quad (33)$$

$$\lambda_j \geq 0, integer ; \forall j \in M^{IMM} \quad (34)$$

$$\eta_j \geq 0, integer ; \forall j \in M^{CHEM} \quad (35)$$

$$\rho_j \geq 0, integer ; \forall j \in M^{IMM} \quad (36)$$

$$\varphi_j \geq 0, integer ; \forall j \in M^{CHEM} \quad (37)$$

$$\begin{aligned}
z_{jj'} &\geq 0, \text{ integer}; \quad \forall j, j' \in M^{IMM}, j < j' \\
&\quad \forall j, j' \in M^{CHEM}, j < j' \\
&\quad \forall j, j' \in M^{HEM}, j < j' \\
&\quad \forall j, j' \in M^{COAG}, j < j'
\end{aligned} \tag{38}$$

$$v_{jj'} \geq 0, \text{ integer}; \quad \forall j, j' \in M^{IMM}, j < j' \tag{39}$$

$$w_{jj'} \geq 0, \text{ integer}; \quad \forall j, j' \in M^{CHEM}, j < j' \tag{40}$$

$$\begin{aligned}
\mu_{jj'} &\geq 0, \text{ integer}; \quad \forall j, j' \in M^{IMM}, j < j' \\
&\quad \forall j, j' \in M^{CHEM}, j < j' \\
&\quad \forall j, j' \in M^{HEM}, j < j' \\
&\quad \forall j, j' \in M^{COAG}, j < j'
\end{aligned} \tag{41}$$

Equations (1), Equation (2), and Equation (3) represent the objective functions. The first objective is to balance the load among the analyzers of each discipline in terms of the total number of tubes assigned to each analyzer from different tube classes. The second objective is to balance the load among the analyzers of each discipline in terms of the total number of tests assigned to each analyzer considering the analyzer's speed and capacity. The third objective is to minimize total tube movements between the analyzers within the laboratory. In this objective function, the total tube movement is composed of the sum of the total tube movements for each class of tubes in the system. This decomposition provides the possibility to give different importance factors (costs) to the movements of a certain class of tubes. Constraint (4) assures that each test of a tube must be analyzed by an analyzer. Thus, if test h is requested by tube i ($TH_{ih} = 1$), the test must be done by an analyzer which is able to analyze the test. Constraint (5) presents that a test can be assigned to an analyzer only if the associated tube is assigned to that analyzer. Constraint (6) assures that the number of tests assigned to each analyzer for any specific test type must not exceed the available amount of reagent for that test type on that analyzer. Constraint (7) guarantees that the total number of tests assigned to each analyzer respects the available capacity of the analyzer. Constraint (8) to (13) represent the total number of tubes assigned to each analyzer from different tube classes. Constraint (14) to (17) present the total number of tests assigned to each analyzer. Constraint (18) to (23) are technical equations used to linearize a non-linear load balancing objective function in terms of the total number of tubes assigned to each analyzer from different tube classes considering the analyzer's speed. Constraint (24) to (27) are technical equations used to linearize a non-linear load balancing objective function in terms of the total number of tests assigned to each analyzer

considering the analyzer's speed. Constraints (28) to (41) imply the type of decision variables used in the model.

5.2.3. Resolution approach and computational results

In this section, the case study introduced in the first chapter (section 1.6.1) is used to validate the proposed mathematical model with three objectives for the assignment problem. As a reminder, the analyzers selected in chapter two and configured in chapter four are the analyzers used in the system with the determined configuration. The aim is to find an appropriate tube-analyzer and tube test-analyzer assignment in the designed laboratory considering all the three aforementioned objective functions. To do so, the proposed mathematical model is coded in GAMS 24.1.3 and is solved using the CPLEX solver. In addition, the weighted sum method is applied to convert the model into a single-objective one. Since the values of the objective functions vary in different scales, objectives need to be normalised. To find the normalised value of each objective, each objective is optimized separately. Table 5-2 presents the extreme values for each objective function where F_1 , F_2 , and F_3 are the first, second, and third objective function, respectively.

Table 5-2. Extreme values of each objective function.

	F_1	F_2	F_3	<i>CPLEX time (sec)</i>
F_1	4.8325*	13.686	17,387	9.25
F_2	18.562	13.259*	31,186	5.58
F_3	5.985	13.542	15,987*	6.98
F^{min}	4.8325	13.259	15,986	-----
F^{max}	18.562	13.686	31,186	-----

Considering these extreme values, normalised objective functions are obtained as follows:

$$F'_1 = \frac{F_1 - F_1^{min}}{F_1^{max} - F_1^{min}} = \frac{F_1 - 4.8325}{18.562 - 4.8325} = \frac{F_1 - 4.8325}{13.7295}$$

$$F'_2 = \frac{F_2 - F_2^{min}}{F_2^{max} - F_2^{min}} = \frac{F_2 - 13.259}{13.686 - 13.259} = \frac{F_2 - 13.259}{0.427}$$

$$F'_3 = \frac{F_3 - F_3^{min}}{F_3^{max} - F_3^{min}} = \frac{F_3 - 15,987}{31,186 - 15,987} = \frac{F_3 - 15,987}{15,199}$$

Consequently, the model is converted to a single-objective in which the objective function is defined as follows:

$$OF = \pi_1 F'_1 + \pi_2 F'_2 + \pi_3 F'_3 \rightarrow$$

$$OF = \pi_1 \frac{F_1 - 4.8325}{13.7295} + \pi_2 \frac{F_2 - 13.259}{0.427} + \pi_3 \frac{F_3 - 15,987}{15,199}$$

Where $\pi_1, \pi_2, \pi_3 \in [0,1]$. To determine the value of π_1, π_2 , and π_3 which imply the importance of the objective functions, the expert opinion is taken into account, so that values noted in [Table 5-3](#) are proposed. The model is solved for each proposed set of importance factors and the values of objective functions are obtained. [Table 5-3](#) illustrates the value of each objective function for each set of weights.

Table 5-3. Values of objective functions under different sets of importance factors.

π_1	π_2	π_3	F_1	F_2	F_3	Relative gap (%)	Run time (sec)
1	0	0	4.8325	13.686	17,387	0	5.02
0	1	0	18.562	13.259	31,186	0	5.32
0	0	1	5.985	13.542	15,987	0	6.66
0.2	0.3	0.5	5.2	13.259	16,217	0	10.12
0.2	0.2	0.6	5.611	13.260	16,053	0	8.08
0.3	0.1	0.6	5.2	13.260	16,220	0	7.5
0.3	0.3	0.4	5.161	13.26	16,242	0	7.98
0.4	0.1	0.5	5.161	13.259	16,242	0	15.26

Considering final expert opinion, it's been decided to give π_1, π_2 , and π_3 values of 0.2, 0.3, and 0.5, respectively. So, the solution found under these weights is taken to assign the tubes to the analyzers and also to assign tests of tubes to the analyzers. Consequently, values of decision variables x_{ij} and y_{hij} which respectively indicate the assignment of tubes to the analyzers and tests of tubes to the analyzers are used for the assignment. [Table 5-4](#) presets a portion of the tube-analyzer assignment. In addition, [Table 5-5](#) illustrates a portion of the assignment of tubes' tests to the analyzers.

Table 5-4. Assignment of tubes to the analyzers.

Tube	AU480	AU5822	DxI600	DxI800
T1		1		
T2		1		
T5	1	1		
T6	1			
T7		1		
...
T1663				1
T1664				1
T1665			1	
T1668				1
...
T2116		1		1
T2117		1	1	
T2119		1	1	
T2120		1	1	
T2121	1			1
...

Table 5-5. Assignment of tubes' tests to the analyzers.

<i>Test Name</i>	<i>Tube</i>	<i>AU480</i>	<i>AU5822</i>	<i>DxI600</i>	<i>DxI800</i>
ALT	T1		1		
AST	T1		1		
ALT	T3529	1			
HBsAb	T3529			1	
HBsAgV3	T3529			1	
...

Table 5-6 summarizes the assignment outputs. The results show a proportional balanced assignment between the analyzers of each discipline in terms of the number of tubes and tests. For instance, the capacity of DxI800 is two times bigger than the capacity of DxI600, hence, the total number of Immunology tubes and tests assigned to DxI800 is almost two times more than what has been assigned to DxI600 in terms of tubes and tests. Additionally, the total number of tubes movement among the analyzers in the laboratory is 5,819 denoting the total number of times that tubes pass through Automate to be analyzed on the analyzers. In addition, the average number of movements of a tube among the analyzers is 1.53 implying the average number of analyzers required by a tube to be completely analyzed. This average for only Immunology- Chemistry tubes is 2.0012 which shows that almost all of these tubes require one Immunology analyzer and one Chemistry analyzer to be entirely analyzed.

It is worth mentioning that the assignment results seal on the efficient configuration of the analyzers done through solving the mathematical model proposed in chapter four where test eligibility and capacity of analyzers was formed in order that tubes and their tests can be assigned among them in a balanced manner and the number of tube movements in the laboratory is controllable.

Table 5-6. Assignment output results.

	<i>AU480</i>	<i>AU5822</i>	<i>DxI600</i>	<i>DxI800</i>
Total number of Immunology tubes assigned to each analyzer	0	0	163	326
Total number of Chemistry tubes assigned to each analyzer	296	1,568	0	0
Total number of Im-Chem tubes assigned to each analyzer	158	1,574	434	1,300
Total number of tubes assigned to each analyzer	454	3,142	597	1,626
Total number of Immunology tests assigned to each analyzer	0	0	1,559	3,032
Total number of Chemistry tests assigned to each analyzer	2,185	21,856	0	0
		<i>Total</i>		<i>Average</i>
Number of tubes movement among the analyzers		5,819		1.513
Number of Immunology tubes movement among the analyzers		489		1.0677
Number of Chemistry tubes movement among the analyzers		1,864		1.124
Number of Im-Chem tubes movement among the analyzers		3466		2.0012

5.3. Aliquoting problem for clinical laboratories

5.3.1. Introduction to the aliquoting problem

In clinical laboratories, it is possible to split the content of a tube to more tubes for any reason. This action is called aliquoting. In better words, aliquoting is the act of making more tubes out of one. This operation is performed in a machine called aliquoter which normally is a part of Automate machine. On one side, aliquoting increases the number of tubes inside the laboratory and imposes aliquoting costs to the system; on the other side, it brings more flexibility to the system while tubes are assigned to the analyzers by providing the possibility of dispatching tubes to different analyzers in parallel. Additionally, dispatching each tube to only one analyzer which simplifies sample workflow in the laboratory is achievable through aliquoting. Aliquoting can be a double-edged sword as it can increase system efficiency or create unfavourable costs and consequences to a clinical laboratory. Hence, aliquoting is an important operational problem in clinical laboratories that needs to be investigated carefully and tackled efficiently. Figure 5-4 depicts the impact of aliquoting on the number of tubes in a clinical laboratory under a specific aliquoting policy. Suppose that the assignment problem has been solved and the resulting solution is presented by the initial tube-analyzer matrix. According to this example, fifteen different tube types (T1 to T15) and four analyzers (MI to MIV) exist. The number of each tube type is written on the left side of each type. The positive sign (+) presents the assignment of tubes to the analyzers. To increase the tubes' traceability in the system, the manager decides to dispatch each tube to only one analyzer. To achieve this aim, all tubes which have been assigned to more than one analyzer must be aliquoted to the number of analyzers they have been assigned to.

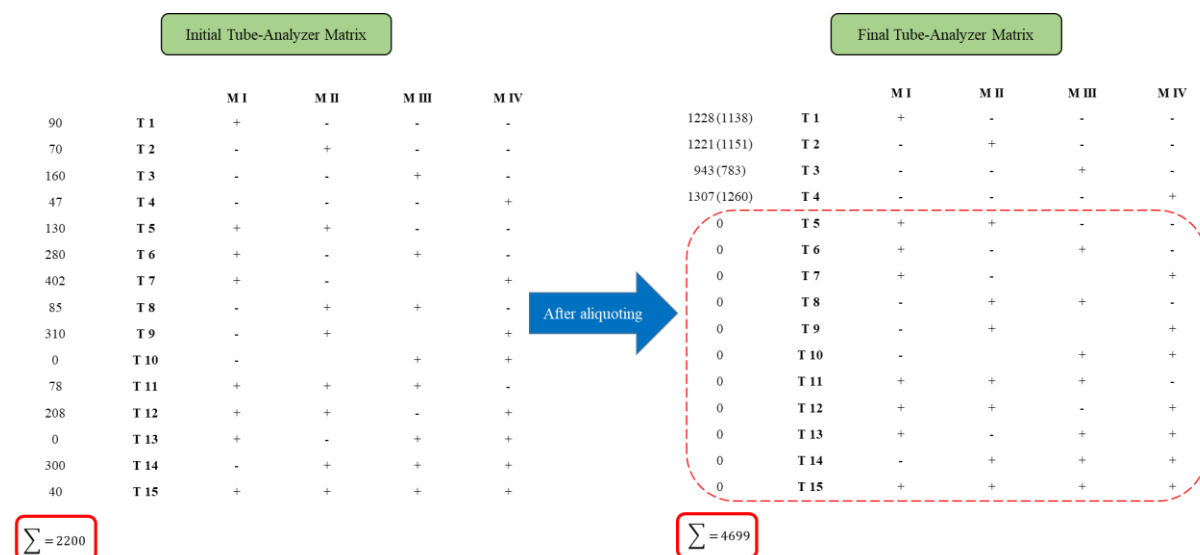

Figure 5-4. Impact of aliquoting on the number of tubes in a clinical laboratory.

The effect of such aliquoting policy on the total number of tubes in the laboratory is shown as the final tube-analyzer matrix. In this matrix, numbers written in the parenthesis on the left side of each tube type denote the number of aliquots added to each type. Comparing the total number of tubes before and

after aliquoting shows that such aliquoting policy almost doubles the number of tubes within the laboratory which is not easy to handle.

Generally, decision making on aliquoting includes answering the following three questions:

- Which tubes (samples) need to be aliquoted?
- How many aliquots have to be created from each selected tube for aliquoting?
- How tests should be assigned to the aliquots?

Figure 5-5 illustrates the aliquoting problem in the form of an example. Suppose that a tube requires tests $\{a, b, c\}$. To analyze these tests, three analyzers are needed; analyzer A for test a , analyzer B for test b , and analyzer C for test c . So, to completely analyze the tests of this tube, the tube must pass through all the three analyzers A , B , and C . All possible aliquoting options for this tube are presented in Figure 5-5. According to this figure, three aliquoting options exist. The first option is not to aliquot; consequently, all the three tests $\{a, b, c\}$ must be done on the primary tube. The second option is to make one aliquot out of the primary tube; consequently, two tubes (one primary and one aliquot) are available to which tests can be assigned in three states. Finally, the third aliquoting option is to make two aliquots out of the primary tube, so that three tubes (one primary and two aliquots) will be available to which tests can be assigned in only one way. According to this example, for each aliquoting candidate, the number of required aliquots as well as tests of the primary tube and its aliquots must be determined.

In the next section, two approaches are proposed to answer the aforementioned questions.

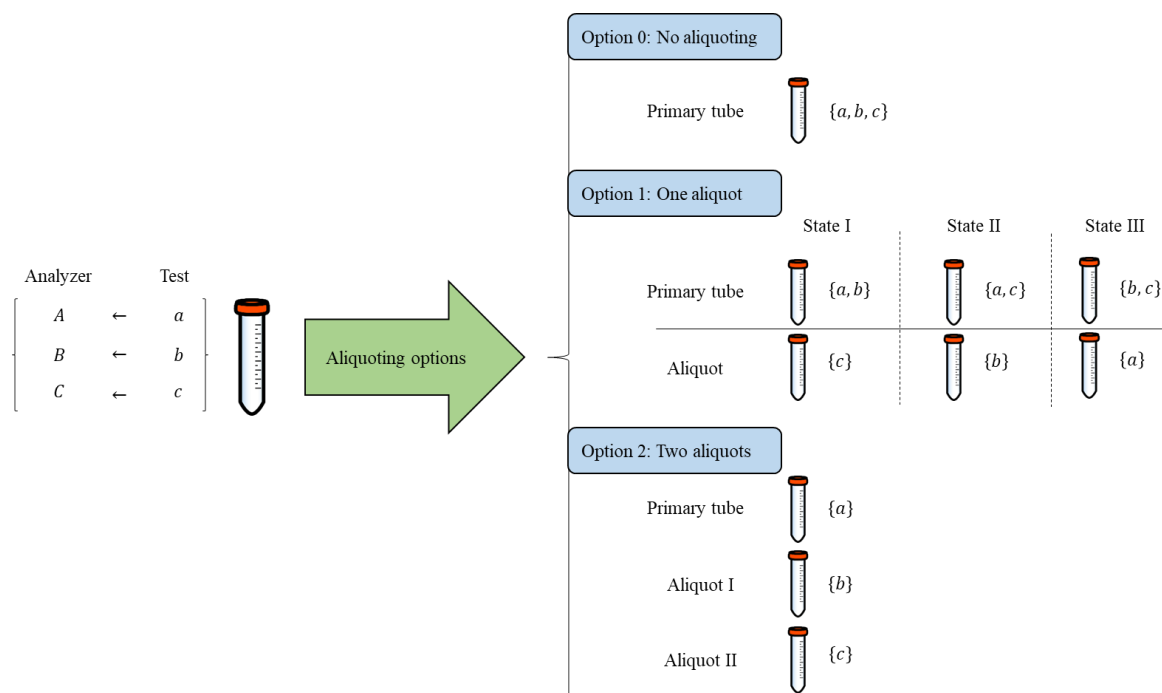

Figure 5-5. All possible aliquoting options for the illustrative example.

5.3.2. Proposed global frameworks for the aliquoting problem

As previously expressed, assignment, aliquoting and scheduling are the main operational problems in a clinical laboratory. Aliquoting can be helpful if it brings advantages to the system such as smoothing the workflow, constraint satisfaction and KPIs improvement, otherwise, it only imposes excessive costs to the organization. Hence, decisions on aliquoting need to be made carefully and wisely. Generally, aliquoting decisions depend on the managerial needs. For instance, to increase the samples' traceability in the laboratory, one can decide to send tube samples to only one analyzer. To maintain such decision, all tubes assigned to more than one analyzer have to be aliquoted to the number of analyzers they have been assigned. As another instance, to satisfy due date constraints for samples, one can decide to aliquot only the tubes whose deadlines have been violated. In this case, aliquoting the tubes with violated deadlines bring the possibility to send the tubes to the assigned analyzers in parallel which might alleviate job tardiness. To conclude this discussion, what is obvious from the instances is that aliquoting policies rely strongly on the assignment and scheduling output results. In the following, two approaches are proposed to tackle the aliquoting problem. In the first approach, the aliquoting problem is considered as an optimization problem in a way that is applied for constraint satisfaction while the number of aliquots are minimized. In the latter approach, different aliquoting policies are considered based on managerial insights through the analysis of the assignment result, then, all proposed policies are evaluated and the most appropriate one is finally selected. It is worth noting that to evaluate the effect of each aliquoting policy on laboratory performance, a simulation model is used which is fully detailed in the next chapter.

5.3.2.1. First proposed framework for the aliquoting problem

This approach relies on the principle expressing aliquoting as a costly activity in the clinical laboratory. Therefore, aliquoting must be only done if it brings advantages to the organization regarding constraints satisfaction or KPIs improvement. [Figure 5-6](#) presents the global scheme of the first proposed approach to tackle aliquoting problem. According to this figure, the assignment problem is firstly solved based on tube-test and analyzer-test matrixes as the inputs. The assignment output is two matrices: the tube-analyzer matrix implying the assignment of tubes to the analyzers, and the tube test-analyzer matrix denoting the assignment of tube tests to the analyzers. Then, sequencing of tubes on different analyzers is determined. After that, a simulation model incorporating the output of assignment and scheduling as well as other necessary elements to build a complete laboratory is applied to evaluate system performance and compute KPIs. In the next step, the obtained KPIs are compared to the managerial objectives and constraints. If the results are satisfactory and all the constraints are met, no aliquoting is needed denoting that the number of required aliquots is zero. But, if the results are not satisfactory, regarding the objective or constraints of interest, one tube or a set of tubes are selected for aliquoting. This selection can be done randomly or intentionally from the eligible tubes for aliquoting. A tube is

eligible for aliquoting if it has been assigned to more than one analyzer. In the tube selection phase for aliquoting, it is recommended to start from a small portion of tubes and increase it incrementally in the next loops if it is needed, in order to achieve the minimum number of tubes required for aliquoting. The next phase for aliquoting is to determine the number of aliquots out of each aliquoting candidate. Again, to minimize the number of required aliquots, start with the minimum possible number. The last phase of aliquoting is to distribute the tests requested by the primary tube to its aliquots and itself. To tackle the last two phases of aliquoting, assignment output matrices are used and the effect of aliquoting on these matrices are applied directly.

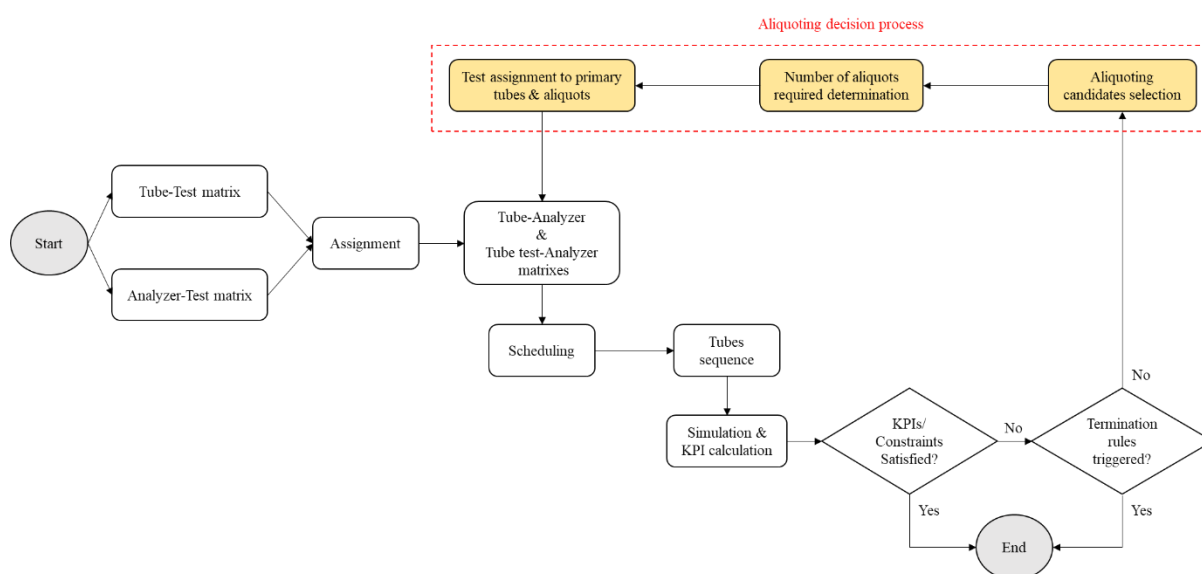

Figure 5-6. Global scheme of the first proposed approach for the aliquoting problem.

For instance, suppose that tube ‘T1’ has been selected for aliquoting. [Figure 5-7](#) shows the assignment of this tube and its tests to the analyzers. According to this figure, as tube ‘T1’ has been assigned to two analyzers, only one aliquoting option is possible for this tube which is to make one aliquot out of the tube. In addition, to assign the tests to tube ‘T1’ and its aliquot, tube test-analyzer matrix is useful. According to this matrix, tests $\{a, b\}$ are assigned to ‘T1’ and tests $\{c, d\}$ to its aliquot which is named ‘T1.1’.

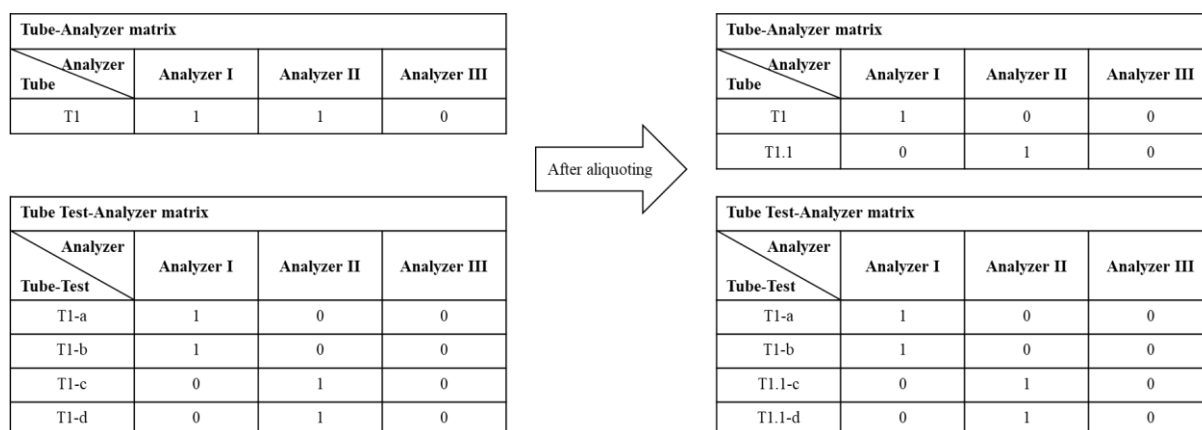

Figure 5-7. Effect of aliquoting on the assignment output matrices.

After applying the required aliquoting changes to the assignment output matrixes, again, tube sequences are determined through dispatching rules and simulation is used to compute the system KPIs for the new batch of tubes. This loop is repeated until either objectives and constraints of interest be satisfied or a termination rule is triggered. Exceeding an upper bound for the number of aliquots or a threshold for a criterion can be considered as some termination rules. Following this approach seems to be helpful to take advantage of the minimum number of aliquots to ameliorate clinical laboratory performance.

5.3.2.2. Second proposed framework for the aliquoting problem

In this framework, a certain number of aliquoting policies are proposed by experts considering laboratory global policies and assignment output results. Each aliquoting proposal is considered as a scenario. Then, the effect of each scenario on the assignment output matrixes is applied. After that, tubes are scheduled on the analyzers through a specific scheduling algorithm. Then, laboratory behaviour is simulated through a simulation model to evaluate the effect of each aliquoting policy on system performance. Average tests turnaround time, number of tardy tubes, the average tube time in the system as well as the costs of aliquoting for each scenario can be considered as the most important criteria for scenario comparison. At last, outputs of each scenario are investigated and compared with others to rank the scenarios. The best obtained scenario denotes the most suitable aliquoting policy for the clinical laboratory under a certain demand. Figure 5-8 presents the whole picture of the second proposed framework to tackle the aliquoting problem. It is worth noting that simulation modeling of the clinical laboratory is detailed in the next chapter.

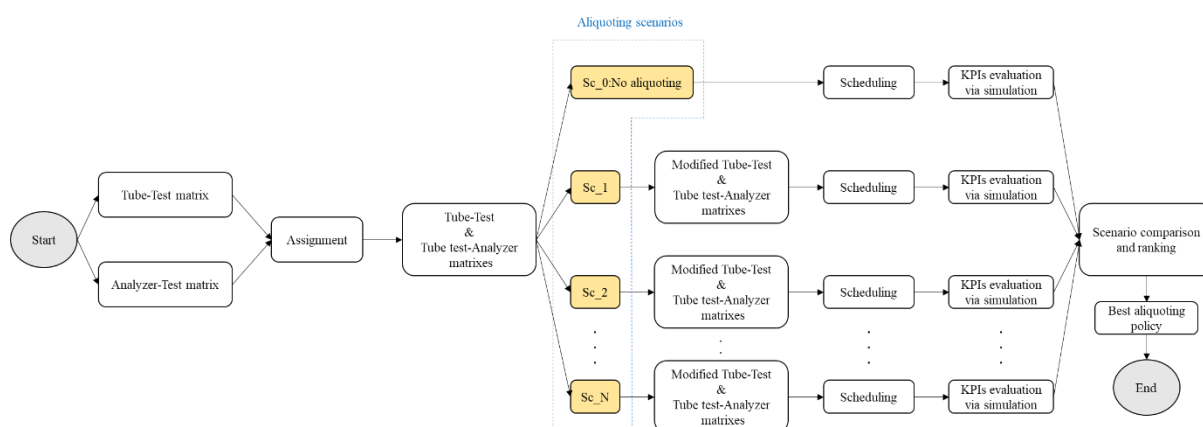

Figure 5-8. Global picture of the second proposed framework for the aliquoting problem.

5.4. Scheduling problem for the clinical laboratory

In this section, the scheduling literature is briefly surveyed by emphasizing the practical aspects of the problem. Then, the main characteristics of the clinical laboratory scheduling problem is introduced. At the end, dispatching rules are proposed to deal with the scheduling problem in clinical laboratories.

It is worthy to mention that a customized simulation model is described in the next chapter in which all characteristics of the laboratory scheduling problem are taken into account. Therefore, this simulation tool is used to evaluate the effect of any applicable dispatching rule on clinical laboratory performance.

5.4.1. Introduction to the scheduling problem

The term ‘*scheduling*’ is defined as the allocation of resources over time to perform tasks (Pinedo, 2016). A schedule is an assignment of jobs over time to the resources. Normally, a Gantt chart is used as a common graphical tool to present a schedule. Figure 5-9 shows a Gantt chart presenting the schedule of operations of two jobs on two resources.

Generally, a scheduling problem is to find a schedule which optimizes one or more objectives under certain constraints. Mathematically speaking, a scheduling problem deals with the assignment of n jobs $\{J_1, J_2, \dots, J_n\}$ to m machines $\{M_1, M_2, \dots, M_m\}$ over time to optimize some objectives while respecting some constraints (Pinedo, 2016). In a scheduling problem, the main data associated with a job (j) are as follows:

- *Processing time* (p_{ij}): The p_{ij} represents the processing time of job j on machine i .
- *Release date* (r_j) or *ready date*: It is the time that a job arrives at the system; the earliest time at which job j can start its processing.
- *Due date* (d_j): It represents the committed shipping or completion date. It is the date the job is promised to the customer. Completion of a job after its due date is allowed, but then a penalty is incurred. When a due date must be met it is referred to as a *deadline* and denoted by \bar{d}_j .



Figure 5-9. Gantt chart of two jobs on two machines.

- *Weight (w_j)*: It is basically a priority factor, denoting the importance of job j relative to the other jobs in the system.

Scheduling is known as one of the combinatorial problems in operations research. Most of the scheduling problems are known as NP-hard (Blazewicz et al., 1983). To characterize a scheduling problem, two popular notations have been introduced by Conway et al. (1967) and Graham et al. (1979), respectively. These notations are presented in Figure 5-10.

Classic machine environments are single machine (1), identical machine in parallel (P_m), machines in parallel with different speeds (Q_m), unrelated machines in parallel (R_m), flow shop (F_m), flexible flow shop (FF_c), job shop (J_m), flexible job shop (FJ_c), and open shop (O_m) (Pinedo, 2016). Notations used in the parentheses briefly characterize the type of machine environment for the scheduling problem where m denotes the number of machines and c implies the number of work centers (stages) made of one or more identical machines.

Release date, precedence constraints, pre-emptions, sequence dependent set-up times, job families, batch processing, breakdown, machine eligibility restrictions, permutation, recirculation, blocking, no-wait, and splitting jobs are the most common constraints considered to characterize a scheduling problem in the literature (Pinedo, 2016).

Various objectives have been investigated for the scheduling problem in the literature. Mellor (1966) introduced twenty-seven different objectives for the scheduling problem such as maximum output, adherence to job priorities, maximum utilization of resources, etc. Baker (1974) proposed three types of decision making goals for the scheduling problem:

- Efficient utilization of resources: Makespan.
- Rapid response to demands: Mean completion time, mean flow time, mean waiting time.
- Close conformance to prescribed deadlines: Mean tardiness, maximum tardiness, number of tardy jobs.

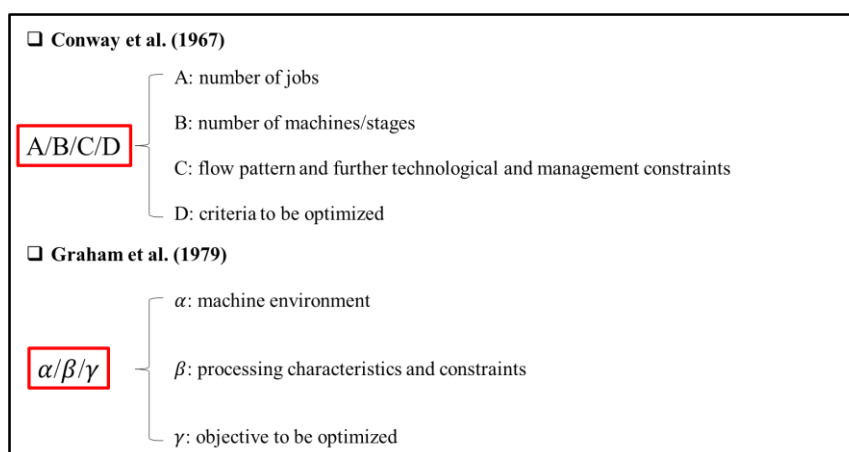

Figure 5-10. Standards used to address a scheduling problem in the literature.

5.4.1.1. Scheduling theory vs. scheduling practice

Although many efforts have been carried out to tackle complex scheduling problems, there is still a large gap between scheduling theory and practice which makes the efficient theoretical solutions useless for practical cases. In the following, major differences between scheduling theory and practice are listed [(Pinedo, 2016) and (Maccarthy and Liu,1993)]:

- Machine environments in the real world are often more complicated than the machine environments considered in theory (e.g. flow shop, job shop, open shop, etc.).
- The dynamic behavior of the system usually is not taken into account in theoretical models.
- Stochastic models studied in the literature usually assume very special processing time distributions such as exponential distributions.
- Mathematical models often do not take preferences into account.
- Processing time distributions may be subject to changes due to learning or deterioration.
- Most theoretical research has focused on models with a single objective while in practice there are usually a number of objectives.

Alongside all these differences, implementability constraints are almost always neglected in scheduling theory which leads to inapplicable solutions in practice.

5.4.1.2. Widely used approaches for the scheduling problems in practice

Approaches used to deal with a real scheduling problem in practice should provide not only feasible suitable solutions but also computationally effective solutions. These approaches need to be flexible to possible changes to provide new solutions considering the real states of the system. In addition, they must be implementable in the system not using excessive data and resources, and also their resulting solutions must be applicable.

Investigating the scheduling literature reveals the extensive application of heuristics to tackle scheduling problems in practice [(Umetani et al., 2017), (D'Ariano et al., 2015)]. Heuristic methods aim at finding reasonably good solutions in a relatively short period of time without any guarantee for optimality. The reason why heuristic techniques are so common for practical scheduling problems is that these methods can be implemented with relative ease in industrial scheduling systems. In addition, these techniques are relatively flexible to be designed for a specific objective function or particular machine environment. Furthermore, these methods are relatively able to respond to dynamic changes. Dispatching rules, local search techniques, and meta-heuristics are different types of heuristics used to solve scheduling problems in practice (Pinedo, 2016).

5.4.1.2.1. Dispatching rules

Dispatching rules, also called priority rules, are a kind of broadly used heuristics for solving scheduling problems (Rajendran and Holthaus, 1999). A dispatching rule assigns the jobs waiting in a queue of a resource to that resource through re-ordering the jobs based on the priorities. In fact, a priority value is assigned to each job waiting in the queue based on the dispatching rule. Once the resource gets available, the job with highest priority value is dispatched to the resource. Generally, two main attributes are used to construct a dispatching rule: job-related attributes such as processing time, release date, due date, weight; and machine-related attributes such as speed, number of jobs waiting for processing, etc.

Some classifications are proposed to classify dispatching rules based on different points of view (Pinedo, 2016):

- Based on time dependency, dispatching rules are grouped into static rules and dynamic rules. Static rules are not time dependent (e.g. shortest processing time (SPT)); however, dynamic rules depend on the time (e.g. minimum slack).
- Based on required data, priority rules are classified into local rules and global rules. A local rule uses only information pertaining to either the queue where the job is waiting or to the machine where the job is queued. (e.g. SPT). A global rule may use information regarding other machines, such as the processing time of the job on the next machine on its route. (e.g. longest alternate processing time rule for $O_2 \parallel C_{max}$).
- Based on structural characteristics, dispatching rules are categorized into simple priority rules, a combination of simple priority rules, weighted priority rules, heuristic rules, etc.

5.4.2. Description of the clinical laboratory scheduling problem

In a clinical laboratory, there are many sample tubes each of which ordering plenty of tests which must be treated through pre-analytical steps and then, analyzed by one or more existing analyzers. Generally, the scheduling problem of a clinical laboratory is to find a feasible assignment of tubes to the resources over time with the aim of optimizing one or more objectives while respecting all system characteristics and constraints. In order to describe the scheduling problem of a clinical laboratory more in detail, the main characteristics and attributes of this problem are listed in the following.

- A clinical laboratory is a real-world system with a complicated machine environment. In better words, this system cannot be fully covered by any classic machine environment proposed in the literature.
- A clinical laboratory is a dynamic system where a new batch of tubes might arrive at any time.
- Three main flows exist in a clinical laboratory:
 - Tube flow through the system which demonstrates the movement of tubes and rack of tubes among different points of a clinical laboratory.

- Testing sample flow within the analyzers which denotes the movement of testing samples taken from the tubes inside the analyzers. Generally, to analyze a test on a tube, a portion of a tube is taken by the analyzer called testing sample. Depending on the analyzer type, testing samples pass through different internal elements within the analyzer or might even split into more testing samples.
- Information flow through the system which mainly indicates the flow of test results from analyzers to the validation stations.

It is worth noting that all these three flows are modeled through the simulation model introduced in the next chapter.

- Machines have different and complicated operational attributes. An analyzer in a clinical laboratory might have different processing modules with different processing behaviors, eligibilities, and capabilities. Operating characteristics of the analyzers directly affect the starting time, processing time and completion time of the tubes. Fine-grained simulation models have been developed to imitate the real behavior of the main existing machines in the laboratory which are entirely detailed in the next chapter.
- Batch processing as one of the constraints in the scheduling problem is seen among some resources of clinical laboratory. For instance, the centrifuge machine is able to handle maximum four batches (racks) of tubes at a time, nevertheless, if it starts processing with only one rack, no new rack can be added to this machine until the completion of the under-processed rack.
- The test capability of analyzers depends on the reagents used in the analyzers and might differ from one to another. The difference in a machine's test capability brings the eligibility restriction to the scheduling problem of the clinical laboratory. It is worth mentioning that the test eligibility of analyzers changes over time as reagents consumed for test analysis.
- Tubes which require both Immunology and Chemistry tests must visit the Immunology analyzer(s) prior to Chemistry analyzer(s) which impose precedence constraints to the scheduling problem of the clinical laboratory.
- Aliquoting provides the possibility of making more tubes out of one which brings new jobs to the system to be treated. Comparing aliquoting with classic constraints of scheduling problem, some similarities are seen between aliquoting and splitting job.
- Re-analyzing some tests due to some abnormalities in results known as '*Rerun*', can be the case in clinical laboratory scheduling problem. Also, adding extra test(s) to a tube known as '*Reflex*', due to abnormal results or other technical reasons can be occurred.
- As all tubes are sent back to the Automate machine from the analyzers, backtracking or recirculation is a common case in the scheduling problem of a clinical laboratory.

- Tubes might have different priorities in the laboratory. A broad classification categorizes tubes into two groups: routine and STAT. Routine tubes have a normal priority while urgent tubes are pointed as STAT.
- In clinical laboratories, in addition to machines, operators are important resources. Operators work as transporters to move racks inside the laboratory or as operation executer at registration desk or validation consoles. An operator can be assigned to one or more tasks. Operator availability affects the scheduling in clinical laboratory and must be taken into account as a crucial element.
- The scheduling problem of a clinical laboratory is a multi-objective problem. Turnaround time minimization and throughput maximization are considered as the main objectives for clinical laboratories. In the second level, the number of tardy jobs and resource utilization are of interest.

5.4.3. Proposed approach for the clinical laboratory scheduling problem

Due to the complexity of the clinical laboratory scheduling problem and also, considering the implementability of scheduling rules as well as the applicability of scheduling solutions in a real system, dispatching rules are identified as the most proper techniques to deal with this problem. In this thesis, a first-come-first-served (FCFS) rule is the only dispatching rule applied to sequence tubes in different processing stages. A fine-grained simulation model which incorporates all the main characteristics of a clinical laboratory is developed to compute time-based KPIs such as test turnaround time and average waiting time under the FCFS rule. Details of the developed simulation model are explained in the next chapter as well as the application of this tool to evaluate the scheduling measures. It is worth noting that the aim of this thesis is not to investigate the effect of different scheduling policies on a clinical laboratory, but to provide a tool covering all the principal attributes of the system to provide realistic time-related measures for the laboratory under a simple scheduling rule; however, the developed simulation tool provides the ability of implementing and evaluating different priority rules on system performance.

5.5. Conclusion

Assignment, aliquoting and scheduling are the most significant operational problems in a clinical laboratory. In this chapter, each of these three problems were fully described. In order to tackle the assignment problem, a mathematical model with three objectives was proposed in which the first two objectives try to balance the load among analyzers in terms of tube and test quantity, and the third objective is to minimize total tube movements within the system considering different importance factors for the movement of each class of tubes. To validate the proposed model and to show its efficiency, the model was solved considering data of a real laboratory.

Concerning the aliquoting problem, two general frameworks were proposed. In the first framework, the aim is to use aliquoting to ameliorate clinical laboratory performance with the minimum number of aliquots while in the second framework, several aliquoting policies are evaluated and analyzed to select the best aliquoting policy for a certain demand under a certain condition. Totally, the first proposed framework has more operational features than the second one. The second approach is more proper to decide on a fixed aliquoting policy for a clinical laboratory.

Concerning the scheduling problem, the main features and characteristics of a clinical laboratory scheduling problem was addressed. To efficiently sequence the sample tubes and racks within the clinical laboratory in practice, dispatching rules as simple heuristics were suggested. Additionally, a simulation model which incorporates all features of a clinical laboratory was proposed to evaluate the impact of dispatching rules on the system performance. This simulation tool and its application is fully described in the next chapter.

Chapter 6

Clinical Laboratory Simulation Modeling and Analysis

6.1. Introduction to computer simulation

Computer simulation is one of the most-used operations research tools among researchers and practitioners. Simulation modeling is used when analytical approaches such as mathematical programming and queueing theory techniques are not able to handle problem's complexity (Pritsker and O'Reilly, 1999). Unlike analytical approaches, a simulation model does not provide optimal values for performance criteria. Rather, it generates a representative average value for performance measures (Heragu, 2008).

Nowadays, with regards to the evolution of computers computational speed and many improvements in simulation languages and software packages, computer simulation is being used more extensively for system performance evaluation and decision making process. Simulation modeling has been broadly used in the literature for complex system design and planning (Law and Kelton, 1991). Numerous applications of simulation are seen in many different domains including but not limited to healthcare (Mielczarek and Uziako-Mydlikowska, 2012), military (Naseer et al., 2009), supply chain (Terzi and Cavalieri, 2004), and manufacturing (Negahban and Smith, 2014).

Computer simulation has been introduced as a powerful, versatile, flexible, effective but computationally expensive tool to model, evaluate and analyze a real-world, complex, stochastic and dynamic system performance. A simulation model is a simplification or abstraction of a real-world system which provides the chance of system analyzing with less costs (Law, 2003). Generally, a simulation model is developed for one or more of the following purposes:

- As a powerful tool, simulation is used to model and analyze the behaviour of a complex system. A simulation model provides the opportunity to fully understand the system and diagnose potential bottlenecks.
- As a what-if tool, a simulation model is applied to evaluate several different scenarios to find out the best alternative.
- As a prediction tool, a simulation model can be utilized for prediction and projection of a system to understand the future situation.
- As a visual tool, a simulation model can provide a virtual presentation of a real system to convince managers or to attract customers.

6.1.1. Types of simulation models

Basically, simulation models are classified based on three factors: timing of change, randomness, and data organization (Mourtzis et al., 2014).

Regarding the time factor, a simulation model can be static or dynamic. A dynamic simulation model evolves over time while a static model is independent of time. A dynamic model can be further

subdivided into discrete and continuous. In discrete simulation model, changes take place at discrete points in time whereas in continuous models, the variable of time is continuous. In more detail, a discrete simulation model is categorized into time-stepped and event driven. Time-stepped comprises regular time intervals and alterations occur after passing a specific period of time; however, in event-driven simulation, updates are linked to the events.

Concerning the randomness factor, a simulation model can be categorized into deterministic and stochastic. Repetition of a deterministic model always leads to the same result while, for a specific stochastic model, repetition will not always produce the same output.

According to data organization, a simulation model can be classified as grid-based and mesh-free. Grid-based implies that data are associated with discrete cells at certain locations in a grid and changes occur to each cell in accordance with its former state and those of its neighbours. On the other side, mesh-free associates with data of individual particles and updates look at each pair of particles.

Figure 6-1 illustrates different types of simulation models. Among all these model types, discrete-event-simulation (DES) is more of interest. DES is known as one of the most commonly used techniques for analyzing, evaluating and understanding the dynamics of complex systems (Carson et al., 2005).

6.1.2. Important concepts in simulation studies

In this section, some significant concepts that need to be addressed in any simulation study are discussed.

- **Verification** is concerned with specifying whether the conceptual simulation model has been correctly transformed into a computer program.
- **Validation** is the process of determining whether a programmed simulation model is an accurate representation of the system, for the particular objectives of interest. If the model is valid, then it can be used for system analysis under various scenarios.
- **Credibility** is discussed when a simulation model and its results are accepted by the decision maker and other key project personnel. A valid model does not imply a credible model and vice versa. In better words, if the assumptions of a valid model are not understood and confirmed by the manager, the model might not be used in decision making process.
- **Input modeling** is a statistical issue concerning with specifying the right types of distribution function for certain system parameters to properly represent the randomness.
- **Output analysis** is also a statistical issue dealing with estimating a simulation model's true performance measures. Simulation run length, length of the warmup period, and the number of independent model replications are important topics in simulation output analysis.

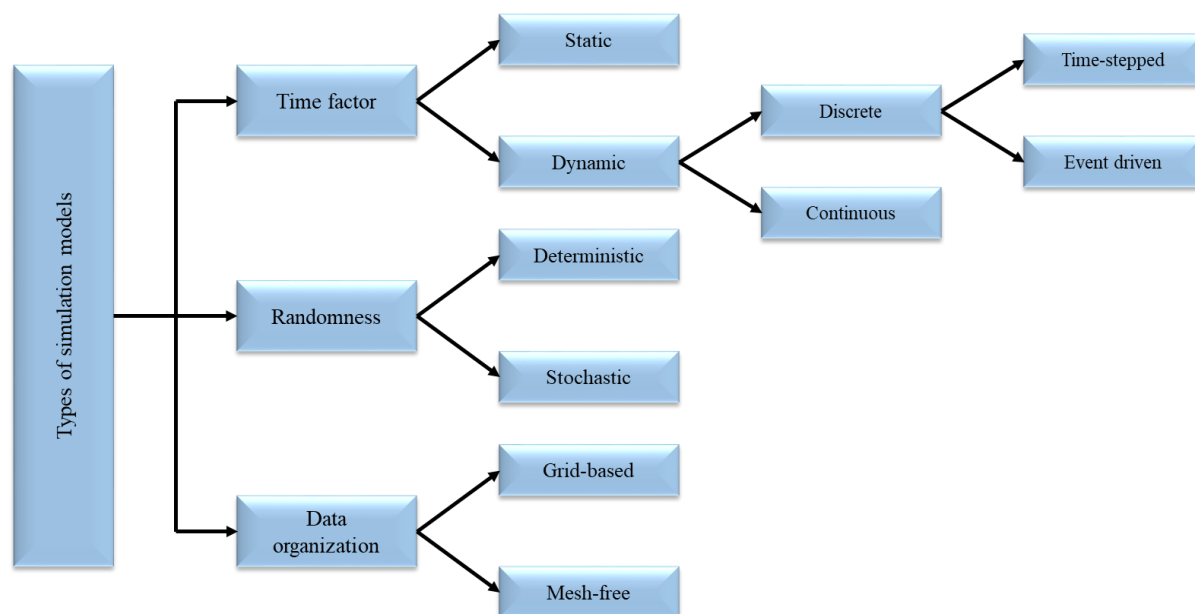

Figure 6-1. Types of simulation models.

6.1.3. How to conduct a successful simulation model?

A systematic seven-step approach has been introduced by Law (2003) to successfully conduct a simulation model. Figure 6-2 shows the steps of this approach covering all the essential actions from problem formulation up to simulation results presentation and documentation. Hereafter, each step is briefly described:

1. Problem formulation - In this step, the problem of interest is described by the decision maker. Objectives of the study, specific questions which need to be answered through the study, appropriate level of model detail, system performance measures, and system configurations to be modeled are the main things which need to be addressed in the problem formulation.

2. Information/data collection and conceptual model construction - In this phase, the required information to understand system structure and operations are collected. Also, data required to specify the value of the model parameters are gathered in this step. Constructing a conceptual model which includes overall objectives and performance measures of interest, system process-flow, detailed description of sub-systems, simplifying assumptions, and the source of important information is the other important task in this stage. Furthermore, the level of model detail is specified in this step. It is also necessary to interact with the decision maker while building the conceptual model for the decision maker's better understanding and to take into account possible modifications in order to eventually make a more credible model. Last but not least, performance data of the existing system is collected in this step to be used for model validation.

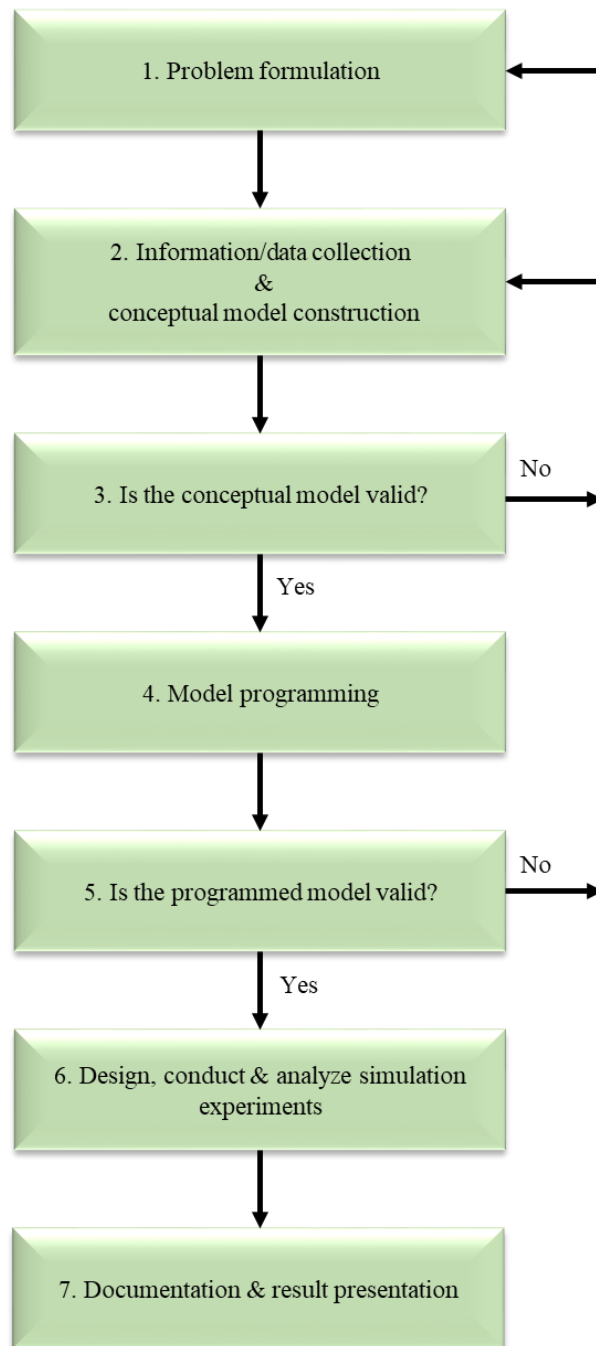

Figure 6-2. Framework for a successful simulation study [Law (2003)].

3. Conceptual model validation - This step is performed by a structured demonstration of the conceptual model before the project manager and analysts to verify the conceptual model validity.

4. Model programming - After confirmation of the conceptual model, this model is programmed either using a general-purpose programming language (e.g. C/C++) or a commercial simulation-software product. The latter possibility has two global types: general purpose (e.g. Arena, SIMUL8, Extend), and application oriented (e.g. FlexSim, AutoMod, WITNESS). Familiarity, greater program control and lower software purchase cost are the advantages of a general purpose programming language for

simulation modeling while, usage of a commercial simulation-software product reduces the programming time and might lead to smaller overall project cost.

5. Programmed model validation - Generally, two ways are suggested for simulation model validation depending on the existence of a real system. If there is an existing system, the output of the programmed simulation model is compared with the system performance data collected from the real system. This approach is the most important validation technique and is called 'result validation'. If no real system exists, the simulation model needs to be reviewed and results have to be checked by analysts and subject-matter experts (SMEs) to face validity.

6. Design, conduct and analyze simulation experiments - Before running a validated simulation model, simulation run length, length of the warm-up period and the number of model replications need to be determined. In this step, a simulation model is run for any system configuration of interest and consequently, the output results are analyzed.

7. Documentation and result presentation - In this step, a detailed documentation including the conceptual model and the computer program have to be prepared. In addition, to promote the model credibility, a presentation including animations, and model building and validation processes is recommended before the managers, analysts and SMEs.

6.2. Toward a customized environment for clinical laboratory simulation modeling

Computer simulation is a useful tool for efficient design of a clinical laboratory. A clinical laboratory is a complex system with specific characteristics. In addition, machines as the key elements in the laboratory play an important role in system performance. Hence, in order to build a valid, reliable and credible simulation model of a clinical laboratory, a crucial need for a customized, flexible and user-friendly simulation environment is appreciated in which all significant system characteristics are taken into account. In other words, the simulation environment must be customized meaning that all the specific features of the system and its sub-systems must be taken into consideration with sufficient attention into details. Furthermore, the customized simulation environment needs to be flexible to cover any system configuration of interest. At last, user-friendliness of the simulation environment is important to provide easy use for both decision makers and marketing individuals. Besides all these features, the simulation model needs to be visually attractive demonstrating the real operations in the system to absorb managers' and clients' viewpoints.

In this thesis, a customized, flexible and user-friendly simulation environment is developed in FlexSim which enables to model any clinical laboratory with a standalone sorter. This simulation environment contains a customized library in which most of the clinical machines have been modeled in detail. Through this tool, designers are able to analyze the behaviour of the system and evaluate the performance measures of the designed clinical laboratory. Additionally, decision makers can use this

tool for scenario analysis and wise decision making. Furthermore, this tool is able to provide attractive and understandable presentation for both managers and customers.

FlexSim is an application-oriented simulation software which has been widely used in various fields such as healthcare, manufacturing systems, airports and warehouse management (Beaverstock et al., 2011). Figure 6-3 compares different aspects of FlexSim with other commercial simulation software.

Required information and data to build the customized environment for clinical laboratory simulation modeling have been mostly extracted from 'LabSim'. Originally, 'LabSim' is an environment for clinical laboratory simulation modeling developed in FlexSim and dedicated to Beckman Coulter company. This simulation tool has been developed in a way that it can be used only for demonstration and marketing aspects. The main focus of this tool is on analyzers to present their performance and throughput and many other key features which affect the system performance have been neglected such as operators, pre-analytical steps, aliquoting, and test validation. Generally, 'LabSim' has been precisely studied and explored in this thesis for two main reasons: (i) to understand the behaviour of the existing machines and objects in 'LabSim', and (ii) to extract data in order to specify the value of model parameters such as test processing time, buffers capacity, etc.

Criteria Groups	Comparison Criteria	Simulation Software Tools				
		AnyLogic	Arena	Flexsim	Plant Simulation	Witness
Hardware and Software	Coding aspects	****	***	**	****	**
	Software compatibility	***	**	***	****	***
	User support	****	**	****	****	***
General features	Purpose	General	General	General	General	General
	Experience required	***	****	**	***	**
	Ease of use	***	**	**	***	****
Modelling assistance	On-line help	****	**	****	***	**
	Library and templates	***	**	****	****	***
	Comprehensiveness of prompting	***	**	***	***	***
Simulation capabilities	Visual aspects	****	**	*****	****	***
	Efficiency	****	**	****	****	***
	Testability	****	***	****	****	***
	Experimentation facilities	***	***	****	****	***
Input / Output	Statistical data	****	***	****	****	****
	Input/output capabilities	****	***	****	*****	****
	Manufacturing capabilities	****	**	****	****	*****
	Analysis capabilities	***	***	****	****	***

Figure 6-3. Comparison of simulation software tools [Mourtzis et al. (2014)].

6.2.1. Customized simulation environment main characteristics

The environment developed for clinical laboratory simulation modeling is a customized FlexSim file. Actually, this file provides the users a ready-to-use environment in which any required element has been previously prepared to build a comprehensive and powerful simulation model of a clinical laboratory. Generally, this file includes the following features:

- A customized library in which all the necessary elements to build a simulation model of a standalone clinical laboratory are ready to be used. Most of these elements have been modeled separately using several standard FlexSim objects in combination with custom codes.
- Customized flow items such as tubes and racks with different sizes.
- All necessary input and output tables.
- An ‘Import’ button by which required objects are selected from the library and located on the positions determined by the user and by which required input data can be easily imported to the model. Input data are specified by the user in an Excel file, named ‘Input File’. In other words, a simulation model can be automatically made only by filling and importing the Excel input file.

6.3. Clinical laboratory simulation modeling

In this section, the main objective of simulation modeling and study is to analyze the behaviour of the designed clinical laboratory through the proposed models in previous chapters considering neglected issues and factors. To do so, according to the proposed framework in chapter one, [section 1.5](#), outputs of optimization problems besides initial solutions for other decision problems lead to a complete clinical laboratory which is modeled via simulation. An initial solution for each neglected decision problem is considered in this chapter while introducing model assumptions. After simulation model verification and validation, the developed simulation model is used for system performance analysis. In addition, the simulation model is used for better decision making on some decision problems and change management.

6.3.1. General standalone clinical laboratory workflow

Normally, tubes arrive to the laboratory in packages in which there is also a form fulfilled in the drawing center including the profile of each tube. Then, tubes are unpacked and registered to the laboratory information system (LIS). Unpacking and registration operations both can be done by each registration operator working at the registration desk with a computer; or, in another case, packages can be distributed among the registration operators by an operator who is only in charge of distributing tube packages among registration operators. This delivery can be done in a round robin manner if the operator is available. This dispatching rule dedicates even workload to the registration operators.

Registration includes registering the requested tests of each tube and checking the tubes conformity to verify whether a tube is suitable enough to be analyzed for the requested tests or not. Unsuitable tubes are rejected and removed from the system. In some cases, laboratories know what kind of tubes are arriving so, in these cases, registration only means verifying the existence of tubes in the system. Registration is done tube per tube, taking the tube out of the package, registering in LIS and finally, place the registered tube into the rack. Here, tubes can be sorted to the tubes which require centrifugation

or the tubes which do not need to be centrifuged. This sorting can be done by the registration operator while registration is done or by another operator who is responsible for centrifugation. Tubes which need centrifugation must be placed into specific racks which are acceptable by centrifuge machine. Other registered tubes can be directly sent to the sorter (Automate) or even bypass the Automate and sent to the analyzers. Centrifuged tubes are sent to the Automate then. In addition, tubes priority (STAT or routine) can be identified by the registration operators and signed (labelled) to accelerate the process flow for the high priority tubes. Normally, STAT tubes are packed into specific racks in the drawing centers to be recognized easily by their rack colors at examination site. It is worth mentioning that in some cases, tubes are racked in drawing centers and then racks are scanned and registered instead of one-by-one tube registration in examination sites.

A centrifugation machine can be used in different manners according to the laboratory policy, real-time system status and logic of operator who's using the machine. As this machine has the capacity for certain number of racks, it can be used as soon as there is an available rack full of tubes, though the machine capacity is not full yet. Note that, as soon as centrifuge runs, no rack can be added to the machine until the process is finished. Or, the operator might wait to have enough racks to completely fill the machine and then run. Another policy is to wait for some time and then run the centrifuge with all the available racks. All these decisions depend on the laboratory policy, laboratory real-time status and operator logic, considering tubes priority, tubes quantity, etc. In the case where there is more than one centrifuge, workload dedicated to the machines can be followed by the first available (or round robin if available) dispatching rule. Furthermore, it might be efficient to reserve a centrifuge for high priority tubes.

Tubes which don't require to be centrifuged bypass this step. After centrifugation, all centrifuged tubes are distributed between Automates but before that, the rack of tubes must be changed in order to place the tubes within the racks accepted by the Automates. One or more Automates may be employed in a laboratory which can be located in different laboratory locations and used for different purposes (e.g. one between centrifuges and analyzers and the other after analyzers). As Automates used in a laboratory might be different in the ability to handle different tube types, aliquoting capability and so forth, tubes attributes (size, cap condition, analyzed or not, etc.) and requests (aliquoting or not) must be taken into account while tube distribution to the Automates is performed, in order to identify the proper sorting machine as a tube's next destination. This identification can be done by the operator who is responsible for unloading the centrifuges and loading the Automates who could be the same operator loading the centrifuges.

Automate is the heart of the clinical laboratory system. Sorting the tubes is the main task of Automate. Automates are loaded by fifty-position racks. The operator first needs to take off the empty rack from

the Automate input buffer drawer and load it with tubes and put it back to the Automate input buffer; or, in another way, the empty rack can be replaced with a similar pre-loaded rack.

Automate operation starts with grabbing the tubes from the input buffer and placing them in the conveyor designed within the Automate with fixed tube positions. This task is done by a robotic arm. Enabling to firstly grab the tubes with high priority among the tubes in the input buffer of Automate aids the laboratory to have more time to take necessary measures on the tubes to fulfil laboratory turnaround time (TAT) commitments. Tubes pending in the Automate conveyor are scanned and decapped one after another and then, grabbed again by another robotic arm to be placed whether into the specific position of a specific rack in the Automate output buffer which specifies tube next destination or in the aliquoter to aliquot the tube. The Automate's sorting drive is responsible for finding the position of each tube in the output buffer racks. Once a tube is scanned, tests requested by the scanned tube are revealed for the sorting drive receiving information from LIS. Then, the sorting drive decides to place the tube into the suitable rack and proper position within the rack. Finally, the information concerning the position of each tube within the rack is sent to the LIS. Automate has different output racks each of which has been assigned to a specific analyzer. Analyzers accept particular racks which may differ in size and shape. In addition, there is a dedicated rack which is sent to the fridge for archiving the treated tubes. Automates can be equipped with an aliquoter which creates more tubes out of one through pipetting and sampling the primary tube and making the secondary, tertiary and other necessary aliquoted tubes. Aliquoter has a conveyor with fixed positions where tubes are placed and sampled to make the aliquoted tubes. Moving tubes to and from aliquoter conveyor positions are done by the main robotic arm of the Automate and sampling is performed by a basic arm with strict movement limitation. The number of aliquots per tube and the test assignment to the aliquoted tubes are important decisions which may directly influence laboratory efficiency.

[Figure 6-4](#) presents a graphical view of Automate with its robotic arms and equipped with an aliquoter. Yellow and blue dash lines show the covering space of the robotic arms. The first robotic arm is used to grab tubes from Automate input buffer and put them into Automate conveyor belt. Yellow dash line shows the movement space of this arm. The other robotic arm is used for three kinds of movement presented by red arrows: from the Automate conveyor belt to the Automate output buffer, from the Automate conveyor belt to the aliquoter belt, and from the aliquoter belt to the Automate output buffer. Blue dash line represents the movement space of this arm. Note that the Automate input buffer has more capacity for fifty-position racks than what is illustrated in [Figure 6-4](#).

Full or partially full racks are taken from the Automate output buffer and then, dispatched to their destinations by one or more operators. The time for removing racks from the Automate output buffer is also crucial and may depend on laboratory policy, laboratory real-time status, the number of operators who load the analyzers and their logic.

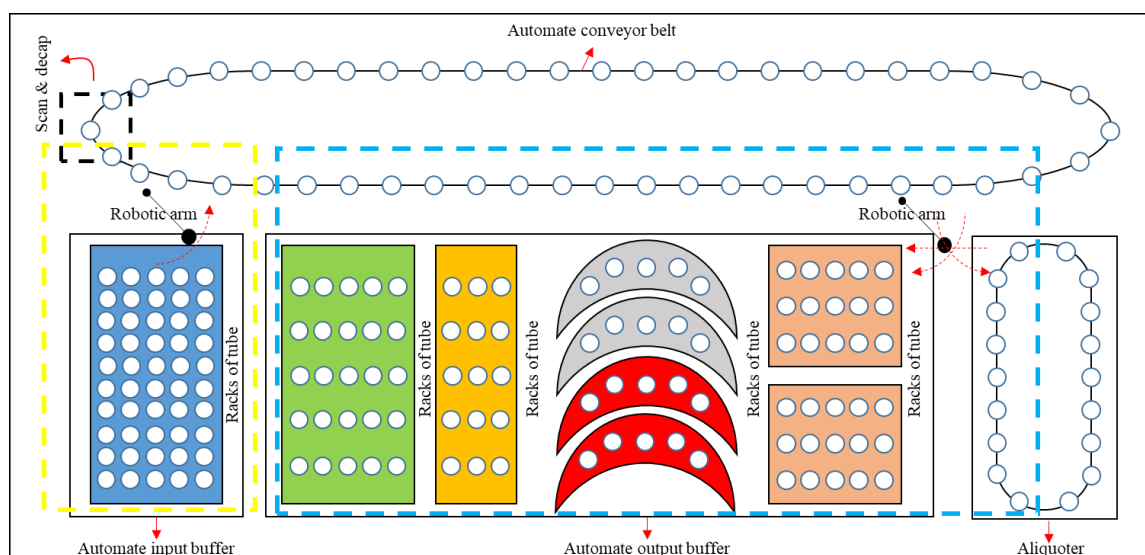

Figure 6-4. Automate components.

Tube racks assigned to each analyzer are placed into the input buffer of the analyzer. The Analyzers' functionalities are different. After analyzing, an operator is in charge of collecting all the tube racks from the analyzers' output buffer, take the tubes one after another and put them all in a fifty-position rack. Then, the fifty-position rack is inserted to the input buffer of the Automate and sorting process is performed again. For each tube, the sorting-analyzing cycle is iterated until all the ordered tests of the tube are analyzed and finally, the tube is placed into the rack reserved for archiving. At last, archiving racks are dispatched to the final storage from time to time.

After analysis, analyzers send the test results to the validation stations for result verification and validation. A portion of the results are validated automatically by a middle-ware and the rest are validated by the laboratory technicians. Then, validated results are released as final reports to the patients and physicians. According to the test results, some tests need to be analyzed again - called 'Rerun' - due to the abnormality seen in the results. Also, some extra tests might ask for a tube called 'add-on' tests.

Figure 6-5¹ represents the general standalone clinical laboratory workflow. In this figure, the loop shown by red arrows demonstrates the sorting-analyzing cycle implying that each tube is moved between the Automate and analyzers until all its tests are analyzed, then the tube is sent to the fridge. In addition, operators shown on the arrows present the need for an operator for rack movement.

¹ Analyzers' 3-D frames dedicated to Beckman Coulter company.

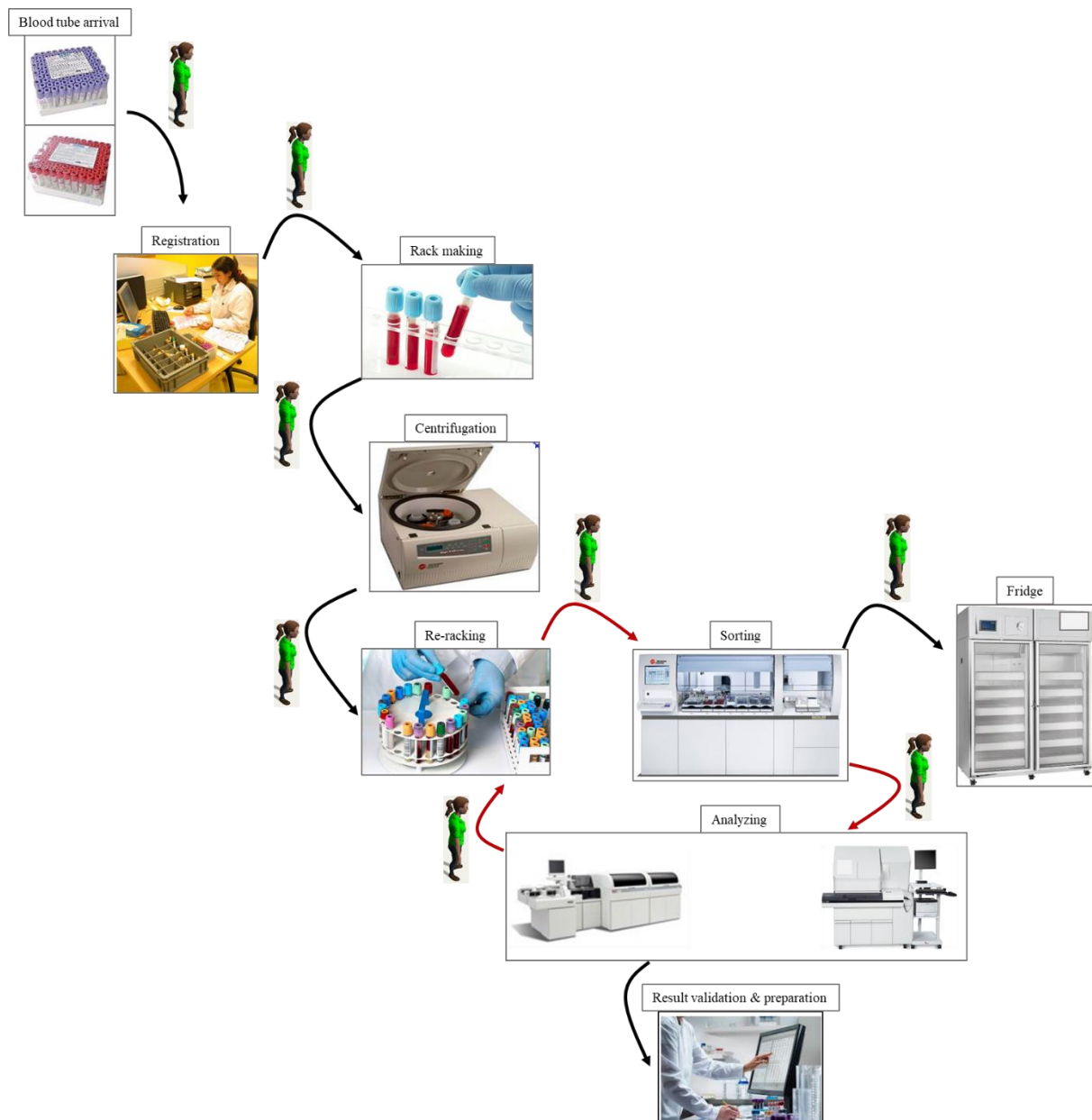

Figure 6-5. General standalone clinical laboratory workflow.

6.3.2. Simulation model inputs and assumptions

In this section, inputs and related assumptions to model a clinical laboratory are described. The clinical laboratory of interest is the one which has been partially designed during the previous chapters. To create a complete clinical laboratory, simple initial solutions are considered for the remaining decision problems such as staff requirement, aliquoting and scheduling problem into account the experts' opinion.

6.3.2.1. Measurement units

In the simulation model, the time unit is the second and the length unit is the meter.

6.3.2.2. System components

Generally, facilities and operators are the main components of a clinical laboratory.

6.3.2.2.1. System components: facilities

Facilities described in Table 6-1 are the instruments constructing the clinical laboratory.

Table 6-1. Clinical laboratory instruments.

<i>Facility</i>	<i>Number</i>
<i>Registration desk</i>	2
<i>Rack-making desk_C</i>	1
<i>Centrifuge</i>	5
<i>Re-racking desk_A</i>	1
<i>Automate</i>	1
<i>AU480</i>	1
<i>AU5822</i>	1
<i>DxI600</i>	1
<i>DxI800</i>	1
<i>Validation station_I</i>	1
<i>Validation station_C</i>	1
<i>Fridge</i>	1

In the following, each of these instruments is described in detail.

- *Registration desk*: Registration desk is a place where arriving tubes are checked and registered to LIS. This desk has a computer which is used by an operator for tube registration. Registration time follows a uniform distribution on the interval [7,12].
- *Rack-making desk for centrifuges*: This desk is used to prepare acceptable racks for centrifuge machines. An operator works on this desk to prepare the racks. The time required for rack making is one second per tube.

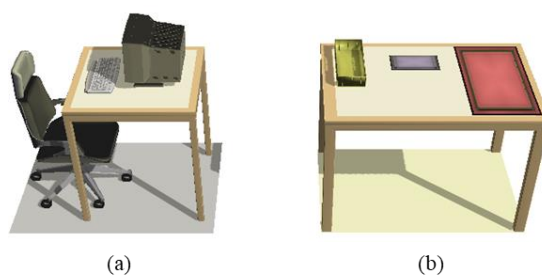

Figure 6-6. Registration desk (a) and Rack-making desk for centrifuges (b).

- *Centrifuge machine*: This machine is used to separate blood into its components. This machine accepts ten-position racks and can room maximum four racks in each run. Once this machine starts processing, no more racks can be added until process completion. The time required for centrifugation is twenty minutes per run. This machine requires an operator to load and unload the racks.
- *Re-racking desk for Automate*: This desk is a place where tubes are re-racked to be placed in a fifty-position rack which is proper for the Automate. An operator works on this desk to prepare the fifty-position racks. The time required for re-racking is one second per tube.
- *Automate with an aliquoter*: This machine is the core instrument in the clinical laboratory which determines the tubes' destination and sorts them into proper racks. In addition, an aliquoter can be added to this machine to aliquot the tubes which require aliquoting. Tubes are transported to the Automate by the staff within fifty-position racks. Then, a robotic arm grabs the tubes one after another and places them in the barcode reading zone. The barcode reader identifies the destination of each tube so that tubes are put in the right racks in the output of the Automate. Once a tube reaches the second robotic arm through traveling on the conveyor belt, the tube can be placed either on the aliquoter part, if the tube requires aliquoting, or in an appropriate rack in the Automate output. The Automate has two different racks in the output: ten-position racks for AU analyzers and archiving in fridge, and four-position racks for DxI analyzers. If a tube enters the aliquoting part, it is aliquoted to the number of required aliquots. Then, the aliquots are placed in the proper racks in the Automate output. Automate input and output buffer capacity is two and fifteen racks, respectively. For each robotic arm, the time between two consecutive snatches is 1.5 seconds. Additionally, the time required to aliquot a tube depends on the number of required aliquots, and for each aliquot is ten seconds.
- *AU480 analyzer*: This analyzer receives only Chemistry tubes in racks with ten positions. [Figure 6-7](#) shows the internal components of AU480 modeled in FlexSim. This analyzer has two analytical units including one ISE module and one Photometric module. The ISE module is able to perform ISE tests which are Sodium, Potassium and Chloride. The Photometric module is able to perform other Chemistry tests with regard to available reagents in the analyzer. Tube racks are positioned into the input buffer of the analyzer by the staff. The input buffer capacity is eight racks. Once a rack reaches the pipetting zone, tubes are sampled one after another by the analyzer pipetting arm. The number of samples taken from each tube rely on the number and type of tests requested by the tube. AU480 shares the pipetting arm between ISE analyzing unit and module used for Photometric tests to needle and sample the tubes. The inter-sampling time is nine seconds. In other words, samples become available on wheels of analyzing units each nine seconds. To do all the requested ISE tests on a tube, only one sample is required on which all ISE tests are performed concurrently. The ISE analyzing unit has a capacity of only one sample at the time so

that samples wait in the wheel until the ISE analyzing unit is freed. ISE tests take 13.33 seconds. For each Photometric

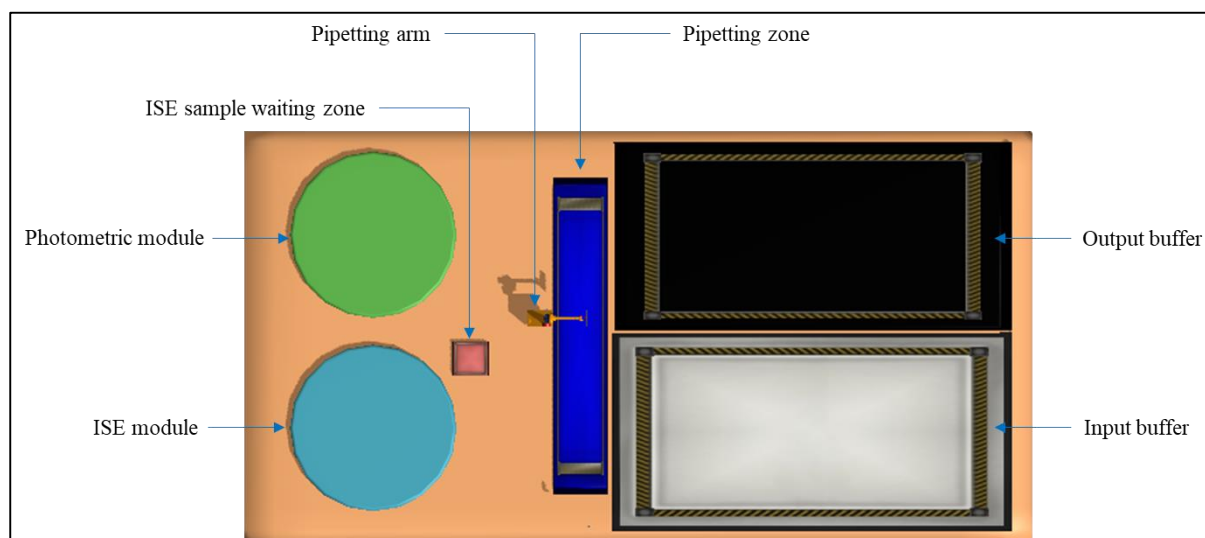

Figure 6-7. Components of AU480 analyzer modeled in FlexSim.

test requested by a tube, a sample is needed. All Photometric tests take same time to be completely analyzed which is 501.6 seconds. The Photometric module is always ready to receive a new sample so there is no waiting time for samples needed for Photometric tests. After sampling all tubes of a rack, the rack is conveyed from the sampling zone and wait on the output buffer until someone takes it.

- *AU5822 analyzer*: This analyzer receives only Chemistry tubes in racks with ten positions. [Figure 6-8](#) shows the internal components of AU5822 modeled in FlexSim. This analyzer has three analytical units including one ISE module and two Photometric modules. The test capability of Photometric modules is not necessarily the same.

Tube racks are loaded to the analyzer input buffer by laboratory operators. The input buffer capacity is forty racks. Racks waiting in the input buffer are conveyed one after another on the conveyor belt passing from all three analyzing units. A rack will stop before an analytical unit while tubes of the rack request the tests available on that unit. The first analyzing unit is the ISE module. This module has one pipetting arm which pipets the tubes one-by-one with a 0.9 seconds time interval. The pipetted testing samples will then wait in the ISE wheel before they get processed by the ISE module. The ISE module can analyze maximum two samples at a time. A waiting sample will start to be analyzed as soon as analyzing one sample is finished. ISE tests take 12 seconds for each sample. Once all required testing samples were extracted and placed on the ISE wheel, the rack moves to the front of the first Photometric module. In other words, once the last sample needed is taken and placed on the ISE wheel, the rack moves toward the first Photometric module. Each Photometric module has two Pipetting arms which provide the ability of getting two samples from a tube at the same time.

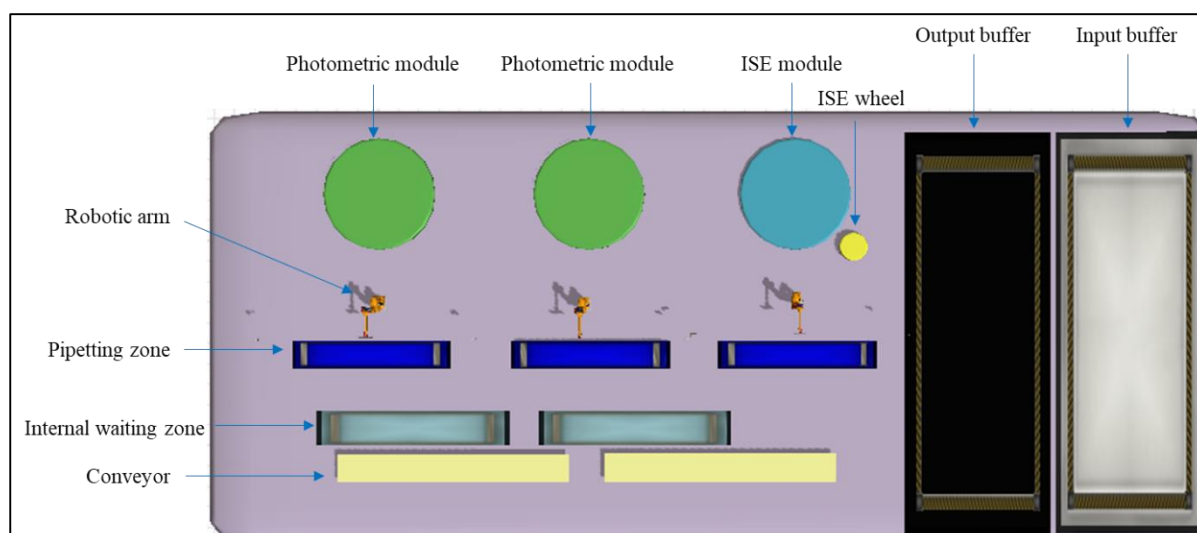

Figure 6-8. Components of AU5822 analyzer modeled in FlexSim.

Tubes of the rack are sampled one by one. The number of samples taken from each tube by each Photometric module equals to the number of tests requested by a tube that can be analyzed by the module. Time between each needling is 0.9 seconds for each pipetting arm. If a rack is getting needled in front of the module, the rear coming rack will wait in the waiting zone and the ISE module will receive another rack. Once the needling is finished for a module, the rack moves toward the next module. The second module functions similar to the first one. After passing all the analyzing modules, the rack waits in the output buffer to be treated by an operator. Note that all Photometric tests take 501.6 seconds independent of the test type and analyzing module.

- DxI600 analyzer:* This analyzer receives only Immunology tubes in racks with four positions. [Figure 6-9](#) shows the internal components of the DxI600 modeled in FlexSim. Tube racks are positioned into the input buffer of the analyzer by the staff. The input buffer capacity is twenty-five racks. Racks enter the analyzer one after another just after leaving the previous rack. Once a rack enters the analyzer, a pipetting arm starts getting a sample volume from each tube and put them into a waiting wheel with no limitative capacity. Generally, in Immunology analyzers, each tube is only sampled once to taking the sample volume. Once the last sample volume is pipetted, the rack is released and the next rack is replaced. Each pipetting takes nine seconds in this phase. Then, a mechanical transporter grabs the sample volumes one-by-one from the wheel and put them into the containers. DxI600 has two containers, each of which has a capacity of one sample volume. This movement time is negligible. Then, another arm needles the sample volumes waiting in the containers in a round robin manner to take the testing samples and put them into the analyzing units. By each needling, one testing sample is taken by the arm. The inter-sampling time is eighteen seconds. Once all the required testing samples are taken from a sample volume, the sample volume will be replaced with another one waiting in the wheel. Testing samples are analyzed by the analyzing units.

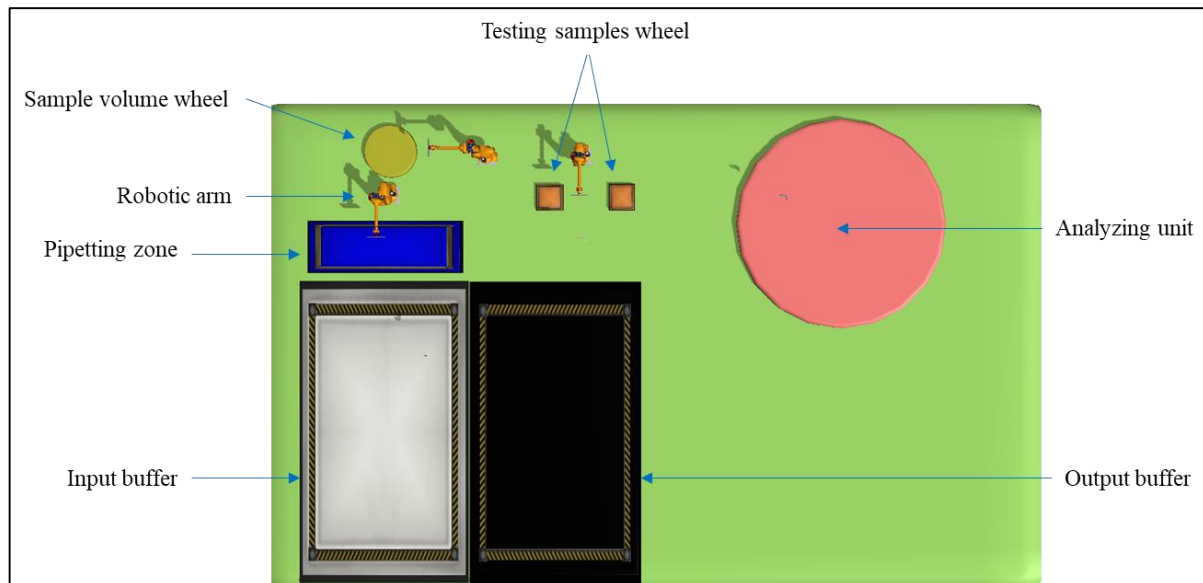

Figure 6-9. Components of DxI600 analyzer modeled in FlexSim.

Generally, Immunology tests have three types. The processing time of each test depends on the test type. There is no limitative capacity for analyzing unit in Immunology analyzers.

- *DxI800 analyzer:* This analyzer functions similar to DxI600; however, there are some differences between these two analyzers. This analyzer has four containers, and the inter-sampling time is nine seconds for each robotic arm of this analyzer.

It is worth noting that the test capability of each analyzer is the one determined through the analyzer configuration model in chapter four.

- *Validation station:* This workstation is equipped by a computer on which the test results are checked and validated. In better words, analyzers transmit the test results to the validation console to be verified. In the validation console, some tests are validated automatically, the remaining tests need a specialist technician for tests result verification and validation. The validation time for automatic validation is negligible; however, for other tests requiring a specialist for validation, the validation time follows a normal distribution with two mean ($\mu = 2$) and unit variance ($\sigma^2 = 1$).

6.3.2.2.2. System components: operators

Operators play an important role in a clinical laboratory performance. Generally, operators are in charge of the following tasks in a standalone clinical laboratory:

- Tube registration in reception
- Rack making for centrifugation
- Rack transportation to centrifuge(s)
- Load/unload centrifuge(s)

- Rack transportation from centrifuge(s) to re-racking zone where fifty-position racks for the Automate are prepared
- Rack making for the Automate (fifty-position racks)
- Rack transportation from the re-racking zone to the Automate
- Load/unload Automate
- Rack transportation from Automate to the analyzers
- Load/unload analyzers
- Rack transportation from analyzers output buffer to re-racking zones to prepare fifty-position racks for Automate
- Rack transportation from Automate to fridge (final storage)
- Test result validation in validation stations

Assigning operators to these tasks depends on the way the tasks are classified. Then, one or more operators can be assigned to each class of tasks. In addition, number of operators for each class of tasks depends mainly on the arriving load. So, many task classifications can be considered. [Table 6-2](#) presents an initial solution for the staff requirement problem considering expert's opinion, where the number and duties of the operators are specified. According to this Table, seven operators are needed for different operations in the laboratory.

Table 6-2. The number and duties of operators in the clinical laboratory.

<i>Operator duty</i>	<i>Number</i>
<i>Tube registration at registration desks</i>	2
<i>Rack making for centrifugation</i>	
<i>Rack transportation to centrifuges</i>	
<i>Load/unload centrifuges</i>	1
<i>Rack transportation from centrifuges to re-racking zone</i>	
<i>Rack making for Automate (50-position racks)</i>	
<i>Rack transportation from re-racking zone to Automate</i>	1
<i>unload Automate</i>	
<i>Rack transportation from Automate to different analyzers</i>	
<i>Load/unload analyzers</i>	1
<i>Rack transportation from analyzers output buffer to re-racking zone</i>	
<i>Rack transportation from Automate to fridge (final storage)</i>	
<i>Test result validation in validation stations</i>	2

6.3.2.3. System entities

In computer simulation, entities are items passing through the objects in the system. In addition, these items can carry data known as attributes (Law and Kelton, 1991). In clinical laboratories, the following entities exist:

- *Sample tubes*: Tubes are the main entities of a clinical laboratory. They carry a patient's sample for analysis. These entities are moved between several objects until reaching the fridge. Normally, tubes are transported in the form of rack. It is assumed that all tubes are available in the laboratory at the beginning of working day. Tubes enter randomly to the laboratory. Each tube is associated with a due date. Over simulation run, several attributes are labelled on each tube such as tube registration time, tube centrifugation time, tube destination, etc.
- *Rack of tubes*: Normally, tubes are transported within the racks. Also, tubes are processed by machines within the racks. Four types of rack exist in the clinical laboratory: (i) ten-position racks acceptable for centrifuges; (ii) fifty-position racks acceptable for Automate; (iii) four-position racks acceptable for DxI analyzers; and (iv) ten-position racks acceptable for AU analyzers and archiving in the fridge. It is assumed that racks are always available in necessary points. Over simulation run, several attributes are labelled on each rack such as rack arrival time to a specific point in the system.
- *Testing samples*: These entities are only seen in the analyzers. Each analyzer requires testing samples to perform the tests. These samples are taken from the tubes. Testing samples might pass different steps in the analyzers to be analyzed. As internal components and behaviour of analyzers are simulated in this study, the flow of testing samples within the analyzers are taken into account. Over simulation run, several attributes are labelled on each testing sample such as test name, test ID, test type, test pipetting time, test starting time and test completion time.
- *Information*: After analyzing each test, analyzers transmit the test result to the validation stations. Hence, information is another entity in the clinical laboratory which is only transmitted between analyzers and validation stations. These entities are then treated either automatically or by specialist technicians in validation stations. Over simulation run, several attributes are labelled on these entities known as test results such as test validation time.

Figure 6-10 presents the tube and different racks used in the simulation model.

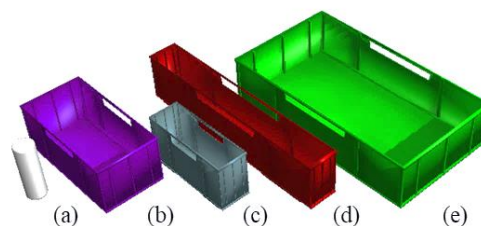

Figure 6-10. Types of flow items used in clinical laboratory simulation modeling.

{(a) Tube. (b) Centrifuge rack. (c) 4-position rack. (d) 10-position rack. (e) 50-position rack. }

6.3.2.4. System layout

The physical arrangement of facilities within the laboratory area is the one designed in chapter three through the proposed heuristic algorithm in combination with expert opinion (See chapter three, [Figure 3-13](#)).

6.3.2.5. Assignment, aliquoting and scheduling in the clinical laboratory

Concerning the assignment problem, the assignment of tubes to the analyzers and tests of tubes to the analyzers are the ones proposed through the mathematical model solved in chapter five. These assignments are described via two input Tables in simulation model. Once a tube is scanned in the barcode reader of the Automate, the destination of the tube is determined from assignment input Tables. In addition, for each tube, tests done on each analyzer are specified through the assignment input Tables. Furthermore, the assignment of tubes to the other machines and workstations (except analyzers) is done based on first available or round-robin dispatching rules for workload levelling.

Concerning the aliquoting problem, tubes are not aliquoted so no aliquoting is performed in the clinical laboratory.

Concerning the scheduling problem, in each waiting queue, the first-come-first-served (FCFS) policy is applied to specify the order of waiting entities for the next process. It is worth noting that the precedence constraint for Immunology-Chemistry tubes is respected implying that these tubes must be firstly dispatched to Immunology analyzers and then to Chemistry ones.

6.3.2.6. Other assumptions

- Machines and operators are always available. In better words, no breakdown is occurred.
- As tubes are all Immunology and Chemistry, they all require to be centrifuged.
- No 'Rerun' and 'Reflex' test is requested.
- In rack-making desk and re-racking desk, racks are filled to their maximum capacity unless no more coming tube exists in the upstream workstations.
- It is aimed at using centrifuges in their maximum capacity, unless no more tube rack exists in the rack-making desk for centrifuges.
- It is aimed at taking only the full racks from Automate output buffer, unless no more tube exists in the Automate input buffer, its conveyor and aliquoter.
- The operator who is in charge of loading/unloading Automate and analyzers proceeds to take the racks once a ready rack appears in the output buffers.
- All tubes have the same priority.

6.3.3. Key performance indicators (KPIs)

In order to evaluate the clinical laboratory performance, the following criteria are of interest known as key performance indicators (KPIs):

- Laboratory throughput: This criterion is expressed through the two following measures:
 - ✓ The average number of tubes treated per hour.
 - ✓ The average number of tests analyzed per hour.
- The average time in system (TIS) for tubes: Generally, the time between tube registration and tube arrival to the fridge is considered as the tube time in system.
- The average or maximum waiting time of tubes and racks of tube in any waiting queue of interest: For instance, average waiting time of tubes for registration and average waiting time of racks for centrifugation are placed in this category of performance measures.
- Test tardiness: This measure denotes the amount of test deadline violation and it is calculated as follows:

$$\text{Test tardiness} = \text{completion time of test validation} - \text{test deadline}$$

- The number (or percentage) of tardy tubes (tests): This measure can be considered for total number of tubes (tests) or for tubes (tests) of each discipline separately
- Tube/Test turnaround time (TAT): Turnaround time is defined as the period between the time a specimen is received at the laboratory and the time a result is released. This measure can be defined for each tube or each test of a tube.
- Resource utilisation: This measure presents the busy period of a resource over its available working time. This measure can be computed for machines and operators in the laboratory.
- Resource throughput: Regarding the resource type, this measure can be expressed as the average number of tubes/racks/tests treated per hour.

6.3.4. Simulation model in FlexSim

In order to build the simulation model of the clinical laboratory of interest, the customized simulation environment developed specifically for clinical laboratory simulation modeling is utilized. As discussed previously, in this environment, all necessary instruments have been already modeled, verified and validated. In addition, all input and output Tables have been already embedded. To build a simulation model using the developed customized environment the following steps have to be taken:

Step 1: Constructing the laboratory area is the first step. To do so, a laboratory plan is used to design the laboratory floor in which walls and pillars are well-located.

Step 2: Selecting the facilities from the customized library and locating them in the laboratory area regarding the layout design output forms the second step. To do so, instruments can be simply dragged from the library and dropped in a specific position. In addition, the exact position and orientation of

each facility is changeable through the facility properties window. Furthermore, operators are added to the model in this step.

Step 3: Making connections between selected objects is the third step. Generally, connections are made for two purposes. The first purpose is to handle material flow through the system. Thus, origin and destination of flows are specified through connections between facilities. The second purpose is to determine the place where operators have to be settled to do their duties. Therefore, certain connections are needed between operators and facilities.

Step 4: Importing input Tables which include all required input data to run the model such as test processing time, assignment of tubes to the analyzers, and assignment of tube tests to the analyzers.

Step 5: Reset, save and run the model.

Figure 6-11 schematically shows the general steps to create a simulation model of a clinical laboratory in the customized environment developed in FlexSim.

It is worth mentioning that a button has been embedded in the customized simulation environment by which an Excel file is imported to automatically conduct the first four aforementioned steps. So, the only thing that needs to be done to create the simulation model is to fill out the Excel input file.

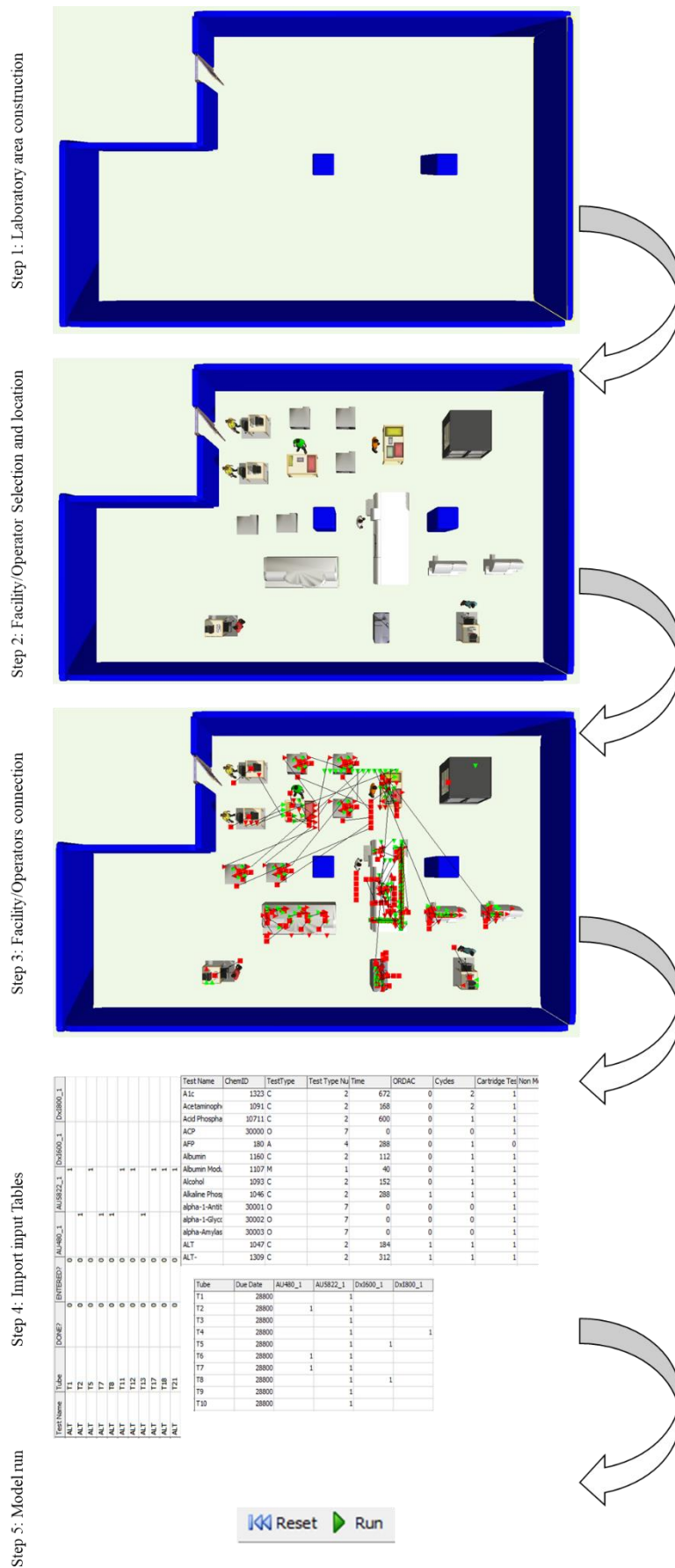

Figure 6-11. Schematic view of general steps to create clinical laboratory simulation model in FlexSim.

Following these steps, a simulation model of the designed laboratory is created. [Figure 6-12](#) shows the scheme of this model in FlexSim. In this figure, strings between the objects present objects' connections, the green and the red triangles show the objects' input and output ports respectively, and the red squares represent objects' central ports. For more information about simulation modeling in FlexSim and concepts of different ports, refer to FlexSim user manual.

Since this model is not a model of an existing system, expert opinion is taken into account for model validation and credibility.

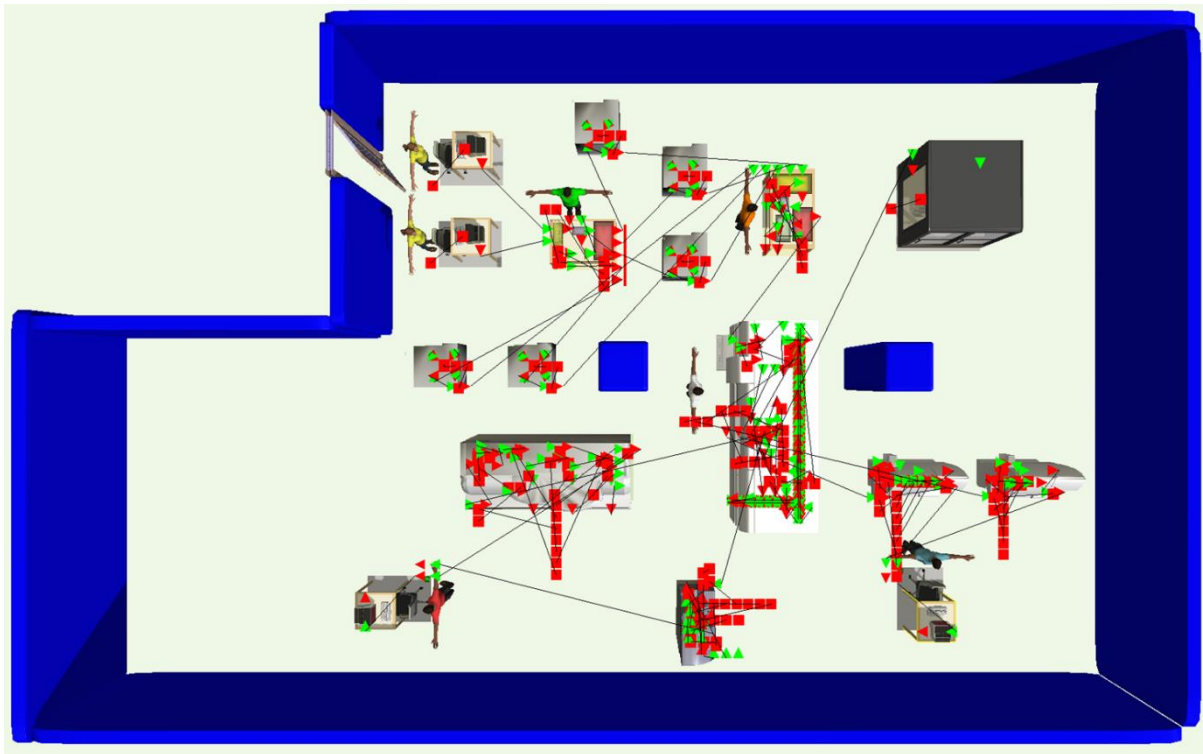

Figure 6-12. Simulation model of the designed clinical laboratory in FlexSim.

6.4. Simulation output results

The developed simulation model is used to analyze the designed clinical laboratory and to evaluate its performance measures. The simulation model is run until analysis completion of all the ordered tests in the laboratory. It's been assumed that the Laboratory starts working at eight o'clock in the morning. [Figure 6-13](#) presents snapshots of different sections and operations of the clinical laboratory taken from the simulation run. A brief description for each shot has been provided below of that shot. Generally, two kinds of result are achieved from simulation model: qualitative and quantitative.

Qualitative results are obtained from direct observation of material flow through the system as well as analyzers, workstations and operators state and status. Observation of a simulation model aids at better understanding the system and helps to discover eventual system bottlenecks.

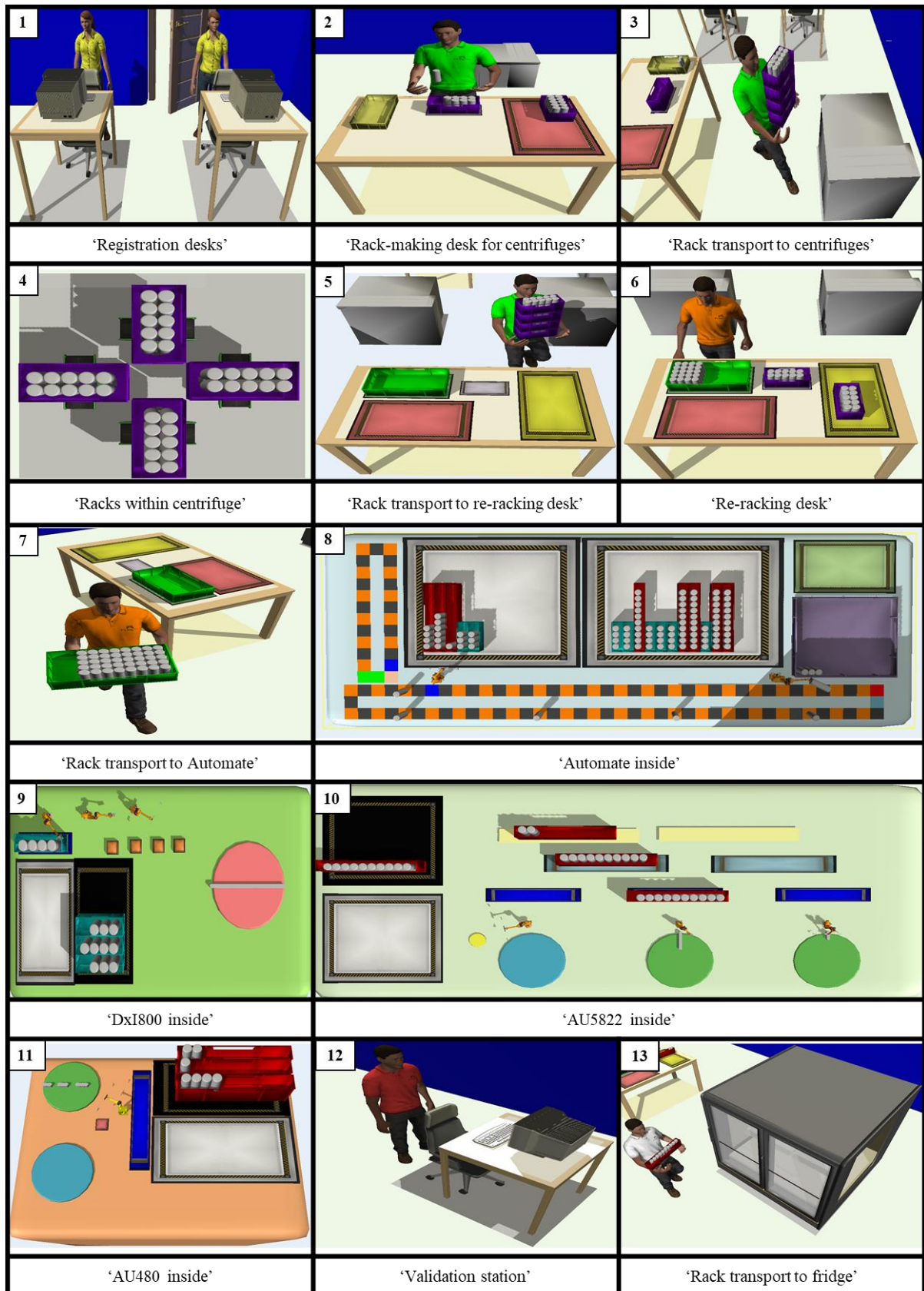

Figure 6-13. Snapshots of different sections and operations of the running simulation model in FlexSim.

The effect of an efficient assignment is clearly observable through the system as analyzers receive proportionally even workload (tubes and tests) which minimizes tubes waiting time in the analyzers and also accelerates tests analysis. Consequently, all tubes are treated less than eight hours and except some Immunology tests, all tests are analyzed and validated before four o'clock in the afternoon. Over simulation run, the accumulation of racks is mainly observed in the output of rack making desk from which racks are sent to the centrifuges. Among the analyzers, the most accumulated racks are seen in the input buffer of AU480. Concerning the operators, the white-shirt operator who is in charge of rack transportation from Automate to the analyzers and storage is seen as the busiest operator. Operators working at initial stages of the laboratory process (registration and rack-making for centrifuges) tolerate massive workload at the beginning of the day, but over time, their workload is decreased until it becomes zero. Inversely, the workload of specialist technicians working at validation workstations increases over time. Central operators with orange and white shirts are the ones who are busy almost all day long.

Beside qualitative results, simulation quantitative results are more of interest. Quantitative results are obtained through data collection from model's objects and entities over a simulation run. These data help to numerically evaluate system KPIs and statistically analyze the system. [Table 6-3](#) presents a portion of raw data collected over a simulation run. This Table contains useful information about tubes and tests of tubes. In this Table, reference, arrival time, due date, registration time, centrifugation time, entry time to Automate, and entry time to analyzer is registered for each tube. In addition, name, ID, type, pipetting time, starting time, completion time, validation time, TAT considering test completion time, TAT considering test validation time, and test lateness are captured for each test of a tube. In order to compute and evaluate the main system KPIs, post-processing is required on the collected raw data. For instance, to compute the number of tardy tests, tests with negative lateness (Tardy tests) have to be counted after the simulation run. A tube is considered as tardy only if at least one of its requested tests violates its deadline.

CI	C2	C3	C4	C5	C6	C7	C8	C9	C10	C11	C12	C13	C14	C15	C16	C17	C18
1	0	28800	10.27	1403.51	1450.79	1588.05	AU5822	AST	1049	Photometric	1619.57	1620.92	2122.52	2122.52	2122.52	2122.52	26677.48
1	0	28800	10.27	1403.51	1450.79	1588.05	AU5822	IndicesHEMOLICTERLIPEM	1057	Photometric	1603.59	1604.94	2106.54	2108.09	2106.54	2108.09	26691.91
1	0	28800	10.27	1403.51	1450.79	1588.05	AU5822	T-Bilirubin	1051	Photometric	1602.79	1602.69	2104.29	2104.29	2104.29	2105.29	26694.71
1	0	28800	10.27	1403.51	1450.79	1588.05	AU5822	ALT	1047	Photometric	1601.24	1603.14	2104.74	2104.74	2104.74	2104.74	26695.26
2	0	28800	7.89	1403.51	1450.79	1588.05	AU5822	GGT	1064	Photometric	1623.17	1624.52	2126.12	2127.67	2126.12	2127.67	26672.33
2	0	28800	7.89	1403.51	1450.79	1588.05	AU5822	Triglyceride	1061	Photometric	1623.62	1624.07	2125.67	2125.67	2125.67	2126.67	26673.33
2	0	28800	7.89	1403.51	1450.79	1588.05	AU5822	UricAcid	1071	Photometric	1621.37	1622.72	2124.32	2124.32	2124.32	2124.32	26675.68
2	0	28800	7.89	1403.51	1450.79	1588.05	AU5822	Creatinine	1063	Photometric	1621.82	1622.27	2123.87	2123.87	2123.87	2123.87	26676.13
2	0	28800	7.89	1403.51	1450.79	1588.05	AU5822	AST	1049	Photometric	1620.02	1620.47	2122.07	2122.07	2122.07	2122.07	26677.93
2	0	28800	7.89	1403.51	1450.79	1588.05	AU5822	IndicesHEMOLICTERLIPEM	1057	Photometric	1607.64	1608.09	2109.69	2110.69	2109.69	2110.69	26689.31
2	0	28800	7.89	1403.51	1450.79	1588.05	AU5822	HDLC	8093	Photometric	1607.19	1608.54	2110.14	2110.14	2110.14	2110.14	26689.86
2	0	28800	7.89	1403.51	1450.79	1588.05	AU5822	Cholesterol	1054	Photometric	1605.39	1606.74	2108.34	2108.34	2108.34	2108.34	26691.66
2	0	28800	7.89	1403.51	1450.79	1588.05	AU5822	GlucoseModular	1102	Photometric	1605.84	1606.29	2107.89	2107.89	2107.89	2107.89	26692.11
2	0	28800	7.89	1403.51	1450.79	1588.05	AU5822	ALT	1047	Photometric	1604.04	1604.49	2106.09	2106.09	2106.09	2107.09	26692.91
2	0	28800	7.89	1403.51	1450.79	1588.05	AU5822	Potassium	1084	ISE	1589.41	1589.86	1601.86	1602.86	1601.86	1602.86	27197.14
2	0	28800	7.89	1403.51	1450.79	1588.05	AU5822	Sodium	1085	ISE	Ref_Same_Tube_ISE	Ref_Same_Tube_ISE	1590.06	1590.06	1590.06	1590.06	27209.94
3	0	28800	400.7	1604.01	1659.13	1814.19	AU5822	IndicesHEMOLICTERLIPEM	1057	Photometric	1827.03	1828.38	2329.98	2329.98	2329.98	2329.98	26470.02
3	0	28800	400.7	1604.01	1659.13	1814.19	AU5822	GlucoseModular	1102	Photometric	1825.68	1826.13	2327.73	2327.73	2327.73	2327.73	26471.27
3	0	28800	400.7	1604.01	1659.13	1814.19	AU5822	Cholesterol	1054	Photometric	1825.23	1826.58	2328.18	2328.18	2328.18	2328.18	26471.82
3	0	28800	400.7	1604.01	1659.13	1814.19	AU5822	Potassium	1084	ISE	1816.45	1827.1	1839.1	1839.1	1839.1	1839.1	26960.9
3	0	28800	400.7	1604.01	1659.13	1814.19	AU5822	Sodium	1085	ISE	Ref_Same_Tube_ISE	Ref_Same_Tube_ISE	1816.2	1816.2	1816.2	1816.2	26983.8
4	0	28800	125.10	1635.178	16581.58	16844.96	AU5822	GGT	1064	Photometric	16879.63	16880.98	17382.58	17382.58	17382.58	17382.58	11417.42
4	0	28800	125.10	1635.178	16581.58	16844.96	AU5822	AST	1049	Photometric	16877.83	16879.18	17380.78	17380.78	17380.78	17381.78	11418.22
4	0	28800	125.10	1635.178	16581.58	16844.96	AU5822	Creatinine	1063	Photometric	16878.28	16878.73	17380.33	17380.33	17380.33	17380.33	11419.67
4	0	28800	125.10	1635.178	16581.58	16844.96	AU5822	UREA	1321	Photometric	16854.2	16855.55	17357.15	17357.15	17360.55	17360.55	11439.45
4	0	28800	125.10	1635.178	16581.58	16844.96	AU5822	Calcium	1104	Photometric	16852.4	16853.75	17355.35	17355.35	17357.55	17357.55	11442.45
4	0	28800	125.10	1635.178	16581.58	16844.96	AU5822	IndicesHEMOLICTERLIPEM	1057	Photometric	16852.85	16853.3	17354.9	17354.9	17356.55	17356.55	11443.45
4	0	28800	125.10	1635.178	16581.58	16844.96	AU5822	ALT	1047	Photometric	16850.6	16851.95	17353.55	17353.55	17354.55	17354.55	11444.45
4	0	28800	125.10	1635.178	16581.58	16844.96	AU5822	T-Bilirubin	1051	Photometric	16851.05	16851.5	17353.1	17353.1	17353.1	17353.1	11446.9
4	0	28800	125.10	1635.178	16581.58	16844.96	AU5822	Potassium	1084	ISE	16845.42	16845.87	16857.87	16857.87	16858.87	16858.87	11941.13
4	0	28800	125.10	1635.178	16581.58	16844.96	AU5822	Sodium	1085	ISE	Ref_Same_Tube_ISE	Ref_Same_Tube_ISE	16844.97	16844.97	16844.97	16844.97	11955.03
5	0	28800	1410	3017.17	3401.58	3809.38	AU480	IndicesHEMOLICTERLIPEM	1057	Photometric	4129.99	4134.49	4636.09	4636.09	4636.09	4636.09	24163.91
5	0	28800	1410	3017.17	3401.58	3809.38	AU480	GlucoseModular	1102	Photometric	4120.99	4125.49	4627.09	4627.09	4627.09	4627.09	24172.91
5	0	28800	1410	3017.17	3401.58	3809.38	AU480	Creatinine	1063	Photometric	4111.99	4116.49	4618.09	4618.09	4618.09	4618.09	24181.91
5	0	28800	1410	3017.17	3401.58	3809.38	AU480	AST	1049	Photometric	4102.99	4107.49	4609.09	4609.09	4613.88	4609.09	24186.12
5	0	28800	1410	3017.17	3401.58	3809.38	AU480	ALT	1047	Photometric	4093.99	4098.49	4600.09	4600.09	4600.09	4600.09	24199.91
5	0	28800	1410	3017.17	3401.58	3809.38	AU480	Potassium	1084	ISE	4084.99	4089.49	4102.82	4102.82	4102.82	4102.82	24697.18
5	0	28800	1410	3017.17	3401.58	3809.38	AU480	Sodium	1085	ISE	Ref_Same_Tube_ISE	Ref_Same_Tube_ISE	3817.49	3817.49	3817.49	3817.49	24982.51
5	0	28800	1410	3017.17	3076.22	3258.77	AU5822	Triglyceride	1061	Photometric	3303.34	3303.79	3805.39	3805.39	3805.39	3805.39	24994.61
5	0	28800	1410	3017.17	3076.22	3258.77	AU5822	UricAcid	1071	Photometric	3301.99	3302.44	3805.04	3805.04	3805.04	3805.04	24994.96
5	0	28800	1410	3017.17	3076.22	3258.77	AU5822	HDLC	8093	Photometric	3283.76	3284.21	3785.81	3785.81	3787.01	3787.01	25012.99
5	0	28800	1410	3017.17	3076.22	3258.77	AU5822	Cholesterol	1054	Photometric	3283.31	3284.66	3786.26	3786.26	3786.26	3786.26	25013.74

Table 6-3. A portion of raw data extracted from a simulation run.

C1: Tube reference, C2: Tube arrival time, C3: Tube due date, C4: Tube registration time, C5: Tube centrifugation time, C6: Tube entry time_Automate, C7: Tube entry time_Analyzer, C8: Analyzer namedsds
 C9: Test name, C10: Test ID, C11: Test type, C12: Test pipetting time, C13: Test starting time, C14: Test completion time, C15: Test validation time, C16: Test TAT_A, C17: Test TAT_V, C18: Test lateness

Table 6-4 demonstrates a portion of the simulation's main KPIs obtained through raw data processing. According to this Table, the designed clinical laboratory is able to averagely analyze 3,052 tests and 534 tubes per hour. The tube turnaround time is recorded once the latest test of the tube is analyzed and validated, and the results are ready. The average of TAT for tubes in the clinical laboratory has been reported as 6502.09 seconds considering tube registration time as the beginning of TAT calculation. This value implies that each tube is entirely analyzed in the laboratory less than 2 hours on average. Minimum and maximum Tube TAT have been also reported as 1914.75 and 15003.77 seconds, respectively. Figure 6-14 presents TAT of all tubes in the laboratory. In addition, tube time in system (TIS) is a measure denoting the period of time that a tube flows within the laboratory until it reaches the fridge. The average tube TIS has been reported as 4487.58 seconds which presents acceptable capability of the laboratory in tube handling.

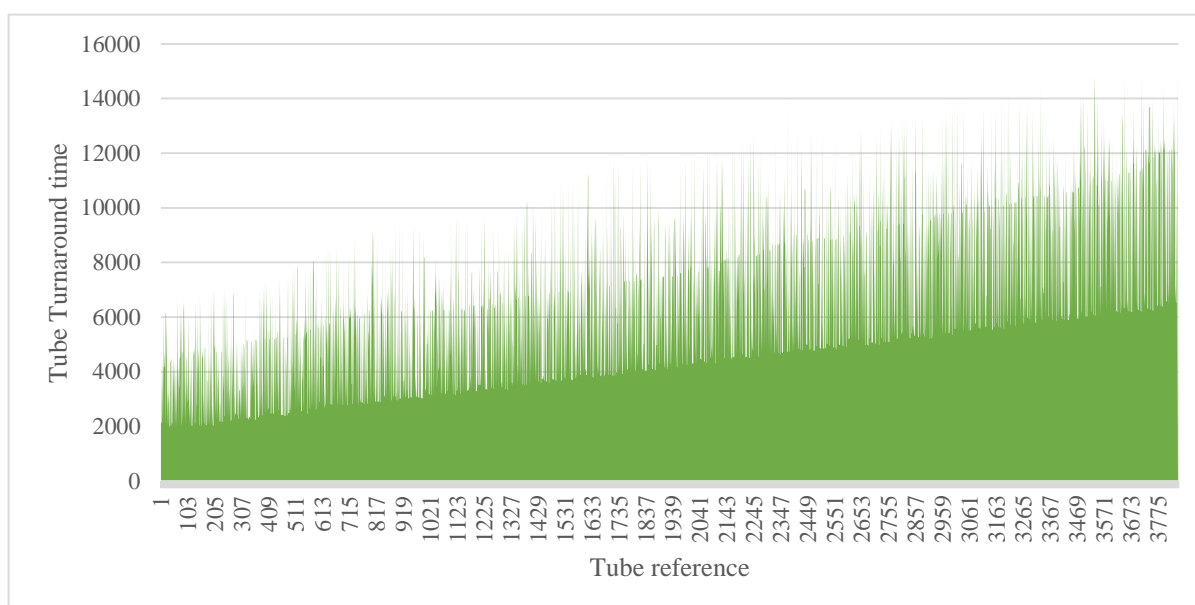

Figure 6-14. TAT of all tubes in the clinical laboratory.

Concerning laboratory capability in deadline satisfaction, the simulation report indicates that deadlines are violated for 1.59% tests and 5.25% tubes. Scrutinizing tardy tests shows that all deadlines violation pertains to Immunology tests which implies an eventual weakness in laboratory Immunology analyzers. Nevertheless, more investigation is required to find a reasonable solution to comply deadlines. For instance, an efficient dispatching rule might resolve this problem.

Table 6-4. A portion of the main clinical laboratory KPIs.

	<i>Value</i>
<i>Laboratory throughput</i>	
The average number of tests analyzed per hour	3052.65
The average number of tubes treated per hour	534.39

Test TAT from tube arrival to test validation

Average TAT	14743.64 sec
Maximum TAT	33765.77 sec
Minimum TAT	1589.06 sec

Test TAT from tube registration to test validation

Average TAT	5068.04 sec
Maximum TAT	15038.77 sec
Minimum TAT	1396.72 sec

Tube TAT from tube arrival to test validation

Average TAT	16124.59 sec
Maximum TAT	33765.77 sec
Minimum TAT	2103.49 sec

Tube TAT from tube registration to test validation

Average TAT	6502.09 sec
Maximum TAT	15003.77 sec
Minimum TAT	1914.75 sec

Tube TIS from tube registration to tube load at fridge

Average TIS	4487.58 sec
Maximum TIS	7766.63 sec
Minimum TIS	1547.12 sec

Tardy tests

Total number of tardy tests	456
Percentage of tardy tests	1.59%
Number of tardy Immunology tests	456
Number of tardy Chemistry tests	0

Tardy tubes

Total number of tardy tubes	202
Percentage of tardy tubes	5.25%
Number of tardy Immunology tubes	37
Number of tardy Chemistry tubes	0
Number of tardy Immunology-Chemistry tubes	165

Test tardiness

Average tardiness	1508.08 sec
Maximum tardiness	4965.77 sec
Minimum tardiness	5.88 sec

In addition to the overall report on laboratory performance shown in the above Table, some other information is also extracted over the simulation run to investigate and analyze system’s components more profoundly.

Figure 6-15 presents the utilization of analyzers used in the laboratory. A bar chart is used to describe the state of AU480 and AU5822 analyzing units. Also, state of DxIs analyzing units are shown by pie chart. Regarding this figure, the utilization of same discipline analyzers seals on the balanced assignment of tests to the analyzers. It is obvious that the Immunology analyzers (DxI600 and DxI800) with about 95% utilization are almost busy all day long while, the Chemistry analyzers have still certain capacity to analyze some tests.

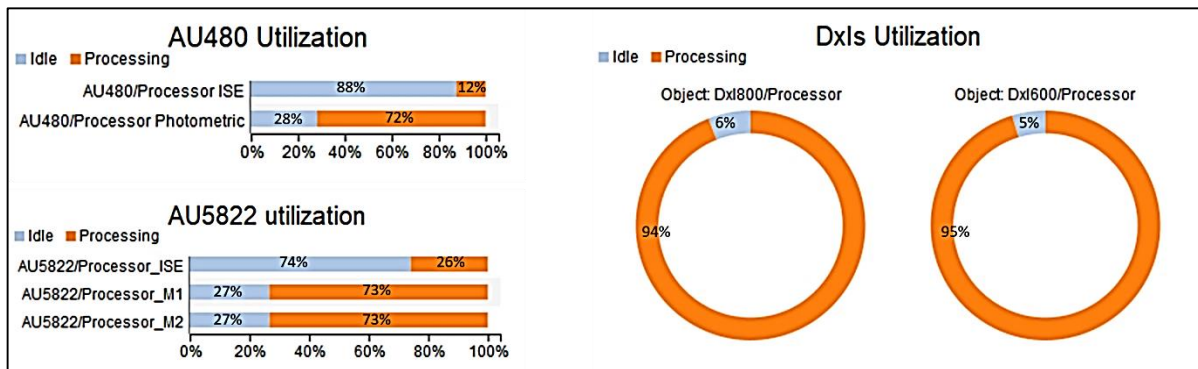

Figure 6-15. Utilization of analyzers in the laboratory.

Figure 6-16 illustrates the state of operators over the simulation run. According to this figure, registration operators (Operator_R1 and Operator_R1) have the same utilization as workload is evenly distributed between them. Rack making operator (Operator_RMC) dedicates 11% of his time to rack preparation for centrifuges and spends 5.7% of his time on rack transportation. The operator working on the re-racking desk (Operator_RRA) is idle in 62% of the working day. The most active operator is the one who works on Automate (Operator_AA) with 68% utilization. Among two specialist technicians working in validation stations for test result verification and validation, the one who works in the Chemistry section (Operator_VC) is busier than the Immunology tests specialist (Operator_VI).

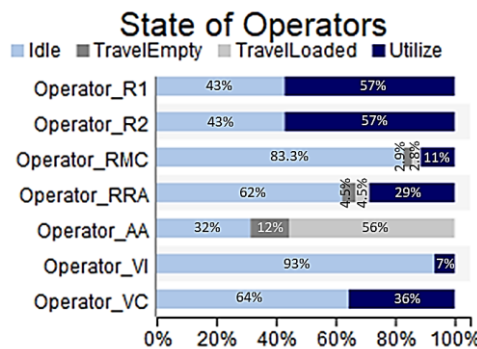

Figure 6-16. Utilization of operators in the laboratory.

Generally, the results of operator utilization show that the initial operator assignment is not efficient enough for this laboratory as operators are idle most of the time. Therefore, a comprehensive study seems to be necessary to tackle the staff requirement problem for the clinical laboratory.

Figure 6-17 provides useful information about waiting time of objects at different queues in the laboratory. For instance, average racks waiting time for centrifugation is 2032.06 seconds. In addition, the average waiting time of tubes in Automate input buffer is 142.10 seconds. Generally, the waiting times of flow items in system's queues are helpful indicators to identify the eventual bottlenecks of the system.

Object	Min	Max	Average
Tube Generator/Tubes Q	0.00	19230.00	9612.50
Rack builder_Centrifuge/Tube entry	0.00	36.18	1.67
Rack builder_Centrifuge/Output	0.00	4163.71	2032.06
Re_racking Desk/Entry point	0.00	60.93	10.49
Re_racking Desk/Output	0.00	396.44	107.47
Automate/Tubes_Q	0.75	247.39	142.10
Automate/Output	0.00	83.34	14.24
AU5822/Input buffer	0.00	0.00	0.00
AU480/Input buffer	0.00	348.89	29.43
DxI800/Input buffer	0.00	105.10	14.62
DxI600/Input buffer	0.00	11.29	0.22
Validation Console_I/Entry point	0.00	3.89	0.16
Validation Console_C/Entry point	0.00	21.42	0.91

Figure 6-17. Waiting times at several queues of the laboratory.

Totally, simulation results of the designed clinical model lead to the following system cognition:

- Smooth flow of tubes and racks within the system
- No considerable bottleneck in the system
- Deadline conformity for more than 98% of the tests and 94% of the tubes
- Excessive allocation of operators
- Staff mismanagement in tasks assignment

It is expected that applying more efficient dispatching rules or replacing DxI600 by a more powerful Immunology analyzer might decrease or even surmount the tardy tubes. In addition, an efficient aliquoting decision might augment system capability in deadline satisfaction. Additionally, an effective decision on laboratory manpower organization might lead to better utilization. The developed simulation model is able to evaluate all these scenarios to provide acceptable analytical responses to these doubts.

6.4.1. Dynamic tube arrival

In the previous simulation run, it was assumed that all tubes are available in the laboratory at eight o'clock in the morning. This assumption matches only a few cases. In most laboratories, tubes arrive to

the system in discrete periods of time. In fact, tubes are brought to the laboratory by special vehicles at some specific moments. In this section, it is assumed that tube arrival follows the bar chart presented in Figure 6-18.

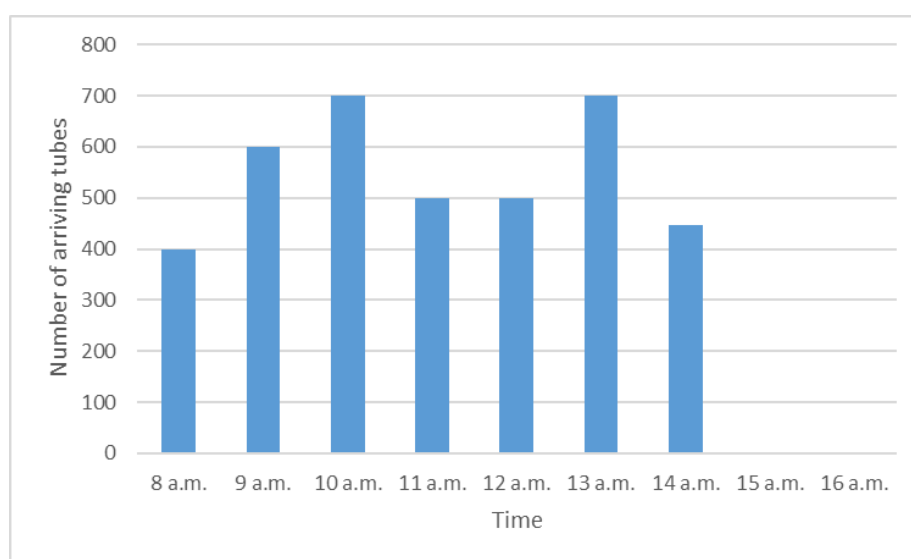

Figure 6-18. Dynamic tube arrival to the laboratory.

In this manner, for each batch of tubes, tube assignment to the analyzers is done separately considering the laboratory status at each batch arrival time in terms of reagents availability in the analyzers and quantity of waiting tubes and tests already assigned to the analyzers from prior batches. To obtain the laboratory status at the arrival time of each batch to run the assignment model, the simulation model is used. A summary of the simulation outputs for the designed laboratory receiving the tubes in a dynamic manner is presented in Table 6-5.

Table 6-5. A portion of the main clinical laboratory KPIs for dynamic tube arrival.

	<i>Value</i>
<i>Laboratory throughput</i>	
The average number of tests analyzed per hour	2824.88
The average number of tubes treated per hour	483.2
<i>Test TAT from tube arrival to test validation</i>	
Average TAT	4714.9 sec
Maximum TAT	14888.29 sec
Minimum TAT	1326.47 sec
<i>Test TAT from tube registration to test validation</i>	
Average TAT	3285.26 sec
Maximum TAT	12878.29 sec
Minimum TAT	1276.47 sec
<i>Tube TAT from tube arrival to test validation</i>	

Average TAT	6023.03 sec
Maximum TAT	14888.29 sec
Minimum TAT	1845.12 sec
<i>Tube TAT from tube registration to test validation</i>	
Average TAT	4586.66 sec
Maximum TAT	12866.29 sec
Minimum TAT	1802.32 sec
<i>Tube TIS from tube registration to tube load at fridge</i>	
Average TIS	2682.72 sec
Maximum TIS	5309.01 sec
Minimum TIS	1367.11 sec
<i>Tardy tests</i>	
Total number of tardy tests	593
Percentage of tardy tests	2.07%
Number of tardy Immunology tests	554
Number of tardy Chemistry tests	39
<i>Tardy tubes</i>	
Total number of tardy tubes	253
Percentage of tardy tubes	6.58%
Number of tardy Immunology tubes	72
Number of tardy Chemistry tubes	1
Number of tardy Immunology-Chemistry tubes	180
<i>Test tardiness</i>	
Average tardiness	2162.63 sec
Maximum tardiness	7688.29 sec
Minimum tardiness	1.65 sec

6.5. Conclusion

Computer simulation is a powerful tool to model, evaluate and analyze the performance of a real-world complex system. In this chapter, a customized simulation environment was developed in FlexSim to simulate clinical laboratories. This environment includes a library in which the most of clinical laboratory instruments have been modeled precisely. Using this environment, a simulation model of the designed clinical laboratory was built and the output results were analyzed both qualitatively and quantitatively. The simulation output results analysis provides a clear illustration on the performance of the designed clinical laboratory and gives helpful indications for system modification and further improvements.

As future researches, such detailed simulation model which includes all the main features of the laboratory can be used individually or in conjunction with other analytical approaches in the form of simulation optimization ([Fu et al., 2004](#)) to tackle the following exemplary problems in clinical laboratory design and planning:

- Evaluating the effect of several dispatching rules in different points of a laboratory
- Evaluating the effect of several laboratory layouts on laboratory performance
- Evaluating the effect of different drawing policies on laboratory performance
- Evaluating the effect of different aliquoting policies on laboratory performance
- Evaluating the effect of several task assignment policies to operators on laboratory performance

In addition, the simulation model can be used together with ranking methods such as data envelopment analysis (DEA) to evaluate and rank the several proposed solutions to tackle a specific problem ([Azadeh et al., 2008](#)).

Chapter 7

General Conclusion and Future Perspectives

7.1. General conclusion

A clinical analysis laboratory is an organization gathering human and machinery resources to analyze human fluid samples such as blood and urine. These laboratories are noticed as one of the principal and preliminary blocks in health services where most of the medical diagnoses and treatments depend on. Therefore, the efficiency and effectiveness of these organizations have straight impact on the performance of other dependent health sectors. Furthermore, reducing the operating costs in laboratories decreases the cost of treatment and eventually increases patient satisfaction.

Surveying the current situation of clinical laboratories implies the trend of fusion among these organizations which on one side, decreases the number of clinical laboratories and on the other side, enlarges the magnitude of the emerging laboratories and imposes more tasks to these organizations. This pervasive phenomenon addresses the clinical laboratories as huge organizations which require profound and precise scientific efforts while designing and planning such complex systems.

Although a wide number of studies has been carried out to improve and optimize healthcare systems, the optimization of clinical laboratories still can be spotted as a virgin domain of research where only a few dispersed studies are observed in the literature of operations research. In addition, a lack of customized and intelligent decision support tool is fully appreciated to aid clinical laboratories designers and managers facing strategic, tactical and operational decision problems.

In this thesis, to aid decision makers for the main strategic, tactical and operational problems in clinical laboratory design and operations management, a decision support tool including mathematical models, a heuristic algorithm and a customized simulation model was developed. This decision making tool follows a top-down stepwise framework starting from strategic problems and ending with operational ones, including a recursive loop for modification and improvement.

In this study, machine selection and facility layout were studied as the main strategic problems, analyzer configuration as the tactical problem, and assignment, aliquoting and scheduling as the principal operational problems. In order to deal with machine selection problem for clinical laboratory, a mathematical model was proposed which aids to select the most appropriate machines to equip the system. To tackle physical arrangement of instruments within the laboratory area, a heuristic approach was developed. The proposed heuristic comprises the key constraints of laboratory layout design. To address the analyzer configuration problem which mainly deals with the assignment of chemical materials to the analyzers in a clinical laboratory, a bi-objective mathematical model was developed. In addition, to determine an efficient assignment of sample tubes to the analyzers, a mathematical model with three objectives was proposed.

In addition, a customized, flexible, and fine-grained simulation model was developed in FlexSim to study the clinical laboratory designed through the outputs of developed mathematical models and layout

algorithm. Simulation model plays a key role in the proposed framework as it is used for many purposes. The simulation model helps the designer to construct and analyze a complete clinical laboratory taking into account job scheduling, aliquoting, and staff operations. This simulation attribute provides the ability to scrutinize the system behaviour and to find out whether the designed system is efficient. System performance analysis through simulation and resulting key performance indicators give helpful feedback for system improvement. Furthermore, the simulation model can be fruitful to decide on scheduling, aliquoting and staffing problems through the evaluation of various scenarios proposed by decision maker for each of these problems.

To verify the validity of the proposed framework, data extracted from a real case was used. The output results seal on the applicability and the efficiency of the proposed framework as well as competency of proposed techniques to deal with each optimization problem. The proposed framework brings a global view on clinical laboratory design activities and helps to systematically tackle this problem. Additionally, the proposed techniques to face each optimization problem provide feasible efficient solutions. These solutions can be considered as initial solutions and require more investigations to be finalized and practically implemented. Furthermore, existence of simulation in the proposed framework brings more flexibility by which the designer is able to assess several design alternatives to make final decisions.

In the next section, perspective and potential future research directions are discussed.

7.2. Future perspectives

This thesis can be considered as one of the leading research works on the clinical laboratory optimization as it provides a comprehensive vision on clinical laboratories' system and addresses some of the main decision problems. In order to enrich this research study and to overcome its shortcomings, following future directions are proposed:

- In the proposed framework, for some decision problems such as staff requirement, aliquoting and scheduling, only simple initial solutions were proposed to complete the laboratory design and operations; however, it is strongly worthy to define each of these problems as an optimization problem and try to develop a systematic approach to tackle them.
- Nowadays, growing data availability motivates to apply learning and data-driven optimization to more efficiently handle uncertainties in optimization problems. Designing a data-driven optimization technique specially for the operational problems is a fruitful long-term future research.
- In the road of complex system design, problem decomposition into sub-problems is inescapable; however, such decomposition eliminates the interconnections between the sub-problems. In order to reduce the harmful effects of decomposition in decision making procedure

either an iterative loop have to be considered between two interconnected problems or an integrated approach must be developed to tackle this inconvenience. As an instance, assignment and scheduling are two connected problems which have been tackled separately in this thesis; however, the results of assignment have direct impact on the scheduling problem and fixing the assignment without considering scheduling might lead to weak scheduling solution. Therefore, a promising future research is to study the connected problems in an integrated manner.

- This thesis has mainly focused on description and modeling of clinical laboratory optimization problems thereby, less attention has been paid to problem complexity and resolution approaches. Applying efficient heuristics and meta-heuristics is fruitful to tackle large-scale problems and to provide reasonable good solutions in timely manner (Talbi, 2009).
- As one of the promising future directions, more precise investigation on aliquoting problem is referable.
- Computer simulation can be applied to tackle the following exemplary problems in clinical laboratory design and planning:
 - ✓ Evaluating the effect of several dispatching rules in different points of a laboratory
 - ✓ Evaluating the effect of several laboratory layouts on laboratory performance
 - ✓ Evaluating the effect of different drawing policies on laboratory performance
 - ✓ Evaluating the effect of different aliquoting policies on laboratory performance
 - ✓ Evaluating the effect of several task assignment policies to operators on laboratory performance
- In this thesis, several mathematical models have been proposed to deal with different problems. Additionally, a customized simulation model has been developed which helps to build a valid simulation model of a clinical laboratory. Coupling these models with simulation as a simulation-based optimization technique is an interesting avenue of research.
- In this thesis, multi-objective problems have been tackled through weighted sum method. Applying Pareto multi-objective approaches is an interesting future study.
- In the analyzer configuration problem, it has been assumed that configuration is done on daily basis so that remaining reagents are discarded at the end of the working day. Although this assumption is true for some laboratories, it can be relaxed so that proposing a dynamic multi-period model could be meaningful.
- In this study, the laboratory design procedure has been surveyed considering demand data of a normal day; however, to propose a robust design, other types of input data must be taken into account.

7.3. List of publications and scientific productions

Hereafter, publications and scientific productions adapted from this thesis are listed:

- One filed and published but not yet granted US patent entitled '*Intelligent handling of materials*'.

<https://patents.google.com/patent/WO2018111721A1/en>

- Two filed but not yet published US patents entitled '*Laboratory instrument selection and configuration*' and '*System and method for clinical laboratory layout design*'.

- Two accepted full papers in international conferences:

- Sohrab Faramarzi Oghani, El-Ghazali Talbi, Martin Bué, Eric Varlet. Optimization of analyzers configuration in a clinical laboratory: a mathematical model. *MOSIM'18*, Jun 2018, Toulouse, France.
- Sohrab Faramarzi Oghani, El-Ghazali Talbi, Martin Bué, Eric Varlet. A heuristic approach for standalone clinical laboratory layout design. *META'2018*, October 2018, Marrakesh, Morocco.

- One accepted and presented abstract entitled '*A mathematical model for machine selection problem in clinical laboratories*' in *OR2018* Conference in Brussels, Belgium.

References

- Ahmadi, A., Pishvae, M. S., & Jokar, M. R. A. (2017). A survey on multi-floor facility layout problems. *Computers & Industrial Engineering*, 107, 158-170.
- Aiello, G., Enea, M., & Galante, G. (2006). A multi-objective approach to facility layout problem by genetic search algorithm and Electre method. *Robotics and Computer-Integrated Manufacturing*, 22(5-6), 447-455.
- Aleisa, E. E., & Lin, L. (2005, December). For effective facilities planning: layout optimization then simulation, or vice versa? *In Proceedings of the 37th conference on Winter simulation* (pp. 1381-1385). Winter Simulation Conference.
- Alidaee, B., & Li, H. (2014). Parallel machine selection and job scheduling to minimize sum of machine holding cost, total machine time costs, and total tardiness costs. *IEEE Transactions on Automation Science and Engineering*, 11(1), 294-301.
- Anjos, M. F., & Vieira, M. V. (2017). Mathematical optimization approaches for facility layout problems: The state-of-the-art and future research directions. *European Journal of Operational Research*, 261(1), 1-16.
- Armour, G. C., & Buffa, E. S. (1963). A heuristic algorithm and simulation approach to relative allocation of facilities. *Management Science*, 9(2), 294– 300.
- Azadeh, A., Ghaderi, S. F., & Izadbakhsh, H. (2008). Integration of DEA and AHP with computer simulation for railway system improvement and optimization. *Applied Mathematics and Computation*, 195(2), 775-785.
- Azadeh, A., Moghaddam, M., Asadzadeh, S. M., & Negahban, A. (2011). An integrated fuzzy simulation-fuzzy data envelopment analysis algorithm for job-shop layout optimization: the case of injection process with ambiguous data. *European Journal of Operational Research*, 214(3), 768-779.
- Azadeh, A., Nazari, T., & Charkhand, H. (2015). Optimisation of facility layout design problem with safety and environmental factors by stochastic DEA and simulation approach. *International Journal of Production Research*, 53(11), 3370-3389.
- Baker, K. R. (1974). Introduction to sequencing and scheduling. *John Wiley & Sons*.
- Balakrishnan, J., & Cheng, C. H. (1998). Dynamic layout algorithms: a state-of-the-art survey. *Omega*, 26(4), 507-521.
- Beaverstock, M., Greenwood, A., Lavery, E., & Nordgren, W. (2011). Applied simulation: modeling and analysis using FlexSim. BookBaby.
- Berchtold, G., Blaschke, H., Hanssmann, F., Liebl, F., Braun, S.L., Vogt, W., Eckert, M., Hoffmann, G. and Klose, S. (1994). Simulation modeling as a tool to evaluate alternative configurations of clinical laboratories. *Simulation*, 63(2), 108-120.
- Blazewicz, J., Lenstra, J. K., & Kan, A. R. (1983). Scheduling subject to resource constraints: classification and complexity. *Discrete applied mathematics*, 5(1), 11-24.
- Bodtker, K., Wilson, L. and Godolphin, W. (1993). Simulation modelling to assist operational management and planning in clinical laboratories. *Simulation*, 60(4), 247-255.
- Boran, G., Given, P. and O'Moore, R. (1996). Patient result validation services. *Computer methods and programs in biomedicine*, 50(2), 161-168.

- Braglia, M. (1996). Optimisation of a Simulated-Annealing-based Heuristic for Single Row Machine Layout Problem by Genetic Algorithm. *International Transactions in Operational Research*, 3(1), 37-49.
- Brailsford, S. and Vissers, J. (2011). OR in healthcare: A European perspective. *European journal of operational research*, 212(2), 223-234.
- Çakır, S. (2016). An integrated approach to machine selection problem using fuzzy SMART-fuzzy weighted axiomatic design. *Journal of Intelligent Manufacturing*, 1-13.
- Cao, D., Chen, M., & Wan, G. (2005). Parallel machine selection and job scheduling to minimize machine cost and job tardiness. *Computers & operations research*, 32(8), 1995-2012.
- Carson, I. I., Nicol, D. M., Nelson, B. L., & Banks, J. (2005). Discrete-event system simulation.
- Chakraborty, S., & Banik, D. (2006). Design of a material handling equipment selection model using analytic hierarchy process. *The International Journal of Advanced Manufacturing Technology*, 28(11-12), 1237-1245.
- Chan, F. T. S. (2002). Design of material handling equipment selection system: an integration of expert system with analytic hierarchy process approach. *Integrated Manufacturing Systems*, 13(1), 58-68.
- Chen, D. S., Wang, Q., & Chen, H. C. (2001). Linear sequencing for machine layouts by a modified simulated annealing. *International Journal of Production Research*, 39(8), 1721-1732.
- Chen, Y. L., Chen, L. H., & Huang, C. Y. (2009). Fuzzy Goal Programming Approach to Solve the Equipment-Purchasing Problem of an FMC. *International Journal of Industrial Engineering: Theory, Applications and Practice*, 16(4).
- Chtourou, H., Masmoudi, W., & Maalej, A. (2005). An expert system for manufacturing systems machine selection. *Expert Systems with Applications*, 28(3), 461-467.
- Chwif, L., Barretto, M. R. P., & Moscato, L. A. (1998). A solution to the facility layout problem using simulated annealing. *Computers in industry*, 36(1-2), 125-132.
- CO, H., WU, A., & REISMAN, A. (1989). A throughput-maximizing facility planning and layout model. *International Journal of Production Research*, 27(1), 1-12.
- Cochran, D. S., Arinez, J. F., Duda, J. W., & Linck, J. (2002). A decomposition approach for manufacturing system design. *Journal of manufacturing systems*, 20(6), 371-389.
- Coello, C. A. C. (1999). A comprehensive survey of evolutionary-based multi-objective optimization techniques. *Knowledge and Information systems*, 1(3), 269-308.
- Coello, C. C. (2006). Evolutionary multi-objective optimization: a historical view of the field. *IEEE computational intelligence magazine*, 1(1), 28-36.
- Conway, R. W., Maxwell, W. L., & Miller, L. W. (1967). Theory of Scheduling. *Massachusetts: Addison-Wesley*.
- Dağdeviren, M. (2008). Decision making in equipment selection: an integrated approach with AHP and PROMETHEE. *Journal of intelligent manufacturing*, 19(4), 397-406.

- Dankbar, G.C., Shellum, J.L. and Bennet, K.E. (1992), December. The use of simulation to evaluate automated equipment for a clinical processing laboratory. In *Proceedings of the 24th conference on Winter simulation* (1065-1070). ACM.
- D'Ariano, A., Pacciarelli, D., Pistelli, M., & Pranzo, M. (2015). Real-time scheduling of aircraft arrivals and departures in a terminal maneuvering area. *Networks*, 65(3), 212-227.
- Das, S. K. (1993). A facility layout method for flexible manufacturing systems. *International Journal of Production Research*, 31(2), 279-297.
- Davis, R. P., & Miller, D. M. (1978). A model for determining machine requirements in a multistage manufacturing system with discretely distributed demand. *Applied Mathematical Modelling*, 2(2), 119-122.
- Deb, K. (2014). Multi-objective optimization. In *Search methodologies* (pp. 403-449). Springer, Boston, MA.
- Deb, S. K., Bhattacharyya, B., & Sorkhel, S. K. (2002, February). Material handling equipment selection by fuzzy multi-criteria decision making methods. In *AFSS International Conference on Fuzzy Systems* (pp. 99-105). Springer, Berlin, Heidelberg.
- Devise, O., & Pierreval, H. (2000). Indicators for measuring performances of morphology and material handling systems in flexible manufacturing systems. *International Journal of Production Economics*, 64(1-3), 209-218.
- Drira, A., Pierreval, H., & Hajri-Gabouj, S. (2007). Facility layout problems: A survey. *Annual reviews in control*, 31(2), 255-267.
- Dunker, T., Radons, G., & Westkämper, E. (2003). A coevolutionary algorithm for a facility layout problem. *International Journal of Production Research*, 41(15), 3479-3500.
- Elena, B.M., Beraldi, P. and Conforti, D. (2006). Improving the efficiency of a clinical laboratory: A mathematical approach. *IFAC Proceedings Volumes*, 39(3), 659-664.
- Ertuğrul, İ., & Güneş, M. (2007). Fuzzy multi-criteria decision making method for machine selection. In *Analysis and Design of Intelligent Systems using Soft Computing Techniques* (pp. 638-648). Springer, Berlin, Heidelberg.
- Franses, P. and Post, G. (2002), August. Personnel scheduling in laboratories. In *International Conference on the Practice and Theory of Automated Timetabling* (113-119). Springer, Berlin, Heidelberg.
- Fu, M. C., Glover, F. W., & April, J. (2005, December). Simulation optimization: a review, new developments, and applications. In *Proceedings of the 37th conference on Winter simulation* (pp. 83-95). Winter Simulation Conference.
- Graham, R. L., Lawler, E. L., Lenstra, J. K., & Kan, A. R. (1979). Optimization and approximation in deterministic sequencing and scheduling: a survey. In *Annals of discrete mathematics* (Vol. 5, pp. 287-326). Elsevier.
- Groothuis, S., Goldschmidt, H.M., Drupsteen, E.J., Vries, J., Hasman, A. and Merode, G.G.V. (2002). Turn-around time for chemical and endocrinology analyzers studied using simulation. *Clinical chemistry and laboratory medicine*, 40(2), 174-181.

- Guan, J., & Lin, G. (2016). Hybridizing variable neighborhood search with ant colony optimization for solving the single row facility layout problem. *European Journal of Operational Research*, 248(3), 899-909.
- Guldogan, E. U. (2011). An integrated approach to machine selection and operation allocation problem. *The International Journal of Advanced Manufacturing Technology*, 55(5-8), 797-805.
- Gunasekaran, A., Goyal, S. K., Martikainen, T., & Yli-Olli, P. (1993). Equipment selection problems in just-in-time manufacturing systems. *Journal of the Operational Research Society*, 44(4), 345-353.
- Hassan, M. M. D. (1994). Machine layout problem in modern manufacturing facilities. *International Journal of Production Research*, 32(11), 2559-2584.
- Hayes, R.H. and Wheelwright, S.C. (1979). "Link manufacturing process and product lifecycles." *Harvard Business Review* (Jan.-Feb. 1979).
- Heragu, S. S. (2008). *Facilities design*. CRC Press.
- Heragu, S. S., & Kusiak, A. (1987). Analysis of expert systems in manufacturing design. *IEEE Transactions on systems, man, and cybernetics*, 17(6), 898-912.
- Hodgett, R. E. (2016). Comparison of multi-criteria decision-making methods for equipment selection. *The International Journal of Advanced Manufacturing Technology*, 85(5-8), 1145-1157.
- Hosseini-Nasab, H., Fereidouni, S., Ghomi, S. M. T. F., & Fakhrazad, M. B. (2018). Classification of facility layout problems: a review study. *The International Journal of Advanced Manufacturing Technology*, 94(1-4), 957-977.
- Jain, A. K., Kasilingam, R. G., & Bhole, S. D. (1991). Resource-requirements planning in flexible manufacturing systems. *The International Journal of Advanced Manufacturing Technology*, 6(3), 232-245.
- Kadı, D., Kuvvetli, Y. and Çolak, S. (2016). Performance analysis of a university hospital blood laboratory via discrete event simulation. *Simulation*, 92(5), 473-484.
- Kim, I. Y., & De Weck, O. L. (2006). Adaptive weighted sum method for multi-objective optimization: a new method for Pareto front generation. *Structural and multidisciplinary optimization*, 31(2), 105-116.
- Kim, J. G., & Kim, Y. D. (2000). Layout planning for facilities with fixed shapes and input and output points. *International Journal of Production Research*, 38(18), 4635-4653.
- Koopmans, T. C., & Beckmann, M. (1957). Assignment problems and the location of economic activities. *Econometrica: journal of the Econometric Society*, 53-76.
- Kuhn, H. W. (1955). The Hungarian method for the assignment problem. *Naval research logistics quarterly*, 2(1-2), 83-97.
- Kundu, A., & Dan, P. K. (2012). Metaheuristic in facility layout problems: current trend and future direction. *International Journal of Industrial and Systems Engineering*, 10(2), 238-253.
- Kusiak, A., & Heragu, S. S. (1987). The facility layout problem. *European Journal of operational research*, 29(3), 229-251.

- Kusiak, A., and S. S. Heragu. "KBSES: a knowledge-based system for equipment selection." *The International Journal of Advanced Manufacturing Technology*, no. 3 (1988): 97-109.
- Law, A. M. (2003, December). How to conduct a successful simulation study? *In Proceedings of the 35th conference on Winter simulation: driving innovation* (pp. 66-70). Winter Simulation Conference.
- Law, A. M., & Kelton, W. D. (1991). *Simulation modeling and analysis* (Vol. 2). New York: McGraw-Hill.
- Lee, G. C., & Kim, Y. D. (2000). Algorithms for adjusting shapes of departments in block layouts on the grid-based plane. *Omega*, 28(1), 111-122.
- Lee, R., & Moore, J. M. (1967). CORELAP-computerized relationship layout planning. *The Journal of Industrial Engineering*, 18, 195-200.
- Lin, Z. C., & Yang, C. B. (1996). Evaluation of machine selection by the AHP method. *Journal of Materials Processing Technology*, 57(3-4), 253-258.
- Lote, R., Williams, E.J. and Ülgen, O.M. (2009). Simulation of Medical Laboratory Operations to Achieve Optimal Resource Allocation. *In ECMS* (249-255).
- Luangmul, K., Pichitlamken, J. and Weerawat, W. (2012). A simulation model of a hospital's clinical laboratory. *Lect Notes Manag Sci*, 4, 64-9.
- Maccarthy, B. L., & Liu, J. (1993). Addressing the gap in scheduling research: a review of optimization and heuristic methods in production scheduling. *The International Journal of Production Research*, 31(1), 59-79.
- Marinagi, C.C., Spyropoulos, C.D., Papatheodorou, C. and Kokkotos, S. (2000). Continual planning and scheduling for managing patient tests in hospital laboratories. *Artificial Intelligence in Medicine*, 20(2), 139-154.
- Marler, R. T., & Arora, J. S. (2004). Survey of multi-objective optimization methods for engineering. *Structural and multidisciplinary optimization*, 26(6), 369-395.
- Masmoudi, W., Chtourou, H., & Maalej, A. Y. (2007). Labor and machine sizing through a simulation-expert-system-based approach. *Simulation Modelling Practice and Theory*, 15(1), 98-110.
- Meller, R. D., Narayanan, V., & Vance, P. H. (1999). Optimal facility layout design. *Operations Research Letters*, 23(3-5), 117-127.
- Mellor, P. (1966). A review of job shop scheduling. *Journal of the Operational Research Society*, 17(2), 161-171.
- Merode, G.G., Oosten, M., Vrieze, O.J., Derks, J. and Hasman, A. (1998). Optimisation of the structure of the clinical laboratory. *European journal of operational research*, 105(2), 308-316.
- Mielczarek, B., & Uziako-Mydlikowska, J. (2012). Application of computer simulation modeling in the health care sector: a survey. *Simulation*, 88(2), 197-216.
- Miller, D. M., & Davis, R. P. (1977). The machine requirements problem. *The International Journal of Production Research*, 15(2), 219-231.

- Moslemipour, G., Lee, T. S., & Loong, Y. T. (2018). Solving stochastic dynamic facility layout problems using proposed hybrid AC-CS-SA meta-heuristic algorithm. *International Journal of Industrial and Systems Engineering*, 28(1), 1-31.
- Moslemipour, G., Lee, T. S., & Rilling, D. (2012). A review of intelligent approaches for designing dynamic and robust layouts in flexible manufacturing systems. *The International Journal of Advanced Manufacturing Technology*, 60(1-4), 11-27.
- Mourtzis, D., Doukas, M., & Bernidaki, D. (2014). Simulation in manufacturing: Review and challenges. *Procedia CIRP*, 25, 213-229.
- Myint, S., & Tabucanon, M. T. (1994). A multiple-criteria approach to machine selection for flexible manufacturing systems. *International Journal of Production Economics*, 33(1-3), 121-131.
- Naseer, A., Eldabi, T., & Jahangirian, M. (2009). Cross-sector analysis of simulation methods: a survey of defense and healthcare. *Transforming Government: People, Process and Policy*, 3(2), 181-189.
- Negahban, A., & Smith, J. S. (2014). Simulation for manufacturing system design and operation: Literature review and analysis. *Journal of Manufacturing Systems*, 33(2), 241-261.
- O'Moore, R.R., De Moor, G., Boran, G., Gaffney, P., Grimson, J., McNair, P., Groth, T., Nykänen, P., Hasman, A., Eller, J. and Yearworth, M., (1994). OpenLabs: the application of advanced informatics and telematics for optimization of clinical laboratory services. *Computer methods and programs in biomedicine*, 45(1-2), 137-140.
- O'Moore, R.R., Groth, T., Grimson, W. and Boran, G. (1996). The OpenLabs Project. *Computer methods and programs in biomedicine*, 50, 85-86.
- Onar, S.C., Oztaysi, B. and Kahraman, C. (2018). A Comprehensive Survey on Healthcare Management. In *Operations Research Applications in Health Care Management* (23-51). Springer, Cham.
- Paramasivam, V., Senthil, V., & Ramasamy, N. R. (2011). Decision making in equipment selection: an integrated approach with digraph and matrix approach, AHP and ANP. *The International Journal of Advanced Manufacturing Technology*, 54(9-12), 1233-1244.
- Park, Y. B. (1996). ICMESSE: intelligent consultant system for material handling equipment selection and evaluation. *Journal of Manufacturing Systems*, 15(5), 325.
- Pentico, D. W. (2007). Assignment problems: A golden anniversary survey. *European Journal of Operational Research*, 176(2), 774-793.
- Pinedo, M. L. (2016). Scheduling: theory, algorithms, and systems. Springer.
- Pritsker, A. A. B., & O'Reilly, J. J. (1999). Simulation with visual SLAM and AweSim. *John Wiley & Sons*.
- Rajasekharan, M., Peters, B. A., & Yang, T. (1998). A genetic algorithm for facility layout design in flexible manufacturing systems. *International Journal of Production Research*, 36(1), 95-110.
- Rajendran, C., & Holthaus, O. (1999). A comparative study of dispatching rules in dynamic flowshops and jobshops. *European journal of operational research*, 116(1), 156-170.
- Seehof, J. M., & Evans, W. O. (1967). Automated layout design program. *The Journal of Industrial Engineering*, 18, 690-695.

- Sharma, P., & Singhal, S. (2016). A review on implementation of meta-heuristic approaches for layout problems in dynamic business environment. *International Journal of Multivariate Data Analysis*, 1(1), 6-27.
- Singh, S. P., & Sharma, R. R. (2006). A review of different approaches to the facility layout problems. *The International Journal of Advanced Manufacturing Technology*, 30(5-6), 425-433.
- Suh, N. P. (1990). The principles of design (No. 6). *Oxford University Press on Demand*.
- Tabucanon, M. T., Batanov, D. N., & Verma, D. K. (1994). Decision support system for multicriteria machine selection for flexible manufacturing systems. *Computers in industry*, 25(2), 131-143.
- Talbi, E. G. (2009). *Metaheuristics: from design to implementation* (Vol. 74). John Wiley & Sons.
- Terzi, S., & Cavalieri, S. (2004). Simulation in the supply chain context: a survey. *Computers in industry*, 53(1), 3-16.
- Tompkins, J. A., & Reed, J. R. (1976). An applied model for the facilities design problem. *International Journal of Production Research*, 14, 583-595.
- Umetani, S., Fukushima, Y., & Morita, H. (2017). A linear programming based heuristic algorithm for charge and discharge scheduling of electric vehicles in a building energy management system. *Omega*, 67, 115-122.
- Van Merode, G.G., Hasman, A., Derks, J., Schoenmaker, B. and Goldschmidt, H.M.J. (1996). Advanced management facilities for clinical laboratories. *Computer methods and programs in biomedicine*, 50(2), 195-205.
- Vogt, W., Braun, S.L., Hanssmann, F., Liebl, F., Berchtold, G., Blaschke, H., Eckert, M., Hoffmann, G.E. and Klose, S. (1994). Realistic modeling of clinical laboratory operation by computer simulation. *Clinical chemistry*, 40(6), 922-928.
- Votaw, D.F., Orden, A. (1952). The personnel assignment problem. Symposium on Linear Inequalities and Programming, SCOOP 10, *US Air Force*, pp.155-163.
- Wang, G., Yan, Y., Zhang, X., Shangguan, J., & Xiao, Y. (2008, December). A simulation optimization approach for facility layout problem. In *Industrial Engineering and Engineering Management*, 2008. IEEM 2008. IEEE International Conference (pp. 734-738). IEEE.
- Yazdani-Chamzini, A., & Yakhchali, S. H. (2012). Tunnel Boring Machine (TBM) selection using fuzzy multicriteria decision making methods. *Tunnelling and Underground Space Technology*, 30, 194-204.
- Yücel, E., Salman, F. S., Gel, E. S., Örmeci, E. L., & Gel, A. (2013). Optimizing specimen collection for processing in clinical testing laboratories. *European Journal of Operational Research*, 227(3), 503-514.
- Zhou, J. (1998). Algorithmes et outils pour l'analyse des flux de production a l'aide du concept d'ordre (Doctoral dissertation, Strasbourg 1).
- Zhu, H., Liu, D., Zhang, S., Zhu, Y., Teng, L., & Teng, S. (2016). Solving the many-to-many assignment problem by improving the Kuhn-Munkres algorithm with backtracking. *Theoretical Computer Science*, 618, 30-41.