



HAL
open science

Formal Methods for Functional Verification of Cache-Coherent System-on-Chip

Abderahman Kriouile

► **To cite this version:**

Abderahman Kriouile. Formal Methods for Functional Verification of Cache-Coherent System-on-Chip. Logic in Computer Science [cs.LO]. Université Grenoble Alpes, 2015. English. NNT: . tel-01258784v1

HAL Id: tel-01258784

<https://inria.hal.science/tel-01258784v1>

Submitted on 19 Jan 2016 (v1), last revised 25 Jan 2016 (v2)

HAL is a multi-disciplinary open access archive for the deposit and dissemination of scientific research documents, whether they are published or not. The documents may come from teaching and research institutions in France or abroad, or from public or private research centers.

L'archive ouverte pluridisciplinaire **HAL**, est destinée au dépôt et à la diffusion de documents scientifiques de niveau recherche, publiés ou non, émanant des établissements d'enseignement et de recherche français ou étrangers, des laboratoires publics ou privés.

THÈSE

Pour obtenir le grade de

DOCTEUR DE L'UNIVERSITÉ DE GRENOBLE

Spécialité : **Informatique**

Arrêté ministériel : 7 août 2006

Présentée par

Abderahman KRIOUILE

Thèse dirigée par **Radu Mateescu**
et codirigée par **Wendelin Serwe**

préparée au sein d' **Inria Grenoble Rhône-Alpes**, du laboratoire **LIG**
et de l'**Ecole Doctorale Mathématiques, Sciences et Technologies de l'Information, Informatique**

Formal Methods for Functional Verification of Cache-Coherent System-on-Chip

Thèse soutenue publiquement le **17 septembre 2015**,
devant le jury composé de :

Emmanuelle Encrenaz

Maître de conférences, LIP6, Université Pierre et Marie Curie, Rapporteur

Franz Wotawa

Professeur, IST, Graz University of Technology, Rapporteur

Ghassan Chehaibar

Docteur-Ingénieur expert, Bull, Examineur

Thierry Jéron

Directeur de recherche, Inria Rennes, Examineur

Guilhem Barthes

Ingénieur expert, STMicroelectronics, Encadrant Industriel

Massimo Zendri

Docteur-Ingénieur expert, STMicroelectronics, Encadrant Industriel

Radu Mateescu

Directeur de recherche, Inria Grenoble, Directeur de thèse

Wendelin Serwe

Chargé de recherche, Inria Grenoble, Co-directeur de thèse



Abstract

State-of-the-art System-on-Chip (SoC) architectures integrate many different components, such as processors, accelerators, memories, and I/O blocks. Some of those components but not all may have caches. Because the effort of validation with simulation-based techniques, as currently used in industry, grows exponentially with the complexity of the SoC, this thesis investigates the use of formal verification techniques in this context. More precisely, we use the CADP toolbox to develop and validate a generic formal model of an SoC compliant with the recent ACE specification proposed by ARM to implement system-level cache coherency. We use a constraint-oriented specification style to model the general requirements of the specification. We verify system properties on both the constrained and unconstrained model to detect the cache coherency corner cases. We take advantage of the parametrization of the proposed model to produce a comprehensive set of counterexamples of non-satisfied properties in the unconstrained model.

The results of formal verification are then used to improve the industrial simulation-based verification techniques in two aspects. On the one hand, in order to generate clever semi-directed test cases from temporal logic properties, we propose a two-step approach. One step consists in generating system-level abstract test cases using model-based testing tools of the CADP toolbox. The other step consists in refining those tests into interface-level concrete test cases that can be executed at RTL level with a commercial Coverage-Directed Test Generation tool. On the other hand, we suggest to use the formal model to assess the sanity of an interface verification unit.

We found that our approach helps in the transition between interface-level and system-level verification, facilitates the validation of system-level properties, and enables early detection of bugs in both the SoC and the commercial test-bench.

Key words: System-Level Cache Coherency, Functional Verification, System-on-Chip, System-Level Validation, CADP, Explicit-State Model Checking, Equivalence Checking, Model-Based Testing, Test Coverage, Test Generation

Contents

Abstract (English/Français)	i
Contents	iii
List of figures	ix
List of tables	xi
1 Introduction	1
1.1 Contributions	4
1.2 Outline	5
I Background and State of the Art	7
2 Background Concepts	9
2.1 Labeled Transition Systems	9
2.2 Process Calculi	10
2.3 Equivalence Checking	11
2.4 Model checking	12
2.4.1 Temporal Logic Languages	13
2.4.2 Propositional Mu-Calculus	15
2.4.3 Symbolic Model Checking	16
2.4.4 Explicit-State Model Checking	18
2.5 Model-Based Testing	19
2.5.1 Definition of <i>ioco</i> Relation for IOTS	20
2.5.2 Test Generation and Test Execution for LTSs	20
2.5.3 Test Selection in Model-Based Testing	21
2.6 CADP Toolbox	22
2.6.1 Representing LTSs in CADP	22
2.6.2 Modeling Language LNT	22
2.6.3 Temporal Logic Language MCL	23
2.6.4 Script Verification Language (SVL)	25

3	State of the Art: Formal Validation of Hardware	27
3.1	Use of Formal Verification	28
3.1.1	Formal Verification using Model Checking	29
3.1.2	Formal Verification using Equivalence Checking	30
3.1.3	Formal Verification using Theorem Proving	30
3.2	Semi-Formal Verification and Assertions	31
3.3	System-Level Approaches	32
3.3.1	SystemC Transaction Level Models	32
3.3.2	High-Level Formal Models and Abstractions	33
3.4	Test Generation strategies	34
3.4.1	Coverage-Directed Test Generation	35
3.4.2	Faults-Based Test Generation	35
3.4.3	Combining Model-Based and Coverage-Directed Testing	36
3.5	Applications of Formal Verification to Hardware Cache Coherency	36
3.6	Applications of CADP to Hardware Validation	37
3.6.1	Formal Modeling	37
3.6.2	Functional Verification	38
3.6.3	Model-Based Testing	39
3.6.4	Performance Evaluation	40
II	Formal Modeling of a System-Level Cache Coherent SoC	43
4	System Level Cache Coherency with AMBA 4 ACE	45
4.1	Introduction	45
4.2	System-Level Cache Coherency	45
4.3	AMBA 4 ACE protocol	47
4.4	ACE States	48
4.5	ACE Ports and Channels	48
4.6	ACE Transactions	49
4.7	Requirements on the Global Ordering of Transactions	52
4.8	Discussion	53
5	Formally Modeling an ACE-based SoC using LNT	55
5.1	Introduction	55
5.2	General Description of the Formal Model	55
5.2.1	Types and Data Structures	56
5.2.2	Channels	57
5.2.3	Channel Structures	58
5.2.4	AXI Slave: Shareable Memory	61
5.2.5	ACE Masters	63
5.2.6	ACE-Lite Masters	63
5.2.7	Cache Coherent Interconnect (CCI)	64

5.3	Modeling Global Ordering Requirements	64
5.4	State Space Generation	64
5.4.1	Shareable Focused Model	65
5.4.2	Optimized Model	66
5.5	Model Validation	66
5.5.1	Absence of Deadlocks	68
5.5.2	Absence of Livelocks	68
5.5.3	Complete Execution of Transactions	68
5.6	First Industrial Results	69
5.7	Discussion	69
III Model Exploitation		71
6	Model Checking System-Level Properties	73
6.1	Introduction	73
6.2	System-Level Cache Coherency Analysis	73
6.2.1	Cache Line States Coherency Requirements	74
6.2.2	Data Integrity Requirements	74
6.2.3	Messaging Consistency Requirements	75
6.3	System-Level Properties	75
6.3.1	Cache States Coherency	76
6.3.2	Data Integrity	77
6.3.3	Consistency of Coherency Parameters	80
6.4	Model-Checking Results	83
6.4.1	Cache State Coherency Results	83
6.4.2	Data Integrity Results	84
6.4.3	Consistency of Coherency Parameters Results	85
6.4.4	Example of a Non Satisfied Property	85
6.4.5	Reproduction of a Previously Fixed Bug	86
6.5	Conclusion	87
7	From Temporal Logic Properties to Clever Test Cases	89
7.1	Introduction	89
7.2	Computation of Interesting Configurations Containing Faults	90
7.3	Model Checking Based Test Generation	91
7.3.1	Unique Dirty Cache State Coherency Test Purpose	91
7.3.2	Unique Clean Cache State Coherency Test Purpose	92
7.3.3	Shareable Memory Data Integrity Test Purpose	94
7.3.4	Model-Based Test Generation Process	94
7.4	Industrial Results and Impact	96
7.4.1	IVK Dynamic Test Benches	96
7.4.2	Making the Test Bench Ready for System-Level Verification	98

Contents

7.4.3	Industrial Results	99
8	Sanity of a Formal Check List	103
8.1	Modeling Formal Checks in LNT	103
8.1.1	C1: No Overlapping Read Write Transactions	104
8.1.2	C2: No Maintenance Transaction while Pending Shareable Transaction	105
8.1.3	C3: No Shareable Read Transaction while Pending Maintenance Transaction	106
8.1.4	C4: No WriteBack or WriteClean while WriteUnique or WriteLineUnique	108
8.1.5	C5: No Shareable write Transaction while Maintenance Transaction	109
8.1.6	C6: Snoop Response when Memory Update in Progress	110
8.1.7	C7: Order between Channels AC and CD	112
8.1.8	C8: Order between Channels AC and CR	113
8.1.9	C9: PassDirty and IsShared Check	114
8.2	Local Sanity of Each Check	115
8.3	Global Sanity of the List of Checks	116
8.4	Improvement of System Coverage Infrastructure	117
8.5	Industrial Results	118
9	Conclusion	121
9.1	Summary of Contributions	121
9.2	Research Perspectives	123
9.3	Scientific Publications and Communications	124
9.3.1	Scientific Publications	124
9.3.2	Scientific Communications	125
IV	Appendix	127
A	Model Checking Properties	129
A.1	Unique dirty coherency	129
A.2	Unique clean coherency	130
A.3	Shared dirty coherency	130
A.4	Shared clean coherency	131
A.5	Unique clean data integrity	131
A.6	Shared dirty data integrity	133
A.7	Shared clean data integrity	134
A.8	Shareable memory data integrity	136
A.9	Read response no PassDirty property	136
A.10	Read response no IsShared property	137
A.11	Read response no IsSharedDirty property	138

A.12 Coherency response PassDirty property	138
A.13 Coherency response no PassDirty property	139
A.14 Coherency response IsShared property	140
A.15 Coherency response no IsShared property	140
Bibliography	152
Glossary	153

List of Figures

2.1	LTS example	10
2.2	LTL operators	13
2.3	CTL operators	14
2.4	Coffee machine example	15
2.5	Impact of variable ordering on BDD size	17
2.6	LNT module example	24
4.1	Example of a heterogeneous SoC using System-Level Cache Coherency . .	46
4.2	ACE: AXI Coherency Extension	47
4.3	ACE states of a cache line	48
4.4	Structures of ACE, ACE-Lite, AXI ports	49
4.5	Execution scenario of a <i>ReadOnce</i> transaction	50
5.1	Model architecture	56
5.2	LNT process representing the shareable memory	62
6.1	State-based and action-based view of a cache line	76
6.2	Data integrity counterexample	86
6.3	Fixed data integrity counterexample	87
7.1	Model-based test generation flow	90
7.2	Function CIC to compute a set of interesting configurations containing faults	90
7.3	IVK generation flow	97
7.4	IVK cci400_r1p2 test bench architecture	98

List of Tables

3.1	CADP: formal modeling effort in past projects	38
3.2	CADP: functional verification results	39
3.3	CADP: Model-based testing results	40
4.1	Snoop transactions and their original transactions	52
5.1	Experimental results: state space generation of shareable focused model configurations	65
5.2	Experimental results: state space generation of optimized model configurations	67
6.1	Cache coherency requirements analysis	74
6.2	Model checking results: cache state coherency	83
6.3	Model checking results: : data integrity	84
6.4	Model checking results: coherency parameters	85
7.1	Experimental test case extraction results	95
7.2	Industrial results: bugs report	99

Chapter 1

Introduction

The integration of ever more functionalities in set-top boxes or mobile appliances such as smart-phones increases the complexity of both the embedded software and the hardware architecture. The design and validation of embedded applications address both the software and the hardware aspects of the system. In our study we are interested in the hardware part of embedded applications. The latter is usually a complex System-on-Chip (SoC), featuring a significant number of heterogeneous components. Indeed, a typical SoC includes nowadays not only processors and memory, but also dedicated hardware accelerators and (analog) I/O blocks. Integrating caches into some of these components (in particular, into processors and hardware accelerators) can increase performance and reduce power consumption, for instance by avoiding accesses to (possibly off-chip) memory.

In the past, prevalence of fast processors encouraged designers to manage cache coherency in software, taking advantage of the flexibility of software solutions. However, due to increased software complexity, a recent trend [MHS12, Tho12] is to introduce hardware support for cache coherency, lightening the load on the processors, thus improving performance and lowering power consumption. In this vein, ARM proposed AMBA 4 ACE (AXI Coherency Extensions) [ARM13], which is becoming a de facto industrial standard for system-level cache coherence in heterogeneous SoCs (ACE explicitly includes operations, called ACE-Lite operations, for components without cache). ACE is required by the ARM® big.LITTLE™ solution [PG11], which takes advantage of two processors (i.e., a “big” and a “LITTLE” one) for low-power SoCs. Also, STMicroelectronics is about to integrate system level cache coherency (based on ACE) in its upcoming heterogeneous SoCs for a family of commercial set-top-boxes supporting multiple Ultra HD flows on a single chip.

Cache coherence protocols are known to be complex and difficult to validate. Therefore, assuring system-level cache coherency is one of the major challenges faced by architects

of current SoC designs. In fact, functional verification continues to be one of the most expensive and time-consuming steps in a typical SoC design flow. Validating a concurrent system has always been a major issue for systems designers. In practice, most widely used techniques are based on extensive simulation due to the related flexibility. Given that the related validation effort grows exponentially with the complexity of hardware architectures, we study the application of formal verification techniques (rooted in concurrency theory), where the human modeling effort increases linearly with the complexity of architectures. Thus, the exponential complexity is handled by automated verification tools.

In computer science, concurrency is a characteristic of systems in which several computations are executed simultaneously, potentially interacting with each other. This notion is intended to cover a wide range of system architectures, from tightly coupled, mostly synchronous parallel systems, to loosely coupled, largely asynchronous distributed systems. We refer to systems exhibiting concurrency as *concurrent systems*, and we call computer programs written for concurrent systems *concurrent programs* [CS96]. *Concurrency theory* [AFV01] is an active field of research in theoretical computer science, which proposes a variety of formalisms for modeling and reasoning about concurrent systems.

The validation of concurrent systems is composed of two different branches: functional verification and performance evaluation. The former consists of verifying the correctness of the system, i.e., verifying that the system respects the specified functional requirements. The latter focuses on the qualitative aspects. Besides, performance evaluation focuses on quantitative aspects such as measuring the response time of the system and the end-to-end communication delay.

In this thesis, we are interested in functional verification. We aim at validating the correctness of the behavior of a hardware concurrent system. In order to functionally verify a hardware design, the following formal methods are often used: elaborating a mathematical correctness proof or checking all possible conditions. The first method is implemented by *theorem provers*, which are based on automated deduction, a subfield of automated reasoning and mathematical logic dealing with proving mathematical theorems by computer programs. The second method verifies if a formal model satisfies the properties of the system. The properties can be expressed with the same formalism as the model. In this case we talk about *equivalence checking*. Otherwise, if the properties are expressed in a different formalism than the model, then we talk about *model checking*.

Model checking has several industrial successes due to its powerful debugging capabilities and its easier integration within the industrial development cycle compared to theorem proving. The most critical issues of formal verification are the state explosion problem and the fact that it is hard to deal with parameterized systems. The application of basic

formal methods at the RTL¹ level are limited to designs of up to 500 flip-flops [Kyu03]. To overcome those limitations, several approaches are proposed in the literature using techniques based on reachability analysis [VGS12], design state abstraction [CTVW04], design decomposition [JOS⁺01], or state projection [McM00].

Concretely, we use the CADP toolbox [GLMS13] for the analysis of system-level cache coherency in a heterogeneous SoC. We are interested in applying and illustrating the feasibility of the following formal methods on an industrial case study: process calculi (in particular the modeling language LNT [CCG⁺14]), explicit-state model checking (with a value-passing extension of modal μ -calculus), equivalence checking (based on bisimulation and simulation preorder relations), and test case generation based on a sound theory (namely, model-based testing and input-output conformance).

As a first step, we develop a generic formal LNT model of an SoC, including an ACE-based cache coherent interconnect and abstractions of master and slave components (e.g., processors and shared memory). This model is a system-level representation of the specified behavior, in the sense that the model focuses on the interactions between the components of the system, preserving their order. Our model considers a communication on a hardware interface channel to be atomic. This model can be considered as a high-level formal specification of the ACE protocol. The model is parametric and can be instantiated with different configurations (number of masters, number of cache lines, and number of memory lines) and different sets of supported ACE transactions. We use a constraint-oriented specification style to model the global requirements of the ACE specification, which must be guaranteed by any implementation. The LNT model enables STMicroelectronics architects to interactively simulate a coherent SoC at system level. We also express several correctness properties in the MCL language [MT08] and check them on the LNT model using the EVALUATOR 4.0 model checker.

To benefit from the formal verification of the model of the ACE-based SoC (i.e., modeling the behavior allowed by the specification) in a concrete industrial case study, we explore the generation of tests in a semi-formal test bench. A semi-formal test bench is a simulation test bench enhanced by *assertions* expressed by formal checks. These assertions monitor the behavior of the system triggered by tests. However, the success of semi-formal verification, both in terms of total effort spent and final verification coverage achieved, depends heavily on the quality of the tests executed during simulation. Effective tests can achieve higher verification coverage in shorter time, saving engineering resources and improving confidence in the quality of the *Design Under Verification* (DUV).

Automatic test generation using model checking is one of the most promising approaches for high-quality test generation. However, for large designs, model checking rapidly faces state explosion when considering hardware protocols in all their details. We propose to generate directed “abstract” tests from our formal model, using a test

¹Register Transfer Level

generator implementing model-based testing techniques issued from the *test conformance* theory [Tre92]. We take advantage of the counterexamples extracted by *model checking* from the formal model to generate interesting configurations of the model. Those configurations are used for automatic generation of abstract test cases. Then, the abstract test cases are refined (by introducing randomization) to “concrete” tests, which can be run on an RTL level test bench, taking advantage of an industrial *coverage-directed test generation* (CDTG) solver.

Furthermore, we apply cross-checking techniques to validate and complete an *interface verification unit* (IV unit) consisting in a formal checks list (used for formal coverage). We apply *equivalence checking* techniques to compare our formal model and a parallel composition of the formal checks.

Notice that the hardware design community has its proper terminology. In hardware design, the term verification denotes a large set of techniques (including emulation, simulation, rapid prototyping, and testing) to detect design mistakes; these techniques are not necessarily formal, and one must use the term formal verification when referring to mathematically based techniques [Gar13]. The verified system is generally called *Design Under Test* (DUT): the system in this case is a design. The expression “test” is used due to the large use of testing techniques in the hardware verification context. With the generalization of verification approaches in hardware context, the terminology *Design Under Verification* (DUV) is increasingly used. In other contexts, different terminologies are used to name the verified system. For the Model-Based Testing (MBT) community, it is named the *System Under Test* (SUT). In fact, the system can be either a software program or a hardware design, and the activity in MBT is restricted to testing. In formal verification we speak about the *system under verification* (SUV), which is more general because it includes software and hardware, as well as all verification activities. In order to avoid confusion, we will use the expression *Design Under Verification* (DUV) in all parts of the thesis, because, we are interested in different verification activities, including, but not restricted to, testing, applied to a hardware design.

1.1 Contributions

The principal contributions of this thesis are the following.

1. Producing a parametric formal model of an industrial case study [KS13], applying relevant abstractions to balance between automatic extraction of relevant verification reports and state space explosion problems. A large Petri net derived from our LNT model was provided as Model Checking Contest 2014 benchmark².
2. Using the parametrization of our formal model in order to produce a comprehensive

²<http://mcc.lip6.fr/pdf/ARMCaCheCoherence-form.pdf>

set of counterexamples of a property rather than a unique counterexample. As a result, it becomes possible to provide all the scenarios triggering a violation of the property [KS15].

3. Proposing a two-step approach to use model-based testing in order to generate clever semi-directed system level test cases from temporal logic properties. We use CADP to generate directed “abstract” system-level test cases, which are then refined with a commercial CDTG solver into interface-level “concrete” test cases that can be executed at RTL level [KS15].
4. We also propose the notion of a *system verification unit* (SV unit) to measure the coverage and verdicts of system-level properties. The SV unit is added to the semi-formal test bench and it is connected to all interfaces of the system. This SV unit is implemented by *Property Specification Language* (PSL) [oEE10] formal checks [KS15].
5. Proposing a way to assess the sanity of an industrial *interface verification unit* (IV unit), consisting of a set of behaviors to cover. In our study, we focus on the complex behaviors expressed by so-called *checks* of a commercial IV unit. Our solution enabled us to discover a missing check in a widespread commercial verification unit [KS15].

An interesting industrial contribution consists in finding a major limitation twenty months before it is confirmed by other approaches. In addition, our other contributions allow us to produce the list of all scenarios triggering this limitation and to propose a possible solution for each scenario.

1.2 Outline

This thesis is organized as follows. The first part presents a general background and the state of the art. Chapter 2 presents the background concepts used in this thesis. Chapter 3 surveys the state of the art of the formal verification applications in hardware design.

The second part of the thesis presents the formal modeling of a system-level cache coherent SoC. Chapter 4 introduces the s [AFV01]system-level cache coherency as well as its recent standard AMBA 4 ACE specification. Chapter 5 presents our first contribution consisting in a formal model of an AMBA 4 ACE-based SoC.

The third part of the thesis displays the different exploitations of the formal model. Chapter 6 presents the verification of global properties of the system using explicit-state model checking. Chapter 7 exhibits our test generation methodology based on model checking counterexamples (i.e., contributions 2, 3, and 4). Chapter 8 describes the

Chapter 1. Introduction

validation and completion of an industrial IV unit using equivalence checking. Besides, we present the experimental results and the industrial impact of our work as a section at the end of each Chapter.

Background and State of the Art

Chapter 2

Background Concepts

In this chapter we present the background concepts of our thesis. We start by presenting the underlying LTS (Labeled Transition System) model as well as the process calculus formalism used to describe LTSs. After that, we explore the principal concepts needed to understand the different formal techniques used in the scope of this thesis, namely model checking, equivalence checking, and model-based testing. Finally, we introduce the CADP toolbox, which offers an implementation for several formal methods techniques.

2.1 Labeled Transition Systems

Intuitively, a *Labeled Transition System* (LTS) is a state/transition graph, in which the states do not provide information except the indication of the initial state. The information is represented in the labels or actions related to transitions. Figure 2.1 shows some examples of LTSs.

Formally, an LTS is a formalism used as the basis for describing the behavior of processes such as specifications, implementations, and tests.

Definition 2.1.1. *An LTS is a quadruple $M = (Q, A, T, q_0)$ where:*

- Q is a the set of states;
- A the set of actions (transition labels); the set A contains the invisible action τ , which denotes internal (unobservable) activity.
- $T \subseteq Q \times A \times Q$ is the transition relation;
- $q_0 \in Q$ is the initial state.

A transition (p, a, q) in T (also noted $p \xrightarrow{a} q$) means that the system can evolve from

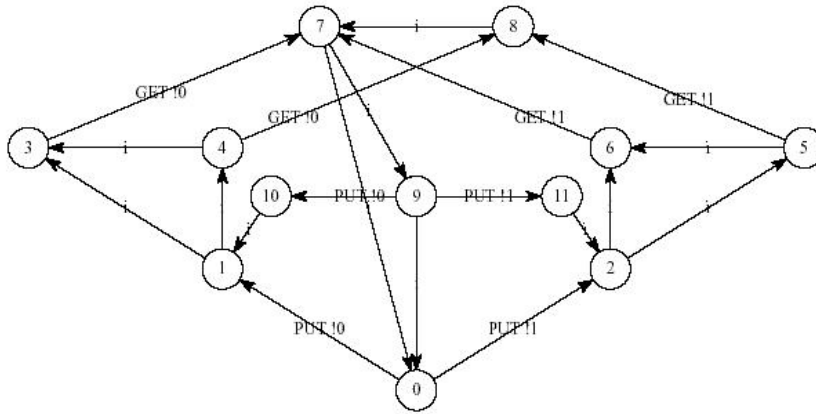

Figure 2.1 – LTS example

state p to state q by performing action a . If W is a language included in A^* , then $p \xrightarrow{W} q$ denotes a transition sequence $p \xrightarrow{a_1} q_2 \xrightarrow{a_2} \dots \xrightarrow{a_n} q$ such that the word $a_1 a_2 \dots a_n$ belongs to W . All states q of Q are assumed to be reachable from the initial state q_0 via sequences of transitions in T (i.e., $q_0 \xrightarrow{A^*} q$). In the sequel, visible actions of A are denoted by a , and (both visible and invisible) actions of A are denoted by b .

An LTS with the distinction between input and output actions is called an *Input-Output Transition System* (IOTS). Input actions are actions from user to machine. Output actions are actions from machine to user. IOTS have the property that any input action is always enabled in any state. $IOTS(L_i, L_u)$ is the class of input-output transition systems with inputs in L_i and outputs in L_u . (L_i, L_u) is a partition of the set of labels L of $IOTS(L_i, L_u)$, i.e., $L_i \cap L_u = \emptyset$ and $L_i \cup L_u = L$ [Tre99].

For large systems, it is impractical to describe explicitly the LTS of the system. Thus, we use higher level formalisms, such as process calculi issued from concurrency theory, in order to describe LTSs.

2.2 Process Calculi

Process Calculi (also called *process algebras* [AFV01]) represent a family of formalisms proposed by concurrency theory.

The word *process* refers to a behavior of a system, for instance the execution of a software system, the actions of a machine or even the actions of a human being. Behavior is the set of events or actions that a system can perform, the order in which they can be executed and maybe other aspects of this execution such as timing or probabilities. In general, we describe only certain aspects of the behavior, disregarding other aspects: we are considering an abstraction or idealization of the “real” behavior. We can say that we

have an observation of the behavior. We call *action* the chosen unit of observation.

Process calculi provide means for a high-level description of interactions, communications, and synchronizations between a set of independent components of a concurrent system. They also provide laws to describe, manipulate, and analyze processes.

Process calculi are characterized by the following main features:

- Representing interactions between independent processes as communication (message-passing on communication gates), and not the modification of shared variables. This corresponds to a *black box view* of the system. In fact, the system can be analyzed by observing the communications between the components of the system instead of the state of the internal variables of the system (used in a *white box view*).
- Describing processes and systems using a small set of primitives and operators in order to combine those primitives. (Primitives and operators are defined in the grammar of each process calculus language).
- Using *interleaving semantics* for compositions of processes. If two processes A and B execute respectively an action **a** and **b** in parallel, then the global behavior (represented by an LTS) will have two possible paths: **a** then **b** and **b** then **a**. Two actions never occur at the same time (i.e., asynchronous semantics).

2.3 Equivalence Checking

The equivalence checking compares two graphs (e.g., LTSs) modulo an equivalence relation. In this thesis, we compare LTSs modulo several *bisimulation* relations. A bisimulation is a binary relation between states, associating states that behave in the same way.

Two LTSs $M_1 = (Q_1, A, T_1, q_{01})$ and $M_2 = (Q_2, A, T_2, q_{02})$ are related modulo an equivalence relation R (noted $M_1 R M_2$) if and only if their initial states are related modulo R (noted $q_{01} R q_{02}$).

For each equivalence R_{equ} , the corresponding preorder relation I_{equ} , which indicates whether a state p is “simulated” by a state q (resp. q is “simulated” by p) is obtained by keeping only condition 1 (resp. 2) in the definition of R_{equ} .

- *strong bisimulation* [Par81]: two states p and q are related modulo strong equivalence ($p R_{str} q$) if and only if:

1. for each transition $p \xrightarrow{b} p'$ in T_1

- there is a transition $q \xrightarrow{b} q'$ in T_2
such that $p' R_{str} q'$
2. for each transition $q \xrightarrow{b} q'$ in T_2
there is a transition $p \xrightarrow{b} p'$ in T_1
such that $p' R_{str} q'$
- *branching bisimulation* [vGW89]: two states p and q are related modulo branching equivalence ($p R_{bra} q$) if and only if:
 1. for each transition $p \xrightarrow{b} p'$ in T_1
 - (a) either $b = \tau$ and $p' R_{bra} q$, or
 - (b) there is a sequence $q \xrightarrow{\tau^*} q' \xrightarrow{b} q''$ in T_2^*
such that $p R_{bra} q'$ and $p' R_{bra} q''$
 2. for each transition $q \xrightarrow{b} q'$ in T_2
 - (a) either $b = \tau$ and $p R_{bra} q'$, or
 - (b) there is a sequence $p \xrightarrow{\tau^*} p' \xrightarrow{b} p''$ in T_1^*
such that $p' R_{bra} q$ and $p'' R_{bra} q'$
 - *divergence-sensitive branching bisimulation* (divbranching) [VGW96] differs from branching bisimulation only in the way cycles of internal transitions τ (also called divergences) are treated. It is known that all states present on a cycle of internal transitions belong to the same branching equivalence class. While divergences are eliminated in the LTS obtained by reduction modulo ordinary branching bisimulation, a self-looping internal transition is kept in each such equivalence class in the LTS obtained by divergence-sensitive branching bisimulation. Unlike branching bisimulation, divergence-sensitive branching bisimulation preserves inevitability properties.

Various algorithms are implemented to perform comparison of graphs or to minimize graphs according to a specific bisimulation.

2.4 Model checking

The *model checking* [CGP00, BK⁺08] verifies that a model satisfies a property expressed in a different formalism. In model checking, the system is described by a finite state model (e.g., an LTS) and the properties are expressed in temporal logic. Model checking verifies formally whether the model satisfies a property by automatic exhaustive search over the state space.

A model checker is a software tool that, given a description of a model M and a property φ , decides whether M satisfies φ . The model checker returns *True* if the property is

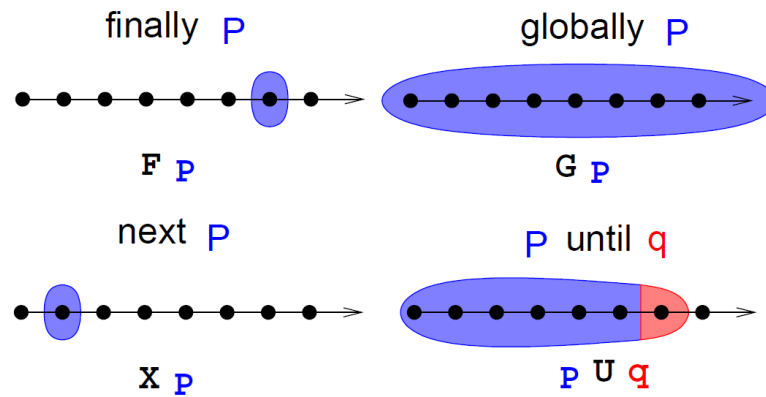

Figure 2.2 – LTL operators

satisfied, otherwise it returns *False*, and provides a counterexample. It can also provide a witness when the property is satisfied.

2.4.1 Temporal Logic Languages

A *Temporal Logic* is a system of rules and symbols for representing, and reasoning about, propositions qualified in terms of time. In a temporal logic we can express statements like “an event A is always possible”, “an event A will eventually happen”, or “an event A is always possible until an event B happens”. Numerous temporal logics were proposed in the literature. Two principal families of temporal logics are *linear time logics* [Pnu77] and *branching time logics* [BAPM83].

- The *Linear time temporal logic* (LTL¹) is a modal temporal logic with modalities referring to discrete time (natural numbers). LTL operators are evaluated over sets of paths, i.e., over infinite, linear sequences of states: “ $s[0] \rightarrow s[1] \rightarrow \dots \rightarrow s[t] \rightarrow s[t+1] \rightarrow \dots$ ”, where $s[t]$ expresses the t^{th} state of a sequence. LTL provides the following temporal operators (illustrated graphically in Fig. 2.2):
 - “Finally” (or “future”): “ $F p$ ” is true in $s[t]$ if and only if p is true in some $s[t']$ with $t' \geq t$.
 - “Globally” (or “always”): “ $G p$ ” is true in $s[t]$ if and only if p is true in all $s[t']$ with $t' \geq t$.
 - “Next”: “ $X p$ ” is true in $s[t]$ if and only if p is true in $s[t+1]$.
 - “Until”: “ $p U q$ ” is true in $s[t]$ if and only if q is true in some state $s[t']$ with $t' \geq t$ and p is true in all states $s[t'']$ with $t \leq t'' < t'$.

¹Linear Temporal Logic

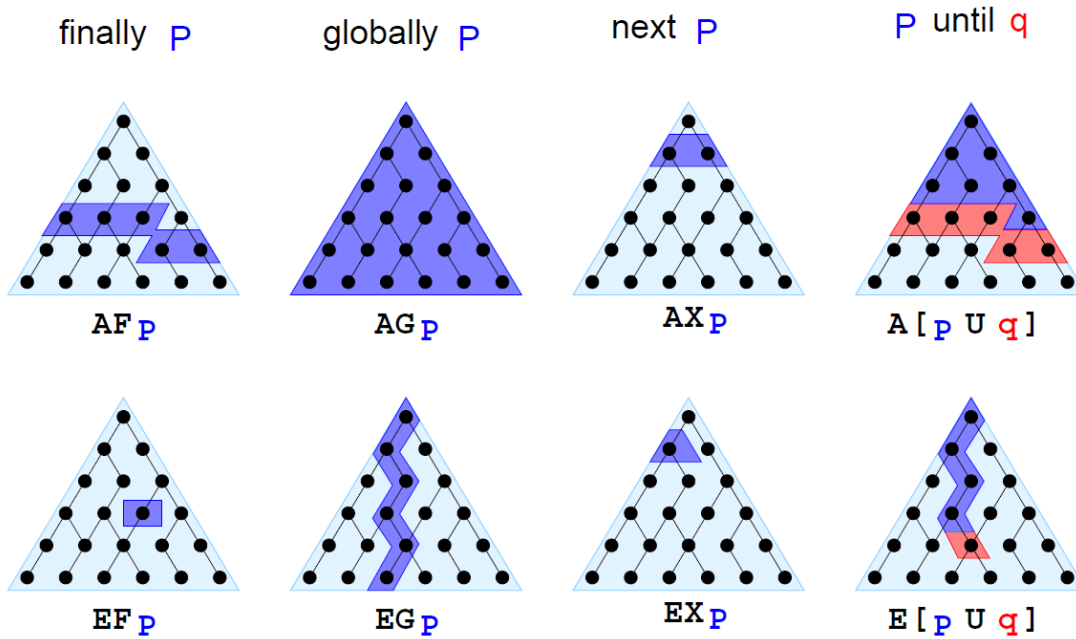

Figure 2.3 – CTL operators

- *Branching time temporal logic* (CTL² and its variants) considers a tree-like structured model of time, in which the future is not determined; there are different paths in the future, any one of which might be an actual path that is realized. CTL operators (illustrated graphically in Fig. 2.3) are evaluated over trees. Every temporal operator (F; G; X; U) is preceded by a path quantifier (A or E), where A expresses universal modalities (or necessity) (AF; AG; AX; AU): the temporal formula is true in all paths starting in the current state; and E expresses existential modalities (or possibility) (EF; EG; EX; EU): the temporal formula is true in some paths starting in the current state.

In this thesis, we use a branching time temporal logic. To explain the interest of this temporal logic in comparison with the widely used linear logic, we present the classical example of the coffee machine.

Example 1 Figure 2.4 shows the LTSs of two coffee machines (a) and (b). The machine (a) works properly: once the 30cts is supplied, the machine is in a state in which one can choose **Coffee** or **Tea**. For the machine (b), when the sum of 30cts is supplied, the machine passes non-deterministically to one of the two states: a state in which the machine can only provide **Coffee** and another state in which the machine can only provide **Tea**. The branching time logic can detect that there is a state in which machine (b) cannot provide **Tea** and another in which it cannot provide **Coffee**. In linear time

²Computation Tree Logic

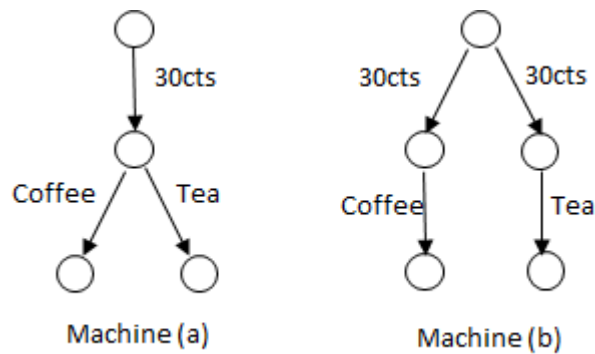

Figure 2.4 – Coffee machine example

logic, the two machines (a) and (b) have equivalent traces: $\{30\text{cts}, \text{Coffee}\}$ and $\{30\text{cts}, \text{Tea}\}$. In this logic, we can never detect that the machine (b) contains a state in which we can never have **Coffee** and another state in which we can never have **Tea**.

2.4.2 Propositional Mu-Calculus

The μ -calculus [Koz83] has generated much interest among researchers in computer-aided verification. This interest stems from the fact that many temporal and program logics can be encoded into the μ -calculus. Another source of interest in the μ -calculus came from the existence of efficient model checking algorithms for this formalism. As a consequence, verification procedures for many temporal and modal logics can be described by translation into μ -calculus. A considerable amount of research has focused on finding techniques for evaluating such formulæ efficiently, and many algorithms have been proposed for this purpose.

The propositional μ -calculus is a powerful language for expressing properties of transition systems. The letter μ reminds that the μ -calculus is a logic capable of expressing least and greatest solutions of fixpoint equations $X = f(X)$, where f is a monotone function mapping some powerset into itself. The μ and ν operators are used to express least and greatest fixpoints, respectively. Precisely, the notation $\mu X.f(X)$ is used for the least fixpoint of the function f , and the notation $\nu X.f(X)$ is used for the greatest fixpoint of f [Len05].

Variables in the μ -calculus can be either *free* or *bound* by fixpoint operators. Closed formulæ are the formulæ without free variables. The intuitive meaning of the formula $\langle a \rangle f$ is “it is possible to make an **a**-transition to a state where f holds”. Similarly, $[a] f$ means that “ f holds in all states reachable (in one step) by making an **a**-transition. The empty set of states is denoted by *False*, and the set of all states S is denoted by *True* [?].

2.4.3 Symbolic Model Checking

Symbolic model checking is a technique to fight the problem of state explosion. Instead of enumerating reachable states one at a time, the state space can sometimes be traversed much more efficiently by considering large numbers of states at a single step. In symbolic model checking the states are manipulated as sets and the transition relations are expressed as formulæ. The two principal symbolic model checking techniques are *Binary Decision Diagrams* (BDD) and *Propositional Satisfiability Checkers* (SAT solvers).

Binary Decision Diagrams (BDD)

BDDs enabled handling much larger concurrent systems (usually, an order of magnitude increase in the hardware case) [BCM⁺90, McM93]. In popular usage, the term BDD almost always refers to *Reduced Ordered Binary Decision Diagram* (ROBDD), which are used when the ordering and reduction aspects need to be emphasized. The advantage of an ROBDD is that it is canonical (unique) for a particular function and variable order. A variety of properties characterized by least and greatest fixed points can be verified purely by manipulations of these formulæ using ROBDD [McM93].

Example 2 Consider building a BDD for the function f defined by the equation:

$$f(a_1, a_2, b_1, b_2, c_1, c_2) = (a_1 \oplus a_2) \text{ and } (b_1 \oplus b_2) \text{ and } (c_1 \oplus c_2)$$

first with variable ordering (A) $a_1 < a_2 < b_1 < b_2 < c_1 < c_2$ and then with (B) $a_1 < b_1 < c_1 < a_2 < b_2 < c_2$. The BDD with the first ordering is in Fig. 2.5(A) and the one with the second ordering is in Fig. 2.5(B). The size ratio of the second BDD to the first BDD is 23:11, more than a 100% increase.

In the first ordering, (A) $a_1 < a_2 < b_1 < b_2 < c_1 < c_2$, when $a_1 = a_2$, the function value is completely determined to be 0 regardless of the values of the other variables. Therefore, two paths have only two variable nodes, a_1 and a_2 . Similarly, $b_1 = b_2$ or $c_1 = c_2$ completely determine the value of the function. Thus, we observe that when the variables are ordered together early that completely determine the value of the function, fewer nodes appear on the paths from BDD root to constant roots, and hence a simpler BDD results. Thus, we observe that when the variables are ordered in a clever order, the value of the function is completely determined earlier, fewer nodes appear on the paths from BDD root to constant roots, and hence a simpler BDD results.

If a_1 and a_2 are not equal, then the function is determined solely by the remaining variables without retaining any knowledge of the specific values that a_1 and a_2 have taken. In other words, $b_1 = b_2$ or $c_1 = c_2$ alone determines the value of the function for all unequal values of a_1 and a_2 . Therefore, we see that variables b_1 and c_1 are being shared

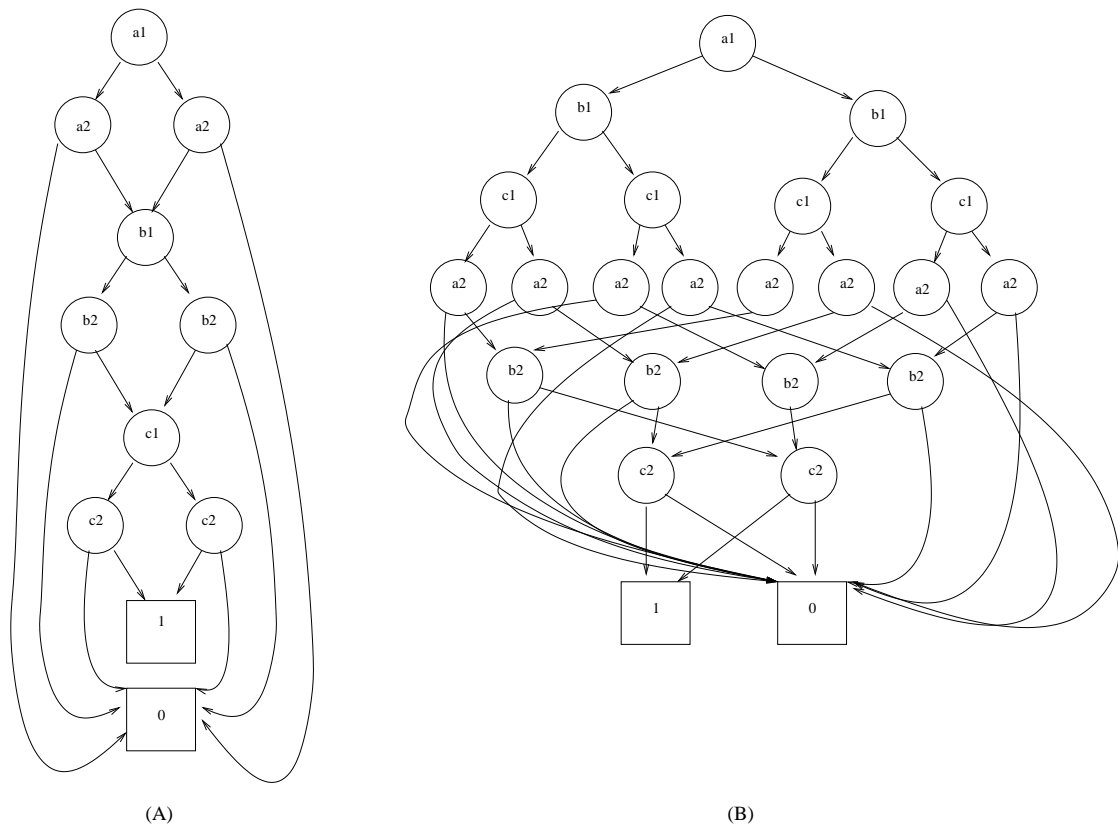

Figure 2.5 – Impact of variable ordering on BDD size

by the two paths that represent $a_1 = 1, a_2 = 0$ and $a_1 = 0, a_2 = 1$. We observe that the less knowledge about previous variable assignment is required to determine the function value the more nodes are shared. More sharing gives smaller BDDs.

In the second ordering, (B) $a_1 < b_1 < c_1 < a_2 < b_2 < c_2$, the earliest time the function value is decided is when four variables are assigned values, which is worse than the situation from the first ordering. If the values assigned to the first four variables do not determine the function value, some already assigned values need to be remembered to assign values to the remaining variables. Therefore, this ordering produces a larger BDD size.

SAT solving

SAT-based techniques [SLM⁺92, GW95] are widely used in the hardware community. These techniques concern the problem of determining if the variables of a given Boolean formula can be consistently replaced by the values **True** or **False** in such a way that the formula evaluates to **True**. If this is the case, the formula is called satisfiable. Otherwise, if no such assignment exists, the function expressed by the formula is equivalent to **False**

for all possible variable assignments and the formula is unsatisfiable. For example, the formula "a and not b" is satisfiable because one can find the values $a = \text{True}$ and $b = \text{False}$, which make $(a \text{ and not } b) = \text{True}$. In contrast, "a and not a" is unsatisfiable. Despite the fact that no algorithms are known that solve SAT efficiently, correctly, and for all possible input instances, many instances of SAT that occur in practice, especially in circuit design, can actually be solved rather efficiently using heuristic SAT-solvers. Such algorithms are not believed to be efficient on all SAT instances, but experimentally these algorithms tend to work well for many practical applications and specially in hardware applications.

Bounded Model Checking

The main idea of *Bounded Model Checking* [BCC⁺03] technique is to look for counterexample paths of increasing length k , in order to guide the model checking to find bugs. For each k , a boolean formula is built, which is satisfiable if and only if there is a counterexample of length k . The satisfiability of the boolean formulæ is checked using a SAT procedure. This technique can manage complex formulæ on hundreds of thousands of variables and returns a satisfying assignment (i.e., a counterexample).

Different model checking algorithms are proposed in the literature for symbolic model checking: fix-point model checking (historically, for CTL), bounded model checking (historically, for LTL), invariant checking, etc.

2.4.4 Explicit-State Model Checking

After around three decades of symbolic model checking, the explicit-state model checking still proposes solutions for complex systems with the ability to use compositional verification and on-the-fly verification. Our thesis is based on this branch of model checking techniques.

Compositional verification

Compositional verification is a way to avoid state explosion for the explicit-state verification of complex concurrent systems. This approach assumes that the concurrent system under study can be expressed as a collection of communicating sequential processes. Process calculi (such as LNT) are suitable for compositional verification, because of their appropriate parallel composition operators and concurrency semantics. Compositional verification consists in replacing each sequential process by an equivalent one, smaller than the original process but still preserving the properties to be verified on the whole system. Quite often, this is done by minimizing the process LTS modulo an appropriate equivalence relation (e.g., a bisimulation relation, such as strong or branching equiva-

lence). If the system has a hierarchical structure, minimization can also be applied at every intermediate level in the hierarchy. Clearly, this approach is only possible if the equivalence relation considered is a congruence with the parallel composition operator. It may be counter-productive in some other cases: generating the LTS of each process separately may lead to state explosion, whereas the generation of the whole system of concurrent processes might succeed if processes constrain each other when composed in parallel [KM97].

On-the-fly verification

On-the-fly verification consists in analyzing the correctness of a concurrent system by constructing and exploring its state space incrementally. This provides a way to fight against state explosion, enabling the detection of errors in systems with large state spaces [Mat03]. In on-the-fly verification, the state space is constructed in a demand-driven way, therefore enabling the detection of errors in large systems. The efficiency of on-the-fly verification depends on the used property and the model maturity. In fact, on-the-fly verification is more interesting in the debug phase, enabling to detect counterexamples without generating the global state space. When the property is satisfied, the (compositional) generation of the state space and the verification of the generated LTS can be more practical than on-the-fly verification.

2.5 Model-Based Testing

When we achieve a good confidence on the formal model of the specification, one can consider to check the conformance of the DUV (i.e., implementation) against the formal model. This can be carried out by generating tests from the model. This activity is called *Model-Based Testing* (MBT). It is important to recall that the purpose of such test suites is to check the DUV, not the specification model itself, which is assumed to be correct.

Some MBT techniques use the theory of *conformance testing* [Tre92]. According to this theory, the DUV is conform to the model if and only if the DUV passes all tests generated from the model. In our context, we are interested in MBT using LTSs and the *input/output conformance* (*ioco*) relation proposed by the conformance testing theory. If the DUV *ioco* the LTS model then the DUV passes the generated tests. Thus, the *ioco* relation is *sound*. If the DUV passes all the generated tests then the DUV *ioco* the LTS model. Thus, the *ioco* relation is *exhaustive*. Although in practice, it is infeasible to generate all the tests. The DUV behaves as input-enabled LTS (i.e., IOTS).

2.5.1 Definition of *ioco* Relation for IOTS

Intuitively, i *ioco*-conforms to s , if and only if:

- if i produces output x after trace σ , then s can produce x after σ .
- if i cannot produce any output after trace σ , then s cannot produce any output after σ (quiescence δ expresses the absence of output).

Definition 2.5.1. [dVT01] *The ioco relation is a relation relating an IOTS to an LTS:*

$$\text{ioco} \subset \text{IOTS}(L_i, L_u) \times \text{LTS}(L_i \cup L_u)$$

Observing with environment outputs, and vice versa, the *ioco* relation is defined as follows:

$$i \text{ ioco } s =_{\text{def}} \forall \sigma \in \text{Straces}(s) : \text{out}(i \text{ after } \sigma) \subset \text{out}(s \text{ after } \sigma)$$

where:

- $\text{Straces}(s) = \{\sigma \in (L \cup \{\delta\})^* \mid s \xrightarrow{\sigma}\}$
- $p \text{ after } \sigma = \{p' \mid p \xrightarrow{\sigma} p'\}$
- $\text{out}(P) = \{x \in L_u \mid p \xrightarrow{x}, p \in P\} \cup \{\delta \mid p \xrightarrow{\delta}, p \in P\}$
- $p \xrightarrow{\delta} p \equiv \forall x \in L_u \cup \{\tau\}. p \not\xrightarrow{x}$

A test suite is valid if this test suite detects the non conformity:

$$i \text{ not ioco } s \Leftrightarrow \exists t \text{ i fails } t$$

where i represents the implementation (i.e., DUV), s the specification (i.e., model), and t a test.

2.5.2 Test Generation and Test Execution for LTSs

For LTS models, a test case is a transition system with labels in $L \cup \{\theta\}$. The 'quiescence' label θ expresses the timeout and is a translation of the absence of output (δ) in the IOTS [Tre96]. The test case transition system is tree-structured, finite, and deterministic. It contains sink states, which are PASS and FAIL states. From each state we have either one input $!\alpha$ and all outputs $?x$ or all outputs $?x$ and θ .

Several algorithms have been proposed to generate tests [Tre99, FJJV96, JJ05]. A typical algorithm generates a test by a finite number of recursive applications of one of the three following non-deterministic choices. The first choice consists in terminating the test by selecting a PASS state. The second choice consists in giving a next input α to

the implementation and applies recursively the algorithm. The third choice consists in selecting non-deterministically one among all the outputs and the timeout θ label (absence of output). If the selected output or θ is allowed at the current state, then the test recalls the algorithm recursively. If the selected output or θ is not allowed at the current state, then the test goes to the **FAIL** state.

To cope with non deterministic behavior, tests are not linear traces, but trees. Furthermore, in order to execute tests, we have to deal with all possible parallel executions (test runs) of test t with implementation i going to state **PASS** or **FAIL**.

2.5.3 Test Selection in Model-Based Testing

In practice, exhaustiveness is never achieved. We have to select a subset of “comprehensive” test suites to achieve confidence in the quality of the tested product (DUV in our case). We want to select the best test cases capable of detecting failures and to measure to what extent testing was exhaustive (i.e., coverage). This leads us to an optimization problem: we seek the best possible testing, but within cost/time constraints. In order to tackle this issue, different test selection approaches were proposed in the literature: random test selection, coverage-oriented selection, or domain specific selection using *test purposes* [dVT01].

Conventional testing tools often have problems in handling nondeterminism and only explore a small subset of feasible paths. Model checkers do not have this problem, as they are designed to systematically explore all reachable states of the system. It is therefore tempting to enhance testing with the capabilities of model checking, an idea expressed in [JW96]. In the literature, dedicated test generation tools have been developed using exhaustive state-space exploration of the model to produce test cases. The exploration capabilities are derived from model checking algorithms (e.g., TGV [FJJV96, JJ05]). Some of these test generation techniques use the notion of a *test purpose*, which is specified as traces or automata (e.g., LTS) derived from high-level requirements.

A test purpose guides the exploration of the specification model to have more focused test cases. Intuitively, it is a means to characterize those states (called **ACCEPT** states) of the specification that should be reached during test execution. To prune the search space for test cases, the test purpose can also contain so-called **REFUSE** states: if such a state is reached while testing the DUV, the test is stopped and declared inconclusive. Technically, a test purpose is provided as an LTS.

2.6 CADP Toolbox

CADP (Construction and Analysis of Distributed Processes)³ [GLMS13] is a widespread toolbox for the design and verification of asynchronous concurrent systems. CADP supports, among others, the process calculus LNT for specification, and offers various tools for simulation and formal verification, including equivalence checkers (bisimulations) and model checkers (temporal logics and modal μ -calculus).

CADP is designed in a modular way and puts the emphasis on intermediate formats and programming interfaces (such as the BCG and OPEN/CAESAR software environments), enabling to combine CADP tools with other tools and adapting to various specification languages. CADP implements a large spectrum of research results of concurrency theory, focusing on process calculus languages, namely LOTOS and the recent LNT language.

CADP is developed by the CONVECS team of Inria (until January 2012, by the VASY team). It is maintained, regularly improved, and used in many industrial projects. Today, CADP contains around fifty tools and more than a dozen libraries.

2.6.1 Representing LTSs in CADP

CADP provides two different representations of an LTS:

- An *explicit* LTS is an enumerative representation of states, transitions, and labels. CADP provides the BCG (Binary Coded Graphs)⁴ format and libraries. The BCG format is an optimized storage format for storing large LTSs (up to 2^{44} states). CADP provides a set of tools and libraries to manipulate BCG files.
- An *implicit* LTS is defined in comprehension by giving its initial state and a function “post” to calculate its successors. This allows to verify a specification on-the-fly without generating the LTS explicitly. CADP provides the Open/Caesar API for manipulating implicit LTSs, which is independent of the language in which the implicit LTS is expressed.

2.6.2 Modeling Language LNT

LNT [CCG⁺14] (a shorthand for “LOTOS New Technology”) is a modern formal specification language that has been designed and implemented in the CADP toolbox since 2005. LNT is intended to be concise, expressive, easily readable, and user-friendly. LNT combines the best features of process calculi, functional programming languages, and imperative programming languages. The semantics of an LNT model is defined as an

³<http://cadp.inria.fr/>

⁴The acronym BCG refers both to a format and a software environment.

LTS, following a black box view of the system. The LNT.OPEN tool translates an LNT model into an LTS suitable for (on-the-fly) verification. At present, LNT is implemented by translation to LOTOS [ISO89, BB88].

Example 3 Figure 2.6 presents an example of an LNT module `cpu`, which contains an example of an LNT process `cpu_read`. This process can send an address read request and can receive read data responses. The process waits the read data response before resending another address read request. This process communicates on two LNT gates `AR` (i.e., Address Read) and `R` (i.e., Read data). The gates are typed by LNT channels (respectively, `AW_CHANNEL` and `W_CHANNEL`). An LNT channel defines the number and types of parameters of the gate. A gate can be defined without a specific channel (i.e., the channel is set to `any`) or a channel without parameters (i.e., the channel is set to `none`). The `cpu_read` process has one value parameter `port` used to identify the `cpu`.

The process defines three local variables, `memory_line` referring to the index of the memory line, `data` corresponding to the data contained in the memory line, and the boolean `read_in_progress` expressing if a read transaction is in progress or not. When starting, the process `cpu_read` initializes the variables `memory_line` and `read_in_progress`. The remaining behavior of the process consists in an infinite loop containing a non-deterministic choice between two branches, which is expressed by the `select` construct.

In the first branch of the `select` can be chosen only if the no read is in progress. In this case, the process can communicate on the gate `AR`, fixing the value for the three parameters: the transaction type is a `ReadOnce`⁵, the port of the `cpu` is `port`, and the memory line to read is `memory_line`. After achieving the communication on the gate `AR`, the `read_in_progress` variable is set to `true`.

In the second branch of the `select`, the process can communicate on the gate `R` and fixes two parameters: the transaction type is a `ReadOnce` and the port of the `cpu` is `port`. The parameters beginning by “?” are not fixed to a value: `?memory_line` accepts any `INDEX_MEM` and sets the variable `memory_line` to this value, and `?data` accepts any `DATA_T` and sets the variable `data` to this value. After achieving the communication on the gate `R`, the `read_in_progress` is set to `false`.

2.6.3 Temporal Logic Language MCL

The *Model Checking Language* (MCL) [MT08] is an extension of the modal μ -calculus with high-level operators aiming at improving expressiveness and conciseness of formulæ. The main ingredients of MCL are: parameterized fixed points, action patterns enabling to extract data values from LTS transition labels, modalities on transition sequences

⁵ReadOnce: is a transaction defined by ACE protocol and means that the `cpu` wants to read the data without keeping a copy of it.

```
module cpu (types) is
process cpu_read [AR : AR_CHANNEL, R : R_CHANNEL]
    (port : INDEX_CPU)
is
    var memory_line : INDEX_MEM,
        data : DATA_T,
        read_in_progress : bool
    in
        memory_line := INDEX_MEM(1);
        read_in_progress := false;
        loop
            select
                only if not (read_in_progress) then
                    AR(ReadOnce, port, memory_line);
                    read_in_progress := true
                end if
            []
            R(ReadOnce, port, memory_line, ?data);
            read_in_progress := false
        end select
    end loop
end var
end process
end module
```

Figure 2.6 – LNT module example

described using extended regular expressions and programming language constructs, and an infinite looping operator specifying fairness. The EVALUATOR 4.0 model checker of CADP can verify MCL properties on the fly, based on the local resolution of Boolean equation systems, and has a linear-time complexity for (data-less) alternation-free and fairness formulæ.

We can write (parameterized) macros to simplify the formulæ.

The MCL formulæ used in this thesis specify either *liveness* or *safety* properties. A liveness property expresses that something good eventually happens. A safety property expresses that something bad never happens. We present an example of each.

Example 4 The following MCL formula encodes a liveness property, that expresses inevitability, using the minimal fixed point operator (μ), which acts as binder for the propositional variable X . This formula states that all transition sequences starting after an action AR eventually lead to an action R after a finite number of steps.

```
[ true * . {AR} ]
mu X . ( < true > true and [ not {R} ] X )
```

Example 5 The following MCL formula encodes a safety property, which expresses that if an action R happens, then while there is no action AR , no other action R may happen.

```
[ true * .
  {R} .
  ( not {AR} ) * .
  {R}
] false
```

2.6.4 Script Verification Language (SVL)

Verification scenarios can be complex, repetitive, and require the use of several tools and techniques provided by CADP. In this respect, CADP proposes a *Script Verification Language* (SVL) [GL01] dedicated to the description of verification scenarios. SVL launches automatically the needed tools of CADP and includes Shell commands, that are preceded by “%”.

Chapter 3

State of the Art: Formal Validation of Hardware

The correct design of complex hardware poses serious challenges. Economic pressures in rapidly evolving markets demand short design cycles while increasing complexity of designs makes simulation coverage less and less complete. Bugs in a design that are not discovered in early design stages can be costly, and bugs that remain undetected until after a product is shipped can be extremely expensive. The most widely used techniques in hardware verification are based on simulation. To improve verification of complex hardware designs, two principal axes are explored: on one side, methodologies proposed to enable a faster simulation speed, e.g., hardware-accelerated simulation and emulation; on the other side, methodologies proposed to enable a bigger coverage than simulation. These methodologies introduce formal and semi-formal verification based on formal methods.

(Software) simulation is a dynamic verification method. The bugs are found by running the design implementation. Thoroughness of the simulation depends on the tests in use. Some parts are tested repeatedly while other parts are not even tested. There is a speed gap between the speed of software simulation and real silicon vastness:

$$\text{Simulation speed} = C * \text{speed of the simulation engine} / \text{size of circuit simulated}$$

where C is a constant

A track that has been explored is to improve the speed of the simulation. For this purpose, *hardware-accelerated simulation* is often used, by moving the time-consuming part of the design to hardware. Usually, the software simulation communicates with an

FPGA-based¹ hardware accelerator. The limitation of this solution is the dependency on the speed of the communication between simulator and hardware. To accelerate more and more (i.e., up to 1000 times faster than simulation), *Emulation* is used; imitating the function of another system to achieve the same results as the imitated system. Usually, the emulation hardware comprises an array of FPGA's and an interconnection scheme among them.

Example 6 A formal specification can be useful in emulation. In the context of the Polykid project² [GVZ01], a missing hardware component (precisely, an ASIC³) was replaced by a software program generated from a formal LOTOS model, running on a PowerPC microprocessor.

It was recognized that conventional simulation does not provide sufficient quality assurance and must be supplemented by formal methods [Fou88]. In fact, approaches combining formal and simulation techniques are required. Since then, formal verification tools are more and more introduced in the hardware design flow due to their capability to detect errors earlier than other techniques. Two formal techniques are often used in hardware validation: *theorem provers* which use a deductive approach based on rules of inference and *model checking* which uses an algorithmic approach based on exhaustive exploration of the behavior of the system. In addition to that, *model-based testing* can be used as a bridge connecting the formal verification of the specification and the simulation-based verification of the implementation.

3.1 Use of Formal Verification

Hardware design typically starts with a high-level informal specification (i.e., block diagrams, tables, and English text) expressing the desired functionalities. The formal verification of hardware requires the existence of formal descriptions for both design and specification. These methods assure 100% coverage, but in practice, work only for small-size finite state systems.

The time required for formal verification must be considered when applying these techniques to a real project. There are highly automated formal methods comparable to traditional simulation. Although formal verification methods are employed in the design of several state-of-the-art microprocessors and other complicated chips, we are not aware of a complete top-to-bottom verification for such a design. The cost of such verification still appears to be prohibitive. Formal methods can be beneficial even if a complete top-to-bottom verification is not carried out: the exercise of formalizing the requirements

¹Field-Programmable Gate Array

²Polykid was a Bull project concerning a multiprocessor architecture based on PowerPC, using CC-NUMA memory model and two cache coherency levels.

³Application Specific Integrated Circuit

or a high-level specification can be useful in itself because it tends to clarify many aspects. It is noticed that hardware engineers acquire a deeper understanding of the design when formal methods are used. In fact in this case, a greater effort of abstraction is needed, a more precise specification of the environment assumptions is required, and a description of the properties relating inputs and outputs is intended [Gar13]. To achieve successful integration, formal methods must be applied in a way that ensures that they can keep up with the design flow [BCL⁺94]. If this is the case, formal methods can benefit from the design process significantly, as they allow conceptual errors in the design to be discovered early in the design process by verifying the high-level design against a set of requirements.

High-level descriptions can often be made concise enough to be tractable by automatic verification methods [BCL⁺94]. Finally, the cost of verification might be considered worthwhile for certain subsystems that are particularly difficult to design, while other “straightforward” modules can be treated with traditional methods [KG99].

3.1.1 Formal Verification using Model Checking

In the following, we present some examples of model checking tools used in the hardware field.

- SMV [McM99] is a widely used symbolic model checker, in which system descriptions are given in terms of a set of equations that determine the next-state relation; programs may be structured into parameterized modules. SMV model checks specifications given in CTL and CTLF. SMV uses hybrid decision diagrams (HDDs) [CFZ95] as the underlying data structure, which permits model checking of properties involving words, i.e., bit vectors interpreted as integers. The SMV model checker is used by Cadence® to validate hardware protocols [KNS01, RMK03].
- SPIN [Hol97] is a model checker targeted at the high-level verification of distributed systems. SPIN accepts model descriptions in the specification language PROMELA, which provides high-level constructs such as communication channels. Specifications are given in LTL and verified by an on-the-fly model-checking algorithm. For example, the SPIN model checker is used in the literature to validate hardware protocols [BED03].
- Mur ϕ [Dil96] is both a formal description language and an explicit state model-checking system. Specifications in Mur ϕ are given as simple safety properties, which are verified by explicit state space exploration. Mur ϕ uses a white box view of the system. In a white box view, the states of all variables are visible during the verification. In contrast, our approach based on LTSs uses a black box view, in which only the events are visible. Mur ϕ is based on a set of commands that are executed repeatedly in an infinite loop. The Mur ϕ is used in the literature to verify cache coherence protocols in a multiprocessor system design. [Che04].

Model checking the requirements, specified as temporal properties, requires that the model is small enough in order to be verified in the available CPU and memory resources. To this end, the design must be modeled and verified at a relatively abstract level. Otherwise, the design has to be divided to relatively small subsystems, where each of which is verified separately.

Example 7 At *gate level*, formal verification techniques are helpful to gain confidence in asynchronous circuits. Those circuits are complex to validate using conventional simulation. That is why formal methods are used to address their validation, in order to detect concurrency issues and to establish the correctness, if possible [SSTV07].

3.1.2 Formal Verification using Equivalence Checking

The equivalence checkers are often used in hardware design to compare a (golden) model⁴ with a refined model. Functional representations are extracted from the designs and compared mathematically. In the hardware community, tools such as *Formality* (SynopsysTM) [Sut06] and *FormalPro* (Mentor GraphicsTM) [Pra08] support equivalence checking. The equivalence checking can be applied in *inter-levels* cross verification performing a logical comparison of two hardware models.

Example 8 This technique is used to compare an RTL description with the corresponding gate-level synthesis in order to prove the absence of synthesis errors. Equivalence checking has progressively replaced gate-level simulation.

3.1.3 Formal Verification using Theorem Proving

A theorem prover is based on libraries of axioms and hypotheses. It uses a set of inference rules to prove the formal description of the behavior of the system by simplifying it until reaching known axioms. Specifications and verification conditions can be expressed in general-purpose logic. Verifying that an implementation meets its specification in such a framework is equivalent to proving a theorem in the underlying logic. In principle, this proof could be carried out manually. However, proofs of such theorems are often long and rather tedious in practice, making it likely that they contain errors.

Using a mechanized theorem-proving system can ensure soundness and reduce toughness by automating parts of the proof. Proof discovery in many theorem provers is guided by the user through the application of proof strategies or tactics. Standard tactics operate at a level of detail such as quantifier instantiation or rewrite with respect to a set of equalities. Hardware proofs in a particular application domain often follow common

⁴A model assumed to be correct.

general patterns, which suggests the development of proof strategies that automatically discharge more complex obligations.

In the literature, various logics have been used to implement theorem proving with various levels of automation, and many have been used for hardware verification, including the followings ones:

- ACL2 tool⁵ [KM96] uses a first order logic without quantifiers with induction.
- HOL system⁶ [Gor01] and PVS system⁷ [ORS92] use higher order logic.
- Coq formal proof management system⁸ [DFH⁺91] uses calculus of inductive constructions.
- Isabelle⁹ [Pau94] uses a general-purpose logic.

It should be noticed that in the hardware verification framework, higher order logic is less crucial than in other applications [Mel09, Pie14].

3.2 Semi-Formal Verification and Assertions

To take advantage of formal verification in the context of industrial sized case studies, semi-formal approaches were proposed combining simulation and formal assertions. An *assertion* (called also *check*) is a statement on the intended behavior of a design. The purpose of assertions is to ensure consistency between the designer intention and the implementation. This verification approach is called *Assertion-based verification* (ABV). The key features of ABV are that, if an assertion violation is detected by the simulator, the related signals are identified, and the source of error is reported to the user.

The assertions are expressed as a native assertion construct, e.g., *System Verilog Assertions* (SVA) [oEE09] or as temporal logic formulæ, e.g., using *Property Specification Language* (PSL) [oEE10]. The PSL is defined as a standard for RTL level assertions. This gives the design architect a standard means of specifying design properties using a concise syntax with clearly defined formal semantics and enables the RTL implementer to capture design intent in a verifiable form, while enabling verification engineer to validate that the implementation satisfies its specification.

ABV can be integrated to *static* and *dynamic* test benches.

⁵<http://www.cs.utexas.edu/~moore/acl2/>

⁶<http://www.cl.cam.ac.uk/research/hvg/HOL/>

⁷<http://pvs.csl.sri.com/>

⁸<http://coq.inria.fr/>

⁹<http://www.cl.cam.ac.uk/research/hvg/Isabelle/>

- A static test bench is a “pure” formal test bench in which the DUV is connected to assertion-based formal unit. Those units analyze the hardware description of the system (e.g., VHDL or Verilog RTL design) without running any simulation. Although model checking a property (expressed through an assertion) at the hardware description level is intractable, because of the state space explosion problem, model checking can be carried out by applying several limitations to the explored state space. The assertions are used to restrain the DUV explored behavior and to extract a model checking assignment.
- A dynamic test bench is a simulation test bench, in which (dynamic) verification IPs are connected to the DUV. The verification IPs initiate tests, respond to the DUV requests, and monitor the DUV activities. The assertion-based unit are connected to the dynamic test bench, in order to monitor the DUV events triggered by ran tests and check that those events respect the properties (expressed by assertions). In this case, we speak about *semi-formal verification*.

3.3 System-Level Approaches

In the SoC context, different complexity aspects are introduced to the verification activity. A first aspect consists in the combination of software and hardware platforms. Precisely, the hardware DUV cooperate with processor model such as BFM (bus functional model). A second aspect consists in the use of pre-verified and unverified components, e.g., the use of legacy IPs already verified. A third aspect of complexity resides on the presence of different languages and different abstraction levels providing common interface structure between SoC components. To deal with this specific complexity introduced in SoC verification context, several approaches have been explored.

3.3.1 SystemC Transaction Level Models

A significant amount of system-level approaches in hardware design rely on *SystemC* [LMSG02], which is a modeling platform consisting of a set of C++ class libraries, including a simulation kernel that supports hardware modeling concepts at the system level, behavioral level, and RTL level. SystemC allows to create an executable specification of the system and can be used either in cycle level or transaction level. While the cycle-level platform has to synchronize with the DUV at every clock cycle, the transaction-level platform has just to synchronize at the end of each transaction. The *Transaction-Level Modeling* (TLM) [G⁺05] has no notion of exact time, but preserves transactions order. The TLM model is used as the fastest reference by each block designer. Such a model can be also used to have a rough estimation on performance.

The SystemC/TLM uses software function calls to model the communication between blocks in a system. This is in contrast to hardware RTL, and gate level models, which

use signals to model the communication between system blocks. TLM models have been used in various forms for many years. The emergence of widely used standard modeling languages such as SystemC/TLM, enables model interoperability and exchange within companies and between companies. This is crucial since modern SoCs rely heavily on IP reuse [Swa06].

It was proposed in the literature to combine system-level modeling with assertion-based verification [DGG⁺05], using a platform called FoCs (“Formal Checkers”) [ABG⁺00] based on both SystemC/TLM and PSL. In fact, formal methods enhance the capabilities of SystemC/TLM languages initially intended for simulation and hardware-software co-simulation purposes. SystemC models can be verified using model checking, which improves simulation speed and coverage [BKS08]. In addition to that, complex designs involving asynchronous concurrency may also be specified using dedicated languages specifically designed and optimized.

3.3.2 High-Level Formal Models and Abstractions

An alternative style of specification uses a high-level formal model to stipulate the allowed behaviors of a system. In this framework, verification entails reasoning about the relationship between the high-level model, also referred to as the specification, and a lower-level model, the implementation [KG99].

Central to this approach is the notion of *abstraction*, which permits unnecessary detail to be hidden from the high-level model. Furthermore, specifications may be given in an hierarchical fashion; starting from a very abstract model at the highest level, one proceeds through a series of abstractions to a detailed description of the implementation. The design at some level k assumes the role of the implementation with respect to the specification at level $k-1$, and the role of the specification for level $k+1$.

Different abstraction mechanisms are explored in the literature. We present here four identified types of abstraction prevalent in hardware verification [JOS⁺01].

- *Structural abstraction* suppresses details about the implementation internal structure in the specification. The specification gives a black-box view of the design that reflects the externally observable system behavior without constraining its internal design.
- *Behavioral abstraction* suppresses details about what the component does under operating conditions that should never occur. Behavioral abstraction may also indicate “do not care” conditions. This gives the designer greater flexibility to optimize the implementation. The specification is more abstract, in the sense that its behaviors are a superset of the implementation behaviors.

- *Data abstraction* substitutes concrete data by a simpler one. Data abstraction requires a mapping that determines how the states or signals (representing data) of the implementation are to be interpreted in the specification semantic domain.
- *Temporal abstraction* relates time steps of the implementation to time steps of the specification. Frequently, specifications of a microprocessor use the execution of a single instruction as the basic unit of time. An implementation, however, would base its notion of time on the execution of a microcode instruction, a clock cycle, or a clock phase. Temporal abstraction requires that corresponding execution states at the two time scales be identified. This is complicated by the possibility that one specification time-unit does not always necessarily correspond to the same number of implementation steps.

In practice, the abstractions used in modeling depend on the application domain, the design size, and the targeted exploitation of the model (e.g., the kind of properties to be verified on the model).

3.4 Test Generation strategies

Generating tests to achieve high coverage for complex designs has always been a challenging problem. In general, more constrained and less random tests reduce the overall validation effort, because the same verification coverage can be achieved with fewer and shorter tests [MC09]. We distinguish three types of test generation techniques with decreasing degree of randomness: fully random, constrained-random [YPAA03], and fully specified tests, hereafter called directed tests, i.e., without randomization.

Fully random tests are the easiest to automate, but require long simulation runs to obtain a reasonable coverage. In many situations, directed tests are the only tests that can thoroughly verify corner cases and important features of a design [BGH⁺99, KMBA06]. However, because directed tests are mostly written manually, it is impractical to generate a comprehensive set of directed tests to achieve a coverage goal [MC09].

Constrained-random testing uses constraint solvers to select tests satisfying a specified set of constraints; non-specified details are then filled in by randomization. Manually writing directed tests has been a dominant test development methodology even with the emergence of constrained-random test generation, which alleviates part of the problem by producing a large number of guided random tests, so that many verification targets can be fortuitously covered.

In the following, we explore additional strategies used to generate more directed and more automated tests.

3.4.1 Coverage-Directed Test Generation

The automation of the feedback from coverage analysis to constrained-random test generation led to *coverage-directed test generation* (CDTG) [SWC⁺08], which dynamically analyzes coverage results and automatically adapts the randomized test generation process to improve the coverage. The *Coverage Driven Verification* (CDV) and *Metric Driven Verification* (MDV) are different instances of the CDTG. The CDV proposes to automatically generate tests targeting the non covered behaviors, without any organization of the coverage metric. As designs increase in size, coverage metrics are exploding, making the sheer magnitude unmanageable without automation. Metric automation has become an imperative. The MDV improves the CDV by organizing the coverage by types of coverage behavior and also by components, which is very useful to define the portion of the design that has been verified. Today, the metric methodology is emerging, reducing the number of manual decisions necessary for claiming verification success. MDV provides the automation and prescriptive approach to reduce the decision churn.

The challenges of CDTG techniques are that it is sometimes difficult to guide the direction of test generation to increase the coverage of the design, and the need of more efficient coverage metrics to represent the behavior of the design including corner cases. For instance, CDTG succeeds to achieve coverage goals for interface hardware protocols, but reaches its limits for complex system-level protocols, such as system-level cache coherency. Achieving good coverage for these recent protocols is a new challenge in the development of industrial test benches and calls for more directed and less random tests.

The semi-formal verification allows the designer to measure the coverage of the test environment as the formal assertions are checked during simulation, but the simulation speed is degraded as the assertions are checked during simulation.

Our thesis is part of the current works trying to resolve the different challenges of semi-formal verification.

3.4.2 Faults-Based Test Generation

To avoid writing directed tests manually, several approaches to generate a comprehensive set of high-quality directed tests are explored. Some techniques of directed test generation propose to generate tests from potential faults of the system [MSK⁺07, WAW09]. For system-level protocols, in the SoC context, it is more difficult to examine potential faults of the DUV. Solutions based on model checking techniques are promising for functional verification and test generation for reasonably complex systems [GH99]. Hence, we suggest the use of the model checking of the main system properties, by prohibiting some protections to generate counterexamples. However, it is unrealistic to assume that a complete detailed model of a large SoC is tractable by a model checker. We address this issue by relying on a system-level model, abstracting from all irrelevant details. In this

way, we succeed to model a complex industrial SoC and to extract relevant scenarios by model checking.

Some approaches [GH99, QM11] transform counterexamples produced by the model checker into test cases. In our approach, we use the counterexamples to produce smaller interesting configurations of the model that still do not satisfy a given property. We generate test cases from these smaller models, thus avoiding combinatorial explosion in many cases.

3.4.3 Combining Model-Based and Coverage-Directed Testing

In the literature, it has already been proposed to mix model-based techniques and coverage-directed techniques. Coverage-directed techniques were used in property learning [CM11] (“reuse learned knowledge from one core to another”), which we do not use, and that relies on SAT-based BMC (whereas CADP implements totally different verification techniques). Some of those techniques [QM11] focus on homogeneous multicore architectures (exploiting symmetry between processors to reduce verification complexity), and only suggest how this could be extended to heterogeneous architectures (by grouping IPs into homogeneous groups to be studied separately). On the contrary, our approach was designed for heterogeneous SoCs and makes no symmetry assumption. Also, most of those techniques [CM11, CQKM13, QM11] remain at system level (SystemC/TLM), whereas our approach starts from system level and goes down to RTL level.

3.5 Applications of Formal Verification to Hardware Cache Coherency

Formal verification techniques such as (symbolic) model checking and theorem proving, have been often applied to the verification of hardware designs of cache coherence protocols, using various modeling languages, temporal logics, and verification tools [PD97, KG99]. Most works [Che04, CYGC10, CGH⁺95, EM95, KKVD13, MS91, PNAD95, SDSH11, SD95] concern elaborated protocols using more complex topologies than the fully connected snoop topology used in our case. The principal differences with our work are that we focus on a generic interconnect that includes the behavior of all correct implementations and that we study a heterogeneous SoC, rather than verifying a particular coherency protocol for a homogeneous system.

It was recently reported [DCF⁺14] that formal verification has to be considered for hot spots at the SoC level and specially for the integration of system-level cache coherency. In fact, efficiency can be improved using formal techniques on the infrastructure that is managing various levels of cache and memory subsystem. More and more interconnect fabrics embark cache coherency mechanisms that require dedicated and tricky verification.

3.6 Applications of CADP to Hardware Validation

Over the last 20 years, the CADP toolbox has been used for verifying numerous complex hardware designs, including Bull supercomputers, STMicroelectronics multiprocessor architectures, several Networks on Chip (e.g., CEA/Leti and University of Utah), and various asynchronous circuits.

In order to apply formal methods to a hardware design, different aspects can be explored: the formal modeling, the functional verification, the model-based testing, and/or the performance evaluation. In this thesis, we present an application of the latest languages and tools of CADP, using the new generation formal language LNT [CCG⁺14] to describe the system and also the test purposes, which greatly facilitates the testing of complex behaviors. In parallel with this thesis, the CONVECS team has developed new prototype tools to support these new functionalities.

The remainder of this section gives an overview of previous hardware related case studies using CADP.

3.6.1 Formal Modeling

Several guidelines must be followed when developing formal models. For example, we have to focus on the complex parts of the system (e.g., parallelism, concurrency, etc.). Other parts are less important and can introduce irrelevant complexity in the model. Also, we can use abstractions to hide irrelevant details.

The formal modeling is useful to detect ambiguities of the initial specification. This one is usually not formal. That is why many problems are discovered just by formally modeling, before running any tool. Formal specification triggers discussions with hardware architects, which is interesting in order to have a deep understanding of the complex parts of the system. After that, the model has to be debugged. In fact, several errors are just introduced during modeling and the debugging aims to remove them. The hardware architects are not interested in those errors, called *false negatives*.

In the CADP context, the modeling languages used are LOTOS (before 2008-2009) and LNT (since then). LOTOS and LNT are both formal languages to describe asynchronously-concurrent systems. LNT (see Sec. 2.6.2) is more convenient for human users, because it is closer to programming languages and hardware languages (such as VHDL). In general, the starting point for producing formal models in hardware context are natural language descriptions of the specification of the system (English text, tables, diagrams), but in some cases, we extract the formal model from a semi-formal program written in other hardware languages (e.g., CHP¹⁰, SystemC/TLM, etc.). To remove

¹⁰Communicating Hardware Processes

Table 3.1 – CADP: formal modeling effort in past projects

Case study	Company	Level	Modeling size
Powerscale	Bull	system	720 lines of LOTOS
Polykid	Bull	system	4000 lines of LOTOS (model) 2000 lines of LOTOS (rules) 3400 lines of LOTOS 7000 lines of C (emulation)
SCSI-2	Bull	system	220 lines of LOTOS
FAME1/CCS	Bull	system	1200 lines of LOTOS
FAME1/NCS	Bull	system	1200 lines of LOTOS
FAME1/B-SPS/FSS	Bull	system	5000 lines of LOTOS
FAME1/ILU	Bull	unit	8900 lines of LOTOS 3400 lines of C
FAME1/PRR	Bull	block	7500 lines of LOTOS 200 lines of C
CC-NUMA	Bull	system	1800 lines of LOTOS
DES	CEA-Leti/TIMA	unit	1000 lines of Mur ϕ 3800 lines of LOTOS 1700 lines of CHP
FAME2/PAB	Bull	block	3977 lines of LNT
FAUST/MAGALI	CEA-Leti	system	1200 lines of CHP
xStream	STMicroelectronics	unit	6800 lines of LOTOS
Blitter Display	STMicroelectronics	block	920 lines of LOTOS 5550 lines of SystemC/TLM 2250 lines of C
Platform2012/HWS	STMicroelectronics	unit	300 lines of LNT
Platform2012/DTD	STMicroelectronics	block	1200 lines of LNT
Utah NoC	Univ. of Utah	system	1350 lines of LNT

introduced errors during modeling, different techniques are used. First of all, by compiling with CADP tools, several errors can be removed. Then, the OCIS interactive step-by-step simulator with backtracking of CADP is found useful for exhibiting other behavioral errors. For more confidence on the formal model, we can use CADP model checkers to verify simple properties (e.g., absence of deadlocks, etc.).

In Table 3.1, we present some figures about the modeling effort in previous hardware case studies with CADP.

3.6.2 Functional Verification

Functional verification looks for “real” bugs in the specification (and not in the model). We need to formalize the properties that we want to verify. The formalization of the properties is a new source of bugs, that is why we have to debug properties.

3.6. Applications of CADP to Hardware Validation

Table 3.2 – CADP: functional verification results

Case study	Functional verification results
Powerscale	Hidden bug found in a few minutes [CGM ⁺ 96]
Polykid	Phase 1: 55 questions Phase 2: 20 questions, 7 serious issues Phase 3: 13 serious issues [KVZ98]
SCSI-2	SCSI-2 bus arbiter starvation problem confirmed (avoided in SCSI-3 standard)
FAME	Critical parts of FAME design verified using CADP 10 issues raised, 2 ambiguities pointed out
STBus SoC	Error in the design discovered [WCB ⁺ 03]
FAME2/MPI	Formally verified
FAUST/MAGALI	Routing problem detected in the CHP description [SSTV07]
xStream	Two design issues detected very early
Blitter Display	Avoids complete translation of SystemC/TLM to LOTOS: - reduced translation effort - better integration of formal verification in the design flow [GHPS09]
Platform2012/DTD	Problematic configurations with livelocks found Further investigation by co-simulation [LS11]
Utah NoC	Found flaws in the original arbiter design [ZSW ⁺ 14]

At some point, a good confidence is reached in both the formal model and properties. Then, if a verification reports an error, it can be either an error in the verification tool (which is rare, and has to be fixed by tool developers) or a “real” bug in the specification is detected.

In Table 3.2, we summarize the principal functional verification results of the past hardware case studies carried out using CADP.

3.6.3 Model-Based Testing

In the CADP context, MBT can be handled by an off-line approach or an on-line one. Off-line approach means that in a first step, test cases are generated, then in a second step test cases are run on the implementation. On-line approach consists in doing a co-simulation of the specification and the implementation. Test cases are generated and ran in the same time. The result of ran test cases can be used to generate the subsequent ones.

The former MBT case studies of CADP are based on TGV [FJJV96, JM99, JJ05], which uses LOTOS to present the specification and a textual `.aut` expression of the test purpose.

Table 3.3 – CADP: Model-based testing results

Case study	Model-based testing results
Polykid/Test generation	5 new bugs discovered in VHDL design [KVZ98]
Polykid/Emulation	Replacement of a missing ASIC by a software emulation [GVZ01]
FAME/CCS	Directed test generation using TGV: 21 base tests 50 collision tests, 1 generalized test
FAME/NCS	Directed test generation using TGV: 50 base tests
FAME/PRR	Random test generation using Executor Detection of a non-conformity between LOTOS and Verilog codes for PRR v1 (not detected using commercial tools)
FAME/ILU	Co-simulation using Exec/Caesar
FAME/B-SPS/FSS	Trace validation with coverage Major bug found (ambiguity in informal specification) Insufficient coverage found (3 missing tests added) [GM04]
FAUST/MAGALI	Co-simulation: LOTOS-SystemC / VHDL netlist Detection of spurious inputs generated by LOTOS model: Constraints added to generate only valid inputs
Platform2012/DTD	Co-simulation: C++ / LNT Found C++ incorrect for some particular scenarios [LS14]

In Table 3.3, we summarize the principal MBT results of the past hardware case studies of CADP.

3.6.4 Performance Evaluation

The high degree of concurrency may introduce communication latencies. The time constraints have to be respected. The performance evaluation is interested in quantitative issues occurring with a high degree of concurrency.

The principle advantage of CADP is that both qualitative and quantitative aspects can be studied on the same formal model [GH02]. CADP expresses the performance information using the following formalisms: the *Continuous-Time Markov Chains* (CTMCs) [And91], the *Interactive Markov Chains* (IMCs) [Her02] and the *Interactive Probabilistic Chains* (IPCs) [CHLS09].

- The CTMCs formalism was applied to a 5×5 2D mesh NoC of CEA-Leti to predict the mean latency of the end-to-end communication. The results were close (<5%) to SystemC simulation [FTHJ10].
- The IMCs formalism was applied to SCSI-2 bus arbitration protocol of Bull, based on fixed priorities in order to do a steady-state analysis, to suggest strategies to

3.6. Applications of CADP to Hardware Validation

avoid starvation and increase throughput [GH02]. This formalism was also applied to FAME/MPI case study of Bull in order to have an estimation of the number of cache misses and to select the most efficient configuration of the system [CZM09].

- The IPCs formalism was applied to the xStream architecture of STMicroelectronics in order to predict latencies, throughputs, and queue occupancy [CHLS09].

Formal Modeling of a System-Level Cache Coherent SoC

Chapter 4

System Level Cache Coherency with AMBA 4 ACE

4.1 Introduction

In this chapter, we define system-level cache coherency in the case of heterogeneous System-on-Chip (SoC). Then, we present the AMBA 4 ACE protocol specification and describe the main elements introduced by this specification to support cache coherency in heterogeneous SoCs.

4.2 System-Level Cache Coherency

In general, an SoC is composed of different hardware blocks such as generic or specialized processors, memories, interconnects, dedicated Intellectual Properties (IPs), or input/output components. These heterogeneous components usually access a *shareable memory* consisting of several *memory lines*. In order to increase data access performance and reduce power consumption, some components may use a *cache*, containing local copies of memory lines. The use of local copies in the caches decreases the number of accesses to global memory. The use of multiple caches in the system and the allowance of multiple users of a cache results in the problem of *System-Level Cache Coherency* (see Fig. 4.1), which is currently one of the main concerns of the digital hardware industry.

An SoC is *cache coherent* if write operations to the same memory line by two components are observable in the same order by all components of the system. Heterogeneity of an SoC stems from not making any constraint on the nature of the components. The only segregation we consider is considering components with caches and without caches. The components are considered with caches if their neighbors are allowed to use data copies present in their caches, unless they are considered without caches. All components can

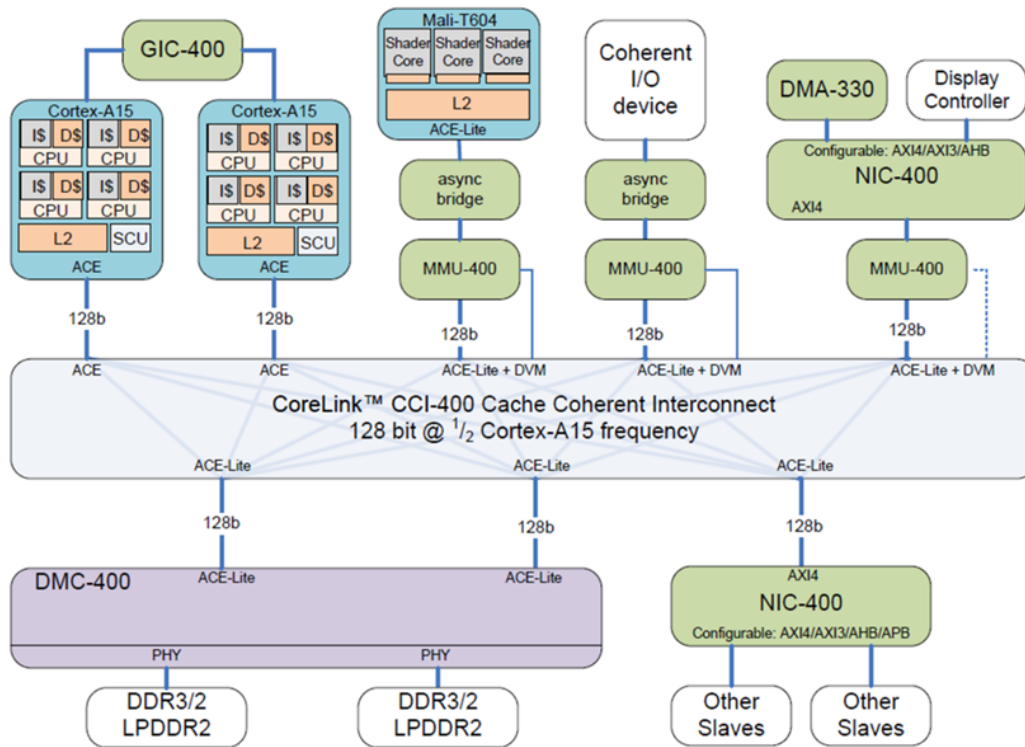

© ARM Ltd. Copyright 2012

Figure 4.1 – Example of a heterogeneous SoC using System-Level Cache Coherency

read their neighbor’s caches instead of reading the global memory, unlike conventional multiprocessor systems, on which the cache coherency is only considered between similar processors.

One may distinguish *shareable* and *non-shareable* memory lines. For example, the graphics memory of an SoC might be dedicated to image processing and exclusively used by the Graphical Processing Unit (GPU), whereas the remaining memory might be used either by the generic processors (Central Processing Units, CPUs) or by the GPU. In this case, the graphics memory is non-shareable, and the remaining memory is shareable.

The components of an SoC can be grouped into *master* components (such as CPUs) and *slave* components (such as memories). Components communicate via an interconnection medium, called the *interconnect*. In the case of a cache coherent system, the interconnect is also called a *Cache Coherent Interconnect (CCI)*. Each component communicates with the interconnect via a communication port, which consists of several channels. Operations performed on ports are called *transactions*.

Snoop transactions are used for master-to-master accesses. Thank to snoop transactions

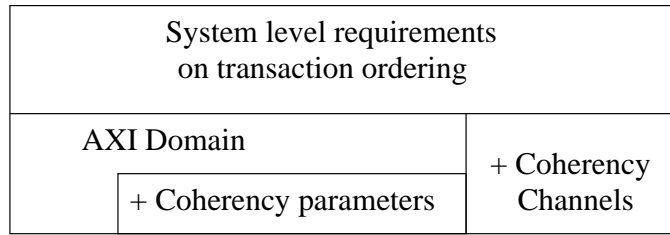

Figure 4.2 – ACE: AXI Coherency Extension

a master has a consistent view of the transactions of other masters. Previously, in bus-based systems all components are connected to the bus and “snoop” the bus traffic to guarantee the consistency of the system. In the context of CCI, the interconnect initiates snoop transactions to simulate the bus snoop.

4.3 AMBA 4 ACE protocol

The recent AMBA 4 ACE (AXI Coherency Extension) protocol [ARM13, Ste11], proposed by ARM, extends the AMBA 3 AXI¹ protocol in order to support system-level cache coherency in SoCs. AXI defines communication at interface level between a pair of master/slave ports. AXI specifies several read and write channels (AR, R, AW, W, B) and determines the structure of each channel: parameters specifying length and composition of control, data, and response channels, as well as the different acknowledgments used. As shown in Figure 4.2, the ACE extension introduces system-level requirements on transaction ordering, adds new channels to send coherency request, enriches existing channels with new coherency parameters expressing details related to the coherency, and defines cache line states and a set of transactions.

ACE is designed to maintain coherency when sharing data across caches of an SoC, to enable interactions between heterogeneous components, and to ensure maximal reuse of cached data. ACE also supports a flexible framework for system level coherency: the system designer can determine the ranges of memory lines that are coherent, the system components that implement the coherency extension, and the communication policies.

The ACE specification defines an interface protocol (between each component and the interconnect), the expected behavior of the components, and the responsibilities of the interconnect. ACE admits different policies of cache coherency, known as directory based, snoop filter, or fully connected (no snoop filter) policies.

ACE introduces heterogeneity by defining two types of coherent masters: those with a cache are called *ACE masters*, and those without caches (but with the ability to access caches of other masters) are called *ACE-Lite masters*. The components not using

¹AMBA: Advanced Micro-controller Bus Architecture / AXI: Advanced eXtensible Interface

coherency transactions are *AXI masters* and *AXI slaves*, which use the former AXI protocol.

In the remaining, we consider an SoC with two ACE masters, a CCI, and an ACE-Lite master.

4.4 ACE States

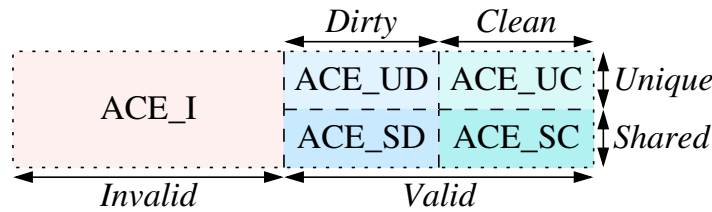

Figure 4.3 – ACE states of a cache line

ACE distinguishes five states (shown in Figure 4.3) of a cache line.

A cache line is *invalid* if it does not contain a copy of any memory line. A cache line is *unique* if all other copies of the same memory line are invalid. A cache line is *shared* if all other copies of the same memory line are shared or invalid. A cache line is *dirty* (respectively *clean*) if the master is responsible (respectively not responsible) of writing the data back to the shareable memory.

4.5 ACE Ports and Channels

The ACE specification distinguishes three kinds of ports (shown in Fig. 4.4) to connect a component to an interconnect. (a) An *ACE port* is used for components having a cache memory. (b) An *ACE-Lite port* is used for components without a cache. (c) An *AXI port* is used for components that do not use coherency.

The interconnect uses an ACE slave port (respectively, ACE-Lite slave port) to be connected to an ACE master and an AXI master port to be connected to the memory (AXI slave). Globally, the interconnect is the slave for master components and the master for slave components.

Each port consists of several channels. ACE distinguishes three types of channels: *read channels*, *write channels*, and *snoop channels*. Read (respectively, write) channels are used to read (respectively, write) data; these channels extend AXI channels with coherency related parameters (namely the parameters *PassDirty* and *IsShared*). Read channels are *address read* channel (called **AR**, used to send read requests) and *data read* channel (called **R**, used to send the data back). Write channels are *address write* channel (called

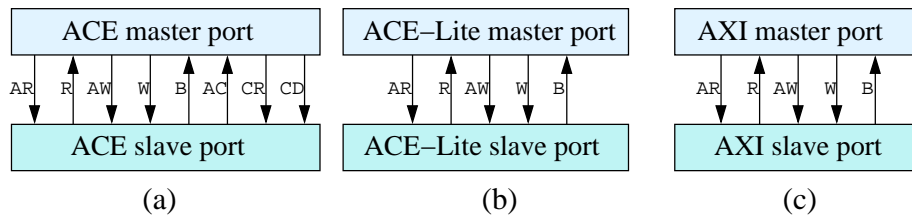

Figure 4.4 – Structures of ACE, ACE-Lite, AXI ports

AW, used to send write requests), *data write* channel (called W, used to send the data to be written), and *write response* channel (called B, used to signal completion of a write).

Snoop channels are used for snoop requests issued by the interconnect to masters with a cache. Snoop channels are *address coherency* channel (called AC, used to send snoop requests), *coherency response* channel (called CR, used to answer snoop requests, indicating whether a data transfer will follow), and *coherency data* channel (called CD, used to send data to the interconnect).

4.6 ACE Transactions

The ACE specification defines several types of transactions. In the sequel, we focus on a significant subset of transactions related to cache coherency. The remaining transactions are not related to the cache coherency aspects (e.g., the distributed virtual memory) and not activated in our industrial application. Other transactions introduced by ACE specification are not used in the fully connected topology that we use (e.g., Evict transaction used to modify the snoop filter, if any).

For each ACE transaction, we present the expected order of operations on the channels. A master initiating a transaction is called *initiator*. A master with a cache receiving a snoop from the CCI is called a *snooped master*.

Non-snooping transactions are used to access non-shareable memory lines which must not be in the caches of other master components. We consider two non-snooping transactions: *ReadNoSnoop* and *WriteNoSnoop*.²

Coherent transactions are used by an ACE or ACE-Lite master to access shareable memory lines, which might be in the caches of other components. A coherent transaction is initiated by a master through a request on the AR channel. The interconnect initiates corresponding snoop transactions to all other masters with a cache and, if necessary, reads the data from the shareable memory. Finally, the interconnect sends a reply transaction to the initiator on the R channel, indicating whether the data is shared and whether

²Those transactions are equivalent to the AXI Read and AXI Write transactions.

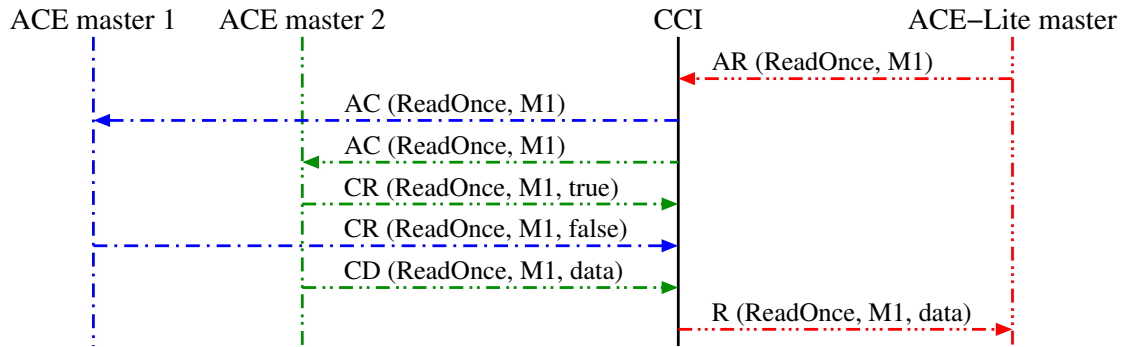

Figure 4.5 – Execution scenario of a *ReadOnce* transaction

the responsibility to write the data to memory is passed to the initiator. The ACE specification defines the following coherent transactions:

- A *ReadClean* transaction obtains a copy of the memory line and ensures that the copy is clean.
- A *ReadNotSharedDirty* transaction obtains a copy of the memory line and ensures that the copy is not *SharedDirty*.
- A *ReadShared* transaction obtains a copy of the memory line without any constraint on the resulting state of the cache line.
- A *ReadUnique* transaction obtains a copy of the memory line and ensures that the copy is unique (i.e., no other copies exist).
- A *CleanUnique* transaction obtains a copy of the memory line and ensures that the copy is unique (i.e., no other copies exist). If another copy of the memory line is dirty, this transaction ensures that the dirty cache line is written to main memory.
- A *MakeUnique* transaction invalidates all other copies of the memory line.
- A *ReadOnce* transaction obtains the current contents of a memory line, which may not be copied into the cache. If a snooped master passes the responsibility to write the data to the memory, the interconnect must write the data to memory before responding to the initiator.
- A *WriteUnique* transaction removes all copies of a cache line before issuing a write of a partial cache line. A *CleanInvalid* snoop transaction is triggered. If a dirty data exists in another cache, this data is used to complete the written memory line.
- A *WriteLineUnique* transaction removes all copies of a cache line before issuing a write of a complete cache line. A *MakeInvalid* snoop transaction is triggered.

Example 9 Figure 4.5 shows the execution of a *ReadOnce* transaction (for memory line M1) initiated by the ACE-Lite master. The CCI snoops both ACE masters, which answer with a Boolean indicating whether the data is in their cache. The cache of ACE master 2 contains the data, hence this master also sends the data, which the CCI forwards to the ACE-Lite master to complete the transaction.

Memory update transactions are used to update shareable memory lines. These transactions are initiated by a master on the **AW** channel; the data to write is sent by the master on the **W** channel. The interconnect writes the data to the memory and returns an acknowledgement on the **B** channel. The ACE specification defines three different memory update transactions:

- A *WriteBack* transaction is used to write back a dirty line to shareable memory, freeing a cache line that can then be used for a different memory line. No copy of the cache line is retained.
- A *WriteClean* transaction is used to write a dirty line to the shareable memory, while permitting to retain a clean copy of the memory line.
- A *WriteEvict* transaction is used to evict a clean cache line.

Cache maintenance transactions are used by master components to access and impact the caches of other components. In particular, cache maintenance transactions enable a master to observe the effect of load and store operations on caches of other masters (which cannot otherwise be accessed). The ACE specification distinguishes three cache maintenance transactions: *CleanShared*, *CleanInvalid*, and *MakeInvalid*. These transactions are initiated by sending a request on the **AR** channel. The interconnect initiates corresponding snoop transactions to all other masters with a cache. For a *CleanShared* transaction, a snooped master may retain its local copy of the memory line, but for a *CleanInvalid* or *MakeInvalid* transaction, a snooped master must invalidate its local copy. For a *CleanShared* or *CleanInvalid* transaction, a snooped master must also provide the data if the corresponding cache line is dirty. After all snooped masters have answered, the interconnect returns an acknowledgment to the initiator on the **R** channel. If the responsibility of writing back the data to memory is passed, the interconnect has to write the data to the memory.

Snoop transactions are initiated by the interconnect to access the cache of an ACE master while handling coherent transactions and cache maintenance transactions (see below) initiated by another ACE or ACE-Lite master. The interconnect initiates a snoop request on the **AC** channel. The snooped master responds on the **CR** channel indicating if a data transfer is needed. If so, the data is transferred on the **CD** channel indicating also

Table 4.1 – Snoop transactions and their original transactions

Snoop transaction	Triggered by
<i>ReadOnce</i>	<i>ReadOnce</i>
<i>ReadClean</i>	<i>ReadClean</i>
<i>ReadNotSharedDirty</i>	<i>ReadNotSharedDirty</i>
<i>ReadShared</i>	<i>ReadShared</i>
<i>ReadUnique</i>	<i>ReadUnique</i>
<i>CleanInvalid</i>	<i>CleanUnique</i>
	<i>CleanInvalid</i>
	<i>WriteUnique</i>
<i>MakeInvalid</i>	<i>MakeUnique</i>
	<i>MakeInvalid</i>
	<i>WriteLineUnique</i>
<i>CleanShared</i>	<i>CleanShared</i>

whether the data is shared and whether the snooped master keeps the responsibility to write the data to memory.

Snoop transactions and their possible original transactions are shown on Table 4.1.

ACE-Lite transactions are a subset of ACE transactions, namely: *ReadNoSnoop*, *ReadOnce*, *CleanShared*, *CleanInvalid*, *MakeInvalid*, *WriteNoSnoop*, *WriteUnique*, and *WriteLineUnique*.

4.7 Requirements on the Global Ordering of Transactions

The AMBA 4 ACE specification contains some global *requirements*. Indeed, the ACE protocol does not guarantee system level cache coherency but just provides a support for it; coherency has to be ensured by proprietary additional mechanisms on each implementation of a CCI.

There are two kinds of global requirements:

- Coherency between caches (called *horizontal coherency*) [ARM13, section C4.10]: When two masters attempt to write to the same memory line simultaneously (i.e., the second transaction begins before the end of the first transaction), then the interconnect must ensure a strict order of transactions.
- Coherency between the memory and caches (called *vertical coherency*) [ARM13, section C6.5.3]: Data received from caches must be written to the memory in the correct order.

4.8 Discussion

The AMBA 4 ACE protocol has become a standard of System-Level Cache Coherency, more than ten big semiconductors companies are using this protocol in their chips. Formally validating such a protocol is very interesting. Before starting any validation work, we must express formally the protocol and in order to avoid intractable complexity we have to focus on the new aspects introduced by ACE. In the following chapter we describe the formal modeling of a generic SoC based on this hardware protocol.

Chapter 5

Formally Modeling an ACE-based SoC using LNT

5.1 Introduction

In this chapter, we discuss the development and the validation of a formal model of an AMBA 4 ACE-based SoC. We start by giving the main aspects of the formal model. After that, we present the state space generation of several configurations of the model. Then, we discuss the validation of the formal model mainly using model checking techniques. Finally, we show the industrial impact of the formal modeling.

5.2 General Description of the Formal Model

We model the coherent part of an SoC in development at STMicroelectronics. The formal model consists of a *cache coherent interconnect* (CCI) connected to a non-cache-coherent Network-on-Chip (NoC), using the LNT language [CCG⁺14], supported by the CADP toolbox [GLMS13].

The formal model (about 3,400 lines of LNT code¹) focuses on the cache-coherent part of the SoC and system-level behavior (i.e., interactions between components), considering a transfer on a channel to be atomic. Hence, parameters about transfer types, identification of the sender and receiver, and coherency information are modeled, whereas other AXI parameters concerning channel transfer structure are omitted. Our model is useful for studying the message ordering in the cache-coherent part of the SoC.

A crucial feature of our formal model is that it is parameterized, in particular by the

¹A large Petri net derived from our LNT model is available as Model Checking Contest 2014 benchmark (<http://mcc.lip6.fr/pdf/ARMCACHECoherence-form.pdf>).

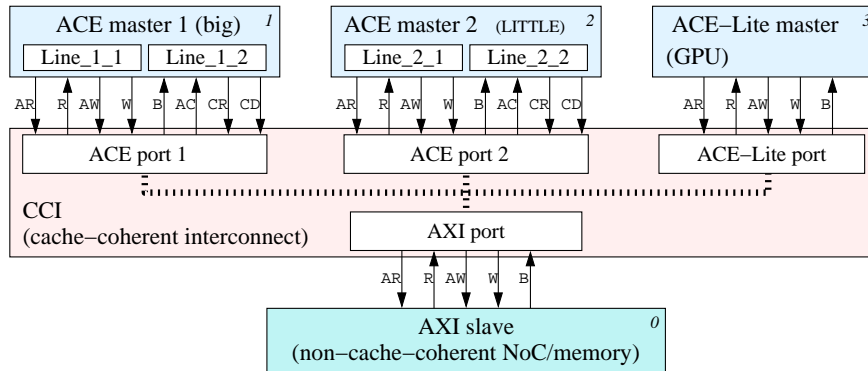

Figure 5.1 – Model architecture

set of forbidden ACE transactions, the number of ACE masters, ACE-Lite masters, and cache lines per ACE master. The model is generic in the sense that it includes all the behaviors permitted by the ACE specification for any correct implementation. The masters are non-deterministic agents, which may initiate all the transactions described in Chapter 4.

Example 10 In the following, we use the configuration with two ACE masters and one ACE-Lite master corresponding to the industrial use of the protocol (shown in Fig. 5.1), which uses the ARM® big.LITTLE™ solution [PG11]: The two ACE masters correspond to one big (powerful) and one little (lower-power) processor, enabling to dynamically adapt to changing computation load. The ACE-Lite master represents a *Graphical Processing Unit* (GPU) that can access the caches of both processors. All three masters access the main memory through a non-cache-coherent NoC. The component index is 0 for the AXI slave (shareable memory), 1 and 2 for the ACE masters, and 3 for the ACE-Lite master. Among the three masters, at most two initiate transactions at the same time. We vary essentially one parameter, which is the set of forbidden ACE transactions; we refer to the model as $\text{Model}(\mathcal{F})$, where \mathcal{F} is the set of forbidden ACE transactions; $\text{Model}(\emptyset)$ corresponds to the complete model.

Due to the industrial choice of STMicroelectronics, we opted for modeling a *fully connected snoop* topology, i.e., all coherent transactions lead to snoop transactions for all masters with caches. Note that the first industrial implementation [ARM12] of the ACE protocol also has a fully connected snoop topology.

5.2.1 Types and Data Structures

Our model abstracted the ACE specification by applying data independence considerations; we replace the 128-bit memory line data by a data type `Data_t` consisting on a limited range of `Nat`. At our abstraction level, we only need to know whether two data

5.2. General Description of the Formal Model

are equal or different². This reduces the potential state space produced by the range of data (i.e., we use $D=7$ to differentiate the data in each master cache and the shareable memory and the data after a new master write on the owned or modified cache line).

```
type Data_t is range 1 .. D of Nat with "=", "<>" end type
```

Each memory line is characterized by two parameters: an index (of range type `Index_Mem`, where N is the number of memory lines) and a data. The shareable memory can be represented by an array of values of type `Data_t`, indexed by the range of `Index_Mem`. ACE states are represented by an enumerated type called `ACE_state`.

```
type Index_Mem is range 1 .. N of Nat end type
```

```
type Mem_Lines is array [1 .. N] of Data_t end type
```

```
type ACE_state is ACE_I, ACE_UC, ACE_UD, ACE_SC, ACE_SD end type
```

Similarly, we define an index for system components (`Index_Component`) and an index for cache lines of a master with cache (`Index_Cache`). ACE transactions are modeled by an enumerated type `ACE_Trans`.

```
type Cache_Line is
```

```
  LINE_C (indC: Index_Cache, S: ACE_state, indM: Index_Mem, data: Data_t)
end type
```

We introduce an abstract transaction \mathcal{A} that simulates an arbitrary ACE transaction by executing the classical steps of an ACE transaction without changing the ACE states of cache lines. The considered steps are: initiating the transaction on an address read channel (**AR**), sending the corresponding snoop transaction on the address coherency channel (**AC**), receiving a coherency response channel (**CR**), and issuing the corresponding response request in the read response channel (**R**).

5.2.2 Channels

Each operation on an ACE channel is modeled by an LNT rendezvous³ on a gate of the same name as the channel. The LNT gates are typed. The types of LNT gates (called

²"=" corresponds to equality function and "<>" corresponds to difference function

³The semantics of an LNT rendezvous avoids the need to model the acknowledgment *signals* at the level of channel transmission. However, the acknowledgment *operation* for a non-atomic transaction (e.g., the operation on the **B** channel for Write transactions) is represented by an independent LNT rendezvous (on gate **B**).

LNT channels) specify the number and types of the parameters (called *offers*), i.e., the values exchanged during a rendezvous. All gates have an offer to represent the ongoing ACE transaction, an offer to represent the initiator of the current transaction, and an offer to designate the concerned memory line. Snooping gates (**AC** and **CR**) have also an offer to represent the snooped master. Gates which transfer data (**R**, **W**, and **CD**) have also an offer for the data. The gates **R** (read data channel) and **CD** (snoop data channel) have also three Boolean offers. *DataStatus* indicates whether the data is valid, *PassDirty* indicates whether the responsibility of writing data to memory is passed, and *IsShared* indicates whether the data is shared. The gate **CR** has a Boolean offer *DataTransfer* to indicate if a data transfer will be followed on the **CD** gate. The gate **B** has a Boolean offer indicating if the write has completed correctly.

For verification purposes, we add an offer representing the ACE state of the cache line to all gates going out from an ACE master (i.e., **AR**, **AW**, and **CR**). Similarly, the gates between the CCI and a slave have an additional offer corresponding to the initiator.

5.2.3 Channel Structures

Each LNT gate is related to an LNT channel, which defines the different parameters involved: their number, their order, and the type of each one of them.

Applying several abstractions, the structure of the channels consists of a subset of the original parameters defined by the ACE specification, since we hide irrelevant parameters for the system-level view. In this section, we present the structure of each ACE channel in the model.

- The structure of the address read channel **AR** is as follows: the first parameter is the ACE transaction **ACE_OP**, the second one is the index of the communicating component **Index_Component**, the third parameter is the index of the memory line concerned by the read transaction **Index_Mem**, and the last one corresponds to the ACE state of the line initiating the read request **ACE_state_t** (this parameter does not exist in the ACE specification and was added for verification reasons).

```
channel AR_CHANNEL is
  (ACE_OP, Index_Component, Index_Mem, ACE_state_t)
end channel
```

For AXI ports (no coherency), the address read channel **AR** has not an ACE state parameters, and has an additional **Index_Component** parameter, which corresponds to the component at the origin of the transaction.

```
channel AR_CHANNEL_AXI is
```

5.2. General Description of the Formal Model

```
(ACE_OP, Index_Component, Index_Mem, Index_Component)
end channel
```

- The structure of the read data channel **R** is as follows: the first parameter is the ACE transaction **ACE_OP**, the second one is the index of the communicating component **Index_Component**, the third parameter is the index of the memory line concerned by the read transaction **Index_Mem**, the fourth one is the data to transfer **DATA_T**, the fifth one is a boolean indicating whether the response data is relevant **result**, the sixth parameter is a boolean indicating whether the data of the memory line is dirty **PassDirty** (has to be written back to the memory), and the seventh parameter is a boolean indicating whether the memory line is shared **IsShared**.

```
channel R_CHANNEL is
  (ACE_OP, Index_Component, Index_Mem, DATA_T, (*result*) bool,
   (*PassDirty*) bool, (*IsShared*) bool)
end channel
```

For AXI ports (no coherency), the read data channel **R** has not the three boolean **result**, **PassDirty**, and **IsShared**. The latter are introduced for coherency reasons. Instead, channel **R** has an additional **Index_Component** parameter corresponding to the component at the origin of the transaction.

```
channel R_CHANNEL_AXI is
  (ACE_OP, Index_Component, Index_Mem, DATA_T, Index_Component)
end channel
```

- The structure of the address write channel **AW** is as follows: the first parameter is the ACE transaction **ACE_OP**, the second one is the index of the communicating component **Index_Component**, the third parameter is the index of the memory line concerned by the write transaction **Index_Mem**, and the last one corresponds to the ACE state of the line initiating the write request **ACE_state_t** (added for verification reasons).

```
channel AW_CHANNEL is
  (ACE_OP, Index_Component, Index_Mem, ACE_state_t)
end channel
```

For AXI ports, the address write channel **AW** has not an ACE state parameter, but has an additional **Index_Component** parameter, which corresponds to the component at the origin of the transaction.

```
channel AW_CHANNEL_AXI is
  (ACE_OP, Index_Component, Index_Mem, Index_Component)
end channel
```

- The structure of the write data channel W is as follows: the first parameter is the ACE transaction `ACE_OP`, the second one is the index of the communicating component `Index_Component`, the third parameter is the index of the memory line concerned by the read transaction `Index_Mem`, the fourth one is the data to transfer `DATA_T`, and the last one corresponds to the ACE state of the line initiating the write request `ACE_state_t` (added for verification reasons).

```
channel W_CHANNEL is
  (ACE_OP, Index_Component, Index_Mem, DATA_T, ACE_state_t)
end channel
```

For AXI ports, the write data channel W has not an ACE state parameter, but has an additional `Index_Component` parameter, which corresponds to the component at the origin of the transaction.

```
channel W_CHANNEL_AXI is
  (ACE_OP, Index_Component, Index_Mem, DATA_T, Index_Component)
end channel
```

- The structure of the write response channel B is as follows: the first parameter is the ACE transaction `ACE_OP`, the second one is the index of the communicating component `Index_Component`, the third parameter is the index of the memory line concerned by the read transaction `Index_Mem`, the fourth one is the acknowledgment boolean.

```
channel B_CHANNEL is
  (ACE_OP, Index_Component, Index_Mem, (*ACK*) bool)
end channel
```

For AXI ports, the write response channel B has an additional `Index_Component` parameter, which corresponds to the component at the origin of the transaction.

```
channel B_CHANNEL_AXI is
  (ACE_OP, Index_Component, Index_Mem, (*ACK*) bool, Index_Component)
end channel
```

- The structure of the address coherency channel AC is as follows: the first parameter is the ACE transaction `ACE_OP`, the second one is the index of the initiating master `Index_Component`, the third one is the index of the snooped master `Index_Component`, and the fourth parameter is the index of the memory line concerned by the read transaction `Index_Mem`.

```
channel AC_CHANNEL is
  (ACE_OP, (*initiator*) Index_Component,
   (*snooped*) Index_Component, Index_Mem)
end channel
```

- The structure of a coherent response channel CR is as follows: the first parameter is the ACE transaction ACE_OP, the second one is the index of the initiating master Index_Component, the third one is the index of the snooped master Index_Component, the fourth parameter is the index of the memory line concerned by the read transaction Index_Mem, the fifth one is a boolean indicating if there is a corresponding data transfer DataTransfer, the sixth parameter is a boolean indicating whether the data of the memory line is dirty PassDirty, the seventh parameter is a boolean indicating whether the memory line is shared IsShared, and the last one corresponds to the ACE state of the line initiating the write request ACE_state_t (added for verification reasons).

```
channel CR_CHANNEL is
  (ACE_OP, (*initiator*) Index_Component,
   (*snooped*) Index_Component, Index_Mem,
   (*DataTransfer*) bool, (*PassDirty*) bool, (*IsShared*) bool,
   ACE_state_t)
end channel
```

- The structure of the coherency data channel CD is as follows: the first parameter is the ACE transaction ACE_OP, the second one is the index of the initiating master Index_Component, the third one is the index of the snooped master Index_Component, the fourth parameter is the index of the memory line concerned by the read transaction Index_Mem, the fifth one is the data to transfer DATA_T, and the sixth one is a boolean indicating whether the response data is relevant result.

```
channel CD_CHANNEL is
  (ACE_OP, (*initiator*) Index_Component,
   (*snooped*) Index_Component,
   Index_Mem, DATA_T, (*result*) bool)
end channel
```

5.2.4 AXI Slave: Shareable Memory

The shareable memory is modeled by the LNT process shown in Figure 5.2. The five gates AR, R, AW, W, and B correspond to the AXI channels. We use the Boolean `pending_read` to indicate if a read operation is in progress. The behavior of the memory process is a

```

process memory [AR: CHANNEL_AXI_AR, R: CHANNEL_AXI_R,
              AW: CHANNEL_AXI_AW, W: CHANNEL_AXI_W, B: CHANNEL_AXI_B]
              (idMEM: Index_Component)
is
var LINES: Mem_Lines, pending_read: Bool, transR, transW: ACE_Trans,
    ind_R, ind_W: Index_Mem, CPU_R, CPU_W: Index_Component, data: Nat
in
  -- initializations (not included)
  loop select
    when pending_read == false then
      AR (?transR, idMEM, ?indM_R, ?CPU_R);
      pending_read := true
    end when
  []
  when pending_read == true then
    R (transR, idMEM, LINES[Nat(indM_R)], CPU_R);
    pending_read := false
  end when
  []
  AW (?transW, idMEM, ?ind_W, ?CPU_W);
  W (transW, idMEM, ind_W, ?data, CPU_W);
  LINES[Nat(ind_W)] := data;
  B (transW, idMEM, indM_W, true, CPU_W)
  end select end loop
end var end process

```

Figure 5.2 – LNT process representing the shareable memory

non-terminating loop, the body of which is a non-deterministic choice (`select`⁴) between three possibilities:⁵

- Receiving a read request on the AR gate, which is only possible if no read operation is in progress (`pending_read == false`),
- Sending back a read data on the R gate, which is only possible if a previous read request was received (`pending_read == true`),
- Receiving a write request.

In our model, a write operation cannot be interrupted by a read operation.

⁴The LNT construction “`select A [] B [] C end select`” expresses a non-deterministic choice between *A*, *B*, and *C*.

⁵In an LNT rendezvous, an offer “`?x`” accepts any value of the same type as variable *x*, and the received value is stored in variable *x*.

5.2.5 ACE Masters

The cache lines of a master are essentially independent from each other, i.e., transactions on different cache lines can freely interleave.⁶ Hence we choose to model each master by a parallel composition of cache lines. Each cache line is modeled by five mutually recursive LNT processes: (1) process *cpu* initializes the cache line; (2) process *cpu_ready* represents a cache line that is ready to initiate an ACE transaction or to receive a snoop request from the CCI; (3) process *cpu_reply* represents a cache line that has previously initiated an ACE transaction and waits for the reply from the CCI (the cache line is also ready to receive any snoop request from the CCI); (4) process *cpu_snoop* represents a cache line that has previously received a snoop request from the CCI and can either reply to this request or initiate a new ACE transaction; (5) process *cpu_reply_snoop* represents a cache line that has previously initiated an ACE transaction and has also received a snoop request from CCI: thus, it is both waiting for the reply of the ACE transaction and ready to reply to the snoop request. Each of these processes behaves as a large non-deterministic choice between all possible rendezvous. Each branch consists of a guard, a rendezvous with parameters to handle the ongoing transaction, and a recursive call corresponding to the new state of the cache line. For example:

```

if (((LineCache.S==ACE_I) or (LineCache.S==ACE_SC)
    or (LineCache.S==ACE_SD)) and IS_ALLOWED_OP(MakeUnique)
    and ((opfixe==ICN_MakeUnique) or (opfixe==ICN_ALL) ))
then
  AR(MakeUnique, idCPU, LineCache.indM, LineCache.S)
else stop end if;
cpu_reply_1 [AR, R, AW, W, B, AC, CR, CD]
  (idCPU, LineCache, res, IsShared, PassDirty,
   WriteBackInProgress, WriteUniqueInProgress)

```

5.2.6 ACE-Lite Masters

The LNT model of an ACE-Lite master is obtained from the model of a cache line of an ACE master by removing the handling of snoop requests. Thus, an ACE-Lite master is modeled by three mutually recursive LNT processes: a process to initialize the ACE-Lite master, a process *lite_ready*, which can initiate any of the ACE-Lite transactions presented in Section 4.6, and a process *lite_reply*, which waits for a reply from the CCI.

For the transaction on outgoing ACE gates the ACE state is fixed to ACE_I (this state is not used inside the ACE-Lite master).

⁶Actually, the only constraint is to store the same memory line in at most one cache line of a same master.

5.2.7 Cache Coherent Interconnect (CCI)

To ease the modeling of all interleavings between the ports of the CCI, we employ two techniques. First, we model the CCI by a parallel composition of as many processes as there are ports; each port is always ready to receive a request from both the corresponding component and other ports. Second, all received requests are stored in a set and are handled in any order.⁷

The ports of the CCI communicate internally via dedicated gates, which are not part of the ACE specification and can be hidden (in the LTS and in counterexamples), but are useful in the debug phase of the model.

Example 11 The CCI of Figure 5.1 contains four ports: two ACE ports, each communicating with an ACE master, one ACE-Lite port communicating with an ACE-Lite master, and one AXI port communicating with the shareable memory through the non-cache-coherent NoC.

5.3 Modeling Global Ordering Requirements

Following a constraint-oriented specification style, our LNT model integrates these global requirements as *observer processes* (one process per requirement and memory line), composed in parallel with the remainder of the model. Hence, those observers monitor the system and have a global view of all transactions. For horizontal coherency, while handling a snoop transaction, the observer process ensures that a subset of snoop transactions (relative to the same memory line) is not handled before the end of the first transaction. For vertical coherency, the observer process monitors write transactions, prohibiting that an old data overwrites a more recent one.

We call the model containing the observer processes the *constrained model*. By omitting those observers, we obtain an *unconstrained model*, for which the global requirements are not necessarily satisfied.

5.4 State Space Generation

In this section, we present two different configurations of the model, both corresponding to the architecture proposed on Figure 5.1. For each configuration, we present statistics on generated LTS for different sub-configurations (varying the allowed/forbidden sets of transactions).

⁷Because the numbers of masters and cache lines are fixed and each master can issue at most one request per cache line at the same time, the number of requests in a set is bounded by construction.

Table 5.1 – Experimental results: state space generation of shareable focused model configurations

	allowed transactions			global	LTS size	
	m1	m2	lite	constraints	states	transitions
(1)	S_0	$\{\mathcal{A}\}$	S_0	yes	93,481,270	308,087,560
(2)	S_0	$\{\mathcal{A}\}$	S_0	no	105,376,971	351,344,207
(3)	S_0	\emptyset	S_0	yes	7,518,552	21,227,610
(4)	S_1	\emptyset	S_1	yes	3,685,311	10,649,422
(5)	S_1	\emptyset	S_1	no	3,127,707	9,121,134
(6)	S_2	S_2	\emptyset	yes	3,545,801	11,122,536
(7)	S_2	S_2	\emptyset	no	2,819,505	9,095,620
(8)	S_3	\emptyset	S'_3	yes	1,834,195	5,170,829
(9)	S_3	\emptyset	S'_3	no	1,437,412	4,547,398
(10)	S_4	S_4	\emptyset	yes	560,299	1,669,886
(11)	S_4	S_4	\emptyset	no	599,971	1,780,634
(12)	S_5	S_5	\emptyset	yes	40,983	63,922
(13)	S_5	S_5	\emptyset	no	55,439	98,688
(14)	S_6	S_6	\emptyset	yes	25,760	71,121
(15)	S_6	S_6	\emptyset	no	25,760	71,121

In this table, we use those sets of allowed transactions:

$$S_0 = \{ \text{CleanInvalid}, \text{CleanShared}, \text{MakeInvalid}, \text{MakeUnique}, \text{ReadOnce}, \text{ReadShared}, \text{ReadUnique}, \text{WriteBack} \}$$

$\{\mathcal{A}\}$ = the abstract transaction singleton

$$S_1 = \{ \text{MakeUnique}, \text{ReadOnce}, \text{ReadUnique}, \text{WriteBack} \}$$

$$S_2 = \{ \text{MakeInvalid}, \text{MakeUnique}, \text{ReadShared}, \text{ReadUnique}, \text{WriteBack} \}$$

$$S_3 = \{ \text{MakeUnique}, \text{WriteBack} \}, S'_3 = \{ \text{ReadOnce} \}$$

$$S_4 = \{ \text{CleanInvalid}, \text{CleanShared}, \text{ReadUnique}, \text{WriteBack} \}$$

$$S_5 = \{ \text{MakeInvalid}, \text{MakeUnique}, \text{WriteBack} \}$$

$$S_6 = \{ \text{CleanInvalid}, \text{CleanShared}, \text{MakeInvalid} \}$$

5.4.1 Shareable Focused Model

For our analysis, we consider several configurations of our formal model, each consisting of a shareable memory (consisting of three memory lines), one ACE-Lite master, and two ACE masters, with two cache lines each. To focus on coherency issues, the first cache lines of each ACE master execute transactions concerning the same shareable memory line (this is suitable according to [DDHY92]). Each master initiates at most one transaction (chosen from a set of allowed transactions); thus, the second cache line of each ACE master never initiates a transaction (but answers snoop requests). We generate several partial configurations of the ACE specification (i.e., up to eight ACE transactions among fifteen ACE transactions allowed in a shareable region of the memory, this limitation being caused by the state space explosion problem). We selected subsets of transactions that could create problems for properties to verify.

Example 12 For each considered configuration, Table 5.1 gives the size of the corresponding LTS. Column one (respectively, two, or three) gives the set of transactions that master 1 (respectively, master 2, or the ACE-Lite master) is allowed to initiate. Column four tells whether the model includes the observer processes enforcing the global ordering requirements; we generate LTSs for unconstrained models to study the impact of the observers on the properties of the system. The LTS of each constrained model is included in the corresponding unconstrained model with respect to strong bisimulation (i.e., the constraints only remove unsuitable behaviors), but the state space may be larger because a state now also integrates the current state of the observer processes.

5.4.2 Optimized Model

The optimized model introduces the following limitations to the shareable focused configuration: We consider that the shareable memory contains only *one* line and that each ACE master contains only *one* cache line. All transactions issued by the three masters concern the same memory line. Each master initiates at most one transaction (chosen from a set of allowed transactions), except for memory update transactions, for which the master can initiate transactions as long as the ACE state allows.

This optimized model is used to generate complete and partial configurations of the ACE specification (i.e., all the fifteen ACE transactions can be activated).

Example 13 For each considered configuration of the optimized model, Table 5.2 gives the size of the corresponding LTS. We have the same configurations as the Table 5.1 with the new statistics and additional configurations that were previously difficult to generate.

5.5 Model Validation

Modeling is a manual activity, and errors might be introduced during this activity. The formal model must be corrected and validated to have more confidence in it before exploiting the formal model in the validation of the modeled system. Compiling the LNT model with CADP tools was useful to detect (via the error and warning messages raised by the LNT compiler) several introduced problems. After that, we used the backtracking OCIS simulator of CADP to simulate step by step the model to see that the modeled behavior corresponds to the expected behavior.

In the reminder of this section, we aim to automatically verify the conformity of the LNT model with respect to the specification. To this purpose, we write several properties expressed in MCL [MT08]. We start by verifying the absence of deadlocks and livelocks in the model, then we validate the complete and correct execution of separate transactions.

Table 5.2 – Experimental results: state space generation of optimized model configurations

	allowed transactions			global constraints	LTS size	
	m1	m2	lite		states	transitions
(1)	<i>ALL</i>	\emptyset	<i>ALL</i>	yes	2,895,388	7,951,583
(2)	<i>ALL</i>	\emptyset	<i>ALL</i>	no	1,466,479	3,772,056
(3)	<i>ALL</i>	<i>ALL</i>	\emptyset	yes	1,302,386	2,854,974
(4)	<i>ALL</i>	<i>ALL</i>	\emptyset	no	668,318	1,320,481
(5)	S_1	\emptyset	S_1	yes	221,754	608,247
(6)	S_1	\emptyset	S_1	no	88,760	231,369
(7)	S_1	S_1	\emptyset	yes	28,381	52,430
(8)	S_1	S_1	\emptyset	no	21,231	37,644
(9)	S_2	\emptyset	S_2	yes	26,336	53,410
(10)	S_2	\emptyset	S_2	no	16,260	32,635
(11)	S_2	S_2	\emptyset	yes	40,099	76,324
(12)	S_2	S_2	\emptyset	no	24,594	42,748
(13)	S_3	\emptyset	S'_3	yes	196,105	542,049
(14)	S_3	\emptyset	S'_3	no	71,850	189,728
(15)	S_4	\emptyset	S_4	yes	50,882	107,100
(16)	S_4	\emptyset	S_4	no	44,464	94,685
(17)	S_4	S_4	\emptyset	yes	11,125	18,199
(18)	S_4	S_4	\emptyset	no	9,660	16,258
(19)	S_5	\emptyset	S_5	yes	16,421	33,549
(20)	S_5	\emptyset	S_5	no	6,869	13,673
(21)	S_5	S_5	\emptyset	yes	6,004	9,971
(22)	S_5	S_5	\emptyset	no	4,399	7,375
(23)	S_6	\emptyset	S_6	yes	41,585	86,977
(24)	S_6	\emptyset	S_6	no	35,665	76,282
(25)	S_6	S_6	\emptyset	yes	5,102	8,150
(26)	S_6	S_6	\emptyset	no	4,335	7,241

In this table, we use those sets of allowed transactions:

ALL = set of all ACE (respectively ACE-Lite) transactions

$\{\mathcal{A}\}$ = the abstract transaction singleton

$S_1 = \{ \textit{MakeUnique}, \textit{ReadOnce}, \textit{ReadUnique}, \textit{WriteBack} \}$

$S_2 = \{ \textit{MakeInvalid}, \textit{MakeUnique}, \textit{ReadShared}, \textit{ReadUnique}, \textit{WriteBack} \}$

$S_3 = \{ \textit{MakeUnique}, \textit{WriteBack} \}$, $S'_3 = \{ \textit{ReadOnce} \}$

$S_4 = \{ \textit{CleanInvalid}, \textit{CleanShared}, \textit{ReadUnique}, \textit{WriteBack} \}$

$S_5 = \{ \textit{MakeInvalid}, \textit{MakeUnique}, \textit{WriteBack} \}$

$S_6 = \{ \textit{CleanInvalid}, \textit{CleanShared}, \textit{MakeInvalid} \}$

Some of the following MCL formulæ use the macro `inevitable (L)`, which expresses that a transition labeled with L will eventually occur. This macro can be defined as follows:

macro `inevitable (L) =`

```

    mu X . ( < true > true and [ not L ] X )
end_macro

```

This macro expresses inevitability using the minimal fixed point operator (`mu`), which acts as binder for the propositional variable `X`. This macro states that all transition sequences starting at the current state lead to `L` actions after a finite number of steps.

5.5.1 Absence of Deadlocks

To check the absence of deadlock (φ_1), we insert a special `TERMINATION` transition. This enables to distinguish deadlock from normal termination, when all system components have normally terminated and have nothing more to do.

The following MCL formula expresses this property: each sequence not containing a `TERMINATION` label does lead to state with at least one successor:

```

[(not TERMINATION)*] <true> true

```

5.5.2 Absence of Livelocks

To verify the absence of livelocks (φ_2), we check that we reach eventually the `TERMINATION` label.

```

inevitable ( TERMINATION )

```

5.5.3 Complete Execution of Transactions

To verify that every transaction inevitably finishes, we use the following two liveness formulæ (φ_3 and φ_4):

```

[ true * .
  { AR ?op:String ?n:Nat ?l:Nat ... }
] inevitable ( { R !op !n !l } )

```

The first formula φ_3 requires that each action `AR` is eventually followed by a corresponding action `R`. Note the capture of the exchanged values into the variables `op`, `n`, and `l` in the first action predicate (using the LNT-like syntax “*?variable:Type*”, where *Type* is one of the predefined types of MCL) and the use of the captured values in the second action predicate.

```
[ true * .
  { AW ?op:String ?n:Nat ?l:Nat ... }
] inevitable ( { B !op !n !l } )
```

The second formula φ_4 requires that each action AW is eventually followed by a corresponding action B.

5.6 First Industrial Results

The formal model is used inside STMicroelectronics as a reference in discussions with verification engineers and interconnect architects. It helps to understand the new aspects introduced by ACE and to define the verification strategy. In this context, the OCIS interactive step-by-step simulator with backtracking of CADP is found useful.

Modeling the ACE-based SoC helps STMicroelectronics engineers to understand the subtleties of the ACE specification, because the initial specification is not formal. Many problems are discovered just by modeling, before running any tool.

5.7 Discussion

We observe that the properties used to validate the model are *liveness properties* because they express that “something good eventually happens”. Classically, the absence of deadlocks and livelocks properties are *safety properties* expressing that never a deadlock happens or never a livelock happens, but in our case, due to state space generation problem, the model initiates transactions a limited number of times. The model is not completely cyclic.

In the remaining, we present the different exploitations of this formal model. In fact, the formal model is used to validate global properties of the system (Chapter 6), to generate "clever" test cases using model checking results (Chapter 7), and to study the sanity of an interface verification unit (Chapter 8). Those activities are detailed in the three following chapters.

Model Exploitation

Chapter 6

Model Checking System-Level Properties

6.1 Introduction

In this chapter we aim at validating the global coherency of the ACE specification by verifying several system-level properties on our formal model of a generic ACE-based SoC (described in Chapter 5). We notice that the ACE masters and ACE-Lite masters include all the allowed behaviors of the ACE specification. First, we analyze the coherency aspects of the protocol in order to exhibit the coherency requirements of the system. Then, we present the different properties triggered by those requirements. The properties are expressed in MCL (Model Checking Language) [MT08]. Finally, we show the model checking results.

6.2 System-Level Cache Coherency Analysis

The modeled system, described in Section 5.2, presents three aspects of coherency: First, the coherency between the ACE states of the different caches containing the same memory line, which we call *cache line states coherency*. Second, the coherency of the data in different caches or between the caches and the memory, which we call *data integrity*. Third, the coherency of the coherent parameters of ACE transactions regarding the ACE state of the cache line before and after sending the transactions, which we call *messaging consistency*. In this section, we explore the requirements regarding each of these coherency aspects.

Table 6.1 – Cache coherency requirements analysis

	ACE states	Requirement concerning states of other caches	Requirement concerning cache line data
(1)	ACE_UD	ACE_I	nothing
(2)	ACE_UC	ACE_I	equal to memory data
(3)	ACE_SD	ACE_I/ACE_SC	equal to data of ACE_SC, if any
(4)	ACE_SC	ACE_I/ACE_SC/ACE_SD	equal to data of ACE_SD/ACE_SC, if any
(5)	ACE_I	nothing	nothing

6.2.1 Cache Line States Coherency Requirements

ACE specification defines five cache line states (presented on Section 4.4). For each state we deduce requirements concerning the ACE state of any cache line of another master containing the same memory line.

Column two of Table 6.1 presents the requirements for ACE state of other caches for each cache line state (column one).

For a cache line in a unique state (ACE_UD or ACE_UC), the other copies of the same memory line must be invalid (ACE_I). For a cache line in a shared dirty state (ACE_SD), the other copies of the same memory line must be invalid (ACE_I) or in a shared clean state (ACE_SC). For a cache line in a shared clean state (ACE_SC), the other copies of the same memory line must be either invalid or shared. Besides, if the cache line is in an invalid state (ACE_I), there is no requirement for the other cache lines containing the same memory line.

6.2.2 Data Integrity Requirements

Data integrity of the system consists in two different aspects:

- First, the cache line data has to respect the cache line states as presented in the third column of Table 6.1: If the cache line is in a unique clean state (ACE_UC), the data has to be equal to the data stored in the shareable memory. If the cache line is shared (ACE_SD or ACE_SC), the data of any other copy of the same memory line has to be equal to the data in the cache line.
- Second, the data integrity of the shareable memory should be maintained. We have to monitor the order of write operations to the shareable memory. We have to check that an old data never erases a newer one.

6.2.3 Messaging Consistency Requirements

Messaging consistency deals with the coherency parameters, namely, the `PassDirty` and `IsShard` parameters present both in the read response channel `R` and the coherency response channel `CR`.

For the read response channel `R`, the consistency encompasses three different requirements:

- For a subset of ACE transactions, the initiating master (called also Initiator within STMicroelectronics) cannot accept to get the responsibility of writing back the data on the shareable memory, i.e., the `PassDirty` parameter must never be asserted (i.e., `PassDirty==False`).
- For another subset of ACE transactions, the initiator must have the memory line in a unique state, i.e., the `IsShared` parameter must never be asserted (i.e., `IsShared==False`).
- For the *ReadNotSharedDirty* transaction, the initiator must never have the memory line in a shared dirty state, i.e., the `PassDirty` and the `IsShared` parameters cannot be asserted at the same time.

For the coherency response channel `CR`, the parameters depend on the snooped master cache line state before and after the `CR` request. In fact, the `PassDirty` parameter is asserted if and only if the cache line state before the request is dirty and the cache line state after the request is clean or invalid. The `IsShared` parameter is asserted if the cache line after the request is in a valid state (`ACE_UD`, `ACE_UC`, `ACE_SD`, or `ACE_SC`) and deserted if the cache line after the request is invalid.

6.3 System-Level Properties

Each requirement leads to one or more system-level properties to be checked on the model. Some properties can be expressed by a state-based view, e.g., properties concerning an ACE state of a cache line. Those properties are translated to an equivalent action-based view handling only actions expressed by the transitions of the LTS (see Fig. 6.1).

In practice, when formalizing properties, we can introduce a *false positive* error: the property does not really check the behavior and the result is `TRUE` (e.g., a syntax error in the property action with regard to the corresponding model transitions). So we suggest to change slightly the sense of the property to have an evident error and if the check is not failed the property has to be corrected.

In this section, we present a selection of representative examples of the MCL formulæ expressed in order to check the requirements corresponding to the different coherency

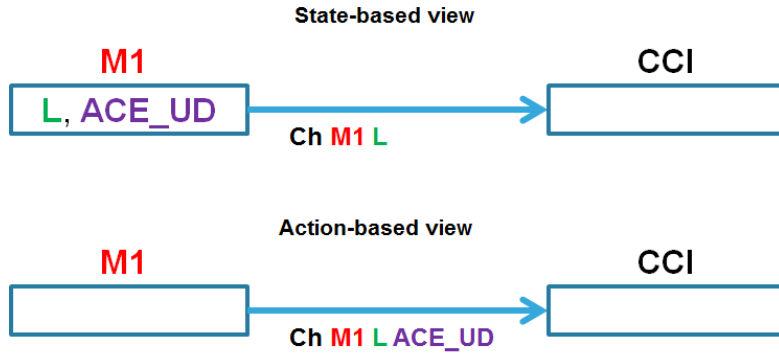

Figure 6.1 – State-based and action-based view of a cache line

aspects. The exhaustive description of the MCL formulæ written in the scope of this thesis to verify the ACE specification is presented in Appendix A.

6.3.1 Cache States Coherency

To verify the coherency of the ACE states of all the caches of the system, we have to translate the state-based properties to action-based properties, using information about the ACE state added to transactions issued by cache lines (see Section 5.2.2).

The cache states coherency requirements lead to four safety formulæ, each of which corresponds to a valid cache line state (ACE_UD, ACE_UC, ACE_SD, and ACE_SC).

Those formulæ use the macro `ace_state (s)`, which is a predicate that holds if and only if the string `s` is an ACE state. This macro is defined as follows:

```
macro ace_state (s) =
  ((s="ACE_I") or (s="ACE_UD") or (s="ACE_SD") or (s="ACE_UC") or (s="ACE_SC"))
end_macro
```

Cache states coherency renaming

To simplify the form of the MCL formulæ corresponding to the cache state coherency properties and to improve the performance of the model checker, we use an SVL script (shown below) to apply a renaming of all the labels of the model. For each label, we only keep the ACE channel gate and four parameters. Those parameters are (1) the ACE transaction, (2) the initiator master, (3) the memory line, and (4) the ACE state. The internal gates (starting by `FW`) are replaced by internal LNT gates `i`. The branching reduction is applied on the renamed model: some interleavings of internal gates are removed.

```

"renameCacheStateCoherency.bcg" =
  branching reduction of
    total rename
  "\([A-Z]* ![A-Z]* ![0-9] ![0-9]\) ![0-9] \(![A-Z]*_[A-Z]*\)"
                                     -> "\1 \2",
  "\([A-Z]* ![A-Z]*\) ![0-9] \(![0-9] ![0-9]\) ![A-Z]* ![A-Z]* \(![A-Z]*_[A-Z]*\)"
                                     -> "\1 \2 \3",
  "\([A-Z]* ![A-Z]*\) ![0-9] \(![0-9] ![0-9]\) ![0-9] ![A-Z]* \(![A-Z]*_[A-Z]*\)"
                                     -> "\1 \2 \3",
  "FW_[A-Z]* [A-Za-z0-9_ !]*"
                                     -> "i"
                                     in "model.bcg";

```

Unique dirty coherency

As a sample, we present the cache state coherency formula concerning the unique dirty state (φ_5). The latter requires that if a cache line (master $m1$, memory line l) is in the state `ACE_UD` (the cache line is unique and modified), then as long as the line does not change its status, all cache lines of other masters ($m2 \neq m1$) containing the same memory line (l) must be in the state `ACE_I` (the cache line is invalid). This is a state-based property. The corresponding action-based property expresses that if an action `{?Ch m1 l ACE_UD}` happens then while there is no action `{?Ch m1 l s1 where s1 \neq ACE_UD}`, we check whether an action `{?Ch m2 l s2 where m2 \neq m1 and s1 \neq ACE_I}` happens. If this is the case, then the property is not satisfied (`false`).

The MCL formula expressing this action-based property is the following:

```

[ true * .
  {?Ch:String ?op:String ?m1:Nat ?l:Nat !"ACE_UD"} .
  ( not ({?Ch:String ?op:String !m1 !l ?s1:String
    where ace_state (s1) and (s1<>"ACE_UD")}) ) * .
  {?Ch:String ?op:String ?m2:Nat !l ?s2:String
    where (m2<>m1) and ace_state (s2)
    and (s2<>"ACE_I")}
] false

```

Notice that the *unique clean coherency* (φ_6), the *shared dirty coherency* (φ_7), and the *shared clean coherency* (φ_8) formulæ are described in Appendix A.

6.3.2 Data Integrity

To verify the data integrity, we have to check four different properties, one concerning the write ordering on the shareable memory and three others concerning the data integrity corresponding to some cache line states (namely, `ACE_UC`, `ACE_SD`, and `ACE_SC`). The

other cache lines do not lead to data integrity issues.

Data integrity renaming

To simplify the form of the MCL formulæ corresponding to the data integrity properties and to improve the performance of the model checker, we use an SVL script (shown bellow) to apply a renaming of all the labels of the model. For each label, we only keep the ACE channel gate and up to five parameters. Those parameters are (1) the ACE transaction, (2) the initiator master, (3) the memory line, (4) the memory data (if any), and (5) the ACE state. The internal gates (starting by FW), are replaced by internal LNT gates *i*. Then, the branching reduction is applied on the renamed model: the interleaving of internal gates is removed.

In the remaining, transactions have two possible structures: transactions with data (an LNT gate with five parameters) and transactions without data (an LNT gate with four parameters).

```
renameDataIntegrity.bcg" =
  branching reduction of
    total rename
  "\([A-Z]* ![A-Z]*\) ![0-9] \(![0-9] ![0-9]\) ![A-Z]* ![A-Z]* ![A-Z]* \(![A-Z]*_[A-Z]*\)\"
                                     -> "\1 \2 \3",
  "\([A-Z]* ![A-Z]*\) ![0-9] \(![0-9] ![0-9] ![0-9]\) ![A-Z]* \(![A-Z]*_[A-Z]*\)\"
                                     -> "\1 \2 \3",
  "FW_[A-Z]* [A-Za-z0-9_ !]*"
                                     -> "i"
                                     in "model.bcg";
```

Unique clean data integrity

The unique clean state requires that the data in the cache line (*data1*) must be equal to the data in the shareable memory (*data2*). Once we detect an *ACE_UC* state and as long as the line does not change its status, we require that *data2* (data in the shareable memory) is equal to *data1*.

In the action-based view, an action containing an *ACE_UC* state can be a data transfer action (action with data) or a control action (action without data). Each case corresponds to a different MCL formula (two formulæ are expressed).

The first formula (φ_9) concerns a data transfer action with an *ACE_UC*. In this case, when we observe an action $\{?Ch !m1 !l !data1 !ACE_UC\}$, then as long as there is neither an action $\{?Ch !m1 !l !s1 \text{ where } s1 \langle \rangle ACE_UC\}$ (action without data) nor an action $\{?Ch !m1 !l !data !s1 \text{ where } s1 \langle \rangle ACE_UC\}$ (action with data), we check whether an action $\{R !0 !l !data2 \text{ where } data2 \langle \rangle data1\}$ happens. In fact, the read response *R* from the shareable memory *0* is the only outgoing data transfer transaction from the

memory. If such a response occurs, the property is not satisfied (**false**).

The formula φ_9 is expressed as follows:

```
[ true * .
  {?Ch:String ?op:String ?m1:Nat ?l:Nat ?data1:Nat !"ACE_UC"} .
  (
    not ({?Ch:String ?op:String !m1 !l ?any of Nat ?s:String
          where ace_state (s) and (s<>"ACE_UC")})
    and
    not ({?Ch:String ?op:String !m1 !l ?s:String
          where ace_state (s) and (s<>"ACE_UC")})
  )* .
  {R ?op:string !"0" !l ?data2:Nat ?m2:Nat
   where (data2<>data1)}
] false
```

The second formula (φ_{10}) concerns a control action with an ACE_UC state. The data transfer containing the data happens in a different action. In the beginning, we save the data present in an action with a different cache state than ACE_UC $\{?Ch !m1 !l !data !s1 \text{ where } s1<>\text{ACE_UC}\}$, then we note an action $\{?Ch !m1 !l !\text{ACE_UC}\}$. As long as there is neither an action $\{?Ch !m1 !l !s1 \text{ where } s1<>\text{ACE_UC}\}$ (action without data) nor an action $\{?Ch !m1 !l !data !s1 \text{ where } s1<>\text{ACE_UC}\}$ (action with data), we check whether an action $\{R !0 !l !data2 \text{ where } data2<>data1\}$ happens. If such a response occurs, the property is not satisfied (**false**).

The formula φ_{10} is expressed as follows:

```
[ true * .
  {?Ch:String ?op:String ?m1:Nat ?l:Nat ?data1:Nat ?s:String
   where ace_state (s) and (s<>"ACE_UC")} .
  (not {?Ch:String ?op:String ?m1:Nat ?l:Nat !"ACE_UC"})* .
  {?Ch:String ?op:String ?m1:Nat ?l:Nat !"ACE_UC"} .
  (
    not ({?Ch:String ?op:String !m1 !l ?h:Nat ?s:String
          where ace_state (s) and (s<>"ACE_UC")})
    and
    not ({?Ch:String ?op:String !m1 !l ?s:String
          where ace_state (s) and (s<>"ACE_UC")})
  )* .
  {R ?op:string !"0" !l ?data2:Nat ?m2:Nat
   where (data2<>data1)}
```

```
] false
```

Notice that the *shared dirty data integrity* ($\varphi_{11}, \varphi_{12}$) and the *shared clean data integrity* ($\varphi_{13}, \varphi_{14}$) formulæ are described in Appendix A.

Shareable memory data integrity

The following formula (φ_{15}) requires correct order of write operations to the shareable memory:

```
[ true * .
  {W !"WRITEBACK" ?m:Nat ?l:Nat ?d:Nat}.
  (not{W !"WRITEBACK" !0 !l !d !m})*.
  {W !"WRITEBACK" !0 !l !d !m}.
  ( (not{AC ... !m ?any of Nat !l}) and
    (not{W ?any of String !0 !l ?any of Nat ...}) )*.
  {W ?any of String !0 !l ?h:Nat ... where h<>d}
] false
```

Once a master m initiates a memory update (*WriteBack* transaction: first action on gate W) of a memory line l and a data d , and this update is actually written to memory (second action on gate W , with port number 0 , i.e., the memory) as second offer, the property forbids a data h different from d to be written to the same memory line l without previously receiving a snoop request (gate AC) concerning line l ¹.

6.3.3 Consistency of Coherency Parameters

First, we start by three consistency properties corresponding to the coherency parameters of the read response channel R , then we present properties relative to the coherency response channel CR .

Read response no PassDirty property

According to the ACE specification [ARM13], for several transactions (i.e., *ReadOnce*, *ReadClean*, *CleanUnique*, *MakeUnique*, *CleanShared*), the master initiating the transaction cannot take the responsibility to write the data on the memory, so the *PassDirty* parameter of the read response channel R has to be deserted (**false**).

¹The number of parameters differs for the rendezvous on gate W between the CCI and the memory and those between a master and the CCI: for the former, the fifth parameter corresponds to index of the initiator.

As described in Section 5.2.3, the sixth parameter of a read response channel R is a boolean corresponding the `PassDirty` parameter and the seventh parameter is a boolean corresponding to the `IsShared` parameter.

We add the following formula (φ_{16}), which checks the correct positioning of the `PassDirty` parameter:

```
[
  true * .
  {AR ?"READONCE"|"READCLEAN"|"CLEANUNIQUE"|"MAKEUNIQUE"|"CLEANSHARED"
    ?m:Nat ?l:Nat ?any of String}.
  (
    not({R !op !m !l ?any of Nat ?any of bool ?any of bool ?any of bool})
  )*.
  {R !op !m !l ?any of Nat ?any of bool !"TRUE" ?any of bool}
] false
```

The formula φ_{16} concerns read address AR actions containing one of the following transactions: *ReadOnce*, *ReadClean*, *CleanUnique*, *MakeUnique*, or *CleanShared*. In fact, the corresponding read response R action (same transaction `op`) must have the `PassDirty` parameter deserted. If this is not the case (i.e., `PassDirty==TRUE`), the property is not satisfied (`false`).

Notice that the *read response no IsShared* (φ_{17}) and the *read response no IsSharedDirty* (φ_{18}) formulæ are described in Appendix A.

Coherency response renaming

To simplify the form of the MCL formulæ corresponding to the coherency response parameters properties and to improve the performance of the model checker, we use an SVL script (shown below) to apply a renaming of all the labels of the model except `CR` gates: for each label, we only keep the ACE channel gate and four parameters which are the ACE transaction, the initiator master, the memory line, and the ACE states. For the coherency response `CR` actions, we preserve all the parameters. The internal gates (starting by `FW`) are replaced by internal LNT gates `i`. Then the branching reduction is applied on the renamed model: the interleaving of internal gates is removed.

```
"renameCoherencyResponse.bcg" =
  branching reduction of
    total rename
    "\([A-Z][^R]*![A-Z]*![0-9]![0-9]\)![0-9]\(![A-Z]*_[A-Z]*\)"
    -> "\1 \2",
```



```

"\([A-Z][^R]* ![A-Z]*\) ![0-9] \(![0-9] ![0-9]\) ![A-Z]* ![A-Z]* ![A-Z]*
 \(![A-Z]*_[A-Z]*\) "          -> "\1 \2 \3",
"\([A-Z][^R]* ![A-Z]*\) ![0-9] \(![0-9] ![0-9]\) ![0-9] ![A-Z][A-Z]*
 \(![A-Z][A-Z]*_[A-Z]*\) "     -> "\1 \2 \3",
"CR \(![A-Z]* ![0-9] ![0-9] ![0-9] ![A-Z]* ![A-Z]* ![A-Z]* ![A-Z]*\)
                                -> "CR \1",
"FW_[A-Z]* [A-Za-z0-9_ !]*"     -> "i"
                                in "model.bcg";

```

Coherency response PassDirty property

The `PassDirty` parameter of the coherency response channel `CR` has to be asserted (`true`) if and only if the ACE state before the `CR` request is either `ACE_UD` or `ACE_SD` and the ACE state after the `CR` request is either `ACE_UC`, `ACE_SC`, or `ACE_I`.

As described in Section 5.2.3, the sixth parameter of a coherent response channel `CR` is a boolean corresponding to the `PassDirty` parameter and the seventh parameter is a boolean corresponding to the `IsShared` parameter.

The corresponding formula (φ_{19}) expresses that if the ACE state switches from a dirty state to a clean or invalid state during a coherent response `CR` action, the `PassDirty` must be asserted. If it is not the case, the property is not satisfied (`false`).

The formula φ_{19} is expressed as follows:

```

[
  true * .
  {?Ch:String ?op:String ?m:Nat ?l:Nat ?"ACE_UD"|"ACE_SD"} .
  (
    ( not({?Ch:String ?op:String !m !l ?s:String})
      and ( not{CR ?op:String !m !l ...} ) ) * .
  ) * .
  {CR ?op:String !m !l ?any of Nat ?any of bool !"FALSE" ?any of bool} .
  (
    ( not({?Ch:String ?op:String !m !l ?s:String})
      and ( not{CR ?op:String !m !l ...} ) )
  ) * .
  {?Ch:String ?op:String !m !l ?"ACE_UC"|"ACE_SC"|"ACE_I"}
] false

```

Notice that the *coherency response no PassDirty* ($\varphi_{20}, \varphi_{21}$), the *coherency response IsShared* (φ_{22}) and the *coherency response no IsShared* (φ_{18}) formulæ are described in Appendix A.

Table 6.2 – Model checking results: cache state coherency

	allowed transactions			properties			
	m1	m2	lite	φ_5	φ_6	φ_7	φ_8
(1)	S_0	S_0	\emptyset	×	×	✓	×
(2)	S_0	\emptyset	S_0	×	×	✓	×
(3)	S_1	S_1	\emptyset	×	✓	✓	✓
(4)	S_1	\emptyset	S_1	✓	✓	✓	✓
(5)	S_2	S_2	\emptyset	×	×	✓	✓
(6)	S_3	\emptyset	S'_3	×	✓	✓	✓
(7)	S_4	S_4	\emptyset	×	✓	✓	✓
(8)	S_5	S_5	\emptyset	✓	×	✓	✓
(9)	S_6	S_6	\emptyset	✓	✓	✓	✓

In Table 6.2, Table 6.3, and Table 6.4, those sets of allowed transactions are used:

- $S_0 =$ set of all ACE (respectively ACE-Lite) transactions
- $\{\mathcal{A}\} =$ *Onlytheabstracttransaction*
- $S_1 = \{ \textit{MakeUnique}, \textit{ReadOnce}, \textit{ReadUnique}, \textit{WriteBack} \}$
- $S_2 = \{ \textit{MakeInvalid}, \textit{MakeUnique}, \textit{ReadShared}, \textit{ReadUnique}, \textit{WriteBack} \}$
- $S_3 = \{ \textit{MakeUnique}, \textit{WriteBack} \}, S'_3 = \{ \textit{ReadOnce} \}$
- $S_4 = \{ \textit{CleanInvalid}, \textit{CleanShared}, \textit{ReadUnique}, \textit{WriteBack} \}$
- $S_5 = \{ \textit{MakeInvalid}, \textit{MakeUnique}, \textit{WriteBack} \}$
- $S_6 = \{ \textit{CleanInvalid}, \textit{CleanShared}, \textit{MakeInvalid} \}$

6.4 Model-Checking Results

In this section we report the results of the automatic model checking for each kind of properties on the different configurations presented in Section 5.4.2.

We start by checking the properties on the biggest configurations (all the ACE transactions allowed in two among three masters), corresponding to the largest LTSs that we can generate, i.e., (1) (S_0, S_0, \emptyset) and (2) (S_0, \emptyset, S_0) either with or without global ordering constraints. When a property is satisfied for a configuration, then all smaller configurations will satisfy this property. We only present results for unconstrained configurations because the constrained configurations satisfy all the properties.

6.4.1 Cache State Coherency Results

The model checking results of the properties (φ_5) , (φ_6) , (φ_7) , and (φ_8) (see Sec. 6.3.1) are given in columns five to eight of Table 6.2.

For the unconstrained configurations, unique dirty coherency (φ_5) and unique clean coherency (φ_6) formulæ may not be satisfied (×). In this case, EVALUATOR 4.0 generates minimal counterexample sequences, which correspond to scenarios to be tested

Table 6.3 – Model checking results: : data integrity

	allowed transactions			properties						
	m1	m2	lite	φ_9	φ_{10}	φ_{11}	φ_{12}	φ_{13}	φ_{14}	φ_{15}
(1)	S_0	S_0	\emptyset	\times	\checkmark	\checkmark	\checkmark	\checkmark	\checkmark	\times
(1)	S_0	\emptyset	S_0	\times	\times	\times	\times	\times	\checkmark	\times
(2)	S_1	\emptyset	S_1	\checkmark	\checkmark	\checkmark	\checkmark	\checkmark	\checkmark	\times
(3)	S_2	S_2	\emptyset	\checkmark	\checkmark	\checkmark	\checkmark	\checkmark	\checkmark	\checkmark
(4)	S_3	\emptyset	S'_3	\checkmark	\checkmark	\checkmark	\checkmark	\checkmark	\checkmark	\times
(5)	S_4	S_4	\emptyset	\checkmark	\checkmark	\checkmark	\checkmark	\checkmark	\checkmark	\checkmark
(6)	S_5	S_5	\emptyset	\checkmark	\checkmark	\checkmark	\checkmark	\checkmark	\checkmark	\checkmark
(7)	S_6	S_6	\emptyset	\checkmark	\checkmark	\checkmark	\checkmark	\checkmark	\checkmark	\checkmark

on any implementation of the ACE specification in order to verify the implementation mechanisms in charge to guarantee the cache coherency.

The shared dirty coherency (φ_7) and unique clean coherency (φ_8) are satisfied on the largest configurations (accordingly, in all configurations). There is no need for additional mechanisms in the implementation to guarantee the coherency. Then, no specific tests have to be added.

Some unconstrained configurations can satisfy all properties because the subset of ACE transactions activated do not present any violation of the properties, e.g., the configuration (S_6, S_6, \emptyset) .

All the configurations containing only one active ACE master and one active ACE-Lite master satisfy the cache state coherency properties because of the presence of at most one cache line per memory line.

6.4.2 Data Integrity Results

The verification results of the properties (φ_9), (φ_{10}), (φ_{11}), (φ_{12}), (φ_{13}), (φ_{14}), and (φ_{15}) (see Sect. 6.3.2) are given in columns five to eleven of Table 6.3.

For unconstrained configurations, data integrity of the shareable memory property (φ_{15}) may not be satisfied (\times). In this case, EVALUATOR 4.0 generates minimal counterexample sequences.

The data integrity properties corresponding to cache line states (φ_9 , φ_{10} , φ_{11} , φ_{12} , φ_{13} , and φ_{14}) are satisfied on the largest configurations (accordingly, in all the configurations). There is no need for additional mechanisms in the implementation to guarantee coherency. Then, no specific tests must be added for the data integrity against the cache line states.

Table 6.4 – Model checking results: coherency parameters

	allowed transactions			properties							
	m1	m2	lite	φ_{16}	φ_{17}	φ_{18}	φ_{19}	φ_{20}	φ_{21}	φ_{22}	φ_{23}
(1)	S_0	$\{\mathcal{A}\}$	S_0	✓	✓	✓	✓	✓	✓	✓	✓
(2)	S_1	\emptyset	S_1	✓	✓	✓	✓	✓	✓	✓	✓
(3)	S_2	S_2	\emptyset	✓	✓	✓	✓	✓	✓	✓	✓
(4)	S_3	\emptyset	S'_3	✓	✓	✓	✓	✓	✓	✓	✓
(5)	S_4	S_4	\emptyset	✓	✓	✓	✓	✓	✓	✓	✓
(6)	S_5	S_5	\emptyset	✓	✓	✓	✓	✓	✓	✓	✓
(7)	S_6	S_6	\emptyset	✓	✓	✓	✓	✓	✓	✓	✓

6.4.3 Consistency of Coherency Parameters Results

The verification results of the properties (φ_{16} , φ_{17} , φ_{18} , φ_{19} , φ_{20} , φ_{21} , φ_{22} , and φ_{23}) presented in Section 6.3.3 over the LTSs of Section 5.4.2 are given in columns five to twelve of Table 6.4.

All the properties corresponding to the consistency of the coherency parameters are satisfied on the largest configurations (accordingly, in all the configurations). There is no need for additional mechanisms in the implementation to guarantee the coherency. Then, no specific tests must be added for this category of properties.

6.4.4 Example of a Non Satisfied Property

The model checking of the property corresponding to the data integrity of shareable memory (φ_{15}) over the configuration (S_0, \emptyset, S_0) produces the counterexample presented in Figure 6.2.

We generate a minimal configuration of the formal model activating only the ACE transactions present on the counterexample (S_3, \emptyset, S'_3) . This configuration, without the global ordering constraints, produces the same counterexample. This configuration introduces only three ACE transactions and it is sufficient to violate the data integrity property.

The data integrity property is violated because of the concurrency between two write operations on the shareable memory. The first one is initiated by the ACE master (*WriteBack* transaction), and the second one is initiated by the CCI. In fact, the CCI has to respond to a *ReadOnce* transaction and has to take the responsibility to write back the data in the memory (*PassDirty=true*), because the master initiating the *ReadOnce* cannot take this responsibility: recall that *ReadOnce* is a “non-cachable” read. It means that the memory line is not stored on the master cache if the cache exists. In this case, the master is an ACE-Lite master, there is no cache to store the memory line.

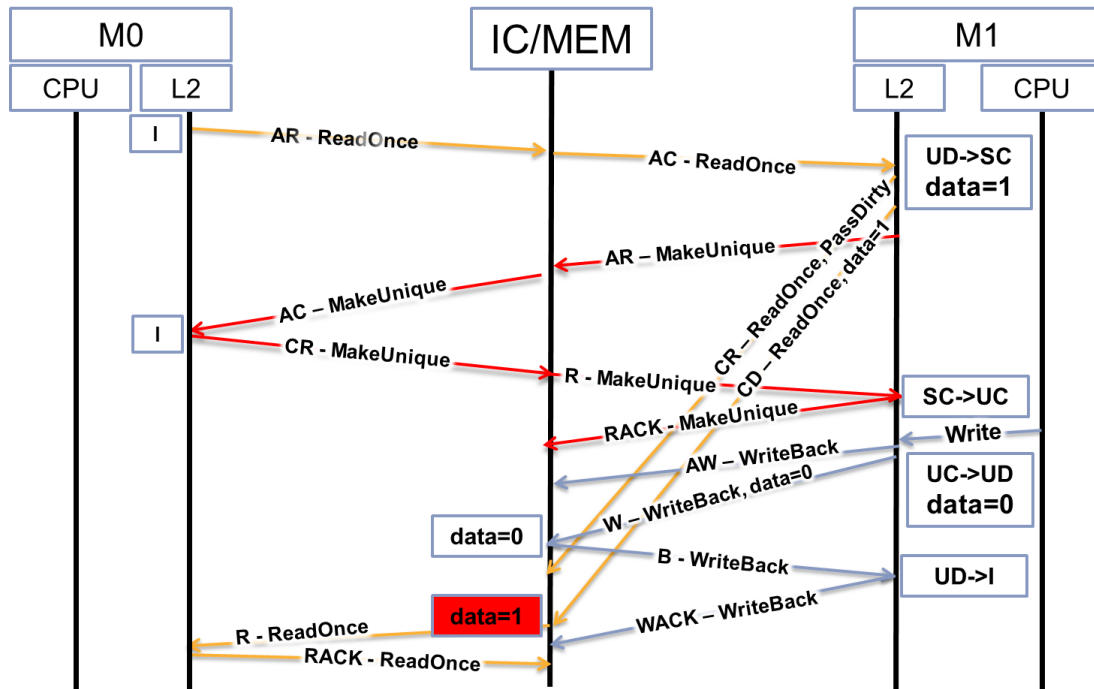

Figure 6.2 – Data integrity counterexample

To verify the existence of additional scenarios, on the model, leading to this data integrity violation, we deactivate one of the transactions participating on the first counter-example. EVALUATOR 4.0 model checker will produce another counterexample (if any), otherwise the property is satisfied in the new configuration. This approach will be explored in the Chapter 7 within the model-based test generation activity.

6.4.5 Reproduction of a Previously Fixed Bug

In a previous version of the ACE specification, a data integrity bug was detected (by Jasper in 2011 using white-box verification techniques using the Mur ϕ model checker [Dil96]). To validate our model and our methodology based on black box verification techniques, we try to reproduce this bug.

ARM fixed the bug by changing the ACE specification. The new version forbids the transition from an ACE_UD cache line state to an ACE_UC cache line state, after the reception of a *ReadOnce* snoop transaction.

We re-allow this transition and we check the data integrity of the shareable memory property (φ_{15}). The EVALUATOR 4.0 model checker produces the counterexample presented on the Fig. 6.3.

Indeed, we have reproduced automatically the same counterexample using our methodol-

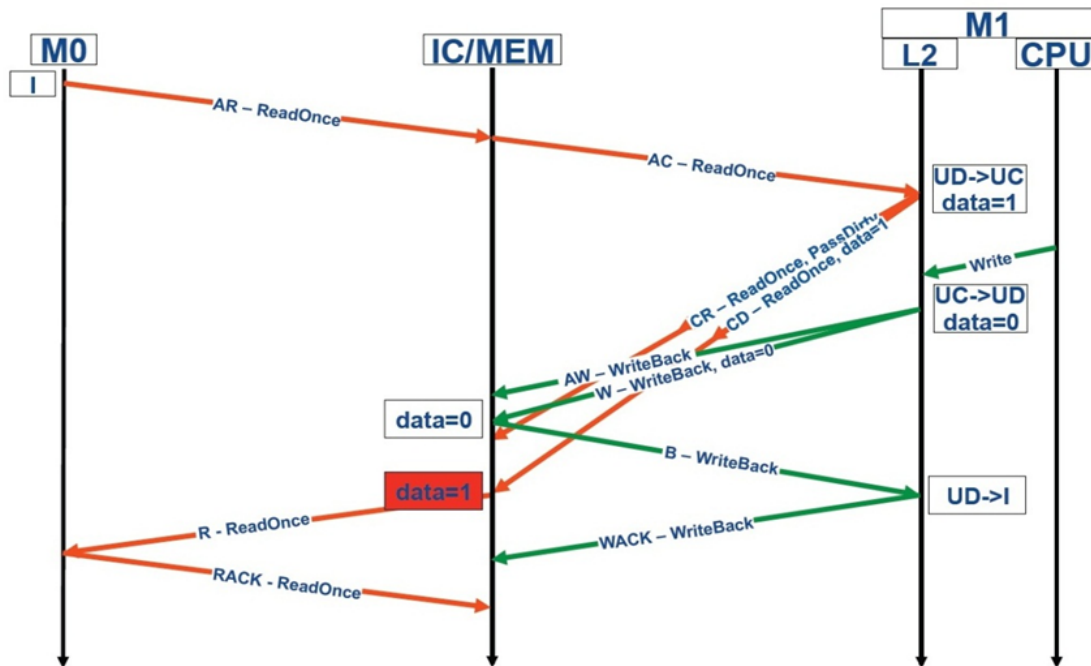

Figure 6.3 – Fixed data integrity counterexample

ogy. In addition to that, we can also catch more depth counterexamples in the current version of ACE specification, e.g., the scenario presented in Figure 6.2.

6.5 Conclusion

The properties presented in this chapter are expressed as *safety properties* (i.e., they express that “nothing bad happens”). Thus, we verified that incorrect behavior does not occur in the model.

Some properties are not satisfied by the unconstrained model, it means that the ACE specification expresses global requirements that must be guaranteed by any implementation of the ACE protocol with specific mechanisms.

In the remaining, we aim at verifying the correct implementation of those global requirements on the industrial implementation of the ACE protocol by generating tests from the model focusing on those detected corner cases.

Chapter 7

From Temporal Logic Properties to Clever Test Cases

7.1 Introduction

An interesting idea for the generation of directed tests is to focus on and derive tests from potential faults of the DUV [MSK⁺07, WAW09]. For system-level protocols, in order to obtain a description of potential faults corresponding to the global requirements of the SoC, we suggest to use system-level properties together with a model containing faults. In our case, we use the unconstrained model (see Sec. 5.3). Applying the theory of conformance testing [Tre92], we generate abstract test cases, which then have to be translated to the input language of a commercial CDTG solver to randomly complete interface-level details and finally to run the tests on the RTL test bench.

Because we found the generation of abstract test cases directly from the complete model to be impractical, we suggest to use information contained in counterexamples to select *interesting configurations* of the formal model, which still contain violations of the global requirements, and to extract abstract test cases from the selected configurations.

In this chapter, we present our approach to generate abstract test cases from the formal model. Figure 7.1 gives an overview of our test generation approach. First, we present an algorithm to compute a comprehensive set of interesting configurations, which contain faults. Second, we present a counterexample-based test-generation flow and its benefits for test generation. Then, we show the impact of our approach on the improvement of test benches and the corresponding industrial results.

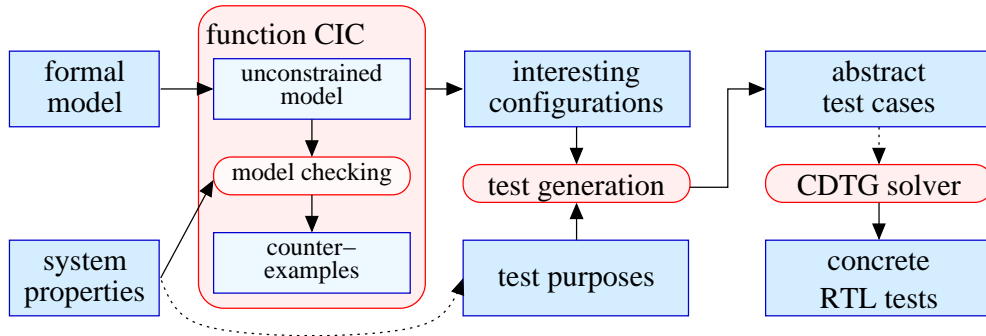

Figure 7.1 – Model-based test generation flow

```

function CIC ( $\varphi$ : Property,  $\mathcal{F}$ : Set of Transaction): Set of (Set of Transaction) is
  if Model( $\mathcal{F}$ )  $\models \varphi$  then
    return  $\emptyset$ 
  else
    let  $\Delta$  be a minimal-depth counterexample ;
    result :=  $\emptyset$  ;
    for each transaction T occurring in  $\Delta$  do
      result := result  $\cup$  CIC ( $\varphi$ ,  $\mathcal{F} \cup \{T\}$  )
    end for ;
    if result =  $\emptyset$  then result := {  $\mathcal{F}$  } end if ;
    return result
  end if
end function
    
```

Figure 7.2 – Function CIC to compute a set of interesting configurations containing faults

7.2 Computation of Interesting Configurations Containing Faults

Among the properties we considered (see Chapter 6), only three properties do not hold for the unconstrained model, namely unique dirty coherency (φ_5), unique clean coherency (φ_6) and shareable memory data integrity (φ_{15}).

Counterexamples of a desired property provide interesting scenarios to test corner cases. To improve test coverage, it is interesting to have as many different counterexamples as possible. However, on-the-fly model checking provides at most *one* counterexample for each property φ and configuration of the model, because the model checker stops as soon as it detects a violation of the property. Therefore, we take advantage of the parametrization of our formal model, by varying the set \mathcal{F} of forbidden ACE transactions, to compute with the recursive function CIC (*compute interesting configurations*) shown in Fig. 7.2 a comprehensive set of *interesting configurations* of the Model(\mathcal{F}) containing faults.

Initially, all fifteen ACE transactions are allowed, i.e., we call $\text{CIC}(\varphi, \emptyset)$. Function CIC proceeds as follows. First, we configure the model to exclude the transactions in \mathcal{F} , and model check property φ . If φ is not satisfied, the model checker produces a counterexample Δ . We use the breadth-first search algorithm of EVALUATOR 4.0 to produce a counterexample of minimal depth, and avoid spurious actions in the counterexample. For each transaction T occurring in Δ , we call CIC recursively, deactivating T in addition to \mathcal{F} . Function CIC terminates, because the parameter \mathcal{F} has an upper bound (the set of all transactions) and it strictly increases for each recursive call.

The set of interesting configurations $\{\text{Model}(\mathcal{F}_1), \dots, \text{Model}(\mathcal{F}_n)\}$ corresponding to the set $\{\mathcal{F}_1, \dots, \mathcal{F}_n\}$ computed by CIC has the following property: a configuration $\text{Model}(\mathcal{F}')$ does not satisfy the property φ if and only if \mathcal{F}' is included in or equal to at least one combination \mathcal{F}_i .

We applied CIC to the three properties that were invalid on the unconstrained model (see Sec. 6.4). Altogether, Shareable Memory Data Integrity yields 21 interesting configurations (14 from an architecture with two ACE masters initiating transactions, and 7 from an architecture with one ACE-Lite master and one ACE master initiating transactions), Unique Dirty Coherency yields 18 interesting configurations from an architecture with two ACE masters initiating transactions (with only one ACE master, i.e., a single cache, Unique Dirty Coherency holds trivially) and Unique Clean Coherency yields 34 interesting configurations from an architecture with two ACE masters initiating transactions.

7.3 Model Checking Based Test Generation

We aim at generating as many tests as possible leading to invalidation of the property for each interesting configuration. We call those tests *negative tests*, because if a test succeeds, we detect a failure of the system; but if the system is correct, all tests will fail.

Our test generation approach is based on the theory of conformance testing [Tre92], i.e., we compute from a specification of a system and a *test purpose* [JJ05] (see the Sec. 2.5.3) a set of abstract test cases. Thus, we express the negation of each property as a test purpose in LNT.

7.3.1 Unique Dirty Cache State Coherency Test Purpose

The LNT code for the test purpose corresponding to the Unique Dirty Cache Coherency is shown below. After an outgoing action (gates AR, AW, W, CR and CD) from an ACE master `cpu1` with a cache state `ACE_UD` (Unique Dirty), it monitors all outgoing actions of all ACE masters. If a different ACE master `cpu2` has the corresponding cache line in a valid state (not `ACE_I`), we `ACCEPT` the test (a coherency error has been detected). If

cpu1 performs another action with a state other than ACE_UD, we REFUSE the test (the test is inconclusive).

The unique dirty coherency test purpose is modeled as follows:

```
module obj_UD (types) is
process main [AR:AR_CHANNEL, AW:AW_CHANNEL, CR:CR_CHANNEL,
             ACCEPT, REFUSE: none] is
var cpu1, cpu2: INDEX_CPU, state: ACE_state_t in
  select
    AR(?any, ?cpu1, 1, ACE_UD)
  [] AW(?any, ?cpu1, 1, ACE_UD)
  [] W (?any, ?cpu1, 1, ?any, ACE_UD)
  [] CR(?any, ?any, ?cpu1, 1, ?any, ?any, ?any, ACE_UD)
  [] CD(?any, ?cpu1, 1, ?any, ACE_UD)
  end select;
  select
    select
      AR(?any, ?cpu2, 1, ?state)
        where ((state<>ACE_I) and (cpu2<>cpu1))
    [] AW(?any, ?cpu2, 1, ?state)
        where ((state<>ACE_I) and (cpu2<>cpu1))
    [] W (?any, ?cpu2, 1, ?any, ?state)
        where ((state<>ACE_I) and (cpu2<>cpu1))
    [] CR(?any, ?any, ?cpu2, 1, ?any, ?any, ?any, ?any, ?state)
        where ((state<>ACE_I) and (cpu2<>cpu1))
    [] CD(?any, ?cpu2, 1, ?any, ?state)
        where ((state<>ACE_I) and (cpu2<>cpu1))
    end select;
  ACCEPT
[]
  select
    AR(?any, cpu1, 1, ?state)
      where (state<>ACE_UD)
  [] AW(?any, cpu1, 1, ?state)
      where (state<>ACE_UD)
  [] W (?any, cpu1, 1, ?any, ?state)
      where (state<>ACE_UD)
  [] CR(?any, ?any, cpu1, 1, ?any, ?any, ?any, ?any, ?state)
      where (state<>ACE_UD)
  [] CD(?any, cpu1, 1, ?any, ?state)
      where (state<>ACE_UD)
  end select;
  REFUSE
  end select;
  stop
end var
end process
end module
```

7.3.2 Unique Clean Cache State Coherency Test Purpose

The LNT code for the test purpose corresponding to the Unique Clean Cache Coherency is shown below. After an outgoing action (gates AR, AW, W, CR and CD) from an ACE

7.3. Model Checking Based Test Generation

master `cpu1` with a cache state `ACE_UC` (Unique Clean), it monitors all outgoing actions of all ACE masters. If a different ACE master `cpu2` has the corresponding cache line in a valid state (not `ACE_I`) we `ACCEPT` the test (a coherency error has been detected). If `cpu1` performs another action with a state other than `ACE_UC`, we `REFUSE` the test (the test is inconclusive).

The unique clean coherency test purpose is modeled as follows:

```
module obj_UC (types) is
process main [AR:AR_CHANNEL, AW:AW_CHANNEL, CR:CR_CHANNEL,
              ACCEPT, REFUSE: none] is
var cpu1, cpu2: INDEX_CPU, state: ACE_state_t in
  select
    AR(?any, ?cpu1, 1, ACE_UC)
  [] AW(?any, ?cpu1, 1, ACE_UC)
  [] W (?any, ?cpu1, 1, ?any, ACE_UC)
  [] CR(?any, ?any, ?cpu1, 1, ?any, ?any, ?any, ?any, ACE_UC)
  [] CD(?any, ?cpu1, 1, ?any, ACE_UC)
  end select;
  select
    select
      AR(?any, ?cpu2, 1, ?state)
        where ((state<>ACE_I) and (cpu2<>cpu1))
    [] AW(?any, ?cpu2, 1, ?state)
        where ((state<>ACE_I) and (cpu2<>cpu1))
    [] W (?any, ?cpu2, 1, ?any, ?state)
        where ((state<>ACE_I) and (cpu2<>cpu1))
    [] CR(?any, ?any, ?cpu2, 1, ?any, ?any, ?any, ?any, ?state)
        where ((state<>ACE_I) and (cpu2<>cpu1))
    [] CD(?any, ?cpu2, 1, ?any, ?state)
        where ((state<>ACE_I) and (cpu2<>cpu1))
    end select;
  ACCEPT
[]
  select
    AR(?any, cpu1, 1, ?state)
      where (state<>ACE_UC)
  [] AW(?any, cpu1, 1, ?state)
      where (state<>ACE_UC)
  [] W (?any, cpu1, 1, ?any, ?state)
      where (state<>ACE_UC)
  [] CR(?any, ?any, cpu1, 1, ?any, ?any, ?any, ?any, ?state)
      where (state<>ACE_UC)
  [] CD(?any, cpu1, 1, ?any, ?state)
      where (state<>ACE_UC)
  end select;
  REFUSE
  end select;
  stop
end var
end process
end module
```

7.3.3 Shareable Memory Data Integrity Test Purpose

If a memory update with a data d is achieved, and as long as no snoop request is initiated, the property forbids any data h different from d to be written in the memory line.

The LNT code for the test purpose corresponding to the data integrity test purpose is shown below. First, a memory update action W is proceeded from an ACE master $m1$, a memory line l , and a data $d1$. Second, this update is actually written to the shareable memory (port number 0). After that, if a memory update action of the some memory line (l), with a different data $d2$, coming from an another master $m2$, the process reaches the ACCEPT state. The presence of the AC snoop channel as communication port of this process, expresses that during the previous steps nothing is sent on snoop channel to inform masters of the change in data. The data $d2$ that has just been written is older than the first data $d1$ written. So we were able to create a data integrity violation.

The shareable memory data integrity test purpose is modeled as follows:

```

module obj_di (types) is
process main [W:W_CHANNEL, AC:AC_CHANNEL, ACCEPT: any]
is
  var m1, m2: INDEX_CPU,
      l: INDEX_MEM,
      d1, d2: DATA_T,
      any : ACE_OP
  in
    l := INDEX_MEM(1);
    W (WriteBack, ?m1, l, ?d1);
    W (WriteBack, INDEX_CPU(0), l, ?d1, m1);
    W (?any, INDEX_CPU(0), l, ?d2, ?m2)
    where ((any <> WriteBack) and
           (d2 <> d1) and (m2 <> m1));
    ACCEPT;
    stop
  end var
end process
end module

```

7.3.4 Model-Based Test Generation Process

We use two newly developed prototype tools for test generation. A first tool takes as input a model and a test purpose (both in LNT), and produces a *Complete Test Graph* (CTG), i.e., an intermediate LTS containing all information to extract (all) abstract test cases. We use a second tool to extract a set of abstract test cases from the CTG. These test cases are abstract in the sense that they are system-level automata generated from the model.

Contrary to the batch approach often used in hardware testing (in which the DUV receives all its stimuli first, the DUV reaction being analyzed afterwards), the test cases

7.3. Model Checking Based Test Generation

Table 7.1 – Experimental test case extraction results

prop.	masters	global CTG		extr. time	nb. of CTGs	largest CTG		smallest CTG		extr. time
		states	trans.			states	trans.	states	trans.	
φ_5	2ACE	6,402	14,323	>1/2 y	18	903	1,957	274	543	$\simeq 7h$
φ_6	2ACE	*6,402	*14,323	>1/2 y	*18	*903	*1,957	*274	*543	* $\simeq 7h$
φ_8	2ACE	*6,402	*14,323	>1/2 y	*18	*903	*1,957	*274	*543	* $\simeq 7h$
φ_9	2ACE	*6,402	*14,323	>1/2 y	14	*903	*1,957	*274	*543	* $\simeq 7h$
φ_{15}	2ACE	23,032	48,543	>1/2 y	14	462	888	59	107	<1h
	1ACE/1Lite	2,815	7,071	>1/2 y	7	193	394	59	107	<1h

generated by our tools are reactive, in the sense that the stimuli sent by the tester may depend on the reactions of the DUV observed in response to previous stimuli. Reactive testing increases the quality and coverage of tests, as more behaviors of the DUV can be tested [GVZ00].

Thus, those abstract test cases have to be translated to the input language of the commercial coverage-based solver to randomly complete the interface-level details and to run the tests on the RTL test bench.

By extracting all test cases from each CTG and running each test case on the industrial test bench, we obtain a locally intensive test around corner cases specified by the global system-level properties.

Table 7.1 summarizes the results of our generation of abstract test cases for a test purpose encoding the negation of a property φ . The first two columns describe the property and the architecture. Columns 3 to 5 report the size of the global CTG (produced from the unconstrained model) and the time to extract test cases. The remaining columns give information about our approach based on individual CTGs (produced from the interesting configurations): column 6 presents the number of CTGs, each of which is extracted from an interesting configuration, columns 7 to 10 report the size of the largest and the smallest CTG, and the last column gives the time to extract test cases from all the individual CTGs. We see that the approach based on individual CTGs is much more efficient than the extraction of test cases directly from the global CTG, for which the extraction of test cases does not finish in half a year. Also, our approach reduces the size of the largest CTG by a factor of 7 for φ_5 (Unique Dirty Coherency), a factor of 14 for φ_{15} (Data Integrity) in the case of the architecture with one ACE master and one ACE-Lite master initiating transactions, and a factor of 49 for φ_{15} in the case of the architecture with two ACE masters ¹.

¹The test generation results of the properties φ_6, φ_8 , and φ_9 will be available for the final version of the thesis.

7.4 Industrial Results and Impact

Our formal model is used inside STMicroelectronics as a reference in discussions with verification engineers and interconnect architects. It helps to understand the new aspects introduced by ACE and to define the verification strategy. In this context, the OCIS interactive step-by-step simulator with backtracking of CADP is found useful for exhibiting execution scenarios of interest.

We also used OCIS to extract the list of possible transaction initiations for each correct initial state of the system. A correct initial state of the system is a correct combination of initial ACE states of the caches. For example, if a memory line exists initially in two different caches, the state of these caches cannot be `ACE_UD` for both caches. So doing, we produce in less than one day 296 simple protocol tests, each of which consists of one single ACE transaction, from request to response, including all triggered snoop requests, if any.

Using some of the counterexamples generated during the computation of the interesting configurations (cf. Sec. 7.2), we produced also ten complex protocol tests containing concurrency between different ACE transactions.

7.4.1 IVK Dynamic Test Benches

An *interconnect* is a hardware component connecting several components (or several blocks of components) of an SoC. A simple example of an interconnect is a bus. Over time, more and more features have continuously been added to interconnects, including routing features for Networks-on-Chip or hardware support for cache coherency protocols.

STMicroelectronics has capitalized more than 10 years of expertise in interconnects verification in a tool called *Interconnect Verification Kit* (IVK). The principle of IVK is shown in Figure 7.3. IVK generates a full verification environment, including sequences and coverage models, using as input the architectural textual description, called TDL (Target Description Language) [Käs03]. The TDL can be either generated from interconnect designers GUI² or through a flow based on spreadsheet describing the elements of the architecture. The industrial test benches used in the scope of this thesis are generated by IVK.

We use IVK to generate a simulation test bench of the ARM PL35 cci400 DUV (called in the following *cci400*), which is a Verilog RTL IP provided by ARMTM to implement a fully connected cache coherent interconnect based on the AMBA 4 ACE specification. The verification infrastructure consists on dynamic verification units (called *Verification Intellectual Properties* (VIP)), tests both in functional verification language *e* [oEE11],

²graphical user interfaces

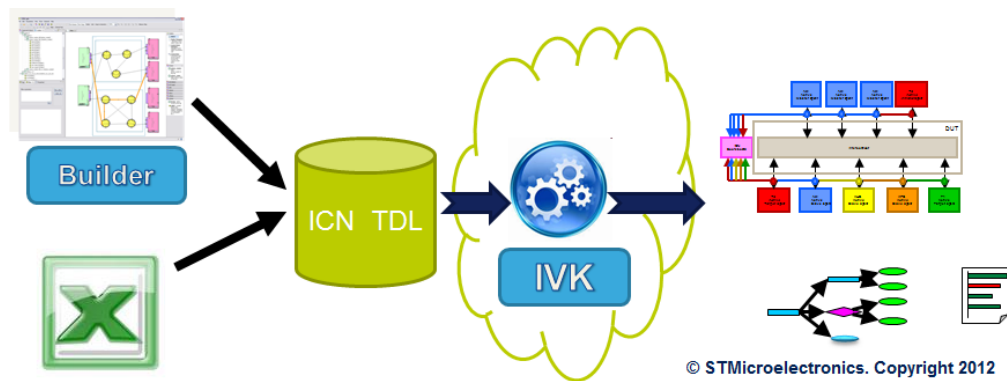

Figure 7.3 – IVK generation flow

IV units in SVA [oEE09], and an SV unit in PSL [oEE10]. This infrastructure is used to generate several test benches through an IVK flow. IVK uses the FTL technique to generate tests, this technique consists on writing generic tests that are then instantiated depending on the types of the components present on the TDL file. For example, an ACE test will be generated for any ACE master, an ACE-Lite test will be generated for any ACE-Lite master, and an ACE/ACE-Lite test will be generated for each ACE and ACE-Lite master.

The following test benches are used in this thesis:

- **cci400_r0p2**: a cci400 stand-alone test bench using the complete configuration of the cci400 interconnect consisting on two ACE masters (2 ACE VIPs), three ACE-Lite masters (3 ACE-Lite VIPs) and three ACE-Lite slaves (3 ACE-Lite slave VIPs).
- **cci400_r1p2**: a cci400 stand-alone test bench (see Figure 7.4) using the STMicroelectronics configuration of the cci400 interconnect consisting on two ACE masters (2 ACE VIPs), one ACE-Lite master (1 ACE-Lite VIP), and ACE-Lite slaves (this configuration corresponds to the configuration of the proposed formal model).
- **ORLY_3**: a test bench of an industrial SoC produced and sold by STMicroelectronics designing a new generation Ultra-HD server used by commercial set-top-boxes. This SoC is the first industrial product of STMicroelectronics integrating the ARM® big.LITTLE™ solution and the cci400 interconnect, which is in the cci400_r1p2 configuration and connected to the STNoC Network-on-Chip interconnect via the ACE-Lite slave port used as an AXI slave port.
- **BARCELONA**: a test bench of a multimedia gateway network processor, which is a second industrial product of STMicroelectronics integrating the ARM® big.LITTLE™ solution and the cci400 interconnect.

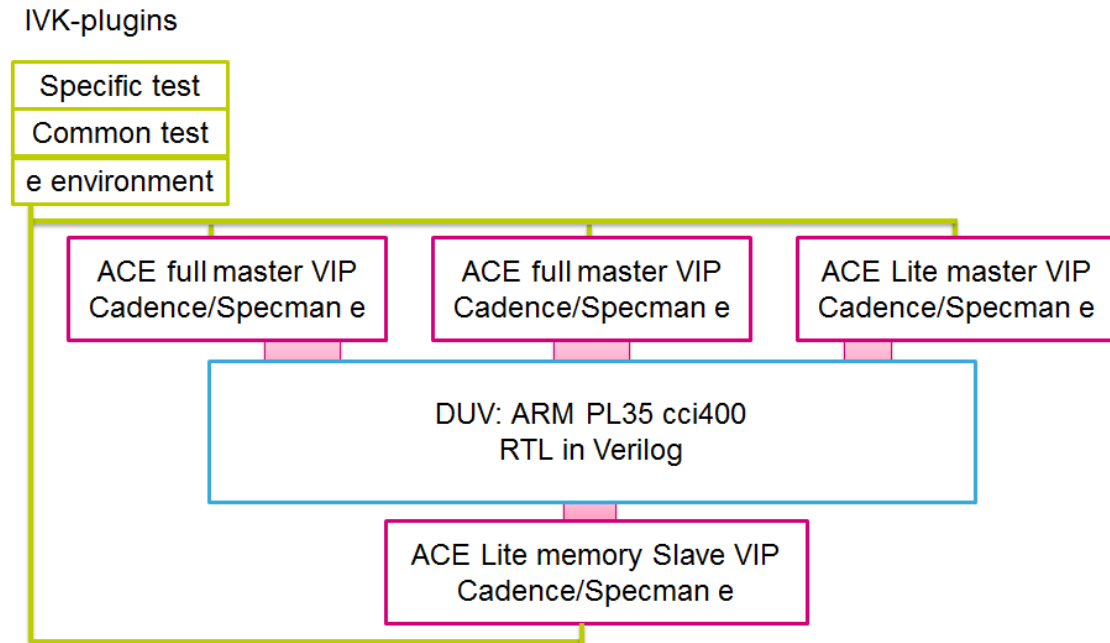

Figure 7.4 – IVK cci400_r1p2 test bench architecture

A semi-random based testing is used. By default, tests are completely random. By specifying constraints expressed in the *e* language, the behavior is restricted in order to have a more significant test. At the beginning, IVK generates components of the system. After that IVK adds general restrictions common to all tests. Then, IVK adds specific restrictions to the test to run. The commercial CDTG solver chooses randomly one of the solutions of the specified set of constraints, if any. If no solution exist, a contradiction is detected. The test has to be corrected. The performed test is characterized by a seed, which specifies the random choices done by the solvers. Rerunning the test with the same seed means running exactly the same values of the variables of the system. Rerunning the test with a new seed means making other random choices of the possible values of the variables of the system. The *e* description of the test is an underspecification of a behavior of the system.

7.4.2 Making the Test Bench Ready for System-Level Verification

The original test libraries developed by the verification engineers are interface tests. With a not so good coverage of system, new tests describing system scenarios are necessary. Because system requirements cannot be verified on a single IV unit separately, the verification infrastructure is completed by introducing the notion of a *system verification unit* (SV unit) connected to all IV units, enabling to combine behaviors of different interfaces in order to validate system-level requirements. For the considered SoC, we defined an SV unit consisting of 56 PSL sequences, 56 PSL basic cover points, and 36 PSL checks. This

Table 7.2 – Industrial results: bugs report

VIP	Bugs detected	CAD Fixed	Open
ACE dynamic VIP	5	3	2
ACE IV unit	5	4	1

enables to verify on the RTL test bench that each coherent transaction produces the corresponding snoop transactions, and that each snoop transaction eventually receives a response from the snooped master.

Further modifications of the test bench are required to enable the execution of the concrete test cases derived from our abstract test cases. In particular, it is necessary to control the order of events. First, we added more synchronizations between different *Verification Intellectual Property* (VIP) events to enforce the desired order of the events. Second, we added speed-up randomization: by default the speed of a master for each of its channels is completely random. To express that a master is faster than another one or to enforce an order between two concurrent actions of a same master, we specify speed-up ranges (e.g., fast, slow, or very slow). So doing, the speed-up remains random, but in a limited range, ensuring the desired order.

7.4.3 Industrial Results

During the implementation of our abstract test cases on top of commercial VIPs, we detected ten bugs in those VIPs (the bug report is presented in Table 7.2). This enabled the CAD supplier to correct the bugs before the use of these VIPs became critical in the development path of STMicroelectronics.

Because the VIPs and the coverage lists are provided by the same CAD supplier, some verification gaps may not be detected. In fact, the same misinterpretation of the ACE specification may find its way into both the VIPs and the coverage lists. Working with a different approach led us to validate the industrial checks (provided in the IV units), and thanks to our directed tests we detected unverified behaviors.

In October 2014, STMicroelectronics architects detected a limitation in the IP implementation of the CCI. This limitation manifests in a subset of the counterexamples for the data integrity property we verified 20 months before. Precisely, when the CCI initiates a memory update, some parameters of this update are set to fixed values possibly losing some important information, and disturbing the ACE-Lite flow in the non-coherent part of the SoC. This limitation corresponds to a gap that we have detected on the commercial VIPs one year before, when we started experimenting with the translation of abstract to concrete test cases. Our method for computing interesting faulty configurations (see

Sec. 7.2) enabled us to provide all the scenarios triggering this limitation. Precisely, those scenarios are a subset of the shareable memory data integrity counterexamples (21 distinct cases, 14 for each pair of ACE masters and 7 for each pair of an ACE master and an ACE-Lite master).

The shareable memory data integrity counterexamples are caused by different aspects: 10 among the 21 counterexamples are caused by a memory update transaction initiated by the cci400. This memory update is related to a coherency response (CR) with an asserted `PassDirty==True` for an ACE transaction not accepting a read response (R) with an asserted `PassDirty==True`.

Each of the 10 counterexamples corresponds to one of three cases:

- The first case consists of a cache maintenance transaction (namely *CleanInvalid* or *CleanShared* transaction). In this case, STMicroelectronics architects decide to deactivate those transactions for the ACE-Lite masters: this decision has an impact on the performance of the SoC but it is still feasible.
- The second case consists on the *ReadOnce* transaction, if a unique dirty cache line (ACE_UD) receives a *ReadOnce* snoop transaction and the master decides to switch to a shared clean (ACE_SC) or invalid (ACE_I) state. In this case, the `PassDirty` parameter of the coherent response CR is asserted. For this reason, STMicroelectronics architects decide to deactivate this case on the ACE masters and require that a cache line in a unique dirty state receiving a *ReadOnce* snoop transaction must stay in a dirty state (ACE_UD or ACE_SD). In this case, the `PassDirty` parameter of the coherent response CR is deserted and no memory update transaction is produced by the cci400.
- The third case consists on the *WriteUnique* transaction, this shareable write transaction is the only way for an ACE-Lite master to write a data in a shareable region of the memory. Deactivating this transaction is infeasible because it relates a functional issue and not only a performance issue. We recommend to STMicroelectronics architects to work with this limitation and to address this issue in the non-coherent part of the SoC.

In addition, we wrote new PSL checks to detect those corner cases. We should notice that our 306 extracted tests trigger those checks 16 times, whereas the other tests of the STMicroelectronics test library never trigger these checks.

Our generated tests have direct impact on the development flow of an industrial SoC of STMicroelectronics. We observe that the coverage of the verification plan increased significantly³ and that the coverage of the SV unit part of the verification plan is complete (100%), i.e., all the aspects corresponding to system-level behaviors are tested.

³The coverage of the verification plan increased from 30% to 68%. Notice that 100% coverage is not

achievable for the considered SoC, because the verification plan, as defined by the VIPs, includes some features of ACE (e.g., distributed virtual memory), which are handled by the VIPs, but are not used by the considered SoC.

Chapter 8

Sanity of a Formal Check List

Industrial CDTG test benches are based on a so-called *verification plan*, i.e., a list of all behaviors to be covered by tests on the *Design Under Verification* (DUV). The coverage of the verification plan is collected to measure test progression.¹ In our work, we focus on the formal *checks*, which are grouped in so-called *interface verification units* (IV unit). Each check is an event sequence, e.g., expressed in *Property Specification Language* (PSL) [oEE10]. Covering a check consists in activating the check and finishing correctly the specified sequence. Activating a check means to detect the first event of the sequence. It is a failure if a check is activated and not correctly finished.

In this chapter, we report about the use of our formal model to validate a commercial IV unit. To this end, we encode each check of the IV unit as a *Labeled Transition System* (LTS) (by means of an LNT model) and use equivalence checking techniques (hiding, minimization, and comparison operations on LTSs).

At the beginning, we model each check as an LNT process. Then, we verify that each check is an overapproximation of the model behavior. Last, we study if the list of checks covers all behaviors of the model.

8.1 Modeling Formal Checks in LNT

We start our study by identifying a subset of nine industrial formal checks (called C1 ... C9), which have a level of abstraction corresponding to our formal model. On one hand, we model each selected check as an LNT model. On the other hand, we derive an interface LTS from our LNT model of the system by hiding all behaviors not related to the selected interface. Each check introduces only a subset of ACE channels (\mathbf{AR} , \mathbf{R} ,

¹There are two types of behaviors in a verification plan: simple behaviors, called *cover points* and complex behaviors, called (formal) *checks*.

AW, W, B, AC, CR, CD). Not used channels are represented by internal actions (i).

8.1.1 C1: No Overlapping Read Write Transactions

The check C1 requires that:

The current read address request (AR) should not overlap with any of the outstanding (and possibly current) write requests: each write (on AW channel) is supposed to be acknowledged (on B channel).

We model the check C1 by a loop, consisting of four phases (see the code below). The PHASE 1 is a loop preceding the write request: in this loop we can send a read request, receive a write response, do an intern rendezvous (i) or break the inner loop. In the PHASE 2 a write request is sent. The PHASE 3 is a loop (the write request is in progress). In this loop we can send another write request, do an intern rendezvous (i) or break the inner loop. In the PHASE 4 the write response is received. After that, we return to the PHASE 1.

```
module prop_ar_aw_no_overlapping(types) is
process MAIN [AR:AR_OCHANNEL, AW:AW_OCHANNEL, B:B_CHANNEL]
is
  var cpu: INDEX_CPU, mem: INDEX_MEM, READOP, WRITEOP, WRITEOP1: ACE_OP
  in
    mem:= INDEX_MEM(1); cpu:=INDEX_CPU(1);
    i;
  loop
```

— PHASE 1: first loop before the initialization of the write request —

```
  loop BE in
    select
      AR (?READOP, cpu, mem)
      where member(READOP,{ReadOnce, ReadShared, ReadClean, ReadUnique,
        ReadNotSharedDirty, MakeUnique, CleanUnique,
        CleanShared, CleanInvalid, MakeInvalid})
      [] B (?WRITEOP, cpu, mem, TRUE)
      [] i
      [] break BE
    end select
  end loop;
```

— PHASE 2: initialization of the write request —

```
  AW (?WRITEOP, cpu, mem)
  where member(WRITEOP,{WriteUnique, WriteLineUnique,
    WriteBack, WriteClean, WriteEvict});
```

— PHASE 3: second loop after the initialization of the write request —

```
  loop NO in
    select
```

```

    AW (?WRITEOP1, cpu, mem)
    where member(WRITEOP1, {WriteUnique, WriteLineUnique,
                          WriteBack, WriteClean, WriteEvict})
    [] i
    [] break NO
    end select
end loop;

```

PHASE 4: response of the write request

```

    B (WRITEOP, cpu, mem, TRUE)
end loop
end var
end process
end module

```

8.1.2 C2: No Maintenance Transaction while Pending Shareable Transaction

The check C2 requires that:

The master must complete any outstanding shareable transactions to the cache line before issuing a cache maintenance transaction corresponding to the same cache line.

We model the check C2 by a loop, consisting of four phases (see the code below). The PHASE 1 is a loop preceding the shareable write or read request: in this loop we can send write and read requests while those requests are not shareable, receive write and read responses, do an intern rendezvous (*i*) or break the inner loop. In PHASE 2 a shareable write or read request is sent. The PHASE 3 is a loop (a shareable write or read request is in progress). In this loop we can send a read request while this read is neither shareable nor maintenance, receive a response for a read or write different from the shareable write or read of the PHASE 2, do an intern rendezvous (*i*) or break the inner loop. In PHASE 4 the shareable write or read response is received. After that, we return to the PHASE 1.

```

module prop_ar_aw_no_maintenance(types) is
process MAIN [AR:AR_OCHANNEL, AW:AW_OCHANNEL, R:R_CHANNEL, B:B_CHANNEL]
is
  var cpu: INDEX_CPU, mem: INDEX_MEM, ACEOP, SHAREABLE, NOTMAINT:ACE_OP,
      d: DATA_T, b1, b2, b3: bool
  in
    mem:= INDEX_MEM(1); cpu:=INDEX_CPU(1);
    i;
  loop

```

PHASE 1: first loop before the shareable request

```

  loop BE in
  select

```

Chapter 8. Sanity of a Formal Check List

```
AR (?ACEOP, cpu, mem)
  where not (member(ACEOP, {ReadShared, ReadClean, ReadNotSharedDirty,
                        MakeUnique, ReadUnique, CleanUnique}))
[] AW (?ACEOP, cpu, mem)
  where not (member(ACEOP, {WriteUnique, WriteLineUnique}))
[] R (?ACEOP, cpu, mem, ?d, ?b1, ?b2, ?b3)
[] B (?ACEOP, cpu, mem, TRUE)
[] i
[] break BE
end select
end loop;
```

— PHASE 2: initialization of the shareable request —

```
select
  AR (?SHAREABLE, cpu, mem)
    where member(SHAREABLE, {ReadOnce, ReadShared, ReadClean,
                              ReadNotSharedDirty,
                              MakeUnique, ReadUnique, CleanUnique})
[] AW (?SHAREABLE, cpu, mem)
  where member(SHAREABLE, {WriteUnique, WriteLineUnique})
end select;
```

— PHASE 3: second loop after the initialization of the shareable request —

```
loop NO in
  select
    AR (?ACEOP, cpu, mem) — ni maintenance ni shareable
      where not (member(ACEOP, {CleanShared, CleanInvalid, MakeInvalid,
                                ReadOnce, ReadShared, ReadClean, ReadNotSharedDirty,
                                MakeUnique, ReadUnique, CleanUnique}))
[] R (?ACEOP, cpu, mem, ?d, ?b1, ?b2, ?b3)
  where (ACEOP <> SHAREABLE)
[] B (?ACEOP, cpu, mem, TRUE)
  where (ACEOP <> SHAREABLE)
[] i
[] break NO
  end select
end loop;
```

— PHASE 4: response of the shareable request —

```
select
  R(SHAREABLE, cpu, mem, ?d, ?b1, ?b2, ?b3)
[] B (SHAREABLE, cpu, mem, TRUE)
end select
end loop
end var
end process
end module
```

8.1.3 C3: No Shareable Read Transaction while Pending Maintenance Transaction

The check C3 requires that:

8.1. Modeling Formal Checks in LNT

The master must not issue any further shareable transactions to the same cache line until the cache maintenance transaction is complete.

We model the check C3 by a loop, consisting of four phases (see the code below). The PHASE 1 is a loop preceding the maintenance read request: in this loop we can send non-maintenance read requests, receive read responses, do an intern rendezvous (i) or break the inner loop. In the PHASE 2 a maintenance read request is sent. The PHASE 3 is a loop(a maintenance read request is in progress). In this loop we can send a read request while this read is neither shareable nor maintenance, receive a non-maintenance read response, do an intern rendezvous (i) or break the inner loop. In the PHASE 4 the maintenance read response is received. After that, we return to the PHASE 1.

```
module prop_no_shareable_read(types) is
process MAIN [AR:AR_OCHANNEL, R:R_CHANNEL]
is
  var cpu: INDEX_CPU, mem: INDEX_MEM, ACEOP, MAINTENANCE, NOTMAINT:ACE_OP,
      d: DATA_T, b1, b2, b3: bool
  in
    mem:= INDEX_MEM(1); cpu:=INDEX_CPU(1);
    i;
  loop

---

    PHASE 1: first loop before the initialization of the maintenance request

---

    loop BE in
      select
        AR (?ACEOP, cpu, mem)
          where not (member(ACEOP,{CleanShared, CleanInvalid, MakeInvalid}))
        [] R (?ACEOP, cpu, mem, ?d, ?b1, ?b2, ?b3)
        [] i
        [] break BE
      end select
    end loop;

---

    PHASE 2: initialization of the maintenance request

---

    AR (?MAINTENANCE, cpu, mem)
    where member(MAINTENANCE, {CleanShared, CleanInvalid, MakeInvalid});

---

    PHASE 3: second loop after the initialization of the maintenance request

---

    loop NO in
      select
        AR (?ACEOP, cpu, mem) — ni maintenance ni shareable
          where not (member(ACEOP, {CleanShared, CleanInvalid, MakeInvalid,
            ReadOnce, ReadShared, ReadClean, ReadNotSharedDirty,
            MakeUnique, ReadUnique, CleanUnique}))
        [] R (?ACEOP, cpu, mem, ?d, ?b1, ?b2, ?b3)
          where (ACEOP<>MAINTENANCE)
        [] i
        [] break NO
      end select
    end loop;

---

    PHASE 4: response of the maintenance request

---

```

```
R(MAINTENANCE, cpu, mem, ?d, ?b1, ?b2, ?b3)
end loop
end var
end process
end module
```

8.1.4 C4: No WriteBack or WriteClean while WriteUnique or WriteLineUnique

The check C4 expresses that:

No additional WriteBack or WriteClean transactions can be issued until all outstanding WriteUnique or WriteLineUnique transactions are completed.

We model the check C4 by a loop, consisting of four phases. The PHASE 1 is a loop preceding the WriteUnique or WriteLineUnique write request. In this loop we can send write requests while they are neither WriteUnique nor WriteLineUnique, receive write responses, do an intern rendezvous (i) or break the inner loop. In the PHASE 2 a WriteUnique or WriteLineUnique write request is sent. The PHASE 3 is a loop (a WriteUnique or WriteLineUnique write request is in progress). In this loop we can send a write request while this write is neither WriteUnique/WriteLineUnique nor WriteBack-/WriteClean, receive a write response different from the WriteUnique/WriteLineUnique pending transaction, do an intern rendezvous (i) or break the inner loop. In the PHASE 4 write response corresponding to the WriteUnique/WriteLineUnique pending transaction is received. After that, we return to the PHASE 1.

```
module prop_no_wb_wc_while_wu_wlu(types) is
process MAIN [AW:AW_OCHANNEL, B:B_CHANNEL]
is
var cpu: INDEX_CPU, mem: INDEX_MEM, ACEOP, PEND, NOTMAINT:ACE_OP,
d: DATA_T, b1, b2, b3: bool
in
mem:= INDEX_MEM(1); cpu:=INDEX_CPU(1);
i;
loop
```

— PHASE 1: first loop before the initialization of the pending request —

```
loop BE in
select
AW (?ACEOP, cpu, mem)
where not (member(ACEOP,{WriteUnique, WriteLineUnique}))
[] B (?ACEOP, cpu, mem, TRUE)
[] i
[] break BE
end select
end loop;
```

8.1. Modeling Formal Checks in LNT

```
— PHASE 2: initialization of the pending request —  
  
    AW (?PEND, cpu, mem)  
    where member(PEND, {WriteUnique, WriteLineUnique});  
  
— PHASE 3: second loop after the initialization of the pending request —  
  
    loop NO in  
    select  
    AW (?ACEOP, cpu, mem) — ni PEND ni INTERD  
    where not (member(ACEOP, {WriteUnique, WriteLineUnique,  
                        WriteBack, WriteClean}))  
    [] B (?ACEOP, cpu, mem, TRUE)  
    where (ACEOP <> PEND)  
    [] i  
    [] break NO  
    end select  
end loop;  
  
— PHASE 4: response of the pending request —  
  
    B(PEND, cpu, mem, TRUE)  
end loop  
end var  
end process  
end module
```

8.1.5 C5: No Shareable write Transaction while Maintenance Transaction

The check C5 requires that:

The master must not issue any further shareable transactions to the same cache line until the cache maintenance transaction is complete.

We model the check C5 by a loop, consisting of four phases. The PHASE 1 is a loop preceding the maintenance read request. In this loop we can send write and non-maintenance read requests, receive write and read responses, do an intern rendezvous (i) or break the inner loop. In the PHASE 2 a maintenance read request is sent. The PHASE 3 is a loop (a maintenance read request is in progress). In this loop we can send a read request while this read is neither shareable nor maintenance, receive a response for a write or read different from the maintenance read of the PHASE 2, do an intern rendezvous (i) or break the inner loop. In the PHASE 4 the maintenance read response is received. After that, we return to the PHASE 1.

```
module prop_no_shareable_write(types) is  
process MAIN [AR:AR_OCHANNEL, R:R_CHANNEL, AW:AW_OCHANNEL, B:B_CHANNEL]  
is  
    var cpu: INDEX_CPU, mem: INDEX_MEM, ACEOP, MAINTENANCE, NOTMAINT:ACE_OP,  
        d: DATA_T, b1, b2, b3: bool
```

Chapter 8. Sanity of a Formal Check List

```
in
  mem:= INDEX_MEM(1); cpu:=INDEX_CPU(1);
  i;
loop
```

— PHASE 1: first loop before the initialization of the maintenance request —

```
loop BE in
  select
    AR (?ACEOP, cpu, mem)
    where not (member(ACEOP,{CleanShared, CleanInvalid, MakeInvalid}))
  [] AW (?ACEOP, cpu, mem)
  [] R (?ACEOP, cpu, mem, ?d, ?b1, ?b2, ?b3)
  [] B (?ACEOP, cpu, mem, TRUE)
  [] i
  [] break BE
  end select
end loop;
```

— PHASE 2: initialization of the maintenance request —

```
AR (?MAINTENANCE, cpu, mem)
where member(MAINTENANCE, {CleanShared, CleanInvalid, MakeInvalid});
```

— PHASE 3: second loop after the initialization of the maintenance request —

```
loop NO in
  select
    AR (?ACEOP, cpu, mem) — ni maintenance ni shareable
    where not (member(ACEOP, {CleanShared, CleanInvalid, MakeInvalid,
      ReadOnce, ReadShared, ReadClean, ReadNotSharedDirty,
      MakeUnique, ReadUnique, CleanUnique}))
  [] R (?ACEOP, cpu, mem, ?d, ?b1, ?b2, ?b3)
    where (ACEOP<>MAINTENANCE)
  [] B (?ACEOP, cpu, mem, TRUE)
  [] i
  [] break NO
  end select
end loop;
```

— PHASE 4: response of the maintenance request —

```
R(MAINTENANCE, cpu, mem, ?d, ?b1, ?b2, ?b3)
end loop
end var
end process
end module
```

8.1.6 C6: Snoop Response when Memory Update in Progress

The check C6 requires that:

If a snooped master has a memory update in progress, using either a *WriteBack* or *WriteClean* transaction, then once it receives a snoop transaction to the same line, the snooped master must ensure that no other master can perform a

memory update at the same time. This is done by giving a snoop response with `PassDirty` parameter de-asserted and `IsShared` parameter asserted, which does not pass the permission to store to the line and does not pass responsibility for updating memory.

We model the check C6 by a loop, consisting of four phases. The PHASE 1 is a loop preceding the memory update. In this loop we can send write requests while the write is not a memory update, receive write responses, send snoop data responses (CD channel), do an intern rendezvous (i) or break the inner loop. In the PHASE 2 a *WriteBack* or *WriteClean* memory update request is sent. The PHASE 3 is a loop (a memory update is in progress): in this loop we can send snoop data responses while `PassDirty` parameter is de-asserted (i.e., `PassDirty=false`) and the `IsShared` parameter is asserted (i.e., `IsShared=true`), do an intern rendezvous (i) or break the inner loop. In the PHASE 4 the memory update write response (B channel) is received. After that, we return to the PHASE 1.

```

module prop_aw_b_cd_wbwc_resp(types) is
!nat_bits 5
process MAIN [AW:AW_OCHANNEL, B:B_CHANNEL, CD:CD_CHANNEL]
is
  var cpu, cpu0: INDEX_CPU, mem: INDEX_MEM, X1, X2 :ACE_OP,
      d: DATA_T, b1, b2, b3: bool
  in
    mem:= INDEX_MEM(1); cpu:=INDEX_CPU(1);
    i;
  loop

```

— PHASE 1: first loop before the memory update —

```

  loop BE in
    select
      i
      [] B (?X2, cpu, mem, TRUE)
      [] CD (?X2, ?cpu0, cpu, mem, ?d, ?b1, ?b2, ?b3)
      [] AW (?X2, cpu, mem) where not ((X2==WriteBack) or (X2==WriteClean))
      [] break BE
    end select
  end loop;

```

— PHASE 2: initialization of the memory update —

```

  AW (?X1, cpu, mem) where ((X1==WriteBack) or (X1==WriteClean));

```

— PHASE 3: second loop after the initialization of the memory update —

```

  loop NO in
    select
      i
      [] CD (?X2, ?cpu0, cpu, mem, ?d, ?b1, (*PD*) ?b2, (*IsSh*) ?b3)
        where (b2==FALSE) and (b3==TRUE)
      [] break NO
    end select
  end loop;

```

Chapter 8. Sanity of a Formal Check List

— *PHASE 4: response of the memory update* —

```
    B (X1, cpu, mem, TRUE)
  end loop
end var
end process
end module
```

8.1.7 C7: Order between Channels AC and CD

The check C7 requires that:

The master must wait the end of AC transfer before issuing the corresponding CD transfer.

We model the check C7 by a loop, consisting of four phases. The PHASE 1 is a loop preceding the AC transfer. In this loop we do not have to send a CD transfer. We can just do an intern rendezvous (i) or break the inner loop. In the PHASE 2 an AC transfer is sent. The PHASE 3 is a sequence of arbitrary operations (i). In the PHASE 4 the corresponding CD transfer is sent. After that, we return to the PHASE 1.

```
module prop_ac_cd_order(types) is
!nat_bits 5
process MAIN [AC:AC_CHANNEL, CD:CD_CHANNEL]
is
  var cpu, cpu0: INDEX_CPU, mem: INDEX_MEM, X1, X2:ACE_OP,
      d: DATA_T, b1, b2, b3: bool
  in
    mem:= INDEX_MEM(1); cpu:=INDEX_CPU(1);
    i;
  loop
```

— *PHASE 1: first loop before AC transfer* —

```
  loop BE in
    select
      i
    [] break BE
    end select
  end loop;
```

— *PHASE 2: AC transfer* —

```
  AC (?X1, ?cpu0, cpu, mem);
```

— *PHASE 3: second loop between AC transfer and CD transfer* —

```
  loop EB in
    select
      i
    [] break EB
```

```

        end select
    end loop;

```

PHASE 4: CD transfer

```

        CD (X1, cpu0, cpu, mem, ?d, ?b1, ?b2, ?b3)
    end loop
end var
end process
end module

```

8.1.8 C8: Order between Channels AC and CR

The check C8 requires that:

The master must wait the end of AC interface transfer (i.e., rendezvous in system-level view) before issuing the corresponding CR transfer.

We model the check C8 by a loop, consisting of four phases. The PHASE 1 is a loop preceding the AC transfer. In this loop we have not to send a CR transfer. We can just do an internal rendezvous (i) or break the inner loop. In the PHASE 2 an AC transfer is sent. The PHASE 3 is a sequence of arbitrary operations (i). In the PHASE 4 the corresponding CR transfer is sent. After that, we return to the PHASE 1.

```

module prop_ac_cr_order(types) is
process MAIN [AC:AC_CHANNEL, CR:CR_OCHANNEL]
is
    var cpu, cpu0: INDEX_CPU, mem: INDEX_MEM, X1, X2:ACE_OP,
        d: DATA_T, b1, b2, b3: bool
    in
        mem:= INDEX_MEM(1); cpu:=INDEX_CPU(1);
        i;
    loop

```

PHASE 1: first loop before AC transfer

```

        loop BE in
            select
                i
            [] break BE
            end select
        end loop;

```

PHASE 2: AC transfer

```

        AC (?X1, ?cpu0, cpu, mem);

```

PHASE 3: second loop between AC transfer and CR transfer

```

        loop EB in
            select
                i

```



```

    [] break EB
  end select
end loop;

```

— PHASE 4: CR transfer —

```

  CR (X1, cpu0, cpu, mem)
end loop
end var
end process
end module

```

8.1.9 C9: PassDirty and IsShared Check

The check C9 requires that:

ReadNoSnoop, *ReadUnique*, *CleanUnique*, *MakeUnique*, *CleanInvalid*, and *MakeInvalid* transactions must have a response with *IsShared* parameter de-asserted (i.e., 7th offer =**false**).

ReadNoSnoop, *ReadOnce*, *ReadClean*, *CleanUnique*, *MakeUnique*, *CleanShared*, *CleanInvalid*, and *MakeInvalid* transactions must have a response with *PassDirty* parameter de-asserted (i.e., 6th offer =**false**).

A *ReadNotSharedDirty* transaction response must not have both *IsShared* and *PassDirty* parameters asserted in the same time (i.e., both 6th and 7th offer =**true**).

We model the check C9 by a loop of non-deterministic choice between different allowed read responses (allowed combination of ACE transaction, *PassDirty* and *IsShared* parameters) and intern rendezvous (*i*) representing arbitrary operations. This loop can be broken in any cycle.

```

module prop_asser_no_passdirty_isshared(types) is
process MAIN [R:R_CHANNEL, sync:any]
is
  var cpu: INDEX_CPU, mem: INDEX_MEM, ACEOP, SELECTED :ACE_OP,
      d: DATA_T, b1, b2, b3, arret: bool
  in
    mem:= INDEX_MEM(1); cpu:=INDEX_CPU(1);
    arret := false;
  loop AE in
    select
      R (?ACEOP, cpu, mem, ?d, ?b1, ?b2, FALSE)
      where member(ACEOP,{ReadUnique});
      arret := true
    [] R (?ACEOP, cpu, mem, ?d, ?b1, FALSE, ?b3)
      where member(ACEOP,{ReadOnce,ReadClean,CleanShared});
      arret := true
    [] R (?ACEOP, cpu, mem, ?d, ?b1, FALSE, FALSE)
      where member(ACEOP,{CleanUnique,MakeUnique,CleanInvalid,MakeInvalid });

```

```

    arret := true
[] R (?ACEOP, cpu, mem, ?d, ?b1, ?b2, ?b3)
  where (ACEOP == ReadNotSharedDirty) and not ((b2 == TRUE) and (b3 ==
    TRUE));
    arret := true
[] R (?ACEOP, cpu, mem, ?d, ?b1, ?b2, ?b3)
  where not (member(ACEOP, {ReadUnique,CleanUnique,MakeUnique,CleanInvalid
    ,
                                MakeInvalid,ReadOnce,ReadClean,CleanShared}));
    arret := true
[] i
  end select
end loop
end var
end process
end module

```

8.2 Local Sanity of Each Check

In fact, the IV unit considers only a single interface (i.e., a single master/slave pair), whereas the formal model describes the complete SoC. To obtain the LTS of the interface between ACE master 1 (big) and the CCI (upper left part of Fig. 5.1), we hide in the LTS of the whole system all labels except those of the selected interface and then minimize the resulting LTS according to *divergence-sensitive branching bisimulation* (divbranching) [VGW96], which preserves the branching structure and the livelocks (cycles of internal τ -transitions). Applying those steps reduces the LTS as generated from the model (498,197 states, 1,343,799 transitions) by two orders of magnitude (3,653 states, 8,924 transitions). We store the reduced LTS in a file named `interface.bcg`, where the extension `.bcg` stands for Binary Coded Graph, the compact binary format used to store LTSs in CADP.

We aim at verifying that each check is well specified. Because each check uses only a subset of interface channels, we generate a corresponding sub-interface by hiding all channels except those occurring in the check, and apply again divbranching reduction.

Example 14 Check C1 (presented in Section 8.1) uses only three channels: address read (AR), address write (AW), and write response (B). Thus we obtain the corresponding sub-interface LTS (105 states, 474 transitions). by the following SVL (Script Verification Language) [GL01] script:

```

"interface_ar_aw_b.bcg" = divbranching reduction of
    gate hide all but AR, AW, B in "interface.bcg";

```

We verify that each sub-interface LTS is included in the corresponding check LTS modulo the preorder of the divbranching bisimulation. We conclude that the check is a correct

overapproximation of the behavior of the subset of ACE channels.

8.3 Global Sanity of the List of Checks

To verify that the list of checks covers all the behaviors of the interface model, we compare the parallel composition of all the nine checks with the interface LTS. We use smart reduction [CL11] to automatically optimize the order of composing and minimizing the checks in the parallel composition: the complete composition process takes approximately five minutes. We express the parallel composition in SVL with an LNT-style parallel composition operation: each check is required to synchronize on all the gates (channels) it uses; synchronization is n-ary, i.e., *all* checks that have a given channel (e.g., AR) in their synchronization set (on the left of \rightarrow) synchronize on the channel (e.g., C1, C2, C3, C5 all together synchronize on AR).

```
"all_checks.bcg" =
  smart divbranching reduction of
    par  AR, AW, B    -> "C1.lnt"
        || AR, AW, R, B -> "C2.lnt"
        || AR, R      -> "C3.lnt"
        || AW, B      -> "C4.lnt"
        || AR, AW, R, B -> "C5.lnt"
        || AW, B, CD  -> "C6.lnt"
        || AC, CD     -> "C7.lnt"
        || AC, CR     -> "C8.lnt"
        || R          -> "C9.lnt"
    end par;
```

We compare the interface LTS and the checks LTS `all_checks.bcg` (11,773 states, 8,171,497 transitions) to verify if the interface LTS is included in the LTS `all_checks.bcg` modulo the preorder corresponding to the divbranching bisimulation. This verification fails, i.e., we detect a *missing check*; the counterexample (provided by CADP) shows a *W* label following an *AW* label.

According to the ACE specification, there must be the same number of *W*'s and *AW*'s. We express this constraint by a new check (C10), avoiding the use of counters, using asynchronous parallel composition ($AW \parallel W$):

```
module prop_aw_w(types) is
process MAIN [AW:AW_oCHANNEL, W:W_CHANNEL] is
  var cpu: INDEX_CPU, mem: INDEX_MEM,
      ACEOP: ACE_OP, d: DATA_T
  in
    mem:= INDEX_MEM(1); cpu:=INDEX_CPU(1);
    i;
  loop
```

```

    par
        AW (?ACEOP, cpu, mem)
    || W (ACEOP, cpu, mem, ?d)
    end par
end loop
end var
end process
end module

```

Adding C10 to the parallel composition of the checks, yields a new LTS `all_checks_bis.bcg` (38,793 states, 27,200,587 transitions).

We compare `all_checks_bis.bcg` and `interface.bcg` and observe now that `interface.bcg` is included in `all_checks_bis.bcg` for divbranching bisimulation. Hence, the check list is now complete with respect to our formal model. Although the missing check could also be found manually by inspecting the list of channels in the checks (all channels but W are present), our approach has the additional benefits of illustrating the missing behavior and enabling to formally, and semi-automatically, establish the completeness of the check list.

8.4 Improvement of System Coverage Infrastructure

However, system requirements cannot be verified on a single IV unit separately. We complete the verification infrastructure by introducing the notion of a *system verification unit* (SV unit) connected to all IV units, so as to combine behaviors of different interfaces in order to validate system-level requirements.

For the considered SoC, we define an SV unit consisting of 56 PSL (Property Specification Language) [oEE10] sequences, 56 PSL basic cover points, and 36 PSL checks. This enables to verify on the RTL test bench that each coherent transaction produces the corresponding snoop transaction, and that each snoop transaction eventually receives a response from the snooped master.

Example 15 We present below an example of two PSL sequences. The first one presents a *ReadOnce* transfer in the address read channel `AR` for an ACE-Lite master `S0` (for the simulation test benches the masters are considered as slaves `S?` and the slaves are considered as masters `M?`). This transfer is observed if the transfer is valid (i.e., `ARVALIDSO parameter==1`), the transaction is not a barrier transaction (i.e., `ARBARS0[0]==0`), we are in a shareable domain of the memory (i.e., `ARDOMAINSO==01 or 10`), and the transaction is a *ReadOnce* (i.e., `ARSNOOPSO==0000` in a shareable domain). The second PSL sequence presents a *ReadOnce* transfer on the address coherency channel `AC` for an ACE master `S3`. This transfer is observed if the transfer is valid (i.e., `ACVALIDS3==1`) and the transaction is a *ReadOnce* (i.e., `ACSNOOPSO==0000` in a shareable domain).

```
//----- AR ReadOnce transaction ACE-Lite S0 -----  
  
sequence AR_ReadOnce_s0 = {{ARVALIDSO==1'b1} & {ARBARS0[0]==1'b0}  
    & {{ARDOMAINSO==2'b01} | {ARDOMAINSO==2'b10}} & {ARSNOOPSO==4'b0000}};  
  
//----- AC ReadOnce transaction ACE S3 -----  
  
sequence AC_ReadOnce_s3 = {{ACVALIDS3==1'b1} & {ACSNOOPS3==4'b0000}};
```

Example 16 After that, we present an example of a PSL basic cover point and a PSL check. The basic cover point represents an action *ReadOnce* that occurred on the address read channel AR. We present that by the defined sequence `AR_ReadOnce_s0`. The check represents that a *ReadOnce* transfer in the address read channel AR of the ACE-Lite master S0 is always followed, after a finite number of clock edges, by a *ReadOnce* transfer in the address coherency channel AC. The defined sequences are useful to abstract the parameters level, when defining cover points and checks.

```
//----- Cover AR ReadOnce transaction ACE-Lite S0 -----  
  
cover_aread_ReadOnce_s0: cover {AR_ReadOnce_s0}  
    report "ReadOnce ACE Lite Master 0 transaction occurred";  
  
//----- Assert Transaction AR S0 => AC S3 -----  
  
assert_ReadOnce_S0_AR_S3_AC:  
    assert (always {AR_ReadOnce_s0} |=> {[*];AC_ReadOnce_s3});
```

8.5 Industrial Results

Our methodology was used by STMicroelectronics verification solution team to validate IV unit provided by a major CAD supplier. We focused in our study on the system-level checks.

The checks of the IV unit are expressed in *System Verilog Assertion* (SVA). Some checks concern the behavior of the DUV (i.e., cache coherent interconnect), and are called *assertions*. Other checks concern the behavior of the verification IP (i.e., IV unit), and are called *constraints*.

The IV unit is used both in static and dynamic verification test benches. In the dynamic test benches we connect the IV unit as a monitor to verify if the cover points and checks are activated by the tests runned by a dynamic Verification IP (VIP), provided by the same CAD supplier, and verify if the activated checks pass or fail. In the static test benches we connect the IV unit to the RTL of the DUV. We use constraints as inputs of

the DUV and the assertions as checks to verify the outputs of the DUV.

In our study presented above, we use the LNT model to replace the DUV and we validate the list of checks. Our LNT model combines both the behavior of the cache coherent interconnect and the behavior of the connected masters/slaves. As a result, either constraints (C1 to C8) and assertions (C9) of the IV unit are considered as constraints against the LNT model of the ACE-based SoC.

Giving that the VIPs and the coverage lists were provided by the same CAD supplier, some verification gaps may not be detected. In fact, the same misinterpretation of the ACE specification can be reproduced. Working with a different approach led us to validate the industrial checks, and thanks to our directed tests we could detect gaps in the industrial VIPs.

The test bench is now ready to check that the coherency mechanisms work well.

Chapter 9

Conclusion

There is nothing more practical than a good theory, and there is nothing more interesting than linking the good theory to a real case study and to prove concretely the relevance of the theory. Applying formal methods, developed by the concurrency theory research community, to improve the functional verification of hardware designs is an important focus in the current works aiming to introduce formal methods in the hardware design flow. The main purpose of this work is to prove the suitability and the efficiency of this approach in an industrial context. To this end, a high-level formal model is used to improve the functional verification of a cache coherent SoC. This SoC provides hardware support for system-level cache coherency, via the state-of-the-art AMBA 4 ACE protocol, which supports cache coherency in heterogeneous SoCs. A family of those SoCs is currently under development at STMicroelectronics.

This thesis starts by formally modeling a generic cache coherent SoC based on the ACE specification. Then this model is exploited in different ways: model checking the system properties on the formal model, extracting relevant test cases to be run on the implementation, and validating an industrial verification unit with respect to the formal model.

In the sequel, we present a summary of the principal contributions of this thesis. Then we propose some research and engineering perspectives to explore in order to capitalize on the results of this thesis.

9.1 Summary of Contributions

A generic formal LNT model of the recent ACE specification [ARM13] is produced. The proposed model includes all the behaviors allowed by the specification. Our model is parametric in the sense that a subset of ACE transactions can be activated and the

number of ACE and ACE-Lite masters can be chosen, as well as those that are activated or not. The constraint-oriented specification style is helpful in the modeling of general requirements expressed in natural language. Our model is found to be valuable by STMicroelectronics architects, because it enables (using the OCIS simulator) interactive and backtrackable step-by-step system-level simulation of all ACE-compliant behaviors.

Formal modeling of hardware specifications requires expertise and can be time-consuming. Often, the first model is not the best, and several iterations are required in order to obtain a mature model. When formally modeling a hardware system, it is indispensable to focus on the most complex parts, and to use appropriate abstractions. That is why, knowledge and experience must be capitalized. Besides, once the model exists, it can be profitably exploited in multiple ways. Some of them are presented in the following.

Correctness properties are expressed as temporal logic formulæ (in MCL) and verified automatically (using the EVALUATOR 4.0 tool). Hence, formal verification techniques are found to be useful for the analysis of heterogeneous coherent SoCs. We take advantage of the parametrization of our model by proposing an approach producing a comprehensive set of counterexamples for each non-satisfied property. The classical on-the-fly model checking approach, on its side, typically produces at most one counterexample.

The formal verification can require the use of clever verification strategies, such as compositional verification and on-the-fly verification. We notice that the use of explicit-state model checking based on enumerative techniques is not equivalent to a pure brute force technique. In fact, clever techniques are used in the different phases of the verification flow to address the challenges of industrial sized systems. The non-trivial issues detected, e.g., high-quality¹ bugs or limitations, prove the effectiveness of formal techniques introduced in the hardware functional verification flow.

Using only CDTG to generate tests in a one-step approach did not reach a satisfying coverage due to the complexity of system-level cache-coherency protocols. That is why this thesis proposes to enhance the CDTG industrial test bench by introducing model-based test generation of abstract test cases, using the results of the model checking. Those abstract test cases are then refined with the CDTG solver into RTL concrete test cases.

Prior approaches [GH99, QM11] transform counterexamples produced by the model checker into test cases. In this thesis, the counterexamples are used to produce smaller (interesting) configurations of the model which still contain violation of a given property, thus abstracting away irrelevant details. The abstract tests are generated from these interesting configurations. Those tests concern system-level properties in the sense that several interfaces are activated.

¹A high-quality bug is an error that would go undetected by the established validation process of some product.

The proposed approach capitalizes on existing environments while solving their limitations for system-level protocols. This has an impact on a family of industrial SoCs in production at STMicroelectronics: it helps to improve the test bench and to increase test coverage. In addition, this approach contributes to the maturation of commercial VIPs. The effectiveness of the proposed approach is illustrated by finding a major limitation twenty months before it is found by other classical approaches.

Finally, to check the sanity of an IV unit (i.e., a list of formal checks) used to monitor the behavior of an interface of the DUV, a cross-checking approach is used, comparing an interface LTS extracted from the proposed formal model with the IV unit. Formal checks are expressed in LNT. Smart-composition and the divbranching bisimulation are used to compose an LTS representing all the checks. After that, equivalence checking is used to validate the sanity of the formal checks list. This comparison enables to find a missing check.

The formal verification is classically used by hardware engineers on low levels. The semi-formal verification, combining simulation and formal checks, releases the formal verification techniques in different ways. It is a solution for the limitations in scalability of the formal verification due to the state-explosion problem and a way to confirm issues detected by the formal verification of a high-level model in the concrete test bench of the design under verification. This thesis improves the state of the art of semi-formal verification test benches by extracting results from high-level formal modeling and verification of the specification in order to extend the capabilities of the semi-formal test bench.

9.2 Research Perspectives

A first perspective concerns the introduction of more automation to strengthen the integration of the proposed approach in the industrial flow. Some manual parts have to be automated, in particular the translation of abstract test cases into inputs of a CDTG solver. The automation of this part enables also further development of on-line model-based testing approach by co-simulating the formal model and the DUV.

A second perspective concerns extending the proposed formal model to expand the scope of applications. In particular, the LNT model could be extended to take into account so-called snoop filters, which enable a coherent interconnect to implement a directory-based model, as required for an SoC with a larger number of coherent components. Hence, such an extension would cover also recently announced interconnects such as ARM's CCN-504. Furthermore, the LNT model could be annotated with quantitative information (e.g., operation latencies) using the framework of Interactive Markov Chains [Her02], so as to enable performance evaluation, capitalizing on the modeling effort done in this thesis.

Given the success of our approach, it seems also interesting to apply this approach to the system-level protocols in the next generation of SoCs. The proposed approach to assess the sanity of a check list (i.e., IV unit) against a formal model is akin to *crosschecking*, a technique widely used in the hardware community in order to improve confidence on the verification components. To apply our test generation approach, the formal model must be configurable, so as to violate a property. These preconditions seem acceptable, as modifying parts of the model (e.g., some data types) is found feasible using simple scripts, and the literature presents several techniques to automate the production of faulty models.

9.3 Scientific Publications and Communications

This thesis led to several publications and communications to the scientific and industrial community.

9.3.1 Scientific Publications

International conference proceedings:

- A. Kriouile and W. Serwe. Using a Formal Model to Improve Verification of a Cache-Coherent System-on-Chip. In *TACAS, LNCS 9035*, pp. 708–722. Springer, April 2015.
- A. Kriouile and W. Serwe. Formal Analysis of the ACE Specification for Cache Coherent Systems-on-Chip. In *FMICS, LNCS 8187*, pp. 108–122. Springer, September 2013.

Other international publications:

- A. Kriouile and W. Serwe. ARMCACHECoherency Model, benchmark model In Model Checking Contest @ Petri Nets. June 2013.
<http://mcc.lip6.fr/2014/pdf/ARMCACHECoherenceform.pdf>

National proceedings:

- A. Kriouile and W. Serwe. Analyse formelle du protocole ACE : cohérence de caches des systèmes sur puce In *ETR*, pp. 130- 133. August 2013.

9.3.2 Scientific Communications

Presentations in international conferences:

- A. Kriouile and W. Serwe. Using a Formal Model to Improve Verification of a Cache-Coherent System-on-Chip. In *TACAS*, part of *ETAPS 2015*, Queen Mary University in London, UK. April 17th 2015.
- A. Kriouile and M. Zendri. 20 years of Hardware Verification with CADP. In *Formal Methods Forum*, LAAS laboratory in Toulouse, France. October 16th 2014.
- A. Kriouile and W. Serwe. Formal Analysis of the ACE Specification for Cache Coherent Systems-on-Chip. In *FMICS*, University Complutense of Madrid, Spain. September 24th 2013.

Presentations in national seminars:

- A. Kriouile. Model-Based Testing of SoCs: from Theory to Practice. In *CONVECS'2014*, Herbelon, Isère, France. June 2014.
- A. Kriouile. Introduction of Formal High Level Modeling into SoC Validation: Illustration on ACE compliant Cache Coherence. In *CONVECS'2013*, Col de Porte, Isère, France. November 2013.
- A. Kriouile. Formal Modeling and Verification of an ACE Compliant Cache Coherent Interconnect. In *CONVECS'2012*, Pont-en-Royans, Isère, France. November 2012.

Posters:

- A. Kriouile (joint work with W. Serwe). Formal Analysis of the ACE specification for Cache Coherent Systems-on-Chip (SoC). In *ETR'2013*.
- A. Kriouile. Validation of Distributed Systems on-Chip. In *LIG'2013*.

Appendix

Appendix A

Model Checking Properties

This appendix describes exhaustively the MCL formulæ used to validate the coherency aspects of the ACE specification.

A.1 Unique dirty coherency

The first cache state coherency formula (φ_5)¹ requires that if a cache line (master m_1 , memory line l) is in the state `ACE_UD` (the cache line is unique and modified), then as long as the line does not change its status, all cache lines of other masters ($m_2 \neq m_1$) containing the same memory line (l) must be in the state `ACE_I` (the cache line is invalid). This is a state-based property. The corresponding action-based property expresses that if an action `{?Ch m1 l ACE_UD}` happens then while there is no action `{?Ch m1 l s1 where s1 \neq ACE_UD}`, we check whether an action `{?Ch m2 l s2 where m2 \neq m1 and s1 \neq ACE_I}` happens. If this is the case, then the property is not satisfied (`false`).

The MCL formula expressing this action-based property is the following:

```
[ true * .
  {?Ch:String ?op:String ?m1:Nat ?l:Nat !"ACE_UD"} .
  ( not ({?Ch:String ?op:String !m1 !l ?s1:String
    where ace_state (s1) and (s1<>"ACE_UD")}) ) * .
  {?Ch:String ?op:String ?m2:Nat !l ?s2:String
    where (m2<>m1) and ace_state (s2)
    and (s2<>"ACE_I")}
] false
```

¹The φ_1 to φ_4 refer to the MCL formulæ written to validate the model (and not the ACE specification) described in the Sec. 5.5

A.2 Unique clean coherency

The second cache state coherency formula (φ_6) is similar to φ_5 and requires that if a cache line (master $m1$, memory line l) is in the state `ACE_UC` (the cache line is unique and not modified), then as long as the line does not change its status, all cache lines of other masters ($m2 \neq m1$) containing the same memory line (l) must be in the state `ACE_I` (the cache line is invalid).

The corresponding action-based property expresses that if an action `{?Ch m1 l ACE_UC}` happens, then while there is no action `{?Ch m1 l s1 where s1 \neq ACE_UC}`, we check whether an action `{?Ch m2 l s2 where m2 \neq m1 and s1 \neq ACE_I}` happens. If this is the case, the property is not satisfied (`false`).

This action-based property is expressed by the following MCL formula:

```
[ true * .
  {?Ch:String ?op:String ?m1:Nat ?l:Nat !"ACE_UC"} .
  ( not ({?Ch:String ?op:String !m1 !l ?s1:String
    where ace_state (s1) and (s1<>"ACE_UC")}) ) * .
  {?Ch:String ?op:String ?m2:Nat !l ?s2:String
    where (m2<>m1) and ace_state (s2)
    and (s2<>"ACE_I")}
] false
```

A.3 Shared dirty coherency

The third cache state coherency formula (φ_7) requires that if a cache line (master $m1$, memory line l) is in the state `ACE_SD` (the cache line is shared and modified), then as long as the line does not change its status, all cache lines of other masters ($m2 \neq m1$) containing the same memory line (l) must be either in the state `ACE_SC` (the cache line is shared and not modified) or in the state `ACE_I` (the cache line is invalid).

The corresponding action-based property expresses that if an action `{?Ch m1 l ACE_SD}` happens, then while there is no action `{?Ch m1 l s1 where s1 \neq ACE_SD}`, we check whether an action `{?Ch m2 l s2 where m2 \neq m1 and s1 \neq ACE_I and s1 \neq ACE_SC}` happens. If this is the case, the property is not satisfied (`false`).

This action-based property is expressed by the following MCL formula:

```
[ true * .
  {?Ch:String ?op:String ?m1:Nat ?l:Nat !"ACE_SD"} .
  ( not ({?Ch:String ?op:String !m1 !l ?s1:String
```

```

    where ace_state (s1) and (s1<>"ACE_SD")) ) * .
  {?Ch:String ?op:String ?m2:Nat !l ?s2:String
    where (m2<>m1) and ace_state(s2)
      and (s2<>"ACE_I" and (s2<>"ACE_SC"))}
] false

```

A.4 Shared clean coherency

The fourth cache state coherency formula (φ_8) requires that if a cache line (master m_1 , memory line l) is in the state `ACE_SC` (the cache line is shared and not modified), then as long as the line does not change its status, all cache lines of other masters ($m_2 \neq m_1$) containing the same memory line (l) must be either in a shared state (`ACE_SD` or `ACE_SC`) or an invalid state (`ACE_I`).

The corresponding action-based property expresses that if an action $\{?Ch\ m_1\ l\ ACE_SC\}$ happens then while there is no action $\{?Ch\ m_1\ l\ s_1\ \text{where } s_1 \neq ACE_SC\}$, we check whether an action $\{?Ch\ m_2\ l\ s_2\ \text{where } m_2 \neq m_1\ \text{and } s_1 \neq ACE_I\ \text{and } s_1 \neq ACE_SC\ \text{and } s_1 \neq ACE_SD\}$ happens. If this is the case, the property is not satisfied (`false`).

This action-based property is expressed by the following MCL formula:

```

[ true * .
  {?Ch:String ?op:String ?m1:Nat ?l:Nat !"ACE_SC"} .
  ( not ({?Ch:String ?op:String !m1 !l ?s1:String
    where ace_state (s1) and (s1<>"ACE_SC")) ) * .
  {?Ch:String ?op:String ?m2:Nat !l ?s2:String
    where (m2<>m1) and ace_state(s2) and (s2<>"ACE_I")
      and (s2<>"ACE_SC") and (s2<>"ACE_SD"))}
] false

```

A.5 Unique clean data integrity

The unique clean state requires that the data in the cache line (`data1`) must be equal to the data in the shareable memory (`data2`). Once we detect an `ACE_UC` state and as long as the line does not change its status, we require that `data2` (data in the shareable memory) is equal to `data1`.

In the action-based view, an action containing an `ACE_UC` state can be a data transfer action (action with data) or a control action (action without data). Each case corresponds to a different MCL formula (two formulæ are expressed).

The first formula (φ_9) concerns a data transfer action with an `ACE_UC`. In this case when

Appendix A. Model Checking Properties

we observe an action $\{?Ch \ !m1 \ !l \ !data1 \ !ACE_UC\}$, then as long as there is neither an action $\{?Ch \ !m1 \ !l \ !s1 \ \text{where } s1 \langle \rangle ACE_UC\}$ (action without data) nor an action $\{?Ch \ m1 \ l \ data \ s1 \ \text{where } s1 \langle \rangle ACE_UC\}$ (action with data). We check whether an action $\{R \ !0 \ !l \ !data2 \ \text{where } data2 \langle \rangle data1\}$ happens. In fact, the read response R from the shareable memory 0 is the only outgoing data transfer transaction from the memory. If such a response occurs, the property is not satisfied (**false**).

The formula φ_9 is expressed as follows:

```
[ true * .
  {?Ch:String ?op:String ?m1:Nat ?l:Nat ?data1:Nat !"ACE_UC"} .
  (
    not ({?Ch:String ?op:String !m1 !l ?h:Nat ?s:String
          where ace_state (s) and (s<>"ACE_UC")})
    and
    not ({?Ch:String ?op:String !m1 !l ?s:String
          where ace_state (s) and (s<>"ACE_UC")})
  )* .
  {R ?op:string !"0" !l ?data2:Nat ?m2:Nat
   where (data2<>data1)}
] false
```

The second formula (φ_{10}) concerns a control action with an ACE_UC state. The data transfer containing the data happens in a different action. In the beginning, we save the data present in an action with a different cache state than ACE_UC $\{?Ch \ !m1 \ !l \ !data \ !s1 \ \text{where } s1 \langle \rangle ACE_UC\}$, then we note an action $\{?Ch \ !m1 \ !l \ !ACE_UC\}$. As long as there is neither an action $\{?Ch \ !m1 \ !l \ !s1 \ \text{where } s1 \langle \rangle ACE_UC\}$ (action without data) nor an action $\{?Ch \ !m1 \ !l \ !data \ !s1 \ \text{where } s1 \langle \rangle ACE_UC\}$ (action with data). We check whether an action $\{R \ !0 \ !l \ !data2 \ \text{where } data2 \langle \rangle data1\}$ happens. If such a response occurs, the property is not satisfied (**false**).

The formula φ_{10} is expressed as follows:

```
[ true * .
  {?Ch:String ?op:String ?m1:Nat ?l:Nat ?data1:Nat ?s:String
   where ace_state (s) and (s<>"ACE_UC")} .
  (not {?Ch:String ?op:String ?m1:Nat ?l:Nat !"ACE_UC"})* .
  {?Ch:String ?op:String ?m1:Nat ?l:Nat !"ACE_UC"} .
  (
    not ({?Ch:String ?op:String !m1 !l ?h:Nat ?s:String
          where ace_state (s) and (s<>"ACE_UC")})
    and
  )
```

```

    not ({?Ch:String ?op:String !m1 !l ?s:String
          where ace_state (s) and (s<>"ACE_UC")})
  )* .
  {R ?op:string !"0" !l ?data2:Nat ?m2:Nat
    where (data2<>data1)}
] false

```

A.6 Shared dirty data integrity

The shared dirty state requires that the `data1` located in the cache line (master `m1`, memory line `l`) must be equal to the `data2` in any valid cache line of an other master (`m2` \neq `m1`) containing the same memory line (`l`) (Particularly, the cache state of this one is shared clean).

In the action-based view, an action containing an `ACE_SD` state can have data or not. Each case corresponds to a different MCL formula (two formulæ are expressed).

The first formula (φ_{11}) concerns a data transfer action with an `ACE_SD` state. In this case we note an action `{?Ch !m1 !l !data1 !ACE_SD}`, then as long as there is neither an action `{?Ch !m1 !l !s1 where s1<>ACE_SD}` (action without data) nor an action `{?Ch !m1 !l !data !s1 where s1<>ACE_SD}` (action with data). We check whether an action `{?Ch !m2 !l !data2 !s where data2<>data1 and s==ACE_SC}` happens. If such a response occurs, the property is not satisfied (`false`).

The formula φ_{11} is expressed as follows:

```

[ true * .
  {?Ch:String ?op:String ?m1:Nat ?l:Nat ?data1:Nat !"ACE_SD"} .
  (
    not ({?Ch:String ?op:String !m1 !l ?h:Nat ?s:String
          where ace_state (s) and (s<>"ACE_SD")})
    and
    not ({?Ch:String ?op:String !m1 !l ?s:String
          where ace_state (s) and (s<>"ACE_SD")})
  )* .
  {?Ch:String ?op:String ?m2:Nat !l ?data2:Nat ?"ACE_SC"
    where (m2<>m1) and (data2<>data1)}
] false

```

The second formula (φ_{12}) concerns a control action with an `ACE_SD` state. The data transfer containing the data happens in a different action. In the beginning, we save the data present in an action with a different cache state than `ACE_SD` `{?Ch !m1 !l`

Appendix A. Model Checking Properties

$\{!data\ !s1\ \text{where}\ s1\langle>ACE_SD\}\}$, then we note an action $\{?Ch\ !m1\ !l\ !ACE_SD\}$. As long as there is neither an action $\{?Ch\ !m1\ !l\ !s1\ \text{where}\ s1\langle>ACE_SD\}$ (action without data) nor an action $\{?Ch\ !m1\ !l\ !data\ !s1\ \text{where}\ s1\langle>ACE_SD\}$ (action with data). We check whether an action $\{?Ch\ !m2\ !l\ !data2\ !s\ \text{where}\ data2\langle>data1\ \text{and}\ s==ACE_SC\}$ happens. If such a response occurs, the property is not satisfied (**false**).

The formula φ_{12} is expressed as follows:

```
[ true * .
  {?Ch:String ?op:String ?m1:Nat ?l:Nat ?data1:Nat ?s:String
    where ace_state (s) and (s<>"ACE_SD")} .
  (not {?Ch:String ?op:String ?m1:Nat ?l:Nat !"ACE_SD"})* .
  {?Ch:String ?op:String ?m1:Nat ?l:Nat !"ACE_SD"} .
  (
    not ({?Ch:String ?op:String !m1 !l ?h:Nat ?s:String
      where ace_state (s) and (s<>"ACE_SD")})
    and
    not ({?Ch:String ?op:String !m1 !l ?s:String
      where ace_state (s) and (s<>"ACE_SD")})
  )* .
  {?Ch:String ?op:String ?m2:Nat !l ?data2:Nat ?"ACE_SC"
    where (m2<>m1) and (data2<>data1)}
] false
```

A.7 Shared clean data integrity

The shared clean state requires that the data (**data1**) in the cache line (master **m1**, memory line **l**) must be equal to the data (**data2**) in any cache line of an other master (**m2** \neq **m1**) containing the same memory line (**l**).

In the action-based view, an action containing an **ACE_SC** state can be with data or without data. Each case corresponds to a different MCL formula. Two formulæ are expressed.

The first formula (φ_{13}) concerns a data transfer action with an **ACE_SC** state. In this case we note an action $\{?Ch\ m1\ l\ data1\ ACE_SC\}$, then as long as there is neither an action $\{?Ch\ m1\ l\ s1\ \text{where}\ s1\ \neq\ ACE_SC\}$ (action without data) nor an action $\{?Ch\ m1\ l\ data\ s1\ \text{where}\ s1\ \neq\ ACE_SC\}$ (action with data). We check whether an action $\{?Ch\ m2\ l\ data2\ s\ \text{where}\ data2\ (m2\langle>m1)\ \text{and}\ ((s="ACE_SC"\ \text{or}\ s="ACE_SD"))\ \text{and}\ (data2\langle>data1)\}$ happens. In this case, the property is not satisfied (**false**).

The formula φ_{13} is expressed as follows:

```
[ true * .
  {?Ch:String ?op:String ?m1:Nat ?l:Nat ?data1:Nat !"ACE_SC"} .
  (
    not ({?Ch:String ?op:String !m1 !l ?any of Nat ?s:String
          where ace_state (s) and (s<>"ACE_SC")})
    and
    not ({?Ch:String ?op:String !m1 !l ?s:String
          where ace_state (s) and (s<>"ACE_SC")})
  )* .

  {?Ch:String ?op:String ?m2:Nat !l ?data2:Nat ?"ACE_SC"|"ACE_SD"
    where (m2<>m1) and (data2<>data1)}
] false
```

The second formula (φ_{14}) concerns a control action with an ACE_SC sstate. The data transfer containing the data happens in a different action. In the beginning, we save the data present in an action with a different cache state than ACE_SC $\{?Ch\ m1\ l\ data\ s1\ where\ s1 \neq ACE_SC\}$, then we note an action $\{?Ch\ m1\ l\ ACE_SC\}$. As long as there is neither an action $\{?Ch\ m1\ l\ s1\ where\ s1 \neq ACE_SC\}$ (action without data) nor an action $\{?Ch\ m1\ l\ data\ s1\ where\ s1 \neq ACE_SC\}$ (action with data). We check whether an action $\{?Ch\ m2\ l\ data2\ s\ where\ data2\ (m2<>m1)\ and\ ((s="ACE_SC"\ or\ s="ACE_SD"))\ and\ (data2<>data1)\}$ happens. In this case, the property is not satisfied (false):

The formula φ_{14} is expressed as follows:

```
[ true * .
  {?Ch:String ?op:String ?m1:Nat ?l:Nat ?data1:Nat ?s:String
    where ace_state (s) and (s<>"ACE_SC")} .
  (not {?Ch:String ?op:String ?m1:Nat ?l:Nat !"ACE_SC"})* .
  {?Ch:String ?op:String ?m1:Nat ?l:Nat !"ACE_SC"} .
  (
    not ({?Ch:String ?op:String !m1 !l ?h:Nat ?s:String
          where ace_state (s) and s<>("ACE_SC")})
    and
    not ({?Ch:String ?op:String !m1 !l ?s:String
          where ace_state (s) and (s<>"ACE_SC")})
  )* .

  {?Ch:String ?op:String ?m2:Nat !l ?data2:Nat ?"ACE_SC"|"ACE_SD"
```

```

    where (m2<>m1) and (data2<>data1)}
] false

```

A.8 Shareable memory data integrity

The following formula (φ_{15}), requires correct order of write operations to the shareable memory:

```

[ true * .
  {W !"WRITEBACK" ?m:Nat ?l:Nat ?d:Nat}.
  (not{W !"WRITEBACK" !0 !l !d !m})*.
  {W !"WRITEBACK" !0 !l !d !m}.
  ( (not{AC ... !m ?any of Nat !l}) and
    (not{W ?any of String !0 !l ?any of Nat ...}) )*.
  {W ?any of String !0 !l ?h:Nat ... where h<>d}
] false

```

Once a master m initiates a memory update (*WriteBack* transaction: first action on gate W) of a memory line l and a data d , and this update is actually written to memory (second action on gate W , with port number 0, i.e., the memory) as second offer, the property forbids a data h different from d to be written to the same memory line l without previously receiving a snoop request (gate AC) concerning line l ².

A.9 Read response no PassDirty property

According to the ACE specification [ARM13], for several transactions (i.e., *ReadOnce*, *ReadClean*, *CleanUnique*, *MakeUnique*, *CleanShared*) the master initiating the transaction cannot take the responsibility to write the data on the memory, so the `PassDirty` parameter of the read response channel R has to be deserted (`false`).

As described in Section 5.2.3, the sixth parameter of a read response channel R is a boolean corresponding the `PassDirty` parameter and the seventh parameter is a boolean corresponding to the `IsShared` parameter.

We add the following formula (φ_{16}), which checks the correct positioning of the `PassDirty` parameter:

```

[

```

²The number of parameters differs for the rendezvous on gate W between the CCI and the memory and those between a master and the CCI: for the former, the fifth parameter corresponds to the index of the initiator.

A.10. Read response no IsShared property

```

true * .
{AR ?op:String ?m:Nat ?l:Nat ?any of String
  where (op="READONCE") or (op="READCLEAN") or (op="CLEANUNIQUE")
        or (op="MAKEUNIQUE") or (op="CLEANSHARED")}.
(
  not({R !op !m !l ?any of Nat ?any of bool ?any of bool ?any of bool})
)*.
{R !op !m !l ?any of Nat ?any of bool !"TRUE" ?any of bool}
] false

```

The formula φ_{16} concerns read address `AR` actions containing one of the following transactions: *ReadOnce*, *ReadClean*, *CleanUnique*, *MakeUnique*, or *CleanShared*. In fact, the corresponding read response `R` action (same transaction `op`) must have the `PassDirty` parameter de-asserted. If this is not the case (i.e., `PassDirty==TRUE`), the property is not satisfied (`false`).

A.10 Read response no IsShared property

Several ACE transactions must lead to a unique state (i.e., *ReadNoSnoop*, *ReadUnique*, *CleanUnique*, *MakeUnique*, *CleanInvalid*, *MakeInvalid*). The `IsShared` parameter of the read response channel `R` has to be de-asserted (`false`). i.e., the cache line is unique.

We add the following formula (φ_{17}), which checks the correct positioning of the `IsShared` parameter.

```

[
true * .
  {AR ?op:String ?m:Nat ?l:Nat ?any of String
    where ((op="READNOSNOOP") or (op="READUNIQUE") or (op="CLEANUNIQUE")
          or (op="MAKEUNIQUE") or (op="CLEANINVALID"))}.
  (
    not({R !op !m !l ?any of Nat ?any of bool ?any of bool ?any of bool})
  )*.
  {R !op !m !l ?any of Nat ?any of bool ?any of bool !"TRUE"}
] false

```

The formula φ_{17} concerns read address `AR` actions containing one of the following transactions: *ReadNoSnoop*, *ReadUnique*, *CleanUnique*, *MakeUnique*, or *CleanInvalid*. In fact, the corresponding read response `R` action must have the `IsShared` parameter de-asserted. If it is not the case (i.e., `IsShared==TRUE`), the property is not satisfied (`false`).

A.11 Read response no IsSharedDirty property

The formula (φ_{18}) corresponds to the *ReadNotSharedDirty* transaction which must not lead to a shared dirty state (*ACE_SD*). The *PassDirty* and *IsShared* parameters of read response channel *R* must never be both asserted (*true*).

```
[
  true * .
  {AR ?op:String ?m:Nat ?l:Nat ?any of String
    where (op="READNOTSHARED DIRTY")}.
  (
    not({R !op !m !l ?any of Nat ?any of bool ?any of bool ?any of bool})
  )*.
  {R !op !m !l ?any of Nat ?any of bool !"TRUE" !"TRUE"}
] false
```

A.12 Coherency response PassDirty property

The *PassDirty* parameter of the coherency response channel *CR* has to be asserted (*true*) if and only if the *ACE* state before the *CR* request is either *ACE_UD* or *ACE_SD* and the *ACE* state after the *CR* request is either *ACE_UC*, *ACE_SC*, or *ACE_I*.

As described in Section 5.2.3, the sixth parameter of a coherent response channel *CR* is a boolean corresponding to the *PassDirty* parameter and the seventh parameter is a boolean corresponding to the *IsShared* parameter.

The corresponding formula (φ_{19}) expresses that if the *ACE* state switch from a dirty state to a clean or invalid state during a coherent response *CR* action, the *PassDirty* must be asserted. If this is not the case, the property is not satisfied (*false*).

The formula (φ_{19}) is expressed as follows:

```
[
  true * .
  {?Ch:String ?op:String ?m:Nat ?l:Nat ?"ACE_UD"|"ACE_SD"} .
  (
    ( not({?Ch:String ?op:String !m !l ?s:String})
      and ( not{CR ?op:String !m !l ...})
    )*.
  {CR ?op:String !m !l ?any of Nat ?any of bool !"FALSE" ?any of bool} .
  (
    ( not({?Ch:String ?op:String !m !l ?s:String})

```

A.13. Coherency response no PassDirty property

```
    and ( not{CR ?op:String !m !l ...})
  )*.
  {?Ch:String ?op:String !m !l ?"ACE_UC"|"ACE_SC"|"ACE_I"}
] false
```

A.13 Coherency response no PassDirty property

The `PassDirty` parameter of the coherency response channel `CR` must be deserted (`PassDirty=FALSE`) in two cases: firstly, when a dirty state remains dirty, and secondly, when an ACE state was clean or invalid before the `CR` action.

This property is expressed by two formulæ. The first formula (φ_{20}) checks if a `PassDirty` is asserted just after an action with a clean or invalid state. In this case, the property is not satisfied (`false`).

The formula φ_{20} is expressed as follows:

```
[
  true * .
  {?Ch:String ?op:String ?m:Nat ?l:Nat ?s:String
   where ace_state (s) and ((s<>"ACE_UD") and (s<>"ACE_SD"))} .
  (
    ( not({?Ch:String ?op:String !m !l ?s:String})
      and ( not{CR ?op:String !m !l ...})
    )*.
  {CR ?op:String !m !l ?any of Nat ?any of bool !"TRUE" ?any of bool}
] false
```

The second formula (φ_{21}) checks if a `PassDirty` is asserted just before an action with a dirty state. In this case the property is not satisfied (`false`).

The formula φ_{21} is expressed as follows:

```
[
  true * .
  {CR ?op:String !m !l ?any of Nat ?any of bool !"TRUE" ?any of bool} .
  (
    ( not({?Ch:String ?op:String !m !l ?s:String})
      and ( not{CR ?op:String !m !l ...})
    )*.

```

```
{?Ch:String ?op:String !m !l ?"ACE_UD"|"ACE_SD"}
] false
```

A.14 Coherency response IsShared property

The `IsShared` parameter of the coherency response channel `CR` has to be asserted (`IsShared=true`) if and only if the ACE state after the `CR` request is a valid state (`ACE_UC`, `ACE_SC`, `ACE_UD`, or `ACE_SD`).

The formula φ_{22} expresses this property as follows:

```
[
true * .
{CR ?op:String !m !l ?any of Nat ?any of bool ?any of bool !"FALSE"} .
(
(not({?Ch:String ?op:String !m !l ?s:String})
and ( not{CR ?op:String !m !l ...}))
)*.
{?Ch:String ?op:String !m !l ?"ACE_UD"|"ACE_SD"|"ACE_UC"|"ACE_SC"}
] false
```

A.15 Coherency response no IsShared property

The `IsShared` parameter of the coherency response channel `CR` has to be de-asserted (`IsShared=false`) if and only if the ACE state after the `CR` request is the invalid state.

The formula (φ_{23}) expresses that the `IsShared` cannot be asserted just before an action from the same master (`m`) and memory line (`l`) with an invalid state (`ACE_I`):

```
[
true * .
{CR ?op:String !m !l ?any of Nat ?any of bool ?any of bool !"TRUE"} .
(
(not({?Ch:String ?op:String !m !l ?s:String})
and ( not{CR ?op:String !m !l ...}))
)*.
{?Ch:String ?op:String !m !l ?"ACE_I"}
] false
```

Bibliography

- [ABG⁺00] Yael Abarbanel, Ilan Beer, Leonid Gluhovsky, Sharon Keidar, and Yaron Wolfsthal. Focs-automatic generation of simulation checkers from formal specifications. In *Computer Aided Verification*, pages 538–542. Springer, 2000.
- [AFV01] Luca Aceto, Wan Fokkink, and Chris Verhoef. *Structural Operational Semantics*, chapter 3, pages 197–292. 2001.
- [And91] David F Anderson. Continuous-time markov chains. 1991.
- [ARM12] ARM. *CoreLink CCI-400 Cache Coherent Interconnect: Technical Reference Manual*, November 2012. revision r1p1, http://infocenter.arm.com/help/topic/com.arm.doc.ddi0470g/DDI0470G_cci400_r1p1_trm.pdf.
- [ARM13] ARM. *AMBA AXI and ACE Protocol Specification*, February 2013. version ARM IHI 0022E, <http://infocenter.arm.com/help/topic/com.arm.doc.ih0022e>.
- [BAPM83] Mordechai Ben-Ari, Amir Pnueli, and Zohar Manna. The temporal logic of branching time. *Acta informatica*, 20(3):207–226, 1983.
- [BB88] Tommaso Bolognesi and Ed Brinksma. Introduction to the iso specification language lotos. *Computer Networks and ISDN Systems*, 14(1):25–59, January 1988.
- [BCC⁺03] Armin Biere, Alessandro Cimatti, Edmund M Clarke, Ofer Strichman, and Yunshan Zhu. Bounded model checking. *Advances in computers*, 58:117–148, 2003.
- [BCL⁺94] J. BURCH, E. Clarke, D. Long, K. McMillan, and D. Dill. Symbolic model checking for sequential circuit verification. *IEEE Trans. Computer-Aided Design Integration of Circuits*, 13:401–424, April 1994.
- [BCM⁺90] Jerry R Burch, Edmund M Clarke, Kenneth L McMillan, David L Dill, and Lain-Jinn Hwang. Symbolic model checking: 10 20 states and beyond. In

Bibliography

- Logic in Computer Science, 1990. LICS'90, Proceedings., Fifth Annual IEEE Symposium on*, pages 428–439. IEEE, 1990.
- [BED03] Vincent Beaudenon, Emmanuelle Encrenaz, and J-L Desbarbieux. Design validation of zcsp with spin. In *Application of Concurrency to System Design, 2003. Proceedings. Third International Conference on*, pages 102–110. IEEE, 2003.
- [BGH⁺99] Mike Benjamin, Daniel Geist, Alan Hartman, Gerard Mas, and Ralph Smeets. A Study in Coverage-Driven Test Generation. In *Proceedings of the 36th Design Automation Conference*, pages 970–975. IEEE, June 1999.
- [BK⁺08] Christel Baier, Joost-Pieter Katoen, et al. *Principles of model checking*, volume 26202649. MIT press Cambridge, 2008.
- [BKS08] Nicolas Blanc, Daniel Kroening, and Natasha Sharygina. Scoot: A tool for the analysis of systemc models. In *Tools and Algorithms for the Construction and Analysis of Systems*, pages 467–470. Springer, 2008.
- [CCG⁺14] David Champelovier, Xavier Clerc, Hubert Garavel, Yves Guerte, Christine McKinty, Vincent Powazny, Frédéric Lang, Wendelin Serwe, and Gideon Smeding. Reference manual of the LNT to LOTOS translator (version 6.0). INRIA/VASY - INRIA/CONVECS, 125 pages, 2014.
- [CFZ95] E. M. Clarke, M. Fujita, and X. Zhao. Hybrid decision diagrams. In *International Conference on Computer-Aided Design, ICCAD-95. 1995 IEEE/ACM International Conference on*, pages 159–163. IEEE, 1995.
- [CGH⁺95] Edmund M. Clarke, Orna Grumberg, Hiromi Hiraishi, Somesh Jha, David E. Long, Kenneth L. McMillan, and Linda A. Ness. Verification of the Futurebus+ cache coherence protocol. *Formal Methods in System Design*, 6(2):217–232, March 1995.
- [CGM⁺96] Ghassan Chehaibar, Hubert Garavel, Laurent Mounier, Nadia Tawbi, and Ferruccio Zulian. Specification and verification of the powerscale bus arbitration protocol: An industrial experiment with lotos. In Reinhard Gotzhein and Jan Bredereke, editors, *Proceedings of the Joint International Conference on Formal Description Techniques for Distributed Systems and Communication Protocols, and Protocol Specification, Testing, and Verification FORTE/P-STV'96 (Kaiserslautern, Germany)*, pages 435–450. IFIP, 1996.
- [CGP00] Edmund M Clarke, Orna Grumberg, and Doron Peled. *Model checking*. MIT press, 2000.
- [Che04] Ghassan Chehaibar. Integrating formal verification with Mur ϕ of distributed cache coherence protocols in FAME multiprocessor system design. In David

- de Frutos-Escrig and Manuel Núñez, editors, *Proceedings of the 24th IFIP WG 6.1 International Conference on Formal Techniques for Networked and Distributed Systems FORTE 2004 (Madrid, Spain)*, volume 3235 of *Lecture Notes in Computer Science*, pages 243–258. Springer, September 2004.
- [CHLS09] Nicolas Coste, Holger Hermanns, Etienne Lantreibecq, and Wendelin Serwe. Towards performance prediction of compositional models in industrial gals designs. In Ahmed Bouajjani and Oded Maler, editors, *Proceedings of the 21th International Conference on Computer Aided Verification CAV'2009 (Grenoble, France)*, volume 5643, pages 204–218, July 2009.
- [CL11] Pepijn Crouzen and Frédéric Lang. Smart reduction. In Dimitra Gianakopoulou and Fernando Orejas, editors, *Proceedings of Fundamental Approaches to Software Engineering FASE'2011 (Saarbrücken, Germany)*, volume 6603, pages 111–126, March 2011.
- [CM11] Mingsong Chen and Prabhat Mishra. Property learning techniques for efficient generation of directed tests. *IEEE Transactions on Computers*, 60(6):852–864, 2011.
- [CQKM13] Mingsong Chen, Xiaoke Qin, Heon-Mo Koo, and Prabhat Mishra. *System-Level Validation: High-Level Modeling and Directed Test Generation Techniques*. Springer, 2013.
- [CS96] Rance Cleaveland and Scott A. Smolka. Strategic directions in concurrency research. *ACM Comput. Surv.*, 28(4):607–625, December 1996.
- [CTVW04] Edmund Clarke, Muralidhar Talupur, Helmut Veith, and Dong Wang. Sat based predicate abstraction for hardware verification. In *Theory and Applications of Satisfiability Testing*, pages 78–92. Springer, 2004.
- [CYGC10] Xiaofang Chen, Yu Yang, Ganesh Gopalakrishnan, and Ching-Tsun Chou. Efficient methods for formally verifying safety properties of hierarchical cache coherence protocols. *Formal Methods in System Design*, 36(1):37–64, February 2010.
- [CZM09] Ghassan Chehaibar, Meriem Zidouni, and Radu Mateescu. Modeling multiprocessor cache protocol impact on mpi performance. In *Advanced Information Networking and Applications Workshops, 2009. WAINA'09. International Conference on*, pages 1073–1078. IEEE, 2009.
- [DCF⁺14] Rolf Drechsler, Christophe Chevallaz, Franco Fummi, Alan J Hu, Ronny Morad, Frank Schirrmeister, and Alex Goryachev. Future soc verification methodology: Uvm evolution or revolution? In *Proceedings of the conference on Design, Automation & Test in Europe*, page 372. European Design and Automation Association, 2014.

Bibliography

- [DDHY92] David L. Dill, Andreas J. Drexler, Alan J. Hu, and C. Han Yang. Protocol verification as a hardware design aid. In *Proceedings of the International Conference on Computer Design: VLSI in Computers and Processors ICCD'92*, pages 522–525. IEEE, October 1992.
- [DFH⁺91] Gilles Dowek, Amy Felty, Hugo Herbelin, Gérard Huet, Benjamin Werner, Christine Paulin-Mohring, et al. The coq proof assistant user's guide: Version 5.6, 1991.
- [DGG⁺05] Anat Dahan, Daniel Geist, Leonid Gluhovsky, Dmitry Pidan, Gil Shapir, Yaron Wolfsthal, Lyes Benalycherif, R Kamidem, and Younes Lahbib. Combining system level modeling with assertion based verification. In *Quality of Electronic Design, 2005. ISQED 2005. Sixth International Symposium on*, pages 310–315. IEEE, 2005.
- [Dil96] D. Dill. The mur ϕ verification system. In R. Alur and T. Henzinger, editors, *Proceedings of the 8th International Conference on Computer-Aided Verification CAV'96*, 1996.
- [dVT01] René G. de Vries and Jan Tretmans. Towards formal test purposes. In *Formal Approaches to Testing of Software FATES'01*, pages 61–76. BRICS Notes Series, 2001.
- [EM95] Ásgeir Th. Eiríksson and Kenneth L. McMillan. Using Formal Verification/-Analysis Methods on the Critical Path in System Design: A Case Study. In Pierre Wolper, editor, *Proceedings of the 7th International Conference on Computer Aided Verification CAV (Liège, Belgium)*, volume 939 of *Lecture Notes in Computer Science*, pages 367–380. Springer, July 1995.
- [FJJV96] Jean-Claude Fernandez, Claude Jard, Thierry Jéron, and César Viho. Using on-the-fly verification techniques for the generation of test suites. In *Computer Aided Verification*, pages 348–359. Springer, 1996.
- [Fou88] National Science Foundation, editor. *Final Report: NSF Workshop on Billion-Transistor Systems*. NSF, 1988.
- [FTHJ10] Sahar Foroutan, Yvain Thonnart, Richard Hersemeule, and Ahmed Jerraya. A markov chain based method for noc end-to-end latency evaluation. In *IEEE International Symposium on Parallel and Distributed Processing, Workshops and Phd Forum (IPDPSW), (Atlanta, Georgia, USA)*, pages 1–8. IEEE, April 2010.
- [G⁺05] Frank Ghenassia et al. *Transaction-level modeling with SystemC*. Springer, 2005.

-
- [Gar13] Hubert Garavel, editor. *Formal Methods for Safe and Secure Computers Systems*, volume BSI Study 875 of *Federal Office for Information Security*. Bundesamt für Sicherheit in der Informationstechnik (BSI), 2013.
- [GH99] A. Gargantini and C. Heitmeyer. Using model checking to generate tests from requirements specifications. *ACM SIGSOFT Software Engineering Notes*, 24:146–162, 1999.
- [GH02] Hubert Garavel and Holger Hermanns. On combining functional verification and performance evaluation using cadp. In Lars-Henrik Eriksson and Peter A. Lindsay, editors, *Proceedings of the 11th International Symposium of Formal Methods Europe FME'2002 (Copenhagen, Denmark)*, volume 2391, pages 410–429, 2002.
- [GHPS09] Hubert Garavel, Claude Helmstetter, Olivier Ponsini, and Wendelin Serwe. Verification of an industrial systemc/tlm model using lotos and cadp. In *Proceedings of the 7th ACM-IEEE International Conference on Formal Methods and Models for Codesign MEMOCODE'2009 (Cambridge, MA, USA)*, 2009.
- [GL01] Hubert Garavel and Frédéric Lang. Svl: a scripting language for compositional verification. In Myungchul Kim, Byoungmoon Chin, Sungwon Kang, and Danhyung Lee, editors, *Proceedings of the 21st IFIP WG 6.1 International Conference on Formal Techniques for Networked and Distributed Systems FORTE'2001 (Cheju Island, Korea)*, pages 377–392. IFIP, Kluwer Academic Publishers, August 2001. Full version available as INRIA Research Report RR-4223.
- [GLMS13] Hubert Garavel, Frédéric Lang, Radu Mateescu, and Wendelin Serwe. Cadp 2011: A toolbox for the construction and analysis of distributed processes. *Software Tools for Technology Transfer*, 15(2):89–107, April 2013.
- [GM04] Hubert Garavel and Radu Mateescu. Seq.open: A tool for efficient trace-based verification. In Susanne Graf and Laurent Mounier, editors, *Proceedings of the 11th International SPIN Workshop on Model Checking of Software SPIN'2004 (Barcelona, Spain)*, volume 2989, pages 150–155, April 2004.
- [Gor01] Mike Gordon. *HOL—a machine oriented formulation of higher order logic*. Citeseer, 2001.
- [GVZ00] Hubert Garavel, César Viho, and Massimo Zendri. System design of a cc-numa multiprocessor architecture using formal specification, model-checking, co-simulation, and test generation. Research Report RR-4041, INRIA, November 2000.
- [GVZ01] Hubert Garavel, César Viho, and Massimo Zendri. System design of a cc-numa multiprocessor architecture using formal specification, model-checking,

Bibliography

- co-simulation, and test generation. *International Journal on Software Tools for Technology Transfer*, 3(3):314–331, 2001.
- [GW95] Michel X Goemans and David P Williamson. Improved approximation algorithms for maximum cut and satisfiability problems using semidefinite programming. *Journal of the ACM (JACM)*, 42(6):1115–1145, 1995.
- [Her02] Holger Hermanns. *Interactive Markov chains: and the quest for quantified quality*. Springer-Verlag, 2002.
- [Hol97] Gerard J. Holzmann. State compression in spin: Recursive indexing and compression training runs. In *Proceedings of SPIN97 the 3rd SPIN Workshop (Twente University, Enschede, The Netherlands)*, 1997.
- [ISO89] ISOIS ISO. Osi 8807-lotos: a formal description technique based on the temporal ordering of observational behaviour. *International standard, ISO*, 1989.
- [JJ05] Claude Jard and Thierry Jéron. Tgv: theory, principles and algorithms. *International Journal on Software Tools for Technology Transfer*, 7(4):297–315, 2005.
- [JM99] T. Jéron and P. Morel. Test generation derived from model-checking. In N. Halbwachs and D. Peled, editors, *Proceedings of the Conference on Computer-Aided Verification CAV'99 (Trento, Italy)*, volume 1633, pages 108–122, July 1999.
- [JOS⁺01] Robert B Jones, John W O’Leary, Carl-Johan H Seger, Mark D Aagaard, and Thomas F Melham. Practical formal verification in microprocessor design. *IEEE Design & Test of Computers*, 18(4):16–25, 2001.
- [JW96] Daniel Jackson and Jeannette Wing. Lightweight formal methods. *IEEE Computer*, 29(1):21–22, 1996.
- [Käs03] Daniel Kästner. Tdl: a hardware description language for retargetable post-pass optimizations and analyses. In *Generative Programming and Component Engineering*, pages 18–36. Springer, 2003.
- [KG99] Christoph Kern and Mark R. Greenstreet. Formal Verification in Hardware Design: A Survey. *ACM Transactions on Design Automation of Electronic Systems*, 4(2):123–193, April 1999.
- [KKVD13] Hemangee K. Kapoor, Praveen Kanakala, Malti Verma, and Shirshendu Das. Design and formal verification of a hierarchical cache coherence protocol for NoC based multiprocessors. *The Journal of Supercomputing*, 2013.

- [KM96] Matt Kaufmann and J Strother Moore. Acl2: An industrial strength version of nqthm. In *Computer Assurance, 1996. COMPASS'96, Systems Integrity. Software Safety. Process Security. Proceedings of the Eleventh Annual Conference on*, pages 23–34. IEEE, 1996.
- [KM97] Jean-Pierre Krimm and Laurent Mounier. Compositional state space generation from lotos programs. In *Tools and Algorithms for the Construction and Analysis of Systems TACAS'1997*, pages 239–258. Springer, 1997.
- [KMBA06] Heon-Mo Koo, Prabhat Mishra, Jayanta Bhadra, and Magdy Abadir. Directed micro-architectural test generation for an industrial processor: A case study. In *Microprocessor Test and Verification, 2006. MTV'06. Seventh International Workshop on*, pages 33–36. IEEE, 2006.
- [KNS01] Marta Kwiatkowska, Gethin Norman, and Roberto Segala. Automated verification of a randomized distributed consensus protocol using cadence smv and prism? In *Computer Aided Verification*, pages 194–206. Springer, 2001.
- [Koz83] Dexter Kozen. Results on the propositional μ -calculus. *Theoretical computer science*, 27(3):333–354, 1983.
- [KS13] Abderahman Kriouile and Wendelin Serwe. Formal analysis of the ace specification for cache coherent systems-on-chip. In Charles Pecheur and Michael Dierkes, editors, *Proceedings of the 18th International Workshop on Formal Methods for Industrial Critical Systems FMICS'2013 (Madrid, Spain)*, volume 8187 of *Lecture Notes in Computer Science*, pages 108–122. Springer, September 2013.
- [KS15] Abderahman Kriouile and Wendelin Serwe. Using a formal model to improve verification of a cache-coherent system-on-chip. In C. Baier and C. Tinelli, editors, *21th International Conference on Tools and Algorithms for the Construction and Analysis of Systems TACAS 2015 (London, UK)*, volume 9035 of *Lecture Notes in Computer Science*, pages 708–722. Springer, April 2015.
- [KVZ98] Hakim Kahlouche, Cesar Viho, and Massimo Zendri. An industrial experiment in automatic generation of executable test suites for a cache coherency protocol. In *Testing of Communicating Systems*, pages 211–226. Springer, 1998.
- [Kyu03] Chong-Min Kyung. Current status and challenges of soc verification for embedded systems market. In *IEEE International SOC Conference*. IEEE, 2003.

Bibliography

- [Len05] Giacomo Lenzi. The modal mu-calculus: a survey. Technical Report 9(3), TASK Quarterly, 2005.
- [LMSG02] Stan Liao, Grant Martin, Stuart Swan, and Thorsten Grötzer. *System Design with SystemC*. Springer Science & Business Media, 2002.
- [LS11] Etienne Lantreibecq and Wendelin Serwe. Model checking and co-simulation of a dynamic task dispatcher circuit using CADP. In Gwen Salaün and Bernhard Schätz, editors, *Proceedings of the 16th International Workshop on Formal Methods for Industrial Critical Systems FMICS 2011 (Trento, Italy)*, volume 6959, pages 180–195, August 2011.
- [LS14] Etienne Lantreibecq and Wendelin Serwe. Formal analysis of a hardware dynamic task dispatcher with cadp. *Science of Computer Programming*, 80:130–149, 2014.
- [Mat03] Radu Mateescu. On-the-fly verification using cadp. In Thomas Arts and Wan Fokkink, editors, *Proceedings of the 8th International Workshop on Formal Methods for Industrial Critical Systems FMICS'2003 (Trondheim, Norway)*, volume 80 of *Electronic Notes in Theoretical Computer Science*. Elsevier, 2003.
- [MC09] Prabhat Mishra and Mingsong Chen. Efficient techniques for directed test generation using incremental satisfiability. In *Proceedings of 22th International Conference on VLSI Design*, pages 65–70. IEEE, 2009.
- [McM93] Kenneth L McMillan. *Symbolic model checking*. Springer, 1993.
- [McM99] Kenneth L. McMillan. The SMV language. Technical report, Cadence Berkeley Labs, March 1999.
- [McM00] Kenneth L. McMillan. A methodology for hardware verification using compositional model checking. *Science of Computer Programming*, 37(1):279–309, 2000.
- [Mel09] Tom F Melham. *Higher order logic and hardware verification*, volume 31. Cambridge University Press, 2009.
- [MHS12] Milo M. K. Martin, Mark D. Hill, and Daniel J. Sorin. Why On-Chip Cache Coherence Is Here to Stay. *Communications of the ACM*, 55(7):78–89, July 2012.
- [MS91] Kenneth L. McMillan and Schwalbe. Formal Verification of the Encore Gigamax cache consistency protocol. In *Proceedings of the International Symposium on Shared Memory Multiprocessors*, pages 242–251, 1991.

- [MSK⁺07] Deepak A Mathaikutty, Sandeep K Shukla, Sreekumar V Kodakara, David Lilja, and Ajit Dingankar. Design fault directed test generation for microprocessor validation. In *Design, Automation & Test in Europe Conference & Exhibition, 2007. DATE'07*, pages 1–6. IEEE, 2007.
- [MT08] Radu Mateescu and Damien Thivolle. A model checking language for concurrent value-passing systems. In Jorge Cuellar, Tom Maibaum, and Kaisa Sere, editors, *Proceedings of the 15th International Symposium on Formal Methods FM'08 (Turku, Finland)*, volume 5014 of *Lecture Notes in Computer Science*, pages 148–164. Springer, May 2008.
- [oEE09] IEEE (Institute of Electrical and Electronics Engineers). Ieee standard for systemverilog - unified hardware design, specification, and verification language. *IEEE Std 1800-2009*, December 2009. <http://standards.ieee.org/findstds/standard/1850-2010.html>.
- [oEE10] IEEE (Institute of Electrical and Electronics Engineers). Ieee standard for property specification language (psl). *IEEE Std 1850-2010*, pages i –188, 2010. <http://standards.ieee.org/findstds/standard/1850-2010.html>.
- [oEE11] IEEE (Institute of Electrical and Electronics Engineers). Ieee standard for the functional verification language e. *IEEE Std 1647-2011*, 2011. <http://standards.ieee.org/findstds/standard/1647-2011.html>.
- [ORS92] Sam Owre, John M Rushby, and Natarajan Shankar. Pvs: A prototype verification system. In *Automated Deduction-CADE-11*, pages 748–752. Springer, 1992.
- [Par81] David Park. Concurrency and automata on infinite sequences. In Peter Deussen, editor, *Theoretical Computer Science*, 1981.
- [Pau94] Lawrence C Paulson. *Isabelle: A generic theorem prover*, volume 828. Springer, 1994.
- [PD97] Fong Pong and Michel Dubois. Verification Techniques for Cache Coherence Protocols. *ACM Computing Surveys*, 29(1):82–126, March 1997.
- [PG11] ARM Peter Greenhalgh. Big. little processing with arm cortexTM-a15 & cortex-a7, 2011.
- [Pie14] Laurence Pierre. Outils de démonstration automatique et preuve de circuits électroniques. *Forum Méthodes Formelles: Preuve de modèle, Preuve de programme*, 2014.
- [PNAD95] Fong Pong, Andreas Nowatzky, Gunes Aybay, and Michel Dubois. Verifying Distributed Directory-based Cache Coherence Protocols: S3.mp, a Case Study. In Seif Haridi, Khayri A. M. Ali, and Peter Magnusson, editors, *Proceedings*

Bibliography

- of the 1st International Conference on Parallel Processing EURO-PAR'95 (Stockholm, Sweden)*, volume 966 of *Lecture Notes in Computer Science*, pages 287–300. Springer, August 1995.
- [Pnu77] Amir Pnueli. The temporal logic of programs. In *Foundations of Computer Science, 1977., 18th Annual Symposium on*, pages 46–57. IEEE, 1977.
- [Pra08] Dhiraj K Pradhan. Application of galois fields to logic synthesis. In *Industrial and Information Systems, 2008. ICIIS 2008. IEEE Region 10 and the Third international Conference on*, pages 1–1. IEEE, 2008.
- [QM11] Xiaoke Qin and Prabhat Mishra. Efficient directed test generation for validation of multicore architectures. In *Proceedings of 12th Int'l Symposium on Quality Electronic Design*, pages 276–283. IEEE, 2011.
- [RMK03] Abhik Roychoudhury, Tulika Mitra, and SR Karri. Using formal techniques to debug the amba system-on-chip bus protocol. In *Design, Automation and Test in Europe Conference and Exhibition, 2003*, pages 828–833. IEEE, 2003.
- [SD95] Ulrich Stern and David L. Dill. Automatic Verification of the SCI Cache Coherence Protocol. In *Correct Hardware Design and Verification Methods*, volume 987 of *Lecture Notes in Computer Science*, pages 21–34. Springer, 1995.
- [SDSH11] Anna Slobodová, Jared Davis, Sol Swords, and Warren Hunt, Jr. A Flexible Formal Verification Framework for Industrial Scale Verification. In *Proceedings of the 9th IEEE/ACM International Conference on Formal Methods and Models for Codesign MEMOCODE 2011 (Cambridge, UK)*, pages 89–97. IEEE Computer Science Press, July 2011.
- [SLM⁺92] Bart Selman, Hector J Levesque, David G Mitchell, et al. A new method for solving hard satisfiability problems. In *AAAI*, volume 92, pages 440–446, 1992.
- [SSTV07] Gwen Salaun, Wendelin Serwe, Yvain Thonnart, and Pascal Vivet. Formal verification of chp specifications with cadp illustration on an asynchronous network-on-chip. In *Asynchronous Circuits and Systems, 2007. ASYNC 2007. 13th IEEE International Symposium on*, pages 73–82. IEEE, 2007.
- [Ste11] Ashley Stevens. *Introduction to AMBA 4 ACE*. ARM whitepaper, June 2011.
- [Sut06] Stuart Sutherland. Modeling with systemverilog in a synopsys synthesis design flow using leda, vcs, design compiler and formality. *SNUG Europe*, 2006.

-
- [Swa06] Stuart Swan. Systemc transaction level models and rtl verification. In *Proceedings of the 43rd annual Design Automation Conference*, pages 90–92. ACM, 2006.
- [SWC⁺08] Haihua Shen, Wenli Wei, Yunji Chen, Bowen Chen, and Qi Guo. Coverage directed test generation: Godson experience. In *Asian Test Symposium, 2008. ATS'08. 17th*, pages 321–326. IEEE, 2008.
- [Tho12] Chris Thompson. *Verifying Cache Coherency Protocols with Verification IP*. Synopsis, October 2012.
- [Tre92] Gerrit Jan Tretmans. *A formal approach to conformance testing*. Twente University Press, 1992.
- [Tre96] Jan Tretmans. Test generation with inputs, outputs and repetitive quiescence. *Software—Concepts and Tools*, (TR-CTIT-96-26), 1996.
- [Tre99] Jan Tretmans. Testing concurrent systems: A formal approach. In *CONCUR'99 Concurrency Theory*, pages 46–65. Springer, 1999.
- [VGS12] Yakir Vizel, Orna Grumberg, and Sharon Shoham. Lazy abstraction and sat-based reachability in hardware model checking. In *Formal Methods in Computer-Aided Design (FMCAD), 2012*, pages 173–181. IEEE, 2012.
- [vGW89] Robert Jan van Glabbeek and Willem Pieter Weijland. *Refinement in branching time semantics*. Centrum voor Wiskunde en Informatica, Computer science, 1989.
- [VGW96] Rob J Van Glabbeek and W Peter Weijland. Branching time and abstraction in bisimulation semantics. *Journal of the ACM (JACM)*, 43(3):555–600, 1996.
- [WAW09] Martin Weiglhofer, Bernhard K Aichernig, and Franz Wotawa. Fault-based conformance testing in practice. *Int. J. Software and Informatics*, 3(2-3):375–411, 2009.
- [WCB⁺03] Pierre Wodey, Geoffrey Camarroque, Fabrice Baray, Richard Hersemeule, and Jean-Philippe Cousin. Lotos code generation for model checking of stbus based soc: The stbus interconnect. In Rajesh K. Gupta, Sandeep Shukla, and Jean-Pierre Talpin, editors, *Proceedings of the 1st ACM and IEEE International Conference on Formal Methods and Models for Codesign MEMOCODE'03 (Mont Saint-Michel, France)*, 2003.
- [YPAA03] J. Yuan, C. Pixley, A. Aziz, and K. Albin. A framework for constrained functional verification. In *International Conference on Computer Aided Design*, pages 142–145. IEEE, November 2003.

Bibliography

- [ZSW⁺14] Zhen Zhang, Wendelin Serwe, Jian Wu, Tomohiro Yoneda, Hao Zheng, and Chris Myers. Formal analysis of a fault-tolerant routing algorithm for a network-on-chip. In Frédéric Lang and Francesco Flammini, editors, *Proceedings of the 18th International Workshop on Formal Methods for Industrial Critical Systems FMICS'2014 (Florence, Italy)*, volume 8718 of *Lecture Notes in Computer Science*, pages 48–62. Springer, September 2014.

Glossary

ABV Assertion-based verification

ACE AXI Coherency Extensions

ASIC Application Specific Integrated Circuit

AMBA Advanced Microcontroller Bus Architecture

AXI Advanced eXtensible Interface

BCG Binary Coded Graphs

BDD Binary Decision Diagrams

BFM Bus Functional Model

CADP Construction and Analysis of Distributed Processes

CCI Cache Coherent Interconnect

CC-NUMA Cache-Coherent - Non Uniform Memory Access computer memory design

CDTG Coverage-Directed Test Generation

CDV Coverage Driven Verification

CHP Communicating Hardware Processes

CIC Computation of Interesting Configurations

CONVECS Construction of Verified Concurrent Systems (Inria research team)

CPU Central Processing Unit

CTG Complete Test Graph

CTL Computation Tree Logic

CTMC Continuous-Time Markov Chains

Appendix A. Glossary

DUT Design Under Test

DUV Design Under Verification

GPU Graphical Processing Unit

FPGA Field-Programmable Gate Array

IMC Interactive Markov Chains

IOTS Input Output Transition System

IPC Interactive Probabilistic Chains

IVK Interconnect Verification Kit

IV unit Interface Verification unit

IP Intellectual Property, refer in SoC context for component designs from a licensor like ARM

LNT LOTOS New Technology

LOTOS Language Of Temporal Ordering Specification

LTL Linear Temporal Logic

LTS Labeled Transition System

MBT Model-Based Testing

MCL Model Checking Language

MDV Metric Driven Verification

NoC Network on Chip

OCIS Open/Caesar Interactive Simulator

PSL Property Specification Language

ROBDD Reduced Ordered Binary Decision Diagram

RTL Register Transfer Level

SoC System on Chip

SUT System Under Test

SUV System Under Verification

SVA SystemVerilog Assertions

SVL Script Verification Language

SV unit System Verification unit

TGV Test Generation from transitions systems using Verification techniques

TLM Transaction-Level Modeling

VASY VALidation of SYstems (Inria research team)

VHDL VHSIC Hardware Description Language

VIP Verification Intellectual Property