



HAL
open science

Multicast Communications for Cooperative Vehicular Systems

Ines Ben Jemaa

► **To cite this version:**

Ines Ben Jemaa. Multicast Communications for Cooperative Vehicular Systems. Networking and Internet Architecture [cs.NI]. Mines ParisTech, 2014. English. NNT : 432 . tel-01101679

HAL Id: tel-01101679

<https://inria.hal.science/tel-01101679>

Submitted on 9 Jan 2015

HAL is a multi-disciplinary open access archive for the deposit and dissemination of scientific research documents, whether they are published or not. The documents may come from teaching and research institutions in France or abroad, or from public or private research centers.

L'archive ouverte pluridisciplinaire **HAL**, est destinée au dépôt et à la diffusion de documents scientifiques de niveau recherche, publiés ou non, émanant des établissements d'enseignement et de recherche français ou étrangers, des laboratoires publics ou privés.

École doctorale n°432 :
Sciences des Métiers de l'Ingénieur

Doctorat européen ParisTech

T H È S E

pour obtenir le grade de docteur délivré par

l'École nationale supérieure des mines de Paris

Spécialité « Informatique temps-réel, robotique et automatique »

présentée et soutenue publiquement par

Inès BEN JEMAA

le 17 Décembre 2014

**Communications Multicast Pour les systèmes véhiculaires
coopératifs**

Multicast Communications for Cooperative Vehicular Systems

Directeur de thèse : **Arnaud DE LA FORTELLE**
Co-encadrement de la thèse : **Oyunchimeg SHAGDAR**
Paul MUHLETHALER

Jury

Sidi-Mohamed SENOUCI, Professeur, Université de Bourgogne
Nadjib ACHIR, Maître de Conférence, Université Paris 13
Nadjib AIT SAADI, Maître de Conférence, Université Paris-Est Creteil Val de Marne
Arnaud DE LA FORTELLE, Professeur, MINES ParisTech
Oyunchimeg SHAGDAR, Docteur, INRIA Rocquencourt
Paul MULHLETHALER, Directeur de Recherche, INRIA Rocquencourt

Rapporteur
Rapporteur
Examineur
Examineur
Examineur
Examineur

**T
H
È
S
E**

Abstract

With the advancement of wireless communications technologies, users can now have multicast services while they are driving. In addition to the traditional multicast applications, developments in vehicular communications allow new multicast emerging applications such as fleet management and point of interest (POI). Fleet management, including route guidance of a fleet of vehicles, often requires a control/service center, which resides in the Internet, to communicate and provide information to fleets of vehicles. Point of Interest refers to a specific point location (e.g., parking lots, restaurants, or other local facilities) that may be of interest or use to road users in the area. Both of these mentioned applications require Internet-to-vehicle multicasting. Conventional group management approaches in Internet is relatively simple because it is performed on the local networks of the multicast members which are usually a priori configured to receive the service. In addition to this, multicast packets flows follow a routing structure (usually a tree structure) that is built between the source and the destinations. These approaches could not be applied to vehicular networks (VANET) due to their dynamic and distributed nature. In order to enable such multicasting, our work deals with two aspects. First, reachability of the moving vehicles to the multicast service and second, multicast message dissemination in the VANET. Regarding the first issue, we find that neither current multicast addressing nor existing mobility management mechanisms are suitable for VANET. This is because not only they do not fit to applications that have a geographic scope but also they do not allow spontaneous joining and they may create routing problems. We introduce first a self-configuring multicast addressing scheme that allows the vehicles to auto-configure a dynamic multicast address without a need to exchange signalling messages with the Internet. Second, we propose a simplified approach that extends Mobile IP and Proxy Mobile IP. This approach aims at optimizing message exchange between vehicles and entities responsible for managing their mobility in Internet. To study the dissemination mechanisms that are suitable for fleet management applications, we propose to revisit traditional multicast routing techniques that rely on a tree structure. For this purpose, we study their application to vehicular networks. In particular, as vehicular networks are known to have changing topology, we present a theoretical study of the link lifetime between vehicles in urban environments. Then, using simulations, we study the application of Multicast Adhoc On Demand Vector, MAODV. We propose then Motion-MAODV, an improved version of MAODV that aims at enhancing routes built by MAODV in vehicular networks and guarantee longer route lifetime. Finally, to enable geographic dissemination as required by POI applications, we propose a routing protocol Melody that provides a geocast dissemination in urban environments. Through simulations, Melody ensures more reliable and efficient packet delivery to a given geographic area compared to traditional geo-broadcasting schemes in highly dense scenarios.

Résumé

Avec l'évolution des technologies de communication sans fil, les usagers de la route peuvent aujourd'hui bénéficier des services multicast. Outre les applications traditionnelles de multicast, la communication véhiculaire permet le développement de nouvelles applications multicast émergentes telles que la gestion de la flotte et la distribution des Points d'Intérêt. Les applications de gestion de flottes de véhicules permettent leur guidage et leur suivi. Elles nécessitent souvent un centre de contrôle localisé dans Internet, qui est responsable de leur communication et de leur fourniture d'informations de gestion. Les applications de Point d'Intérêt (POI) distribuent les informations spécifiques à un emplacement d'un point d'intérêt utilisateur (par exemple, les parcs de stationnement, les restaurants, etc.). Ces informations sont utiles pour les usagers de la route qui se trouvent à proximité du point d'intérêt. Les deux catégories d'applications déjà citées nécessitent une communication multicast de l'Internet vers les réseaux véhiculaires (VANET). En effet, la gestion des groupes multicast dans Internet est simplifiée car elle est réalisée au niveau des réseaux locaux des membres multicast qui sont dans la majorité des cas à priori configurés pour recevoir le service. De plus, les paquets multicast suivent une structure de routage fixe (souvent en arbre) établie entre la source et les destinataires. Ces approches ne peuvent être appliquées aux réseaux véhiculaires en raison de leur nature dynamique et distribuée. Afin de mettre en place une communication multicast adaptée au contexte de la communication Internet-vers-réseaux véhiculaires, notre travail traite de deux aspects différents. Tout d'abord, l'accessibilité des véhicules en mouvement au service Internet et en deuxième lieu, la dissémination du message dans les VANET. Concernant le premier problème, nous constatons que le système d'adressage multicast actuel ainsi que le mécanisme de gestion de la mobilité ne sont pas adaptés aux VANET. Ceci car non seulement ils ne sont pas adaptés aux applications dont la destination est géographique mais aussi ne permettent pas une jointure de groupe spontanée et peuvent créer des problèmes de routage. Nous introduisons alors un schéma d'adressage multicast basé sur les coordonnées géographiques des véhicules qui leur permet de s'auto-configurer d'une façon dynamique sans aucun besoin d'échanger des messages de signalisation avec Internet. Nous proposons aussi une approche simplifiée de gestion de la mobilité des véhicules dans le cadre des architectures Mobile IP et Proxy Mobile IP. Le but de cette approche est d'optimiser l'échange des messages avec les entités responsables de la gestion de la mobilité dans Internet en mettant en place un mécanisme de gestion de groupe local au réseau véhiculaire. Afin d'étudier les mécanismes de dissémination appropriés aux applications de gestion de flottes, nous nous proposons de revisiter les techniques de routage multicast traditionnelles basées sur une structure de diffusion en arbre. Pour cela, nous étudions leur application aux réseaux véhiculaires. En particulier, comme les réseaux véhiculaires sont connus pour avoir une topologie dynamique, nous présentons une étude théorique portant sur la durée de vie des liens entre les véhicules en milieu urbain. Ensuite, en utilisant la simulation, nous étudions l'application de

Multicast Adhoc On Demand Vector, MAODV et proposons Motion-MAODV, une version adaptée de MAODV qui a pour objectif d'établir des routes plus robustes et qui ont une durée de vie plus longue que celles établies par MAODV. Enfin, concernant la dissémination multicast géolocalisée dans les applications POI, nous proposons le protocole de routage Melody qui permet une diffusion geocast en milieu urbain. A partir de simulations, nous constatons que, comparé aux protocoles de géo-broadcasting dans les milieux urbain très denses, Melody assure plus de fiabilité et d'efficacité lors de l'acheminement des données vers les zones géographiques de destination.

Table des matières

Abstract	2
Résumé	2
List of Figures	9
List of Tables	11
Abbreviations	12
1 Introduction	1
1.1 Context of the work	3
1.2 Thesis Statement	4
1.3 Contributions of the thesis	5
A Dynamic Geographical Addressing Scheme for Multicast Vehicles	5
Study of Multicast Mobility Management Issues for Mobile Vehicles	5
Motion-MAODV : An enhanced MAODV protocol for Ve- hicular Networks	5
Melody : Opportunistic Geocast Routing for Vehicular Net- works	6
Implementations and evaluation	6
1.4 Organization of the dissertation	6
2 Context & Background	9
2.1 Introduction	9
2.2 Intelligent Transportation Systems : Communication Architecture	9
2.2.1 The ETSI ITS Reference Architecture	10
2.2.2 Related Research Projects in ITS Communications	10
2.3 Vehicular Scenarios	11
2.3.1 Available Access technologies	11
2.3.2 Vehicular Networks	13
Mobility Modelling and Predication	13
Novel Technologies	13
Operating Environments	14
Application Requirements	14

	Sufficient energy, processing capabilities and storage	14
2.4	ITS and Vehicular Applications	14
2.5	Multicast Applications in ITS	15
2.5.1	Geo-independent Multicast	15
2.5.2	Geo-dependent Multicast	16
2.5.3	Multicast applications classification	17
2.6	Multicast in the Internet	18
2.7	Review of Multicast Routing Approaches in Vehicular Networks	19
2.7.1	Review of Unicast Routing in VANET	20
2.7.2	Review of Broadcast Routing in VANET	21
2.7.3	Review of Multicast Routing in VANET	22
2.8	Review of Geocast Routing Approaches in Vehicular Networks	23
2.8.1	Mac-Based Geocast	23
2.8.2	Spatiotemporary Geocast	24
2.8.3	Opportunistic Geocast	24
2.8.4	Comparison of Geocast protocols	25
2.9	Conclusion	25
3	Multicast For Hybrid Scenarios	28
3.1	Introduction	28
3.2	Preliminaries	28
3.3	Multicast Addressing for Mobile Multicast Members	29
3.3.1	Problem Statement	29
3.3.2	Related Work	30
3.3.3	Design Requirements	31
3.3.4	GMAA : Geographic Multicast Address Auto-configuration	32
3.3.5	Framework Integration	34
3.4	Mobility Management of Internet-to-VANET Multicasting	36
3.4.1	Background and Related Work	36
3.4.1.1	Multicast Mobility Management in Mobile IP	36
3.4.1.2	Multicast Mobility Management in Proxy Mobile IP	37
3.4.2	Approach Comparison	39
3.5	Extended Multicast Mobility Management for VANET	39
3.5.1	Multicast Membership Management	39
3.5.2	Internet-to-VANET Multicast Dissemination	41
3.6	Conclusion	43
4	Mobility-Aware Multicast Routing Protocol	45
4.1	Introduction	45
4.2	The Link Lifetime Problem in Vehicular Networks	45
4.2.1	Route Lifetime Analytical Model	47
4.2.2	Simulation of the Impact of Traffic Dynamics on Neighbor Link Stability	49
4.2.2.1	Methodology and Link Stability Metrics	49
4.2.2.2	Simulation Results and Analysis	50
	Simulation Settings	50
	Simulation Results	51

4.3	Multicast Routing in Vehicular Networks	54
4.3.1	Background	54
4.3.2	Tree-based Multicast Routing	55
4.3.3	Multicast Ad hoc On-Demand Distance Vector	56
4.3.4	Motion-MAODV : A Tradeoff Between Routing Complexity and Delivery Efficiency in Vehicular Networks	58
4.3.4.1	Discussion : MAODV performance in VANET Scenarios	58
	Route Reliability Problems	58
	Route Maintenance Problems	58
4.3.4.2	Description of Motion-MAODV	59
4.4	Simulations and Results	61
4.4.1	Simulation Settings	61
4.4.2	Comparison of MAODV, Motion-MAODV and Flooding	62
4.4.3	Evaluation of the Joining Success Rate	64
4.4.4	Evaluation of the link lifetime on the tree	64
4.5	Conclusion	65
5	Toward a Reliable Geocast Delivery in Urban Vehicular Networks	67
5.1	Introduction	67
5.2	Preliminaries	67
5.2.1	Scenario Overview	67
5.2.2	Problem Statement	68
5.3	Melody Description	69
5.3.1	Neighbor Discovery	69
5.3.2	Relaying Phase	70
5.3.3	Dissemination Phase	71
5.4	Performance evaluation	72
5.4.1	Simulation Settings	72
5.4.2	Simulation Results	73
5.4.2.1	Packet Delivery Ratio	73
5.4.2.2	Packet End-to-End Delay	75
5.4.2.3	Packet Retransmission	76
5.4.2.4	Performance Evaluation per Sub-zone	76
5.5	Conclusion	78
6	Conclusion	79
6.1	Conclusion	79
6.2	Future Work	80
	Bibliographie	82
	List Of Publications	89

Table des figures

1.1	V2V and V2I communications in vehicular networks	3
1.2	Examples of Car sharing systems	4
2.1	The ETSI ITS reference Architecture	11
2.2	V2V and V2I communications in vehicular networks	11
2.3	POI Applications	16
2.4	Applications Taxonomy	17
2.5	The multicast distribution tree in Internet	18
2.6	Multicasting Techniques	19
2.7	Zone Of Relevance and Zone Of Forwarding in geocast Type of dissemination	23
3.1	Multicast in hybrid scenario	29
3.2	Geographic area partitioning	32
3.3	The GMAA operations	33
3.4	Hash Function and area fetching operation in the server side	34
3.5	Framework Integration in the ITS Architecture	35
3.6	Mobility Management in Mobile IPv6	38
3.7	Mobility Management in Proxy Mobile IPv6	39
3.8	Multicast group management in vehicular networks	41
3.9	Extended mobility management for Internet-to-VANET dissemination in MIPv6	42
3.10	Extended mobility management for Internet-to-VANET dissemination in PMIPv6	42
4.1	Link disconnections effects on the unicast data transmission	46
4.2	Link disconnection effects on multicast data transmission	47
4.3	Intersection scenario	50
4.4	Variation of the maximum neighborhood lifetime with the road density .	51
4.5	Average number of neighbors	52
4.6	Neighbors' relative direction w.r.t the ego vehicle.	52
4.7	Neighbors' relative velocity w.r.t the ego vehicle	52
4.8	The tree topology in multicast routing	56
4.9	Maodv Operations	57
4.10	Motion-MAODV Routing table	60
4.11	Join RREP Reception process in MaodvMotion	60
4.12	Simulation scenario.	61
4.13	Average Packet Delivery Ration of MAODV, Motion-MAODV and Flooding	62
4.14	Average Delay and throughput of MAODV, Motion-MAODV and Flooding	63

4.15	Average Successful Join Rate of MAODV and Motion-MAODV	64
4.16	Number of Established and broken links in the tree during the simulation	65
4.17	Average number of nodes on the tree in MAODV and Motion-MAODV . .	65
5.1	Background	68
5.2	Melody Hello packet	70
5.3	Urban geographic dissemination Scenario	71
5.4	Melody Overlay view	71
5.5	Melody relaying phase	72
5.6	Melody simulation scenario	72
5.7	Packet Delivery Ratio of Melody compared to geographic Flooding	74
5.8	Packet Delivery Ratio of geographic Flooding per multicast receivers' rate	74
5.9	Packet Delivery Ratio of Melody using Multicast relay path	75
5.10	Packet Delivery Ratio of Melody using Unicast relay path	75
5.11	End-to-End Delay of Melody compared to Flooding	75
5.12	Number of packet transmissions	76
5.13	Number of packet transmissions per Meter	76
5.14	Partitioning of destination area into sub-zones	76
5.15	Number of hops relaying the message to the destinations for $\lambda = \frac{1}{10}$	77
5.16	Number of hops relaying the message to the destinations for $\lambda = \frac{1}{15}$	77
5.17	Packet Delivery Ratio per sub-zone for $\lambda = \frac{1}{10}$	77
5.18	Packet Delivery Ratio per sub-zone for $\lambda = \frac{1}{15}$	77

Liste des tableaux

2.1	Survey of the main ITS projects	12
2.2	Available Technologies for ITS communications	13
2.3	Comparison of geocast protocols	25
3.1	Comparative study of the multicast mobility management approaches . .	40
4.1	Simulation settings	62
4.2	MAODV/Motion-MAODV settings	62
5.1	Simulation settings	73

Abbreviations

ITS	I ntelligent T ransportation S ystems
VANET	V ehicular A dhoc N etworks
MANET	M obile A dhoc N etworks
POI	P oint O f I nterest
V2V	V ehicle T o V ehicle
V2I	V ehicle T o I nternet
IP	I nternet P rotocol
IPv6	I nternet P rotocol v ersion 6
MIPv6	M obile I P v ersion 6
PMIPv6	P roxy M obile I P v ersion 6
PMIPv6	P roxy M obile I P v ersion 6
AODV	A dhoc O n D emand D istance V ector
MAODV	M ulticast A dhoc O n D emand D istance V ector
ETSI	E uropean T elecommunications S tandards I nstitute
DSRC	D edicated S hort R ange C ommunications V ector
IR	I nfra R ed
GPS	G lobal P ositioning S ystem
QoS	Q uality o f S ervice
PIM	P rotocol I ndependent M ulticast
MLD	M ulticast L istener D iscovery
RP	R endez-vous P oint
DTN	D elay T olerent N etworks
ZOF	Z one O f F orwarding
ZOR	Z one O f R elevance
GMAA	G eographic M ulticast A ddress A uto-configuration

HA	H ome A gent
MN	M obile N ode
LMA	L ocal M obility A nchor
MAG	M obile A ccess G ateway
MLQ	M obility L istener Q uery
MLR	M ulticast L istener R eport
CDF	C umulative D istribution F unctiopn
PDF	P robability D istribution F unction
MAC	M edia A ccess C ontrol

Chapitre 1

Introduction

Intelligent Transportation Systems (ITS) refer to the future transportation systems, where several entities, including vehicles and road-side infrastructure, cooperate for safe, efficient, and comfortable transportation. Communications technologies are expected to play an important role towards building ITS by enabling vehicles, road-side infrastructure, and centralized entities to exchange information for safety, efficiency, and user-oriented applications.

Safety applications are related to any hazardous event that may occur on the road and which may cause road accidents. For instance, in France 56 812 accidents are reported in 2013 [12]. The aim of safety applications is to predict and avoid accidents. This can be done by alerting drivers in advance about hazardous events, thus, enabling drivers or vehicles to take the right decision, for example by reducing their speed.

Applications for Road efficiency aim at improving traffic flows on the road by avoiding road congestion and increasing traffic fluidity. Traffic congestion has a considerable socio-economic impact : it results in increased fuel consumption, increased CO₂ transmission and the journey time of road users. Road efficiency services will be deployed to monitor, control and regulate the traffic on the road. This will be done, for instance, by collecting real time information about the road traffic status and redistributing it on a city-wide scale. This will result in smoother traffic flow, reduced energy consumption and less road-user frustration.

User services are seen more as a "Customer-centric" services. They are also known as infotainment services in which road users are provided with information, advertisements and entertainment. Information gathering contains the usual Internet services

such as e-mailing, Web surfing, etc. Advertisements are lucrative and non-lucrative announcement services providing real time information to the occupants of vehicles regarding nearby restaurants, hotels or parking facilities. The entertainment category can be classified as peer-to-peer services. It includes distributed gaming, content downloading, chatting and etc., as cited by [51].

As part of their specificity, ITS services often target multiple destinations. For instance, alerting drivers about an accident on the road requires transmitting the message to all endangered vehicles in the surrounding area. In such situations, where hard constraints on delays have to be respected, it is very common to use broadcasting techniques in vehicular networks. On the other hand, sending information from a management server on the Internet to a fleet of buses about traffic flow, as in a fleet management application, requires a multicast dissemination from the Internet to the group of buses. In addition to this, announcing empty parking lots in a specific area like in "Point Of Interest" (POI) also requires using a local geographic multicast dissemination scheme. Besides the challenges of low delay and high delivery reliability, multicasting imposes challenges on identifying and managing the group of vehicles that should receive the message. When the data flows are sent from a fixed infrastructure (i.e, the Internet) to vehicular networks, multicast dissemination is even more challenging. Indeed, vehicles must be able to receive the service even if they change their means to access to the Internet. In addition to this, characteristics of highly dynamic vehicular networks are very different compared to the Internet, making it hard to apply the conventional multicast dissemination mechanisms to vehicular networks or Internet-and-vehicular networks.

This work pay specific attention to multicasting as it is the one-to-many dissemination type on which many vehicular communication services are based. Multicast technology was first introduced by Stephen Deering [23] in 1988. It was initially designed for nodes that reside on the Internet. Then, quickly, the concept of multicasting was extended to allow the development of new applications and new protocols over mobile wireless networks. In the multicast scheme, a node referred to as a source sends data to a group of receivers without knowing them a priori. The receivers join a specific address called a multicast address. Multicast delivery is achieved by sending only one copy of the message which follows a specific path to the multicast receivers.

Using multicasting for vehicular networks has many benefits :

- First, organizing vehicles as a group reduces the complexity of managing several individual entities by setting up a unified mechanism for the group. Hence, the system is more flexible to accept new joining members.
- Second, it presents a solution to the problems of resource limitations in vehicular networks. Compared to mechanisms that use broadcast or multiple destinations

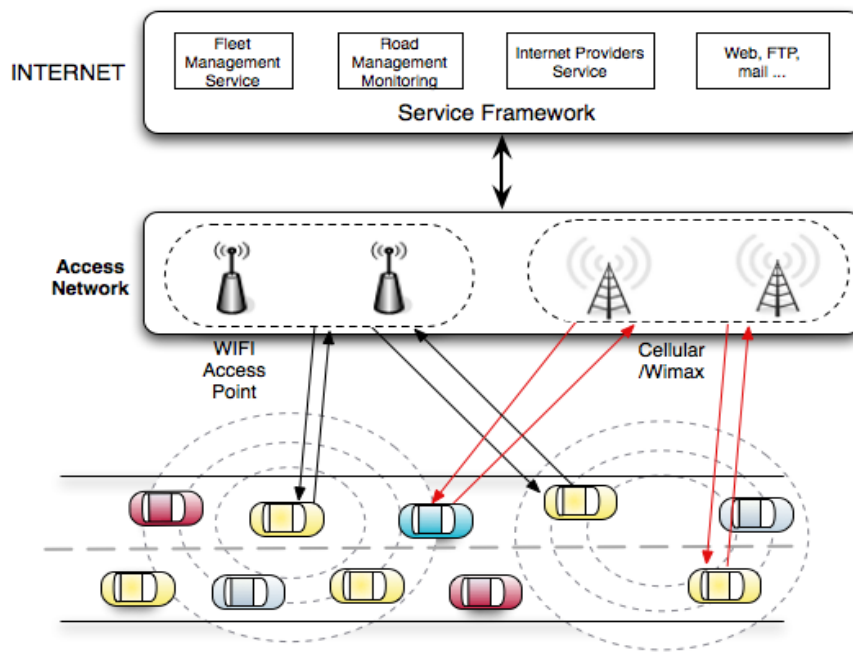

FIGURE 1.1: V2V and V2I communications in vehicular networks

unicast, multicast optimizes the use of the channel by sending only one copy of the message

1.1 Context of the work

”Smart vehicles for smart driving” [76] is an emerging concept that offers road user further enhanced facilities. Automated driving is a promising technology that fits in well with this concept. It provides greater safety, reduces the environmental impact and optimizes the traffic flows [43]. For instance, the AutoNet2030 project [Aut] aims to develop cooperative automated driving technology for a network of automated vehicles between 2020 and 2030. Achieving the deployment of automated vehicle systems requires efforts from multiple research fields, in particular control, sensing, perception and communications technologies. It is in this context that the RITS team is working on this context to contribute to the development of automated car systems. Its main focus is on improving the control, the perception and the automation capabilities of intelligent vehicles and providing a reliable communications system. RITS is also contributing to several national and European projects such as Mobility 2.0, HaveIt, ScoreF, and etc. It is also developing novel applications with respect to the identified use cases for automated driving.

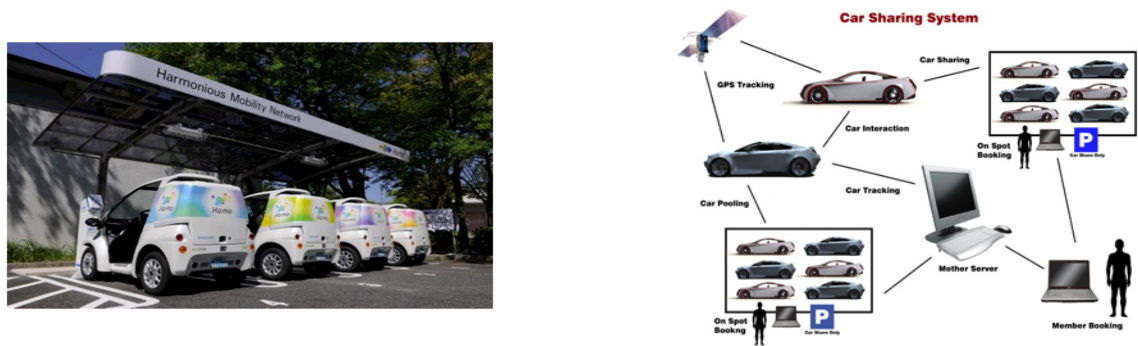

FIGURE 1.2: Examples of Car sharing systems

One of the attractive services on which RITS is working is *Car Sharing service*. Car Sharing is a service that is based on a fleet of automated vehicles. In this application, a user requests a vehicle at a given geographic location (e.g., a station) triggering the car sharing system to allocate an autonomous vehicle to transport the user from the station to the user's desired destination. Consequently, the application requires efficient cooperation between the autonomous vehicles and the management center for a reliable and responsive service. To monitor the fleet of vehicles, the server continuously sends multicast messages to the fleet of cars. On the other hand, the request sent from the station to the fleet of vehicles is usually multicast on the geographic surrounding area (e.g, a circular geographic area of a 500 meters radius from the station).

Figure 1.2 illustrates the operations of a Car Sharing system (on the right) and the fleet of the automated cars of Toyota (on the left).

Our communications work for ITS research axis of RITS basically aims at studying multicast services from a routing point of view. It focuses on Multicast for both Internet-to-Vehicle and Vehicle-to-Vehicle networks. Our intention is to integrate our protocols in the platform of the team. As a first step, we rely on simulations using the NS3 [NS3] network simulator.

1.2 Thesis Statement

This dissertation considers the problems of Internet-to-VANET multicast communications. To enable such multicasting, our work is intended to meet three objectives.

1. Ensure the reachability of vehicles that are multicast members to the Internet services through an efficient multicast addressing system and an enhanced multicast mobility management than conventional schemes

2. Revisit the conventional structure-based multicast routing in mobile networks and investigate their application to vehicular networks through the MAODV routing protocol for the fleet management type of applications.
3. Propose a geocast routing protocol that copes with the problems of geo-broadcasting especially in urban dense scenarios to enable the Point Of Interest type of applications.

1.3 Contributions of the thesis

A Dynamic Geographical Addressing Scheme for Multicast Vehicles Many ITS applications such as fleet management require multicast data delivery. Existing work on this subject mainly tackles the problems of the IP multicasting inside the Internet or geocasting in VANETs. We present a new framework that enables Internet-based multicast services on top of VANETs. We introduce a self-configuring multicast addressing scheme based on the geographic locations of vehicles coupled with a simplified approach that locally manages the group membership to allow packet delivery from the Internet.

Study of Multicast Mobility Management Issues for Mobile Vehicles Reachability of the mobile multicast receivers by Internet services is still an open challenge. New technologies such as Mobile IPv6 (MIP) and Proxy Mobile IPv6 (PMIP) are designed to manage the mobility of users in the Internet. In this work, we propose two approaches that are adapted to the mobility of the multicast members in the vehicular networks. The first approach extends the network mobility management of MIPv6 to fit multicasting in fleet management services. The second extends the mobility management mechanism of PMIPv6 for POI type of services.

Motion-MAODV : An enhanced MAODV protocol for Vehicular Networks

MAODV is a typical multicast routing protocol for wireless networks that builds a multicast tree to route the packets from the source to the multicast receivers. In order to investigate the performance of structure-based multicast in vehicular environments, we first investigate the ability of structure-based routing protocol to keep a path for a long duration. we compared MAODV to structure-less protocols as Flooding, which uses multi-hop broadcasting. We proposed Motion-MAODV that uses the velocity as a criteria to guarantee a long duration routing path. The new protocol, Motion-MAODV, outperforms MAODV and Flooding.

Melody : Opportunistic Geocast Routing for Vehicular Networks Opportunistic Routing is a solution that can be applied in vehicular networks. Opportunistic routing suffers from problems of congested scenarios where vehicle density is high. Melody overcomes this problems by providing an efficient geographic dissemination mechanism. Melody builds an overlay-like topology to disseminate the messages to the multicast receivers. Simulations show that it outperforms Flooding in highly dense scenarios.

Implementations and evaluation To evaluate our proposals, a significant amount of code was written during the work of this Phd. This includes the implementation of MAODV support in NS3, the implementation of our proposals Motion-MAODV and Melody. We also implemented also the Flooding and the geographical fFlooding to compare them with our proposals. The code that we developed will soon be released on the Internet to the community. In order to make our multicast node configuration more flexible, we also developed the tracing framework of SUMO by adding newer features which fits to the performance evaluation.

To summarize, our work primarily focuses on multicasting for Internet-to vehicle and the Vehicle-to-Vehicle communications. For Internet-to-Vehicle communications, we studied the reachability of the multicast receivers through the Internet. We mainly focused on the problems of multicast mobility management and address auto-configuration. For Vehicle-to-Vehicle communications, we revisited a traditional multicast tree-based protocol MAODV and proposed an improvement to MAODV to tailor it to vehicular networks for fleet management applications. We also proposed Melody, an opportunistic geocast routing protocol for the POI type of applications to overcome the routing performances problems in highly dense scenario.

1.4 Organization of the dissertation

This thesis is organised in three parts. The first part is an Introduction and consists of Chapters 1 and 2. Chapter 1 introduces the work by giving an overview of the context and the main objectives of the work, while Chapter 2 presents the context and the background of our study and reviews the state-of-the art of multicast communications in Internet and in vehicular networks.

The second part concerns the problem of Internet reachability of mobile multicast vehicles. The state-of-the art and our contributions in global multicast addressing and mobility management is set out in Chapter 3.

The third part focuses on multicast dissemination mechanisms in vehicular networks. In Chapter 4 we focus on the problem of link lifetime in vehicular networks and revisit MAODV for vehicular networks. Chapter 5 presents Melody, our proposal for a reliable opportunistic geocast dissemination.

Chapter 6 concludes this Phd work by summarizing our contributions and giving the perspectives of our work.

Résumé du Chapitre 2

Les applications multicast sont d'une grande importance dans les réseaux véhiculaires étant donné le nombre de scénarios qui nécessite une transmission multi-destinations de messages. Particulièrement, dans ce travail de thèse, on s'intéresse aux services multicast véhiculaires déployés dans Internet et dont les destinations sont des véhicules inscrits au service. Étant donné les problèmes et les défis qu'il soulève, ce type de communication exige au préalable une compréhension du contexte et de l'état de l'art des réseaux véhiculaires. Dans ce chapitre, on présente d'abord les architectures de référence dans les ITS ainsi que les différents projets de recherche qui s'intéressent à l'étude et au test des protocoles de communication véhiculaire. On explique ensuite les scénarios et les applications de base de la communication véhiculaires et en particulier les applications nécessitant l'utilisation du multicast. La partie suivante présente d'une façon générale le multicast conventionnel dans Internet. La dernière partie du chapitre se focalise sur l'état de l'art du routage multicast et geocast dans les réseaux véhiculaires.

Chapitre 2

Context & Background

2.1 Introduction

Multicast applications are of great importance in vehicular networks due to the potential use cases they target. Enabling Internet-to-VANET multicasting in particular needs to be studied deeply as it raises a number of relevant issues. This requires understanding the background of vehicular networks and analyzing their state-of-the-art.

In this chapter, we study some of the interesting aspects of research in vehicular networks. In Section 2.2 we present the ITS reference architecture and the latest results of the research projects that focus on studying and testing the communication aspects of the ITS. In Sections 2.3 and 2.4, we outline the main vehicular communication scenarios and the major applications. Section 2.5 then focuses on fleet management and POI applications, which are the applications we are particularly interested in. Section 2.6 reviews multicasting in the Internet while Sections 2.7 and 2.8 respectively present the related work on the different techniques used respectively in multicast and geocast routing in vehicular networks.

2.2 Intelligent Transportation Systems : Communication Architecture

The ITS Standards are fundamental to the establishment of an open ITS environment. Their goal is to ensure interoperability between different technologies, systems and communication protocols to ease their deployment. Especially, many standardization bodies including the SAE (Society of Automotive Engineers) in USA, ARIB (Association for radio industry and business) in Japan or ETSI (European telecommunications

standards Institute) in Europe exist aiming at designing new communication layered architectures which are somehow different from the conventional TCP/IP stack.

2.2.1 The ETSI ITS Reference Architecture

Figure 2.3 shows the ITS reference architecture [11]. The architecture is to be deployed on various types of ITS stations involved in cooperative ITS communications. This ITS station architecture allows all types of communications : Vehicle-to-Vehicle (V2V) and Vehicle-to-Roadside (V2R) and Vehicle-to-Central (V2C). The major novelty of this architecture are that it introduces a new layer called the facilities layer and two horizontal layers ; management and security.

- **The management and security layers** The management layer contains management functionalities that especially provide communications management across the different communications layers for e.g., congestion control. The security layer contains the security related functionalities, including firewall and authentication.
- **The facilities layer** The facilities layer provides the application support, information support, and communication support. Most notably, the facilities provide two types of messages to support traffic safety applications : Cooperative Awareness Message (CAM) and Decentralized Environmental Notification Message (DENM). For instance, *DENM* are alert messages triggered by an application that detects the existence of an event. They carry information about the event type, the location, the time of the detection, the area affected. *CAM* messages are periodic messages transmitted in single hop mode. They carry information about the current state of the sending station (identifier, position, velocity, etc ...). *LDM* which is a dynamic map maintains a dynamic network topology of the area around the station.
- **GeoNetworking** In V2V applications, especially those for traffic safety and efficiency applications, it is often desirable to communicate with vehicles in a specific geographic area. To support such applications, ETSI has specified Geonetworking protocols that provide packet routing (geoUnicast, geoBroadcast, and geoAnycast) in an ad hoc network based on geographical addressing.

2.2.2 Related Research Projects in ITS Communications

Table 2.1 summarizes the ITS European projects in the last fifteen years. The table details the main features taken into consideration in the projects as well as the technologies tested and used in their experimental platforms.

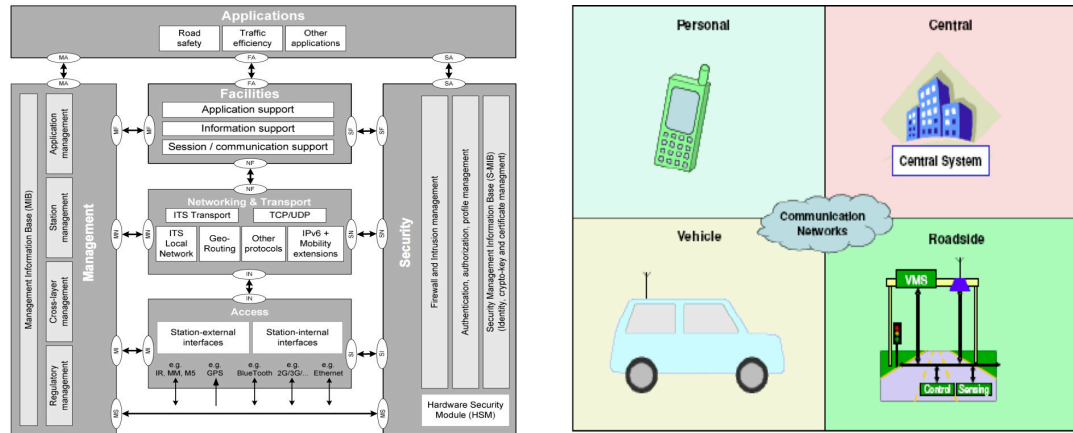

FIGURE 2.1: The ETSI ITS reference Architecture

2.3 Vehicular Scenarios

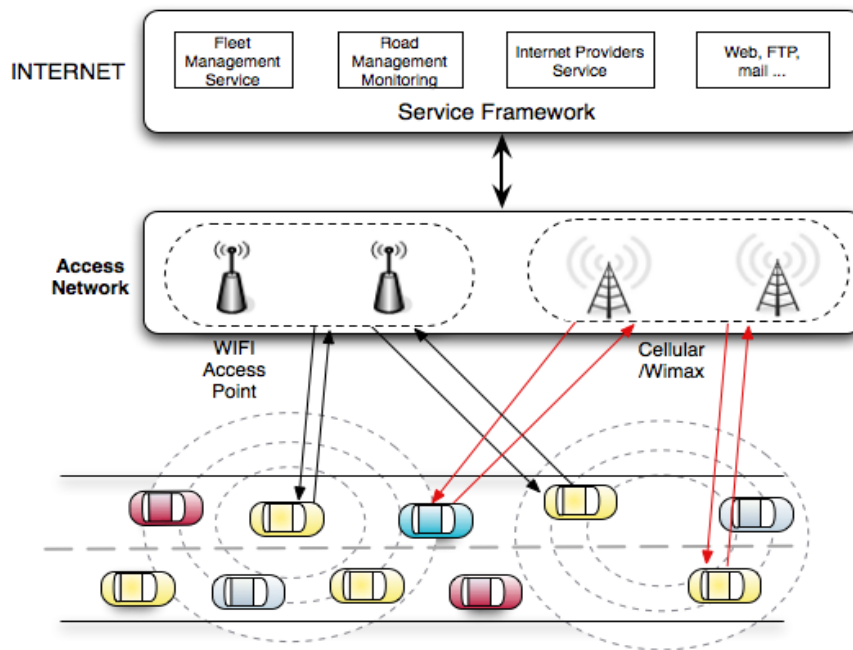

FIGURE 2.2: V2V and V2I communications in vehicular networks

2.3.1 Available Access technologies

Radio access technologies have different properties depending on their frequency band, transmission power, and their digital/analog communications functionalities. Table 2.2 compares the most popular access technologies in terms of their operating frequency band, range, data rate, latency, and transmission mode.

	Scope/Feature	Related Protocols	V2V	V2I
FleetNet [29] (2000-2003)	V2V communication framework Cooperative driving. Position-based forwarding	802.11	✓	✓
CVIS [cvi] (2006-2010)	Seamless V2V and V2I communication between various protocols and standards. Cooperative V2I systems. Uses CALM (Continuous Air Interface for Long and Medium range.	IEEE 802.11, IPv6, Infrared, Millimeter wave, GSM/UMTS. CALM M5 radio communication. CALM FAST	✓	✓
GeoNet [geo] (2007-2009)	Geographic addressing and routing including IPv6 running on top of a C2C-Net routing layer. Geographic alert. IPv6 mobility management	802.11, IPv6, C2CNet	✓	✓
SAFESPOT [saf] (2006-2010)	Ad hoc networking. Relative localization. Real time representation of surrounding vehicles and environment. Information gathered by road side sensors and mobile sensors. Road intersection safety, safe overtaking, head-on collision and vulnerable road warning	IEEE 802.11p, GPS.	✓	✓
COOPER [coo] (2006-2008)	Improvement of traffic management and safety. Collection of traffic information by using vehicles as floating sensors. Building on existing equipment and network on the road infrastructure.	GSM/GPRS/UMTS, Microwave and Infrared	✓	✓
ScoreF [sco] (2010-2013)	Field Operation Test Project. Test of 802.11p technologies. Several applications : Point Of Interest, alert systems, road traffic management	802.11p, 3G, GPS, IPv6	✓	✓
CarTALK 2000 [car] (2001-2004)	Ad hoc V2V communication. Traffic safety, and comfort. Three application clusters (IWF, CBLC, and CODA).	IEEE 802.11	✓	✓

TABLE 2.1: Survey of the main ITS projects

Among the access technologies, CEN DSRC, ITS-G5, and ITS-IR operate over dedicated ITS bandwidth, whereas WPAN (e.g., Zigbee and Bluetooth), WiFi (802.11b/g/n) operate over The Industrial, Scientific and Medical frequency bands. WiMAX, 3/4G cellular communications technologies utilize allocated frequency bands. Considering the operating frequency channel and communication coverage, ITS-G5 is probably the most promising technology for V2V communications. The technology can also be used for communications between vehicles and RSUs. The WiFi can also be used for V2V/V2I communications but because it operates over the ISM band, it may suffer from channel interference. If the vehicles are equipped with a long-range communication device e.g., WiMAX and 3G/4G cellular, the vehicles can have Internet connectivity without using RSUs.

TABLE 2.2: Available Technologies for ITS communications

Technology	Frequency	Range	Transmission mode	Type of communication
CEN DSRC	5.8GHz	3m – 15m	No ad hoc	V2V and V2I
ITS-G5 (802.11p)	5.9GHz	1km	Ad hoc/No ad hoc	V2V and V2I
ITS-IR	800nm-1000nm	10m	Ad hoc/No ad hoc	electronic toll payment
Zigbee/Bluetooth	2.4GHz	10m	Ad hoc/No ad hoc	intra-vehicle
WiFi (802.11b/g/n)	2.4GHz-5GHz	200m	Ad hoc	V2V and V2I
WiMAX (802.16)	2.5GHz-3.5GHz (Europe)	50km (max)	No ad hoc	V2I communications
UMTS / LTE-Adv (3G/4G)	800MHz 900MHz 2000 MHz (Europe)	50km (max)	No ad hoc	Internet connectivity

2.3.2 Vehicular Networks

Vehicular networks have particular characteristics compared to the traditional mobile networks, and it is important to understand their characteristics in order to design suitable protocols.

Mobility Modelling and Predication Due to high mobility, vehicular connectivity is intermittent. The high mobility dynamic of vehicles and the use of short range communication makes connectivity among the cars very unstable. The dynamic topology and the shared bandwidth impose some QoS constraints. Such cases, mobility prediction plays an important role in network protocol design. Indeed, mobility of vehicular nodes is usually constrained by highways, roads and streets, hence based on given the speed and the street map, the future position of the vehicle can be predicated.

Novel Technologies VANET are characterized by the availability of various types of technologies inside a vehicle. Vehicles are equipped with on-board GPS (Global Positioning System), DVD/CD player, and speaker systems. They are also equipped with even more gadgets such as sensors and rear-view cameras. Novel technology also includes laser equipments and advanced sensors for autonomous driving capabilities. The passengers, also, are often well equipped with laptops, PDAs and cellular phones with connection to the Internet.

Operating Environments Vehicles can move into many different environments can interfere with wireless communication. Possible environments include city environments, disaster situations, and extreme weather conditions. City environments, for instance, may influence transmission signal interference and obstruction. In addition, streets maps in an urban scenario impose a different network topology compared to a highway scenario.

Application Requirements New applications impose severe requirements like short delay transmission and reliability. For example, in an automatic highway system, when a braking event happens, the message should be transferred and received in a certain time to avoid a car crash. In such applications, rather than the average delay, the maximum delay will be crucial.

Sufficient energy, processing capabilities and storage A common characteristic of nodes in VANETs is that nodes have ample energy and computing power (including both storage and processing), since nodes are cars instead of small handheld devices. The high computational power allows combination with the other information coming from other vehicles to eliminate redundancy, minimize the number of transmissions and improve the quality of the sensor information. This makes possible complex treatments such as data fusion and aggregation.

2.4 ITS and Vehicular Applications

The diversity of vehicular applications and the potential new use cases have challenged both researchers and industrials to develop and test new communication protocols that suit the vehicular network characteristics. Many efforts have attempted to study and to classify the ITS applications in order to understand the communication requirements. [51] classifies the vehicular applications according to the nature of the information services they gather. This classification ranges from data source applications, data consumer applications and interactive applications. For instance, vehicular urban sensing falls within the first category. It is used for effective monitoring of environmental conditions and social activities. This type of application was the focus of the CarTel [Car] project. Data consumer applications focus on the data content distribution such as multimedia files, road condition data or location aware advertisements such as POI (Point Of Interest) applications which were one of the main interests of the ScoreF project. The third category deals with the interactive applications and especially voice chatting and network games. In [Dar et al.], the authors explore vehicular applications and classify them

into safety, efficiency and infotainment applications. They list the requirements of each class of application in terms of use cases, communication mode, minimum transmission frequency and minimum latency.

In our work, we have a specific interest in common applications where the use of multicast communication is relevant. More precisely we focus on *fleet management* and the *POI* applications. In the following section, we present these applications and detail their requirements.

2.5 Multicast Applications in ITS

Multicast applications in vehicular scenarios may be categorized into two groups, geo-independent and dependent, in which fleet management and poi are included, respectively :

2.5.1 Geo-independent Multicast

In this category, a group of vehicles receive a multicast service without depending on their geographic position. An example of such an application is fleet management, where a group of vehicles is monitored and tracked continuously. The group of vehicles can be managed centrally from the Internet or locally in the wireless vehicular network. A vehicle's navigation assistance, path planning and platooning are examples of fleet management applications. Another notable application in this category is the car sharing service, where a fleet of cars is monitored centrally by a management center and cooperate locally to coordinate and allocate tasks among vehicles. In this category, groups of vehicles are usually defined and configured a priori. Vehicles belonging to the same group have the same profile (i.e : taxi, trucks, etc) and are interdependent and aware of each other. We qualify the groups as *tightly coupled* groups.

- **Identity of the group** : Group identity is usually pre-configured or set dynamically
- **Topological information** : Members need to keep topological information about each other
- **Group management** : members cooperate and they are coordinated in a distributed or a centralized way

2.5.2 Geo-dependent Multicast

In these applications, data is transmitted to a group of vehicles in a specific geographic area. This data can be of various types including critical information such as alerts about an accident or a potential congestion which may occur in the future or even commercial opportunities such as geographical service advertisements. Whether the vehicles are already subscribed to the same service or not, residing in the same geographic location leads to an implicit definition of groups even if vehicles belonging to the same group are autonomous and do not depend on each other. A notable application in this category is the localized congestion alerts. The application's objective is to alert vehicles which reside in a given geographical area about a congested area, so they can avoid it or change their road itinerary accordingly. The service can target some specific vehicles which may already be subscribed to this service, or even all vehicles that belong to a certain area.



FIGURE 2.3: POI Applications

Multicast groups are *loosely coupled* groups. Members can operate relatively independently of each other and they are usually autonomous. This type is well suited well to geographic multicast communication where vehicles are independent. This type of grouping has numerous characteristics :

- **Identity of members** : In order to be reachable from the Internet, vehicles have to auto-configure a global address that can identify them in the Internet. This identity is strongly related to the geographic location.
- **Topological information** : As members are independent, no central entity knows the identity of members a priori. Group members are not connected and do not explicitly announce themselves in the network.
- **Group management** : Group management and maintenance of multicast members is not always necessary.

2.5.3 Multicast applications classification

Following the application characteristics that we outlined in Section 2.5, in this section, we present a classification of the applications as shown in Figure 2.4. The main criteria that we consider are the group characteristics. Our classification takes into account at the second level the dependency of the applications to the geographical scope.

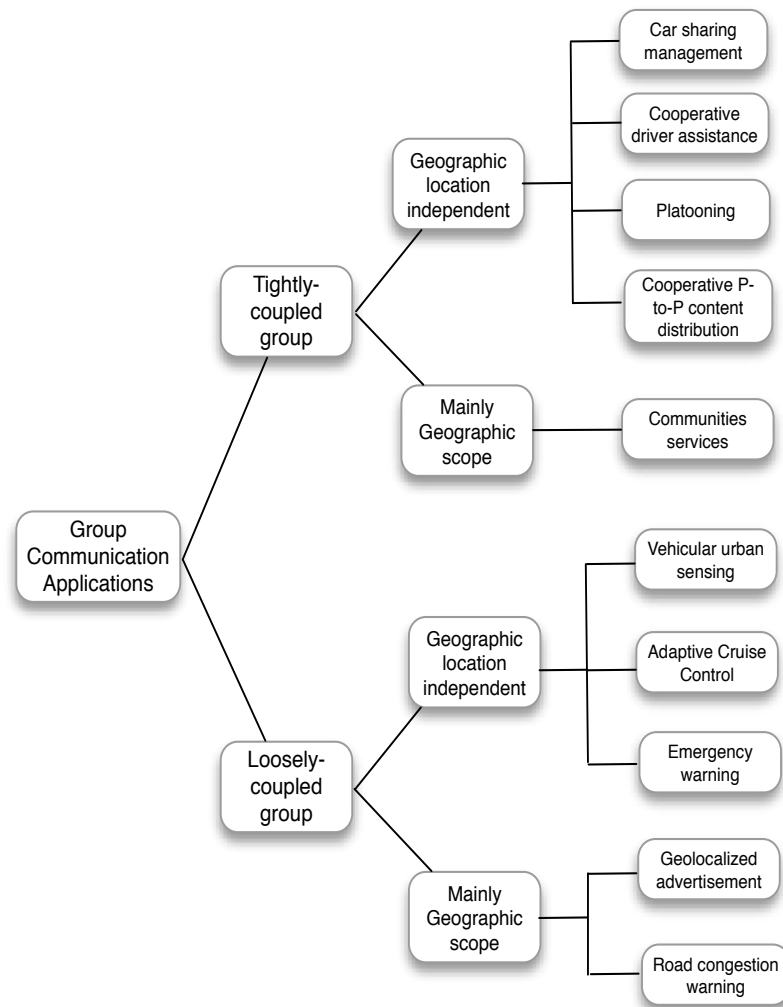

FIGURE 2.4: Applications Taxonomy

We review in the remaining sections the background of multicast communication first in the Internet and second in vehicular networks. We call *Multicast* routing the delivery of packets in the case of fleet management scenarios and *geocast* the Geographic Multicast dissemination in the case of POI-type applications.

2.6 Multicast in the Internet

Group communication has been a major concern of many research studies over the last fifteen years. This was first introduced for many Internet applications like video conferencing and IPTV, etc. In these applications, following the early idea of the host model of Deering [23], a set of fixed hosts subscribe to the multicast service in order to receive the corresponding data flows. Conventional protocols define a multicast group as a collection of hosts which register to a multicast group address. Multicast packet delivery from the source to the members of the group is then ensured by a specific routing protocol. Multicast routing in wired networks basically relies on a distribution tree. Many protocols such as DVMRP [62] and PIM [26] implement a tree-based multicast routing. Multicast in IPv6 relies on the two reference protocols, the Multicast Listener Discovery [77] (MLD) and Protocol Independent Multicast (PIM). MLD performs management of the groups on local links. Each local router manages the membership of the group subscribers on the link. PIM builds and maintains a distribution tree to deliver the packets from a source to the multicast members as shown in Figure 2.5. Two types of distribution trees exist :

- Shortest Path Tree (SPT) : Also known as per-source tree. This is a tree built from the source to all the members. The source is the root of the tree. Each source has its own tree.
- Shared Tree : This is a single tree rooted at a Rendezvous Point (RP) which is a router that controls the packets destined for one group and sent from many sources. All packets destined for the same group from different sources are first sent to the RP which is the root of the tree. The RP routes the packets over the distribution tree.

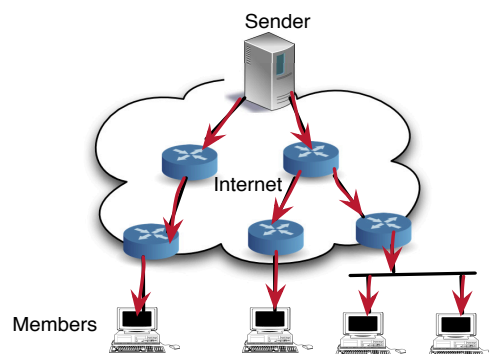

FIGURE 2.5: The multicast distribution tree in Internet

2.7 Review of Multicast Routing Approaches in Vehicular Networks

Unlike wired networks, where multicast members and multicast routers have distinct roles, in mobile networks, nodes can be at the same time a multicast member and a router. Multicast routing in Mobile Adhoc Networks can be achieved through several techniques as listed in the following :

- **Unicast-based approaches** : In these approaches, the source generates copies of the data for each multicast receiver. The packets are then transmitted over unicast routing paths to the receivers as shown in Figure 2.6 a). Although this approach is simple, it creates a large number of packets in the network.
- **Broadcast-based approaches** : In these approaches, the message is disseminated over the entire network. Only receivers intercept the multicast packets and provide them to the corresponding multicast applications. The basic approach is *Flooding*, where each node that received the packet retransmits it. The flooding approach is illustrated in Figure 2.6 b).
- **Multicast-based approaches** : In this approach, message delivery from the source to the multicast receivers follows a specific path that can rely on a tree or a mesh structure. The goal of this approach is to merge the path from the source to the receivers in order to reduce the number of packet retransmissions as illustrated in Figure 2.6 c).

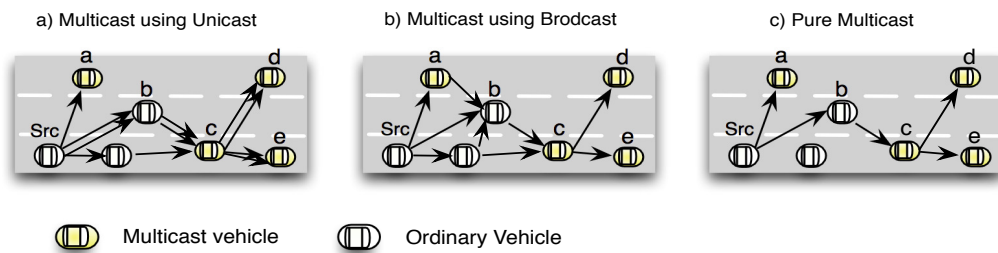

FIGURE 2.6: Multicasting Techniques

In Sections 2.7.1, 2.7.2 and 2.7.3, we review the state-of-the-art of the main routing protocols that adopt the above-mentioned approaches.

2.7.1 Review of Unicast Routing in VANET

Several studies in the literature survey and classify existing routing protocols in VANET [54] [46] [52] [13]. Generally, unicast routing protocols are classified in the literature as **topological routing**, **geographic routing** and **DTN routing**. The first routing category is the traditional topological-based routing which makes use of global path information and link information to forward packets. Topological routing needs to maintain a path from the source to the destination in a proactive or a reactive way. Examples of such routing protocols are AODV [61], OLSR [34] and DSR [37]. The frequently changing topology and the short connection lifetime, especially with multi-hop paths significantly degrade the performance of some popular topological routing protocols for ad hoc network.

The second routing category is geographic routing which uses the geographic positions of nodes to perform packet dissemination. Geographic routing maintains local information on nodes' positions to forward packets from the source to the destination. The Greedy Perimeter Stateless Routing (GPSR) [40] was one of the first geographic routing protocols in mobile networks. In GPSR, the packets are forwarded to the neighbor that is closest to the destination. GPSR avoids local optimum situations by performing a perimeter approach. The Anchor-based Street and Traffic Aware Routing (A-STAR) [68] forwards the packets from the source to the destination by selecting a set of intersections. The packet is forwarded through the roads that have higher connectivity using a greedy forwarding approach. Gytar [35] is also an intersection-based geographical routing protocol capable of finding robust routes within city environments. Gytar forwards the packets dynamically along closer roads to the destination that provide a good connectivity. [58] is a hybrid approach that establishes an anchored path between the source and the destination and then performs a greedy forwarding strategy to the anchor points of the path. To maintain the routing path, "Guards" help to track the current position of a destination.

[85] is an example of DTN routing. It presents the Vehicle-Assisted Data Delivery in Vehicular Ad Hoc Networks (VADD) which can forward the packet to the best road with the lowest data delivery delay. VADD uses the Store-Carry-Forward technique and based on the existing traffic pattern, a vehicle can find the next road to forward the packet to the destination to reduce the delay.

2.7.2 Review of Broadcast Routing in VANET

Flooding is the simplest broadcast scheme, in which vehicles blindly rebroadcast every message they receive without applying additional control mechanisms. In low density scenarios, where the probability of broadcast storms is reduced, flooding represents a good candidate scheme.

The *weighted p-persistence* and the *slotted p-persistence* techniques presented by [79] are some of the few rebroadcast schemes specifically proposed for VANET. These probabilistic broadcast suppression techniques can mitigate the severity of broadcast storms by allowing nodes with higher priority to access the channel as quickly as possible. However, their ability to avoid storms is limited since these schemes are specifically designed for highway scenarios, and so their effectiveness in other scenarios is reduced.

[69] proposed a stochastic broadcast scheme (SBS) to achieve an anonymous and scalable protocol where relay nodes rebroadcast messages according to a retransmission probability. The performance of the SBS system depends on the vehicle density, and the probabilities must be tuned to adapt to different scenarios.

The *enhanced Street Broadcast Reduction* (eSBR) scheme [57], proposed by Martinez et al., was specially designed to be used in VANET and takes advantage of the information provided by maps and built-in positioning systems, such as the GPS. Vehicles are only allowed to rebroadcast messages if they are located far away from their source ($> d_{min}$), or if the vehicles are located in different streets, giving access to new areas of the scenario. The eSBR scheme uses information about the roadmap to avoid blind areas due the presence of urban structures blocking the radio signal.

[28] presented the *enhanced Message Dissemination for Roadmaps* (eMDR) scheme, as an improvement to eSBR. In particular, eMDR increases the efficiency of the system by not forwarding the same message multiple times if nearby vehicles are located in different streets. Specifically, vehicles use the information about junctions on the roadmap, so that only the closest vehicle to the geographic center of the junction, according to the geopositioning system, is allowed to forward the received messages. This strategy aims at reducing the number of broadcasted messages while keeping a high percentage of vehicles informed.

[74] presented the Distributed Vehicular Broad-CAST (DV-CAST) protocol. Specifically, DV-CAST is a distributed broadcast protocol that relies only on local topology information for handling broadcast messages in VANETs. DV-CAST mitigates the broadcast storm and disconnected network problems simultaneously, while incurring a small amount of additional overhead. In particular, the DV-CAST protocol relies on

local topology information (i.e., a list of one-hop neighbors) as the main criterion to determine how to handle message rebroadcasting, adapting the dissemination process depending on the density of neighbor vehicles, their position, and their direction.

2.7.3 Review of Multicast Routing in VANET

In the structure-based protocols, the multicast route establishment process is either proactive or on-demand. In reference proactive multicast protocols in MANET such as AMRIS [80], AMRoute [81] and ODMPP [50], the path to all the possible destinations is precomputed. Then, periodic control messages are disseminated to maintain up-to-date knowledge about the network routes. The idea behind typical on-demand multicast routing such as MAODV [66], and PUMA [75] is based on a query/response procedure, where the node discovers the network topology in the query phase and the route is established when the response is sent back to the requester.

In vehicular networks, multicast schemes are more or less based on the same strategies.

[18] is one of the first works to propose a modified flooding scheme for multicasting in vehicular networks. In this scheme, the multicast nodes are assumed to be dynamically identified and a vehicle receiving a message calculates a time that is proportional to the distance to the sender before new neighbors enter its transmission range.

Sebastian et al. [67] propose a multicast routing scheme that is based on the calculation of a delay constraint Steiner tree. In their approach, the sender of a collision warning disseminates the message only for a set of endangered vehicles. Vehicles are assumed to periodically exchange beacons that are used to estimate the delay on each link. The delay between each pair of nodes is then used to calculate the minimum cost path between nodes that are relays or receivers in the multicast tree. Hsieh et al. [32] propose an overlay multicasting scheme to deliver multimedia streams in urban vehicular environments. In their method, an overlay mesh topology is maintained between the multimedia streaming source and the members of the multicast group. In their method, to provide QoS new parent nodes are dynamically chosen in the topology based on their packet loss rate and end-to-end delay. To overcome changes in the topology, each multicast member is attached to two parents.

Following the new trends that consider a vehicular network as a Delay Tolerant Network (DTN), some studies propose multicast schemes that fit the DTN context. In [71], the authors use a modified epidemic multicast routing scheme to deliver the packets to a set of receivers. In their scheme, the receivers are already encoded in the

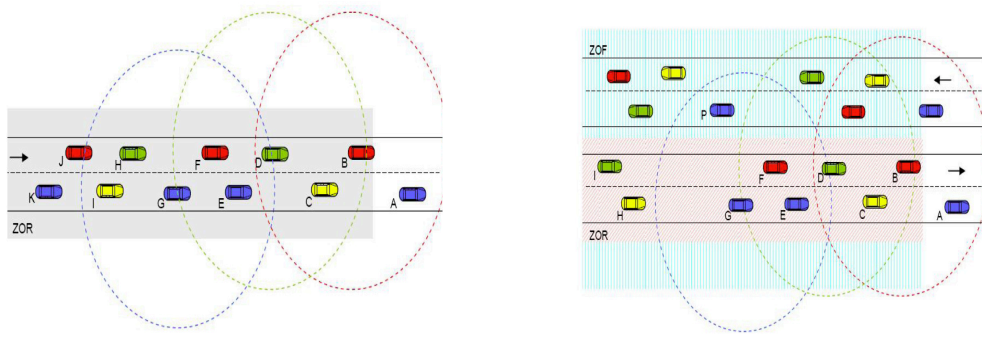

FIGURE 2.7: Zone Of Relevance and Zone Of Forwarding in geocast Type of dissemination

packet header and as a result are known to the source. A node is assigned a custodial responsibility to deliver a message to a number of nodes it meets. It may also pass on the responsibility of forwarder to some of these nodes to further deliver the packets for the multicast members. In [82], the authors propose OS-Multicast in which a node, which receives a bundle, dynamically recalculates trees rooted in itself to all the destinations based on current network conditions.

2.8 Review of Geocast Routing Approaches in Vehicular Networks

Geocasting is the dissemination of messages to all nodes belonging to a given geographic zone called the *Zone Of Relevance ZOR*. This zone can, for instance be, an area affected by an accident or even an area where a commercial advertisement should be propagated. The main concern of geocasting protocols is to be able to cope with the network dynamics to deliver the message to the ZOR which is usually specified by the application. For this purpose, a *Zone Of Forwarding ZOF* is defined within which the relay vehicles are involved in forwarding the message to the ZOR.

2.8.1 Mac-Based Geocast

Distributed Robust Geocast [44] DRG's interest is to spread the message in the area. DRG proposes a scheme for one and two dimensional networks. In the first scheme, transmitters use a distance-based back-off that the furthest vehicle from the transmitter will relay the message. In [ref], the forwarding zone is split into two partitions; an upper forwarding zone and a lower forwarding zone. Each forwarding zone is responsible for carrying one packet flow. The goal is to increase the throughput toward the forwarding

zone. Once the packet reaches the destination area, a network coding strategy is applied to overcome packet loss. The authors of [multiforwarding zone] propose splitting the forwarding zone which could be a cone or a box into two equal partitions; a higher partition and a lower partition. To increase packet throughput, the data flow is also split between the higher and the lower partition, and using MIMO antennas, the packets can be sent simultaneously towards the ZOR. A network coding mechanism is then applied to overcome packet loss problems in the dense network.

2.8.2 Spatiotemporary Geocast

In [21], to overcome network fragmentation, the authors propose a scheme that dynamically defines the forwarding zone ZOF at a given time t . Their protocol operates in three phases. The first phase is a Creation phase in which an elliptic ZOR centered on the vehicle that witnesses the event is created. In the dissemination phase, neighboring vehicles try to disseminate the message to the left and right apex of the ellipse. The growing phase is initiated by the relayer of the message when no neighbor is found in the initial dissemination region, thus a new elliptic approaching zone is created by the message's relayer. A node which is a neighbor of the relayer tries to forward the message within the approaching zone, if no neighbor exists, it will initiate an other approaching zone. The forwarding zone is then built dynamically and is the sum of the ZOR with all the approaching zones. In [63], the authors use the vehicles in the opposite lanes called helping vehicles in a highway scenario to relay an emergency message to the ZOR for a certain period of time T . The vehicles that are in the ZOR are called intended vehicles. Two dissemination periods are defined. The first one is a pre-stable period in which leaders of helping vehicles try to broadcast the alerting message in the ZOR. Once the helping vehicles reach the end of the ZOR, the stable period begins. An extra distance which is inversely proportional to the density of the highway is calculated. During the crossing time of this distance, the helping vehicles and the intended vehicles repeatedly rebroadcast the message until they receive an acknowledgment from the vehicles in the opposite lane. This goal of this operation is to make the alert message active within the ZOR during the required time which may change.

2.8.3 Opportunistic Geocast

In [55], the authors present an opportunistic geocast routing algorithm based on a new routing metric called the expected visiting rate to a destination region. More precisely, since the scheme uses a multi-copy-based Store-Carry-Forward approach to

deliver the geocast message to a destination region, the packet is delivered only to nodes that have high expected visiting rate to the geocast area.

2.8.4 Comparison of Geocast protocols

In the following table, we present a comparison between according to several criteria of the different geocasting protocols described in the previous section.

TABLE 2.3: Comparison of geocast protocols

Criteria	DRG	Moicast	Network co- ding geocast	DTSG
Application	Emergency warning	Emergency online games video	Not specified	Emergency warning
Main Concern	Minimum number of retransmis- sions	network fragmentation	Maximize throughput	Minimum number of retransmis- sions
Control mes- sage overhead	No	Yes	No	No
Dynamic ZoR	No	Yes	No	No
Scenario	Highway Urban	Highway	Not specified	Highway
Store-Carry- forward	No	No	No	Yes
Digital map	No	Yes	No	No
Mobility considerations	No	Yes	No	Yes

2.9 Conclusion

In this chapter, we have summarized the background and the related studies that have been carried in the field of vehicular networks in general and multicast communication in particular. There are a number of contributions that have been made at several

levels including new protocols, technologies and applications. Numerous vehicular applications have been addressed in the literature and the communication technologies and requirements have been specified. In this work, we are mainly interested in applications that involve group communication mechanisms. We essentially focus on fleet management and Point Of Interest applications.

We studied the existing multicast routing mechanisms that are suitable for both geographical and non-geographical communications types.

In the following chapters, we will state the problems of Internet-to-VANET communications and explain our contributions.

Résumé du Chapitre 3

Dans ce chapitre, on adresse le problème de l'accessibilité des services multicast déployés dans Internet par les véhicules. En effet, permettre des communications multicast entre l'Internet ayant une infrastructure fixe et le réseau véhiculaire mobile ou la topologie change fréquemment pose un véritable défi. En premier lieu, pour accéder à ces services, les véhicules doivent être capables de s'auto-configurer une adresse multicast valide. Ensuite, le mécanisme de la gestion de la mobilité dans Internet doit être adapté aux caractéristiques des réseaux véhiculaires. Concernant le problème de l'adressage, on propose GMAA (Geographic Multicast Address Auto-configuration), un mécanisme d'adressage géographique qui permet aux véhicules membres des groupes multicast de s'auto-configurer dynamiquement une adresse multicast. Pour la gestion de la mobilité des membres multicast, on propose une approche simplifiée qui permet d'optimiser la signalisation entre le réseau véhiculaire et les entités responsables de la gestion de la mobilité dans Internet dans le cadre des architectures Mobile IP (MIP) et Proxy Mobile IP (PMIP).

Chapitre 3

Multicast For Hybrid Scenarios

3.1 Introduction

In this chapter, we address the issue of multicast members reachability, in order to access the services that are deployed in the Internet. A major challenge is, we believe, to enable multicast communications between the Internet and multi-hop vehicular networks. In particular, this requires ensuring some functionalities. First, vehicles have to be capable of auto-configuring a valid and global multicast address and second, the IP mobility mechanism has to be tailored to the vehicular network in order to ensure efficient mobility management of the multicast members. Regarding the addressing issue, we propose GMAA (Geographic Multicast Address Auto-configuration), a geographic addressing framework that enables vehicles to dynamically auto-configure multicast addresses. For the mobility management of the receivers, we propose a simplified approach that optimizes the signaling between the VANET and the entities that manage the mobility of the mobile members in the context of Mobile IP (MIP) and Proxy Mobile IP (PMIP).

3.2 Preliminaries

Multicasting in the Internet has a long history and has produced a number of standardized protocols to support multicast services for addressing [72], membership management [19], [77] and multicast routing [62], [26]. However, the specific characteristics of the vehicular environment make it difficult to adapt these protocols to VANET. In particular, multicasting to VANET mobile users (i.e., drivers and occupants) raises additional challenges including multicast addressing and multicast mobility management.

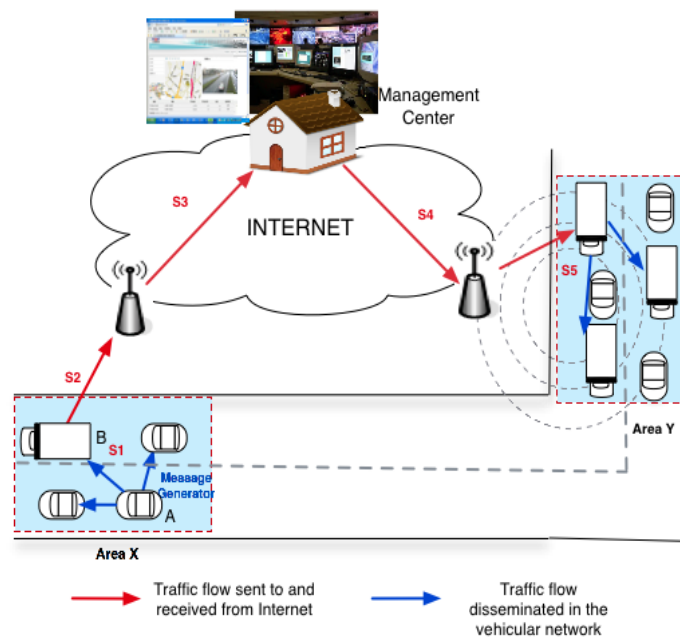

FIGURE 3.1: Multicast in hybrid scenario

Figure 4.12 illustrates the problems of addressing and mobility management of multicast members in the Internet. In the figure, a truck detects a hazard on the road and broadcasts (i.e., geocast) an alarm message to the immediate area (step S1 in the figure). The message is also forwarded to a central server, located in the Internet, that can process the information and generate a multicast message sent to the trucks in a remote area e.g., to recommend an alternative route. In this scenario, the server forwards the message to the upcoming vehicles in the remote area Y (step S3 and S4 in the figure). Obviously the communications of S2-S4 are based on conventional IP routing and addressing (including the mobility management of the receivers); communications for S1 and S5 are more suited to geographical addressing and dissemination techniques. Hence, the difficulty lies in the hybridation between conventional IP protocols and geographical dissemination protocols.

In the following chapters, we set out the problems related to both multicast addressing and mobility management.

3.3 Multicast Addressing for Mobile Multicast Members

3.3.1 Problem Statement

To receive multicast traffic through the Internet or from neighbouring vehicles, a group has to be identified by a unique multicast address that is needed by the routing

protocol to perform correct packet routing. Currently, as in the conventional Internet, the multicast addresses are assumed to be *a priori* configured or announced. A node in the Internet receives multicast data through the fixed infrastructure if it has subscribed to the service via its multicast address. In the ITS scenario, however, the data destination is frequently changing. For example, information sent to inform drivers about a congested zone changes according to the variation of the road traffic in a given city in the rush hours. This consequently leads to changing the destinations that subscribe to the service. In the vehicular context, it is more common to use geographical location to identify vehicles, since vehicles are assumed to be equipped with GPS devices, rather than a pre-configured address that might not be known by the source. Moreover, vehicles can be identified by the geographical area in which they reside. This concept matches well with the conditional multicast data transmission where destinations of the data change according to the message content. In addition to this, geographic multicast addressing is required by routing protocols to perform correct packet dissemination among the multicast receivers. Consequently, a dynamic geographic multicast addressing system is needed to meet the above requirements.

3.3.2 Related Work

IPv6 provides a standard mechanism to auto-configure IPv6 addresses. As defined in the Stateless Address AutoConfiguration (SLAAC) [73], nodes receive network prefix advertisements sent by access routers which provide Internet connectivity. The prefix is then merged to the MAC identifier to calculate a valid IPv6 address. Duplicate Address Detection (DAD) is then performed to check the uniqueness of the address in the network. SLAAC is designed for one-hop communication between Internet Access Router and mobile nodes. Thus, it is mainly defined for standalone mobile nodes and is not suitable for the multi-hop nature of VANET.

[24] introduces a multicast gateway (MGW) to transmit multicast in mixed networks; a fixed subnet and a MANET. This work relies on the infrastructure to deliver multicast packets to the mobile nodes but does not consider the multi-hop nature of data dissemination.

[Fazio et al.] is one of the first studies to deal with address configuration in VANET. It proposes Vehicular Address Configuration (VAC) which is a distributed approach based on a set of leaders acting as DHCP servers in the network. VAC allows nodes to configure a valid address since they are connected to leaders in a linear topology but is not robust in disconnected networks where vehicles frequently change their velocity.

Currently, there is a tendency to prefer geographical addressing and routing for vehicular networks. This is due to the fact that several VANET applications have a geographical scope. Moreover, geographical routing which use geographic locations of the nodes has been shown to be preferable in vehicular scenarios compared to traditional topology-based routing protocols [48] [36] [49]. The pioneering work that first integrated the geographic information into the address was introduced in 1997 in [59]. This work formed the basis for studies that propose new designs of possible geographic addressing. It defines three solutions to integrate geographic addresses to the Internet design. First, an application layer solution using an extended Domain Name Service (DNS) where a geographic address is expressed in a set of IP addresses of "GeoNodes" covering the destination area. Second, Geo-multicast where each partition is mapped to a multicast address, and third, geographic unicast addresses that can be routed by geographical-aware routers.

In [42], following the concept introduced in [59], a solution that encodes GPS coordinates into the IPv6 multicast address is presented. Nevertheless, this approach remains local and does not scale to the whole Internet where the routers are not yet aware of the still not geographically aware.

In [17], an approach that matches the geographic areas to the Access Routers' IP addresses using the extended DNS [59] is presented. In this approach, the packets, once reaching the Access Router, are disseminated in geobroadcast in a given geographic area. Unlike [17], our approach does not require signalling to configure a common geographic multicast address and takes into consideration the mobility of the multicast group.

We propose a framework that enables the multicast members to auto-configure a global address. The following section specifies the design requirements.

3.3.3 Design Requirements

As outlined above, unlike the existing solutions for multicast deployment, the framework that we propose aims at providing a dynamic and self-configuring geographic multicast addressing and a simplified approach for packet delivery. To this end, we fix some requirements :

- **Scalability** : The framework has to offer a global geographic addressing and multicast delivery service for a large number of groups and members.
- **Low complexity and ease of deployment** : In a respect of the classic multicast delivery schemes that relies on a multicast distribution tree, our approach should

offer minimal effort of configuration. Moreover, it must ensure that only minimal changes are required if new services in the infrastructure or in the vehicular networks are deployed.

- **Efficiency** : This is particularly related to the multicast delivery approach which has to provide low signalling overhead for efficient bandwidth utilization especially in the vehicular network.
- **Generic for Internet and geographic communication** : Our addressing approach has to be generalized for IP and geographic communication. This is mainly necessary to host new services that have different requirements. Some services require local multicasting in the direct neighbourhood while others require global multicasting through the Internet.

3.3.4 GMAA : Geographic Multicast Address Auto-configuration

To provide a solution to the problem of autonomous multicast addressing and configuration for vehicles that are in the same geographic location, we defined a distributed mechanism that allows the vehicles to configure common multicast addresses. Using a dynamic geographic multicast address matches the requirements of vehicular applications that target usually a given geographic destination. The GMAA allows the vehicles to configure their own address without signalling (i.e, no control message is generated). Furthermore, to support geo-based applications, a vehicle will be able to change the multicast address to which it is subscribed when it changes its location.

We assume that the geographic areas are already partitioned into small areas (for instance, a road can be divided into small segments) as shown in Figure 3.2 and that each vehicle has the same geographic partitioning in its embedded digital map since the vehicles are equipped with GPS devices and map-matching capabilities.

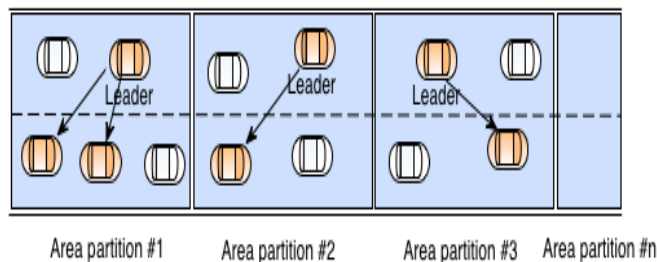

FIGURE 3.2: Geographic area partitioning

We also consider that the group identity is already defined implicitly by a *profile*. The *profile* includes the vehicle type (i.e : taxi, bus, emergency vehicle, and etc), the motion and the geographic location in which the group of vehicles is moving. All the

vehicles that have the same profile, have a specific *hash function* and a key service. The hash function $H()$ (see equation (3.1)) takes M geographic attributes of the geographic area p_i (e.g : for a circular area, the geographic attributes are the longitude and the latitude of the centre and the radius) where the vehicles are moving and generate a hash value as shown in Figure 3.4. The hashed value is the *Group Identifier* of the multicast address. Using the hash function secures the generated multicast. Only vehicles that have the service key and the hash function are able to generate the same address.

The *Group Identifier* is a sequence of N bits, h_i is the bit in position i of the sequence as shown in ((3.1)).

$$H(p_1, p_2, \dots, p_M) = (h_1, h_2, \dots, h_N); h_i \in \{0, 1\} \quad (3.1)$$

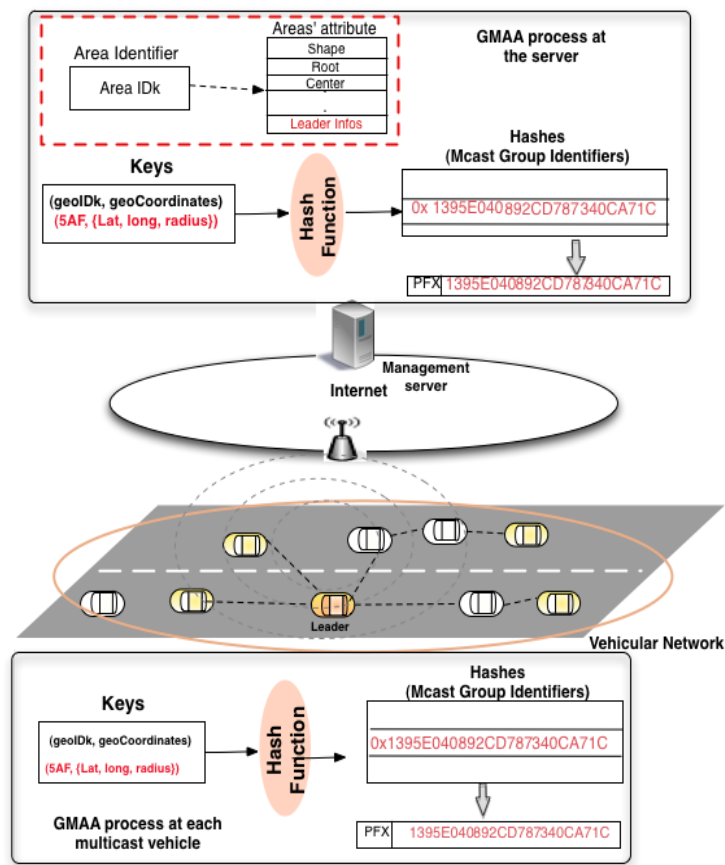

FIGURE 3.3: The GMAA operations

An application that runs on the host will subscribe to both a geographical multicast group generated from the process of hashing and a global multicast group generated by concatenating a prefix that has a global scope with the generated *Group Identifier*. The central server also has the same hash function. Once it receives a message that is to be disseminated to a certain geographic area, it generates the same address. In our work, we

used the *FNV* hash function [FNVHashFunction] which is based on multiplication and XOR operations. The reason behind our choice is that the FNV hash function is simple, easy to implement and has a low collision rate, which guarantees a high probability of the uniqueness of the group identifier.

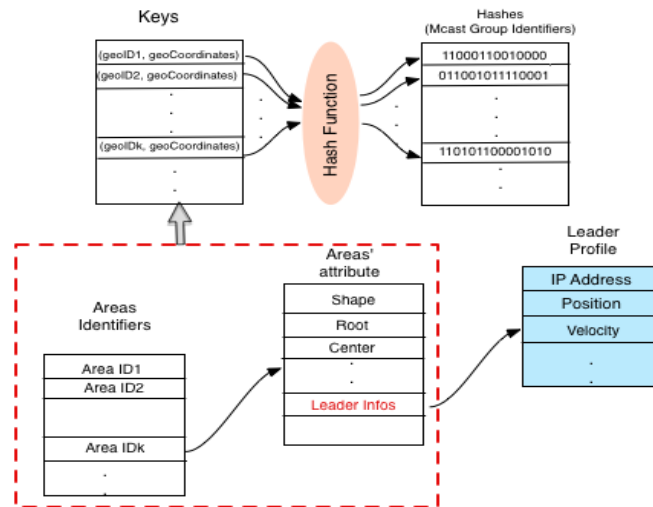

FIGURE 3.4: Hash Function and area fetching operation in the server side

3.3.5 Framework Integration

Our proposal has been integrated in the ITS architecture described in Chapter 2. This integration was done in a Field Operational Test project Scoref¹, which aims at preparing the future deployment of cooperative road-vehicle systems in Europe. It is compliant to the specification of the ITS reference architecture as explained in Chapter 2. Our integration is done basically in the management layer and the facilities layer which are implemented in the Knoplerfish² OSGi framework.

Figure 3.5 outlines the component integrated in the ITS communication architecture. We designed the following components :

- **The Mapper** is a management layer component responsible of multicast address generation. It contains the necessary functions that take as input the geographic attributes of a given area and a hash function (FNV as said before) and generates a unique **Mapped Multicast Address** per geographic region. It also sends and receives **Map matching Request/Reply** messages to and from the LDM (Local Dynamic Map).

1. <http://www.scoref.fr/>

2. Knoplerfish <http://www.knoplerfish.org/>

- **The GeoDestination Table** this management table stores the geodestination requested from Hazard Application Message DENM (Decentralized Environmental Notification Message) for instance (it could be other facilities messages) via **GeoArea Request/Reply** message exchange.
- **The Network Selector** Based on predefined rules given by the management layer, the network selector, which is a Facilities component, sends the message through a UDP/IPv6 stack or BTP/Geonetworking stack. The rule is related to the previously defined *Network Profile* **Profile Request/Reply**
- **The Mapping Table** is a kind of dictionary in the management layer that contains the geo-location attributes of a given shape of area and the mapped multicast address.
- **The Network Profile Manager** collects information from different layers. Depending on this information attributes the corresponding Communication Profile. The DEMN message for instance, requests the communication profile of the data flow to the Profile Manager and gets a bits array that specifies the transport, network and media access stack to which the packet must be sent.

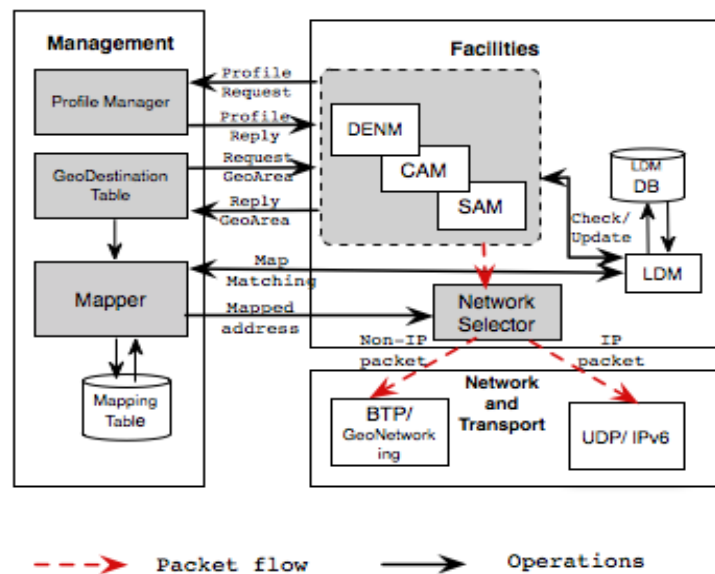

FIGURE 3.5: Framework Integration in the ITS Architecture

3.4 Mobility Management of Internet-to-VANET Multicasting

3.4.1 Background and Related Work

Current Internet mobility management solutions such as the Mobile IP (MIPv6 for IPv6) [60] and the Proxy Mobile IP (PMIPv6) [30] aim to locate mobile users and provide them with data in a seamless manner. Although existing multicast mobility management solutions can provide multicast data to mobile nodes (MNs), one issue of the solutions is that they are somehow based on the assumption that users usually stay in their home network (fixed network) hence consider the mobility of only one or a few users. Therefore, the simple and direct application of these solutions to emerging vehicular services, where there are many vehicles, most of which are moving continuously, would imply a large control overhead due to per-user membership management, and inefficient bandwidth utilization due to the unicast bidirectional tunnels built by MIPv6/PMIPv6. We consider that such a control overhead and bandwidth over-usage can be avoided, particularly when the mobile users are in the same geographical area, which is the case for the mentioned fleet management and POI distribution applications.

In vehicular environments, another issue of existing multicast mobility management approaches is that they obviously cannot provide multicast data to MNs that do not have Internet connection (e.g., because they are not in the coverage area of access networks, and/or they are not equipped with 3G/4G devices). A solution to provide multicast data to such MNs is to extend the mobility management solution by providing ad-hoc networking, (i.e., by using VANET).

Motivated by this, we propose an extended multicast mobility management scheme, especially designed for the vehicular communications, that provides a set of mobile nodes with mobility management with small control overhead and efficient bandwidth utilization.

3.4.1.1 Multicast Mobility Management in Mobile IP

The key idea of MIPv6 is a fixed entity in the Mobile Node's (MN) home network, the so-called Home Agent (HA) that locates the MNs and builds a bidirectional tunnel which is used to transfer data destined for each MN. Mobile IPv6 proposes a set of solutions to manage the mobility of multicast members.

- (a) **Bidirectional tunneling or Home Subscription** : In this approach, the MN sends a *Join Subscription* to its HA via the communication tunnel. Being a part

of the multicast path in the Internet (e.g, as defined by the PIM protocol), the HA intercepts the multicast packets directed for the MN, encapsulates them and sends them to the mobile node in its new attached network.

This approach raises drawbacks related to the triangular routing which may not provide the shortest path, causing latency and congestion in the HA. Moreover, when several multicast members of the same group are located in the same visited network, using Home subscription will create several copies of the same message and will result in an inefficient packet transmission.

- (b) **Remote subscription** : In this approach, the MN joins the multicast group by sending an MLD Report to the Access Router of its visited network. This procedure includes the frequent change of the routing path to reach the multicast distribution tree each time the Mobile Node changes its access network. This approach overcomes the triangular routing problems but at the cost of including complexity in rebuilding multicast routing paths. Thus, it can lead to huge packet losses. [64] introduces a solution that relies on a Multicast Router Proxy (MRProxy). In this solution, the mobility management of the multicast receivers and the multicast routing are separated, and the HA is only responsible for the mobility management of the mobile receivers. It also forwards the Multicast Membership report to the MRP and notifies it when a mobile receiver changes its location. The MRProxy is only in charge of routing multicast data to the mobile receivers. This approach reduces the stress on the HA but leads to additional signaling messages between the HA and the MRProxy and thus additional delays to route packets toward the mobile receiver. This solution is introduced in [64].
- (c) **Agent-based solution** : In this solution, static agents acting as proxies are responsible for multicast mobility, which results in inter-tree handover.

As shown in Figure 3.6, in MIPv6, using MLD, the Home Agent (HA) transmits a multicast listener query (MLQ) to the Mobile Node (MN) over the tunnel, and the MN returns a Multicast Listener Report (MLR) showing its interest in receiving the multicast data. Upon reception of the MLR, the HA joins the multicast delivery tree and forwards received multicast data over the bidirectional tunnel(s) to the MNs.

3.4.1.2 Multicast Mobility Management in Proxy Mobile IP

[41] states the problems of using host-based mobility management mechanisms such as Mobile IP. The authors explain that using such mechanisms can lead to long latency, high signaling overhead and location privacy problems. [41] presents solutions to overcome the problems of global mobility management. In fact, localizing the mobile

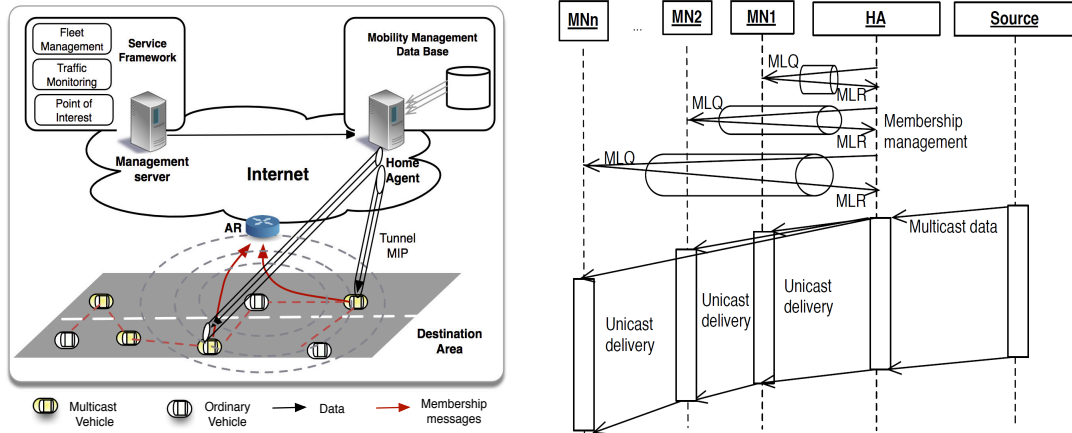

FIGURE 3.6: Mobility Management in Mobile IPv6

nodes movements to newer link on a smaller scale is preferable because it provides local control of the mobility management. Proxy Mobile IPv6 [30] is one solution that uses a Network-based localized mobility management approach. In this approach, the Mobile Nodes do not implement mobility management functions. Additional network entities, called the Mobile Access Gateways (MAGs) and the Local Mobility Anchor (LMA) are in charge of managing IP mobility on behalf of the mobile node (MN).

RFC 6224 details the support of use Multicast Listener in Proxy Mobile IPv6 (PMIPv6) domains. In PMIPv6, Mobile Access Gateways provide MLD proxy functions [14]. The MLD Forwarding Proxy is a simplified mechanism that can be deployed in simple topology where a multicast routing protocol is not necessary and would lead to additional costs. MLD Forwarding Proxy forwards the multicast membership information from their ingress interfaces attached to the nodes in their local networks to their up-links attached to the multicast routers. In PMIP, when the MAG receives a membership report from a mobile node from its downstream link, it checks its membership database, aggregates the membership information if needed and forwards it in its upstream tunnel established with the corresponding Mobile Node LMA. The LMA also maintains a membership data base and is acts as a router in the Internet multicast routing infrastructure. When it receives multicast data, it forwards it through the tunnel to the MAG, which forwards it to the mobile nodes.

Figure 3.7 illustrates the operations performed in PMIPv6 to manage the mobility of the mobile receivers. MLD signaling is used between the Mobile Access Gateways (MAGs) and the MNs. MAGs broadcast MLQ (Multicast Listener Query) to MNs under their coverage, collect MLRs from them, and send aggregated MLRs to the respective Local Mobility Anchor (LMA). Upon reception of the MLR, the LMA joins the multicast delivery tree and forwards received multicast data over the bidirectional tunnel(s) to the MAG. The MAG multicasts the data received to the MNs.

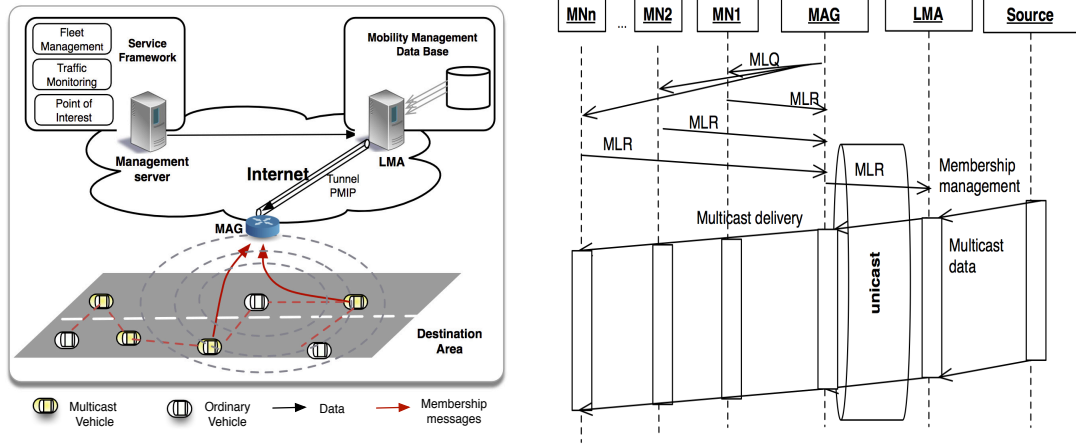

FIGURE 3.7: Mobility Management in Proxy Mobile IPv6

3.4.2 Approach Comparison

In this section, we present the advantages and drawbacks of the already cited approaches. A comparative study is detailed in table 3.1.

3.5 Extended Multicast Mobility Management for VANET

As shown in Figure 3.7 and 3.6, the efficiency in terms of control overhead and bandwidth utilization of the two schemes (i.e., MIPv6 and PMIPv6) degrades with an increase in the number of mobile nodes because MIPv6 (resp. PMIPv6) sends data over as many unicast tunnels as the number of MNs (resp. LMAs). Moreover, the two approaches obviously cannot deliver data to the MNs that do not have Internet connection either due to a lack of signal coverage or because they are not equipped with the necessary communications equipment (e.g., 3G/4G devices).

Targeting the above issues, we propose to extend the multicast mobility management solutions by exploiting the VANET concept.

3.5.1 Multicast Membership Management

Group members announce themselves through periodic information exchanges that contains their profile, their position and their velocity. One elected vehicle, say the leader, within the group is responsible for locally managing the groups in the vehicular network. The leader vehicle manages the groups in the vehicular network locally and thus is an intermediate node between the infrastructure and the mobile network. To the HA (in MIPv6) or the LMA (in PMIPv6), only the leader is changing its location and thus its

TABLE 3.1: Comparative study of the multicast mobility management approaches

Approach	Pros	Cons
Basic MIP tunneling	Mobile Node reachability to the multicast service	Non Optimal multicast routing Multicast membership management through HA tunneling Latency and Packets overhead Individual multicast membership management
Basic MIP Remote subscription	Avoids Multicast triangular routing	Multicast membership management through MAG and LMA tunneling Latency and Packets overhead Individual multicast membership management
Basic PMIP Proxy MLD	Simple local management of members by MAGS Latency and packets overhead Decreasing multicast traffic overhead towards MNs	Non Optimal multicast Routing Individual multicast membership management
Context Transfer	Optimizes handover latency Avoids triangular routing local management of multicast path change	Require AR/MAG discovery protocol Individual multicast membership management
MLD behaviour tuning	Reduces the join latency	multicast signalling due to tuning MLD QI/QRI timers Low support of large number of members Individual multicast membership management
Direct native multicast routing	No change of current standard	weakness of trees under mobility Individual multicast membership management
Direct overlay multicast routing	No change of the current standard provides simplified mulicast path	Deployment of additional agents (Proxies) Weakness under mobility Individual multicast membership management

IP address, as shown in Figure 3.8. In order to prevent creating a very large VANET groups, the size of the multicast group in terms of the maximum number of hops from the leader to any member should not exceed TTL_{max} (the maximum Time To Live) number of hops.

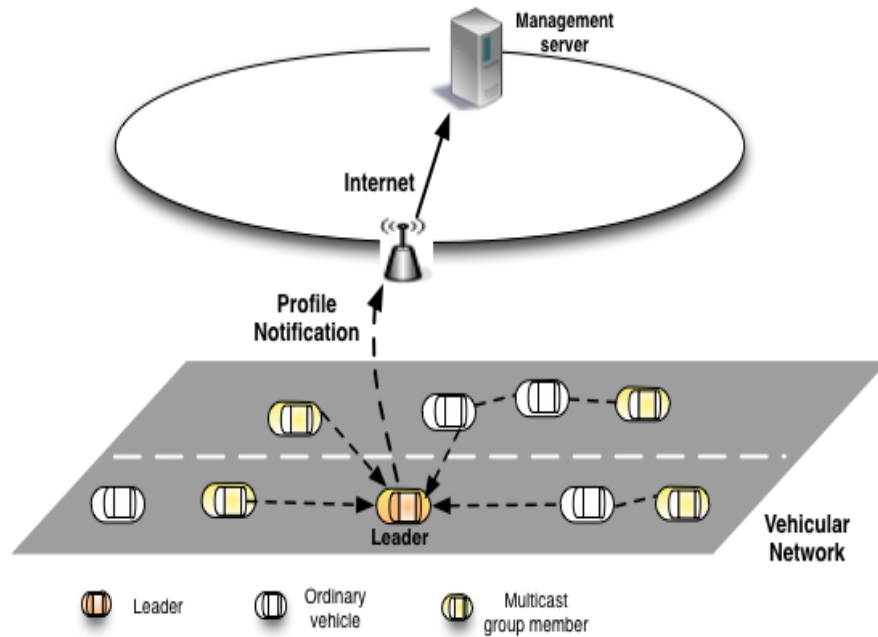

FIGURE 3.8: Multicast group management in vehicular networks

3.5.2 Internet-to-VANET Multicast Dissemination

In the proposed scheme, the HA periodically sends a Multicast Listener Query (MLQ) to the leader. The leader responds by a Multicast Listener Report (MLR) by specifying the multicast group it wants to join. It receives multicast data from the Internet (i.e., from the HA).

Figure 3.9 and 3.10 illustrates the proposed scheme for MIPv6 and PMIPv6. The difference between MIPv6 and PMIPv6 is that the leader would interact with a MAG instead of a HA.

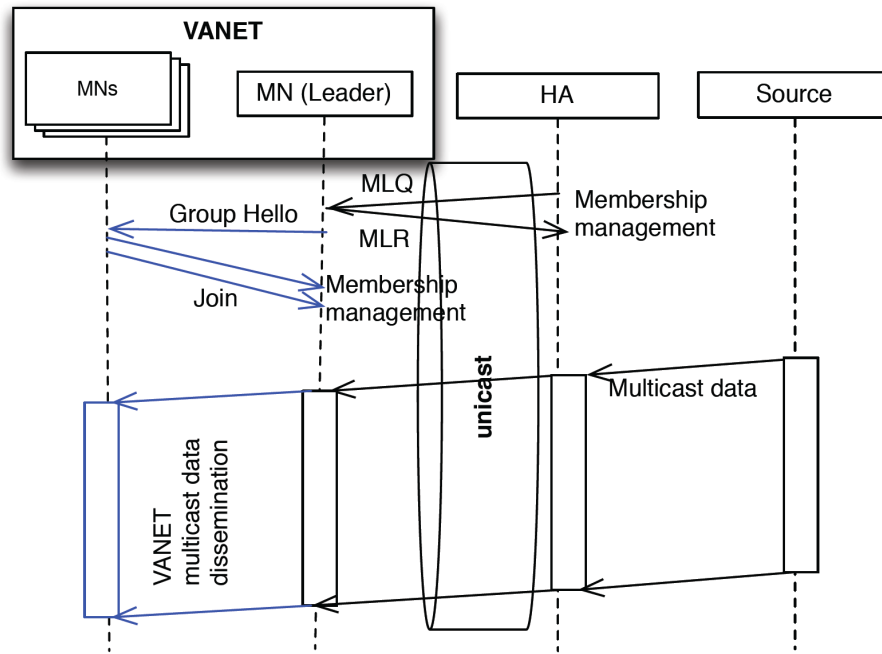

FIGURE 3.9: Extended mobility management for Internet-to-VANET dissemination in MIPv6

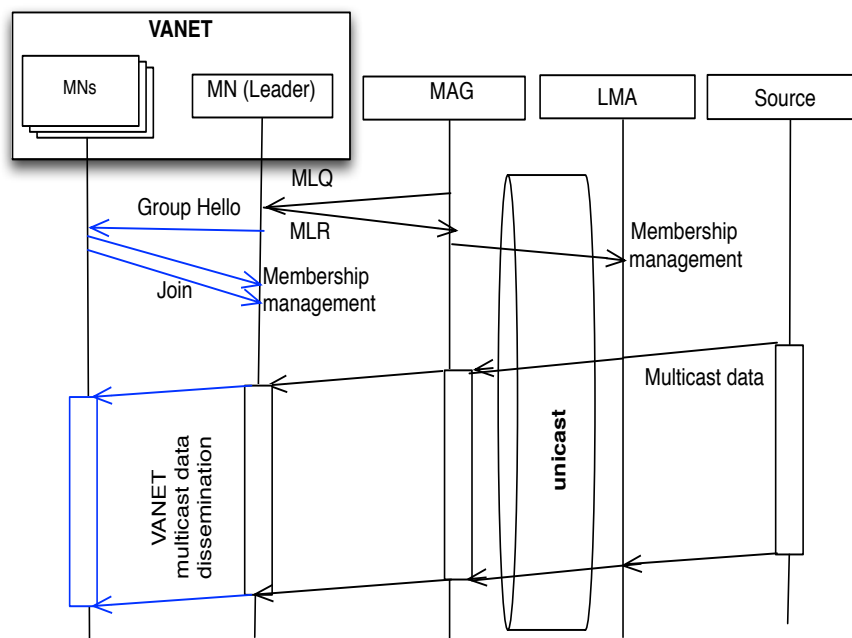

FIGURE 3.10: Extended mobility management for Internet-to-VANET dissemination in PMIPv6

Message dissemination from the Internet to the leader can be achieved following an Internet multicast routing protocol (e.g., Protocol Independent Multicast, PIM), and

the handover functionalities of MIPv6/PMIPv6 should also be applied to support the handover of the leader. Note that handover in access networks with small cell sizes (such as WLANs) is an extremely challenging task but it is not in the scope of this work. Message dissemination from the leader to the vehicles in the ad-hoc network is performed using multicast routing schemes as it will be explained in Chapter 4 and Chapter 5.

3.6 Conclusion

In this chapter we studied the problems of the address auto-configuration and the mobility management of the mobile multicast vehicles. We proposed GMAA, a geographic addressing scheme for mobile multicast members that allows vehicles to auto-configure a valid multicast address without any message exchange or frequent reconfiguration unlike in the usual schemes. GMAA was designed in the frame of the ScoreF project and integrated to the design of the ITS architecture.

In addition, we propose to extend the mobility management of MIPv6 and PMIPv6 to the multi-hop vehicular network. To this end, we proposed a multicast leader-based scheme that allows low control overhead and efficient bandwidth utilization. To extend the service coverage in VANET, Chapter 4 and Chapter 5 will detail our multicast message delivery proposal.

Résumé du Chapitre 4

Dans le Chapitre 3, on a proposé un mécanisme de gestion de la mobilité qui permet d'étendre le service Internet dans le réseau véhiculaire multi-saut tout en réduisant la signalisation requise pour la gestion des membres de groupes multicast depuis Internet. Dans ce chapitre, on étudie les performances des protocoles de routages multicast dans les VANET pour les applications de gestion de flotte de véhicules. On s'intéresse tout d'abord aux problèmes de la stabilité des liens et notamment la durée de vie des liens entre véhicules dans le réseau. A partir d'étude théorique et de simulations des durées de contacts entre véhicules dans les environnements urbains, il s'avère que la vitesse a un impact majeur sur la durée de vie des liens et par conséquent la performance des routes établies pour la dissémination des paquets. Dans la deuxième partie du chapitre, afin d'étudier les performances du routage multicast topologique, on revisite le protocole MAODV et on étudie son application aux réseaux véhiculaires dans le contexte des applications de management de flotte de véhicules. On compare ensuite les performances de MAODV, motion-MAODV qui est notre version améliorée de MAODV pour les scénarios véhiculaires et le flooding.

Chapitre 4

Mobility-Aware Multicast Routing Protocol

4.1 Introduction

In the previous chapter, we proposed a mobility management scheme that aims to reduce control overhead and to improve bandwidth utilization for Internet-to-VANET multicasting. To extend the coverage of the Internet multicast services such as the fleet management to the vehicular network, we investigate in this chapter the performance of multicast routing schemes in VANET. The performance of multicast routing depends much on the ability to keep communication links between vehicles for long durations. In this chapter, we studied first the problem of link lifetime in vehicular networks theoretically and using simulations. We find that the vehicular velocity and density impacts much the link stability. Then, in the second part, considering the applications of fleet management, we revisit a structure-based multicast protocol and study its applicability to VANET. Specifically, we study MAODV, which is a typical tree-based multicast routing protocol, and point out the issues that degrade its performance in vehicular mobile scenarios. Then, we propose an enhanced MAODV, called Motion-MAODV that is an enhanced version of MAODV in vehicular scenarios and compare the performance of both protocols and the conventional flooding.

4.2 The Link Lifetime Problem in Vehicular Networks

One of the most challenging problems in highly mobile networks is establishing and maintaining routes between nodes during the application service time. A route

is generally built between a source and a destination using intermediate nodes. It is a set of links that are established between the pairs of nodes on the route path if they are within transmission range of each other. Some studies focus on the availability of the communication opportunities in vehicular networks by defining metrics such as the *inter-contact time*, which is the time elapsed between two contacts of vehicle pairs [86][87]. Beyond the contact opportunities, we believe that the performance of the data transmission over the established route in the network is highly dependent on the lifetime duration of the links. Link breakages occur when two nodes leave the transmission range of each other, causing the whole route to fail in transmitting packets. Thus, the route lifetime duration depends on the weakest link of the whole route, as shown in [70]. Longer lifetime duration improves the network throughput as shown by [Bai and Helmy] whereas short link lifetime duration induces frequent route failures and thus leads to a degradation in the communication performance.

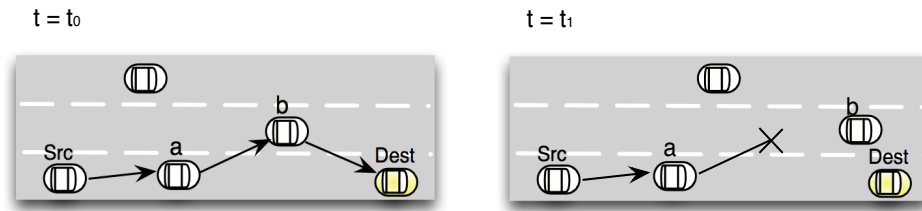

FIGURE 4.1: Link disconnections effects on the unicast data transmission

In Figure 4.1, a route is established at time $t = t_0$ between the source Src and the destination $Dest$. Nodes a and b are relaying nodes of the packets transmitted between the source and the destination. However, at time $t = t_1$, node b leaves the transmission range of node a and thus the link between a and b is broken. Consequently, the destination node $Dest$ is not reachable for the source Src via the route established at time $t = t_0$.

[20] [78] are among the first efforts that studied the impact of human mobility on the contact duration (i.e., link lifetime duration). Through empirical studies, they find that the contact duration follows a *power law* distribution. By analysing real traces of taxis in the cities of Beijing and Shanghai, [53] shows that the contact duration follows an exponential law up to a certain point in the distribution, and power law beyond that. [31] studies node connectivity which includes the contact duration by simulating a bus network in the city of London. In this work, the authors show the impact of the location of the bus stops and the road traffic patterns on the bus connectivity. Through their statistics, they also raise the issue of the feasibility of the multi-hop path which have much poorer connectivity than the single hop path. [83] studies the effects of the velocity

distribution, transmission range and traffic flow on the connectivity distance between vehicles in a highway scenario.

Link lifetime in vehicular communication is highly dependent on the traffic flow state. In highway scenarios, according to [83], from a macroscopic point of view, traffic flow is highly dependent on three parameters : the velocity of the vehicles, the density of the road and the radio transmission range.

The problem of link lifetime, even if it has been extensively studied in the literature for unicast routes, is even more important in the case of multicast routes where the source is sending a packet to several destinations at once. In particular, this is because multicast routes are built between sources and multiple receivers named multicast members. They are built in a way to efficiently share (or merge) the relaying paths between the multiple receivers. Consequently, if the route is broken due to a disruption in one link, the data is not transmitted further to the remaining members.

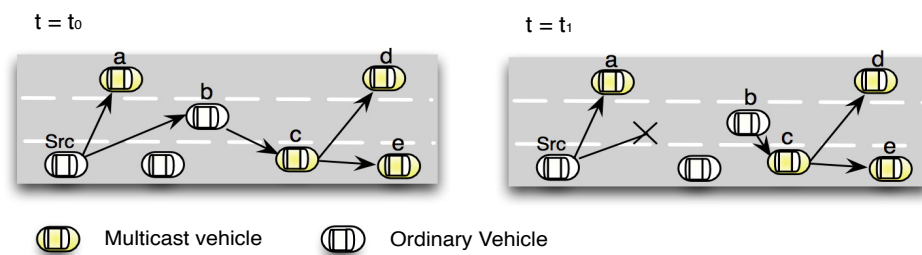

FIGURE 4.2: Link disconnection effects on multicast data transmission

Figure 4.2 illustrates the case of a link failure in a multicast transmission. The multicast route is established at time $t = t_0$ between the source *Src* and the destinations *a*, *c*, *d* and *e* which are multicast receivers. Node *b* is a relaying node between *Src* and *Dest*. At time $t = t_1$, node *b* leaves the transmission range of node *a* and thus the link between *a* and *b* is broken. Consequently, only node *a* receives the packet. Multicast receivers *c*, *d* and *e* are not able to receive the packet from the source *Src* via the route established at time $t = t_0$.

4.2.1 Route Lifetime Analytical Model

A link is established between two vehicles if and only if their Euclidean distance is not greater than their communication range R_c . In order to calculate the link lifetime, we use the common model that assumes that the velocity v of a vehicle has a Gaussian distribution. The Probability Distribution Function (PDF) and the Cumulative Distribution Function (CDF) are given by the following expressions :

$$f(v) = \frac{1}{\sigma\sqrt{2\pi}} \exp\left(\frac{-(v-\mu)^2}{2\sigma^2}\right) \quad (4.1)$$

$$F(v \leq V_0) = \frac{1}{\sigma\sqrt{2\pi}} \int_0^{V_0} \exp\left(\frac{-(v-\mu)^2}{2\sigma^2}\right) dv \quad (4.2)$$

Where μ is the mean velocity and σ^2 is the variance of the velocity v .

Let us assume that the distance between two vehicles is d . The lifetime T of the link between the two vehicles is $T = \frac{d}{\Delta v}$. Let R_c be the radius of the communication range of each vehicle in the network. Two vehicles are able to communicate if they stay within a R_c distance. If we consider the relative velocity $\Delta v = |v_1 - v_2|$ of two vehicles having velocities v_1 and v_2 , it is also normally distributed since v_1 and v_2 are also normally distributed. We then get the following expression :

$$f(\Delta v) = \frac{1}{\sigma_{\Delta v}\sqrt{2\pi}} \exp\left(\frac{-(\Delta v - \mu_{\Delta v})^2}{2\sigma_{\Delta v}^2}\right) \quad (4.3)$$

Here $\mu_{\Delta v}$ is the mean relative velocity, $\mu_{\Delta v} = |\mu_{v1} - \mu_{v2}|$ and $\sigma_{\Delta v}^2$ is the variance of the relative velocity v , $\sigma_{\Delta v}^2 = \sigma_{v1}^2 + \sigma_{v2}^2$. Then we can calculate the probability density function of the link lifetime T as follows :

$$g(T) = \frac{4R_c}{\sigma_{\Delta v}\sqrt{2\pi}} \frac{1}{T^2} \exp\left(\frac{-(\Delta v - \mu_{\Delta v})^2}{2\sigma_{\Delta v}^2}\right) \quad (4.4)$$

Let D_{ij} be the Euclidean distance between vehicle i and vehicle j . Let T_c be the predictable time during which two vehicles stay within communication range. Assuming that vehicles are not accelerating nor decelerating during T_c and that, in the case of a road with several lanes, the width of the lanes is negligible compared to the communication range of the vehicles R_c , we calculate T_c as follows :

$$D_{ij} = \sqrt{(x_i - x_j)^2 + (y_i - y_j)^2} \quad (4.5)$$

$$T_c = \frac{R_c - D_{ij}}{\Delta v_{ij}} \quad (4.6)$$

Consequently, we can calculate L_i the probability at a time t that the link will be available for a duration T_c for a vehicle i :

$$L_i = \begin{cases} \int_t^{t+T_c} g(T) dt. & \text{if } T_c > 0 \\ 0 & \text{else} \end{cases}$$

Using the *erf* function, we can calculate L_i as follows :

$$L_i = \operatorname{erf} \left[\frac{\frac{2R_c}{t} - \mu_{\Delta v}}{\sigma_{\Delta v} \sqrt{2}} \right] - \operatorname{erf} \left[\frac{\frac{2R_c}{t+T_c} - \mu_{\Delta v}}{\sigma_{\Delta v} \sqrt{2}} \right] \quad (4.7)$$

4.2.2 Simulation of the Impact of Traffic Dynamics on Neighbor Link Stability

4.2.2.1 Methodology and Link Stability Metrics

To analyse link lifetime, we will use a set of metrics introduced in [31] in a simulated urban network. Note that a node i is connected to a node j at time t if $D_{ij} \leq R_c$; where D_{ij} denotes the Euclidean distance between i and j and R_c is the communication range of the nodes. $C(i, j, t)$ is a random variable that indicates the connectivity between two nodes i and j at time t .

$$C(i, j, t) = \begin{cases} 0 & \text{if } D_{ij} > R_c \\ 1 & \text{else} \end{cases}$$

We then list the link stability metrics as follows :

1. **Number of connected vehicle pairs at time t_1** : This is the number of connected node pairs $N(i, j, t)$ that are connected in one hop at a time t_1 .

$$N(i, j, t_1) = \sum_{j=0}^N C(i, j, t_1) \quad (4.8)$$

2. **Link lifetime** : This is the period during which two nodes i and j are connected. Note that we calculate the link lifetime by observing if nodes are connected in each interval of our simulations :

$$L(i, j, t) = \sum_{t=0}^T C(i, j, t) \quad (4.9)$$

4.2.2.2 Simulation Results and Analysis

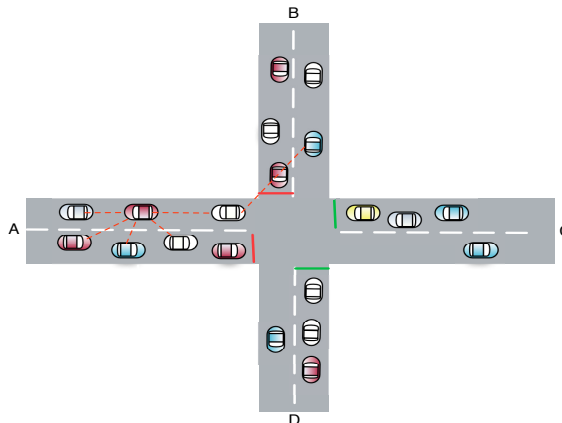

FIGURE 4.3: Intersection scenario

Simulation Settings In our simulations, we consider an urban area with an intersection as illustrated in Figure 4.12. The size of the overall area is $4000m \times 4000m$. Each road has a single forward and backward lanes. Vehicles are generated at the edge of each lane (the points A, B, C and D in Figure 4.12) following the Poisson process at the average rate λ Hz (car/second). The maximum speed, acceleration and deceleration are 50 km/h, 0.8 m/s^2 and 4.5 m/s^2 respectively. The minimum inter-vehicle distance is 2.5 m. We processed the simulation traces to extract the contact duration between the vehicles. The velocity of the vehicles is limited to 50 Km/h. Their acceleration ability is set to 0.8 m/s^2 and their deceleration ability is set to 4.5 m/s^2 . The intersection is equipped with traffic lights and so that, the vehicles stop at the intersection if necessary. At the intersection, vehicles select randomly their destination and follow the route to their destination. Consequently, vehicles dynamically control their mobility following the traffic rule as well as to avoid collisions. The total simulation time is 15 minutes.

The aim of the simulations is to evaluate the number of K-hops neighbors of randomly chosen ego nodes (vehicles), the neighborhood lifetimes, the relative directions and velocities. We define a node as a neighbor of the ego node, if the distance between the node and the ego is less than the communication range R_c . R_c is set to 300 m, with the IEEE 802.11p technology [33] in mind. The neighborhood lifetime is the period of time during which the nodes stay as neighbors. The relative direction is the angle difference between the moving directions of the neighbors. It is worth noting that in realistic scenarios, even if two vehicles are within the same communication range, they may not be able to exchange data successfully due to the wireless signal blockages and losses. In this section, since our objective is only to characterize the link lifetime between vehicle, we will not discuss the communication abilities of vehicles in exchanging data.

Simulation Results Figure 4.4 illustrates the maximum, the minimum and the average values of lifetimes for 10 randomly chosen ego vehicles. The horizontal axis is the road density, more specifically λ (the average vehicle generation rate). For each simulation, we change the value of the density, λ . As shown in the figure, the neighborhood lifetime linearly increases with the increase of the density. When the vehicular density on the road is low ($\lambda=0.04$ Hz), the maximum lifetime that we obtain is about 150 seconds, resulting in shorter neighborhood lifetimes with individual neighbors compared to those when density is higher (e.g., 650 seconds expressed by $\lambda=0.2$ Hz). The minimum neighborhood lifetime remains the same for all densities. This value is obtained when both the ego vehicle and its neighbors are moving at the maximum velocity and in opposite directions. As in the scenario, assuming that the maximum velocity is 50 km/h and the range R is 300 meters, the minimum neighborhood lifetime value can be obtained in this scenario as following :

$$\Delta t = \frac{R}{|v_{ego} - v_{neighbor}|} = \frac{0,3km}{100km/h} = 10,79sec$$

The average neighborhood lifetime drops notably compared to the maximum value of the neighborhood lifetime. The range of the average neighborhood lifetime varies from 30 seconds for a density λ of 0.04 Hz to 170 seconds for a density λ of 0.2 Hz. Those values explain that only few neighbors are kept for a long period (maximum lifetime) and that most of the contacts' durations belong to the interval [30sec,170sec]. Thus, vehicles are able to share common links with their neighbors during relatively long periods of time (i.e., neighborhood lifetime) in intersection scenarios.

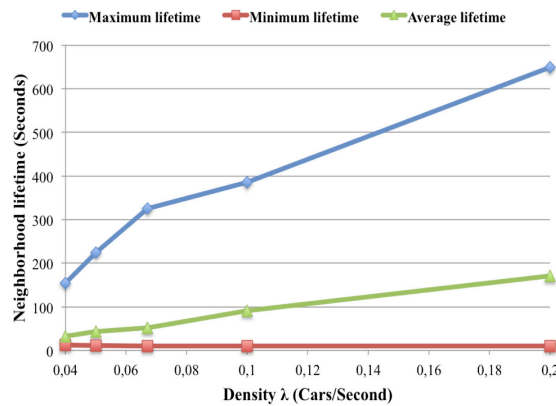

FIGURE 4.4: Variation of the maximum neighborhood lifetime with the road density

In the following, Figure 4.5, Figure 4.6 and Figure 4.7 show, respectively, the number of the neighbors, the relative direction and the relative velocity measured (w.r.t ego node) when λ is 0.1 Hz. The horizontal axis of Figure 4.5 and Figure 4.6 (corresponding

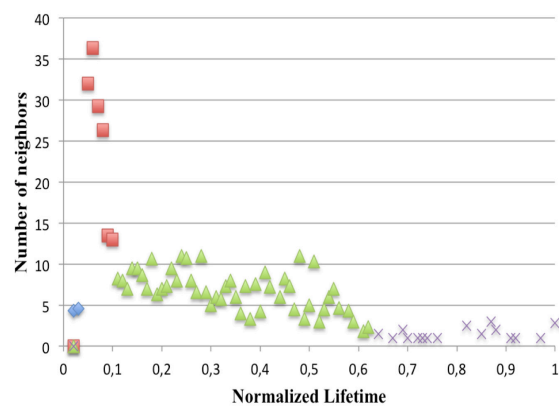

FIGURE 4.5: Average number of neighbors

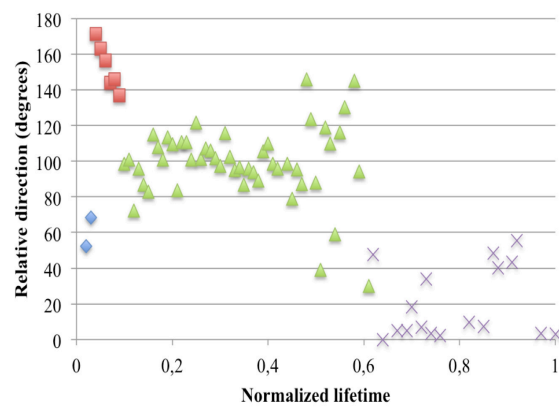

FIGURE 4.6: Neighbors' relative direction w.r.t the ego vehicle.

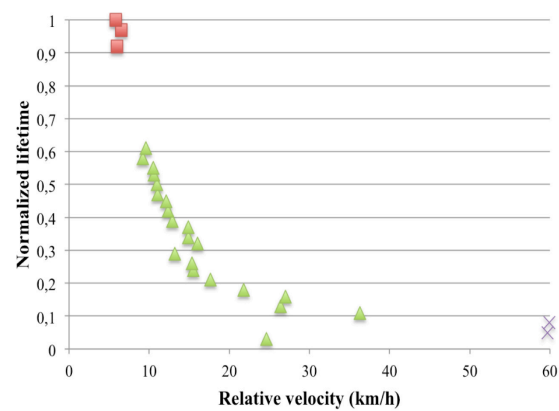

FIGURE 4.7: Neighbors' relative velocity w.r.t the ego vehicle

to the vertical axis of Figure 4.7) is the normalized neighborhood lifetime. Based on our analysis, we used different markers; both rectangular and cross markers correspond to the results obtained for straight roads whereas triangular markers correspond to the

results obtained in the intersection area.

Figure 4.5 shows that a great number of neighbors, between 35 and 15 (expressed with rectangular markers), kept less than 0.07 of the total lifetime (more precisely between 4% and 7% of the total lifetime). This explains why the average lifetime is much lower compared to the maximum lifetime in Figure 4.4. The relative direction of these neighbors, as shown in Figure 4.6 is as high as close to 180 degrees (i.e., opposite direction with the ego vehicle). Figure 4.5 also shows that the lifetime of very few neighbors (1 to 3 neighbors) is longer than 50% of the maximum neighborhood lifetime and the corresponding relative direction is at most 40 degrees (expressed with cross markers in the figures).

Our investigation shows that such extremely short or long lifetime values reflect the situations where the ego vehicle is driving on the straight road. This implies that on the straight road, the relative direction provides a major impact on the link stability. While the ego node meets a larger number of nodes, which are moving to the opposite direction, the neighborhood lifetime can be short and thus unreliable. On the other hand, while the number can be few, the neighbors, which are following the same direction as the ego node even after the intersection area, can provide stable links, and the lifetime can be especially long. Those situations correspond to a normalized lifetime of 1.

Furthermore, the neighbors which start their journey on the same road segment as the ego node but take a different direction at the intersection, gives slightly shorter lifetime (between 0.5 to 0.8) and the relative direction is higher than 0. The lifetime in the range of $[0.05, 0.08[$ (expressed with rectangular markers in the figures) corresponds to the neighbors which meet the ego node at the intersection. The relative directions of those nodes are relatively high; 80 to 160. It is interesting to observe that for those neighbors, the relative direction takes a high value for a long lifetime. Specifically, the neighbor with the relative direction $[80, 120]$ had the neighborhood lifetime of $[0.1, 0.3]$, whereas the neighbors with the relative direction 160 has neighborhood lifetime of 0.47. Finally, attention should be made to the case of lifetime neighborhood of less than 0.02 (expressed with diamond marker) that corresponds to the neighbors, which did not stop at the intersection and with whom the ego meets at the intersection. Because the neighborhood lifetime of such nodes is even shorter than those of the neighbors, which move on the opposite direction at the straight road), such nodes should be distinguished from nodes which stop at the intersection.

As a consequence, it should be mentioned that we could not find a clear relationship between the neighborhood lifetime and the direction. For this reason, we investigated the impact of the velocity (Figure 4.7) on the neighborhood lifetime duration of an ego vehicle.

Figure 4.7 illustrates the variation of the neighborhood lifetime with the neighbors' relative velocity. From the figure, we can notice that long neighborhood lifetimes (almost 100% of the lifetime) are obtained when the relative velocity is low (i.e., between 0 to 10 km/h). In contrast, it is almost less than 10% of the neighborhood lifetime when the relative velocity is 60 km/h. Those situations correspond to the scenarios where vehicles are either driving on the same direction or on opposite direction but in the same road. On the other hand, the lifetime considerably decreases and becomes almost constant for the highest relative velocity which reflects the situation where the neighborhood contact duration is low when the vehicles are moving in opposite directions. Following the observation of Figure 4.7 and Figure 4.6, it seems that keeping relatively long neighborhood lifetime does not depend much on the moving direction but more on the relative velocity. Indeed, as can be seen from Figure 4.6, at intersection, while vehicles can have large relative direction, the lifetime's duration is short.

Consequently, our current investigation of the parameters that may have impacts on the neighborhood lifetime duration in the intersection scenario leads to the conclusion that the velocity seems to have the major influence on the neighborhood link duration which agree with the theoretical expression as presented in Section 4.2.1.

4.3 Multicast Routing in Vehicular Networks

4.3.1 Background

A number of efforts towards enabling multicasting in ad-hoc networks have been previously made, especially for message dissemination [38][15]. The proposed message dissemination protocols for multicasting in ad-hoc networks can be divided into **structureless** protocols and **structure-based** protocols. As explained in Chapter 2, The structureless protocols use broadcasting techniques, where the data is disseminated in the entire network. In this approach, no knowledges about the network topology is required, each node that receives the multicast data packet rebroadcasts it on the network. In the structure-based protocols, the data is sent to only a subset of nodes (i.e., the group members) following a specific path which has usually a tree or a mesh structure.

In general, multicast protocols are known to perform significantly better in terms of forwarding efficiency and bandwidth utilization, because they are based on creation and maintenance of routing structures (tree or mesh). However, it is not clear that they perform better than broadcast approaches, in highly mobile scenarios such as those commonly found on the vehicular environments. An earlier work [47] compared the performance of the two types of schemes for MANET, and concluded that multicast

schemes perform better than broadcast approaches when the group size (i.e., the number of multicast members with regard to the total number of nodes) is small, while it is better to use a broadcast protocol in highly mobile scenarios and/or when the group size is large. The work presented in [39] compares two multicast and broadcast protocols in terms of packet retransmissions cost. It shows that the packet retransmissions is better for multicast than broadcasting when the number of the group members is small and it remains stable for broadcast, unlike in multicast, when the size of the group members increases.

However, the above mentioned study was made for MANET and targeting the random way-point mobility model, which does not represent at all the specific mobility characteristics found in VANET. Furthermore, in applications such as fleet management or POI distribution, the multicast receivers tend to move together (especially true for fleet management) and/or stay around some geographical area with low velocity (especially true for POI distribution). Considering these, in this chapter we revisit a traditional multicast routing protocol and propose necessary extensions specially designed to fit the VANET characteristics. Specifically, we consider the application of the Multicast ad hoc on-demand distance vector (MAODV) protocol [66] for VANET multicasting, and propose an extended MAODV, we call Motion-MAODV, which has additional functionalities to handle mobility dynamics of VANET.

4.3.2 Tree-based Multicast Routing

Tree-based multicast routing builds and maintains a *tree* topology between multicast nodes. A routing tree is a directed graph without cycles of \mathcal{N} nodes and $\mathcal{N}-1$ edges. A routing tree has a *root* node, a set of *relayers* nodes and a set of *receivers* \mathcal{R} , with $\mathcal{R} \leq \mathcal{N} - 1$.

A message that follows the tree structure is usually sent from the root node. It is then forwarded by the relayers (that can be also potential receivers) until it reaches the receivers located in the leaves of the tree. The objective of the tree-based routing is to optimize the packet retransmissions along the tree paths. If a path is established between a node A and a node B in the tree, only one copy of the packet is transmitted along that path as shown in Figure 4.8.

The problem of packet redundancy has a major impact especially in wireless networks, where the network resources (such as bandwidth) that are shared between several nodes are limited. For instance, in vehicular networks, the transmission performance of the safety messages, which have the highest priority on the channel should not be affected by any other traffic. Consequently building optimized routes that merge paths

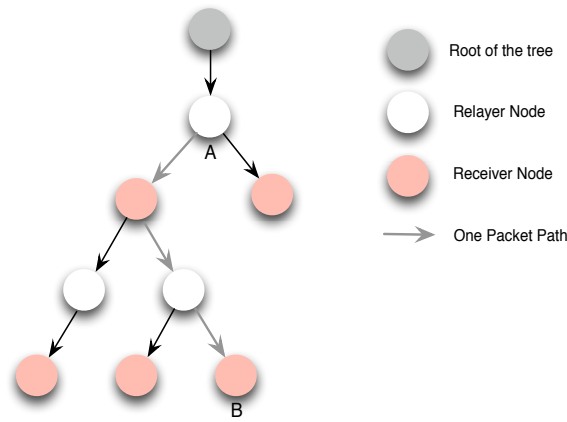

FIGURE 4.8: The tree topology in multicast routing

between several multicast receivers may reduce the network resources consumption and increase the network capacity.

Performance and stability of the tree-based routing protocols is highly dependent on the ability to increase the lifetime of the multicast routing links.

If we assume that :

- $a[i]$ is the number of the multicast receivers in the tree at level i of the tree (for instance, in figure 4.8 $a[2]=2$)
- $N = \sum_{i=1}^n a[i]$ is the total number of the receivers on the tree until level n
- p is the probability of a successful transmission of one multicast message
- P_n is the expected number of successful transmissions of the multicast message until the level n of the tree

Then, we can write :

$$P = \frac{pa[1] + p^2a[2] + p^3a[3] + \dots + p^na[n]}{N} = \frac{\sum_{i=1}^n p^i a[i]}{N} \quad (4.10)$$

To investigate the ability to keep a tree path for a long duration in realistic vehicular environments, we used a traditional multicast routing protocol; MAODV and we compare its performance against flooding.

4.3.3 Multicast Ad hoc On-Demand Distance Vector

According to MAODV, VANET nodes should maintain a multicast routing table for each multicast group with the entries of leader identity, sequence number (indicates the freshness of the information), *downstream* next hops and *upstream* next hop to the

tree and routing cost, which is the number of hops to the leader from the node. The leader of the multicast group (in our case it is the node which joined the multicast group in the Internet as explained in Chapter 3) periodically broadcasts Group Hello messages (GRPH) to announce the existence of the group.

Figure 4.11 details the MAODV membership management and route configuration procedures. If a node, say node A, wishes to join a multicast group, it sends a Join Route Request (RREQ), which will be flooded in the network. A node, say node C (it can be leader), which receives the Join RREQ, responds with a Join Route Reply (RREP), if it already has a route to the leader (i.e., node C has an entry in the routing table). The Join RREP is transmitted following the reverse path of the RREQ. A node on the reverse path, say node B, receives the Join RREP, updates its multicast routing table with the information contained in the RREP, and retransmits the RREP. If it is not the first time to receive a Join RREP, i.e., node B already has an entry on the routing table, it compares the information contained in the RREP to that of the table. Node B updates the routing table if the sequence number of the RREP is larger than that in the table or the sequence numbers are equal but the number of hops of the RREP is smaller than that in the table. Once the node updates the routing table, it retransmits the RREP. When node A receives a Join RREP, it sends a Multicast Activation Message (MACT) to node B which retransmits it to node C in order to activate the route to the multicast tree.

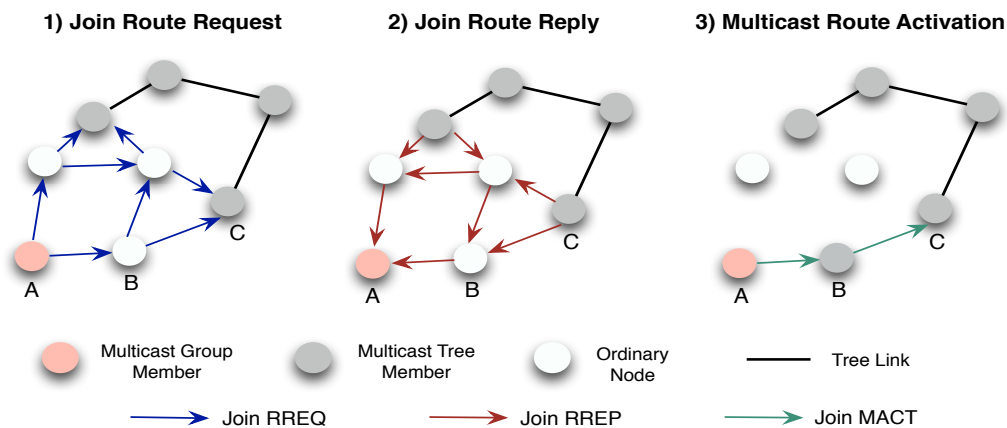

FIGURE 4.9: Maodv Operations

4.3.4 Motion-MAODV : A Tradeoff Between Routing Complexity and Delivery Efficiency in Vehicular Networks

4.3.4.1 Discussion : MAODV performance in VANET Scenarios

Route Reliability Problems One of the problems we see in MAODV is that it does not consider mobility dynamics of the network. MAODV builds routes that rely on the least number of hops to the tree. Consequently, short living links may be selected to build a route between a multicast member and the tree. Short living links may create problems in the route request/reply procedure since MAODV control messages use the unicast routing table of AODV to build the multicast path. Those routes are used or updated in the following cases :

1. When a node receives a Join RREQ, it updates the reverse path toward the originator of the RREQ.
2. When a node receives a Join RREP, it uses the unicast path to reach the originator of the RREQ.
3. When the originator of the Join RREQ receives a Join RREP and the waiting time to receive a Join RREP expires, the node uses AODV route to send a Join MACT to the node that sends originally the Join RREP.

Each unicast routing entry in the routing table contains a *route lifetime* field. *the route lifetime* is the time for which the route is considered to be valid. Since the unicast routes are used by the control messages of MAODV, the lifetime of the route serving to build the path is an important parameter that should be considered. The lifetime field is determined from the control messages (i.e, RREP) or initialized to the *ACTIVE_ROUTE_TIMEOUT*. A long lifetime value means that the links in the network are not changing frequently whereas a short lifetime value is needed when the network topology is often times changing. Since Join RREP and Join MACT are sent using reverse path routes, a non valid or an expired route may affect considerably the route establishment procedure.

Route Maintenance Problems Route maintenance procedure is performed locally, since each node in the tree has only knowledges about its upstream and its downstream interfaces. When a link to a neighbor is lost, the node sends a Route Error message to find back its neighbor. In addition to this, downstream nodes send a join RREQ to find a route to the tree. In mobility situations, since links are known to be intermittent, those messages create a lot of overhead on the channel and have major a impact on the network performance especially in dense scenarios.

4.3.4.2 Description of Motion-MAODV

In section 4.2, we showed that link stability, in terms of the lifetime of a link, sharply degrades with the increase of the relative velocity of the nodes : $\Delta t = R/|V_e - V_n|$, where R is the transmission range, V_e and V_n are the velocity vectors of the ego vehicle and its neighbor, respectively.

Our study showed that it is sufficient to express link stability with only the relative velocity between the nodes because the relative velocity has the impact of the other features, such as the moving directions and the density. Considering this, our proposed Motion-MAODV works as follows :

- Each node periodically broadcasts hello messages, which contain *the velocity* and *the positions* of the neighboring vehicles, allowing each vehicle to estimate the stability of each link.
- We define a new metric called *Route Stability* (RS_i between two nodes i and j , that calculates the cost of the route as follows :

$$RS_i = \begin{cases} 0 & \text{if leader} \\ \frac{\Delta V_{ij} + (n_{hops} - 1) * RS_j}{n_{hops}} & \text{else} \end{cases} \quad (4.11)$$

Here, ΔV_{ij} is the relative velocity of node i and node j , n_{hops} is the number of hops between node i to the leader, and RS_j is the Route Stability between node j and the leader.

- Join RREP as well as the multicast routing table include RS_i .
- Upon reception of RREPs, the node first selects n routes with smaller RS values, and then it selects the one that has the least number of hops. The node caches the RREP with its cost and retransmits it if it is a simple relay.

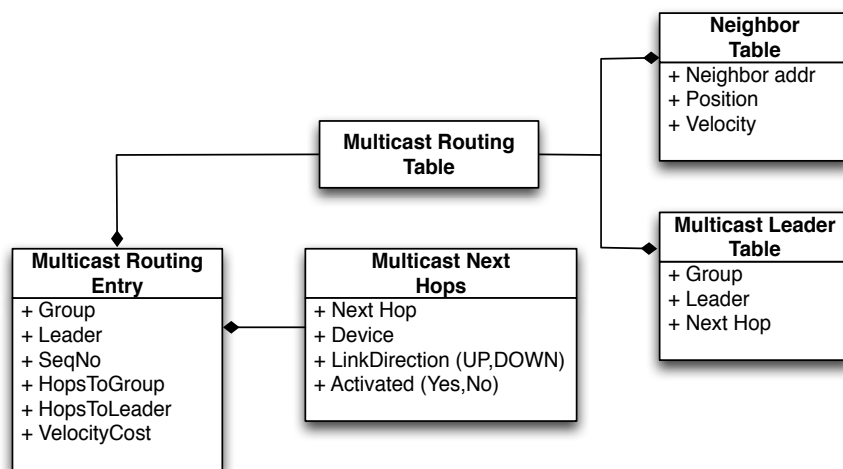

FIGURE 4.10: Motion-MAODV Routing table

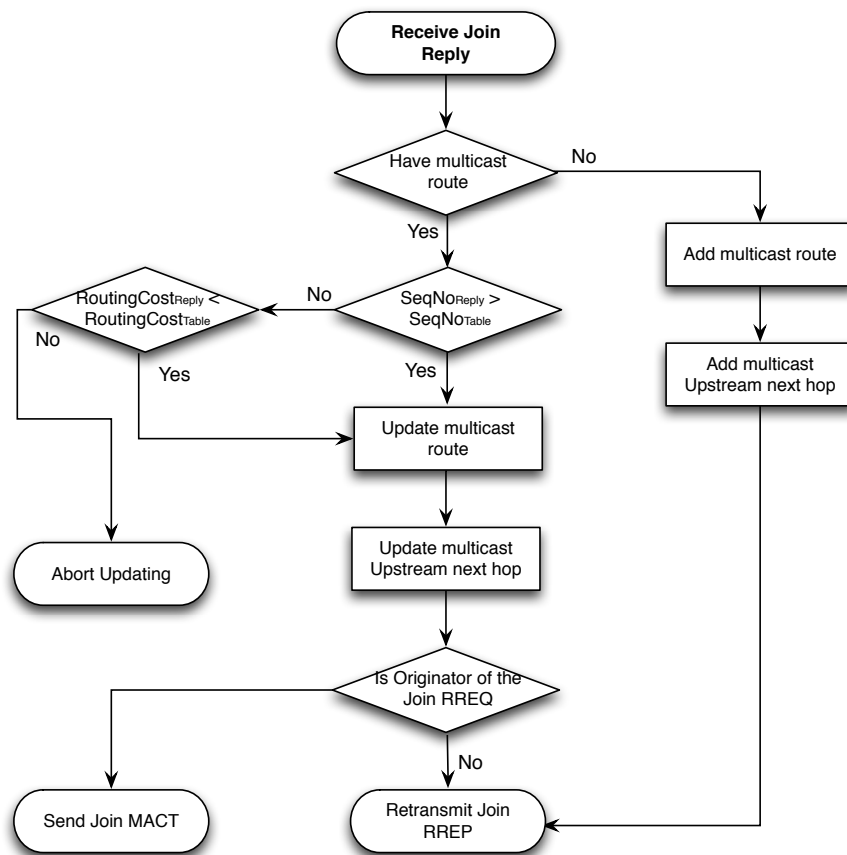

FIGURE 4.11: Join RREP Reception process in MaodvMotion

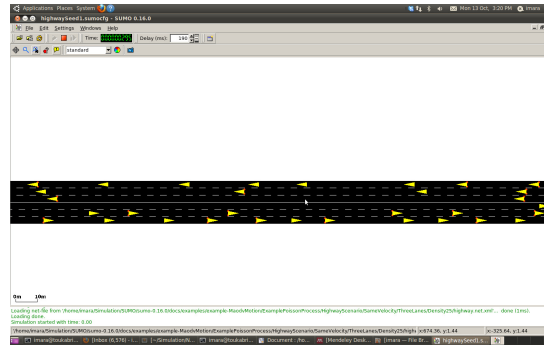

FIGURE 4.12: Simulation scenario.

4.4 Simulations and Results

4.4.1 Simulation Settings

In our simulations, the SUMO traffic simulator [SUM] is used to generate realistic vehicular mobility traces. More specifically, we simulated a highway scenario illustrated by Figure 4.12. The overall length of the road is of 2 kilometers. The road has multiple forward and backward lanes. The maximum velocity of vehicles is limited to 50km/h. The acceleration and deceleration values of the vehicles are set to 0.8 m/s^2 and 4.5 m/s^2 , respectively, and the minimum inter-vehicle distance is of 2.5 meters. Vehicles are generated at the edge of each lane following the Poisson process at the average rate λ (in terms of vehicles/second). For each generation rate, we perform 10 simulation runs, and each simulation run lasts for 100 seconds.

More specifically, the average generation rate λ is varied along the simulations. Additionally, the simulations are carried out for different numbers of backward and forward lanes (i.e, one, two, and three lanes per direction). Having the fleet management application in mind, the multicast members including the leader node reside on the forward lane, and the members join the multicast group at random points of time before the multicast data transmission starts. Regarding vehicle-to-vehicle (V2V) communications, we follow the IEEE 802.11p standard [33], and the maximum communication range considered was around 300 meters. Table 5.1 summarizes the settings of our simulations.

In order to correctly assess our approach, we added to the ns-3 [NS3] simulator both our Motion-MAODV, and the MAODV protocol, following the specification of the IETF [65]. Then, we evaluated the performance of the three protocols : (i) our proposed Motion-MAODV, (ii) the MAODV, and (iii) the traditional flooding approach. For MAODV and Motion-MAODV we used the parameters values as shown in table 4.2.

TABLE 4.1: Simulation settings

Simulation Parameter	Value
Simulation scenario	Highway
Simulation time	100 sec
Road length	2000 m
Number of lanes	6 lanes
Number of nodes per 1km	10-95
Communication range	about 300 m
Propagation model	Log Distance
Channel Bandwidth	6 Mbps

TABLE 4.2: MAODV/Motion-MAODV settings

Protocol Parameter	Description	Value
HelloInterval	HELLO messages emission interval	1 second
AllowedHelloLoss	Number of hello messages which may be lost for valid link	3
JoinRequestTimeout	Time during which a route requester wait for the reply	3 seconds
RreqRetries	Maximum number of retransmissions of RREQ to discover a route	1
ActiveRouteTimeout	Period of time during which the route is considered to be valid	3 seconds
GroupHelloInterval	GROUP HELLO messages emission interval	5 seconds

4.4.2 Comparison of MAODV, Motion-MAODV and Flooding

we compared MAODV, Motion-MAODV and Flooding in terms of packet delivery ratio (PDR), throughput and end-to-end transmission delay.

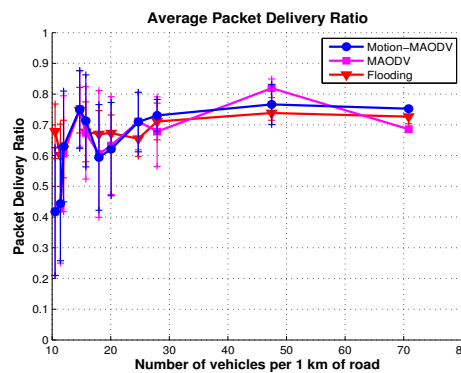

FIGURE 4.13: Average Packet Delivery Ratio of MAODV, Motion-MAODV and Flooding

Figure 4.13 shows the PDR of the three protocols when varying the vehicle density (in terms of number of vehicles per one kilometre of road). As shown in the figure,

when the vehicle density decreases (i.e., the inter-vehicle distance per lane increases), the PDR obtained by MAODV and Motion-MAODV also decreases while it remains relatively constant for the flooding. Indeed, when the network is not connected, the route choice in MAODV and Motion-MAODV is limited. The route in both MAODV and Motion-MAODV is built relying on the existent vehicles even if the link lasts for short period. In relatively dense scenarios, the PDR of MAODV and Motion-MAODV increases. This is due to the fact that higher densities ensure the connectivity of the network. In such situations, the multicast member that requests a route receives several Join RREP in both MAODV and Motion-MAODV. Consequently, a reliable route is built which increase the packet delivery ratio and accordingly the throughput (as shown in figure 4.14). As for dense scenarios, our Motion-MAODV performs better than MAODV. MAODV rely on the number of hops to deliver the packets while Motion-MAODV selects the most reliable routes that guaranties stable low relative velocity cost and thus stable links.

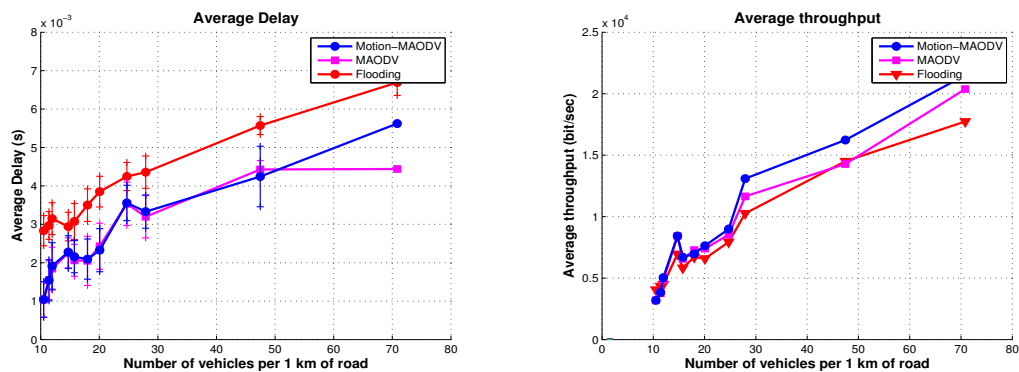

FIGURE 4.14: Average Delay and throughput of MAODV, Motion-MAODV and Flooding

Figure 4.14 illustrates the measurements of the delay and the throughput. The delay in MAODV, Motion-MAODV and Flooding increases with the increase of the density in the network. It should be mentioned that flooding presents higher delays compared to MAODV and Motion-MAODV. Redundant packets in flooding are transmitted over several paths which implies contention and packet collisions caused by simultaneous forwarding. Consequently, the packets arrive to the destination with higher delay compared to the structure-based routing (i.e., MAODV and Motion-MAODV) where the packets are delivered only over the multicast tree, thereby reducing the redundant retransmissions and optimizing the transmission delays.

4.4.3 Evaluation of the Joining Success Rate

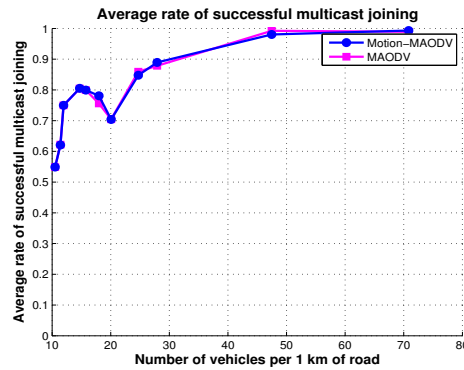

FIGURE 4.15: Average Successful Join Rate of MAODV and Motion-MAODV

Figure 4.15 illustrates the joining success rate which is the ratio of the number of vehicles that were able to join the group and the total number of vehicles that are supposed to join the group. This ratio presents also the percentage of multicast joining failures. As shown in Figure 4.15, when the network is scarce, only 60% to 70% of the multicast members could join the multicast group. Usually, they are members that reside near to the leader in terms of distance and number of hops. More multicast members are distant from the root of the tree (i.e., the leader), the less they have a chance to join the tree in scarce scenario. On the other side, when the network is dense, the success joining is about 100%, which means that all the members are able to establish a path to the multicast tree. MAODV and Motion-MAODV perform similar in term of success join rate because both of them try to find a route to the tree and build it, the difference is that MAODV relies on the number of hops while Motion-MAODV takes the velocity of the vehicles into consideration.

4.4.4 Evaluation of the link lifetime on the tree

Figure 4.16 show the number of established links and broken links in the tree during the simulation. As depicted in the figure, the number of established links is same in MAODV and Motion-MAODV. This is due to the maintenance process where nodes trigger a join request when a link breaks to rebuild the route. Although the number of established links is same in both protocols, links are broken more often in MAODV compared to Motion-MAODV.

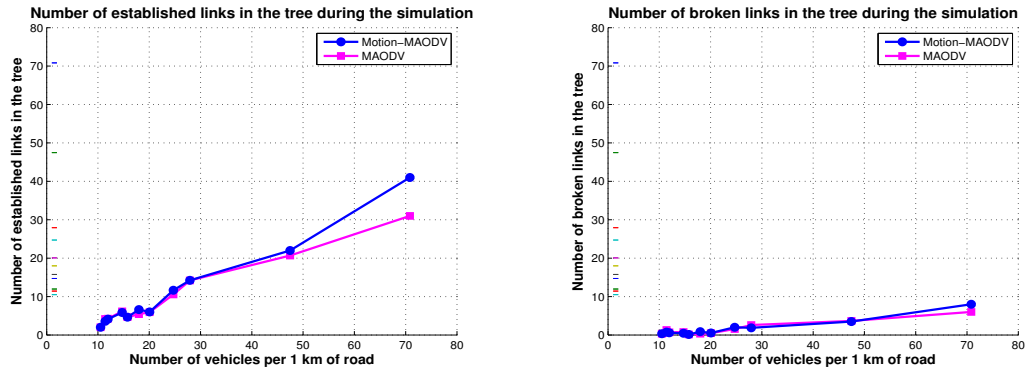

FIGURE 4.16: Number of Established and broken links in the tree during the simulation

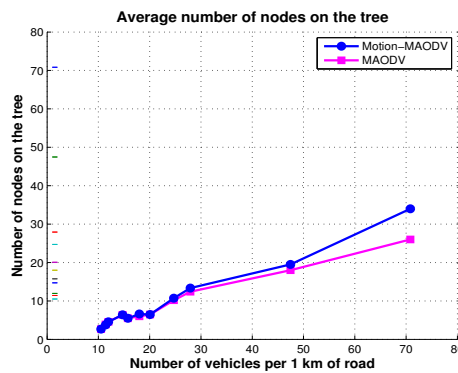

FIGURE 4.17: Average number of nodes on the tree in MAODV and Motion-MAODV

4.5 Conclusion

In this chapter, we investigated first the link lifetime problem in vehicular networks theoretically and using simulations of a realistic urban scenario. We find that the velocity is the major factor that influences the link lifetime in vehicular scenarios. Through extensive simulations, we investigated the performance of MAODV, Motion-MAODV and flooding and show that the tree-based routing present relatively good performance compared to flooding. Simulation results show also that Motion-MAODV showed better link stability than MAODV (mainly in terms of number of established and broken links in the tree). In next chapter, we will present Melody, a geocast routing protocol that enhance geographic broadcast especially in highly dense scenarios.

Résumé du Chapitre 5

Dans ce chapitre, on s'intéresse aux problèmes de la dissémination multicast géolocalisée dans les réseaux véhiculaires et notamment dans les scénarios urbains à forte densité. On introduit Melody, un protocole de géocast qui a pour objectif de réduire le nombre de retransmissions sur le lien tout en assurant la fiabilité de la dissémination des paquets de données multicast. Melody utilise une approche simple qui consiste à utiliser du routage opportuniste tout en choisissant les meilleur relais sur le chemin.

Chapitre 5

Toward a Reliable Geocast Delivery in Urban Vehicular Networks

5.1 Introduction

In this chapter, we tackle the problems of geocast dissemination in highly dense urban scenarios. We propose Melody, a geocast routing protocol, that uses an opportunistic approach to send packets to multicast receivers which are located in a given geographic area.

First, we introduce the preliminary scenario of geocast in vehicular networks and explain the problem statement in Section 5.2. Then, we detail the operations of Melody in urban scenarios in Section 5.3. Finally, we present our performance evaluation, comparing Melody and geographic Flooding in Section 5.4.

5.2 Preliminaries

5.2.1 Scenario Overview

We assume that data messages come from the Internet to an urban area through Road Side Units that are deployed on a city scale. Information sent from the Internet can be of several types concerning, for instance a congested area, an advertisement of a new restaurant or information about parking facilities in the surrounding area of the RSU.

The scenario is depicted in Figure 5.1. When an RSU receives the information, it sends it to close vehicles that are one-hop away from it. To extend the information to the destination area, the vehicular network has to spread it and has to inform the multicast vehicles that are subscribed to the services concerned. The vehicles use the mechanism detailed in Chapter 3 to auto-configure a valid address that has a geographic scope. Only multicast vehicles that reside in the geographic area of the destination (there could be several destination areas) need to be informed.

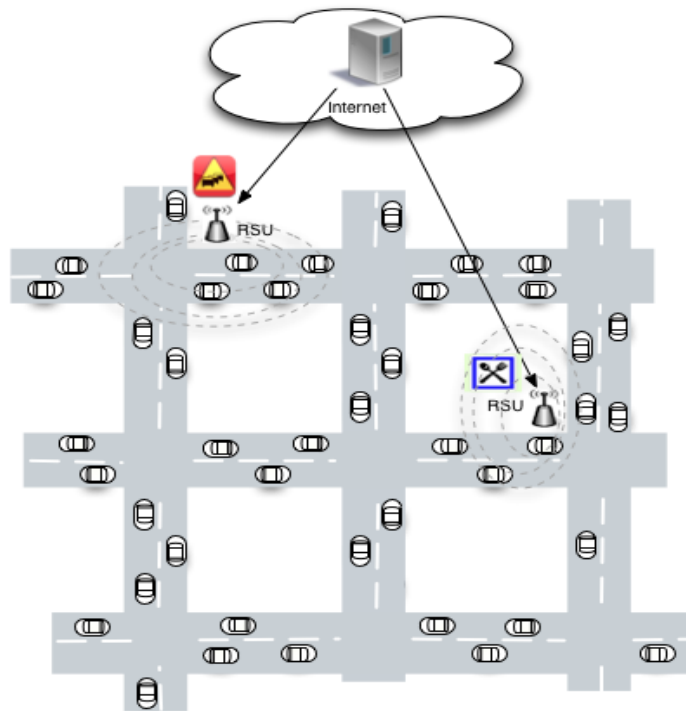

FIGURE 5.1: Background

5.2.2 Problem Statement

Traditional MANET geocasting protocols such as LBM [45] and GeoGrid [84] protocols rely on flooding techniques to relay and disseminate a message to a given area [56]. However, MANET applications such as sensor networks impose a different network structure compared to vehicular networks and this particularly true particular in urban areas. In fact, vehicles are mostly moving in close proximity to each other creating a dense and compact topology. This usually results in sharing the same communication medium between all the nodes. This may lead to a massive packet redundancy on the network, which increases the overhead and bandwidth consumption, and can even result in high packet collisions.

On contrast, opportunistic routing has been proposed to improve packet delivery and increase the throughput in the network. Opportunistic routing exploits the broadcast nature of the wireless transmissions. It allows any node that overhears the packet and that is close to the destination to participate in forwarding the packet and thus reduce the number of retransmissions. However, it introduces an additional challenge because multiple forwarding nodes have to coordinate themselves to allow only one node to forward the packet. The challenge is even greater in the case of a multicast transmission, where the destination is several nodes. Coordination between relay nodes in this case becomes difficult and may lead to wrong decisions that considerably affect the reliability of packet delivery. In this chapter, we introduce Melody, a geocast routing protocol that uses opportunistic routing techniques to transmit multicast packets over an overlay path.

5.3 Melody Description

Figure 5.4 shows the overlay path built between the source and all the multicast receivers. The path is composed of a set of relays that are chosen for each data packet transmission. When a relay receives a data packet, two possibilities exist :

- it checks if it has multicast neighbors in its neighbor table and, if so, sends a multicast packet to them. Then, it chooses the best relay that matches the selection criteria and unicasts to it the packet.
- Only one transmission of the packet is used. The packet is multicast on the link with an explicit indication of the next relay.

5.3.1 Neighbor Discovery

In Melody, each vehicle in the network has to maintain a list of its neighbors. For this, each vehicle periodically broadcasts *Hello* messages on the link with a transmission frequency of one second. Within the Hello messages, each node on the network informs other nodes about its position, velocity, its *connectivity degree* and whether it belongs to a multicast group or not. The connectivity degree is the number of neighbors of the node at the time of sending the Hello packet. Including the information about the membership in the Hello packet (the multicast flag M in Figure 5.2) avoids sending other control messages through which the node announces its membership in the entire network. Only neighbors of multicast members are aware of their existence on the link.

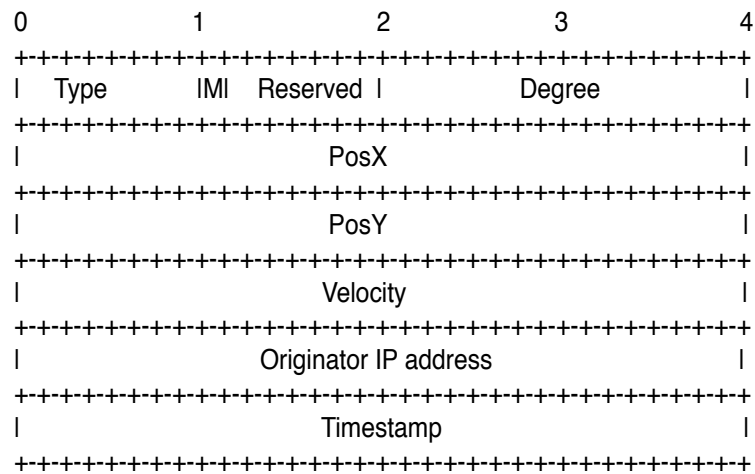

FIGURE 5.2: Melody Hello packet

5.3.2 Relaying Phase

During the relaying phase, a node selects a packet relay from its neighbor table to deliver the packet to the destination area. The packet is sent to the relay that is closest to the center of the destination area. The node whose position is nearest to the area and which has a maximum number of neighbors is chosen. Choosing the forwarder that is well connected to the other nodes offers robustness during the relaying phase. The delivery of the packets is more certain in this case. It should be noted that since Melody targets urban scenarios, the destination area may be a set of road segments. In this case, Melody calculates the shortest path from the road map to the *splitting junction* where the packet is sent to more than one relay. Figures 5.3 and 5.4 show respectively the physical and the logical view of Melody. Figure 5.3 illustrates the two destination areas where the data has to be disseminated from the source (here the RSU) to multicast subscribers. Figure 5.4 shows the overlay path built between the source and the multicast receivers to disseminate the packets in both road segments.

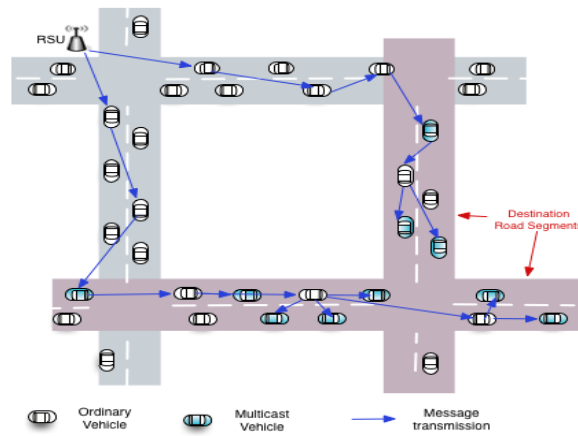

FIGURE 5.3: Urban geographic dissemination Scenario

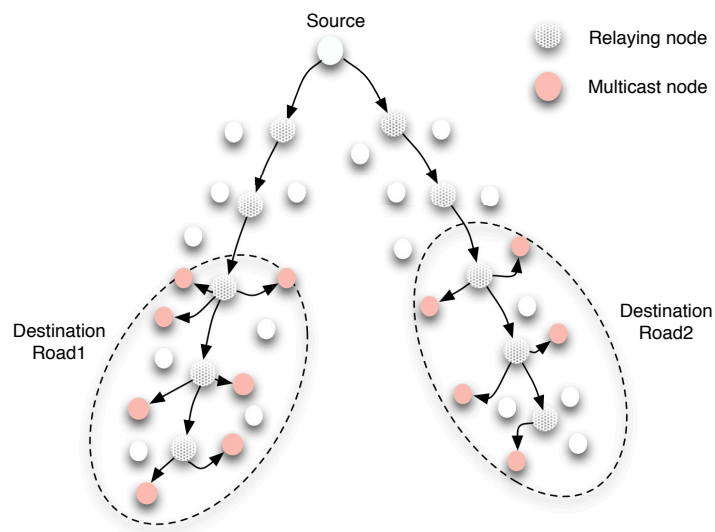

FIGURE 5.4: Melody Overlay view

5.3.3 Dissemination Phase

Once the packet reaches the destination area, it is delivered to all the vehicles that are multicast members and which reside in the geographical area. In the dissemination phase, the same method as the multicast relaying phase is used. An additional transmission is employed in order to send the packets to the multicast members that already announced themselves in the hello messages. The relays check if they have multicast members in the neighbor table and, if it is the case, they transmit and they include the multicast address in the packet when they send it to the relay nodes. As the multicast delivery uses unicast, it is reliable because it takes advantages of the acknowledgement

mechanism performed in the MAC layer, which is absent from the usual broadcast or the pure multicast transmission.

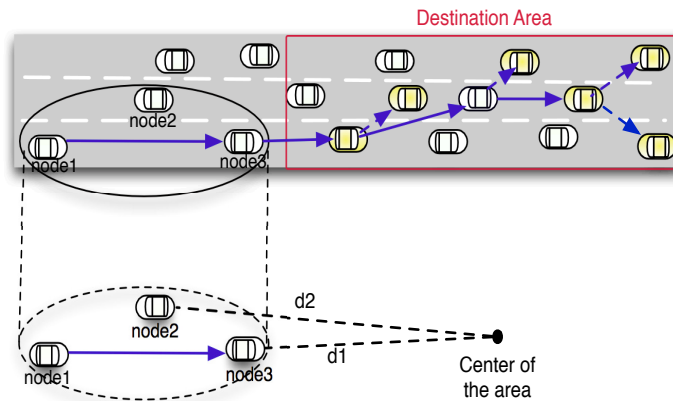

FIGURE 5.5: Melody relaying phase

5.4 Performance evaluation

5.4.1 Simulation Settings



FIGURE 5.6: Melody simulation scenario

In our simulations, the SUMO traffic simulator [SUM] was used to generate realistic vehicular mobility traces. We simulated a Manhattan grid scenario as illustrated in Figure 5.6. The area length of the road is 2000×1500 . The road has two lanes. The maximum velocity of the vehicles is limited to 50km/h. The acceleration and deceleration values of the vehicles are set to 0.8 m/s^2 and 4.5 m/s^2 , respectively, and the minimum inter-vehicle distance is 2.5 meters. Vehicles are generated in the grid following the Poisson process at the average rate λ (in terms of vehicles/second). More specifically, the

average generation rate λ varied during the simulations. The multicast members reside in the destination area. Regarding vehicle-to-vehicle (V2V) communications, it follows the IEEE 802.11p standard [33], and the maximum communication range considered was around 300 meters. For each generation rate, we performed 10 simulation runs, and each simulation run lasted for 100 seconds. Table 5.1 summarizes the settings of our simulations.

TABLE 5.1: Simulation settings

Simulation Parameter	Value
Simulation scenario	urban (Manhattan Grid)
Simulation time	100 sec
Area size	$2000m \times 1500m$
Packet size	512 bytes
Number of lanes	2 lanes
Vehicles' generation rate λ	$\frac{1}{15} - \frac{1}{10} - \frac{1}{5} - 1$
Number of simulated vehicles in the entire area	160 - 248 - 538 - 817
Communication range	about 300 m
Propagation model	Log Distance
Channel bandwidth	6 Mbps

5.4.2 Simulation Results

Melody was implemented in the NS3 simulator. It was compared to the geographic Flooding approach for relatively high density scenarios. The scenarios simulate an urban area in the rush hour where the number of vehicles is extremely high. We compare two-variants of Melody with geographic Flooding in terms of packet Delivery Ratio (PDR), End-to-End delay, packet retransmissions and number of hops.

5.4.2.1 Packet Delivery Ratio

Figure 5.7 presents the results of Melody using a multicast relay path, Melody using a unicast relay path and geographic Flooding. As shown in the figure, both variants of Melody perform better than flooding for all the density scenarios. For the lowest densities, the two variants of Melody reach 100% packet delivery while Flooding has a low delivery success (about 40%). Melody using a unicast relay path performs slightly better than Melody that uses a multicast path. This is because the unicast transmission ensures greater reliability compared to the broadcast-type of transmission. Unicast transmission requires acknowledgement at the MAC layer when a packet is lost. The PDR in Melody relying on a unicast path and Melody relying on a multicast path decreases at a certain

density (density 538 in Figure 5.7). As a result, Melody is sensitive to very high dense scenarios.

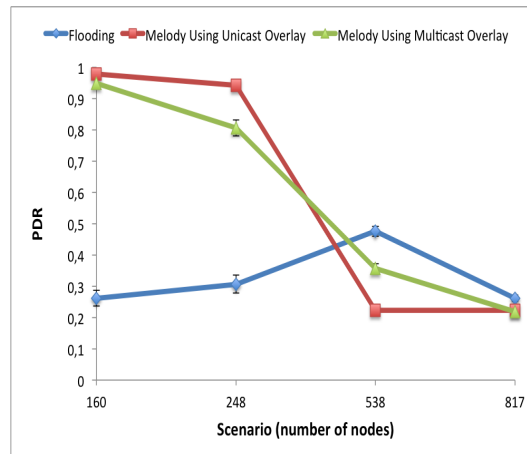

FIGURE 5.7: Packet Delivery Ratio of Melody compared to geographic Flooding

Figure 5.8, Figure 5.9 and Figure 5.10 show the result obtained when we change the rate of the multicast receivers in the geographic area for different densities (Here in the graph it is expressed in generation rate λ). Note that the rate 1 does not mean necessarily all the vehicles in the geographic area but the set of vehicles that reside in the geographic area during the period of the data transmission. The results show clearly that the PDR of the geographic flooding is low for all the multicast receivers' rate. However, for both variants of Melody, it is relatively high when the density of the network is low and drops considerably when the density of the network is high. As shown in the figure, the rate of the receivers has not a remarkable impact on the PDR. This is because the number of packet retransmissions is independent from the number of multicast receivers in the network. Consequently, for a given density, the path followed by one packet would be the same whatever the value of the number of multicast receivers.

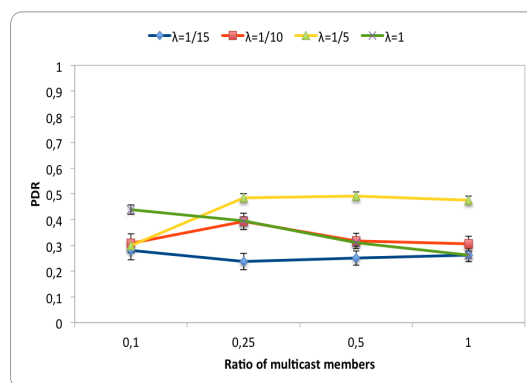

FIGURE 5.8: Packet Delivery Ratio of geographic Flooding per multicast receivers' rate

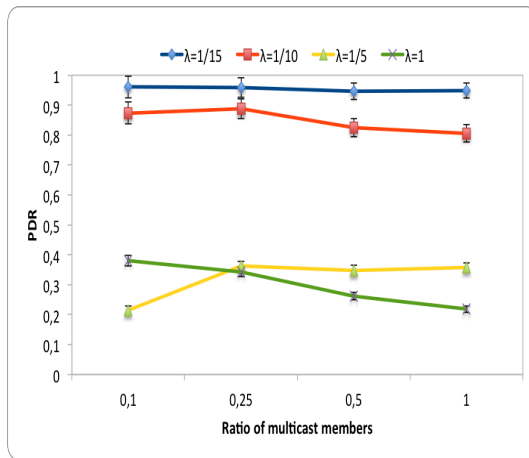

FIGURE 5.9: Packet Delivery Ratio of Melody using Multicast relay path

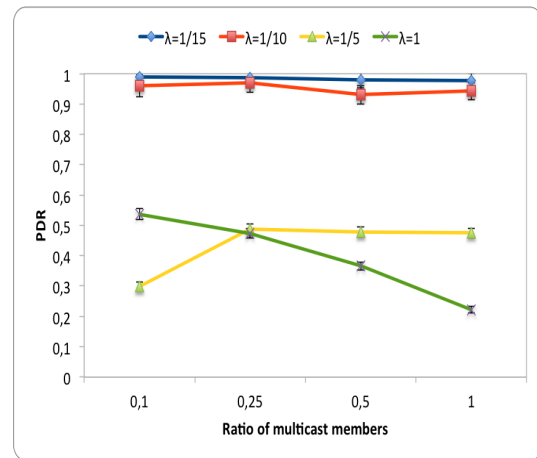

FIGURE 5.10: Packet Delivery Ratio of Melody using Unicast relay path

5.4.2.2 Packet End-to-End Delay

Figure 5.11 shows the performance concerning the delay. While the two variants of Melody guarantee low delays for all receivers in all the densities (0.01s to 0.05 s), delays in Flooding increase considerably in high density scenarios and change the scale (from milliseconds to seconds). In fact, in high density scenarios, due to the excessive redundancy of the packets, which leads to high channel occupancy, the packets are buffered for a long time before being released on the channel, and this results in long end-to-end delays.

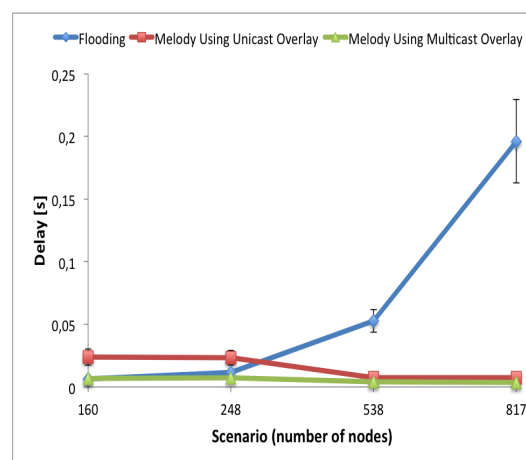

FIGURE 5.11: End-to-End Delay of Melody compared to Flooding

5.4.2.3 Packet Retransmission

As shown in Figure 5.12 and Figure 5.13, packet retransmission in geographic Flooding increases considerably with the increase of density in the network compared to Melody. Both variants of Melody limit the number of retransmission of the packets on the channel. Reducing packet retransmissions in Melody through the relay path ensures their delivery even for nodes that are geographically located far from the source. In addition, Flooding suffers from multiple packet retransmissions, which causes channel collisions. Melody using Multicast relay path present better results than Melody using a unicast path which uses an additional transmission in unicast to select the relay.

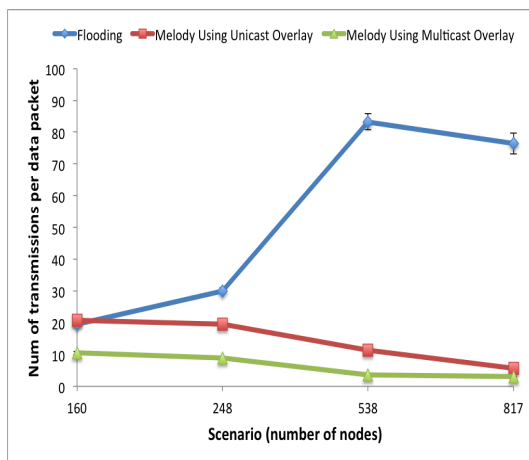

FIGURE 5.12: Number of packet transmissions

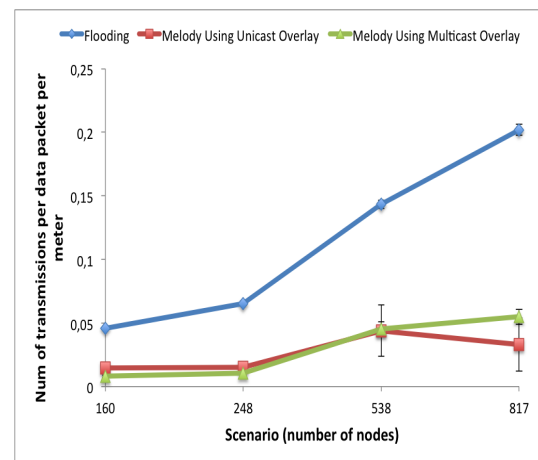

FIGURE 5.13: Number of packet transmissions per Meter

5.4.2.4 Performance Evaluation per Sub-zone

To evaluate the dissemination performance in the geographic area, we divide the area into small zones with equal length. Then we measure the number of hops required to deliver multicast packets to the multicast receivers located in the zone as shown in Figure 5.14.

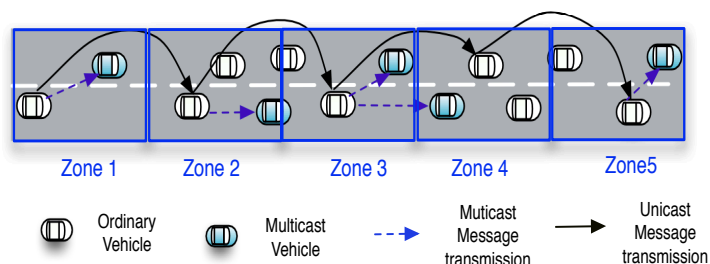

FIGURE 5.14: Partitioning of destination area into sub-zones

Figure 5.15 and Figure 5.16 illustrate the number of hops required by the two variants of Melody and geographic Flooding to disseminate the multicast packets over the sub-zones that we defined. In the figure, we can see that Flooding requires less number of hops compared to Melody to reach the destination sub-zone. However, Flooding presents low PDR in the sub-zones that are far from the source as illustrated by Figure 5.17 and Figure 5.18 for respective densities $\lambda = \frac{1}{10}$ and $\lambda = \frac{1}{15}$. On contrast, Melody presents high PDR even for sub-zone 4 and 5 (which are furthest sub-zones from the source) and in particular for the unicast relay approach. Through the relay based approach, multicast transmission ensures robustness of the packet delivery and achieves a successful delivery even for distant geographic zones.

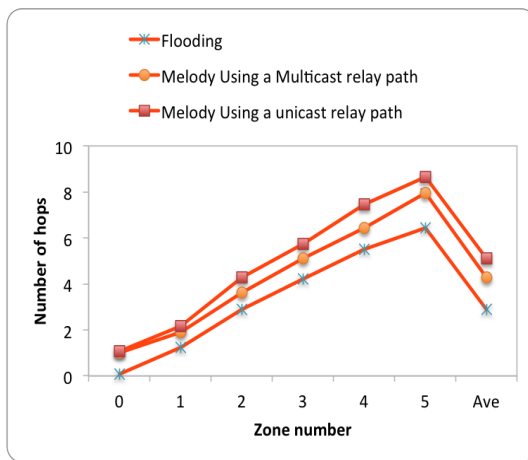

FIGURE 5.15: Number of hops relaying the message to the destinations for $\lambda = \frac{1}{10}$

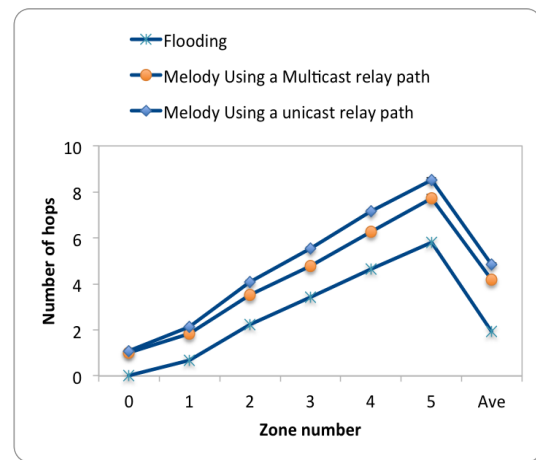

FIGURE 5.16: Number of hops relaying the message to the destinations for $\lambda = \frac{1}{15}$

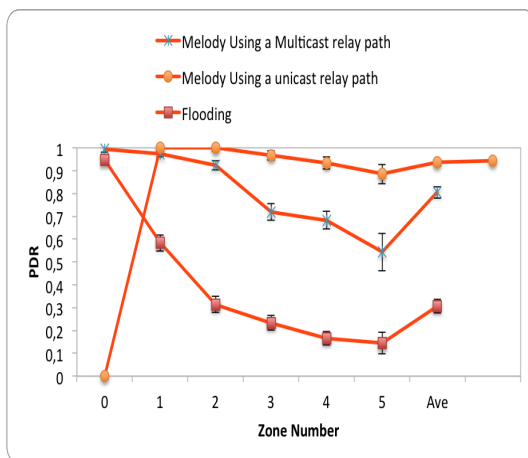

FIGURE 5.17: Packet Delivery Ratio per sub-zone for $\lambda = \frac{1}{10}$

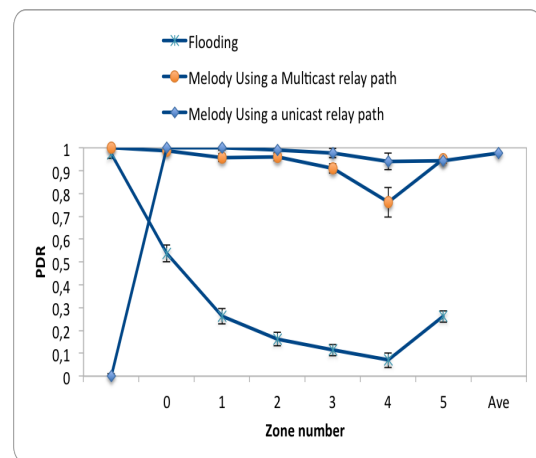

FIGURE 5.18: Packet Delivery Ratio per sub-zone for $\lambda = \frac{1}{15}$

5.5 Conclusion

In this chapter, we introduced Melody, a reliable geocast routing protocol whose aim is to reduce the overhead normally incurred by conventional broadcasting protocols and achieve greater reliability. Melody introduces two approaches. The first one exploits the reliability of the unicast transmission to relay and disseminate multicast packets in the destination area, and the second one reduces the number of retransmissions on the link. Through extensive simulations, we show that Melody achieves better results compared to geographic Flooding, but is still sensitive to very high density scenarios. Consequently, further improvements could be carried out to achieve greater robustness in highly dense urban scenarios.

Chapitre 6

Conclusion

6.1 Conclusion

Developing Intelligent Transportation Systems (ITS) involves integrating high technologies in both vehicles and road infrastructures. In the near future, road users in both urban and highway areas will be able to use wireless devices to improve road safety, increase traffic-flow efficiency and enhance road users' comfort. In this research, we focused on emerging applications for road efficiency and value added services. In particular, we were interested in fleet management and Point Of Interest distribution services. Fleet management, such as route guidance for a fleet of vehicles, often requires a control/service center in the Internet to provide information to a set of vehicles. POI distribution services aim to inform drivers and passengers about specific location points (e.g., parking lots, restaurants, or other facilities), which may be of interest or use to road users in the area.

Both applications require one-to-many communications, also referred to as group communications. So far, multicasting approaches have proved to be effective for supporting group communication in traditional networks. However, providing such Internet-to-VANET multicast service involves several challenges. In this PhD work, we were mainly interested in studying Internet-to-Vehicles service access and message delivery in vehicular networks.

We first introduced the context of vehicular networks with a focus on the important aspects of recent research in the field. We specifically presented the ITS communication architecture which replaces the standard TCP/IP communication stack, which is not suitable for the requirements of ITS communication and we presented the projects that have carried out over the last fifteen years to develop ITS communications. Then, we

outlined the main applications developed for vehicular communications in general and in particular we explained the requirements and characteristics of the fleet management and the POI categories. The review of the related work helped us to establish the background of our study and to understand the main techniques used for multicasting in the Internet and in vehicular networks.

First, to enable multicast communications between the Internet and a multi-hop vehicular network, we proposed a geographic addressing framework, GMAA (Geographic Multicast Address Auto-configuration), which allows the vehicles to auto-configure a dynamic geographic address without any need of signaling traffic. Second, we proposed a scheme that combines an existing multicast mobility management scheme with vehicular networking solutions to achieve Internet-to-VANET multicasting. The proposed scheme aims to provide multicast mobility management with low control overhead and efficient bandwidth utilization, as well as extend the service coverage provided by VANET membership management and multicast message delivery.

Bearing the fleet management application in mind, we investigated the issue of maintaining links between vehicles and, specifically, the impact of urban traffic dynamics on link stability. Our study shows that in urban scenarios the link can be sufficiently stable. Consequently, we revisited traditional multicast routing, which builds and maintains a routing structure between the multicast receivers. More precisely, we studied the application of the Multicast Adhoc On Demand Distance Vector MAODV protocol in vehicular multicast routing and compared it to the flooding approach. Simulation results show that structure-based multicast performs well in vehicular networks and ensures reliable and efficient packet delivery.

For POI applications, we proposed Melody, a geocast routing protocol which targets highly dense urban scenarios. Melody uses an opportunistic approach to send packets to multicast receivers that are subscribed to the service and are located within given geographic area. Melody optimizes the packet retransmissions and offers reliable delivery thanks to its technique for selecting the relays of the multicast message. Melody shows much better performances than geographic flooding.

6.2 Future Work

This thesis has focused on multicast message delivery for Internet-to-VANET communication. We revisited traditional multicast protocols and showed the performance and potential of their use in the specific context of fleet management services. We proposed Motion-MAODV. Several points must be considered to improve Motion-MAODV.

First, since a successful multicast delivery relies primarily on the ability to join (correctly) the multicast group, we believe that the traditional route request/response scheme is not suitable for vehicular networks. As such a mechanism may lead to congestion in dense scenarios. Second, it is also necessary to review the link stability function that builds the multicast route to the tree. Although Motion-MAODV creates stable routes in the tree, it does not ensure that they are optimized (which may result in unnecessary retransmissions).

Although Melody performs well in urban scenarios, its performance degrades in scenarios where traffic density is extremely high. Further investigations into the reasons for performance degradation are needed to enhance Melody and tailor it to all possible scenarios.

At present our work uses simulated vehicle trajectories, and, as a next step, it is worth considering using mobility traces taken from real experiments. We could also port our proposals to experimental platforms, particularly in the context of car sharing application.

Bibliographie

- [car] CarTalk2000, <http://www.cartalk2000.net/>.
- [Car] Cartel, <http://cartel.csail.mit.edu/doku.php>.
- [coo] COOPER, <http://www.coopers-ip.eu/>.
- [cvi] CVIS, <http://www.cvisproject.org/>.
- [geo] GeoNet, <http://www.geonetproject.eu/>.
- [NS3] Network Simulator NS3.
- [saf] SafeSpot, <http://www.safespot-eu.org/>.
- [sco] ScoreF, <https://project.inria.fr/scoref/en>.
- [SUM] Simulator for Urban MObility SUMO, www.dlr.de/ts/sumo/en/.
- [Aut] The AutoNet2030 project.
- [11] (2010). Etsi en 302 665 : Intelligent Transport Systems (ITS); Communications Architecture. Technical report.
- [12] (2014). L'accidentalité routière en 2013. Technical report.
- [13] Altayeb, M. and Mahgoub, I. (2013). A survey of vehicular ad hoc networks routing protocols. *Journal of Innovation and Applied Studies*, 3(3) :829–846.
- [14] B. Fenner, H. He, B. H. H. S. (2006). Internet Group Management Protocol (IGMP) /Multicast Listener Discovery (MLD)-Based Multicast Forwarding(“IGMP/MLD Proxying”). pages 1–92.
- [15] Badarneh, O. and Kadoch, M. (2009). Multicast Routing Protocols in Mobile Ad Hoc Networks : A Comparative Survey and Taxonomy. *EURASIP Journal on Wireless Communications and Networking*, 2009(1) :764047.

- [Bai and Helmy] Bai, F. and Helmy, A. IMPORTANT : a framework to systematically analyze the Impact of Mobility on Performance of Routing Protocols for Adhoc Networks. *IEEE INFOCOM 2003.*, 2 :825–835.
- [17] Baldessari, Roberto, Bernardos, Carlos J., Calderon, M. (2008). GeoSAC-scalable address autoconfiguration for VANET using geographic networking concepts. In *Personal, Indoor and . . .*, number Section IV.
- [18] Briesemeister, L. and Hommel, G. (2000). Role-based multicast in highly mobile but sparsely connected ad hoc networks. *First Annual Workshop on Mobile and Ad Hoc Networking and Computing. MobiHOC*, pages 45–50.
- [19] Cain, B., Deering, S., Kouvelas, I., Fenner, B., and Thyagarajan, A. (2002). Internet Group Management Protocol, Version 3. RFC 3376, RFC Editor, IETF.
- [20] Chaintreau, A., Hui, P., Crowcroft, J., Diot, C., Gass, R., and Scott, J. (2005). Pocket switched networks : Real-world mobility and its consequences for opportunistic forwarding. Technical report, Technical Report UCAM-CL-TR-617, University of Cambridge, Computer Laboratory.
- [21] Chen, Y.-S., Lin, Y.-W., and Lee, S.-L. (2010). A mobicast routing protocol in vehicular ad-hoc networks. *Mobile Networks and Applications*, 15(1) :20–35.
- [Dar et al.] Dar, K., Bakhouya, M., and Gaber, J. *IEEE Communications Magazine*, (May).
- [23] Deering, S. (1988). Host extensions for IP multicasting.
- [24] Ding, W. (2002). Multicast routing in fixed infrastructure and mobile ad hoc wireless networks with a multicast gateway, m.sc.
- [Fazio et al.] Fazio, M., Das, S., Palazzi, C. E., and Gerla, M. Vehicular Address Configuration. (Ivc) :1–20.
- [26] Fenner, B., Handley, M., Kouvelas, I., and Holbrook, H. (2006). Protocol independent multicast-sparse mode (PIM-SM) : Protocol specification (revised). Technical report.
- [FNVHashFunction] FNVHashFunction. FNV : <http://isthe.com/chongo/tech/comp/fnv/>.
- [28] Fogue, M., Garrido, P., Martinez, F. J., Cano, J.-C., Calafate, C. T., and Manzoni, P. (2012). Evaluating the impact of a novel message dissemination scheme for vehicular networks using real maps. *Transportation Research Part C : Emerging Technologies*, 25 :61–80.

- [29] Franz, W., Hartenstein, H., and Mauve, M. (2005). *Inter-vehicle communications based on ad hoc networking principles : the FleetNet project*. Univ.-Verlag Karlsruhe.
- [30] Gundavelli, S., Leung, K., and Devarapalli, V. (2008). Proxy mobile ipv6. pages 1–92.
- [31] Ho, I. W., Leung, K. K., Polak, J. W., and Mangharam, R. (2007). Node Connectivity in Vehicular Ad Hoc Networks with Structured Mobility. *32nd IEEE Conference on Local Computer Networks (LCN 2007)*, pages 635–642.
- [32] Hsieh, Y.-L. and Wang, K. (2012). Dynamic overlay multicast for live multimedia streaming in urban VANETs. *Computer Networks*, 56(16) :3609–3628.
- [33] IEEE 802.11 Working Group (2010). IEEE Standard for Information Technology – Telecommunications and information exchange between systems – Local and metropolitan area networks – Specific requirements – Part 11 : Wireless LAN Medium Access Control (MAC) and Physical Layer (PHY) specifications Amendment 6 : Wireless Access in Vehicular Environments.
- [34] Jacquet, P., Muhlethaler, P., Clausen, T., Laouiti, A., Qayyum, A., and Viennot, L. (2001). Optimized link state routing protocol for ad hoc networks. In *Multi Topic Conference, 2001. IEEE INMIC 2001. Technology for the 21st Century. Proceedings. IEEE International*, pages 62–68. IEEE.
- [35] Jerbi, M., Senouci, S.-M., Meraihi, R., and Ghamri-Doudane, Y. (2007). An improved vehicular ad hoc routing protocol for city environments. In *Communications, 2007. ICC'07. IEEE International Conference on*, pages 3972–3979. IEEE.
- [36] Jerbi, M., Senouci, S.-M., Rasheed, T., and Ghamri-Doudane, Y. (2009). Towards efficient geographic routing in urban vehicular networks. *Vehicular Technology, IEEE Transactions on*, 58(9) :5048–5059.
- [37] Johnson, D. B. and Maltz, D. A. (1996). Dynamic source routing in ad hoc wireless networks. In *Mobile computing*, pages 153–181. Springer.
- [38] Junhai, L., Danxia, Y., Liu, X., and Mingyu, F. (2009). A survey of multicast routing protocols for mobile Ad-Hoc networks. *IEEE Communications Surveys & Tutorials*, 11(1) :78–91.
- [39] Karaoglu, B. and Heinzelman, W. (2010). Multicasting vs . Broadcasting : What are the. In *IEEE Global Telecommunications Conference GLOBECOM 2010*.
- [40] Karp, B. and Kung, H.-T. (2000). Gpsr : Greedy perimeter stateless routing for wireless networks. In *Proceedings of the 6th annual international conference on Mobile computing and networking*, pages 243–254. ACM.

- [41] Kempf, J. (2007). Problem Statement for Network-Based Localized Mobility Management (NETLMM).
- [42] Khaled, Y., Jemaa, I. B., Tsukada, M., and Ernst, T. (2009). Application of IPv6 multicast to VANET. pages 198–202.
- [43] Khan, A. M., Bacchus, A., and Erwin, S. (2012). Policy-based challenges of increasing automation in driving. *IATSS Research*, 35(2) :79–89.
- [44] Kihl, M., Sichitiu, M., and Joshi, H. P. (2008). Design and evaluation of two geocast protocols for vehicular ad-hoc networks. *Journal of Internet Engineering*, 2(1).
- [45] Ko, Y. and Vaidya, N. (1999). Geocasting in mobile ad hoc networks : Location-based multicast algorithms. WMCSA '99.
- [46] Kukliński, S. and Wolny, G. (2011). CARAVAN : Context-AwaRe Architecture for VANET. *Mobile Ad-Hoc Networks : Applications*.
- [47] Law, L. K., Krishnamurthy, S. V., and Faloutsos, M. (2007). Understanding and exploiting the trade-offs between broadcasting and multicasting in mobile ad hoc networks. *Mobile Computing, IEEE ...*, pages 1–16.
- [48] Lee, K. C., Lee, U., and Gerla, M. (2010a). Geo-opportunistic routing for vehicular networks [topics in automotive networking]. *Communications Magazine, IEEE*, 48(5) :164–170.
- [49] Lee, K. C., Lee, U., and Gerla, M. (2010b). Survey of routing protocols in vehicular ad hoc networks. *Advances in vehicular ad-hoc networks : Developments and challenges*, pages 149–170.
- [50] Lee, S.-j., Gerla, M., Chiang, C.-c., and Rouse, A. M. (1999). On-Demand Multicast Routing Protocol. In *Wireless Communications and Networking Conference, 1999. WCNC*, pages 298–302.
- [51] Lee, U., Cheung, R., and Gerla, M. (2009). Emerging vehicular applications. In *Vehicular Networks : From Theory to Practice*, chapter Chapter1.
- [52] Li, F. and Wang, Y. (2007). Routing in vehicular ad hoc networks : A survey. *Vehicular Technology Magazine, IEEE*, (June) :12–22.
- [53] Li, Y., Jin, D., Wang, Z., Zeng, L., and Chen, S. (2013). Exponential and Power Law Distribution of Contact Duration in Urban Vehicular Ad Hoc Networks. *IEEE Signal Processing Letters*, 20(1) :110–113.
- [54] Lin, Y., Chen, Y., and Lee, S. (2010). Routing Protocols in Vehicular Ad Hoc Networks : A Survey and Future Perspectives. *J. Inf. Sci. Eng.*, 1(c).

- [55] Ma, Y. and Jamalipour, A. (2011). Opportunistic geocast in disruption-tolerant networks. In *Global Telecommunications Conference (GLOBECOM 2011), 2011 IEEE*, pages 1–5. IEEE.
- [56] Maihöfer, C. and DAIMLERCHRYSLER AC (2004). Geocast Routing Protocols. *delab.csd.auth.gr*, 6(2) :32–42.
- [57] Martinez, F. J., Fogue, M., Coll, M., Cano, J.-C., Calafate, C., and Manzoni, P. (2010). Evaluating the impact of a novel warning message dissemination scheme for VANETs using real city maps. In Crovella, M., Feeney, L., Rubenstein, D., and Raghavan, S., editors, *NETWORKING 2010*, volume 6091 of *Lecture Notes in Computer Science*, pages 265–276. Springer Berlin / Heidelberg.
- [58] Naumov, V. and Gross, T. R. (2007). Connectivity-aware routing (car) in vehicular ad-hoc networks. In *InfoCOM*, volume 26, pages 1919–1927.
- [59] Navas, J. C. and Imielinski, T. (1997). GeoCast - Geographic Addressing and Routing *. In *MobiCom*.
- [60] Perkins, C., Johnson, D., and Arkko, J. (2011). Mobility support in IPv6. *Zhurnal Eksperimental'noi i Teoreticheskoi Fiziki*, pages 1–169.
- [61] Perkins, C. E. and Royer, E. M. (1999). Ad-hoc on-demand distance vector routing. In *Mobile Computing Systems and Applications, 1999. Proceedings. WMCSA '99. Second IEEE Workshop on*, pages 90–100. IEEE.
- [62] Pusateri, T. (2003). Distance vector multicast routing protocol.
- [63] Rahbar, H., Naik, K., and Nayak, A. (2010). DtsG : Dynamic time-stable geocast routing in vehicular ad hoc networks. In *Ad Hoc Networking Workshop (Med-Hoc-Net), 2010 The 9th IFIP Annual Mediterranean*, pages 1–7. IEEE.
- [64] Romdhani, I., Munoz, J., Bettahar, H., and Bouabdallah, A. (2006). Mobile multicast route optimisation. In *Communications, 2006. ICC'06. IEEE International Conference on*, volume 5, pages 1977–1983. IEEE.
- [65] Royer, E. (2000). Multicast ad hoc on-demand distance vector (MAODV) routing. *IETF Internet Draft, draft-ietf-manet-maodv-00.txt*, (July).
- [66] Royer, E. M. and Perkins, C. E. (1999). Multicast operation of the ad-hoc on-demand distance vector routing protocol. In *Proceedings of the 5th annual ACM/IEEE international conference on Mobile computing and networking*, pages 207–218. ACM.
- [67] Sebastian, A. and Tang, M. (2010). A multicast routing scheme for efficient safety message dissemination in VANET. (*WCNC*), *2010 IEEE*, (April) :18–21.

- [68] Seet, B.-C., Liu, G., Lee, B.-S., Foh, C.-H., Wong, K.-J., and Lee, K.-K. (2004). A-star : A mobile ad hoc routing strategy for metropolis vehicular communications. In *NETWORKING 2004. Networking Technologies, Services, and Protocols; Performance of Computer and Communication Networks; Mobile and Wireless Communications*, pages 989–999. Springer.
- [69] Slavik, M. and Mahgoub, I. (2010). Stochastic Broadcast for VANET. In *7th IEEE Consumer Communications and Networking Conference (CCNC)*, pages 1–5, Las Vegas, USA.
- [70] Sofra, N., Gkelias, A., and Leung, K. K. (2011). Route Construction for Long Lifetime in VANETs. *IEEE Transactions on Vehicular Technology*, 60(7) :3450–3461.
- [71] Srinivasan, K. and Ramanathan, P. (2010). Reliable multicasting in disruption tolerant networks. In *Global Telecommunications Conference (GLOBECOM 2010), 2010 IEEE*, pages 1–5. IEEE.
- [72] Thaler, D. (2010). Unicast-prefix-based ipv4 multicast addresses. Internet-draft, RFC 6034, IETF.
- [73] Thomson, S., Narten, T., and Jinmei, T. (2007). IPv6 Stateless Address Autoconfiguration. Technical report.
- [74] Tonguz, O., Wisitpongphan, N., and Bai, F. (2010). DV-CAST : A distributed vehicular broadcast protocol for vehicular ad hoc networks. *IEEE Wireless Communications*, 17(2) :47–57.
- [75] Vaishampayan, R. and Garcia-Luna-Aceves, J. J. (2004). Efficient and robust multicast routing in mobile ad hoc networks. In *Mobile Ad-hoc and Sensor Systems, 2004 IEEE International Conference on*, pages 304–313. IEEE.
- [76] Vegni, A., Biagi, M., and Cusani, R. (2013). Smart vehicles, technologies and main applications in vehicular ad hoc networks. *Vehicular Technologies - Deployment and Applications*, pages 3–20.
- [77] Vida, R., Costa, L., Fdida, S., Deering, S., Fenner, B., Kouvelas, I., and Haberman, B. (2004). Multicast listener discovery version 2 (mldv2) for ipv6. Technical report, RFC 3810, June.
- [78] Wang, W., Srinivasan, V., and Motani, M. (2007). Adaptive contact probing mechanisms for delay tolerant applications. In *Proceedings of the 13th annual ACM international conference on Mobile computing and networking*, pages 230–241. ACM.

- [79] Wisitpongphan, N., Tonguz, O., Parikh, J., Mudalige, P., Bai, F., and Sadekar, V. (2007). Broadcast storm mitigation techniques in vehicular ad hoc networks. *IEEE Wireless Communications*, 14 :84–94.
- [80] Wu, C.-W. and Tay, Y. (1999). Amris : A multicast protocol for ad hoc wireless networks. In *Military Communications Conference Proceedings, 1999. MILCOM 1999. IEEE*, volume 1, pages 25–29. IEEE.
- [81] Xie, J., Talpade, R. R., Mcauley, A., and Liu, M. (2002). Amroute : ad hoc multicast routing protocol. *Mobile networks and Applications*, 7(6) :429–439.
- [82] Ye, Q., Cheng, L., Chuah, M. C., and Davison, B. D. (2006). -multicast : On-demand Situation-aware Multicasting in Disruption Tolerant Networks. 00(c).
- [83] Yousefi, S. and Antipolis, S. (2007). Study of connectivity in vehicular ad hoc networks.
- [84] Zhang, J., Zhang, G., and Liu, L. (2007). Geogrid : A scalable location service network. In *ICDCS*, page 60. Citeseer.
- [85] Zhao, J. and Cao, G. (2008). Vadd : Vehicle-assisted data delivery in vehicular ad hoc networks. *Vehicular Technology, IEEE Transactions on*, 57(3) :1910–1922.
- [86] Zhu, H., Fu, L., Xue, G., Zhu, Y., Li, M., and Ni, L. M. (2010). Recognizing Exponential Inter-Contact Time in VANETs. In *2010 Proceedings IEEE INFOCOM*, pages 1–5. IEEE.
- [87] Zhu, Hongzi and Li, M. (2013). Realistic Vehicular Mobility Models. In *Studies on Urban Vehicular Ad-hoc Networks*. Springer.

List Of Publications

Ines Ben Jemaa, Oyunchimeg Shagdar, Francisco J. Martinez and Piedad Garrido, Extended Mobility Management and Routing Protocols for InternettoVANET Multicasting Accepted in VENITs 2015, Las Vegas, January, 2015.

Ines Ben Jemaa, Oyunchimeg Shagdar, Paul Muhlathaler and Arnaud de la Fortelle, Analysing Impact of Mobility Dynamics on Multicast Routing in Vehicular Networks, Emerging 2013, Porto, Portugal, October, 2013.

Ines Ben Jemaa, Oyunchimeg Shagdar, Thierry Ernst, A Framework for IP and Non-IP Multicast Services for Vehicular Networks, NoF 2012, Tunis, Tunisia, November 2012.

Satoru Noguchi, Manabu Tsukada, Ines Ben Jemaa and Thierry Ernst, Vehicle Integration of Driver Support Application with ipv6 Geonetworking, vtc spring 2011, Budapest, Hungary, May, 2011.

Ines Ben Jemaa, Manabu Tsukada, Hamid Menouar and Thierry Ernst, Validation and Evaluation of Nemo in Vanet Using Geographic Routing, ITST 2010, Kyoto, Japan, November, 2010.

Manabu Tsukada, Ines Ben Jemaa, Hamid Menouar, Wenhui Zhang, Maria Goleva and Thierry Ernst, Experimental Evaluation for IPv6 Over Vanet Geographic Routing, MO-MOPE 2010 in Conjunction with IWCMC 2010, Caen, France, June 2010.

Yacine Khaled, Ines Ben Jemaa, Manabu Tsukada and Thierry Ernst, Application of IPv6 Multicast to Vanet, ITS 2009, Lille, france, october, 2009.

Communications Multicast Pour les systèmes véhiculaires coopératifs

Résumé : La communication véhiculaire permet le développement de nouvelles applications multicast émergentes telles que la gestion de la flotte et la distribution des Points d'Intérêt (POI). Ces deux catégories d'applications nécessitent une communication multicast de l'Internet vers les réseaux véhiculaires (VANET). Afin de mettre en place une communication multicast adaptée au contexte de la communication Internet-vers-réseaux véhiculaires, notre travail traite de deux aspects différents. Tout d'abord, l'accessibilité des véhicules en mouvement au service Internet et en deuxième lieu, la dissémination du message dans les VANET.

Nous introduisons un schéma d'adressage multicast basé sur les coordonnées géographiques des véhicules qui leur permet de s'auto-configurer d'une façon dynamique sans aucun besoin d'échanger des messages de signalisation avec Internet. Nous proposons aussi une approche simplifiée de gestion de la mobilité des véhicules dans le cadre des architectures Mobile IP et Proxy Mobile IP. Le but de cette approche est d'optimiser l'échange des messages avec les entités responsables de la gestion de la mobilité dans Internet.

Afin d'étudier les mécanismes de dissémination appropriés aux applications de gestion de flottes, nous nous proposons de revisiter les techniques de routage multicast traditionnelles basées sur une structure de diffusion en arbre. Pour cela, nous étudions leur application aux réseaux véhiculaires. Nous présentons une étude théorique portant sur la durée de vie des liens entre les véhicules en milieux urbains. Ensuite, en utilisant la simulation, nous étudions l'application de Multicast Adhoc On Demand Vector, MAODV et proposons Motion-MAODV, une version adaptée de MAODV qui a pour objectif d'établir des routes plus robustes. Enfin, concernant la dissémination multicast géolocalisée dans les applications POI, nous proposons le protocole de routage Melody qui permet une diffusion geocast en milieu urbain. A partir de simulations, nous constatons que, comparé aux protocoles de géo-broadcasting dans les milieux urbains très denses, Melody assure plus de fiabilité et d'efficacité lors de l'acheminement des données vers les zones géographiques de destination.

Mots clés : Multicast, Internet, Routage, VANET

Multicast Communications for Cooperative Vehicular Systems

Abstract: Vehicular communications allow emerging new multicast applications such as fleet management and point of interest (POI). Both applications require Internet-to-vehicle multicasting. These approaches could not be applied to vehicular networks (VANET) due to their dynamic and distributed nature. In order to enable such multicasting, our work deals with two aspects. First, reachability of the moving vehicles to the multicast service and second, multicast message dissemination in VANET.

We introduce first a self-configuring multicast addressing scheme that allows the vehicles to auto-configure a dynamic multicast address without a need to exchange signalling messages with the Internet. Second, we propose a simplified approach that extends Mobile IP and Proxy Mobile IP. This approach aims at optimizing message exchange between vehicles and entities responsible for managing their mobility in Internet.

To study the dissemination mechanisms that are suitable for fleet management applications, we propose to revisit traditional multicast routing techniques that rely on a tree structure. For this purpose, we study their application to vehicular networks. In particular, as vehicular networks are known to have changing topology, we present a theoretical study of the link lifetime between vehicles in urban environments. Then, using simulations, we study the application of Multicast Adhoc On Demand Vector, MAODV. We propose then Motion-MAODV, an improved version of MAODV that aims at enhancing routes built by MAODV in vehicular networks and guarantee longer route lifetime. Finally, to enable geographic dissemination as required by POI applications, we propose a routing protocol Melody that provides a geocast dissemination in urban environments. Through simulations, Melody ensures more reliable and efficient packet delivery to a given geographic area compared to traditional geo-broadcasting schemes in highly dense scenarios.

Keywords: Multicast, Internet, Routing, VANET

