



HAL
open science

Control Architecture Concepts and Properties of an Ontology Devoted to Exchanges in Mobile Robotics

Saadia Dhouib, Nicolas Du Lac, Jean-Loup Farges, Sébastien Gerard, Miniar Hemaissia-Jeannin, Juan Lahera-Perez, Stéphane Millet, Bruno Patin, Serge Stinckwich

► **To cite this version:**

Saadia Dhouib, Nicolas Du Lac, Jean-Loup Farges, Sébastien Gerard, Miniar Hemaissia-Jeannin, et al.. Control Architecture Concepts and Properties of an Ontology Devoted to Exchanges in Mobile Robotics. 6th National Conference on Control Architectures of Robots, INRIA Grenoble Rhône-Alpes, May 2011, Grenoble, France. 24 p. inria-00599694

HAL Id: inria-00599694

<https://inria.hal.science/inria-00599694>

Submitted on 10 Jun 2011

HAL is a multi-disciplinary open access archive for the deposit and dissemination of scientific research documents, whether they are published or not. The documents may come from teaching and research institutions in France or abroad, or from public or private research centers.

L'archive ouverte pluridisciplinaire **HAL**, est destinée au dépôt et à la diffusion de documents scientifiques de niveau recherche, publiés ou non, émanant des établissements d'enseignement et de recherche français ou étrangers, des laboratoires publics ou privés.

Control Architecture Concepts and Properties of an Ontology Devoted to Exchanges in Mobile Robotics

Saadia Dhouib(1), Nicolas du Lac(2), Jean-Loup Farges(3), Sébastien Gerard(1),
Miniar Hemaïssia-Jeannin(4), Juan Lahera-Perez(5), Stéphane Millet(6), Bruno Patin(6)
and Serge Stinckwich(7)

(1) CEA-LIST, (2) INTEMPORA, (3) ONERA
(4) TRT, (5) INRIA, (6) DASSAULT AVIATION
(7) GREYC

Abstract

A specific ontology is proposed in the scope of the development of a platform devoted to exchanges between academics and industrials of the robotic domain. This paper presents the tools used for knowledge elicitation, the concepts and properties linked with control architecture, the use of the resulting ontology for description of some scenarios and the tracks for the development of a domain specific language grounded on the ontology. Knowledge elicitation is performed in web ontology language thanks to Protégé ontology editor. The ontology is structured as a set of modules organized around a kernel. Modules addressing systems, information, robot and mission include concepts and properties for control architecture description. The expressivity of the ontology is demonstrated describing architectures for a set of scenarios; urban robotic scenario, air-ground scenario, landmark search scenario and military unmanned aerial vehicles scenario. Finally some tracks for the use of the ontology for developing a domain specific language are given.

Keywords

Ontology ; Control ; Architecture ; Robot.

1 INTRODUCTION

An ontology is a formal representation of knowledge that describes a given domain [1]. It organizes the knowledge as a set of concepts with relations between them.

Plateforme pour la Robotique Organisant les Transferts Entre Utilisateurs et Scientifiques (PROTEUS) is a research software platform under development [2] by several french academics and industrials partners. It aims at facilitating transfer of knowledge of the mobile robotic domain from the academic world toward the industrial one and problems from the industrial world toward the academic one. The PROTEUS specification proposes the following use case:

- A first user of the platform provides a problem to the platform,
- A second user gets the problem from the platform and designs a solution for this problem,
- The second user provides the solution to the platform,
- The first user gets the solution from the platform.

This use case indicates that the second user has to understand the problem given by the first user and that the first user has to understand the solution given by the second user. Thus they have to share a common language; they have to agree to use a vocabulary in a way that is consistent with respect to a theory. Moreover, thanks to a computer science language consistent

with the theory, artificial agents that commit to the theory can be designed for the purpose of simulation or test on the field of the solution developed by the second user. For those reasons the development of a theory grounding a vocabulary is required for the PROTEUS platform. Candidates formalisms for specifying this theory are Unified Modelling Language (UML) and ontologies. Ontologies compliant with description logics are known to offer greater support for automated reasoning and cleaner solutions for defining complex relationships than UML. Thus the theory associated to the PROTEUS vocabulary is specified through an ontology. Moreover, simplifying the ontology into UML structural diagrams is an approach for the development of a Domain Specific Language (DSL), that may facilitate the exchanges between users, the configuration of simulation and the projection on actual robots.

2 STATE OF THE ART

Several ontologies have already been proposed in the context of robotics. There is a usually a distinction between ontologies designed to be used directly by robots during their reasoning and ontologies suitable to model the robotic domain in every aspect. Even if the intersection between these approaches is not empty, we are interested here mainly in the second category.

In the late nineties, two ontologies with concepts in French have been proposed from the study on test of decisional autonomy of robots: an robotics ontology and an environment ontology [3]. This robotics ontology is organized in five points of view: agent, component, flow, control and state. It is relevant for PROTEUS and its organization in points of view facilitate its presentation but the implementation of this organization through abstract classes may be a drawback for the development of a computer science language. The ontology includes some ternary relations that may be difficult to implement. In this ontology, the concept of state is defined in general terms that are applicable for continuous and discrete processes. However, the concept is used only in the discrete case. Each instance of the agent concept manages dynamics. This concept is a quite efficient way to specify a simulator to be generated. The hierarchical decomposition of the robot with components is an interesting feature with respect to the ability of generating simulations with different levels of abstraction. This decomposition could also be applied to functionalities and to states. Finally the robot components and the spatial objects could be specializations of a common concept.

Ontology based Component Oriented Architecture (OCA) [4] is a robotic architecture based on behaviours and ontologies. The OCA ontology describes a control architecture for a very specific component model. The generalisation of OCA to a set of control architectures and component models could be very useful for PROTEUS.

The Multi-Layered Context Ontology Framework (MLCOF) [5] describes the context of a robot. MLCOF includes 6 Knowledge Layers (KLayer) : image, 1D geometry, 2D geometry, 3D geometry, object and space. The structure of the ontology of each KLayer is based on concepts, relations, functions of relations, hierarchies of concepts, relations of hierarchy and axioms. Each KLayer include a meta-ontology, an ontology and an ontology of instances. The meta-ontology describes general information about the entities to be modelled while the ontology describes specific entities. The main propose of MLCOF is to help robots in object identification tasks.

Ontology-based Multi-layered Robot Knowledge Framework (OMRKF) [6] is an extension of MLCOF. This robot centred description ontology is organized in knowledge boards with four knowledge levels: perception, model, context and activity. Each knowledge level is organized in three layers: high, intermediate and low levels. Each layer includes the same elements than MLCOF: meta-ontology, ontology and ontology of instances. OMRKF has been validated by an experiment with actual robots using Prolog to implement reasoning.

An ontology for robotic rescue with 230 classes, 245 attributes and 180 instances is presented in [8]. This ontology is specific for search and rescue missions.

RoSta¹ (Robot Standards and Reference Architectures) is a Coordination Action (CA) funded under European Union’s Sixth Framework Programme (FP6) from January 2007 to February 2009. The objective of RoSta was to take initiative to defined formal standards in the context of advanced service robotics. In this context, they have defined a glossary and ontology² for mobile manipulation and service robots.

The overview of the state of the art indicates that each ontology is devoted to a purpose. Thus a specific ontology is developed for PROTEUS. This ontology includes concepts and properties strongly linked with control architectures that are presented in this paper.

3 CONCEPTS AND PROPERTIES

3.1 Tools for Knowledge Elicitation

3.1.1 Web Ontology Language

The PROTEUS ontology is described using the Web Ontology Language (OWL). Three elements of OWL are extensively used for the PROTEUS ontology description: namespace, class and property.

A namespace is container that provide the context for the content of an OWL file. A namespace prefix can be used for modifying the meaning of the name of a class or a property in function of the context of the OWL file it belongs to. For instance a property **hasPhysicalCharacteristics**, belonging to the kernel.owl file can be written **kernel:hasPhysicalCharacteristics**.

A class encapsulates the meaning of a concept. Class hierarchies may be created by making one or more statements that a class is a subclass of another class. Classes may have instances.

A property describes a kind of association that is possible between classes. Property hierarchies may also be created by making one or more statements that a property is a subproperty of one or more other properties. For instance the **has** property, which is a generic composition property, can be specialized in **hasPhysicalCharacteristics**, which is a property that may apply only to physical objects.

3.1.2 Protégé

Protégé³ is an ontology editor that is compatible with OWL. The presentation of the ontology in this paper is illustrated by graphs generated with Protégé. Nodes of the graphs correspond to classes or instances and oriented arcs correspond to properties. Class hierarchies are symbolized on graphs by specific arcs with a **isa** label. Moreover an arc with an **io** label indicates that the upstream instance is an instance of the downstream class.

3.2 Ontology Structure

The ontology is organised in a modular way as a set of specialized modules build over a general purpose kernel. The kernel, as well as each module, corresponds to one specific OWL file and to one specific namespace. Moreover a specific PROTEUS file integrates the kernel and the modules. Namespace prefixes are systematically used for the names in the files. Table 1 indicates the namespace prefixes and the contents of corresponding OWL files.

¹ <http://www.robot-standards.eu/>

² More information about this ontology are available in the deliverables D1.2 “Report on Requirement Analysis of Glossary/Ontology Standards”, D1.3 “Plan and Recommendations on Glossary/Ontology Standards” & D 1.4 “Example of modelling and design by using an ontology-based methodology”.

³ <http://protege.stanford.edu/>

Prefix	Contents
proteus	Links to all parts of PROTEUS ontology.
kernel	General classes and properties.
env	Classes and properties devoted to the description of the environment to be simulated for the verification or validation of a solution through a numerical experiment.
expe	Classes and properties devoted to the description of the use of the PROTEUS platform: problem, solution, verification and validation in simulation and by field tests.
information	Classes and properties devoted to the description of information processed or exchanged.
mission	Classes and properties devoted to the description of the missions of the agents involved in a scenario.
robot	Classes and properties devoted to the description of the robot elements.
simu	Classes and properties devoted to the description of the simulation framework and the simulation tools used to test solutions.
system	Classes and properties devoted to the description of systems.

Table 1 : Namespace prefixes for PROTEUS ontology OWL files

The kernel and all the modules, except the **env** module, the **expe** module and the **simu** module, include knowledge about control architecture. Next sub-section includes the description of the **system** and **kernel** modules. Both are presented together because **kernel** is closely linked and dependent of **system**. Indeed, **system** represents the basis of the ontological architecture. Afterwards, each relevant module is introduced in successive sub-sections.

3.3 System and Kernel

3.3.1 System

The present ontology follows a system-based or system-driven architecture. All the logical units or logical entities which achieve an interaction (either physical or logical interaction) with another entity in the ontology, are considered as a system. We can think of a system as a block which triggers interactions and is impacted by interactions coming from other systems, and which owns an input/output interface that we will call 'ports'. Thus, this logical entity is the basic communication unit of the PROTEUS ontology. Consequently, the control architecture of the final platform will rely and will be inspired somehow on this ontological basis. A clear evidence of this system-based ontology can be appreciated considering the development of the PROTEUS DSL; the language will have an important part of its architecture based on block entities with message passing between them by means of interconnected ports. This schema answers to the ontological basis of “system”. Hence, the final code generation and control architecture of the platform will be guided by the DSL and in turn by the ontology.

We can see a schematic example of the ontological idea of System, showing a possible graphical piece of the DSL in *Figure 1*.

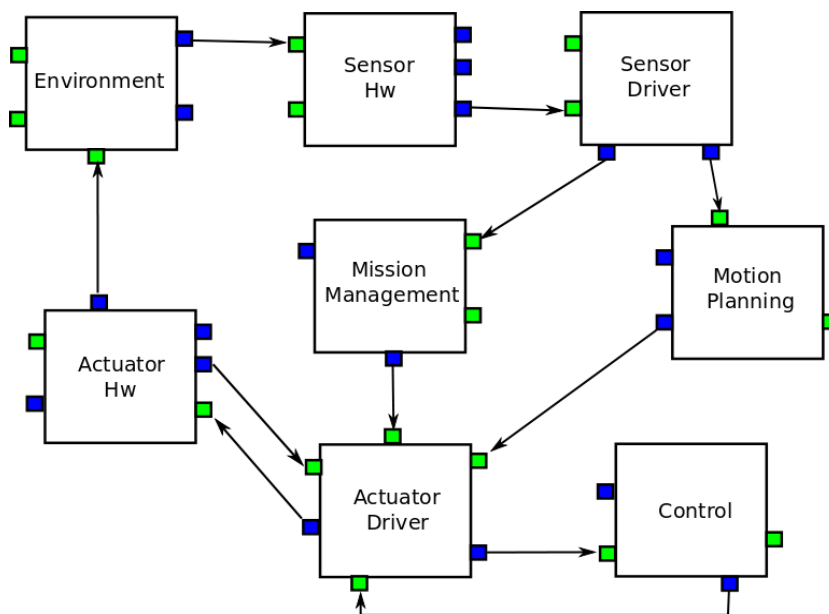

Figure 1: System block diagram as it could be displayed by a graphical DSL

3.3.1.1 System Hierarchy

We can find several classifications of **System**, organized in a hierarchical way in the ontology. A first classification level is shown in Figure 2.

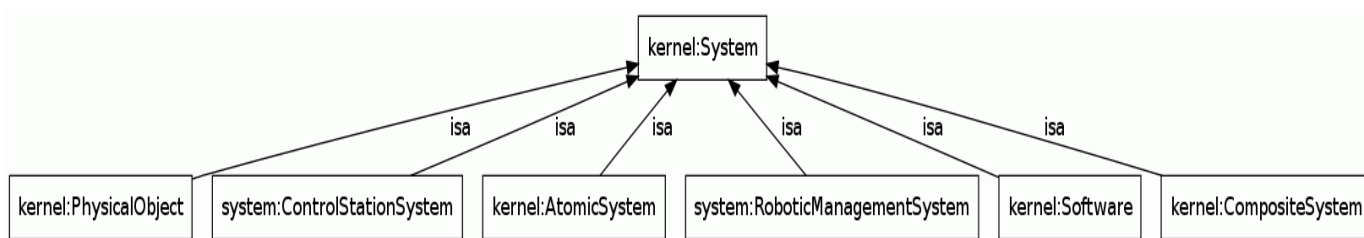

Figure 2: System's first level of classification

A system can be an aggregate of other subsystems (**CompositeSystem**) or an individual unit of interaction (**AtomicSystem**). It can be considered as a logical unit (**Software**) or as a physical entity (**PhysicalObject**). All of these aforementioned systems respond to a point of view about physical/logical components within the scenario (robotic hardware, robotic software, environment elements), hence it is a composition guided hierarchy. Nevertheless it is possible to add to this hierarchy a logical view of the functional part of the Robotic Platform; this is the **RoboticManagementSystem** entity. Finally, **ControlStationSystem** is an entity in the platform independent from a robotic system. However, this station communicates and controls a target robot of the specific scenario. There is a property **hasEvolutionModel** that links a **System** to one or several **EvolutionModel**. This feature can be used not only to describe the dynamics of any part of the control architecture but also the dynamics and capabilities of real components.

Figure 3 shows a part of this classification with some of the most important relationships mentioned above.

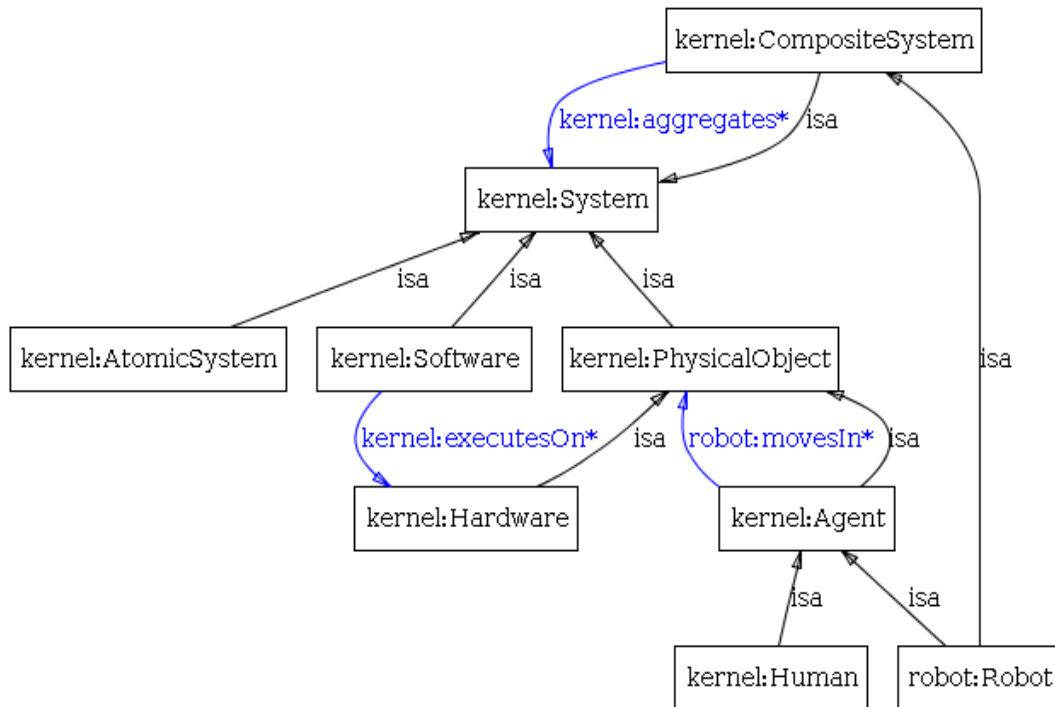

Figure 3: System classification and relationships

Some of the previous subclasses of **System** are worth explaining due to their meaning, subsequent classification and relationship with other entities:

CompositeSystem: As aforementioned, this is a composition of other subsystems. In this classification, our ontology comprehends the following entities: **Environment**, **Robot**, **RoboticSubsystem**. The latter is classified in turn in: **ActuatorSystem**, **CommandableDeviceSystem**, **CommunicationSystem**, **PowerSystem** and **SensorSystem**. Except **CommandableDeviceSystem** which represents commandable units in the system hierarchy, all the other subclasses of systems are composed by both a driver and a hardware part. The ontology contains a constraint in order to impose the mixed Driver/Hardware composition of a **RoboticSystem**.

PhysicalObject: It involves all the physical entities in the scenario. In the corresponding subclassification it is possible to find **Agent (Human and Robot)**, the different components of the **Environment** and **Hardware**. Hardware contains **Clock**, **ActuatorHw** (motorization, prehension or weapon hardware actuators), **CommunicationHw**, **PowerHw** and finally **SensorHw**. As part of the sensor classification, the ontology embraces **EnvironmentParametersSensorHw**, **ImageSensorHw**, **LocalizationSensorHw**, **ObjectDetectionSensorHw**, **ObjectTrackingSensorHw**.

Software: It makes reference to the logical component in a computational unit. It can be a library, a framework, an object file or an **Application (Driver or RoboticMiddleware** in the case of the robotic platform). The drivers represent the software part of all the aforementioned hardware entities. Thus, parallelly it is possible to find a driver for each one of the presented hardware components: **ActuatorDriver**, **CommunicationDriver**, **PowerDriver**, **SensorDriver** and the analogous subclassification for actuators and sensors that can be found in the hardware as well.

Both parts, hardware and driver, make up the corresponding robotic subsystem for the robotic platform.

The link between **Software** and **Hardware** is also explicitly expressed by means of the relationship **Software executesOn Hardware**.

RoboticManagementSystem: This is the set of functional system entities of the robotic platform, i.e. the different main group of functions, which embraces different sets of algorithms, that will be used by the robotic platform in some specific scenarios. It does not involve the *composition* of the system as the previous classification, thus it is just another way to classify the systems without taking into account which software, hardware or physical objects compose it.

In this general functional set it is possible to find: **ControlSystem**, **MissionManagementSystem**, **MotionPlanningSystem**, **PlatformManagementSystem** and **SecuritySystem**.

3.3.1.2 Interaction and dynamic aspects

Another important aspect to be described in this system-based architecture is the exchanges between systems. As shown in *figure 4* **System hasPort** and **Port isTheSupport of Interaction**. As aforementioned, Port is our entity to interface the input/output interaction between systems. For emitting, **System triggers Interaction** that **isEmittedOn Port**. For the reception process, **Interaction isReceivedOn Port** and **impacts System**.

The System module of the ontology expands the notion of **Interaction** in order to embrace the relationships between the physical and logical components of the platform: Hardware and Software. Hence, it is considered **SoftwareToSoftwareInteraction**, **DriverToPhysicDeviceInteraction** and **PhysicDeviceToDriverInteraction** as a classification of **Interaction**. Other interactions triggered by some systems are introduced in the classification; in this way **Noise** and **Bias** represent interactions which can impact on **SensorSystem** or **ActuatorSystem**, for example. This hierarchy is shown in *figure 5*.

It is essential to describe not only the structure of the system architecture but also its dynamical aspects. The **EvolutionModel** class is the basis for the description of this dynamic. Not only **System**, but also **Interaction hasEvolutionModel**.

Two specific types of **EvolutionModel** (**Algorithm** and **StateMachine**) and the general schema of evolution are presented on *figure 6*. An **Algorithm** is an effective method for solving a problem expressed as a sequence of instructions. A **StateMachine isDefinedBy Transitions** and **Events** and, of course, it relies in the entity **State** to carry out the evolution of the system.

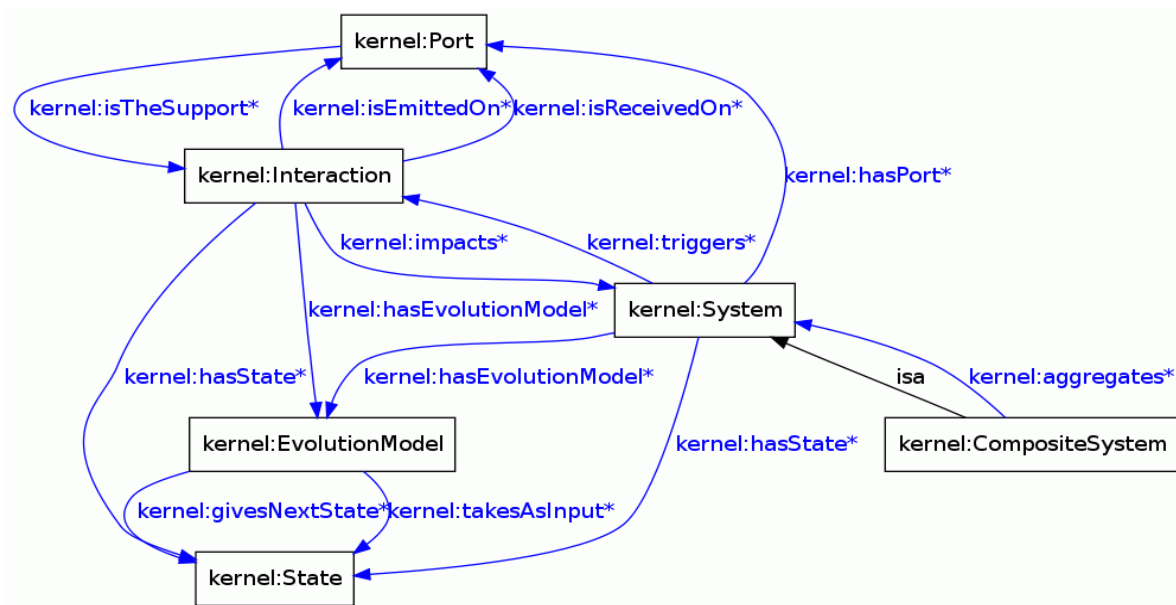

Figure 4: Interactions and dynamic aspects of a System

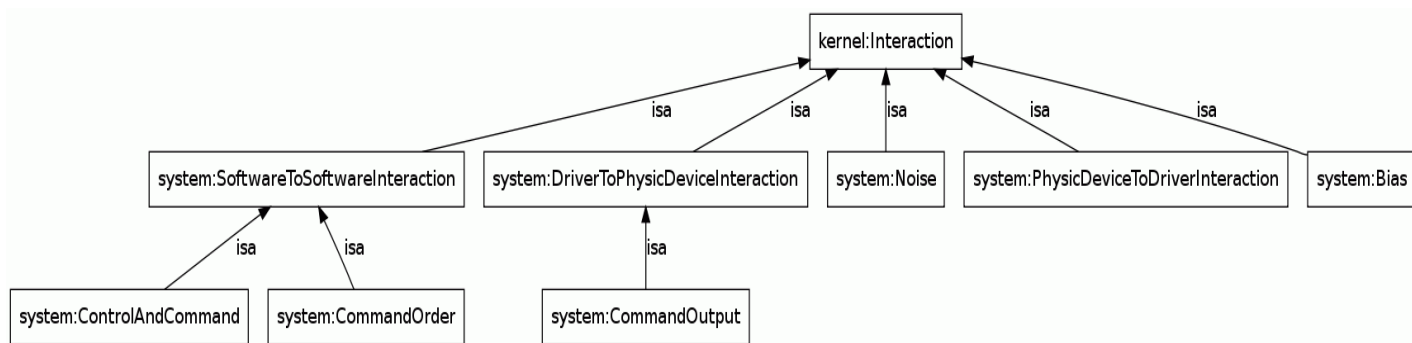

Figure 5: Interaction classification of system module.

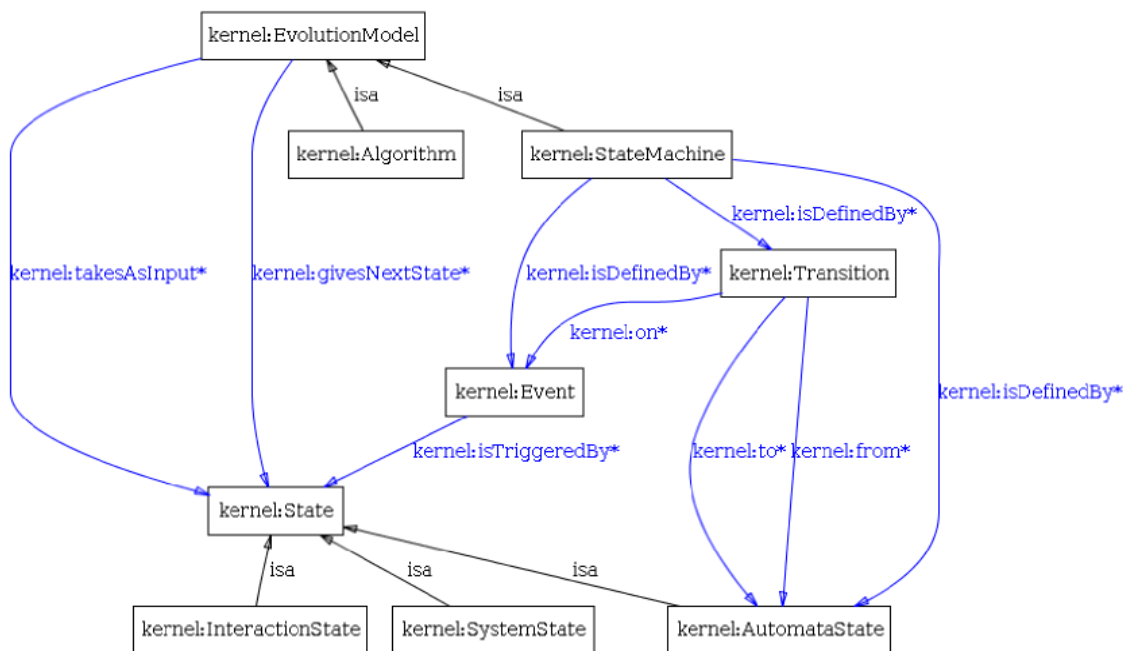

Figure 6: *EvolutionModel.class*

3.3.2 Information

The **Information** class that is a central concept in PROTEUS ontology. As shown on *figure 7*, **Information** is directly and indirectly linked to **Interaction**. The direct link indicates that **Interaction transmitInformation**. The indirect link indicates that **Interaction hasProtocol** and that **Protocol constrains Information**.

Both **Data** and **Abstraction** are **Information**. **Data** is directly interpretable by a machine, for example boolean and bits are **Data**. **Abstraction** is not directly interpretable by a machine but provides some meaning that can be indirectly interpretable, for instance **State** is an **Abstraction** meaning that the **Information** can be the input or the output of an **EvolutionModel**. It is important to note that **Abstraction isCodedIn Data**. Indeed despite the fact that objectively speaking a control architecture only processes and transmits **Data**, the understanding and analysis of the architecture is grounded on **Abstraction**.

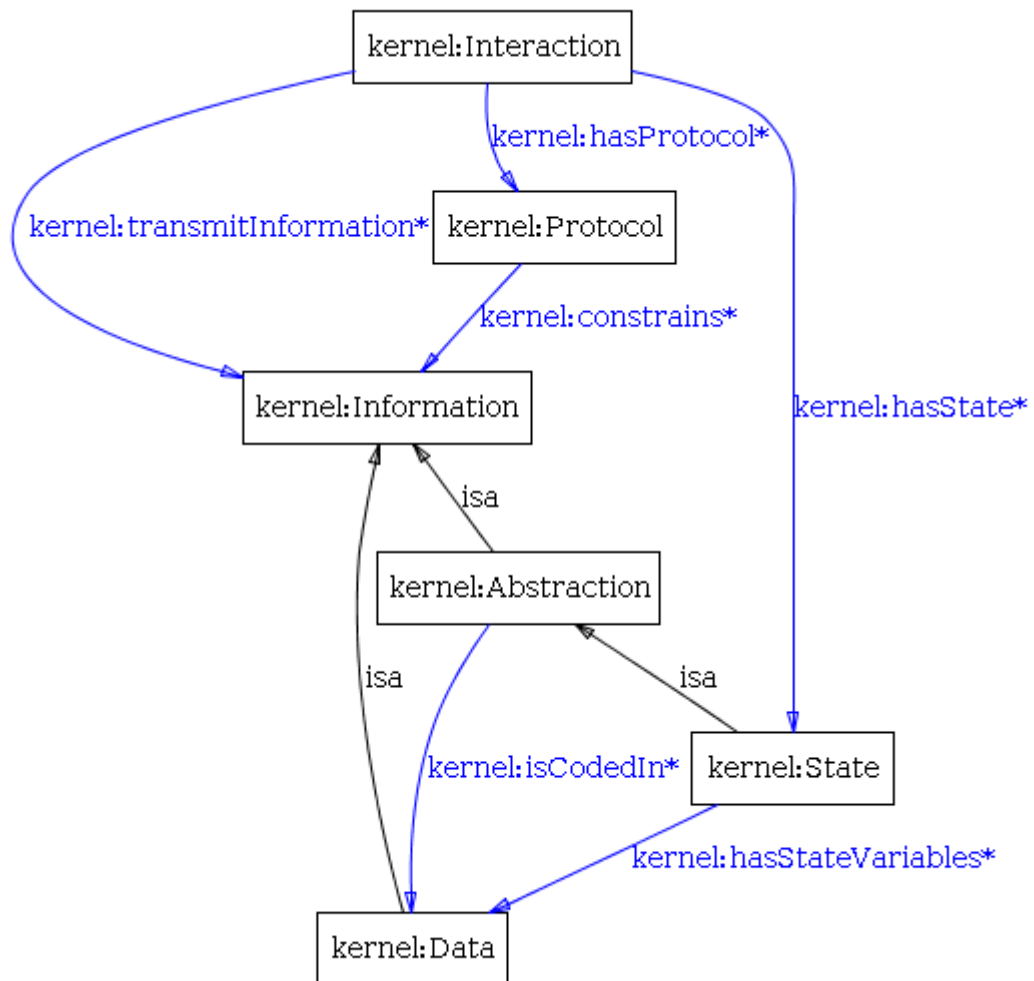

Figure 7: The Information class

3.4 Information

The main classes of **information** namespace that are relevant for architecture description are specializations of **kernel:Data**. Those classes, shown on figure 8 are:

- **Collection** contains a possibly modifiable set of **kernel:Data** with coherent types and fitted with a data structure (indexation, ad hoc or natural order, father/child relation, etc).
- **PhysicalData** represents a mathematical algebraic object with an associated physical unit.
- **TimestampedData** is any information combined with a timestamp that may represent its creation date.
- **ComposedData** represents any aggregation of heterogenous **kernel:Data** with no specific structure (in the computer science meaning) which can be consistently interpreted in robotics. Of course, this is not exhaustive. This class can be widely extended depending on application. See messages like defined in JAUS, FIPA, ADL...
- **PrimitiveData** is a type of **kern:Data** which corresponds to the primitives of the standard computing interpretation: boolean, classical number representation (int, double, ...), character

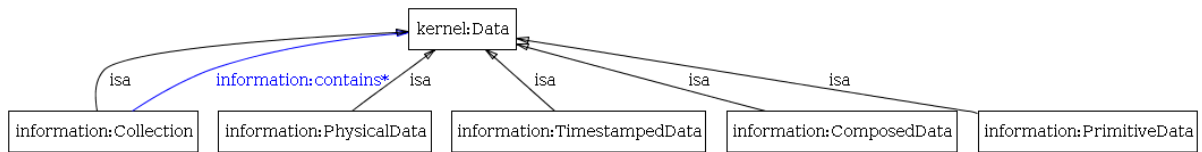

Figure 8: Main relevant classes and properties of information

3.5 Robot

The module Robot of the ontology introduces the definition of the entity **Robot** as subclass of **Agent** and **CompositeSystem**. A constraint is imposed in the characterization of this entity: **Robot** is an aggregation of some **RoboticSystems** (which are defined by the composition of a software and a hardware part).

This module introduces a hierarchy based on unmanned/piloted property. It is possible to find aerial, water surface, ground and underwater vehicles in this classification for both unmanned and piloted robots. The “Robot” module is presented in figure 9.

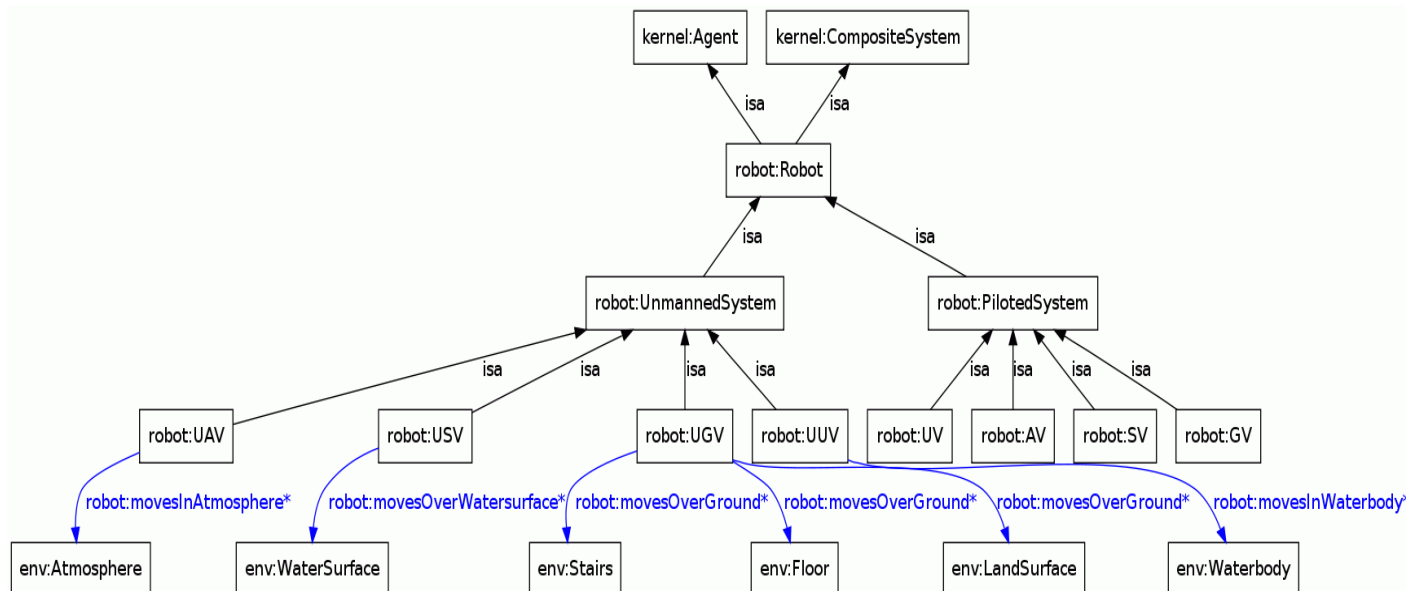

Figure 9: Robot Module

3.6 Mission

Figure 10 presents the main classes and properties of **mission** namespace.

The class **OperationalInformation** is a specialization of **kernel:Information** that is characterized by being related to operations. The ontology includes several specializations of **OperationalInformation**. Among those specialisations **Mission** and **Task** are presented on figure 10. **Mission** is a description of an operational mission that can be used by the **kernel:Agent** performing it and that can be used for performance assessment. **Task** corresponds to a task as defined in Hierarchical Task Networks.

The class **FiniteStateMachine** is a specialization of **kernel:StateMachine** that is characterized by having a finite number of **kernel:AutomataState**. The specialization **MissionStateMachine** indicates that the **FiniteStateMachine** is the range of the property **hasMissionStateMachine** whose scope is **Mission**.

A **Mission** instance **isDescribedBy** its **MissionStateMachine** instances, its **Constraint** instances and its **Task** instances. The **Workflow** of the **Mission isDescribedBy** the same **MissionStateMachine** instances.

Finally the **hasRessource** property allows the enumeration of **kernel:Agent** instances participating to a **Mission** instance.

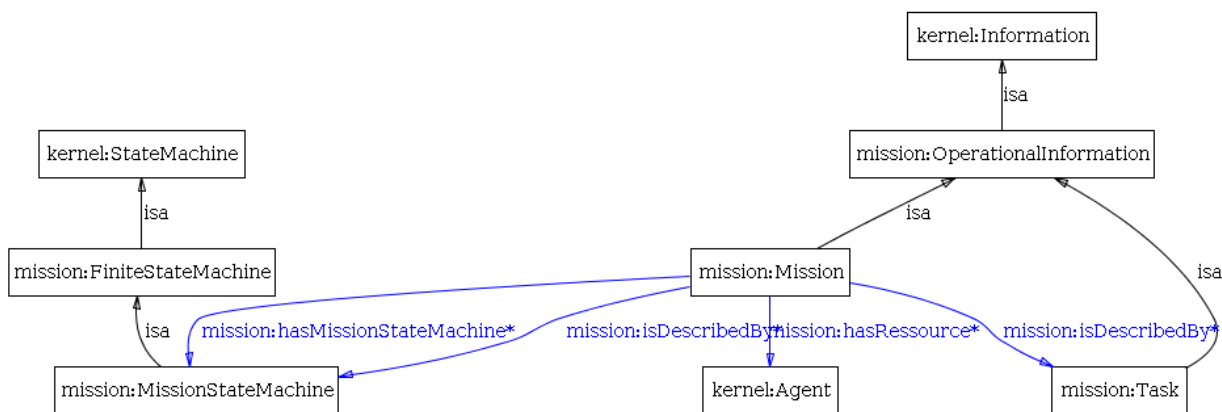

Figure 10: Main classes and properties of *mission*

4 APPLICATION TO SCENARIOS

4.1 Scenarios

The validation of the PROTEUS platform is based on a set of robotic challenges. The problem associated with each challenge is provided to challengers through the PROTEUS platform and the challengers provide their solution to the problem through the PROTEUS platform. Each robotic challenge is a part of a more global scope corresponding to a scenario. For this reason, before developing a computer science language consistent with the ontology a set of scenarios are used for verifying it. The verification is based on four scenarios; three of them are directly issued for challenges and a fourth is issued from a different robotic domain.

The scenarios linked to challenges are:

- The urban scenario is an implementation of a robotized taxi service as a non segregated mode in the streets of a city. This scenario will conduct to a challenge on the Pavin test site in Clermont-Ferrand.
- The air ground scenario is an implementation of the use of unmanned aerial vehicles and unmanned ground vehicles for an area surveillance aiming at searching and tracking intruders. This scenario will conduct to a challenge on the military camp of Caylus.
- The landmark search scenario is an academic scenario for the pedagogic use of problem based learning in the institutions teaching robotics. This scenario will conduct to a challenge in the DGA site of Bourges.

The fourth scenario is a strike in the depth performed by a package of unmanned aerial combat vehicles. This military unmanned vehicle scenario is an implementation of the use of robotized aircraft for very dangerous war missions.

4.2 Urban robotic

Taxi is an instance of both **robot:UGV** and **kernel:CompositeSystem** that is considered in the urban scenario. **Taxi kernel:aggregates** a set of instances related to its control architecture. Those instances and their classes are shown on *Table 2*.

Instance(s)	Classe(s)
LIDARSensor	system:EnvironementParameterSensor
StereoVisionSensor VisonSensor	system:ImageSensorHardware
MetricGPSSensor OdometerSensor RTKGPSIMUSensor	system:LocalizationSensorHardware
LIDARDriver	system:EnvironementParameterSensorDriver
StereoVisionDriver VisonDriver	system:ImageSensorDriver
MetricGPSDriver OdometerDriver RTKGPSIMUDriver	system:LocalizationSensorDriver
Control Servoing	system:ControlSystem kernel:Software
Mapping TrajectoryPlanning	system:MotionPlanningSystem kernel:Software
Localisation	system:PlatformManagemenetSystem kernel:Software
ObstacleDetection MonitoringAndIntegrity	system:SecuritySystem kernel:Software
BrakesDriver MotorDriver SteeringWheelDriver	system:MotorizationDriver
Brakes Motor SteeringWheel	system:MotorizationHardware

Table 2. Instances related to control architecture and aggregated by Taxi

All instances belonging to **Taxi** are instances of classes specializing **kernel:System**. Thus those instances can **kernel:triggers kernel:Interaction**. Moreover **kernel:Interaction** can **kernel:impacts** them. A set of instances of specializations of **kernel:Interaction** are used for describing the exchanges. **system:PhysicDeviceToDriverInteraction** instances are:

- **LIDARInput**
- **MetricGPSInput**
- **OdometerInput**
- **RTKGPSIMUInput**
- **StereoVisionInput**
- **VisionInput**

system:SoftwareToSoftwareInteraction instances perform exchanges, abbreviated by **Ex**, in the software part of the control architecture:

- **ExLIDARMeasurement**
- **ExMetricGPSMeasurement**
- **ExOdometerMeasurement**
- **ExRTKGPSIMUMeasurement**
- **ExStereoVisionMeasurement**
- **ExVisionMeasurement**
- **ExDetectedObstacle**
- **ExEstimatedPosition**
- **ExBeliefAboutEnvironement**
- **ExTrajectory**
- **ExCommands**
- **ExBrakesCommand**
- **ExMotorCommand**

- ExSteeringWheelCommand
- system:CommandOutput instances are:
- BrakesCommandOutput
- MotorCommandOutput
- SteeringWheelCommandOutput

The **kernel:triggers** of the instances of specialisations of **kernel:System** and **kernel:impacts** of the instances of specialisations of **kernel:Interaction** are set in order to describe the control architecture of **Taxi**. The result is shown on figures 10, 11 and 12.

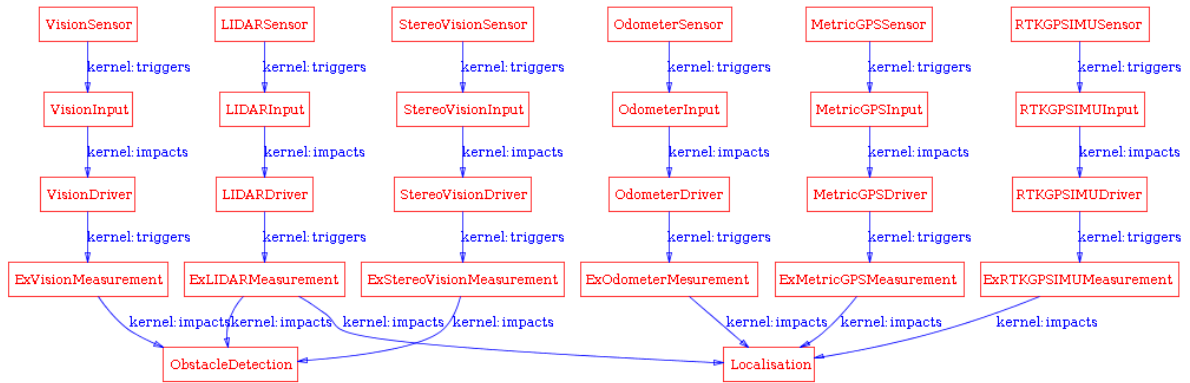

Figure 11: Sensing part of control architecture of Taxi

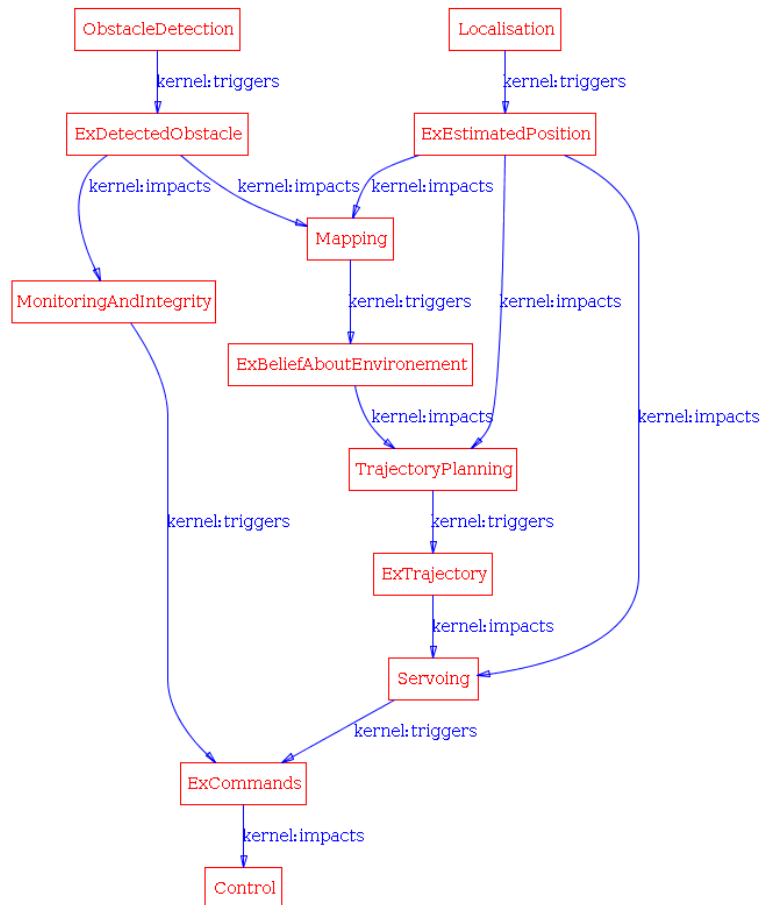

Figure 12: Functional part of control architecture of Taxi

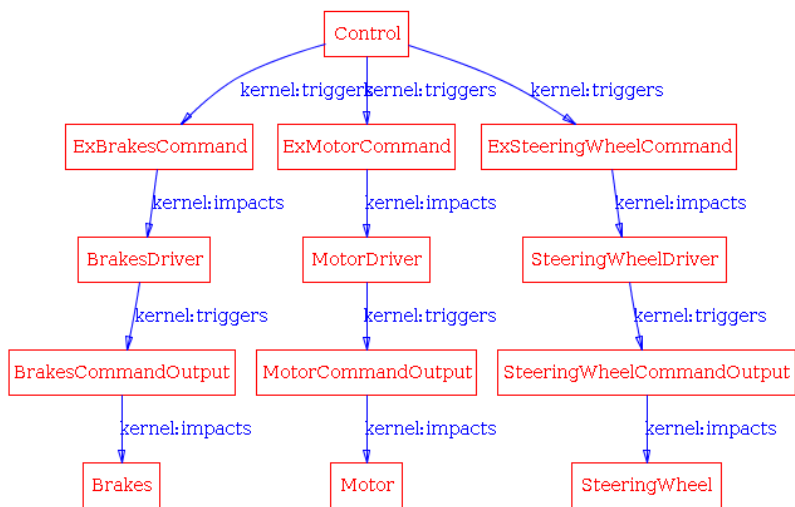

Figure 13: Actuation part of control architecture of Taxi

In the urban scenario **Taxi** has to perform a mission which consists in picking and dropping passengers. The evolution of this mission is described by **TaxiMissionEvolution** instance of **mission:MissionStateMachine**. **TaxiMissionEvolution** **kernel:isDefinedBy** seven **kernel:Transition** instances and five **kernel:AutomataState** instances. Figure 13 illustrates the use of the relations **kernel:from** and **kernel:to** for describing the evolution constraints.

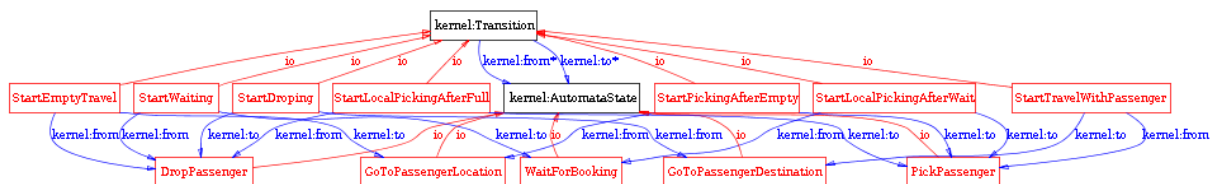

Figure 14: Mission of Taxi

In order to be able to perform a mission, the previously described architecture has to be complemented with a mission management function. Figure 14 presents some aspects of this integration. **TaxiMissionManager** is an instance of **system:MissionManagementSystem** and **kernel:Software**. It **kernel:hasEvolutionModel** **TaxiMissionEvolution**. **ExDesiredDestination** is an instance of **system:SoftwareToSoftwareInteraction** aiming at giving a destination to **TrajectoryPlanning**. **ExDestinationReachedSignal** is an instance of **kernel:Event**. The relation **kernel:on** of the **kernel:Transition** instances **StartPickingAfterEmpty** and **StartDropping** are set to **ExDestinationReachedSignal** in order to indicate that the event fire the transitions.

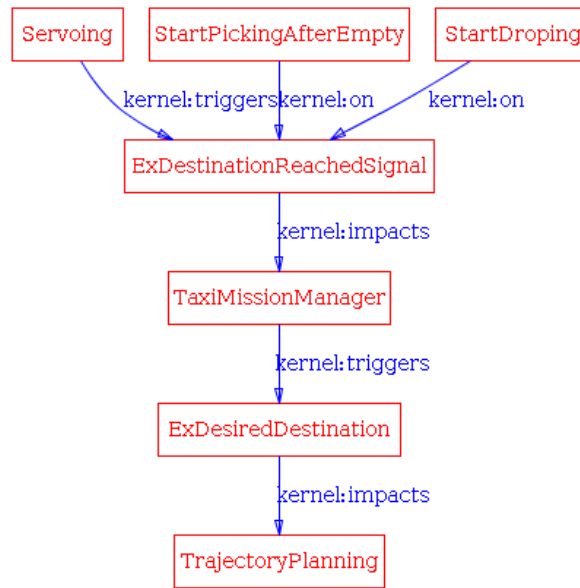

Figure 15: Integration of a mission manager in the *Taxi* architecture

4.3 Air-Ground

RTrooper is an instance of both **robot:UGV** and **kernel:CompositeSystem**. **Rmax** is an instance of both **robot:UAV** and **kernel:CompositeSystem**. Both are considered in the air ground scenario and **kernel:aggregates** a set of instances related to its control architecture. For example, as illustrated in *figure 16*, **RTrooper** **kernel:aggregates** **GPSSensorOfRTrooper** that is an instance of **system:LocalizationSensorHardware**. The multi-robot architecture of the scenario is defined with **RobotTeam** that is an instance of **kernel:CompositeSystem** that **kernel:aggregates** **RTrooper** and **Rmax**. **RobotTeamMission** is **mission:Mission** instance that is performed by both robots. This is indicated by configuring the range of its **mission:hasResource** property with **RTrooper** and **Rmax**. **RobotTeamMission** **mission:isDescribedBy** **Surveillance** and **Detection** that are instances of **mission:Task**, indicating that some hierarchical planning has to be performed by the multi-robot architecture to fulfil its mission.

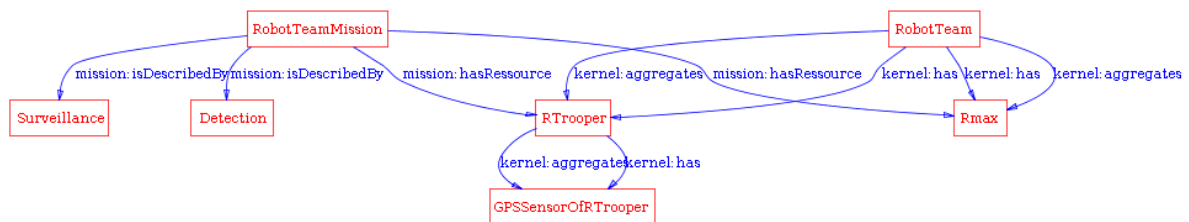

Figure 16: Multi-robot architecture of *RobotTeam*

4.4 Landmark Search

WifiBot is an instance of both **robot:UGV** and **kernel:CompositeSystem**. It **kernel:aggregates** a set of instances related to its control architecture. Among those instances:

- **WheelMotor1, WheelMotor2, WheelMotor3** and **WheelMotor4** are instances of **system:MotorizationHardware**.
- **Camera** is an instance of **system:ImageSensorHardware**.

- **Odometer1, Odometer2, Odometer3, Odometer4, GPS, IMU** and **MagneticCompass** are instances of **system:LocalizationSensorHardware**.
- **Proxymeter1, Proxymeter2, Proxymeter3, Proxymeter4** and **LaserRanging** are instances of **system:ObjectDetectionSensorHardware**.
- **WifiLink** is an instance of **system:CommunicationHardware**.
- **WheelControl** is an instance of **system:Closed-Loop_ControlSystem** and **kernel:Software**.
- **Localisation** and **Navigator** are instances of **system:PlatformManagementSystem** and **kernel:Software**.
- **Servoing** is an instance of **system:ControlSystem** and **kernel:Software**.
- **ProximityMapping** is an instance of **system:SecuritySystem** and **kernel:Software**.
- **GlobalPlanning** is an instance of **system:MissionManagementSystem** and **kernel:Software**.
- **LocalMapping** and **PathPlanning** are instances of **system:MotionPlanningSystem** and **kernel:Software**.

The **kernel:Software** instances exchange information through an instance of **system:CommandOrder**, **ExCommands**, and through a set of **system:SoftwareToSoftwareInteraction** instances: **ExEstimatedPosition**, **ExLocalMapInfo**, **ExLongTermObjective**, **ExPath**, **ExProximityMapInfo** and **ExShortTermTarget**.

Figure 17 presents the description of the functional part of the **WifiBot** architecture with ontology instances. It is more complex than the functional part of the architecture of **Taxi**. It is interesting to observe the loop **ExEstimatedPosition** – **LocalMapping** – **ExLocalMapInfo** – **Localization** that indicates a Simultaneous Localization And Mapping (SLAM) problematic embedded in the landmark search scenario. An alternative architectural solution for **WifiBot** could be to substitute **LocalMapping** and **Localization** by an **kernel:AtomicSystem** SLAM system.

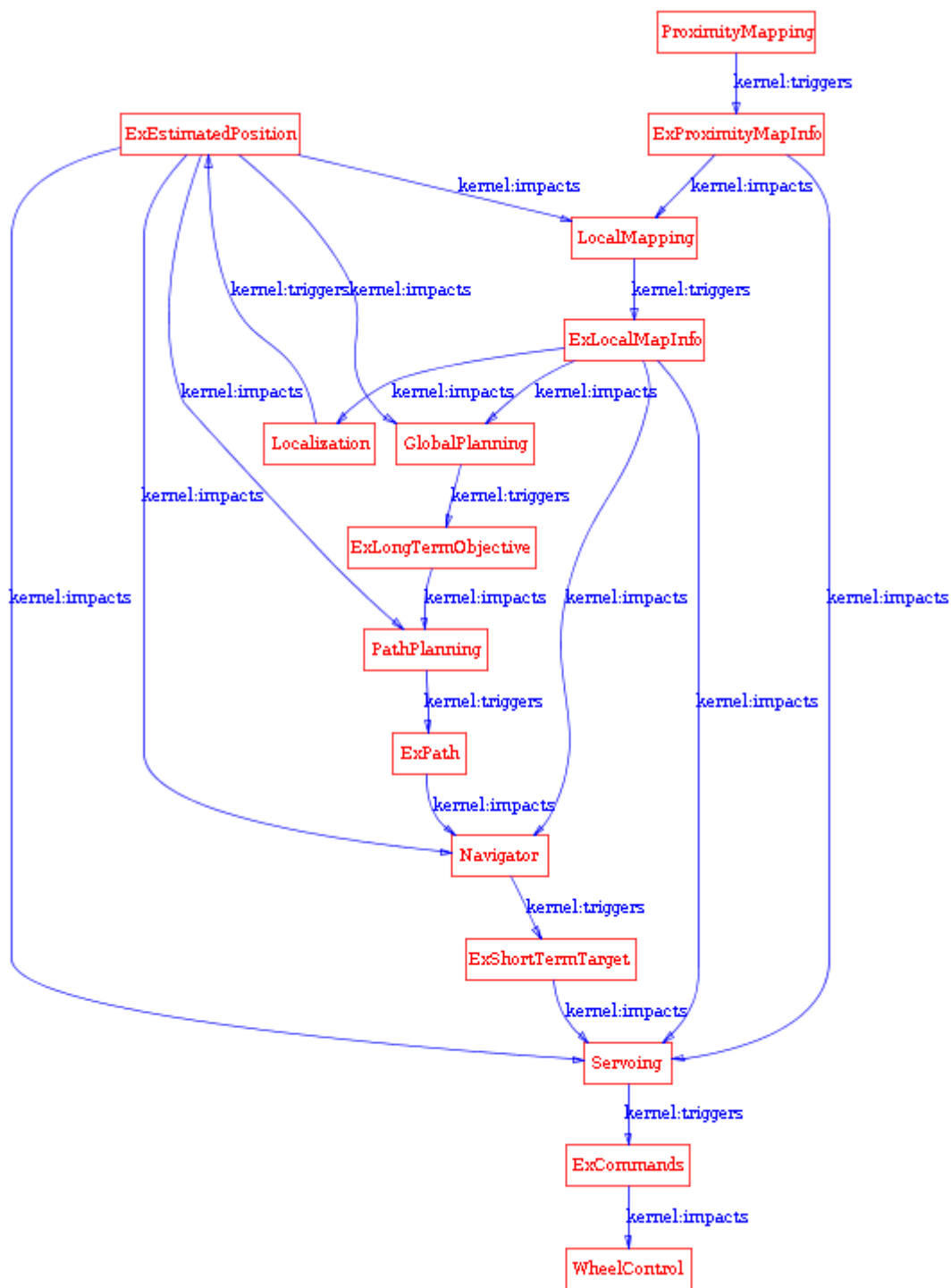

Figure 17: Functional part of architecture of WifiBot

4.5 Military Unmanned Aerial Vehicles

In the following figure, we have an instance of **kernel:CompositeSystem** named **FCAS**, it aggregates of an instance of **system:ControlStationSystem** named **GroundControlStation** and two instances of **robot:UAV** named **UAV7** and **UAV8**.

These 3 last instances are **kernel:PhysicalObject** which are part of an instance of **kernel:Environment** named **Environment**. **UAV7** and **UAV8** can move in this **Environment**.

The **GroundControlStation** can interact with **UAV7** and **UAV8** using an instance of **kernel:Interaction** named **RobotControl**.

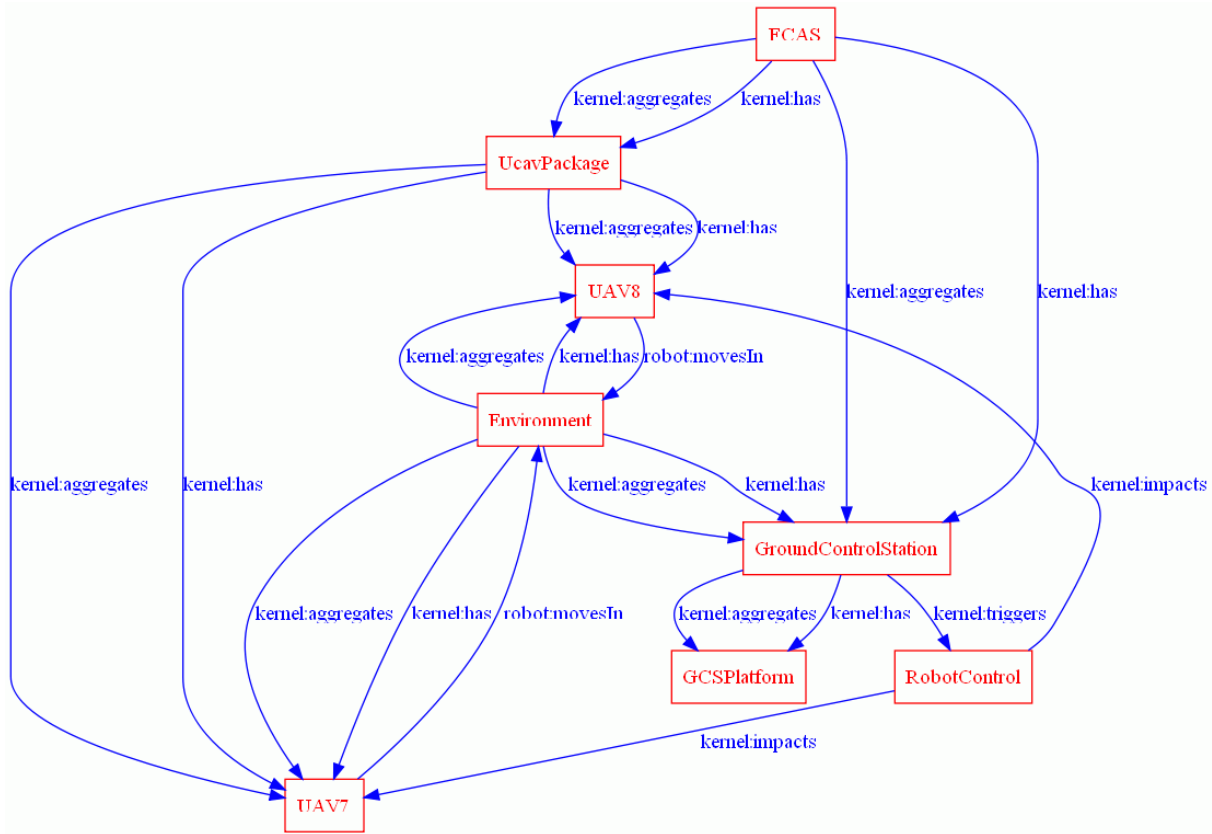

Figure 18: High level system decomposition

In the following figure, we detail the different parts of **UAV7** from the Hardware point of view. It has an instance of **kernel:CompositeSystem** based **UcavPlatform**. This platform aggregates two other **kernel:CompositeSystem**, one named **UcavPayload**, the other named **UcavEquipments**.

The payload is composed of two **system:WeaponHardware** named **BGL1000-1** and **BGL1000-2**.

The defined pieces of equipment are a **system:ObjectDetectionSensorHardware** **RadarHarware**, a **system:MotorizationHardware**, a **system:CommunicationHardware** and a **kernel:Hardware** **OnBoardComputer**.

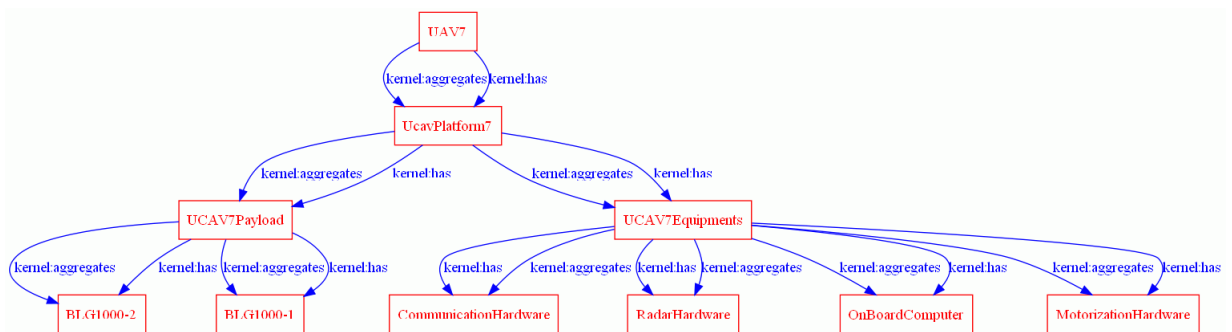

Figure 19: System decomposition of UAV7

As can be seen below, the **OnBoardComputer** hosts several instances of **system:RoboticManagementSystem** named: **MissionManagementSystem**, a **WeaponManagementSystem**, a **SensorManagementSystem** and **NavigationManagementSystem**. The **OnBoardComputer** interacts with the **UcavPlatform7** using a **kernel:Interaction** named **PlatformManagement**.

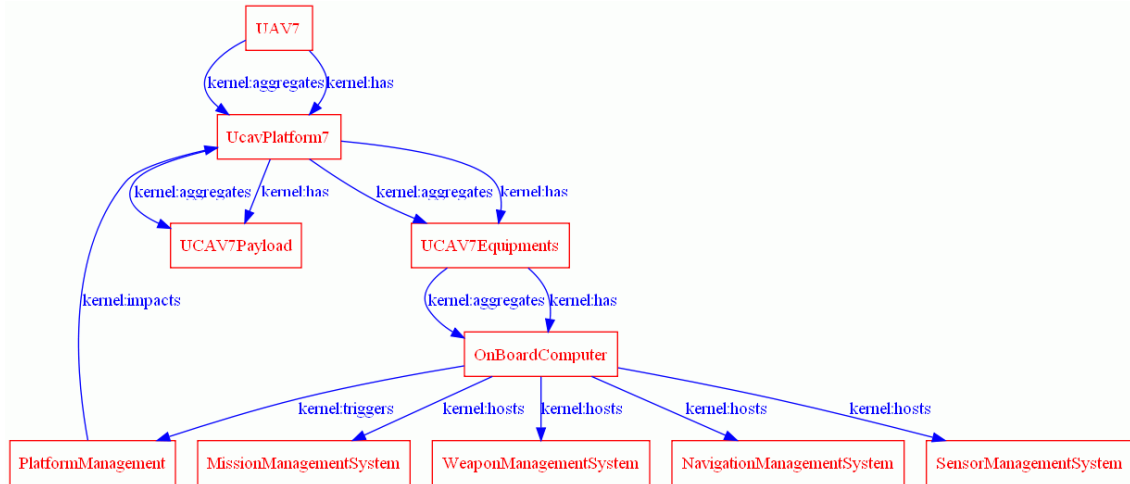

Figure 20: Software hosted in computer of UAV7

In the following, we introduce an instance of **mission:Mission** named **UAVPackageMission**. The resources for this mission are **UAV7** and **UAV8**, this mission defines a **mission:MissionStateMachine** which is used as a **kernel:EvolutionModel** by the **MissionManagementSystem** of the UAVs. This **MissionStateMachine** has a **kernel:AutomataInitialState** **TakeOffPhase**, a **kernel:AutomataEndState** **LandingPhase** and several **kernel:AutomataStates** (**DomesticPhase**, **FebaCrossingPhase**, **TacticalNavigationPhase**, **AttackPhase**).

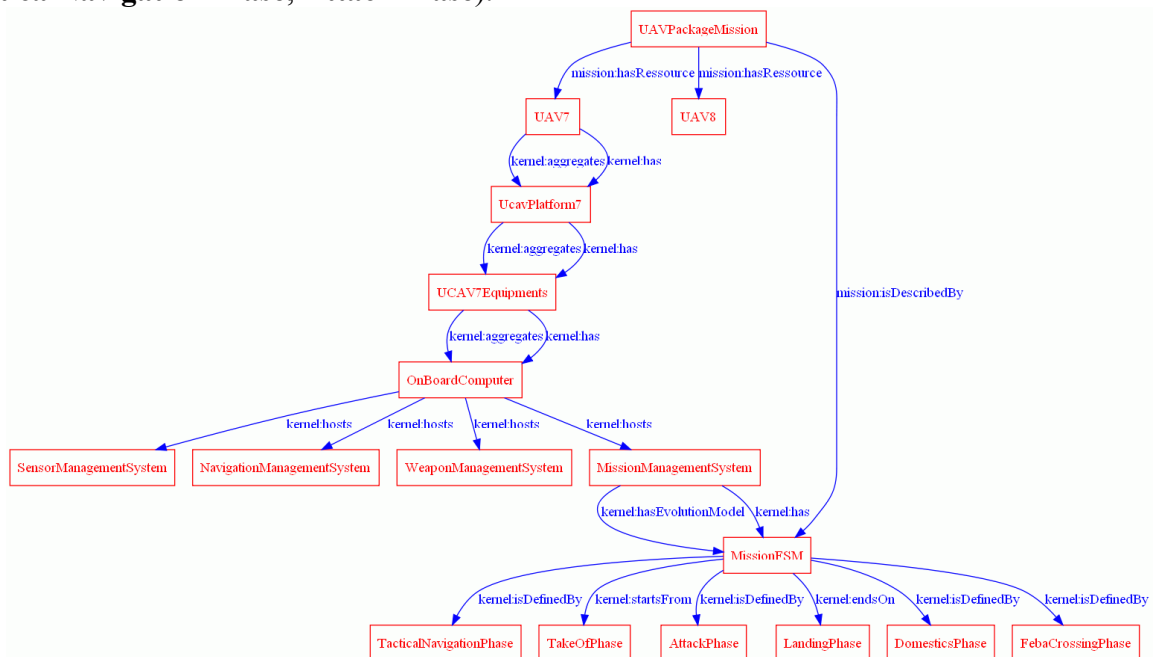

Figure 21: Mission for MissionManagementSystem of UAV7

5 TOWARDS A DOMAIN SPECIFIC LANGUAGE

In the PROTEUS project, the usage of models in the context of the robotics domain is investigated into two forms: ontologies that have been presented in the previous sections and domain specific languages.

Coming from the Artificial Intelligence (AI) and Semantic Web (SW) circles, ontologies are used mainly to represent domains. The Model Driven Engineering (MDE) field gave birth to Domain Specific Languages (DSLs) to represent a particular technical domain. Several works have used ontologies for their semantic or structural synergy with DSLs. Those works are combining the ontologies with DSL at a meta-level to extend the coverage of a DSL [11] or to integrate a variability viewpoint straightforwardly in a DSML [12].

In the context of the PROTEUS project, the ontology is firstly used to represent the domain, i.e. inferring information from a Knowledge Base that complements with the DSL and then to develop the DSLs, i.e. as a representation of experts' knowledge. The methodology we followed in PROTEUS is described in figure 17. We show the DSL design process that integrates the ontology. The design process consists in four steps:

1. The requirements of the DSL are gathered from both following sources: in the one hand from the ontology and in the other hand from the state-of-the-art on DSL for robotics systems.
2. Building the domain model of the DSL: The purpose of the domain model is to describe formally the concepts of the domain. The domain model is described by the means of one or more class diagrams, as well as in the form of textual descriptions.
3. Domain model verification: this step is intended to verify that the aforementioned domain model is covering all the requirements expressed in the first step. This step can lead to adding some concepts that have been integrated in the domain model of the DSL, and that are not belonging to the ontology.
4. UML/textual representation: An alternative for the specification of a DSL is the use of UML, which is a widely known modelling language that has a lot of support tools [13]. Another alternative is a textual representation of the DSL.

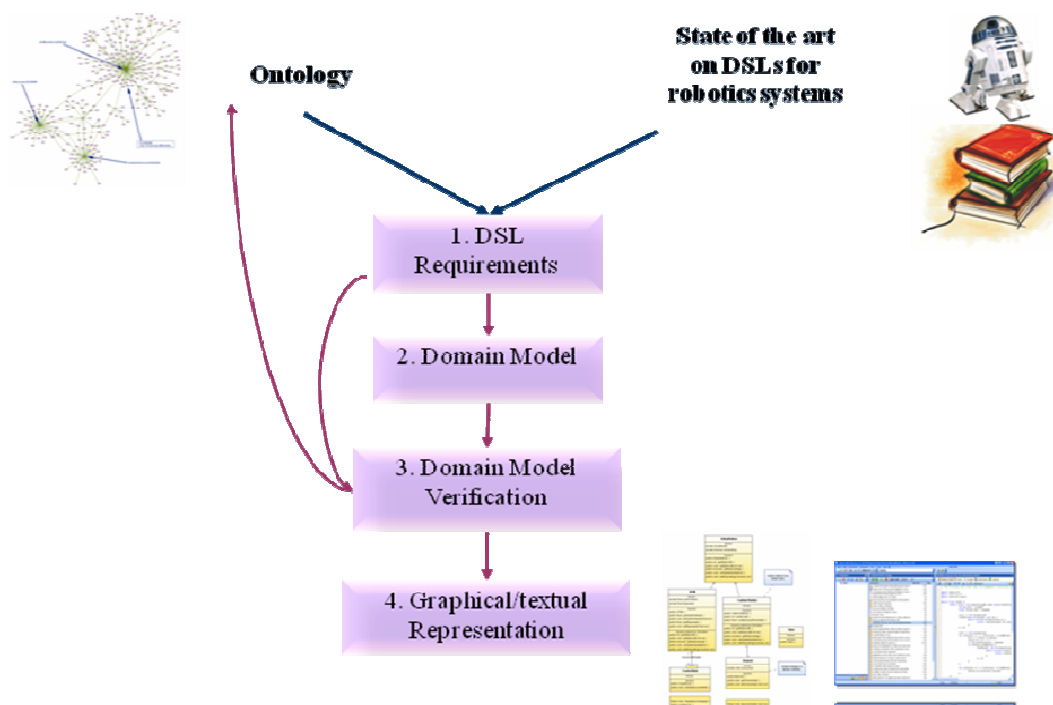

Figure 22: Methodology of the development of the PROTEUS DSL

The ontology is involved in the steps 1 and 2 of the DSL design process. Indeed, the first requirement of the DSL is to correspond to domain concepts defined in the ontology. The other requirements, coming from the ontology, are derived from this one. From the ontology, we extract all the concepts that are specific to the domain. Those concepts are then filtered to retain only the relevant ones for the DSL. On the other hand, if some concepts are missing in the ontology, they are added to the domain model of the DSL.

Ontology (OWL)	Domain model (UML class diagram)
Concept	Class
subClassOf	Inheritance
Property	Association, Attribute
Property:IsA	Inheritance
Property:HasA	Composition
Cardinality	Multiplicity

Table 3. Mapping the ontology to the DSL domain model

The *Table 3* shows the transition from the ontology, written in OWL DL language, to the DSL domain model specified as a UML class diagram. OMG also proposes the ODM (Ontology Definition Metamodel) which defines a set of QVT mappings from UML to OWL [14]. Only the automatic transformation from UML to OWL is implemented, the transformation from OWL to UML is not implemented yet. So we have not taken advantage of the ODM project to make the transition from OWL to UML.

6 CONCLUSION

The PROTEUS ontology devoted to the description of mobile robotic scenarios in view of their numerical simulation or test field is described using OWL. The **kernel** and the **system, information, mission** and **robot** modules include classes and properties allowing control architecture description. The main useful features provided by the ontology are:

- Basic concepts such as software, types of data, hardware, sensor, actuators and types of mobile robots,
- Hierarchical static system description suited as well for isolated robots than for groups of robots with a ground station,
- Dynamical system description grounded on interactions between systems and evolution models such as state machines,
- Decisional system description on the basis of tasks and mission.

None of those features is new. The contribution of the work is to gather them in a common framework understandable and sharable by a large majority of people involved in the development of control architecture of mobile robots. The use of the ontology for describing some aspects of several different scenario ranking from academic landmark search to military strike indicates that the ontology is able to gather information for different types of control architectures and is not devoted to a specific architectural approach. Finally the development of a DSL on the basis of the PROTEUS ontology open the way to automatic code generation for simulation and projection to a target robotic middleware.

However, the work on an ontology seem to be an endless work. Indeed:

- DSL developers are the first users of the ontology and their feedback may lead to some improvements.

- Then challenge providers and challengers, who will use the DSL to describe their problems and solutions, will probably have some feedback on the DSL. It is likely that this feedback will impact the ontology.

7 REFERENCES

- [1] T. Gruber. Toward principles for the design of ontologies used for knowledge sharing. *International Journal of Human-Computer Studies*, 43(5-6):907–928, 1995.
- [2] P. Martinet and B. Patin. PROTEUS: A platform to organize transfer inside french robotic community. In *Proceedings of the 3rd National Conference on Control Architectures of Robots, CAR 2008*, May 29-30 2008.
- [3] P. Deplanques. Vers le test de l’autonomie des robots: une ontologie de la robotique. PhD thesis, Université de Montpellier 2, 1996.
- [4] F. M. Casas and L. A. Garcia. OCOA: An open, modular, ontology based autonomous robotic agent architectures. In D. Scott, editor, *Artificial Intelligence: Methodology, Systems, and Applications*, 10th International Conference, AIMS 2002, volume 2443 of *Lecture Notes in Computer Science*, pages 173–182, 2002.
- [5] W. Hwang, J. Park, H. Suh, H. Kim, and I. H. Suh. Ontology-based framework of robot context modeling and reasoning for object recognition. In L. Wang, L. Jiao, G. Shi, X. Li, and J. Liu, editors, *Fuzzy Systems and Knowledge Discovery, Third International Conference, FSKD 2006*, volume 4223 of *Lectures Notes in Artificial Intelligence*, pages 596–606. Springer-Verlag, 2006.
- [6] I. H. Suh, G. H. Lim, W. Hwang, H. Suh, J.-H. Choi, and Y.-T. Park. Ontology-based multi-layered robot knowledge framework (OMRKF) for robot intelligence. In *IEEE/RSJ International Conference on Intelligent Robots and Systems*, pages 429–436. IEEE, 2007.
- [7] J. Hallam and H. Bruyninckx. An ontology of robotics science. In H. Christensen, editor, *European Robotics Symposium 2006*, volume 22 of *STAR (Springer Tracts in Advanced Robotics)*, pages 1–14. Springer-Verlag, 2006.
- [8] C. Schlenoff and E. Messina. A robot ontology for urban search and rescue. In *Proceedings of the 2005 ACM workshop on Research in knowledge representation for autonomous systems, KRAS 2005*, pages 27–34. ACM, 2005.
- [9] J. Bateman and S. Farrar. Modelling models of robot navigation using formal spatial ontology. In C. Freksa, M. Knauff, B. Krieg-Brückner, B. Nebel, and T. Barkowsky, editors, *Spatial Cognition IV*, volume 3343 of *Lecture Notes in Artificial Intelligence*, pages 366–389. Springer-Verlag, 2005.
- [10] A. Chella, M. Cossentino, R. Pirrone, and A. Ruisi. Modeling ontologies for robotic environments. In *Proceedings of the 14th international conference on Software engineering and knowledge engineering, SEKE 2002*, pages 77–80. ACM, 2002.
- [11] T. Walter and J. Ebert. Combining dsls and ontologies using metamodel integration. In W. Taha, editor, *Proceedings of the IFIP TC 2 Working Conference on Domain-Specific Languages*, number 5658 in *Lecture Notes in Computer Science*, pages 148–169. Springer-Verlag, 2009.
- [12] B. Morin, G. Perrouin, P. Lahire, O. Barais, G. Vanwormhoudt, and J.-M. Jézéquel. Weaving variability into domain metamodels. In *12th International Conference on Model Driven Engineering Languages and Systems (MODELS 2009)*, volume 5795 of *Lecture Notes in Computer Science*, pages 690–705, Denver, Colorado, USA, Oct. 2009. Springer-Verlag.
- [13] G. Giachetti, B. Martin, and O. Pastor. Using uml as a domain-specific modeling language: A proposal for automatic generation of uml profiles. In *Advanced Information*

Systems Engineering, volume 5565 of *Lecture Notes in Computer Science*, pages 110–124, 2009.

- [14] IBM and Object Management Group and Sandpiper Software. *Ontology Definition Metamodel (ODM)*. Available at: <http://www.omg.org/spec/ODM/1.0/>, 2009.