



**HAL**  
open science

## Towards a communication free coordination for multi-robot exploration

Antoine Bautin, Olivier Simonin, François Charpillet

► **To cite this version:**

Antoine Bautin, Olivier Simonin, François Charpillet. Towards a communication free coordination for multi-robot exploration. 6th National Conference on Control Architectures of Robots, INRIA Grenoble Rhône-Alpes, May 2011, Grenoble, France. 8 p. inria-00599605

**HAL Id: inria-00599605**

**<https://inria.hal.science/inria-00599605>**

Submitted on 10 Jun 2011

**HAL** is a multi-disciplinary open access archive for the deposit and dissemination of scientific research documents, whether they are published or not. The documents may come from teaching and research institutions in France or abroad, or from public or private research centers.

L'archive ouverte pluridisciplinaire **HAL**, est destinée au dépôt et à la diffusion de documents scientifiques de niveau recherche, publiés ou non, émanant des établissements d'enseignement et de recherche français ou étrangers, des laboratoires publics ou privés.

# Towards a communication free coordination for multi-robot exploration

Antoine Bautin, Olivier Simonin, François Charpillet  
INRIA Nancy Grand Est - LORIA Lab. - Université Henri Poincaré

**Abstract**—Frontier-based exploration methods are known to be efficient for multi-robot exploration systems. In this paper, we propose a novel, computationally inexpensive, frontier allocation method favoring a well balanced spatial distribution of robots in the environment. It is based on the computation of a position criteria. The position of a robot towards a frontier is defined by the number of robots closer to the frontier. Distances to frontiers are computed using a wavefront propagation from each frontier. The local minimum free potential fields, thus created, are also used for navigation achieved by descending the potential field gradient. Comparisons with existing approaches in simulation demonstrated the efficiency of our algorithm and experiments on robots validated the navigation method.

## I. INTRODUCTION

Exploration of unknown environments by autonomous mobile robots can be useful in many real world situations, typically areas where human access is difficult or hazardous. In exploration tasks, multiple robots systems are advantageous because, using an efficient coordination strategy, they are more accurate and/or faster to explore the environment than single robot systems [Sta06]. Furthermore, multi-robot systems using a distributed algorithm are also robust to failures, flexible and scalable [BM10]. Nevertheless collectively building a map with a team of robots also raises up some difficulties. Finding a good navigation strategy for each robot is not straightforward as the exploration policy of one robot strongly depends of the exploration policy of others. Furthermore, information exchange between robots is often confronted to the issue that each robot might have a different representation of the environment (due to errors in the localization of each robots for example). Another issue is the computational capabilities of the robots that is often limited when using a team of robots. Finally, robot can disturb each other, for example, a robot can block another robot or confuse it with an obstacle.

In this paper, we are interested in building a metric map that accurately and exhaustively describes an unknown indoor environment where no external localization system is available. Robots are equipped with sensors allowing them to build a metric representation of the environment. The main task of a robotic exploration system is to provide a robot with a point to visit in the environment in order to minimize the amount of time required to fully explore the environment.

When complete exploration is the objective every frontier should be explored. Frontiers are the boundaries between unexplored and empty/accessible areas. A robot “exploring a frontier” (moving towards a frontier) discovers new areas to add to the map. When no prior knowledge of the environment is available, maximizing the coverage rate can be sub-optimal

in regards to the time evaluation criteria of an exploration because several robots can go towards frontiers in the same direction while leaving a further isolated frontier. We think that in a good exploration strategy, each robot should “go towards the direction of the frontier having the less robots in its direction”. This work opens a perspective in this way by presenting a novel computationally inexpensive method for going towards such frontiers.

The main contribution of this paper is a new algorithm for the robot-frontier allocation problem. Each robot is assigned to the frontier for which it is in best position i.e the frontier where there is the less robots between the frontier and the robot to be assigned (in path distance). Experimental results in simulation show that this algorithm gives better results than a greedy allocation while having a lower computation complexity. This algorithm also has the desired property of not requiring communication between robots to distribute the frontiers among them.

The paper is organized as follows. Section II states the problem, then Section III reviews the existing literature on the multi-robot exploration problem. Section IV presents our exploration strategy. In Section V we compare in simulation the performances of our algorithm with others and we present first results with robots.

## II. PROBLEM STATEMENT

To limit the scope of the problem, the following assumption are made : the fleet of robots is assumed to be homogeneous (robots composing it are identical), robots are equipped with a range finder, such as sonar or laser, allowing them to localize and build a map of the environment (using, for example, one of the Simultaneous Localization and Mapping (SLAM) algorithms in the literature [TL05] [McC08] [SHSP06]), robots start from a configuration where they are close to each other with a common reference frame, thus making the fusion of maps in between robots easier as well as localization and mapping. The environment to explore is finite and the exploration is considered finished when one of the robots has a complete map. The main problems left to solve are then, the choice of sub-tasks to be carried out by each robot, the task allocation method, and the frequency to which allocation are recomputed. The following presents the notations that will be used in the paper and the evaluation criteria used to assess the quality of a frontier allocation.

### A. Notations

- $\mathcal{E}$  is the environment and  $\mathcal{E}_{exp}, \mathcal{E}_{unexp}$  are, respectively the explored and unexplored part of the environment ( $\mathcal{E} = \mathcal{E}_{exp} + \mathcal{E}_{unexp}$ )
- $\mathcal{R}$  is the set of robots,  $\mathcal{R} : \{\mathcal{R}_1 \dots \mathcal{R}_n\}$  with  $n = |\mathcal{R}|$  the number of robots
- $\mathcal{F}$  is the set of frontiers,  $\mathcal{F} : \{\mathcal{F}_1 \dots \mathcal{F}_m\}$  with  $m = |\mathcal{F}|$  the number of frontiers
- $\mathcal{C}$  a cost matrix with  $C_{ij}$  the cost associated with assigning robot  $\mathcal{R}_i$  to frontier  $\mathcal{F}_j$
- $\mathcal{A}$  an assignation matrix with  $\alpha_{ij} \in [0, 1]$  computed as follows :

$$\alpha_{ij} = \begin{cases} 1 & \text{if robot } \mathcal{R}_i \text{ is assigned to } \mathcal{F}_j \\ 0 & \text{otherwise} \end{cases}$$

### B. Evaluation Criteria of an allocation

The main goal is to optimize the overall exploration time but as the problem is dynamic - robots discovering an unknown environment - it is difficult to evaluate during the system execution. Indeed, when selecting among different allocation, the impact of a given assignation on system performance is not known because no information about what is behind the frontiers is available. Consequently, optimization has to be done at each time step or at least every time a frontier is observed or discovered. In order to deploy the robots in the environment a frontier is assigned to each robot. The quality of an assignation is evaluated using 3 optimization criteria detailed in this section. Each of them must verify the following equality ensuring that only one frontier is assigned per robot.

$$\forall i \sum_{j=1}^m \alpha_{ij} = 1$$

1) *Number of robots per frontiers equilibrium:* When the number of robots is equal to the number of frontiers each frontier should be assigned to one robot. When the number of robots is larger than the number of frontiers, each frontier should be assigned to a robot and remaining robots without frontiers should be assigned to frontiers in a balanced way. Indeed robots should not be left standing still if no frontier is available to them because other robots exploring frontiers are likely to discover new ones and require backup to explore large areas and there is no a priori information on which frontier will lead to large areas. In the opposite case when the number of frontiers is larger than the number of robots, then robots should be assigned to distinct frontiers.

This criteria can be resumed with the following equation :

$$\lfloor n/m \rfloor \leq \forall j \sum_{i=1}^n \alpha_{ij} \leq \lceil n/m \rceil \quad (1)$$

The number of robots per frontier is roughly equal with a maximum difference of one.

2) *Minimum of the sum of cost:* Minimization of the exploration cost by minimizing the sum of cost (typically distance to reach the frontiers)

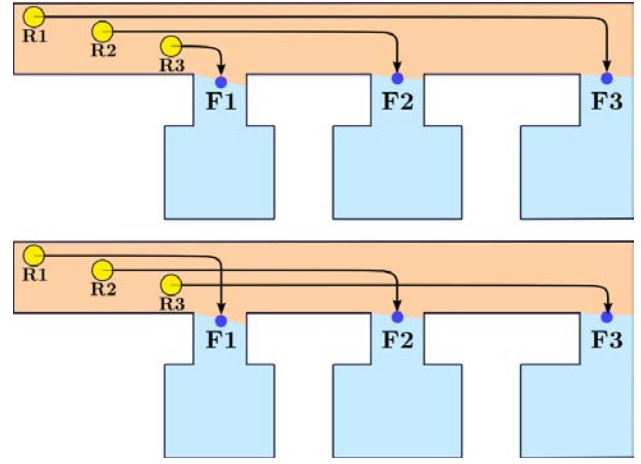

Fig. 1: The two assignation have the same sum of cost but the one on the bottom will take less time to finish

$$C(\mathcal{A}) = \sum_{i=1}^n \sum_{j=1}^m \alpha_{ij} C_{ij} \quad (2)$$

3) *Minimum of the frontier exploration maximum cost:* Respecting criteria 2 does not guarantee a unique solution, for example Figure 1 illustrates a situation where two solutions respect criteria 1 and 2 but the one showed on bottom will result in a lower exploration time. This is due to the fact that the time for all frontiers to be explored is determined by the maximum exploration time among all frontiers. A third criteria is therefore the minimization of the maximum cost :

$$C_{max}(\mathcal{A}) = \max_i \sum_{j=1}^m \alpha_{ij} C_{ij} \quad (3)$$

### Complexity issue

The challenge of the frontier allocation problem lies in the number of possible assignments being equal to the number of permutations i.e. sequences without repetition. Therefore, in the best and most common case when  $n \leq m$ , it is equal to  $\frac{m!}{(m-n)!}$ . When  $n > m$  it becomes even greater. These figures make the search for the optimal assignment intractable for large teams of robots and an approximation is therefore necessary.

### III. STATE OF THE ART

Frontier allocation is a particular case of the multi-robot task allocation problem (MRTA). More specifically, using Gerkey and Mataric's taxonomy [GM04], it features single-robot tasks (frontiers can be explored by one robot) and single-task robots (robot can explore 1 frontier at the same time). It is also a dynamic task allocation problem because task allocation needs to be updated everytime a frontier is created or disappears and when robots move.

The main approaches used for frontier allocation can be classified by the way collaboration is achieved. In this section, previously proposed methods are presented in 3 groups : first the "implicit coordination" where no communication

is necessary for collaboration then the centralized approach where a central agent decides which frontier to assign to each robot and finally the decentralized decision making to assign frontiers.

### A. No explicit coordination

Sharing a map can be enough to achieve collaboration : when a frontier is explored by one robot, the information acquired is shared with the fleet of robot and the frontier will not be explored again by another robot.

The earliest exploration methods were based on random walks or wall following, but a technique admitted as efficient is to explore successively the frontiers created between explored and empty areas [Yam97]. Robots move towards the frontiers thus observing unexplored areas. More precisely, the robot reaches a configuration (position and heading) allowing it to observe the frontier, during an exploration the robot will be required to reach these different configurations and observe a frontier. Hereafter the terms exploring a frontier are used to name this sequence of action.

*Closest Frontier:* In 1997, Yamauchi introduced the very popular frontier-based exploration algorithm [Yam97]. He first referred to frontiers as the border between known free space and an unexplored area. A robot moving towards a frontier will therefore sense new areas of the map, repeating this operation increase the size of  $\mathcal{E}_{exp}$  until it is equal to  $\mathcal{E}$ .

In the multi-robot extension [Yam98], robots share the gathered information so that they build a similar map resulting in a similar list of frontiers. Each robot moves towards its closest frontier, makes an observation and broadcasts its results. No communication is necessary in order to coordinate the robots. This pioneer work pointed out the issue of choosing frontiers to assign to each robot. Using this approach, robots are attracted to their closest frontier. By adopting this behavior, multiple robots are often assigned to the same frontier not taking advantage of their number to explore different areas. Figure 2 illustrates a situation where two robots are assigned to the same frontier, leaving unexplored areas without robots.

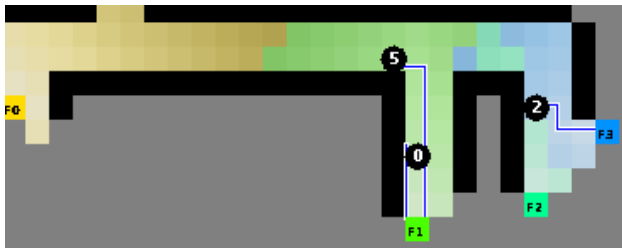

Fig. 2: Resulting frontier assignment using the Closest Frontier algorithm. There is no consideration for the position of other robots in the environment

This method is asynchronous, distributed and robust to robot failures. Collaboration is said to be implicit because it is achieved only by sharing information gathered on the environment. Figure 3 illustrates a situation when 3 robots

are assigned to 3 different frontiers thus achieving a good cooperation.

Algorithm 1 is optimal in regards to the exploration cost (criteria 2) at each step.

---

#### Algorithm 1: Closest frontier

---

**Input:**  $\mathcal{C}_i$  cost vector of robot  $i$  to each frontier

**Output:**  $\mathcal{A}_i$  robot  $i$  assignment

**begin**

$\alpha_{ij} = 1$  such that  $j = \min \mathcal{C}_{ij} \quad \forall j \in \mathcal{F}_j$

**end**

---

The computational complexity of this algorithm is  $O(m)$ .

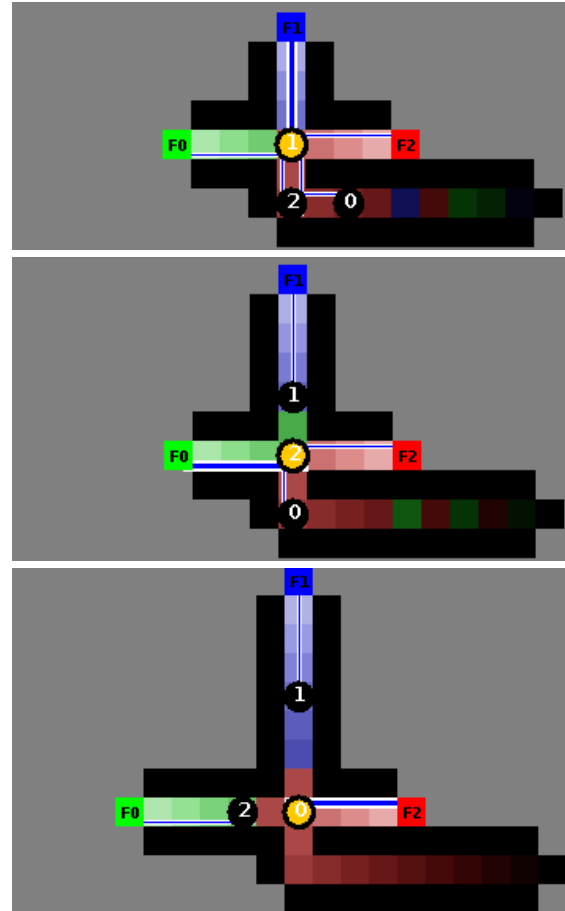

Fig. 3: Implicit coordination with closest frontier algorithm. Top-bottom description : when the first robot  $R1$  reaches the intersection it discovers the 3 frontiers equidistant to its location and randomly chooses  $F1$ , when  $R2$  reaches the intersection,  $R1$  has pushed  $F1$  further to the intersection and only two frontiers are closest and equidistant to its location, robot 2 chooses randomly  $F0$  between  $F0$  and  $F2$ , when the third robot  $R0$  arrives at the intersection, only one frontier is closer to it and therefore,  $R0$  chooses  $F2$ .

### B. Centralized coordination

In a centralized coordination scheme, one central agent decides which frontier, each robots should explore. A centra-

lized coordination scheme represents a single point of failure and requires an additional computation and communication cost.

1) *Greedy*: Greedy algorithm are commonly used for task allocation and the frontier assignment problem is a task allocation problem. At each iteration of the allocation loop, the robot-frontier pair with lowest cost is assigned and removed from their respective list. This is repeated until all robots have a frontier assigned. The standard way of applying the Greedy algorithm is centralized but a decentralized version is given in Algorithm 2, each robot then computes the allocation of all the other robots until it finds its assignation. An example of a Greedy assignation is illustrated on figure 4, due to the robots considering the assignation of other robots, robots are evenly assigned to frontier. Most frontier allocation approaches are Greedy based [BMS02], [SAB<sup>+</sup>00] [ZSDT02].

---

**Algorithm 2:** Greedy

---

**Input:**  $\mathcal{C}$  Cost Matrix

**Output:**  $\alpha_{ij}$  assignation of robot  $\mathcal{R}_i$  to frontier  $\mathcal{F}_j$

**while**  $\mathcal{R}_i$  has no frontier assigned **do**

    Find  $i, j = \operatorname{argmin} C_{ij} \quad \forall \mathcal{R}_i \in \mathcal{R}, \forall \mathcal{F}_j \in \mathcal{F}$

$\alpha_{ij} = 1$

$\mathcal{R} = \mathcal{R} \setminus \mathcal{R}_i$

$\mathcal{F} = \mathcal{F} \setminus \mathcal{F}_j$

**IF**  $\mathcal{F} = \emptyset$  **THEN**  $\mathcal{F} = \mathcal{F}_{init}$

**end**

---

The complexity of the greedy assignation algorithm 2 is  $O(n^2m)$ .

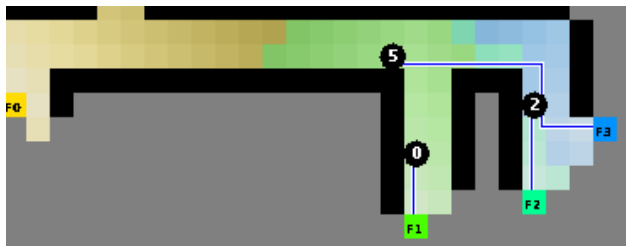

Fig. 4: Resulting frontier assignment using the Greedy algorithm.

2) *Utility greedy*: The term utility refers to the estimated information gain, evaluating it requires to estimate the expected area discovered by exploring a frontier reduced by the possible overlap in between robot sensors.

Simmons et al. [SAB<sup>+</sup>00] and Burgard et al. [BMS02] proposed a utility function based approach. The utility function calculates a gain depending on the robot expected sensor coverage taking into consideration the sensor coverage of other robots and the cost of reaching the target points. This way, robots are assigned to targets sufficiently distant from each other and, therefore, maximize coverage by minimizing the potential overlap in information gain. One central agent collects the utility of each robot and assigns greedily robot-robot pairs. Due to a better distribution of the robots in the

environment, the gain of such approaches over basic frontier exploration is significant (see Stachniss' [SMMB08]) but depends on the environment because the expected visible area behind the frontier is unknown.

### C. Decentralized coordination

In order to be decentralized, the utility based method was extended by Zlot et al. [ZSDT02] by using a market based approach where robots bid on targets, thus negotiating their assignments.

*Bidding algorithms*: Existing bidding algorithm for frontier allocation usually works with the same principle as a greedy algorithm.

Each robot evaluates a cost of travel and an estimate of the future information gain for each frontier. Each robot then emits its bids on each frontier, the robot with the highest bid wins the frontier. They can either be centralized [SAB<sup>+</sup>00], one central agent receives bids from all robots and assigns frontiers to each robot or decentralized as [ZSDT02] and [CCK02], robots who discover a frontier is auctioneer for this frontier.

### D. Conclusion

Frontier-based methods are inherently simpler than utility based approaches, that require the extra step of computing the utility of each frontier. To our knowledge, efficient frontier-based multi-robot exploration approaches rely on a Greedy frontier allocation that has a high complexity ( $O(n^2m)$ ). The Closest Frontier algorithm has a low complexity but lacks to provide a good coordination. The method proposed hereafter strives for achieving a good coordination with a low complexity algorithm.

## IV. PROPOSED APPROACH

### A. Principle

Our approach for the frontier allocation is based on the distribution of robots among the frontier directions rather than only on the distances to the frontiers. So we consider the notion of position of a robot towards a frontier, by counting how many robots are closer to the frontier. To evaluate robots' positions we use, as other methods, the cost matrix.

In order to compute the cost matrix we build a local minimum free artificial potential field from each frontier using the wavefront propagation algorithm [BLL91]. It gives the shortest paths to a frontier from any point in the environment therefore for all robots. Moreover it allows to navigate to the frontier by descending the negative gradient. In comparison, presented approaches compute a path from each robot to each frontier. Thus if a robot requires the cost for another robot it needs to ask the other robot for it or to compute the path it would follow.

The scheme of our approach for exploration and mapping can be summarized in three steps :

- 1) Frontiers identification
- 2) Computation of the potential fields from the frontiers
- 3) Allocation of frontiers to the robots

Robots then navigate towards their assigned frontiers. We now detail steps 2 and 3 in the next sections.

## B. Grids computation

To compute the potential field in a general case with real informations from robots sensors, we need to compute several grids.

The map representation used is an Occupancy grid (OG) [Elf89], which is a square tessellation of the environment into cells of the desired size, maintaining a probabilistic estimate of their occupancy state.

The potential field grid computation is formed of three main steps. First, each robot computes a configuration space grid using its OG. To simplify the approach and reduce the computation cost, robots are assumed to have a circular shape and be holonomic. The configuration space grid is then computed by enlarging obstacle by the size of the robot. This configuration space grid is then used to identify frontiers. Finally, the wavefront propagation algorithm [BLL91] is used on the configuration space grid to generate a potential field grid ascending from each frontier cells. The wavefront propagation algorithm is a breadth-first search algorithm that assigns to each cell the distance, in steps, necessary to reach a cell. This algorithm has the advantage of computing the shortest path from any cell in the environment to the goal configurations. Its complexity is  $\mathcal{O}(n)$  where  $n$  is the number of reachable cells. The potential field grid is re-computed periodically, at least every time the robot is close to reaching the frontier, but ideally every time new information is significant enough to modify the configuration grid and could therefore affect the robot path.

Navigation will be done by following the negative of the gradient of the chosen potential field grid.

## C. Frontier Allocation

Frontier assignation is done in a decentralized way i.e. each robot computes the frontier it will explore next.

1) *Description:* Given the position of all robots and the potential field grids of each frontier, the creation of the cost matrix is straightforward, as the travel distance for a robot to a frontier is instantly given by the value of the potential field grid.

Our approach consists in assigning to a robot a frontier for which it is in best position, i.e. the frontier having less robots closer than it to the frontier. Formally we set  $\mathcal{P}_{ij}$  the position of a robot  $i$  towards a frontier  $j$  as 
$$\sum_{k \in \mathcal{R}_k, k=i, C_{kj} < C_{ij}} 1$$

It computes the number of robots closer than it towards the considered frontier.

By reasoning on positions instead of distances, 2 close robots will be assigned on frontiers having distinct directions where they will be in first position whatever the distances. We will see in next section that such an approach separates robots on different directions favouring the criteria (1) of a well balanced assignation on frontiers.

Figure 5 illustrates such an assignation. Robot 5 is assigned to frontier F0 instead of a closer frontier which is F3 being closer and without any assigned robots. Indeed robot 5 is in second position for frontiers F1, F2 and F3.

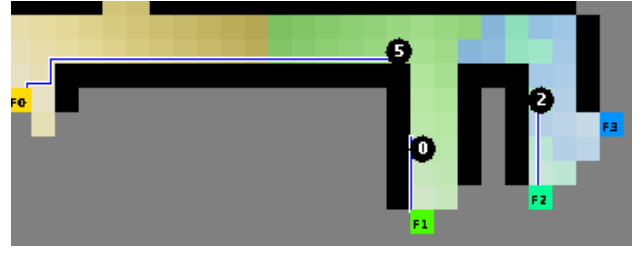

Fig. 5: Resulting frontier assignment using the MinPosition algorithm.

2) *Algorithm:* The algorithm for assignation, called Minimum Position, is given in Algorithm 3.

---

### Algorithm 3: Minimum position

---

**Input:**  $\mathcal{C}$  cost matrix

**Output:**  $\alpha_{ij}$  assignation of robot  $\mathcal{R}_i$

**foreach**  $\mathcal{F}_j \in \mathcal{F}$  **do**

$$\mathcal{P}_{ij} = \sum_{k \in \mathcal{R}_k, k=i, C_{kj} < C_{ij}} 1$$

**end**

$$\alpha_{ij} = 1 \text{ such that } j = \underset{\mathcal{F}_j \in \mathcal{F}}{\operatorname{argmin}} \mathcal{P}_{ij}$$

*In case of equality choose the minimum cost among min  $\mathcal{P}_{ij}$*

---

The complexity of Minimum position assignation algorithm 3 is  $\mathcal{O}(nm)$ .

A typical problem with the closest frontier allocation occurs when a group of robots stands near a frontier with a different frontier further in the opposite direction, all robots will choose the same frontier whereas the MinPosition algorithm will separate the group of robots in two even groups assigned to the two different frontiers. This difference is illustrated with figure 6.



(a) Closest Frontier Allocation : all robots are assigned to the same, closest, frontier



(b) Min Position Allocation : robots are evenly separated among the 2 frontiers

Fig. 6: Difference between Closest Frontier and Min Position Frontier allocation

Similar to the closest frontier algorithm, our algorithm features implicit coordination and does not require communication in between robots or with a central agent in order to assign frontiers. Coordination in between robots is achieved only by sharing the map and the robots positions. Simulation results demonstrated that the Minimum Position algorithm outperforms the closest frontier algorithm like the



Fig. 7: Example of a maze environment



Fig. 8: Hospital environment from Player/Stage

greedy algorithm while having a lower computational and communication complexity.

## V. EXPERIMENTS

### A. Simulation : Frontier Assignment evaluation

Evaluation of the proposed method were carried out in a simulator specifically developed in JAVA. The model used is simple, environment and time are discrete, the robot's size is set to the dimension of a cell. Robots know with certainty their location and can sense their neighborhood perfectly. Simulated environments are buildings and randomly generated mazes (illustrated in Figures 7 and 8). Exploration times were measured when robots had built the map of the whole environments.

Figures 9 and 10 compares the different methods in exploration times, given in simulation steps, while varying the number of robots. The methods compared are Closest Frontier, Greedy and Min Position (algorithms 1 2 and 3). We observe that the Greedy and Min Position algorithm are more efficient, this is even more true as the number of robots increases reaching a maximum of 15% improvement on the hospital environment and 20% on the maze environments. The proposed algorithm appears slightly better than the Greedy algorithm, a difference more significant on the maze environments. On average, the application of the Greedy and Min Position algorithms allow improvements of 8% and 12% respectively compared to the Closest frontier method.

The greedy algorithm assignation respects criteria 1 of a balanced assignation among frontiers but when the frontiers are far there is no need to decide which frontier each

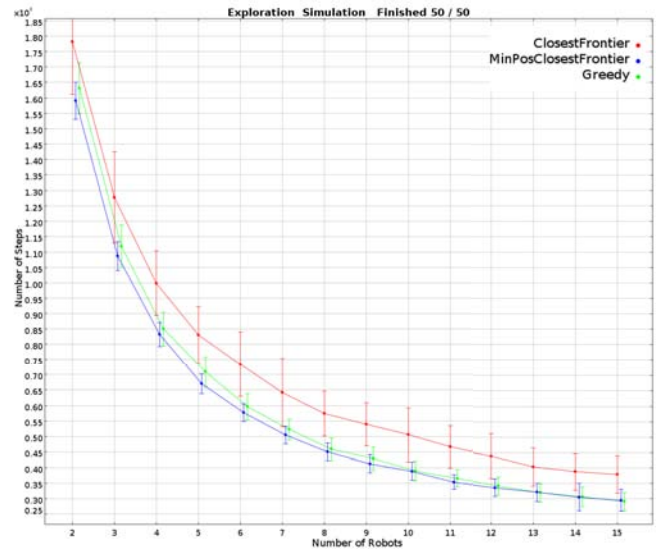

Fig. 9: Exploration results for simulations in maze environment

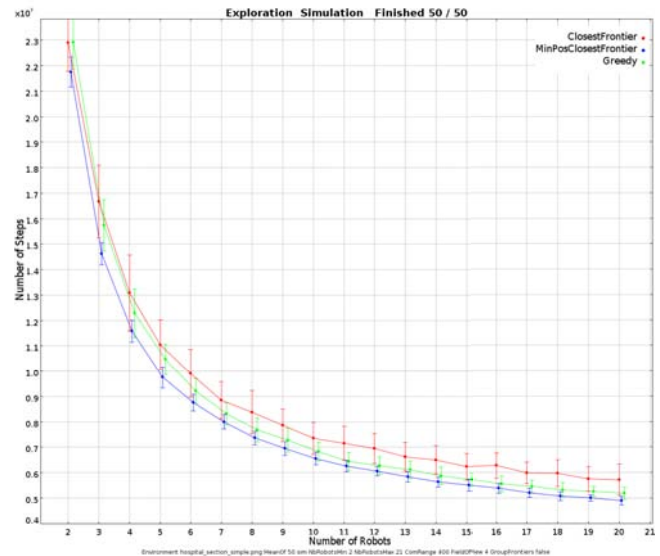

Fig. 10: Exploration results for simulations in the Player/Stage hospital environment

robot will eventually explore as the assignation is likely to change. A more important criteria addressed by the Min Position algorithm is to separate them in balanced group size towards frontiers directions. Then, an adequate dynamical behavior emerges that tends to separate grouped robots. Two robots following each other to reach the same frontier will separate as soon as the first one moves away from an unassigned frontier. Indeed, the second robot is then in first position towards this frontier and therefore assigned to it. This behavior is a similar to the implicit coordination featured by the Closest frontier algorithm but the separation happens more rapidly.

## B. Robots : Navigation method validation

Figure 11 shows the Kheperas III autonomous robots we have equipped with laser rangefinder to implement our multi-robot exploration approach. First tests carried out in small environments were satisfying.



Fig. 11: Two Khepera III (K-Team Corporation) equipped with laser rangefinder (Hokuyo URG-04LX)

Figure 12 illustrates the states of each of the map produced during an experiment using a robot in an office like environment. In this experiment, the robot had an obstacle in front of it blocking its field of view and just finished exploring the frontier behind it when the capture was taken. Other experiments demonstrated the ability of the robot to explore a maze.

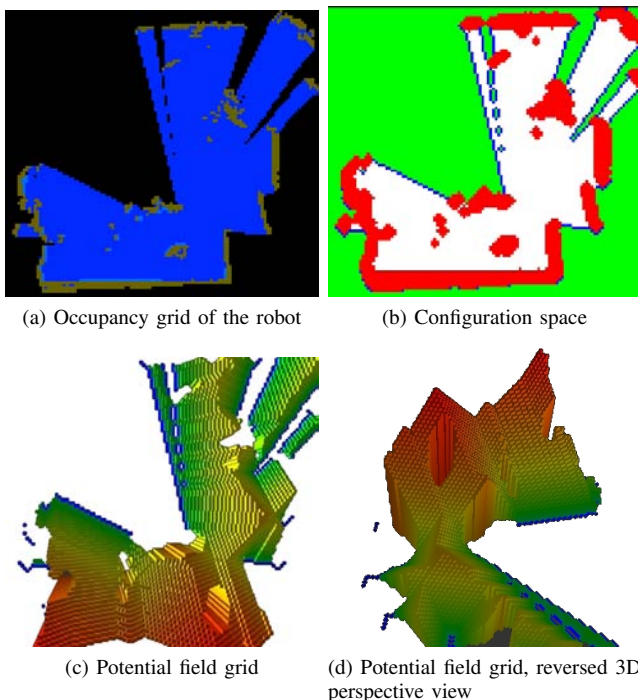

Fig. 12: The different grids used for exploration

The navigation algorithm for exploration was also tested with a single robot during the first edition of ANR-DGA Carotte Challenge where a single robot mapped more than a 50 meter square environment, thus demonstrating its validity for exploration.

We currently preparing the deployment of the exploration algorithm with several Khepera III robots and with several mini-Pekoo robots.

## VI. CONCLUSION

In this paper, the multi-robot exploration problem was addressed. We proposed a novel algorithm to assign frontiers that should be explored by robots. It is based on the concept of position towards a frontier, defined by the number of robots closer to the frontier than the robot evaluating its position. Each robot is assigned to the frontier for which it is in best position, rather than considering its distance to the frontiers. Performance measures in simulation demonstrated that our approach is more efficient in total exploration time than a Greedy or a Closest Frontier assignment. Furthermore our algorithm has a lower complexity than standard Greedy approaches. Finally, it is decentralized and asynchronous, a robot decides autonomously without requiring communication with other robots to choose the frontier it will explore next.

The perspectives of this work include to deploy and to measure the performances of the proposed algorithm with several robots. We also plan to compare the approach with methods exploiting the utility functions, even they requires an additional computational and communication cost.

## ACKNOWLEDGEMENT

This work has been partially supported by the French National Research Agency (Agence Nationale de la Recherche, ANR) and Defence Procurement Agency (Direction Générale de l'Armement, DGA) through the Cartomatic project in ANR Carotte Challenge.

## REFERENCES

- [BLL91] J. Barraquand, B. Langlois, and J.-C. Latombe. Numerical potential field techniques for robot path planning. In *Advanced Robotics, 1991. 'Robots in Unstructured Environments', 91 ICAR., Fifth International Conference on*, pages 1012 –1017 vol.2, jun. 1991.
- [BM10] Derek J. Bennet and Colin R. McInnes. Distributed control of multi-robot systems using bifurcating potential fields. *Robotics and Autonomous Systems*, 58(3) :256 – 264, 2010. Towards Autonomous Robotic Systems 2009 : Intelligent, Autonomous Robotics in the UK.
- [BMS02] W. Burgard, M. Moors, and F. Schneider. Collaborative exploration of unknown environments with teams of mobile robots. In M. Beetz, J. Hertzberg, M. Ghallab, and M.E. Pollack, editors, *Plan-Based Control of Robotic Agents*, volume 2466 of *Lecture Notes in Computer Science*. Springer Verlag, 2002.
- [CCK02] L. Chaimowicz, M.F.M. Campos, and V. Kumar. Dynamic role assignment for cooperative robots. In *Robotics and Automation, 2002. Proceedings. ICRA '02. IEEE International Conference on*, volume 1, pages 293 – 298 vol.1, 2002.
- [Elf89] A. Elfes. Using occupancy grids for mobile robot perception and navigation. *Computer*, 22(6) :46–57, Jun 1989.
- [GM04] Brian P. Gerkey and Maja J. Mataric. A formal analysis and taxonomy of task allocation in multi-robot systems. *The Intl. J. of Robotics Research*, 23(9) :939–954, sep 2004.
- [McC08] Ruben Martinez-cantin and Jose A. Castellanos. Multi-robot marginal-slam. *IJCAI Workshop on Multi-Robotic Systems for Societal Applications*, 2008.



- [SAB<sup>+</sup>00] R. Simmons, D. Apfelbaum, W. Burgard, M. Fox, D. an Moors, S. Thrun, and H. Younes. Coordination for multi-robot exploration and mapping. In *Proceedings of the AAAI National Conference on Artificial Intelligence*, Austin, TX, 2000. AAAI.
- [SHSP06] J. Stipes, R. Hawthorne, D. Scheidt, and D. Pacifico. Co-operative localization and mapping. In *Networking, Sensing and Control, 2006. ICNSC '06. Proceedings of the 2006 IEEE International Conference on*, pages 596–601, 0-0 2006.
- [SMMB08] Cyrill Stachniss, Oscar Martinez Mozos, and Wolfram Burgard. Efficient exploration of unknown indoor environments using a team of mobile robots. *Annals of Mathematics and Artificial Intelligence*, 52(2-4) :205–227, 2008.
- [Sta06] C. Stachniss. *Exploration and Mapping with Mobile Robots*. PhD thesis, University of Freiburg, Department of Computer Science, April 2006.
- [TL05] Sebastian Thrun and Yufeng Liu. Multi-robot slam with sparse extended information filters. In *International Journal of Robotics Research*, pages 254–266. SAGE, 2005.
- [Yam97] Brian Yamauchi. A frontier-based approach for autonomous exploration. In *CIRA '97 : Proceedings of the 1997 IEEE International Symposium on Computational Intelligence in Robotics and Automation*, page 146, Washington, DC, USA, 1997. IEEE Computer Society.
- [Yam98] Brian Yamauchi. Frontier-based exploration using multiple robots. In *AGENTS '98 : Proceedings of the second international conference on Autonomous agents*, pages 47–53, New York, NY, USA, 1998. ACM.
- [ZSDT02] Robert Michael Zlot, Anthony (Tony) Stentz, M Bernardine Dias, and Scott Thayer. Multi-robot exploration controlled by a market economy. In IEEE, editor, *IEEE International Conference on Robotics and Automation*, volume 3, pages 3016 – 3023, May 2002.