



HAL
open science

New Semiconcavity Results for Optimal Control Problems

Piermarco Cannarsa

► **To cite this version:**

Piermarco Cannarsa. New Semiconcavity Results for Optimal Control Problems. SADCO Kick off, Mar 2011, Paris, France. inria-00585863

HAL Id: inria-00585863

<https://inria.hal.science/inria-00585863>

Submitted on 14 Apr 2011

HAL is a multi-disciplinary open access archive for the deposit and dissemination of scientific research documents, whether they are published or not. The documents may come from teaching and research institutions in France or abroad, or from public or private research centers.

L'archive ouverte pluridisciplinaire **HAL**, est destinée au dépôt et à la diffusion de documents scientifiques de niveau recherche, publiés ou non, émanant des établissements d'enseignement et de recherche français ou étrangers, des laboratoires publics ou privés.

New Semiconcavity Results for Optimal Control Problems

Piermarco Cannarsa

University of Rome "Tor Vergata" (Italy)

<http://www.mat.uniroma2.it>

ITN SADCO – ENSTA PARISTECH

March 3-4, 2011



Outline

Semiconcave functions

Definitions and general properties

Generalized gradients

Singularities of semiconcave functions

Semiconcave functions and optimal control

Mayer problem

Differential inclusions

Semiconcave functions and Hamilton-Jacobi equations

Smoothness of extremal trajectories

Semiconcavity of solutions

Conclusions



Outline

Semiconcave functions

Definitions and general properties

Generalized gradients

Singularities of semiconcave functions

Semiconcave functions and optimal control

Mayer problem

Differential inclusions

Semiconcave functions and Hamilton-Jacobi equations

Smoothness of extremal trajectories

Semiconcavity of solutions

Conclusions



Outline

Semiconcave functions

Definitions and general properties

Generalized gradients

Singularities of semiconcave functions

Semiconcave functions and optimal control

Mayer problem

Differential inclusions

Semiconcave functions and Hamilton-Jacobi equations

Smoothness of extremal trajectories

Semiconcavity of solutions

Conclusions



Outline

Semiconcave functions

Definitions and general properties

Generalized gradients

Singularities of semiconcave functions

Semiconcave functions and optimal control

Mayer problem

Differential inclusions

Semiconcave functions and Hamilton-Jacobi equations

Smoothness of extremal trajectories

Semiconcavity of solutions

Conclusions



Outline

Semiconcave functions

Definitions and general properties

Generalized gradients

Singularities of semiconcave functions

Semiconcave functions and optimal control

Mayer problem

Differential inclusions

Semiconcave functions and Hamilton-Jacobi equations

Smoothness of extremal trajectories

Semiconcavity of solutions

Conclusions



definition

 $\Omega \subset \mathbb{R}^N$ domain

Definition

 $u : \Omega \rightarrow \mathbb{R}$ (linearly) semiconcave

- ▶ u continuous in Ω
- ▶ $\exists C \geq 0$ (semiconcavity constant) such that

$$u(x+h) + u(x-h) - 2u(x) \leq C|h|^2$$

for all $x, h \in \mathbb{R}^N$ such that $[x-h, x+h] \subset \Omega$

more general notion

$$u(x+h) + u(x-h) - 2u(x) \leq |h|\omega(|h|)$$

where $\omega : [0, \infty) \rightarrow [0, \infty)$ (semiconcavity modulus) upper semicontinuous, nondecreasing, $\omega(r) \rightarrow 0$ ($r \rightarrow 0$)



definition

$\Omega \subset \mathbb{R}^N$ domain

Definition

$u : \Omega \rightarrow \mathbb{R}$ (linearly) semiconcave

- ▶ u continuous in Ω
- ▶ $\exists C \geq 0$ (semiconcavity constant) such that

$$u(x+h) + u(x-h) - 2u(x) \leq C|h|^2$$

for all $x, h \in \mathbb{R}^N$ such that $[x-h, x+h] \subset \Omega$

more general notion

$$u(x+h) + u(x-h) - 2u(x) \leq |h|\omega(|h|)$$

where $\omega : [0, \infty) \rightarrow [0, \infty)$ (semiconcavity modulus) upper semicontinuous, nondecreasing, $\omega(r) \rightarrow 0$ ($r \rightarrow 0$)



equivalent properties

$u : \Omega \rightarrow \mathbb{R}$ semiconcave with constant $C \geq 0$

iff

any of the following holds:

- ▶ for all x, y such that $[x, y] \subset \Omega$ and all $\lambda \in [0, 1]$

$$\lambda u(x) + (1 - \lambda)u(y) - u(\lambda x + (1 - \lambda)y) \leq \frac{C}{2} \lambda(1 - \lambda) |x - y|^2$$

- ▶ the function $x \rightarrow u(x) - \frac{C}{2}|x|^2$ is concave in Ω
- ▶ for any $\nu \in \mathbb{R}^N$ such that $|\nu| = 1$

$$\frac{\partial^2 u}{\partial \nu^2} \leq C \quad \text{in (distributional sense on) } \Omega$$

- ▶ $u(x) = \inf_{i \in \mathcal{I}} u_i(x)$ where $\|D^2 u_i\|_\infty \leq C$ for all $i \in \mathcal{I}$



equivalent properties

$u : \Omega \rightarrow \mathbb{R}$ semiconcave with constant $C \geq 0$

iff

any of the following holds:

- ▶ for all x, y such that $[x, y] \subset \Omega$ and all $\lambda \in [0, 1]$

$$\lambda u(x) + (1 - \lambda)u(y) - u(\lambda x + (1 - \lambda)y) \leq \frac{C}{2} \lambda(1 - \lambda) |x - y|^2$$

- ▶ the function $x \rightarrow u(x) - \frac{C}{2}|x|^2$ is concave in Ω
- ▶ for any $\nu \in \mathbb{R}^N$ such that $|\nu| = 1$

$$\frac{\partial^2 u}{\partial \nu^2} \leq C \quad \text{in (distributional sense on) } \Omega$$

- ▶ $u(x) = \inf_{i \in \mathcal{I}} u_i(x)$ where $\|D^2 u_i\|_\infty \leq C$ for all $i \in \mathcal{I}$



equivalent properties

$u : \Omega \rightarrow \mathbb{R}$ semiconcave with constant $C \geq 0$

iff

any of the following holds:

- ▶ for all x, y such that $[x, y] \subset \Omega$ and all $\lambda \in [0, 1]$

$$\lambda u(x) + (1 - \lambda)u(y) - u(\lambda x + (1 - \lambda)y) \leq \frac{C}{2} \lambda(1 - \lambda) |x - y|^2$$

- ▶ the function $x \rightarrow u(x) - \frac{C}{2}|x|^2$ is concave in Ω
- ▶ for any $\nu \in \mathbb{R}^N$ such that $|\nu| = 1$

$$\frac{\partial^2 u}{\partial \nu^2} \leq C \quad \text{in (distributional sense on) } \Omega$$

- ▶ $u(x) = \inf_{i \in \mathcal{I}} u_i(x)$ where $\|D^2 u_i\|_\infty \leq C$ for all $i \in \mathcal{I}$



equivalent properties

$u : \Omega \rightarrow \mathbb{R}$ semiconcave with constant $C \geq 0$

iff

any of the following holds:

- ▶ for all x, y such that $[x, y] \subset \Omega$ and all $\lambda \in [0, 1]$

$$\lambda u(x) + (1 - \lambda)u(y) - u(\lambda x + (1 - \lambda)y) \leq \frac{C}{2} \lambda(1 - \lambda) |x - y|^2$$

- ▶ the function $x \rightarrow u(x) - \frac{C}{2}|x|^2$ is concave in Ω
- ▶ for any $\nu \in \mathbb{R}^N$ such that $|\nu| = 1$

$$\frac{\partial^2 u}{\partial \nu^2} \leq C \quad \text{in (distributional sense on) } \Omega$$

- ▶ $u(x) = \inf_{i \in \mathcal{I}} u_i(x)$ where $\|D^2 u_i\|_\infty \leq C$ for all $i \in \mathcal{I}$



equivalent properties

$u : \Omega \rightarrow \mathbb{R}$ semiconcave with constant $C \geq 0$

iff

any of the following holds:

- ▶ for all x, y such that $[x, y] \subset \Omega$ and all $\lambda \in [0, 1]$

$$\lambda u(x) + (1 - \lambda)u(y) - u(\lambda x + (1 - \lambda)y) \leq \frac{C}{2} \lambda(1 - \lambda) |x - y|^2$$

- ▶ the function $x \rightarrow u(x) - \frac{C}{2}|x|^2$ is concave in Ω
- ▶ for any $\nu \in \mathbb{R}^N$ such that $|\nu| = 1$

$$\frac{\partial^2 u}{\partial \nu^2} \leq C \quad \text{in (distributional sense on) } \Omega$$

- ▶ $u(x) = \inf_{i \in \mathcal{I}} u_i(x)$ where $\|D^2 u_i\|_\infty \leq C$ for all $i \in \mathcal{I}$



why study semiconcave functions?

$$u(x) = \inf_{i \in \mathcal{I}} u_i(x) \quad x \in \mathbb{R}^N$$

- ▶ u_i affine $\Rightarrow u$ concave
- ▶ $\|D^2 u_i\|_\infty \leq C \Rightarrow u$ semiconcave

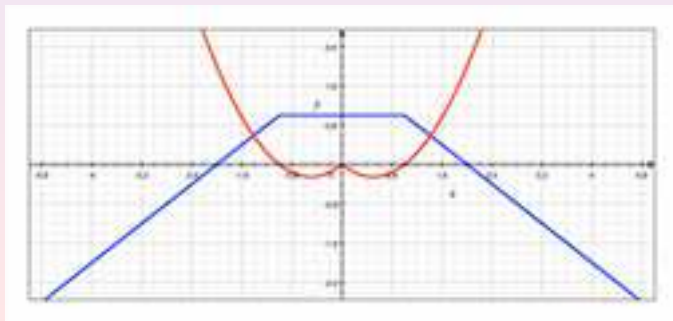

why study semiconcave functions?

$$u(x) = \inf_{i \in \mathcal{I}} u_i(x) \quad x \in \mathbb{R}^N$$

- ▶ u_i affine $\Rightarrow u$ concave
- ▶ $\|D^2 u_i\|_\infty \leq C \Rightarrow u$ semiconcave

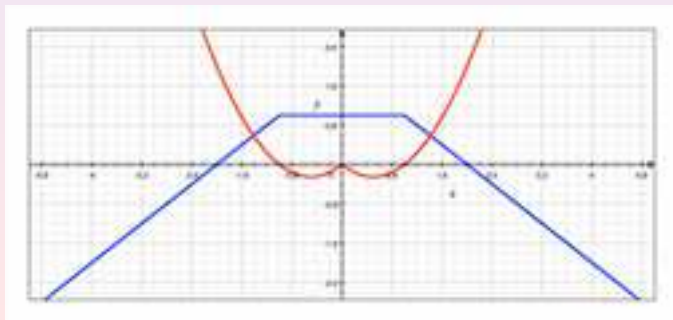

why study semiconcave functions?

$$u(x) = \inf_{i \in \mathcal{I}} u_i(x) \quad x \in \mathbb{R}^N$$

- ▶ u_i affine $\Rightarrow u$ concave
- ▶ $\|D^2 u_i\|_\infty \leq C \Rightarrow u$ semiconcave

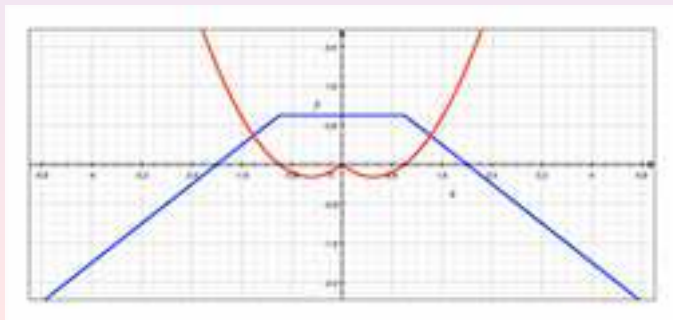

references

- ▶ uniqueness for pdes Kruzhkov (1960), Douglis (1961)
- ▶ control theory
 - ▶ Hrustalev (1978)
 - ▶ C – Soner (1987) power-like modulus
 - ▶ C – Frankowska (1991) general modulus
 - ▶ Fleming – McEneaney (2000) nonlinear filtering
 - ▶ Rifford (2000, 2002) feedback stabilization
 - ▶ ...
- ▶ nonsmooth analysis Rockafellar (1982)
- ▶ comprehensive exposition
 - ▶ C – Sinestrari (Birkhäuser, 2004)
 - ▶ Villani (Springer, 2009)
- ▶ generalizations
 - ▶ Colombo – Marigonda (2006)
 - ▶ Colombo – Nguyen (2010)



references

- ▶ **uniqueness for pdes** Kruzhkov (1960), Douglis (1961)
- ▶ **control theory**
 - ▶ Hrustalev (1978)
 - ▶ C – Soner (1987) **power-like modulus**
 - ▶ C – Frankowska (1991) **general modulus**
 - ▶ Fleming – McEneaney (2000) **nonlinear filtering**
 - ▶ Rifford (2000, 2002) **feedback stabilization**
 - ▶ ...
- ▶ **nonsmooth analysis** Rockafellar (1982)
- ▶ **comprehensive exposition**
 - ▶ C – Sinestrari (Birkhäuser, 2004)
 - ▶ Villani (Springer, 2009)
- ▶ **generalizations**
 - ▶ Colombo – Marigonda (2006)
 - ▶ Colombo – Nguyen (2010)



references

- ▶ uniqueness for pdes Kruzhkov (1960), Douglis (1961)
- ▶ control theory
 - ▶ Hrustalev (1978)
 - ▶ C – Soner (1987) power-like modulus
 - ▶ C – Frankowska (1991) general modulus
 - ▶ Fleming – McEneaney (2000) nonlinear filtering
 - ▶ Rifford (2000, 2002) feedback stabilization
 - ▶ ...
- ▶ nonsmooth analysis Rockafellar (1982)
- ▶ comprehensive exposition
 - ▶ C – Sinestrari (Birkhäuser, 2004)
 - ▶ Villani (Springer, 2009)
- ▶ generalizations
 - ▶ Colombo – Marigonda (2006)
 - ▶ Colombo – Nguyen (2010)



references

- ▶ **uniqueness for pdes** Kruzhkov (1960), Douglis (1961)
- ▶ **control theory**
 - ▶ Hrustalev (1978)
 - ▶ C – Soner (1987) **power-like modulus**
 - ▶ C – Frankowska (1991) **general modulus**
 - ▶ Fleming – McEneaney (2000) **nonlinear filtering**
 - ▶ Rifford (2000, 2002) **feedback stabilization**
 - ▶ ...
- ▶ **nonsmooth analysis** Rockafellar (1982)
- ▶ **comprehensive exposition**
 - ▶ C – Sinestrari (Birkhäuser, 2004)
 - ▶ Villani (Springer, 2009)
- ▶ **generalizations**
 - ▶ Colombo – Marigonda (2006)
 - ▶ Colombo – Nguyen (2010)



references

- ▶ **uniqueness for pdes** Kruzhkov (1960), Douglis (1961)
- ▶ **control theory**
 - ▶ Hrustalev (1978)
 - ▶ C – Soner (1987) **power-like modulus**
 - ▶ C – Frankowska (1991) **general modulus**
 - ▶ Fleming – McEneaney (2000) **nonlinear filtering**
 - ▶ Rifford (2000, 2002) **feedback stabilization**
 - ▶ ...
- ▶ **nonsmooth analysis** Rockafellar (1982)
- ▶ **comprehensive exposition**
 - ▶ C – Sinestrari (Birkhäuser, 2004)
 - ▶ Villani (Springer, 2009)
- ▶ **generalizations**
 - ▶ Colombo – Marigonda (2006)
 - ▶ Colombo – Nguyen (2010)



Outline

Semiconcave functions

Definitions and general properties

Generalized gradients

Singularities of semiconcave functions

Semiconcave functions and optimal control

Mayer problem

Differential inclusions

Semiconcave functions and Hamilton-Jacobi equations

Smoothness of extremal trajectories

Semiconcavity of solutions

Conclusions



generalized differentials

$\Omega \subset \mathbb{R}^N$ domain $u : \Omega \rightarrow \mathbb{R}$

u semiconcave \implies u Locally Lipschitz
 \implies u differentiable a.e.

$x \in \Omega$

▶ limiting gradients

$$D^* u(x) = \left\{ \lim_{i \rightarrow \infty} Du(x_i) \mid x_i \rightarrow x \right\}$$

compact $\neq \emptyset$

▶ $D^+ u(x) = \text{co}(D^* u(x))$ superdifferential

($\implies D^+ u(x) = \partial u(x)$ Clarke's generalized differential)

$$D^+ u(x) = \left\{ p \in \mathbb{R}^N \mid \limsup_{y \rightarrow x} \frac{u(y) - u(x) - p \cdot (y - x)}{|y - x|} \leq 0 \right\}$$



generalized differentials

$\Omega \subset \mathbb{R}^N$ domain $u : \Omega \rightarrow \mathbb{R}$

u semiconcave \implies u Locally Lipschitz
 \implies u differentiable a.e.

$x \in \Omega$

- ▶ limiting gradients

$$D^*u(x) = \left\{ \lim_{i \rightarrow \infty} Du(x_i) \mid x_i \rightarrow x \right\}$$

compact $\neq \emptyset$

- ▶ $D^+u(x) = \text{co}(D^*u(x))$ superdifferential
 ($\implies D^+u(x) = \partial u(x)$ Clarke's generalized differential)

$$D^+u(x) = \left\{ p \in \mathbb{R}^N \mid \limsup_{y \rightarrow x} \frac{u(y) - u(x) - p \cdot (y - x)}{|y - x|} \leq 0 \right\}$$



generalized differentials

$\Omega \subset \mathbb{R}^N$ domain $u : \Omega \rightarrow \mathbb{R}$

u semiconcave \implies u Locally Lipschitz
 \implies u differentiable a.e.

$x \in \Omega$

- ▶ limiting gradients

$$D^*u(x) = \left\{ \lim_{i \rightarrow \infty} Du(x_i) \mid x_i \rightarrow x \right\}$$

compact $\neq \emptyset$

- ▶ $D^+u(x) = \text{co}(D^*u(x))$ superdifferential

($\implies D^+u(x) = \partial u(x)$ Clarke's generalized differential)

$$D^+u(x) = \left\{ p \in \mathbb{R}^N \mid \limsup_{y \rightarrow x} \frac{u(y) - u(x) - p \cdot (y - x)}{|y - x|} \leq 0 \right\}$$



generalized differentials

$\Omega \subset \mathbb{R}^N$ domain $u : \Omega \rightarrow \mathbb{R}$

u semiconcave \implies u Locally Lipschitz
 \implies u differentiable a.e.

$x \in \Omega$

- ▶ limiting gradients

$$D^*u(x) = \left\{ \lim_{i \rightarrow \infty} Du(x_i) \mid x_i \rightarrow x \right\}$$

compact $\neq \emptyset$

- ▶ $D^+u(x) = \text{co}(D^*u(x))$ superdifferential

($\implies D^+u(x) = \partial u(x)$ Clarke's generalized differential)

$$D^+u(x) = \left\{ p \in \mathbb{R}^N \mid \limsup_{y \rightarrow x} \frac{u(y) - u(x) - p \cdot (y - x)}{|y - x|} \leq 0 \right\}$$



generalized differentials

$\Omega \subset \mathbb{R}^N$ domain $u : \Omega \rightarrow \mathbb{R}$

u semiconcave \implies u Locally Lipschitz
 \implies u differentiable a.e.

$x \in \Omega$

- ▶ limiting gradients

$$D^*u(x) = \left\{ \lim_{i \rightarrow \infty} Du(x_i) \mid x_i \rightarrow x \right\}$$

compact $\neq \emptyset$

- ▶ $D^+u(x) = \text{co}(D^*u(x))$ superdifferential

($\implies D^+u(x) = \partial u(x)$ Clarke's generalized differential)

$$D^+u(x) = \left\{ p \in \mathbb{R}^N \mid \limsup_{y \rightarrow x} \frac{u(y) - u(x) - p \cdot (y - x)}{|y - x|} \leq 0 \right\}$$



example 1

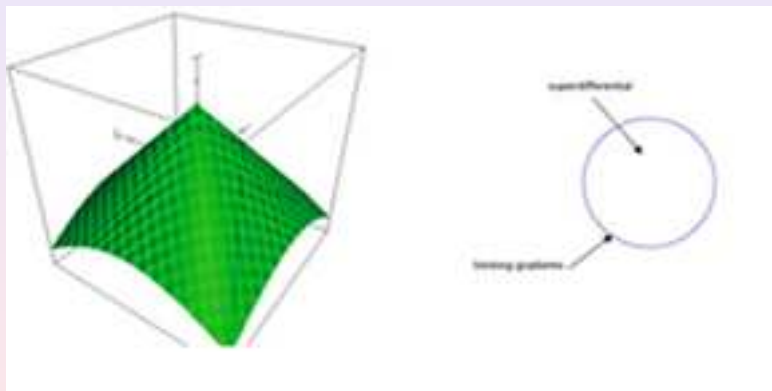

Figure: $u(x, y) = 3 - \sqrt{x^2 + y^2}$ and $D^+ u(0, 0)$



example 2

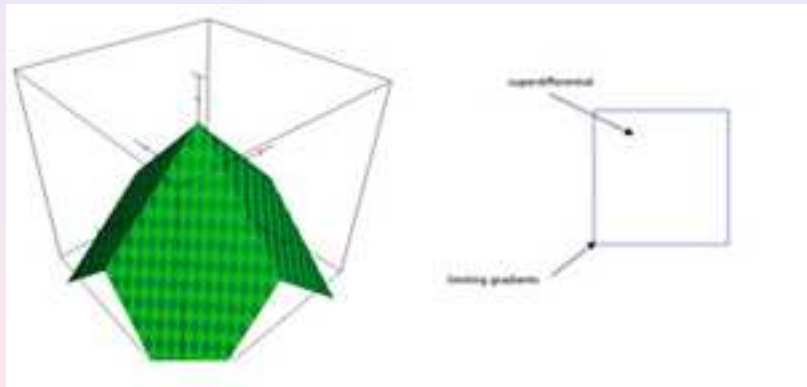

Figure: $u(x, y) = 3 - |x| - |y|$ and $D^+ u(0, 0)$



Outline

Semiconcave functions

Definitions and general properties

Generalized gradients

Singularities of semiconcave functions

Semiconcave functions and optimal control

Mayer problem

Differential inclusions

Semiconcave functions and Hamilton-Jacobi equations

Smoothness of extremal trajectories

Semiconcavity of solutions

Conclusions



singular point = nondifferentiability point

$u : \Omega \rightarrow \mathbb{R}$ semiconcave

Definition (singular set)

$$\begin{aligned}\Sigma(u) &= \{x \in \Omega \mid \nexists Du(x)\} \\ &= \{x \in \Omega \mid \dim D^+ u(x) \geq 1\}\end{aligned}$$

- ▶ $u \in \text{Lip}_{loc}(\Omega) \implies |\Sigma(u)| = 0$ (Lebesgue)
- ▶ $Du \in BV_{loc}(\Omega; \mathbb{R}^N) \implies \Sigma(u)$ countably \mathcal{H}^{N-1} -rectifiable
- ▶ magnitude of a singular point x

$$\kappa(x) = \dim D^+ u(x)$$



singular point = nondifferentiability point

$u : \Omega \rightarrow \mathbb{R}$ semiconcave

Definition (singular set)

$$\begin{aligned}\Sigma(u) &= \{x \in \Omega \mid \nexists Du(x)\} \\ &= \{x \in \Omega \mid \dim D^+ u(x) \geq 1\}\end{aligned}$$

- ▶ $u \in \text{Lip}_{loc}(\Omega) \implies |\Sigma(u)| = 0$ (Lebesgue)
- ▶ $Du \in BV_{loc}(\Omega; \mathbb{R}^N) \implies \Sigma(u)$ countably \mathcal{H}^{N-1} -rectifiable
- ▶ magnitude of a singular point x

$$\kappa(x) = \dim D^+ u(x)$$



singular point = nondifferentiability point

$u : \Omega \rightarrow \mathbb{R}$ semiconcave

Definition (singular set)

$$\begin{aligned}\Sigma(u) &= \{x \in \Omega \mid \nexists Du(x)\} \\ &= \{x \in \Omega \mid \dim D^+ u(x) \geq 1\}\end{aligned}$$

- ▶ $u \in \text{Lip}_{loc}(\Omega) \implies |\Sigma(u)| = 0$ (Lebesgue)
- ▶ $Du \in BV_{loc}(\Omega; \mathbb{R}^N) \implies \Sigma(u)$ countably \mathcal{H}^{N-1} -rectifiable
- ▶ magnitude of a singular point x

$$\kappa(x) = \dim D^+ u(x)$$



singular point = nondifferentiability point

$u : \Omega \rightarrow \mathbb{R}$ semiconcave

Definition (singular set)

$$\begin{aligned}\Sigma(u) &= \{x \in \Omega \mid \nexists Du(x)\} \\ &= \{x \in \Omega \mid \dim D^+ u(x) \geq 1\}\end{aligned}$$

- ▶ $u \in \text{Lip}_{loc}(\Omega) \implies |\Sigma(u)| = 0$ (Lebesgue)
- ▶ $Du \in BV_{loc}(\Omega; \mathbb{R}^N) \implies \Sigma(u)$ countably \mathcal{H}^{N-1} -rectifiable
- ▶ magnitude of a singular point x

$$\kappa(x) = \dim D^+ u(x)$$



example 1

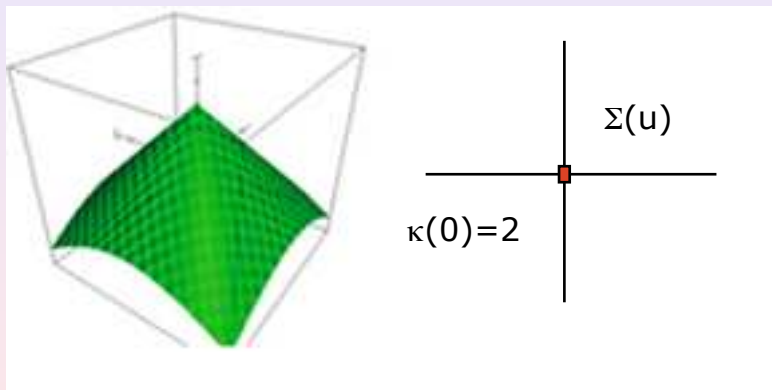

Figure: singular set of $u(x, y) = 3 - \sqrt{x^2 + y^2}$



example 2

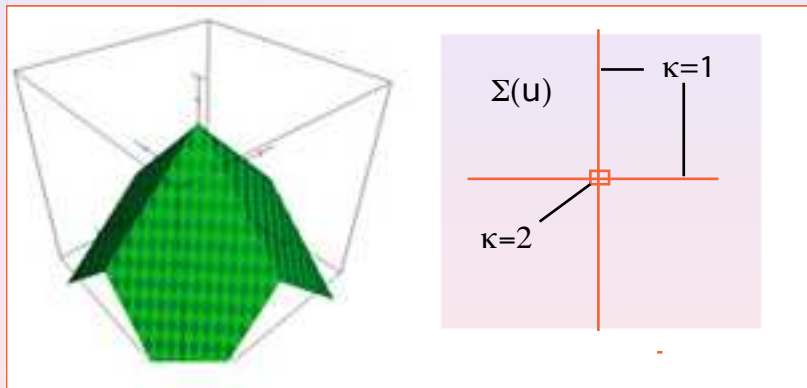

Figure: singular set of $u(x, y) = 3 - |x| - |y|$



sharp rectifiability

$u : \Omega \rightarrow \mathbb{R}$ semiconcave

singular sets of prescribed magnitude $k = 1, \dots, N$

$$\Sigma^k(u) := \{x \in \Omega \mid \dim D^+ u(x) = k\}$$

Theorem

$\Sigma^k(u)$ countably $(N - k)$ -rectifiable

▶ $\Sigma(u) = \bigcup_{k=1}^N \Sigma^k(u)$ countably $(N - 1)$ -rectifiable

▶ references

- ▶ Zajíček (1978), Veselý (1979)
linearly semiconcave functions
- ▶ Alberti, Ambrosio & C— (1992)
general semiconcave functions



sharp rectifiability

 $u : \Omega \rightarrow \mathbb{R}$ semiconcavesingular sets of prescribed magnitude $k = 1, \dots, N$

$$\Sigma^k(u) := \{x \in \Omega \mid \dim D^+ u(x) = k\}$$

Theorem

 $\Sigma^k(u)$ countably $(N - k)$ -rectifiable

- ▶ $\Sigma(u) = \bigcup_{k=1}^N \Sigma^k(u)$ countably $(N - 1)$ -rectifiable

- ▶ references

- ▶ Zajíček (1978), Veselý (1979)
linearly semiconcave functions
- ▶ Alberti, Ambrosio & C— (1992)
general semiconcave functions



sharp rectifiability

 $u : \Omega \rightarrow \mathbb{R}$ semiconcavesingular sets of prescribed magnitude $k = 1, \dots, N$

$$\Sigma^k(u) := \{x \in \Omega \mid \dim D^+ u(x) = k\}$$

Theorem

 $\Sigma^k(u)$ countably $(N - k)$ -rectifiable

- ▶ $\Sigma(u) = \bigcup_{k=1}^N \Sigma^k(u)$ countably $(N - 1)$ -rectifiable

- ▶ references

- ▶ Zajíček (1978), Veselý (1979)
linearly semiconcave functions
- ▶ Alberti, Ambrosio & C— (1992)
general semiconcave functions



sharp rectifiability

$u : \Omega \rightarrow \mathbb{R}$ semiconcave

singular sets of prescribed magnitude $k = 1, \dots, N$

$$\Sigma^k(u) := \{x \in \Omega \mid \dim D^+ u(x) = k\}$$

Theorem

$\Sigma^k(u)$ countably $(N - k)$ -rectifiable

▶ $\Sigma(u) = \bigcup_{k=1}^N \Sigma^k(u)$ countably $(N - 1)$ -rectifiable

▶ references

- ▶ Zajíček (1978), Veselý (1979)
linearly semiconcave functions
- ▶ Alberti, Ambrosio & C— (1992)
general semiconcave functions



propagation of singularities

$u : \Omega \rightarrow \mathbb{R}$ semiconcave $x_0 \in \Sigma(u)$

Problem

$$??? \Rightarrow \Sigma(u) \neq \{x_0\}$$

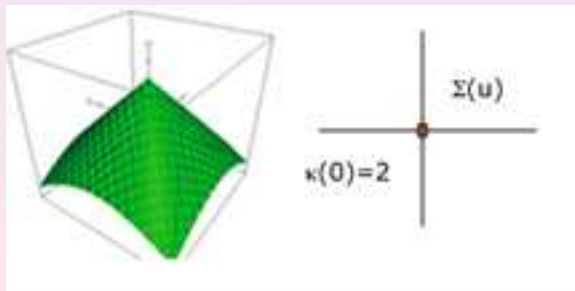

Figure: no propagation for $u(x, y) = 3 - \sqrt{x^2 + y^2}$



do lower magnitude singularities propagate?

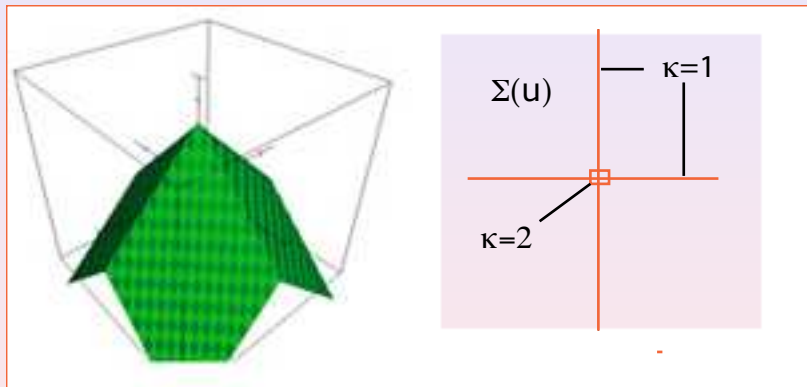

Figure: **magnitude 1** singularities of $u(x, y) = 3 - |x| - |y|$ do propagate along straight lines



semiconcavity results for optimal control

- └ semiconcave functions
- └ singularities

NO

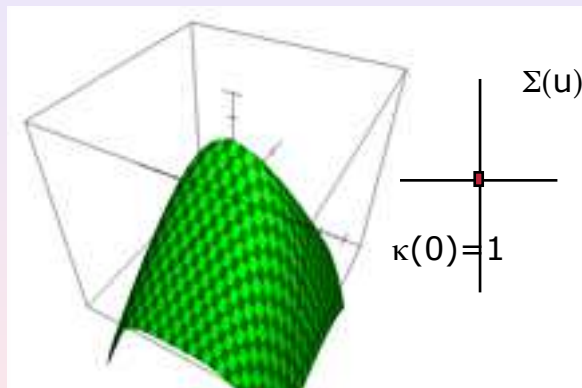

Figure: an **isolated** singularity of **magnitude 1** at the origin

$$u(x, y) = 3 - \sqrt{\left(\frac{3x}{2}\right)^2 + \left(\frac{2y}{3}\right)^4}$$



- └ semiconcave functions
- └ singularities

“pattern recognition”

a closer look at D^+u and D^*u

Example

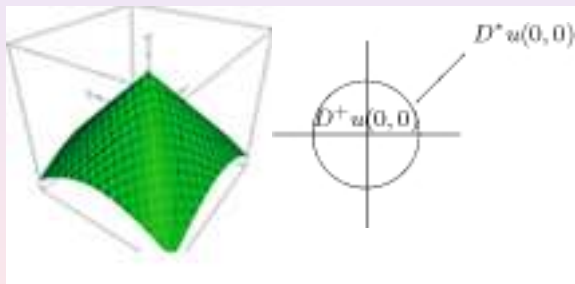

Figure: in example 1

$$D^*u(0,0) = \partial D^+u(0,0)$$



- └ semiconcave functions
- └ singularities

example 2

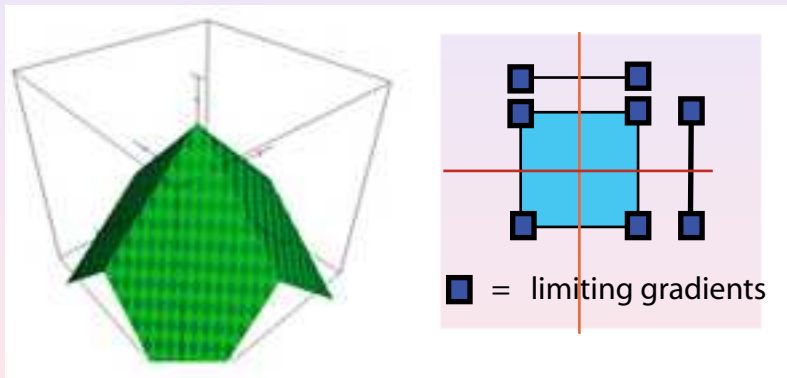

Figure: here

$$D^*u(0,0) \subsetneq \partial D^+u(0,0)$$



example 3

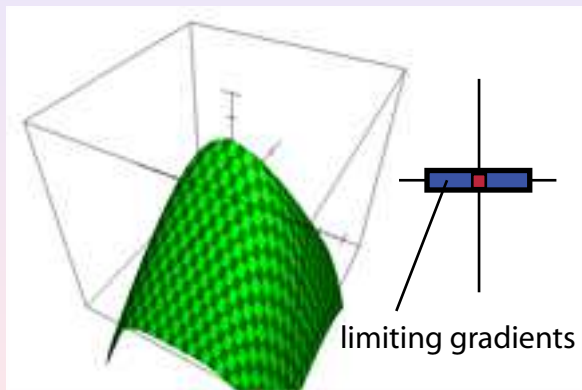

Figure: here

$$D^*u(0,0) = D^+u(0,0)$$



propagation principle

$u : \Omega \rightarrow \mathbb{R}$ semiconcave $x_0 \in \Sigma(u)$

Theorem (Albano – C 1999; C – Yu 2007)

Let

- ▶ $\emptyset \neq \partial D^+ u(x_0) \setminus D^* u(x_0) \ni p_0$
- ▶ $q \in \mathbb{R}^N \setminus \{0\}$ such that $q \cdot (p - p_0) \geq 0 \forall p \in D^+ u(x_0)$

Then $\exists \tau > 0$ and $x(\cdot) : [0, \tau] \rightarrow \Sigma(u)$ Lipschitz

1. $\dot{x}(s) \in q - p_0 + D^+ u(x(s))$ a.e. $s \in [0, \tau]$
2. $\dot{x}^+(0) = q$ & $\dot{x}^+(\cdot)$ continuous from the right
3. $\inf_{s \in [0, \tau]} \text{diam } D^+ u(x(s)) > 0$



propagation principle

$u : \Omega \rightarrow \mathbb{R}$ semiconcave $x_0 \in \Sigma(u)$

Theorem (Albano – C 1999; C – Yu 2007)

Let

- ▶ $\emptyset \neq \partial D^+ u(x_0) \setminus D^* u(x_0) \ni p_0$
- ▶ $q \in \mathbb{R}^N \setminus \{0\}$ such that $q \cdot (p - p_0) \geq 0 \forall p \in D^+ u(x_0)$

Then $\exists \tau > 0$ and $x(\cdot) : [0, \tau] \rightarrow \Sigma(u)$ Lipschitz

1. $\dot{x}(s) \in q - p_0 + D^+ u(x(s))$ a.e. $s \in [0, \tau]$
2. $\dot{x}^+(0) = q$ & $\dot{x}^+(\cdot)$ continuous from the right
3. $\inf_{s \in [0, \tau]} \text{diam } D^+ u(x(s)) > 0$



propagation principle

$u : \Omega \rightarrow \mathbb{R}$ semiconcave $x_0 \in \Sigma(u)$

Theorem (Albano – C 1999; C – Yu 2007)

Let

- ▶ $\emptyset \neq \partial D^+ u(x_0) \setminus D^* u(x_0) \ni p_0$
- ▶ $q \in \mathbb{R}^N \setminus \{0\}$ such that $q \cdot (p - p_0) \geq 0 \forall p \in D^+ u(x_0)$

Then $\exists \tau > 0$ and $x(\cdot) : [0, \tau] \rightarrow \Sigma(u)$ Lipschitz

1. $\dot{x}(s) \in q - p_0 + D^+ u(x(s))$ a.e. $s \in [0, \tau]$
2. $\dot{x}^+(0) = q$ & $\dot{x}^+(\cdot)$ continuous from the right
3. $\inf_{s \in [0, \tau]} \text{diam } D^+ u(x(s)) > 0$



propagation principle

$u : \Omega \rightarrow \mathbb{R}$ semiconcave $x_0 \in \Sigma(u)$

Theorem (Albano – C 1999; C – Yu 2007)

Let

- ▶ $\emptyset \neq \partial D^+ u(x_0) \setminus D^* u(x_0) \ni p_0$
- ▶ $q \in \mathbb{R}^N \setminus \{0\}$ such that $q \cdot (p - p_0) \geq 0 \forall p \in D^+ u(x_0)$

Then $\exists \tau > 0$ and $x(\cdot) : [0, \tau] \rightarrow \Sigma(u)$ Lipschitz

1. $\dot{x}(s) \in q - p_0 + D^+ u(x(s))$ a.e. $s \in [0, \tau]$
2. $\dot{x}^+(0) = q$ & $\dot{x}^+(\cdot)$ continuous from the right
3. $\inf_{s \in [0, \tau]} \text{diam } D^+ u(x(s)) > 0$



propagation principle

$u : \Omega \rightarrow \mathbb{R}$ semiconcave $x_0 \in \Sigma(u)$

Theorem (Albano – C 1999; C – Yu 2007)

Let

- ▶ $\emptyset \neq \partial D^+ u(x_0) \setminus D^* u(x_0) \ni p_0$
- ▶ $q \in \mathbb{R}^N \setminus \{0\}$ such that $q \cdot (p - p_0) \geq 0 \forall p \in D^+ u(x_0)$

Then $\exists \tau > 0$ and $x(\cdot) : [0, \tau] \rightarrow \Sigma(u)$ Lipschitz

1. $\dot{x}(s) \in q - p_0 + D^+ u(x(s))$ a.e. $s \in [0, \tau]$
2. $\dot{x}^+(0) = q$ & $\dot{x}^+(\cdot)$ continuous from the right
3. $\inf_{s \in [0, \tau]} \text{diam } D^+ u(x(s)) > 0$



propagation principle

$u : \Omega \rightarrow \mathbb{R}$ semiconcave $x_0 \in \Sigma(u)$

Theorem (Albano – C 1999; C – Yu 2007)

Let

- ▶ $\emptyset \neq \partial D^+ u(x_0) \setminus D^* u(x_0) \ni p_0$
- ▶ $q \in \mathbb{R}^N \setminus \{0\}$ such that $q \cdot (p - p_0) \geq 0 \forall p \in D^+ u(x_0)$

Then $\exists \tau > 0$ and $x(\cdot) : [0, \tau] \rightarrow \Sigma(u)$ Lipschitz

1. $\dot{x}(s) \in q - p_0 + D^+ u(x(s))$ a.e. $s \in [0, \tau]$
2. $\dot{x}^+(0) = q$ & $\dot{x}^+(\cdot)$ continuous from the right
3. $\inf_{s \in [0, \tau]} \text{diam } D^+ u(x(s)) > 0$



semiconcavity results for optimal control

- └ semiconcave functions
- └ singularities

back to example 2

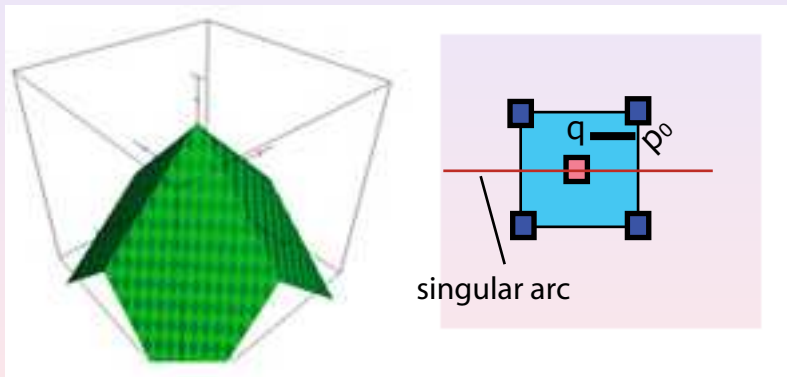

Figure: the propagation principle at work



Outline

Semiconcave functions

Definitions and general properties

Generalized gradients

Singularities of semiconcave functions

Semiconcave functions and optimal control

Mayer problem

Differential inclusions

Semiconcave functions and Hamilton-Jacobi equations

Smoothness of extremal trajectories

Semiconcavity of solutions

Conclusions



value function of a Mayer problem

$t \leq T$ $x \in \mathbb{R}^N$ $y_{t,x,\alpha}(\cdot)$ solution

$$\begin{cases} \dot{y}(s) = f(y(s), \alpha(s)) & s \in (t, T) \\ y(t) = x \end{cases}$$

where

- A compact
- $\alpha : [t, T] \rightarrow A$ measurable
- $f \in C(\mathbb{R}^N \times A; \mathbb{R}^N)$ continuous
 - ▶ $|f(x, a)| \leq C_0(1 + |x|)$
 - ▶ $|f(x, a) - f(y, a)| \leq C_1|x - y|$

given $\phi \in C(\mathbb{R}^N)$ define value function

$$V(t, x) = \inf_{\alpha} \phi(y_{t,x,\alpha}(T))$$



value function of a Mayer problem

$t \leq T$ $x \in \mathbb{R}^N$ $y_{t,x,\alpha}(\cdot)$ solution

$$\begin{cases} \dot{y}(s) = f(y(s), \alpha(s)) & s \in (t, T) \\ y(t) = x \end{cases}$$

where

- A compact
- $\alpha : [t, T] \rightarrow A$ measurable
- $f \in C(\mathbb{R}^N \times A; \mathbb{R}^N)$ continuous
 - ▶ $|f(x, a)| \leq C_0(1 + |x|)$
 - ▶ $|f(x, a) - f(y, a)| \leq C_1|x - y|$

given $\phi \in C(\mathbb{R}^N)$ define value function

$$V(t, x) = \inf_{\alpha} \phi(y_{t,x,\alpha}(T))$$



an 'old' semiconcavity result

Theorem

Assume

- ϕ *semiconcave*
- $\|f_x(x, a) - f_x(y, a)\| \leq C_2|x - y|$

Then V **(linearly) semiconcave** $(-\infty, T] \times \mathbb{R}^N$

references

- ▶ C – Frankowska (1991)
- ▶ C – Sinestrari (2004)



an 'old' semiconcavity result

Theorem

Assume

- ϕ *semiconcave*
- $\|f_x(x, a) - f_x(y, a)\| \leq C_2|x - y|$

Then V **(linearly) semiconcave** $(-\infty, T] \times \mathbb{R}^N$

references

- ▶ C – Frankowska (1991)
- ▶ C – Sinestrari (2004)



proof of semiconcavity of $V(t, \cdot)$

$$x, z \in \mathbb{R}^N$$

- ▶ α optimal at x
- ▶ $y(\cdot) = y_{t,x,\alpha}(\cdot)$, $y_{\pm}(\cdot) = y_{t,x \pm z, \alpha}(\cdot)$

by semiconcavity of ϕ and smoothness of flow

$$\begin{aligned} & V(t, x+z) + V(t, x-z) - 2V(t, x) \\ & \leq \phi(y_+(T)) + \phi(y_-(T)) - 2\phi(y(T)) \\ & = \underbrace{\phi(y_+(T)) + \phi(y_-(T)) - 2\phi\left(\frac{y_+(T) + y_-(T)}{2}\right)}_{\leq c|y_+(T) - y_-(T)|^2 \leq c|z|^2} \\ & \quad + 2 \left[\underbrace{\phi\left(\frac{y_+(T) + y_-(T)}{2}\right) - \phi(y(T))}_{\leq c|y_+(T) + y_-(T) - 2y(T)| \leq c|z|^2} \right] \end{aligned}$$



Outline

Semiconcave functions

Definitions and general properties

Generalized gradients

Singularities of semiconcave functions

Semiconcave functions and optimal control

Mayer problem

Differential inclusions

Semiconcave functions and Hamilton-Jacobi equations

Smoothness of extremal trajectories

Semiconcavity of solutions

Conclusions



parameterizations

- ▶ control system

$$\begin{cases} \dot{y}(s) = f(y(s), \alpha(s)) & s \in (t, T) \\ y(t) = x \end{cases}$$

can be recast as differential inclusion

$$\begin{cases} \dot{y}(s) \in F(y(s)) & \text{a.e in } (t, T) \\ y(t) = x \end{cases}$$

defining

$$F(x) = \{f(x, a) : a \in A\} \quad (*)$$



- ▶ F can be parametrized as in $(*)$



parameterizations

► control system

$$\begin{cases} \dot{y}(s) = f(y(s), \alpha(s)) & s \in (t, T) \\ y(t) = x \end{cases}$$

can be recast as differential inclusion

$$\begin{cases} \dot{y}(s) \in F(y(s)) & \text{a.e in } (t, T) \\ y(t) = x \end{cases}$$

defining

$$F(x) = \{f(x, a) : a \in A\} \quad (*)$$



► F can be parametrized as in (*)



parameterizations

- ▶ control system

$$\begin{cases} \dot{y}(s) = f(y(s), \alpha(s)) & s \in (t, T) \\ y(t) = x \end{cases}$$

can be recast as differential inclusion

$$\begin{cases} \dot{y}(s) \in F(y(s)) & \text{a.e in } (t, T) \\ y(t) = x \end{cases}$$

defining

$$F(x) = \{f(x, a) : a \in A\} \quad (*)$$

- ▶ F can be parametrized as in $(*)$



difficulty: smoothness of $f(\cdot, a)$

Example

$$F(x) = [-|x|, |x|] \quad (N = 1)$$

has the C^{1+} parametrization

$$F(x) = \{xu : |u| \leq 1\}$$

as well as the nonsmooth parametrization

$$F(x) = \{|x|u : |u| \leq 1\}$$

trajectories of the two systems coincide but known theorems asserting semiconcavity only apply to former parametrization



difficulty: smoothness of $f(\cdot, a)$

Example

$$F(x) = [-|x|, |x|] \quad (N = 1)$$

has the C^{1+} parametrization

$$F(x) = \{xu : |u| \leq 1\}$$

as well as the nonsmooth parametrization

$$F(x) = \{|x|u : |u| \leq 1\}$$

trajectories of the two systems coincide but known theorems asserting semiconcavity only apply to former parametrization



difficulty: smoothness of $f(\cdot, a)$

Example

$$F(x) = [-|x|, |x|] \quad (N = 1)$$

has the C^{1+} parametrization

$$F(x) = \{xu : |u| \leq 1\}$$

as well as the nonsmooth parametrization

$$F(x) = \{|x|u : |u| \leq 1\}$$

trajectories of the two systems coincide but known theorems asserting semiconcavity only apply to former parametrization



difficulty: smoothness of $f(\cdot, a)$

Example

$$F(x) = [-|x|, |x|] \quad (N = 1)$$

has the C^{1+} parametrization

$$F(x) = \{xu : |u| \leq 1\}$$

as well as the nonsmooth parametrization

$$F(x) = \{|x|u : |u| \leq 1\}$$

trajectories of the two systems coincide but known theorems asserting semiconcavity only apply to former parametrization



difficulty: smoothness of $f(\cdot, a)$

Example

$$F(x) = [-|x|, |x|] \quad (N = 1)$$

has the C^{1+} parametrization

$$F(x) = \{xu : |u| \leq 1\}$$

as well as the nonsmooth parametrization

$$F(x) = \{|x|u : |u| \leq 1\}$$

trajectories of the two systems coincide but known theorems asserting semiconcavity only apply to former parametrization



Hamiltonian

$H : \mathbb{R}^N \times \mathbb{R}^N \rightarrow \mathbb{R}$ associated to F is defined by

$$H(x, p) = \sup_{v \in F(x)} v \cdot p$$

one-to-one correspondence between H and F

$$v \in F(x) \iff v \cdot p \leq H(x, p) \quad \forall p \in \mathbb{R}^N$$

Assumptions

- (H1) for all compact convex $K \subseteq \mathbb{R}^N$ there is a constant $c_K \geq 0$ so that $x \mapsto H(x, p)$ semiconvex on K with constant $c_K |p|$
- (H2) $\nabla_p H(x, p)$ locally Lipschitz in x uniformly for $|p| \neq 0$



Hamiltonian

$H : \mathbb{R}^N \times \mathbb{R}^N \rightarrow \mathbb{R}$ associated to F is defined by

$$H(x, p) = \sup_{v \in F(x)} v \cdot p$$

one-to-one correspondence between H and F

$$v \in F(x) \iff v \cdot p \leq H(x, p) \quad \forall p \in \mathbb{R}^N$$

Assumptions

(H1) for all compact convex $K \subseteq \mathbb{R}^N$ there is a constant $c_K \geq 0$ so that $x \mapsto H(x, p)$ semiconvex on K with constant $c_K |p|$

(H2) $\nabla_p H(x, p)$ locally Lipschitz in x uniformly for $|p| \neq 0$



Hamiltonian

$H : \mathbb{R}^N \times \mathbb{R}^N \rightarrow \mathbb{R}$ associated to F is defined by

$$H(x, p) = \sup_{v \in F(x)} v \cdot p$$

one-to-one correspondence between H and F

$$v \in F(x) \iff v \cdot p \leq H(x, p) \quad \forall p \in \mathbb{R}^N$$

Assumptions

(H1) for all compact convex $K \subseteq \mathbb{R}^N$ there is a constant $c_K \geq 0$ so that $x \mapsto H(x, p)$ semiconvex on K with constant $c_K |p|$

(H2) $\nabla_p H(x, p)$ locally Lipschitz in x uniformly for $|p| \neq 0$



Hamiltonian

$H : \mathbb{R}^N \times \mathbb{R}^N \rightarrow \mathbb{R}$ associated to F is defined by

$$H(x, p) = \sup_{v \in F(x)} v \cdot p$$

one-to-one correspondence between H and F

$$v \in F(x) \iff v \cdot p \leq H(x, p) \quad \forall p \in \mathbb{R}^N$$

Assumptions

- (H1) for all compact convex $K \subseteq \mathbb{R}^N$ there is a constant $c_K \geq 0$ so that $x \mapsto H(x, p)$ **semiconvex** on K with constant $c_K|p|$
- (H2) $\nabla_p H(x, p)$ **locally Lipschitz** in x uniformly for $|p| \neq 0$



a 'new' semiconcavity result

given terminal cost $\varphi \in C(\mathbb{R}^N)$

define value function

$$V(t, x) = \inf \{ \varphi(y(T)) : y \in Y_T(t, x) \}$$

Theorem (C – Wolenski, 2011)

Assume

- ▶ F and H as above
- ▶ φ locally semiconcave

Then V locally semiconcave on $(-\infty, T] \times \mathbb{R}^N$

time optimal control

- ▶ C—, Marino and Wolenski
- ▶ C— and Nguyen



a 'new' semiconcavity result

given terminal cost $\varphi \in C(\mathbb{R}^N)$

define value function

$$V(t, x) = \inf \{ \varphi(y(T)) : y \in Y_T(t, x) \}$$

Theorem (C – Wolenski, 2011)

Assume

- ▶ F and H as above
- ▶ φ locally semiconcave

Then V locally semiconcave on $(-\infty, T] \times \mathbb{R}^N$

time optimal control

- ▶ C—, Marino and Wolenski
- ▶ C— and Nguyen



a 'new' semiconcavity result

given terminal cost $\varphi \in C(\mathbb{R}^N)$

define value function

$$V(t, x) = \inf \{ \varphi(y(T)) : y \in Y_T(t, x) \}$$

Theorem (C – Wolenski, 2011)

Assume

- ▶ F and H as above
- ▶ φ locally semiconcave

Then V locally semiconcave on $(-\infty, T] \times \mathbb{R}^N$

time optimal control

- ▶ C—, Marino and Wolenski
- ▶ C— and Nguyen



a 'new' semiconcavity result

given terminal cost $\varphi \in C(\mathbb{R}^N)$

define value function

$$V(t, x) = \inf \{ \varphi(y(T)) : y \in Y_T(t, x) \}$$

Theorem (C – Wolenski, 2011)

Assume

- ▶ F and H as above
- ▶ φ locally semiconcave

Then V locally semiconcave on $(-\infty, T] \times \mathbb{R}^N$

time optimal control

- ▶ C—, Marino and Wolenski
- ▶ C— and Nguyen



proof of semiconcavity of $V(t, \cdot)$

- ▶ fix $x, z \in \mathbb{R}^N$ and let $y(\cdot)$ be **optimal** at x : want to show $V(t, x+z) + V(t, x-z) - 2V(t, x) \leq c|z|^2$
- ▶ invoke **maximum principle** to obtain adjoint arc

$$\begin{cases} -\dot{p}(s) \in \partial_x H(y(s), p(s)), & \dot{y}(s) \in \partial_p H(y(s), p(s)) \\ -p(T) \in \partial^P \varphi(y(T)) \end{cases}$$

- ▶ supposing $p(s) \neq 0$ define $y_{\pm}(\cdot)$ by

$$\begin{cases} \dot{y}_{\pm}(s) = \nabla_p H(y_{\pm}(s), p(s)) \\ y_{\pm}(t) = x \pm z \end{cases}$$

observe

- ▶ $|y_+(s) - y_-(s)| \leq c|z|$ and $|y_{\pm}(s) - y(s)| \leq c|z|$
- ▶ $p \cdot \dot{y} = H(y, p)$ and $p \cdot \dot{y}_{\pm} = H(y_{\pm}, p)$



► $V(t, x + z) + V(t, x - z) - 2V(t, x)$

$$\begin{aligned} &\leq \varphi(y_+(T)) + \varphi(y_-(T)) - 2\varphi(y(T)) \\ &= \underbrace{\varphi(y_+(T)) + \varphi(y_-(T)) - 2\varphi\left(\frac{y_+(T) + y_-(T)}{2}\right)}_{\leq c|y_+(T) - y_-(T)|^2 \leq c|z|^2} \\ &\quad + 2\left[\varphi\left(\frac{y_+(T) + y_-(T)}{2}\right) - \varphi(y(T))\right] \end{aligned}$$

► since $-p(T) \in \partial^P \varphi(y(T))$

$$\begin{aligned} &\varphi\left(\frac{y_+(T) + y_-(T)}{2}\right) - \varphi(y(T)) \\ &\leq -p(T) \cdot \left[\frac{y_+(T) + y_-(T)}{2} - y(T)\right] + c \underbrace{\left|\frac{y_+(T) + y_-(T)}{2} - y(T)\right|^2}_{\leq c|z|^2} \end{aligned}$$



- ▶ $-p(T) \cdot \left[\frac{y_+(T)+y_-(T)}{2} - y(T) \right]$
 $= \frac{1}{2} \int_t^T \left[-\dot{p} \cdot (y_+ + y_- - 2y) + p \cdot (2\dot{y} - \dot{y}_+ - \dot{y}_-) \right] ds$
- ▶ $\frac{1}{2} \int_t^T p \cdot (2\dot{y} - \dot{y}_+ - \dot{y}_-) ds$
 $= \int_t^T \left[H(y, p) - \frac{H(y_+, p) + H(y_-, p)}{2} \right] ds$
 $= \int_t^T \left[H(y, p) - H\left(\frac{y_+ + y_-}{2}, p\right) \right] ds$
 $+ \int_t^T \underbrace{\left[H\left(\frac{y_+ + y_-}{2}, p\right) - \frac{H(y_+, p) + H(y_-, p)}{2} \right]}_{\leq c|p||y_+ - y_-|^2 \leq c|z|^2} ds$
- ▶ $\int_t^T \left[H(y, p) - H\left(\frac{y_+ + y_-}{2}, p\right) \right] ds \quad (-\dot{p} \in \partial_x H(y, p)!)$
 $\leq \int_t^T \left[\dot{p} \cdot \left(\frac{y_+ + y_-}{2} - y \right) + \underbrace{c|p| \left| \frac{y_+ + y_-}{2} - y \right|^2}_{\leq c|z|^2} \right] ds$



nonsmooth HJ equations

$$\begin{cases} H(x, -Du(x)) = 1 & \text{in } \Omega \\ u(x) = 0 & \text{on } \partial\Omega \end{cases}$$

Example

$$|A(x)Du(x)| = 1 \quad \text{in } \Omega$$

where

- ▶ $A : \mathbb{R}^N \rightarrow \mathbb{R}^{N \times N}$ is α -Hölder continuous on \mathbb{R}^N
- ▶ $A(x)$ is invertible for all $x \in \mathbb{R}^N$, and

$$|A(x)| \leq C \quad \text{and} \quad |A(x)^{-1}| \leq C \quad \forall x \in \mathbb{R}^N$$



nonsmooth HJ equations

$$\begin{cases} H(x, -Du(x)) = 1 & \text{in } \Omega \\ u(x) = 0 & \text{on } \partial\Omega \end{cases}$$

Example

$$|A(x)Du(x)| = 1 \quad \text{in } \Omega$$

where

- ▶ $A : \mathbb{R}^N \rightarrow \mathbb{R}^{N \times N}$ is α -Hölder continuous on \mathbb{R}^N
- ▶ $A(x)$ is invertible for all $x \in \mathbb{R}^N$, and

$$|A(x)| \leq C \quad \text{and} \quad |A(x)^{-1}| \leq C \quad \forall x \in \mathbb{R}^N$$



nonsmooth HJ equations

$$\begin{cases} H(x, -Du(x)) = 1 & \text{in } \Omega \\ u(x) = 0 & \text{on } \partial\Omega \end{cases}$$

Example

$$|A(x)Du(x)| = 1 \quad \text{in } \Omega$$

where

- ▶ $A : \mathbb{R}^N \rightarrow \mathbb{R}^{N \times N}$ is α -Hölder continuous on \mathbb{R}^N
- ▶ $A(x)$ is invertible for all $x \in \mathbb{R}^N$, and

$$|A(x)| \leq C \quad \text{and} \quad |A(x)^{-1}| \leq C \quad \forall x \in \mathbb{R}^N$$



assumptions on H

$\exists C_0, r, R$, and $\alpha \in (0, 1/2)$ such that

- ▶ $|H(x, p) - H(y, p)| \leq C_0 |x - y|^{2\alpha} |p| \quad \forall x, y, p \in \mathbb{R}^N$
- ▶ $H(x, \cdot)$ is convex, 1-homogeneous, and

$$r|p| \leq H(x, p) \leq R|p| \quad \forall x, p \in \mathbb{R}^N$$

- ▶ $H(x, \cdot)$ is continuously differentiable on $\mathbb{R}^N \setminus \{0\}$, and

$$\begin{aligned} & -\frac{1}{2r} |D_p H(x, q) - D_p H(x, p)|^2 \\ & \leq \langle D_p H(x, q) - D_p H(x, p), \frac{p}{|p|} \rangle \\ & \leq -\frac{1}{2R} |D_p H(x, q) - D_p H(x, p)|^2 \end{aligned}$$



assumptions on H

$\exists C_0, r, R$, and $\alpha \in (0, 1/2)$ such that

- ▶ $|H(x, p) - H(y, p)| \leq C_0 |x - y|^{2\alpha} |p| \quad \forall x, y, p \in \mathbb{R}^N$
- ▶ $H(x, \cdot)$ is convex, 1-homogeneous, and

$$r|p| \leq H(x, p) \leq R|p| \quad \forall x, p \in \mathbb{R}^N$$

- ▶ $H(x, \cdot)$ is continuously differentiable on $\mathbb{R}^N \setminus \{0\}$, and

$$\begin{aligned} & -\frac{1}{2r} |D_p H(x, q) - D_p H(x, p)|^2 \\ & \leq \langle D_p H(x, q) - D_p H(x, p), \frac{p}{|p|} \rangle \\ & \leq -\frac{1}{2R} |D_p H(x, q) - D_p H(x, p)|^2 \end{aligned}$$



associated control problem

define

$$F(x) = \text{co} \{ D_p H(x, p) : p \in \mathbb{R}^N \setminus \{0\} \} \quad \forall x \in \mathbb{R}^N$$

then

$$\begin{cases} H(x, -Du(x)) = 1 & \text{in } \Omega \\ u(x) = 0 & \text{on } \partial\Omega \end{cases}$$

if and only if

$$u(x) = \inf \left\{ t \geq 0 : \exists \begin{cases} y'(s) \in F(y(s)) & s \geq 0 \text{ a.e.} \\ y(0) = x, & y(t) \in \partial\Omega \end{cases} \right\}$$



associated control problem

define

$$F(x) = \text{co} \{ D_p H(x, p) : p \in \mathbb{R}^N \setminus \{0\} \} \quad \forall x \in \mathbb{R}^N$$

then

$$\begin{cases} H(x, -Du(x)) = 1 & \text{in } \Omega \\ u(x) = 0 & \text{on } \partial\Omega \end{cases}$$

if and only if

$$u(x) = \inf \left\{ t \geq 0 : \exists \begin{cases} y'(s) \in F(y(s)) & s \geq 0 \text{ a.e.} \\ y(0) = x, & y(t) \in \partial\Omega \end{cases} \right\}$$



associated control problem

define

$$F(x) = \text{co} \{ D_p H(x, p) : p \in \mathbb{R}^N \setminus \{0\} \} \quad \forall x \in \mathbb{R}^N$$

then

$$\begin{cases} H(x, -Du(x)) = 1 & \text{in } \Omega \\ u(x) = 0 & \text{on } \partial\Omega \end{cases}$$

if and only if

$$u(x) = \inf \left\{ t \geq 0 : \exists \begin{cases} y'(s) \in F(y(s)) & s \geq 0 \text{ a.e.} \\ y(0) = x, & y(t) \in \partial\Omega \end{cases} \right\}$$



properties of $F(\cdot)$

- ▶ $F(x) \subset F(y) + C_0|x - y|^{2\alpha}B \quad \forall x, y \in \mathbb{R}^N$
- ▶ *curvature* estimates

$$B\left(f_p(x) - r \frac{p}{|p|}, r\right) \subset F(x) \quad \text{and} \quad F(x) \subset B\left(f_p(x) - R \frac{p}{|p|}, R\right)$$

- ▶ *controllability* condition

$$B(0, r) \subset F(x) \subset B(0, R)$$



properties of $F(\cdot)$

- ▶ $F(x) \subset F(y) + C_0|x - y|^{2\alpha}B \quad \forall x, y \in \mathbb{R}^N$
- ▶ *curvature* estimates

$$B\left(f_p(x) - r \frac{p}{|p|}, r\right) \subset F(x) \quad \text{and} \quad F(x) \subset B\left(f_p(x) - R \frac{p}{|p|}, R\right)$$

- ▶ *controllability* condition

$$B(0, r) \subset F(x) \subset B(0, R)$$



Outline

Semiconcave functions

Definitions and general properties

Generalized gradients

Singularities of semiconcave functions

Semiconcave functions and optimal control

Mayer problem

Differential inclusions

Semiconcave functions and Hamilton-Jacobi equations

Smoothness of extremal trajectories

Semiconcavity of solutions

Conclusions



$C^{1,\alpha/2}$ regularity of extremal trajectories

$K \subset \mathbb{R}^N$ closed

$$\begin{cases} x'(t) \in F(x(t)) & t \geq 0 \text{ a.e.} \\ x(0) \in K \end{cases} \quad (DI)$$

reachable set (from K) in time t

$$\mathcal{R}(t) = \{x(t) : x(\cdot) \text{ is a trajectory of } (DI)\}$$

$x(\cdot)$ **extremal trajectory** on $[0, t]$ if $x(t) \in \partial \mathcal{R}(t)$

Theorem (C–Cardaliaguet)

$x(\cdot)$ extremal on $[0, T] \Rightarrow |x'(t) - x'(s)| \leq C|t - s|^{\alpha/2} \forall t, s$

$F(x) = c(x)B$

- ▶ Su and Berger (2006, 2007) $N = 2$
- ▶ Cardaliaguet, Ley and Monteillet



$C^{1,\alpha/2}$ regularity of extremal trajectories

$K \subset \mathbb{R}^N$ closed

$$\begin{cases} x'(t) \in F(x(t)) & t \geq 0 \text{ a.e.} \\ x(0) \in K \end{cases} \quad (DI)$$

reachable set (from K) in time t

$$\mathcal{R}(t) = \{x(t) : x(\cdot) \text{ is a trajectory of } (DI)\}$$

$x(\cdot)$ **extremal trajectory** on $[0, t]$ if $x(t) \in \partial\mathcal{R}(t)$

Theorem (C–Cardaliaguet)

$x(\cdot)$ **extremal on $[0, T]$** $\Rightarrow |x'(t) - x'(s)| \leq C|t - s|^{\alpha/2} \forall t, s$

$F(x) = c(x)B$

- ▶ Su and Berger (2006, 2007) $N = 2$
- ▶ Cardaliaguet, Ley and Monteillet



$C^{1,\alpha/2}$ regularity of extremal trajectories $K \subset \mathbb{R}^N$ closed

$$\begin{cases} x'(t) \in F(x(t)) & t \geq 0 \text{ a.e.} \\ x(0) \in K \end{cases} \quad (DI)$$

reachable set (from K) in time t

$$\mathcal{R}(t) = \{x(t) : x(\cdot) \text{ is a trajectory of } (DI)\}$$

 $x(\cdot)$ extremal trajectory on $[0, t]$ if $x(t) \in \partial\mathcal{R}(t)$

Theorem (C–Cardaliaguet)

 $x(\cdot)$ extremal on $[0, T] \Rightarrow |x'(t) - x'(s)| \leq C|t - s|^{\alpha/2} \forall t, s$
 $F(x) = c(x)B$

- ▶ Su and Berger (2006, 2007) $N = 2$
- ▶ Cardaliaguet, Ley and Monteillet



Outline

Semiconcave functions

Definitions and general properties

Generalized gradients

Singularities of semiconcave functions

Semiconcave functions and optimal control

Mayer problem

Differential inclusions

Semiconcave functions and Hamilton-Jacobi equations

Smoothness of extremal trajectories

Semiconcavity of solutions

Conclusions



'new' semiconcavity for HJ

Theorem (C-Cardaliaguet)

▶ *u* solution

$$\begin{cases} H(x, -Du(x)) = 1 & \text{in } \Omega \\ u(x) = 0 & \text{on } \partial\Omega \end{cases}$$

▶ $\theta \in (0, \frac{\alpha}{4+\alpha})$

⇒ *u* locally semiconcave

$$u(x+h) + u(x-h) - 2u(x) \leq C|h|^{1+\theta}$$



'new' semiconcavity for HJ

Theorem (C-Cardaliaguet)

▶ *u* solution

$$\begin{cases} H(x, -Du(x)) = 1 & \text{in } \Omega \\ u(x) = 0 & \text{on } \partial\Omega \end{cases}$$

▶ $\theta \in (0, \frac{\alpha}{4+\alpha})$

⇒ *u* locally semiconcave

$$u(x+h) + u(x-h) - 2u(x) \leq C|h|^{1+\theta}$$



conclusions

- ▶ **semiconcavity** is a useful property to study **nonsmooth** solutions of
 - ▶ optimal control problems
 - ▶ partial differential equations

not only for smooth data
- ▶ **extensions** of such a property (**φ -concavity, exterior ball property of hypograph...**) have been developed
- ▶ modelling control systems by **differential inclusions** provides intrinsic description which is independent of smoothness of parameterization
- ▶ **maximum principle** and **geometric properties of dynamics** (rather than smoothness of flow) should play an essential role in such generalized contexts



Thank you for your attention

