



**HAL**  
open science

# Invariant Manifolds for the Station Keeping of Solar Sails

Àngel Jorba, Ariadna Farrés

► **To cite this version:**

Àngel Jorba, Ariadna Farrés. Invariant Manifolds for the Station Keeping of Solar Sails. SADCO A2CO - Aerospace applications of control and optimization, Mar 2011, Paris, France. inria-00585612

**HAL Id: inria-00585612**

**<https://inria.hal.science/inria-00585612v1>**

Submitted on 14 Apr 2011

**HAL** is a multi-disciplinary open access archive for the deposit and dissemination of scientific research documents, whether they are published or not. The documents may come from teaching and research institutions in France or abroad, or from public or private research centers.

L'archive ouverte pluridisciplinaire **HAL**, est destinée au dépôt et à la diffusion de documents scientifiques de niveau recherche, publiés ou non, émanant des établissements d'enseignement et de recherche français ou étrangers, des laboratoires publics ou privés.

# Invariant Manifolds for the Station Keeping of Solar Sails

Ariadna Farrés, AJ

Universitat de Barcelona

March 2nd, 2011

- 1 Background
- 2 Station Keeping around Equilibria
- 3 Nonlinear Dynamics around Equilibria
- 4 Station Keeping around Periodic Orbits

# What is a Solar Sail ?

- Solar Sails are a new concept of spacecraft propulsion that takes advantage of the Solar radiation pressure to propel a satellite.
- The impact of the photons emitted by the Sun on the surface of the sail and its further reflection produce momentum on it.
- Solar Sails open a wide new range of possible missions that are not accessible by a traditional spacecraft.

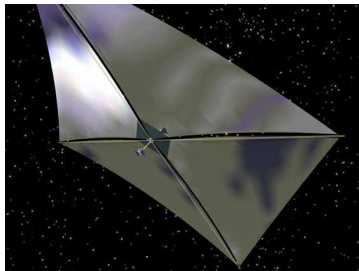



At this moment, there are two solar sails in space:

- **IKAROS**: (Interplanetary Kite-craft Accelerated by Radiation Of the Sun). It is a Japan Aerospace Exploration Agency experimental spacecraft. The spacecraft was launched on May 21st 2010, together with Akatsuki (Venus Climate Orbiter). On December 8th 2010, IKAROS passed by Venus at about 80,800 km distance.
- **NanoSail-D2**: On January 2011 NASA managed to deploy a solar sail in a low Earth orbit.

The Planetary Society is planning its own demo flight, **LightSail 1**, by the end of 2011.

# The Solar Sail

We have considered a flat and perfectly reflecting Solar Sail: the force due to the solar radiation pressure is normal to the surface of the sail ( $\vec{n}$ ), and it is defined by the *sail orientation* and the *sail lightness number*.

- The *sail orientation* is given by the normal vector to the surface of the sail,  $\vec{n}$ . It is parametrised by two angles,  $\alpha$  and  $\delta$ .
- The *sail lightness number* is given in terms of the dimensionless parameter  $\beta$ . It measures the effectiveness of the sail.

The acceleration of the sail due to the radiation pressure is given by:

$$\vec{a}_{sail} = \beta \frac{m_s}{r_{ps}^2} \langle \vec{r}_s, \vec{n} \rangle^2 \vec{n}.$$

# The Sail Effectiveness

The parameter  $\beta$  is defined as the ratio of the solar radiation pressure in terms of the solar gravitational attraction.

With nowadays technology, it is considered reasonable to take  $\beta \approx 0.05$ . This means that a spacecraft of 100 kg has a sail of  $58 \times 58 \text{ m}^2$ .

*Reference: C. McInnes, "Solar Sail: Technology, Dynamics and Mission Applications", Springer-Praxis, 1999.*

# The Dynamical Model

We use the Restricted Three Body Problem (RTBP) taking the Sun and Earth as primaries and including the solar radiation pressure.

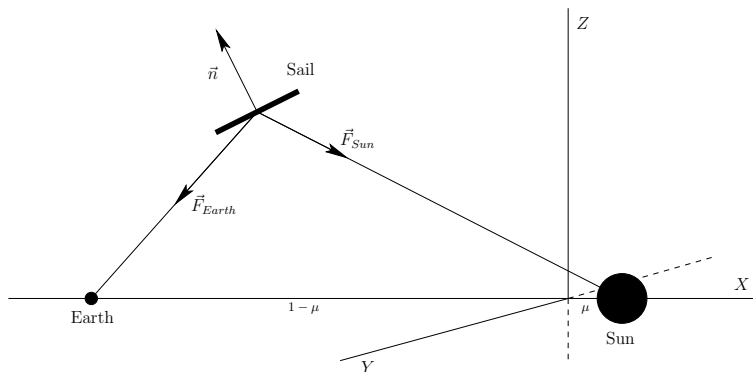

## Equations of Motion

The equations of motion are:

$$\ddot{x} = 2\dot{y} + x - (1 - \mu) \frac{x - \mu}{r_{ps}^3} - \mu \frac{x + 1 - \mu}{r_{pe}^3} + \beta \frac{1 - \mu}{r_{ps}^2} \langle \vec{r}_s, \vec{n} \rangle^2 n_x,$$

$$\ddot{y} = -2\dot{x} + y - \left( \frac{1 - \mu}{r_{ps}^3} + \frac{\mu}{r_{pe}^3} \right) y + \beta \frac{1 - \mu}{r_{ps}^2} \langle \vec{r}_s, \vec{n} \rangle^2 n_y,$$

$$\ddot{z} = - \left( \frac{1 - \mu}{r_{ps}^3} + \frac{\mu}{r_{pe}^3} \right) z + \beta \frac{1 - \mu}{r_{ps}^2} \langle \vec{r}_s, \vec{n} \rangle^2 n_z,$$

where  $\vec{n} = (n_x, n_y, n_z)$  is the normal to the surface of the sail with

$$\begin{aligned} n_x &= \cos(\phi(x, y) + \alpha) \cos(\psi(x, y, z) + \delta), \\ n_y &= \sin(\phi(x, y, z) + \alpha) \cos(\psi(x, y, z) + \delta), \\ n_z &= \sin(\psi(x, y, z) + \delta), \end{aligned}$$

and  $\vec{r}_s = (x - \mu, y, z)/r_{ps}$  is the Sun - sail direction.

# Equilibrium Points

- The RTBP has 5 equilibrium points ( $L_i$ ,  $i = 1, \dots, 5$ ). For small  $\beta$ , these 5 points are replaced by 5 continuous families of equilibria, parametrised by  $\alpha$  and  $\delta$ .
- For a fixed small value of  $\beta$ , we have 5 disconnected family of equilibria near the classical  $L_i$ .
- For a fixed and larger  $\beta$ , these families merge into each other. We end up having two disconnected surfaces,  $S_1$  and  $S_2$ , where  $S_1$  is like a sphere and  $S_2$  is like a torus around the Sun.
- All these families can be computed numerically by means of a continuation method.

## Interesting Missions Applications

Observations of the Sun provide information of the geomagnetic storms, as in the Geostorm Warning Mission.

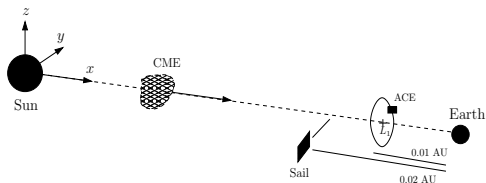

Observations of the Earth's poles, as in the Polar Observer.

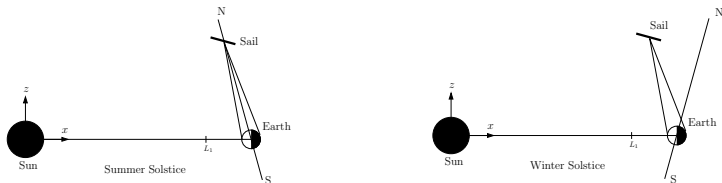

# Interesting Missions Applications

To ensure reliable radio communication between Mars and Earth even when the planets are lined up at opposite sides of the Sun.

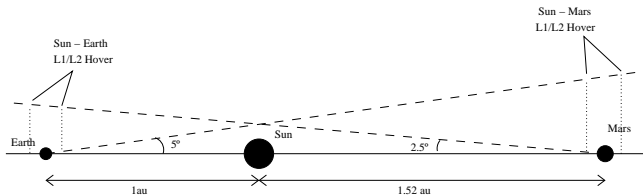



## Periodic Motion Around Equilibria

We must add a constrain on the sail orientation to find bounded motion. One can see that when  $\alpha = 0$  and  $\delta \in [-\pi/2, \pi/2]$  (i.e. only move the sail vertically w.r.t. the Sun - sail line):

- The system is time reversible  $\forall \delta$  by  $R : (x, y, z, \dot{x}, \dot{y}, \dot{z}, t) \rightarrow (x, -y, z, -\dot{x}, \dot{y}, -\dot{z}, -t)$  and Hamiltonian only for  $\delta = 0, \pm\pi/2$ .
- There are 5 disconnected families of equilibrium points parametrised by  $\delta$ , we call them  $FL_{1,\dots,5}$  (each one related to one of the Lagrangian points  $L_{1,\dots,5}$ ).
- Three of these families ( $FL_{1,2,3}$ ) lie on the  $Y = 0$  plane, and the linear behaviour around them is of the type saddle  $\times$  centre  $\times$  centre.
- The other two families ( $FL_{4,5}$ ) are close to  $L_{4,5}$ , and the linear behaviour around them is of the type sink  $\times$  sink  $\times$  source or sink  $\times$  source  $\times$  source.

## We focus on ...

- We focus on the motion around the equilibrium on the  $FL_1$  family close to  $SL_1$  (they correspond to  $\alpha = 0$  and  $\delta \approx 0$ ).
- We fix  $\beta = 0.051689$ .
- We consider the sail orientation to be fixed along time.

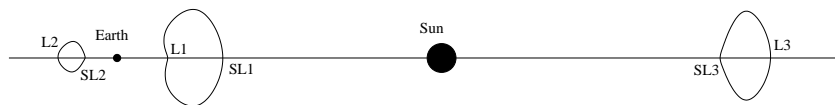

*(Schematic representation of the equilibrium points on  $Y = 0$ )*

Let us see the **periodic motion** around these points for a fixed sail orientation and show how it varies when we change, slightly, the sail orientation.

# $\mathcal{P}$ -Family of Periodic Orbits

Periodic Orbits for  $\delta = 0$ .

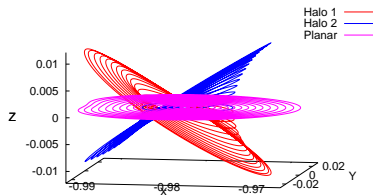
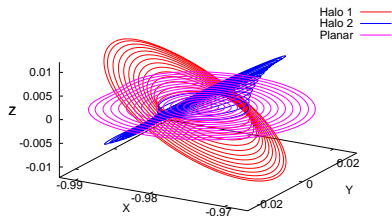
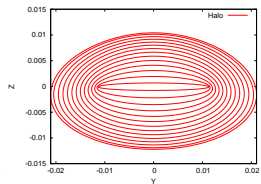
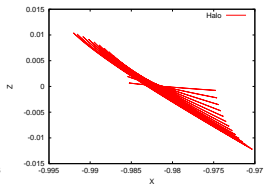
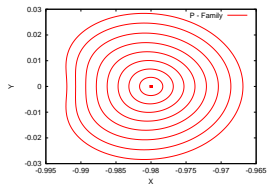

# $\mathcal{P}$ -Family of Periodic Orbits

Periodic Orbits for  $\delta = 0.01$ .

*Main family of periodic orbits for  $\delta = 0.01$*

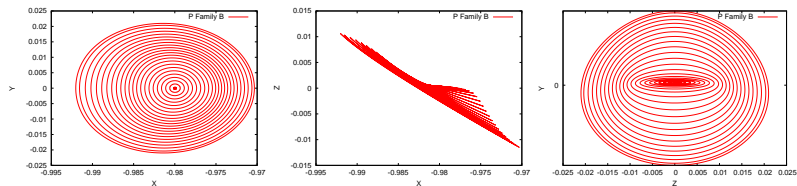

*Secondary family of periodic orbits for  $\delta = 0.01$*

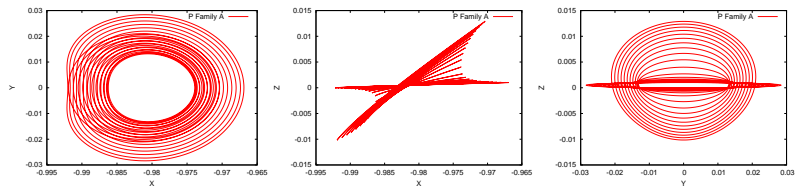

# $\mathcal{P}$ -Family of Periodic Orbits

Periodic Orbits for  $\delta = 0.01$ .

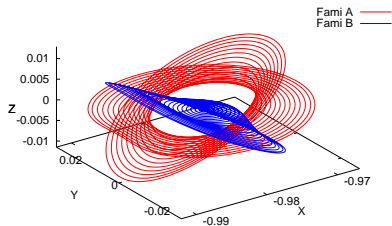
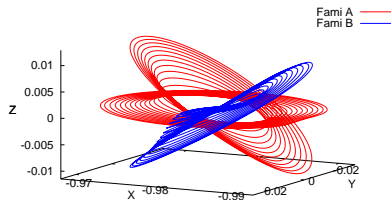
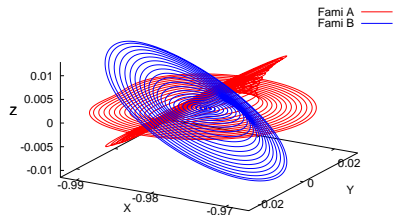

# $\mathcal{V}$ - Family of Periodic Orbits

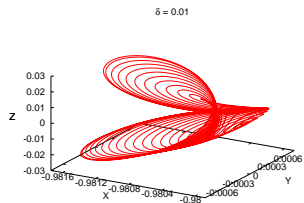
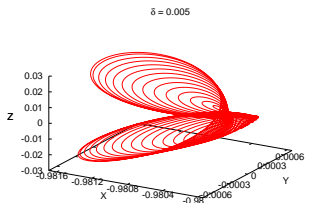
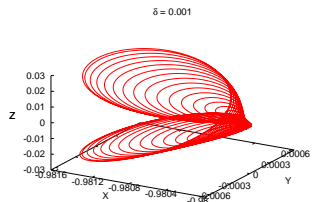
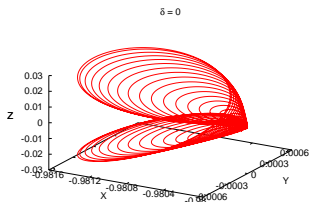

# Station Keeping around equilibria

Goal:

- Design station keeping strategy to maintain the trajectory of a solar sail close to an unstable equilibrium point.
- Instead of using *Control Theory Algorithms*, we want to use *Dynamical Systems Tools* to find a station keeping algorithm for a Solar Sail.

# Station Keeping around equilibria

Goal:

- Design station keeping strategy to maintain the trajectory of a solar sail close to an unstable equilibrium point.
- Instead of using *Control Theory Algorithms*, we want to use *Dynamical Systems Tools* to find a station keeping algorithm for a Solar Sail.

Idea:

- We focus on the linear dynamics around an equilibrium point and study how this one varies when the sail orientation changes.
- We want to change the sail orientation (i.e. the phase space) to make the system act in our favour: keep the trajectory close to a given equilibrium point.



We focus on the previous missions, where the equilibrium points are unstable with two real eigenvalues,  $\lambda_1 > 0, \lambda_2 < 0$ , and two pair of complex eigenvalues,  $\nu_{1,2} \pm i\omega_{1,2}$ , with  $|\nu_{1,2}| \ll |\lambda_{1,2}|$ .

- The linear dynamics at the equilibrium point is of the type saddle  $\times$  centre  $\times$  centre.
- We describe the trajectory of the sail in three reference planes defined by the eigendirections.

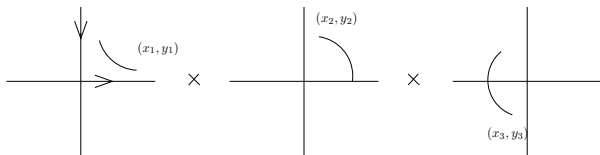

- For small variations of the sail orientation, the equilibrium point, eigenvalues and eigendirections have a small variation. We will describe the effects of the changes on the sail orientation on each of these three reference planes.

## Schematic Idea of the Station Keeping Strategy (I)

In the saddle projection of the trajectory:

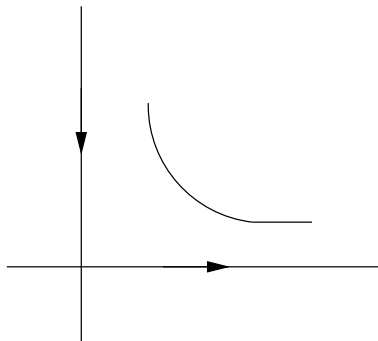

- When we are close to the equilibrium point,  $p_0$ , the trajectory escapes along the unstable direction.

# Schematic Idea of the Station Keeping Strategy (I)

In the saddle projection of the trajectory:

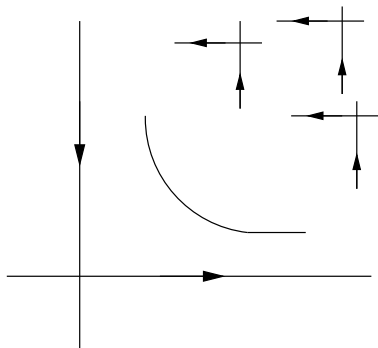

- When we are close to the equilibrium point,  $p_0$ , the trajectory escapes along the unstable direction.
- If we change the sail orientation the equilibrium point is shifted. Now the trajectory will escape along the new unstable direction.

# Schematic Idea of the Station Keeping Strategy (I)

In the saddle projection of the trajectory:

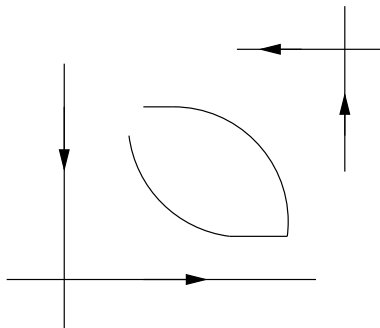

- When we are close to the equilibrium point,  $p_0$ , the trajectory escapes along the unstable direction.
- If we change the sail orientation the equilibrium point is shifted. Now the trajectory will escape along the new unstable direction.
- We want to find a new sail orientation  $(\alpha, \delta)$  so that the trajectory will come close to the stable direction of  $p_0$ .

# Schematic Idea of the Station Keeping Strategy (II)

In the saddle projection of the trajectory:

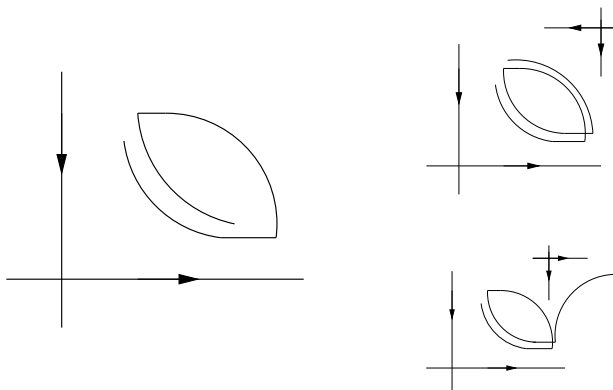

## Schematic Idea of the Station Keeping Strategy (II)

In the saddle projection of the trajectory:

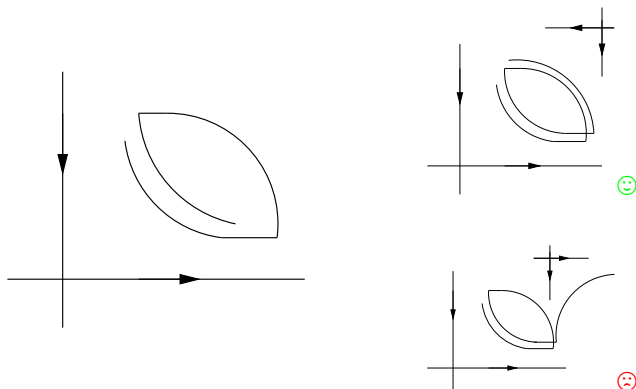

- With these ideas we can control the instability due to the saddle.
- We need to take into account the centre projection of the trajectory, as it might grow.

## Schematic Idea of the Station Keeping Strategy (III)

In the centre projection of the trajectory:

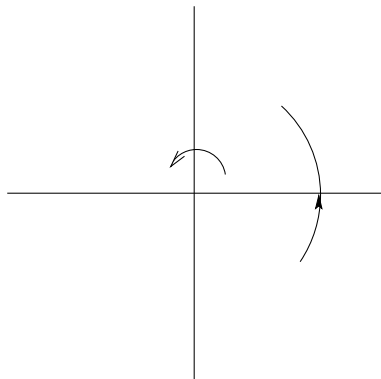

- When we are close to the equilibrium point the trajectory is a rotation.

## Schematic Idea of the Station Keeping Strategy (III)

In the centre projection of the trajectory:

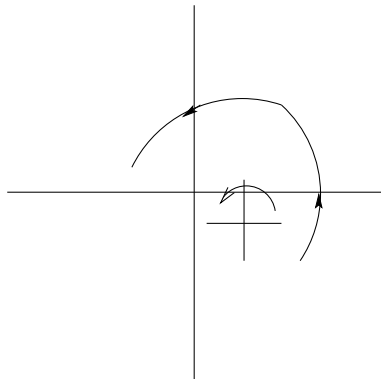

- When we are close to the equilibrium point the trajectory is a rotation.
- If we change the sail orientation the equilibrium point is shifted. Now the trajectory will rotate around the new equilibrium point.



## Schematic Idea of the Station Keeping Strategy (III)

In the centre projection of the trajectory:

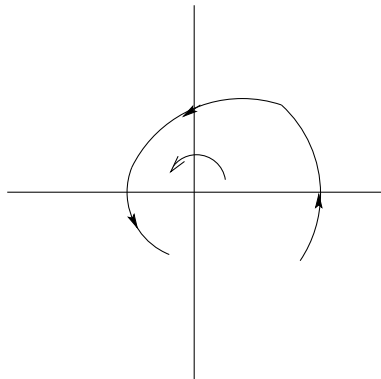

- When we are close to the equilibrium point the trajectory is a rotation.
- If we change the sail orientation the equilibrium point is shifted. Now the trajectory will rotate around the new equilibrium point.
- A sequence of changes on the sail orientation results in a sequence of rotations around the different equilibrium points.

# Schematic Idea of the Station Keeping Strategy (IV)

In the centre projection of the trajectory:

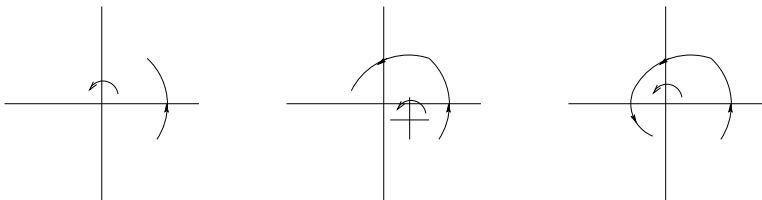

# Schematic Idea of the Station Keeping Strategy (IV)

In the centre projection of the trajectory:

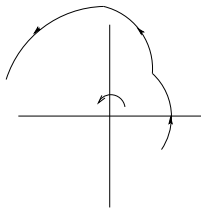
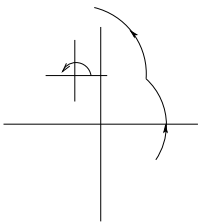
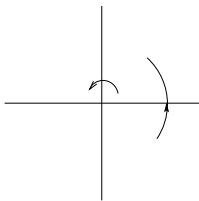
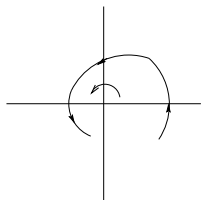
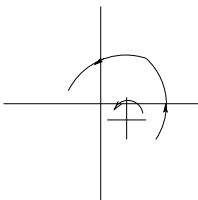
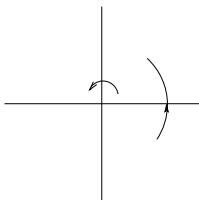

# Schematic Idea of the Station Keeping Strategy (IV)

In the centre projection of the trajectory:

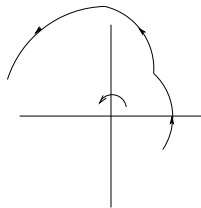
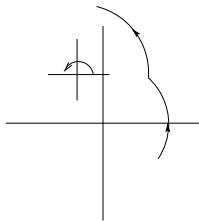
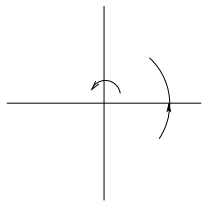
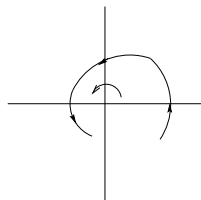
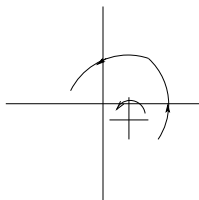
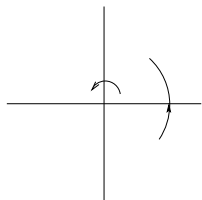

## Schematic Idea of the Station Keeping Strategy (V)

In the centre projection of the trajectory:

- A sequence of changes on the sail orientation implies a sequence of rotations around different equilibrium points on the centre projection.
- As we have seen a sequence of rotations around different equilibrium points can result unbounded.
- How can we choose the position of the new equilibrium point on the centre projection to keep this projection bounded ?

## Schematic Idea of the Station Keeping Strategy (V)

In the centre projection of the trajectory:

- A sequence of changes on the sail orientation implies a sequence of rotations around different equilibrium points on the centre projection.
- As we have seen a sequence of rotations around different equilibrium points can result unbounded.
- How can we choose the position of the new equilibrium point on the centre projection to keep this projection bounded ?

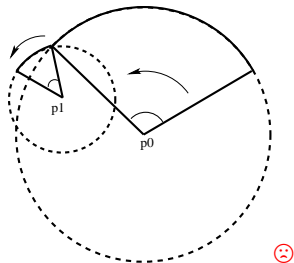
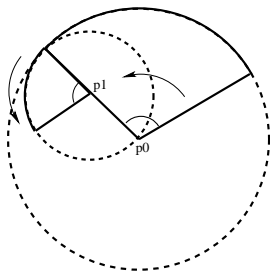

## Schematic Idea of the Station Keeping Strategy (VI)

To control the saddle and centre projection we want the new equilibrium point to satisfy:

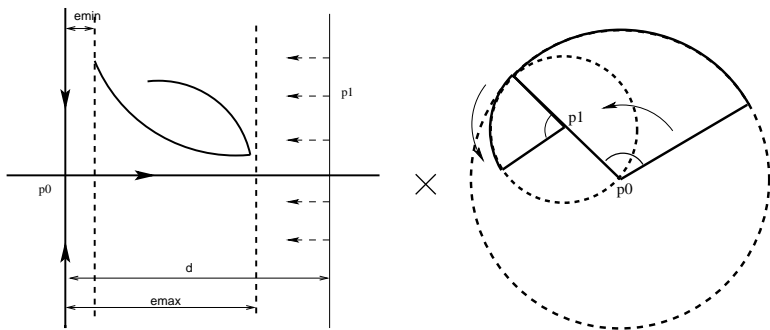

The constants  $\epsilon_{min}$ ,  $\epsilon_{max}$  and  $d$  will depend on the mission requirements and the dynamics around the equilibrium point.

# Results

We have applied this station keeping strategy to two different mission applications, the *Geostorm Warning Mission* and the *Polar Observer*.

For each mission:

- We have done a Monte Carlo simulation taking a 1000 random initial conditions.
- For each simulation we have applied the station keeping strategy for 30 years.
- We have tested the robustness of our strategy including random errors on the position and velocity determination, as well as on the orientation of the sail at each manoeuvre.



## Results for the Geostorm

We take  $\beta = 0.051689$  (i.e. a satellite of 130kg mass with a  $67m \times 67m$  square sail).

	Success	Max. Time	Min. Time	Ang. Vari.
No Error	100 %	45.87 days	24.13 days	1.43°
Error Pos.	100 %	45.85 days	24.13 days	1.43°
Error Pos. & Ori. <sup>*</sup>	100 %	53.90 days	21.59 days	1.42°
Error Pos. & Ori. <sup>†</sup>	97 %	216.47 days	15.54 days	1.67°

*Statistics for the Geostorm mission taking 1000 simulations. Considering errors on the sail orientation of order  $0.5^\circ$  (<sup>\*</sup>) and  $2.2^\circ$  (<sup>†</sup>).*

## Results for the Geostorm (No Errors in Manoeuvres)

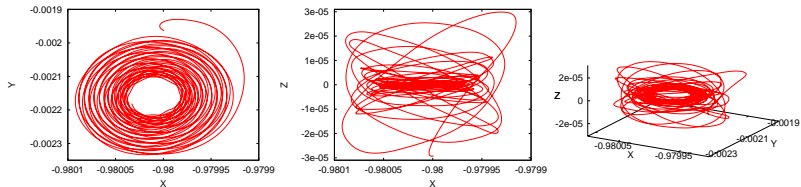
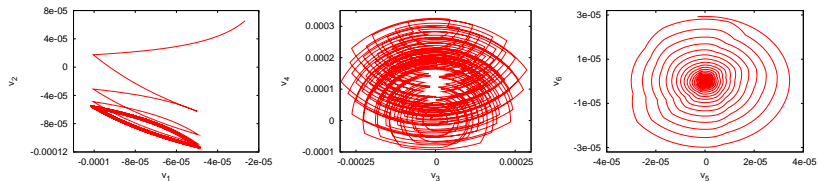
*XY and XZ and XYZ Projections**Saddle  $\times$  Centre  $\times$  Centre Projections*

# Results for the Geostorm (Errors in Manoeuvres)

## *XY and XZ and XYZ Projections*

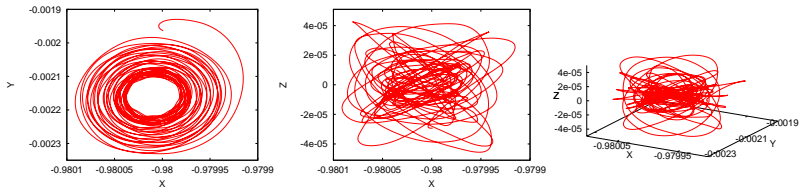

## *Saddle × Centre × Centre Projections*

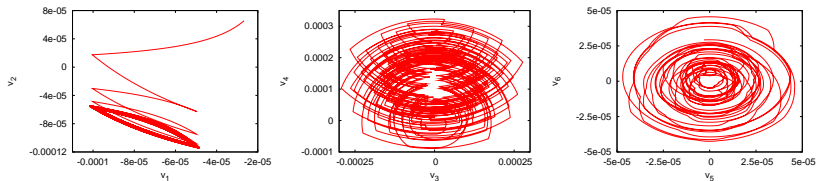

# Results for the Geostorm

## Variation of the sail orientation (No Errors in Manoeuvres)

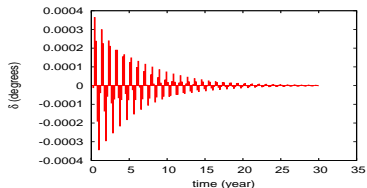
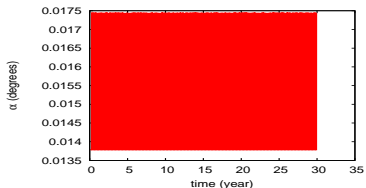

## Variation of the sail orientation (Errors in Manoeuvres)

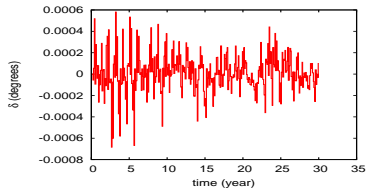
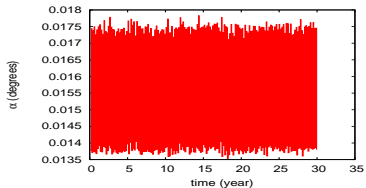

# Results

- We manage to maintain the trajectory close to the equilibrium point for 30 years.
- The most significant errors are the ones due to the sail orientation.
- This station keeping strategy does not require previous planning as the decisions taken by the sail only depend on its position in the phase space.
- The same ideas can be used to design strategies to move along the family of equilibrium points.

# Surfing along the family of equilibria

Scheme on the idea to surf along the family of equilibria.

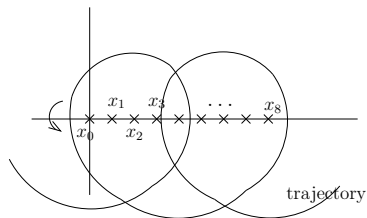
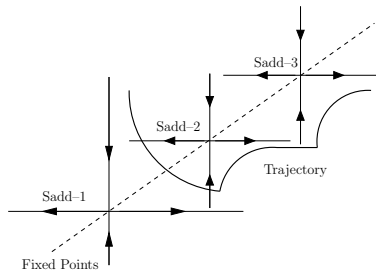

## Reduction to the Centre Manifold

Using an appropriate linear transformation, the equations around the fixed point can be written as,

$$\begin{aligned}\dot{x} &= Ax + f(x, y), & x \in \mathbb{R}^4, \\ \dot{y} &= By + g(x, y), & y \in \mathbb{R}^2,\end{aligned}$$

where  $A$  is an elliptic matrix and  $B$  an hyperbolic one, and  $f(0, 0) = g(0, 0) = 0$  and  $Df(0, 0) = Dg(0, 0) = 0$ .

- We want to obtain  $y = v(x)$ , with  $v(0) = 0$ ,  $Dv(0) = 0$ , the local expression of the centre manifold.
- The flow restricted to the invariant manifold is

$$\dot{x} = Ax + f(x, v(x)).$$

## Approximating the Centre Manifold (I)

To find  $y = v(x)$  we substitute this expression on the differential equations. Hence,  $v(x)$  must satisfy,

$$Dv(x)Ax - Bv(x) = g(x, v(x)) - Dv(x)f(x, v(x)). \quad (1)$$

We take,

$$v(x) = \sum_{|k| \geq 2} v_k x^k, \quad k \in (\mathbb{N} \cup \{0\})^4,$$

its expansion as power series. Then we solve equation (1) to find the coefficients  $v_k$  up to high degree ( $|k| = N$ ).

- $\hat{v}(x) = \sum_{|k|=2}^N v_k x^k$  is a high order approximation of the centre manifold.
- $\dot{x} = Ax + f(x, \hat{v}(x))$  gives a high order approximation of the motion on the centre manifold.



## Approximating the Centre Manifold (II)

- The left hand side of equation (1),

$$L(x) = Dv(x)Ax - Bv(x),$$

is a linear operator w.r.t  $v(x)$  that diagonalizes if  $A$  and  $B$  are diagonal.

- The right hand side of equation (1),

$$h(x) = g(x, v(x)) - Dv(x)f(x, v(x)),$$

can be expressed as,  $h(x) = \sum_{|k| \geq 2} h_k x^k$ , where  $h_k$  depend on  $v_j$  in a known way.

- It can be seen that for a fixed degree  $|k| = n$ , the  $h_k$  depend only on the  $v_j$  such that  $|j| < n$ .

## Approximating the Centre Manifold (III)

We can solve equation (1) in an iterative way, equalising the left and the right hand side degree by degree.

### Notice:

- It is important to have a fast way to find the  $h_k$  to compute high degrees.
- We do not recommend to expand  $f(x, y)$  y  $g(x, y)$ , and then compose with  $y = v(x)$ . One should find other alternative ways, faster in terms of computational time.
- For instance, compute the terms in a recurrent way and use the recurrences to derive an efficient algorithm.
- The matrices  $A$  and  $B$  do not have to be diagonal, but then one must solve a larger linear system at each degree.

## On the Centre Manifold

We have computed the centre manifold around different equilibrium points of the  $FL_1$  family up to degree 16.

- After this reduction we are in a four dimensional phase space  $(x_1, x_2, x_3, x_4)$  that is difficult to visualise.
- We need to perform suitable Poincaré sections to reduce the phase space dimension and help us visualise the phase space.
- For  $\delta = 0$  the system is Hamiltonian and we have a first integral. We will use it to reduce the phase space dimension.
- For  $\delta \neq 0$  the system is no longer Hamiltonian. We will take a function that varies little along the trajectories as an “approximate first integral”, and use it to visualise the phase space.

## Dynamics for $\delta = 0$

Here the first integral is:

$$J_c = (\dot{X}^2 + \dot{Y}^2 + \dot{Z}^2) - 2\Omega(X, Y, Z).$$

- We fix a Poincaré section  $x_3 = 0$  to reduce the system to a three dimensional phase space. (*Taking  $x_3 = 0$  is like taking  $Z = 0$* ).
- We fix the energy level to determine  $x_4$  and reduce the system to a two dimensional phase space that is easy to visualise. (*Taking  $x_4(J_c, x)$  is like taking  $\dot{Z}(J_c, x)$* ).
- We have taken several initial conditions and computed their successive images on the Poincaré section.

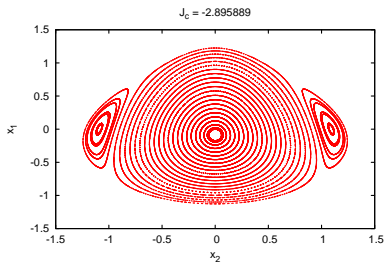
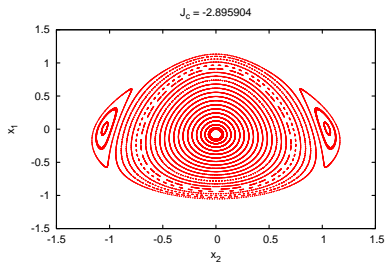
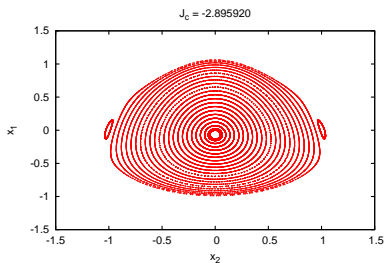
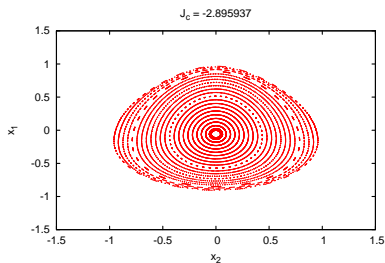
Dynamics for  $\delta = 0$  ( $x_3 = 0$  section)

Dynamics for  $\delta \neq 0$ 

Here we take an “*approximated first integral*” :

$$J_c = (\dot{X}^2 + \dot{Y}^2 + \dot{Z}^2) - 2\Omega(X, Y, Z) + \beta(1 - \mu) \frac{Zr_2}{r_{PS}^3} \cos^2 \delta \sin \delta$$

- We fix a Poincaré section  $x_3 = 0$  to reduce the system to a three dimensional phase space. (*Taking  $x_3 = 0$  is similar to taking  $Z = Z^*$* ).
- We fix  $J_c$  to determine  $x_4$  and reduce the system to a two dimensional phase space that is easy to visualise. (*Taking  $x_4(J_c, x)$  is like taking  $\dot{Z}(J_c, x)$* ).
- We have taken several initial conditions and computed their successive images on the Poincaré section.

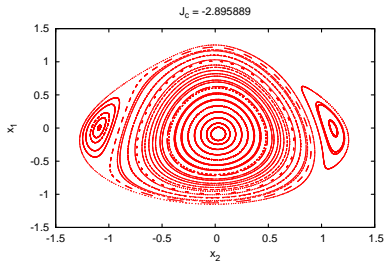
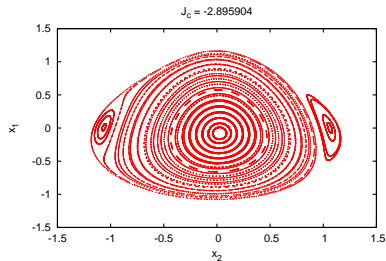
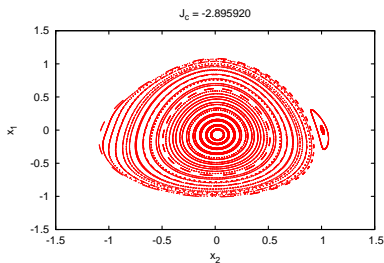
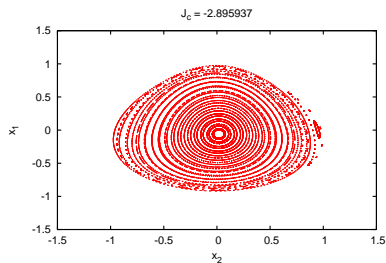
Dynamics for  $\delta = 0.005$  ( $x_3 = 0$  section)

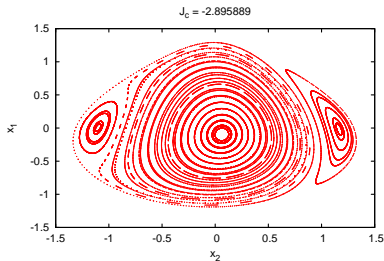
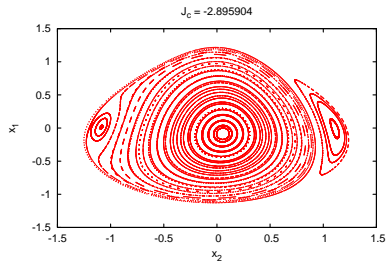
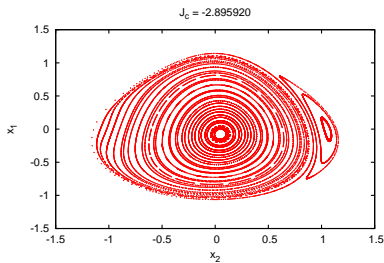
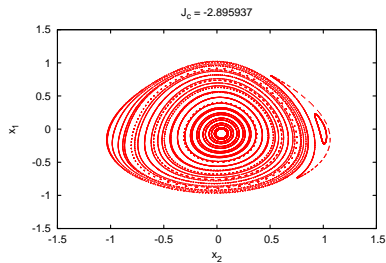
Dynamics for  $\delta = 0.01$  ( $x_3 = 0$  section)



## Station Keeping around Periodic Orbits

We want to extend the ideas on the station keeping around an equilibrium point for the station keeping around a periodic orbit.

Again, the idea is to change the phase space, by changing the sail orientation, so that the system acts as we wish, maintaining the sail's trajectory close to the nominal orbit.

We will focus on the motion around a Halo-type orbit. Although the same ideas should apply to other families of periodic orbits with the same characteristics.

## First approach

The first idea is to extend the methods used for equilibrium points to periodic orbits.

## First approach

The first idea is to extend the methods used for equilibrium points to periodic orbits.

There is an extra difficulty: while the points are persistent when the orientation of the sail is changed, periodic orbits may not. Hence, a careful study of the dynamics is needed.

## Second approach

A second idea is the following: assume that the periodic (for instance, Halo) orbit we want to follow corresponds to  $\alpha = \alpha_0$  and  $\delta = \delta_0$ .

The computation of variational equations (of suitable order) w.r.t.  $\alpha$  and  $\delta$  gives explicit expressions for the effect of different orientations (close to the reference values  $\alpha = \alpha_0$ ,  $\delta = \delta_0$ ) trajectory.

Hence, we can impose conditions on the “future” of the orbit and find orientations that fulfill them (or show that the condition is unattainable).