



**HAL**  
open science

## Weighted Improper Colouring

Julio Araujo, Jean-Claude Bermond, Frédéric Giroire, Frédéric Havet, Dorian Mazaauric, Remigiusz Modrzejewski

► **To cite this version:**

Julio Araujo, Jean-Claude Bermond, Frédéric Giroire, Frédéric Havet, Dorian Mazaauric, et al..  
Weighted Improper Colouring. [Research Report] RR-7590, 2011, pp.23. inria-00583036v3

**HAL Id: inria-00583036**

**<https://inria.hal.science/inria-00583036v3>**

Submitted on 10 Oct 2011 (v3), last revised 5 Jun 2012 (v4)

**HAL** is a multi-disciplinary open access archive for the deposit and dissemination of scientific research documents, whether they are published or not. The documents may come from teaching and research institutions in France or abroad, or from public or private research centers.

L'archive ouverte pluridisciplinaire **HAL**, est destinée au dépôt et à la diffusion de documents scientifiques de niveau recherche, publiés ou non, émanant des établissements d'enseignement et de recherche français ou étrangers, des laboratoires publics ou privés.



INSTITUT NATIONAL DE RECHERCHE EN INFORMATIQUE ET EN AUTOMATIQUE

## *Weighted Improper Colouring*

J. Araujo — J.-C. Bermond — F. Giroire — F. Havet — D. Mazauric — R.  
Modrzejewski

**N° 7590**

Octobre 2011

Domaine 3



*R*apport  
*de recherche*



## Weighted Improper Colouring \*

J. Araujo<sup>† ‡</sup>, J.-C. Bermond<sup>†</sup>, F. Giroire<sup>†</sup>, F. Havet<sup>†</sup>, D. Mazauric<sup>†</sup>, R. Modrzejewski<sup>†</sup>

Thème : Réseaux, systèmes et services, calcul distribué  
Équipe-Projet Mascotte

Rapport de recherche n° 7590 — Octobre 2011 — 23 pages

**Abstract:** In this paper, we study a colouring problem motivated by a practical frequency assignment problem and, up to our best knowledge, new. In wireless networks, a node interferes with other nodes, the level of interference depending on numerous parameters: distance between the nodes, geographical topography, obstacles, etc. We model this with a weighted graph  $(G, w)$  where the weight function  $w$  on the edges of  $G$  represents the noise (interference) between the two end-vertices. The total interference in a node is then the sum of all the noises of the nodes emitting on the same frequency. A weighted  $t$ -improper  $k$ -colouring of  $(G, w)$  is a  $k$ -colouring of the nodes of  $G$  (assignment of  $k$  frequencies) such that the interference at each node does not exceed some threshold  $t$ . We consider here the Weighted Improper Colouring problem which consists in determining the weighted  $t$ -improper chromatic number defined as the minimum integer  $k$  such that  $(G, w)$  admits a weighted  $t$ -improper  $k$ -colouring. We also consider the dual problem, denoted the Threshold Improper Colouring problem, where, given a number  $k$  of colours (frequencies), we want to determine the minimum real  $t$  such that  $(G, w)$  admits a weighted  $t$ -improper  $k$ -colouring. We show that both problems are NP-hard and first present general upper bounds; in particular we show a generalisation of Lovász's Theorem for the weighted  $t$ -improper chromatic number. We then show how to transform an instance of the Threshold Improper Colouring problem into another equivalent one where the weights are either 1 or  $M$ , for a sufficient large  $M$ . Motivated by the original application, we study a special interference model on various grids (square, triangular, hexagonal) where a node produces a noise of intensity 1 for its neighbours and a noise of intensity  $1/2$  for the nodes at distance 2. Consequently, the problem consists in determining the weighted  $t$ -improper chromatic number when  $G$  is the square of a grid and the weights of the edges are 1 if their end-vertices are adjacent in the grid, and  $1/2$  if their end-vertices are linked in the square of the grid, but not in the grid. Finally, we model the problem using integer linear programming, propose and test heuristic and exact Branch-and-Bound algorithms on random cell-like graphs, namely the Poisson-Voronoi tessellations.

**Key-words:** graph colouring, improper colouring, interference, radio networks, frequency assignment, grids, algorithms

\* This work was partially supported by région PACA, ANR Blanc AGAPE (ANR-09-BLAN-0159) and ANR International Taiwan GRATEL (ANR-09-BLAN-0373).

<sup>†</sup> {julio.araujo, jean-claude.bermond, frederic.giroire, frederic.havet, dorian.mazauric, remigiusz.modrzejewski}@inria.fr - MASCOTTE Project, I3S (CNRS & UNS) and INRIA, INRIA Sophia-Antipolis, 2004 route des Lucioles, BP 93, 06902 Sophia-Antipolis Cedex France.

<sup>‡</sup> ParGO Research Group - Universidade Federal do Ceará - UFC - Campus do Pici, Bloco 910. 60455-760 - Fortaleza, CE - Brazil.

## Coloration Impropre Pondérée

**Résumé :** Dans ce papier, nous étudions un nouveau problème de coloration motivé par un problème pratique d'allocation de fréquences. Dans les réseaux sans-fil, un nœud interfère avec d'autres, à un niveau dépendant de nombreux paramètres : la distance entre les nœuds, la topographie physique, les obstacles, etc. Nous modélisons cela par un graphe arête-valué  $(G, w)$  où le poids d'une arête représente le bruit (ou l'interférence) entre ces deux extrémités. L'interférence totale au niveau d'un nœud est alors la somme de tous les bruits entre ce nœud et les autres nœuds émettant avec la même fréquence. Une  $k$ -coloration  $t$ -impropre pondérée de  $(G, w)$  est une  $k$ -coloration des nœuds de  $G$  (assignation de  $k$  fréquences) telle que l'interférence à chaque nœud n'excède pas un certain seuil  $t$ . Dans ce papier, nous étudions le problème de la coloration impropre pondérée qui consiste à déterminer le nombre chromatique  $t$ -impropre pondéré d'un graphe arête-valué  $(G, w)$ , qui est le plus petit entier  $k$  tel que  $(G, w)$  admette une  $k$ -coloration  $t$ -impropre pondérée. Nous considérons également le problème Threshold Improper Colouring (le problème dual) qui, étant donné un nombre de couleurs (fréquences), consiste à déterminer le plus petit réel  $t$  tel que  $(G, w)$  admette une  $k$ -coloration  $t$ -impropre pondérée. Nous montrons que tous ces problèmes sont NP-difficiles en présentant tout d'abord des bornes supérieures générales; en particulier nous prouvons une généralisation du théorème de Lovász pour le problème du nombre chromatique  $t$ -impropre pondéré. Nous montrons ensuite comment transformer une instance du problème Threshold Improper Colouring en une instance équivalente avec des poids 1 ou  $M$ , pour une valeur de  $M$  suffisamment grande. Motivé par l'origine du problème, nous étudions un modèle d'interférence particulier pour différentes grilles (carrée, triangulaire, hexagonale) où un nœud produit un bruit d'intensité 1 pour ses voisins et un bruit d'intensité  $1/2$  pour les nœuds à distance 2. Le problème consiste alors à déterminer le nombre chromatique  $t$ -impropre pondéré lorsque  $G$  est le carré d'une grille et que les poids des arêtes valent 1 si les deux nœuds extrémités sont adjacents dans la grille, et  $1/2$  sinon. Enfin, nous modélisons le problème par des programmes linéaires en nombres entiers, nous proposons des heuristiques et des algorithmes exactes d'énumération par la technique du Branch-and-Bound. Nous les testons pour des graphes aléatoires ressemblant à des réseaux cellulaires, à savoir des tessellations de Poisson-Voronoi.

**Mots-clés :** coloration de graphes, coloration impropre, interférence, allocation de fréquences, réseaux radio, grilles, algorithmes

## 1 Introduction

Let  $G = (V, E)$  be a graph. A  $k$ -colouring of  $G$  is a function  $c : V \rightarrow \{1, \dots, k\}$ . The colouring  $c$  is *proper* if  $uv \in E$  implies  $c(u) \neq c(v)$ . The *chromatic number* of  $G$ , denoted by  $\chi(G)$ , is the minimum integer  $k$  such that  $G$  admits a proper  $k$ -colouring. The goal of the VERTEX COLOURING problem is to determine  $\chi(G)$  for a given graph  $G$ . It is a well-known NP-hard problem [12].

A  $k$ -colouring  $c$  is  *$l$ -improper* if  $|\{v \in N(u) \mid c(v) = c(u)\}| \leq l$  for all  $u \in V$ . Given a non-negative integer  $l$ , the  *$l$ -improper chromatic number* of a graph  $G$ , denoted by  $\chi_l(G)$ , is the minimum integer  $k$  such that  $G$  admits an  $l$ -improper  $k$ -colouring. Given a graph  $G$  and an integer  $l$ , the IMPROPER COLOURING problem consists in determining  $\chi_l(G)$  and is also NP-hard [5, 15]. Indeed, if  $l = 0$ , observe that  $\chi_0(G) = \chi(G)$ . Consequently, VERTEX COLOURING is a particular case of IMPROPER COLOURING.

In this work we define and study a new variation of the IMPROPER COLOURING problem for edge-weighted graphs. An edge-weighted graph is a pair  $(G, w)$  where  $G = (V, E)$  is a graph and  $w : E \rightarrow \mathbb{R}_+^*$ . Given an edge-weighted graph  $(G, w)$  and a colouring  $c$  of  $G$ , the *interference* of a vertex  $u$  in this colouring is defined by

$$I_u(G, w, c) = \sum_{\{v \in N(u) \mid c(v) = c(u)\}} w(u, v).$$

For any non-negative real number  $t$ , called *threshold*, we say that  $c$  is a *weighted  $t$ -improper  $k$ -colouring* of  $(G, w)$  if  $c$  is a  $k$ -colouring of  $G$  such that  $I_u(G, w, c) \leq t$ , for all  $u \in V$ .

Given a threshold  $t \in \mathbb{R}_+^*$ , the minimum integer  $k$  such that the graph  $G$  admits a weighted  $t$ -improper  $k$ -colouring is the *weighted  $t$ -improper chromatic number* of  $(G, w)$ , denoted by  $\chi_t(G, w)$ . Given an edge-weighted graph  $(G, w)$  and a threshold  $t \in \mathbb{R}_+^*$ , determining  $\chi_t(G, w)$  is the goal of the WEIGHTED IMPROPER COLOURING problem. Note that if  $t = 0$  then  $\chi_0(G, w) = \chi(G)$ , and if  $w(e) = 1$  for all  $e \in E$ , then  $\chi_l(G, w) = \chi_l(G)$  for any positive integer  $l$ . Therefore, the WEIGHTED IMPROPER COLOURING problem is clearly NP-hard since it generalises VERTEX COLOURING and IMPROPER COLOURING.

On the other hand, given a positive integer  $k$ , we define the *minimum  $k$ -threshold* of  $(G, w)$ , denoted by  $T_k(G, w)$  as the minimum real  $t$  such that  $(G, w)$  admits a weighted  $t$ -improper  $k$ -colouring. Then, for a given edge-weighted graph  $(G, w)$  and a positive integer  $k$ , the THRESHOLD IMPROPER COLOURING problem consists of determining  $T_k(G, w)$ . The THRESHOLD IMPROPER COLOURING problem is also NP-hard. This fact follows from the observation that determining whether  $\chi_l(G) \leq k$  is NP-complete, for every  $l \geq 2$  and  $k \geq 1$  [5–7]. Consequently, in particular, it is a NP-complete problem to decide whether a graph  $G$  admits a weighted  $t$ -improper 2-colouring when all the weights of the edges of  $G$  are equal to one, for every  $t \geq 2$ .

### 1.1 Motivation

Our initial motivation to these problems was the design of satellite antennas for multi-spot MFTDMA satellites [2]. In this technology, satellites transmit signals to areas on the ground called *spots*. These spots form a grid-like structure which is modelled by an hexagonal cell graph. To each spot is assigned a radio channel or colour. Spots are interfering with other spots having the same channel and a spot can use a colour only if the interference level does not exceed a given threshold  $t$ . The level of interference between two spots depends on their distance. The authors of [2] introduced a factor of mitigation  $\gamma$  and the interferences of remote spots are reduced by a factor  $1 - \gamma$ . When the interference level is too low, the nodes are considered to not interfere anymore. Considering such types of interferences, where nodes at distance at most  $i$  interfere, leads to the study of the  $i$ -th power of the graph modelling the network and a case of special interest is the power of grid graphs (see Section 3).

## 1.2 Related Work

Our problems are particular cases of the FREQUENCY ASSIGNMENT problem (FAP). FAP has several variations that were already studied in the literature (see [1] for a survey). In most of these variations, the main constraint to be satisfied is that if two vertices (mobile phones, antennas, spots, etc.) are close, then the difference between the frequencies that are assigned to them must be greater than some function which usually depends on their distance.

There is a strong relationship between most of these variations and the  $L(p_1, \dots, p_d)$ -LABELLING problem [16]. In this problem, the goal is to find a colouring of the vertices of a given graph  $G$ , in such a way that the difference between the colours assigned to vertices at distance  $i$  is at least  $p_i$ , for every  $i = 1, \dots, d$ .

In some other variants, for each non-satisfied interference constraint a penalty must be paid. In particular, the goal of the MINIMUM INTERFERENCE ASSIGNMENT problem (MI-FAP) is to minimise the total penalties that must be paid, when the number of frequencies to be assigned is given. This problem can also be studied for only *co-channel interferences*, in which the penalties are applied only if the two vertices have the same frequency. However, MI-FAP under these constraints does not correspond to WEIGHTED IMPROPER COLOURING, because we consider the co-channel interference, i.e. penalties, just between each vertex and its neighbourhood.

The two closest related works we found in the literature are [14] and [8]. However, they both apply penalties over co-channel interference, but also to the *adjacent channel interference*, i.e. when the colours of adjacent vertices differ by one unit. Moreover, their results are not similar to ours. In [14], they propose an enumerative algorithm for the problem, while in [8] a Branch-and-Cut method is proposed and applied over some instances.

## 1.3 Results

In this article, we study both parameters  $\chi_r(G, w)$  and  $T_k(G, w)$ . We first present general upper bounds; in particular we show a generalisation of Lovász's Theorem for  $\chi_r(G, w)$ . We then show how to transform an instance of THRESHOLD IMPROPER COLOURING into an equivalent one where the weights are either 1 or  $M$ , for a sufficient large  $M$ .

Motivated by the original application, we study a special interference model on various grids (square, triangular, hexagonal) where a node produces a noise of intensity 1 for its neighbours and a noise of intensity 1/2 for the nodes that are at distance 2. Consequently, the problem consists in determining  $\chi_r(G, w)$  and  $T_k(G, w)$ , when  $G$  is the square of a grid and the weights of the edges are 1, if their end-vertices are adjacent in the grid, and 1/2 if they are adjacent in the square of the grid, but not in the grid.

Finally, we propose a heuristic and a Branch-and-Bound algorithm to solve THRESHOLD IMPROPER COLOURING for general graphs. We compare them to an integer linear programming formulation on random cell-like graphs, namely Voronoi diagrams of random points of the plan. These graphs are classically used in the literature to model telecommunication networks [3, 9, 10].

## 2 General Results

In this section, we present some results for WEIGHTED IMPROPER COLOURING and THRESHOLD IMPROPER COLOURING for general graphs and general interference models.

### 2.1 Upper bounds

Let  $(G, w)$  be an edge-weighted graph with  $w : E(G) \rightarrow \mathbb{R}_+^*$ . For any vertex  $v \in V(G)$ , its *weighted degree* is  $d_w(v) = \sum_{u \in N(v)} w(u, v)$ . The *maximum weighted degree* of  $G$  is  $\Delta(G, w) = \max_{v \in V} d_w(v)$ .

Given a  $k$ -colouring  $c : V \rightarrow \{1, \dots, k\}$  of  $G$ , we define  $d_{w,c}^i(v) = \sum_{\{u \in N(v) \mid c(u)=i\}} w(u, v)$ , for every vertex  $v \in V(G)$  and colour  $i = 1, \dots, k$ . Note that  $d_{w,c}^{c(v)}(v) = I_v(G, w, c)$ . We say that a  $k$ -colouring  $c$  of  $G$  is  $w$ -balanced if  $c$  satisfies the following property:

$$\text{For any vertex } v \in V(G), I_v(G, w, c) \leq d_{w,c}^j(v), \text{ for every } j = 1, \dots, k.$$

We denote by  $\gcd(w)$  the greatest common divisor of the weights of  $w$ . We use here the generalisation of the gcd to non-integer numbers (e.g. in  $\mathbb{Q}$ ) where a number  $x$  is said to divide a number  $y$  if the fraction  $y/x$  is an integer. The important property of  $\gcd(w)$  is that the difference between two interferences is a multiple of  $\gcd(w)$ ; in particular, if for two vertices  $v$  and  $u$ ,  $d_{w,c}^i(v) > d_{w,c}^j(u)$ , then  $d_{w,c}^i(v) \geq d_{w,c}^j(u) + \gcd(w)$ .

If  $t$  is not a multiple of the  $\gcd(w)$ , that is, there exists an integer  $a \in \mathbb{Z}$  such that  $a \gcd(w) < t < (a+1)\gcd(w)$ , then  $\chi_t^w(G) = \chi_{a \gcd(w)}^w(G)$ .

**Proposition 1.** *Let  $(G, w)$  be an edge-weighted graph. For any  $k \geq 2$ , there exists a  $w$ -balanced  $k$ -colouring of  $G$ .*

*Proof.* Let us colour  $G = (V, E)$  arbitrarily with  $k$  colours and then repeat the following procedure: if there exists a vertex  $v$  coloured  $i$  and a colour  $j$  such that  $d_{w,c}^i(v) > d_{w,c}^j(v)$ , then recolour  $v$  with colour  $j$ . Observe that this procedure neither increases (we just move a vertex from one colour to another) nor decreases (a vertex without neighbour on its colour is never moved) the number of colours within this process. Let  $W$  be the sum of the weights of the edges having the same colour in their end-vertices. In this transformation,  $W$  has increased by  $d_{w,c}^j(v)$  (edges that previously had colours  $i$  and  $j$  in their end-vertices), but decreased by  $d_{w,c}^i(v)$  (edges that previously had colour  $i$  in both of their end-vertices). So,  $W$  has decreased by  $d_{w,c}^i(v) - d_{w,c}^j(v) \geq \gcd(w)$ . As  $W \leq |E| \max_{e \in E} w(e)$  is finite, this procedure finishes and produces a  $w$ -balanced  $k$ -colouring of  $G$ .  $\square$

The existence of a  $w$ -balanced colouring gives easily some upper bounds on the weighted  $t$ -improper chromatic number and the minimum  $k$ -threshold of an edge-weighted graph  $(G, w)$ . It is a folklore result that  $\chi(G) \leq \Delta(G) + 1$ , for any graph  $G$ . Lovász [13] extended this result for IMPROPER COLOURING problem using  $w$ -balanced colouring. He proved that  $\chi_t(G) \leq \left\lceil \frac{\Delta(G)+1}{t+1} \right\rceil$ . In what follows, we extend this result to weighted improper colouring.

**Theorem 2.** *Let  $(G, w)$  be an edge-weighted graph with  $w : E(G) \rightarrow \mathbb{Q}_+^*$ , and  $t$  a multiple of  $\gcd(w)$ . Then*

$$\chi_t(G, w) \leq \left\lceil \frac{\Delta(G, w) + \gcd(w)}{t + \gcd(w)} \right\rceil.$$

*Proof.* If  $k = 1$  there is nothing to prove.

Observe that, in any  $w$ -balanced  $k$ -colouring  $c$  of a graph  $G$ , the following holds:

$$d_w(v) = \sum_{u \in N(v)} w(u, v) \geq k d_{w,c}^{c(v)}(v). \quad (1)$$

Let  $k^* = \left\lceil \frac{\Delta(G, w) + \gcd(w)}{t + \gcd(w)} \right\rceil \geq 2$  and  $c^*$  be a  $w$ -balanced  $k^*$ -colouring of  $G$ . We claim that  $c^*$  is a weighted  $t$ -improper  $k^*$ -colouring of  $(G, w)$ .

By contradiction, suppose that there is a vertex  $v$  in  $G$  such that  $c^*(v) = i$  and that  $d_{w,c^*}^i(v) > t$ . Since  $c^*$  is  $w$ -balanced,  $d_{w,c^*}^j(v) > t$ , for all  $j = 1, \dots, k^*$ . By the definition of  $\gcd(w)$  and as  $t$  is a multiple of  $\gcd(w)$ , it leads to  $d_{w,c^*}^j(v) \geq t + \gcd(w)$  for all  $j = 1, \dots, k^*$ . Combining this inequality with Inequality (1), we obtain:

$$\Delta(G, w) \geq d_w(v) \geq k^*(t + \gcd(w)),$$

giving

$$\Delta(G, w) \geq \Delta(G, w) + \gcd(w),$$

a contradiction. The result follows.  $\square$



Note that when all weights are unit, we obtain the bound for the improper colouring derived in [13]. Brooks [4] proved that for a connected graph  $G$ ,  $\chi(G) = \Delta(G) + 1$  if, and only if,  $G$  is complete or an odd cycle. One could wonder for which edge-weighted graphs the bound we provided in Theorem 2 is tight. However, Correa *et al.* [5] already showed that it is NP-complete to determine if the improper chromatic number of a graph  $G$  attains the upper bound of Lovász, which is a particular case of WEIGHTED IMPROPER COLOURING, i.e., of the bound Theorem 2.

The  $w$ -balanced colourings also yields upper bounds for the minimum  $k$ -threshold of an edge-weighted graph  $(G, w)$ . When  $k = 1$ , then all the vertices must be coloured same, and  $T_1(G, w) = \Delta(G, w)$ . This may be generalized as follows, using  $w$ -balanced colourings.

**Theorem 3.** *Let  $(G, w)$  be an edge-weighted graph with  $w : E(G) \rightarrow \mathbb{R}_+$ , and let  $k$  be a positive integer. Then*

$$T_k(G, w) \leq \frac{\Delta(G, w)}{k}.$$

*Proof.* Let  $c$  be a  $w$ -balanced  $k$ -colouring of  $G$ . Then

$$kT_k(G, w) \leq kd_{w,c}^{c(v)}(v) \leq d_w(v) = \sum_{u \in N(v)} w(u, v) \leq \Delta(G, w)$$

□

Because  $T_1(G, w) = \Delta(G, w)$ , Theorem 3 may be restated as  $T_k(G, w) \leq T_1(G, w)$ . This inequality may be generalised as follows.

**Theorem 4.** *Let  $(G, w)$  be an edge-weighted graph with  $w : E(G) \rightarrow \mathbb{R}_+$ , and let  $k$  and  $p$  be two positive integers. Then*

$$T_{kp}(G, w) \leq \frac{T_p(G, w)}{k}.$$

*Proof.* Set  $t = T_p(G, w)$ . Let  $c$  be a  $t$ -improper  $p$ -colouring of  $(G, w)$ . For  $i = 1, \dots, p$ , let  $G_i$  be the subgraph of  $G$  induced by the vertices coloured  $i$  by  $c$ . By definition of improper colouring  $\Delta(G_i, w) \leq t$  for all  $1 \leq i \leq p$ . By Theorem 3, each  $(G_i, w)$  admits a  $t/k$ -improper  $k$ -colouring  $c_i$  with colours  $\{(i-1)k+1, \dots, ik\}$ . The union of the  $c_i$ 's is then a  $t/k$ -improper  $kp$ -colouring of  $(G, w)$ . □

Theorem 4 and its proof suggest that to find a  $kp$ -colouring with small impropriety, it may be convenient to first find a  $p$ -colouring with small impropriety and then to refine it. In addition, such a strategy, allows to adapt dynamically the refinement. In the above proof, the vertex set of each part  $G_i$  is again partitionned into  $k$  parts. However, sometimes, we shall get a better  $kp$ -colouring by partitionning each  $G_i$  into a number  $k_i$  parts, with  $\sum_{i=1}^p k_i = kp$ . Doing so, we obtain a  $T$ -improper  $kp$ -colouring of  $(G, w)$ , where  $T = \max\{\frac{\Delta(G_i, w)}{k_i}, 1 \leq i \leq p\}$ .

One can also find upper bound on the minimum  $k$ -threshold by considering first the  $k-1$  edges of largest weight around each vertex. Let  $(G, w)$  be an edge-weighted graph, and let  $v_1, \dots, v_n$  be an ordering of the vertices of  $G$ . The edges of  $G$  may be ordered in increasing order of their weight. Furthermore, to make sure that the edges incident to any particular vertex are totally ordered, we break ties according to the label of the second vertex. Formally, we say that  $v_i v_j \leq_w v_i v_{j'}$  if either  $w(v_i v_j) < w(v_i v_{j'})$  or  $w(v_i v_j) = w(v_i v_{j'})$  and  $j < j'$ . With such a partial order on the edge set, the set  $E_w^k(v)$  of  $k-1$  greatest edges (according to this ordering) around a vertex is uniquely defined. Observe that every edge incident to  $v$  and not in  $E_w^k(v)$  is smaller than an edge of  $E_w^k(v)$  for  $\leq_w$ .

Let  $G_w^k$  be the graph with vertex set  $V(G)$  and edge set  $\bigcup_{v \in V(G)} E_w^k(v)$ . Observe that every vertex of  $E_w^k(v)$  has degree at least  $k-1$ , but a vertex may have an arbitrarily large degree. For if any edge incident to  $v$  has a greater weight than any edge not incident to  $v$ , the degree of  $v$  in  $G_w^k$  is equal to its degree in  $G$ . However we now prove that at least one vertex has degree  $k-1$ .

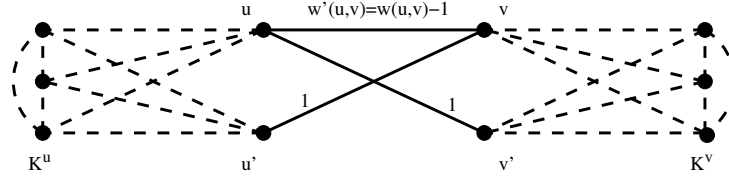

Figure 1: Construction of  $G^{i+1}$  from  $G^i$  using edge  $(u, v)$  with  $k = 4$ . Dashed edges represent edges with infinite weights.

**Proposition 5.** *If  $(G, w)$  is an edge-weighted graph, then  $G_w^k$  has a vertex of degree  $k - 1$ .*

*Proof.* Suppose for a contradiction, that every vertex has degree at least  $k$ , then every vertex  $x$  there is an edge  $xy$  in  $E(G_w^k) \setminus E_w^k(x)$ , and so in  $E_w^k(y) \setminus E_w^k(x)$ . Therefore, there must be a cycle  $(x_1, \dots, x_r)$  such that, for all  $1 \leq i \leq r$ ,  $x_i x_{i+1} \in E_w^k(x_{i+1}) \setminus E_w^k(x_i)$  (with  $x_{r+1} = x_1$ ). It follows that  $x_1 x_2 \leq_w x_2 x_3 \leq_w \dots \leq_w x_r x_1 \leq_w x_1 x_2$ . Hence, by definition,  $w(x_1 x_2) = w(x_2 x_3) = \dots = w(x_r x_1) = w(x_1 x_2)$ . Let  $m$  be the integer such that  $x_m$  has maximum index in the ordering  $v_1, \dots, v_n$ . Then there exists  $j$  and  $j'$  such that  $x_m = v_j$  and  $x_{m+2} = v_{j'}$ . By definition of  $m$ , we have  $j > j'$ . But this contradicts the fact that  $x_m x_{m+1} \leq_w x_{m+1} x_{m+2}$ .  $\square$

**Corollary 6.** *If  $(G, w)$  is an edge-weighted graph, then  $G_w^k$  has a proper  $k$ -colouring.*

*Proof.* By induction on the number of vertices. By Proposition 5,  $G_w^k$  has a vertex  $x$  of degree at most  $k - 1$ . Trivially,  $G_w^k - x$  is a subgraph of  $(G - x)_w^k$ . By the induction hypothesis,  $(G - x)_w^k$  has a proper  $k$ -colouring, which is also a proper  $k$ -colouring of  $(G - x)_w^k$ . This colouring can be extended in a proper  $k$ -colouring of  $G_w^k$ , by assigning to  $x$  a colour not assigned to any of its  $k - 1$  neighbours.  $\square$

**Corollary 7.** *If  $(G, w)$  is an edge-weighted graph, then  $T_k(G, w) \leq \Delta(G \setminus E(G_w^k), w)$ .*

## 2.2 Transformation

In this section, we prove that the THRESHOLD IMPROPER COLOURING problem can be transformed into a problem mixing proper and improper colouring. More precisely, we prove the following:

**Theorem 8.** *Let  $(G_0, w_0)$  be an edge-weighted graph where  $w_0$  is an integer-valued function, and let  $k$  be a positive integer. We can construct an edge-weighted graph  $(G^*, w^*)$  such that  $w^*(e) \in \{1, M\}$  for any  $e \in E(G^*)$ , satisfying  $T_k(G_0, w_0) = T_k(G^*, w^*)$ , where  $M = 1 + \sum_{e \in E(G)} w_0(e)$ .*

*Proof.* Consider the function  $f(G, w) = \sum_{\{e \in E(G) \mid w(e) \neq M\}} (w(e) - 1)$ .

If  $f(G, w) = 0$ , all edges have weight either 1 or  $M$  and  $G$  has the desired property. In this case,  $G^* = G$ . Otherwise, we construct a graph  $G'$  and a function  $w'$  such that  $T_k(G', w') = T_k(G, w)$ , but  $f(G', w') = f(G, w) - 1$ . By repeating this operation  $f(G_0, w_0)$  times we get the required edge-weighted graph  $(G^*, w^*)$ .

In case  $f(G, w) > 0$ , there exists an edge  $e = uv \in E(G)$  such that  $2 \leq w(e) < M$ .  $G'$  is obtained from  $G$  by adding two complete graphs on  $k - 1$  vertices  $K^u$  and  $K^v$  and two new vertices  $u'$  and  $v'$ . We join  $u$  and  $u'$  to all the vertices of  $K^u$  and  $v$  and  $v'$  to all the vertices of  $K^v$ . We assign weight  $M$  to all these edges. Note that,  $u$  and  $u'$  ( $v$  and  $v'$ ) always have the same colour, namely the remaining colour not used in  $K^u$  (resp.  $K^v$ ).

We also add two edges  $uv'$  and  $u'v$  both of weight 1. The edges of  $G$  keep their weight in  $G'$ , except the edge  $e = uv$  whose weight is decreased by one unit, i.e.,  $w'(e) = w(e) - 1$ . Thus,  $f(G') = f(G) - 1$  as we added only edges of weights 1 and  $M$  and we decreased the weight of  $e$  by one unit.

Now consider a weighted  $t$ -improper  $k$ -colouring  $c$  of  $(G, w)$ . We produce a weighted  $t$ -improper  $k$ -colouring  $c'$  of  $(G', w')$  as follows: we keep the colours of all the vertices in  $G$ , we assign to  $u'$  ( $v'$ ) the same colour as  $u$  (resp.  $v$ ), and we assign to  $K^u$  (resp.  $K^v$ ) the  $k - 1$  colours different from the one used in  $u$  (resp.  $v$ ).

Conversely, from any weighted improper  $k$ -colouring  $c'$  of  $(G', w')$ , we get a weighted improper  $k$ -colouring  $c$  of  $(G, w)$  by just keeping the colours of the vertices that belong to  $G$ .

For such colourings  $c$  and  $c'$  we have that  $I_x(G, w, c) = I_x(G', w', c')$ , for any vertex  $x$  of  $G$  different from  $u$  and  $v$ . For  $x \in K^u \cup K^v$ ,  $I_x(G', w', c') = 0$ . The neighbours of  $u$  with the same colour as  $u$  in  $G'$  are the same as in  $G$ , except possibly  $v'$  which has the same colour of  $u$  if, and only if,  $v$  has the same colour of  $u$ . Let  $\varepsilon = 1$  if  $v$  has the same colour as  $u$ , otherwise  $\varepsilon = 0$ . As the weight of  $uv$  decreases by one and we add the edge  $uv'$  of weight 1 in  $G'$ , we get  $I_u(G', w', c') = I_u(G, w, c) - \varepsilon + w'(u, v')\varepsilon = I_u(G, w, c)$ . Similarly,  $I_v(G', w', c') = I_v(G, w, c)$ . Finally,  $I_{u'}(G', w', c') = I_{v'}(G', w', c') = \varepsilon$ . But  $I_u(G', w', c') \geq (w(u, v) - 1)\varepsilon$  and so  $I_{u'}(G', w', c') \leq I_u(G', w', c')$  and  $I_{v'}(G', w', c') \leq I_v(G', w', c')$ . In summary, we have

$$\max_x I_x(G', w', c') = \max_x I_x(G, w, c)$$

and therefore  $T_k(G, w) = T_k(G', w')$ . □

In the worst case, the number of vertices of  $G^*$  is  $n + m(w_{max} - 1)2k$  and the number of edges of  $G^*$  is  $m + m(w_{max} - 1)[(k + 4)(k - 1) + 2]$  with  $n = |V(G)|$ ,  $m = |E(G)|$  and  $w_{max} = \max_{e \in E(G)} w(e)$ .

In conclusion, this construction allows to transform the THRESHOLD IMPROPER COLOURING problem into a problem mixing proper and improper colouring. Therefore the problem consists in finding the minimum  $l$  such that a (non-weighted)  $l$ -improper  $k$ -colouring of  $G^*$  exists with the constraint that some subgraphs of  $G^*$  must admit a proper colouring. The equivalence of the two problems is proved here only for integers weights, but it is possible to adapt the transformation to prove it for rational weights.

### 3 Squares of Particular Graphs

As mentioned in the introduction, WEIGHTED IMPROPER COLOURING is motivated by networks of antennas similar to grids [2]. In these networks, the noise generated by an antenna undergoes an attenuation with the distance it travels. It is often modelled by a decreasing function of  $d$ , typically  $1/d^\alpha$  or  $1/(2^{d-1})$ .

Here we consider a simplified model where the noise between two neighbouring antennas is normalised to 1, between antennas at distance two is  $1/2$  and 0 when the distance is strictly greater than 2. Studying this model of interference corresponds to study the WEIGHTED IMPROPER COLOURING of the square of the graph  $G$ , that is the graph  $G^2$  obtained from  $G$  by joining every pair of vertices at distance 2, and to assign weights  $w_2(e) = 1$ , if  $e \in E(G)$ , and  $w_2(e) = 1/2$ , if  $e \in E(G^2) \setminus E(G)$ . Observe that in this case the interesting threshold values are the non-negative multiples of  $1/2$ .

Figure 2 shows some examples of colouring for the square grid. In Figure 2(b), each vertex  $x$  has neither a neighbour nor a vertex at distance 2 coloured with its own colour, so  $I_x(G^2, w_2, c) = 0$  and  $G^2$  admits a weighted 0-improper 5-colouring. In Figure 2(c), each vertex  $x$  has no neighbour with its colour and at most one vertex of the same colour at distance 2. So  $I_x(G^2, w_2, c) = 1/2$  and  $G^2$  admits a weighted 0.5-improper 4-colouring.

For any  $t \in \mathbb{R}_+$ , we determine the weighted  $t$ -improper chromatic number for the square of infinite paths, square grids, hexagonal grids and triangular grids under the interference model  $w_2$ . We also present lower and upper bounds for  $\chi_t(T^2, w_2)$ , for any tree  $T$  and any threshold  $t$ .

#### 3.1 Infinite paths and trees

In this section, we characterise the weighted  $t$ -improper chromatic number of the square of an infinite path, for all positive real  $t$ . Moreover, we present lower and upper bounds for  $\chi_t(T^2, w_2)$ , for a given tree  $T$ .

**Theorem 9.** Let  $P = (V, E)$  be an infinite path. Then,

$$\chi_t(P^2, w_2) = \begin{cases} 3, & \text{if } 0 \leq t < 1; \\ 2, & \text{if } 1 \leq t < 3; \\ 1, & \text{if } 3 \leq t. \end{cases}$$

*Proof.* Let  $V = \{v_i \mid i \in \mathbb{Z}\}$  and  $E = \{(v_{i-1}, v_i) \mid i \in \mathbb{Z}\}$ . Each vertex of  $P$  has two neighbours and two vertices at distance two. Consequently, the case  $t \geq 3$  is trivial.

There is a 2-colouring  $c$  of  $(P^2, w_2)$  with maximum interference 1 by just colouring  $v_i$  with colour  $(i \bmod 2) + 1$ . So  $\chi_t(P^2, w_2) \leq 2$  if  $t \geq 1$ . We claim that there is no weighted 0.5-improper 2-colouring of  $(P^2, w_2)$ . By contradiction, suppose that  $c$  is such a colouring. If  $c(v_i) = 1$ , for some  $i \in \mathbb{Z}$ , then  $c(v_{i-1}) = c(v_{i+1}) = 2$  and  $c(v_{i-2}) = c(v_{i+2}) = 1$ . This is a contradiction because  $v_i$  would have interference 1.

Finally, the colouring  $c(v_i) = (i \bmod 3) + 1$ , for every  $i \in \mathbb{Z}$ , is a feasible weighted 0-improper 3-colouring.  $\square$

**Theorem 10.** Let  $T = (V, E)$  be a tree. Then,  $\left\lceil \frac{\Delta(T) - \lfloor t \rfloor}{2t+1} \right\rceil + 1 \leq \chi_t(T^2, w_2) \leq \left\lceil \frac{\Delta(T) - 1}{2t+1} \right\rceil + 2$ .

*Proof.* The lower bound is obtained by two simple observations. First,  $\chi_t(H, w) \leq \chi_t(G, w)$ , for any  $H \subseteq G$ . Let  $T$  be a tree and  $v$  be a node of maximum degree in  $T$ . Then, observe that the weighted  $t$ -improper chromatic number of the subgraph of  $T^2$  induced by  $v$  and its neighbourhood is at least  $\left\lceil \frac{\Delta(T) - \lfloor t \rfloor}{2t+1} \right\rceil + 1$ . Indeed, the colour of  $v$  can be assigned to at most  $\lfloor t \rfloor$  vertices on its neighbourhood. Any other colour used in the neighbourhood of  $v$  cannot appear in more than  $2t + 1$  vertices because each pair of vertices in the neighbourhood of  $v$  is at distance two.

Let us look now at the upper bound. Choose any node  $r \in V$  to be the root of  $T$ . Colour  $r$  with colour 1. Then, by a pre-order traversal in the tree, for each visited node  $v$  colour all the children of  $v$  with the  $\left\lceil \frac{\Delta(T) - 1}{2t+1} \right\rceil$  colours different from the ones assigned to  $v$  and to its parent in such a way that at most  $2t + 1$  nodes have the same colour. This is a feasible weighted  $t$ -improper  $k$ -colouring of  $T^2$ , with  $k \leq \left\lceil \frac{\Delta(T) - 1}{2t+1} \right\rceil + 2$ , since each vertex interferes with at most  $2t$  vertices at distance two which are children of its parent.  $\square$

## 3.2 Grids

In this section, we show the optimal values of  $\chi_t(G^2, w_2)$ , whenever  $G$  is an infinite square, hexagonal or triangular grid, for all the possible values of  $t$ .

### 3.2.1 Square Grid

The square grid is the graph  $\mathfrak{S}$  in which the vertices are all integer linear combinations  $ae_1 + be_2$  of the two vectors  $e_1 = (1, 0)$  and  $e_2 = (0, 1)$ , for any  $a, b \in \mathbb{Z}$ . Each vertex  $(a, b)$  has four neighbours: its *down neighbour*  $(a, b - 1)$ , its *up neighbour*  $(a, b + 1)$ , its *right neighbour*  $(a + 1, b)$  and its *left neighbour*  $(a - 1, b)$  (see Figure 2(a)).

**Theorem 11.**

$$\chi_t(\mathfrak{S}^2, w_2) = \begin{cases} 5, & \text{if } t = 0; \\ 4, & \text{if } t = 0.5; \\ 3, & \text{if } 1 \leq t < 3; \\ 2, & \text{if } 3 \leq t < 8; \\ 1, & \text{if } 8 \leq t. \end{cases}$$

*Proof.* If  $t = 0$ , then the colour of vertex  $(a, b)$  must be different from the ones used on its four neighbours. Moreover, all the neighbours have different colours, as each pair of neighbours is at distance two. Consequently, at least 5 colours are needed. The following construction provides a weighted 0-improper 5-colouring of  $(\mathfrak{S}^2, w_2)$ :

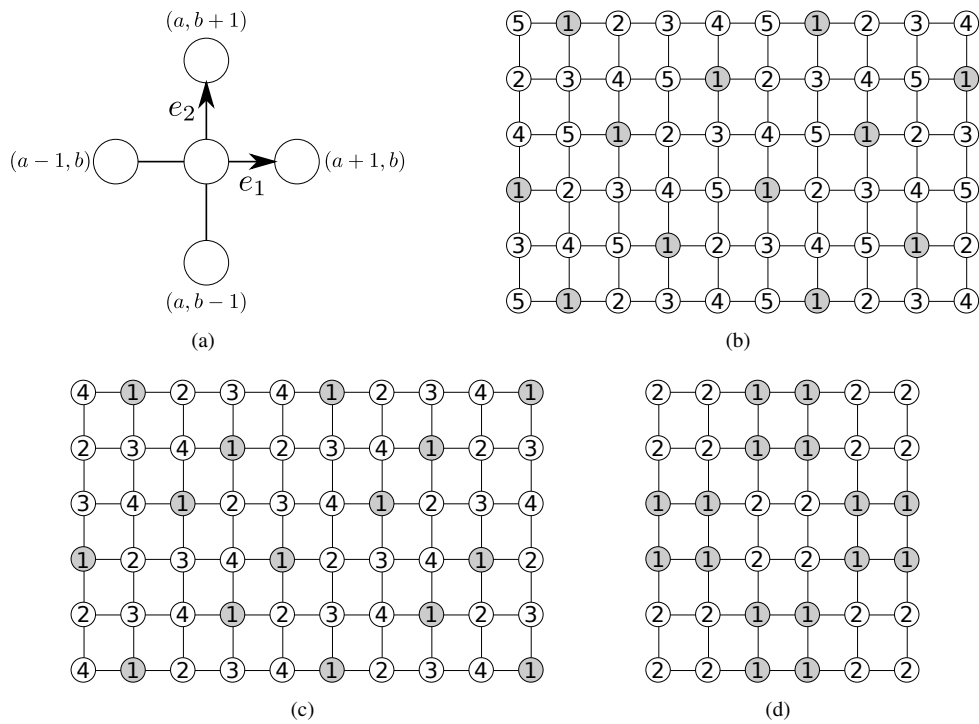

Figure 2: Optimal colourings of  $(\mathcal{S}^2, w_2)$ : (b) weighted 0-improper 5-colouring of  $(\mathcal{S}^2, w_2)$ , (c) weighted 0.5-improper 4-colouring of  $(\mathcal{S}^2, w_2)$ , and (d) weighted 3-improper 2-colouring of  $(\mathcal{S}^2, w_2)$ .

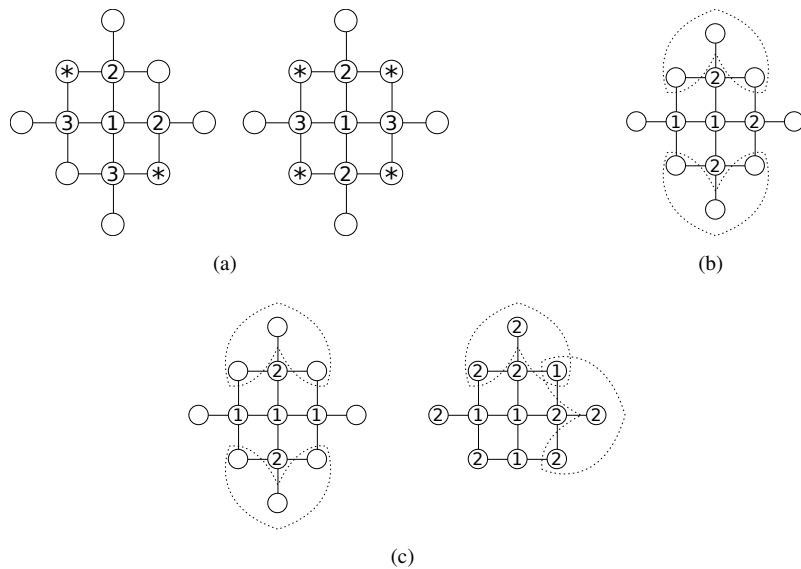

Figure 3: Lower bounds for the square grid: (a) if  $t \leq 0.5$  and  $k \leq 3$ , there is no weighted  $t$ -improper  $k$ -colouring of  $(\mathcal{S}^2, w_2)$ ; (b) the first case when  $t \leq 2.5$  and  $k \leq 2$ , and (c) the second case.

for  $0 \leq j \leq 4$ , let  $A_j = \{(j, 0) + a(5e_1) + b(2e_1 + 1e_2) \mid \forall a, b \in \mathbb{Z}\}$ . For  $0 \leq j \leq 4$ , assign the colour  $j + 1$  to all the vertices in  $A_j$  (see Figure 2(b)).

When  $t = 0.5$ , we claim that at least four colours are needed to colour  $(\mathfrak{S}^2, w_2)$ . The proof is by contradiction. Suppose that there exists a weighted 0.5-improper 3-colouring of it. Let  $(a, b)$  be a vertex coloured 1. None of its neighbours is coloured 1, otherwise  $(a, b)$  has interference 1. If three neighbours have the same colour, then each of them will have interference 1. So two of its neighbours have to be coloured 2 and the two other ones 3 (see Figure 3(a)). Consider now the four nodes  $(a - 1, b - 1)$ ,  $(a - 1, b + 1)$ ,  $(a + 1, b - 1)$  and  $(a + 1, b + 1)$ . For all configurations, at least two of these four vertices have to be coloured 1 (the ones indicated by a \* in Figure 3(a)). But then  $(a, b)$  will have interference at least 1, a contradiction. A weighted 0.5-improper 4-colouring of  $(\mathfrak{S}^2, w_2)$  can be obtained as follows (see Figure 2(c)): for  $0 \leq j \leq 3$ , let  $B_j = \{(j, 0) + a(4e_1) + b(3e_1 + 2e_2) \mid \forall a, b \in \mathbb{Z}\}$  and  $B'_j = \{(j + 1, 2) + a(4e_1) + b(3e_1 + 2e_2) \mid \forall a, b \in \mathbb{Z}\}$ . For  $0 \leq j \leq 3$ , assign the colour  $j + 1$  to all the vertices in  $B_j$  and in  $B'_j$ .

If  $t = 1$ , there exists a weighted 1-improper 3-colouring of  $(\mathfrak{S}^2, w_2)$  given by the following construction: for  $0 \leq j \leq 2$ , let  $C_j = \{(j, 0) + a(3e_1) + b(e_1 + e_2) \mid \forall a, b \in \mathbb{Z}\}$ . For  $0 \leq j \leq 2$ , assign the colour  $j + 1$  to all the vertices in  $C_j$ .

Now we prove by contradiction that for  $t = 2.5$  we still need at least three colours in a weighted 2.5-improper colouring of  $(\mathfrak{S}^2, w_2)$ . Consider a weighted 2.5-improper 2-colouring of  $(\mathfrak{S}^2, w_2)$  and let  $(a, b)$  be a vertex coloured 1. Vertex  $(a, b)$  has at most two neighbours of colour 1, otherwise it will have interference 3. We distinguish three cases:

1. Exactly one of its neighbours is coloured 1; let  $(a - 1, b)$  be this vertex. Then, the three other neighbours are coloured 2 (see Figure 3(b)). Consider the two sets of vertices  $\{(a - 1, b - 1), (a + 1, b - 1), (a, b - 2)\}$  and  $\{(a - 1, b + 1), (a + 1, b + 1), (a, b + 2)\}$  (these sets are surrounded by dotted lines in Figure 3(b)); each of them has at least two vertices coloured 1, otherwise the vertex  $(a, b - 1)$  or  $(a, b + 1)$  will have interference 3. But then  $(a, b)$  having four vertices at distance 2 coloured 1 has interference 3, a contradiction.
2. Two neighbours of  $(a, b)$  are coloured 1.
  - (a) These two neighbours are opposite, say  $(a - 1, b)$  and  $(a + 1, b)$  (see Figure 3(c) left). Consider again the two sets  $\{(a - 1, b - 1), (a + 1, b - 1), (a, b - 2)\}$  and  $\{(a - 1, b + 1), (a + 1, b + 1), (a, b + 2)\}$  (these sets are surrounded by dotted lines in Figure 3(c) left); they both contain at least one vertex of colour 1 and therefore  $(a, b)$  will have interference 3, a contradiction.
  - (b) The two neighbours of colour 1 are of the form  $(a, b - 1)$  and  $(a - 1, b)$  (see Figure 3(c) right). Consider the two sets of vertices  $\{(a + 1, b - 1), (a + 1, b + 1), (a + 2, b)\}$  and  $\{(a + 1, b + 1), (a - 1, b + 1), (a, b + 2)\}$  (these sets are surrounded by dotted lines in Figure 3(c) right); these two sets contain at most one vertex of colour 1, otherwise  $(a, b)$  will have interference 3. So vertices  $(a + 1, b - 1)$ ,  $(a + 2, b)$ ,  $(a, b + 2)$  and  $(a - 1, b + 1)$  are of colour 2. Vertex  $(a + 1, b + 1)$  is of colour 1, otherwise  $(a + 1, b)$  has interference 3. But then  $(a - 2, b)$  and  $(a - 1, b - 1)$  are of colour 2, otherwise  $(a, b)$  will have interference 3. Thus, vertex  $(a - 1, b)$  has exactly one neighbour coloured 1 and we are again in Case 1.
3. All neighbours of  $(a, b)$  are coloured 2. If one of these neighbours has itself a neighbour (distinct from  $(a, b)$ ) of colour 2, we are in Case 1 or 2 for this neighbour. Therefore, all vertices at distance two from  $(a, b)$  have colour 1 and the interference in  $(a, b)$  is 4, a contradiction.

A weighted 3-improper 2-colouring of  $(\mathfrak{S}^2, w_2)$  can be obtained as follows: a vertex of the grid  $(a, b)$  is coloured with colour  $(\lfloor \frac{a}{2} \rfloor + \lfloor \frac{b}{2} \rfloor \bmod 2) + 1$ , see Figure 2(d).

Finally, since each vertex has four neighbours and eight vertices at distance two, there is no weighted 7.5-improper 1-colouring of  $(\mathfrak{S}^2, w_2)$  and, whenever  $t \geq 8$ , one colour suffices. □

### 3.2.2 Hexagonal Grid

There are many ways to define the system of coordinates of the hexagonal grid. Here, we use grid coordinates as shown in Figure 4. The hexagonal grid graph is then the graph  $\mathfrak{H}$  whose vertex set consists in the pairs of integers  $(a, b) \in \mathbb{Z}^2$  and where each vertex  $(a, b)$  has three neighbours:  $(a - 1, b)$ ,  $(a + 1, b)$ , and  $(a, b + 1)$  if  $a + b$  is odd, or  $(a, b - 1)$  otherwise.

**Theorem 12.**

$$\chi_t(\mathfrak{H}^2, w_2) = \begin{cases} 4, & \text{if } 0 \leq t < 1; \\ 3, & \text{if } 1 \leq t < 2; \\ 2, & \text{if } 2 \leq t < 6; \\ 1, & \text{if } 6 \leq t. \end{cases}$$

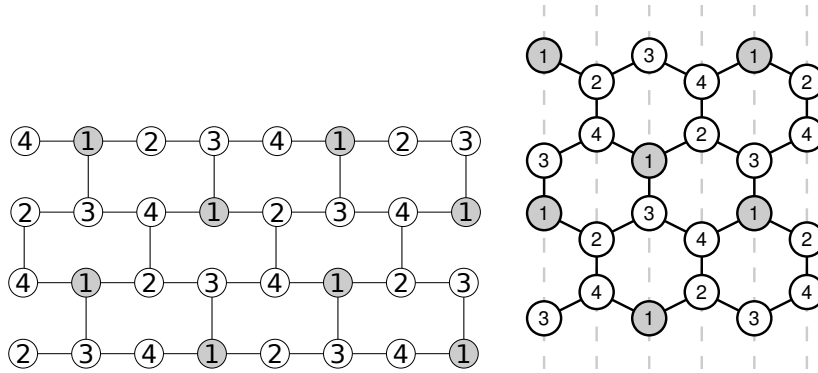

Figure 4: Weighted 0-improper 4-colouring of  $(\mathfrak{H}^2, w_2)$ . Left: Graph with coordinates. Right: Corresponding hexagonal grid in the euclidean space.

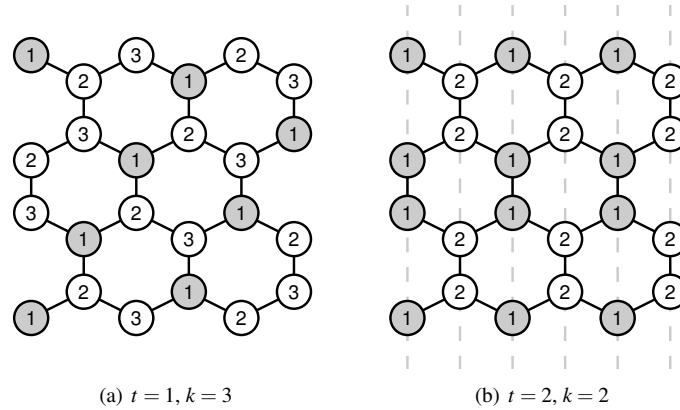

Figure 5: (a) weighted 1-improper 3-colouring of  $(\mathfrak{H}^2, w_2)$  and (b) weighted 2-improper 2-colouring of  $(\mathfrak{H}^2, w_2)$ .

*Proof.* Note first, that when  $t = 0$ , at least four colours are needed to colour the grid, because a vertex and its neighbourhood in  $\mathfrak{H}$  form a clique of size 4 in  $\mathfrak{H}^2$ . The same number of colours are needed if we allow a threshold  $t = 0.5$ . To prove this fact, let  $A$  be a vertex  $(a, b)$  of  $\mathfrak{H}$  and  $B = (a - 1, b)$ ,  $C = (a, b - 1)$  and  $D = (a + 1, b)$  be its neighbours in  $\mathfrak{H}$ . Denote by  $G = (a - 2, b)$ ,  $E = (a - 1, b - 1)$ ,  $F = (a - 2, b - 1)$ ,  $H = (a + 1, b - 1)$ ,  $I = (a + 2, b - 1)$  and  $J = (a + 1, b - 2)$  (see Figure 6(a)). By contradiction, suppose there exists a weighted 0.5-improper 3-colouring of  $\mathfrak{H}^2$ . Consider a node  $A$  coloured 1. Its neighbours  $B, C, D$  cannot be coloured 1 and they

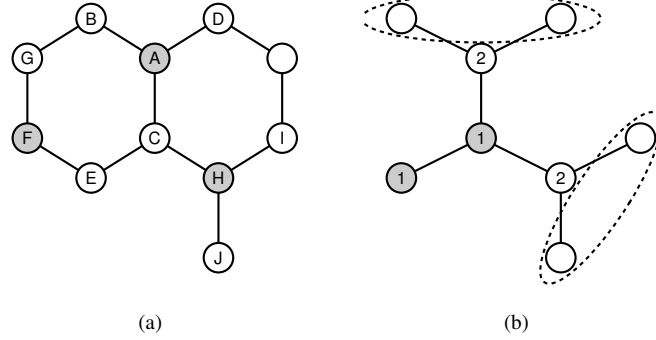

Figure 6: Lower bounds for the hexagonal grid. (a) when  $t \leq 0.5$  and  $k \leq 3$ , there is no weighted  $t$ -improper  $k$ -colouring of  $(\mathfrak{H}^2, w_2)$ ; (b) vertices coloured 2 force a vertex coloured 1 in each ellipse, leading to interference 2 in central node.

cannot all have the same colour. Without loss of generality, suppose that two of them  $B$  and  $C$  have colour 2 and  $D$  has colour 3. Then  $E$ ,  $F$  and  $G$  cannot be coloured 2 because of the interference constraint in  $B$  and  $C$ . If  $F$  is coloured 3, then  $G$  and  $E$  are coloured 1, creating interference 1 in  $A$ . So  $F$  must be coloured 1 and  $G$  and  $E$  must be coloured 3. Then,  $H$  can be neither coloured 2 (interference in  $C$ ) nor 3 (interference in  $E$ ). So  $H$  is coloured 1. The vertex  $I$  is coloured 3, otherwise the interference constraint in  $H$  or in  $C$  is not satisfied. Then,  $J$  can receive neither colour 1, because of the interference in  $H$ , nor colour 2, because of the interference in  $C$ , nor colour 3, because of the interference in  $I$ .

There exists a construction attaining this bound and the number of colours, i.e., a 0-improper 4-colouring of  $(\mathfrak{H}^2, w_2)$  as depicted in Figure 4. We define for  $0 \leq j \leq 3$  the sets of vertices  $A_j = \{(j, 0) + a(4e_1) + b(2e_1 + e_2) \mid \forall a, b \in \mathbb{Z}\}$ . We then assign the colour  $j + 1$  to the vertices in  $A_j$ . This way no vertex experiences any interference as vertices of the same colours are at distance at least three.

For  $t = 1.5$  it is not possible to colour the grid with less than three colours. By contradiction, suppose that there exists a weighted 1.5-improper 2-colouring. Consider a vertex  $A$  coloured 1. If all of its neighbours are coloured 2, they have already interference 1, so all the vertices at distance two from  $A$  need to be coloured 1; this gives interference 3 in  $A$ . Therefore one of  $A$ 's neighbours, say  $D$ , has to be coloured 1 and consider that the other two neighbours  $B$  and  $C$  are coloured 2.  $B$  and  $C$  have at most one neighbour of colour 2. It implies that  $A$  has at least two vertices at distance 2 coloured 1. This is a contradiction, because the interference in  $A$  would be 2 (see Figure 6(b)). Figure 5(a) presents a weighted 1-improper 3-colouring of  $(\mathfrak{H}^2, w_2)$ . To obtain this colouring, let  $B_j = \{(j, 0) + a(3e_1) + b(e_1 + e_2) \mid \forall a, b \in \mathbb{Z}\}$ , for  $0 \leq j \leq 2$ . Then, we colour all the vertices in the set  $B_j$  with colour  $j + 1$ , for every  $0 \leq j \leq 2$ .

For  $t < 6$ , it is not possible to colour the grid with one colour. As a matter of fact, each vertex has three neighbours and six vertices at distance two in  $\mathfrak{H}$ . Using one colour leads to an interference of 6. There exists a 2-improper 2-colouring of the hexagonal grid as depicted in Figure 5(b). We define for  $0 \leq j \leq 1$  the sets of vertices  $C_j = \{(j, 0) + a(2e_1) + be_2 \mid \forall a, b \in \mathbb{Z}\}$ . We then assign the colour  $j + 1$  to the vertices in  $C_j$ . □

### 3.2.3 Triangular Grid

The triangular grid is the graph  $\mathfrak{T}$  whose vertices are all the integer linear combinations  $af_1 + bf_2$  of the two vectors  $f_1 = (1, 0)$  and  $f_2 = (\frac{1}{2}, \frac{\sqrt{3}}{2})$ . Thus we may identify the vertices with the ordered pairs  $(a, b)$  of integers. Each vertex  $v = (a, b)$  has six neighbours: its *right neighbour*  $(a + 1, b)$ , its *right-up neighbour*  $(a, b + 1)$ , its



left-up neighbour  $(a - 1, b + 1)$ , its left neighbour  $(a - 1, b)$ , its left-down neighbour  $(a, b - 1)$  and its right-down neighbour  $(a + 1, b - 1)$  (see Figure 7(a)).

**Theorem 13.**

$$\chi_t(\mathfrak{T}^2, w_2) = \begin{cases} 7, & \text{if } t = 0; \\ 6, & \text{if } t = 0.5; \\ 5, & \text{if } t = 1; \\ 4, & \text{if } 1.5 \leq t < 3; \\ 3, & \text{if } 3 \leq t < 5; \\ 2, & \text{if } 5 \leq t < 12; \\ 1, & \text{if } 12 \leq t. \end{cases}$$

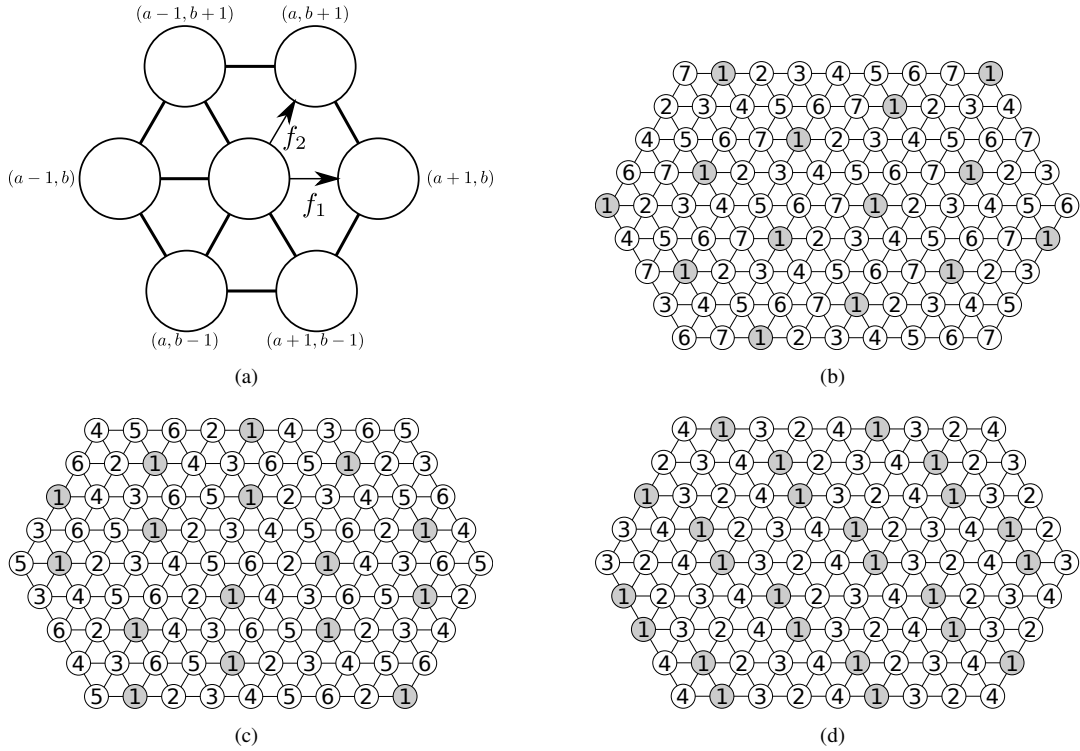

Figure 7: Optimal colourings of  $(\mathfrak{T}^2, w_2)$ : (b) weighted 0-improper 7-colouring of  $(\mathfrak{T}^2, w_2)$ , (c) weighted 0.5-improper 6-colouring of  $(\mathfrak{T}^2, w_2)$ , and (d) weighted 1.5-improper 4-colouring of  $(\mathfrak{T}^2, w_2)$

*Proof.* If  $t = 0$ , there is no weighted 0-improper 6-colouring of  $(\mathfrak{T}^2, w_2)$ , since in  $\mathfrak{T}^2$  there is a clique of size 7 induced by each vertex and its neighbourhood. There is a weighted 0-improper 7-colouring of  $(\mathfrak{T}^2, w_2)$  as depicted in Figure 7(b). This colouring can be obtained by the following construction: for  $0 \leq j \leq 6$ , let  $A_j = \{(j, 0) + a(7f_1) + b(2f_1 + f_2) \mid \forall a, b \in \mathbb{Z}\}$ . For  $0 \leq j \leq 6$ , assign the colour  $j + 1$  to all the vertices in  $A_j$ .

In what follows, we denote by  $V_0$  a vertex coloured 1; by  $N_0, N_1, N_2, N_3, N_4, N_5$  the six neighbours of  $V_0$  in  $\mathfrak{T}$  be in a cyclic order. Let  $\Gamma^2$  be the set of twelve vertices at distance 2 of  $V_0$  in  $\mathfrak{T}$ ; more precisely  $N_{i(i+1)}$  denotes the vertex of  $\Gamma^2$  adjacent to both  $N_i$  and  $N_{i+1}$  and by  $N_{ii}$  the vertex of  $\Gamma^2$  joined only to  $N_i$ , for every  $i \in \{0, \dots, 5\}$ ,  $i + 1$  is taken modulo 6 (see Figure 8).

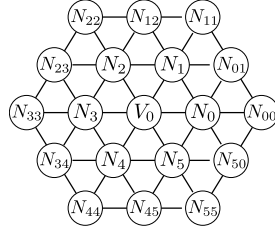

Figure 8: Notation used in proofs of non-existence of weighted improper colourings of  $(\mathfrak{T}^2, w_2)$ .

We claim that there is no weighted 0.5-improper 5-colouring of  $(\mathfrak{T}^2, w_2)$ . We prove it by contradiction, thus let  $c$  be such a colouring. No neighbour of  $V_0$  can be coloured 1, otherwise  $I_{V_0}(\mathfrak{T}^2, w_2, c) \geq 1$ . As two consecutive neighbours are adjacent, they cannot have the same colour. Furthermore, there cannot be three neighbours with the same colour (each of them will have an interference at least 1). As there are four colours different from 1, at least two of them, say 2 and 3, are repeated twice among the six neighbours. So, there exists a sequence of three consecutive neighbours the first one with a colour different from 2 and 3 and the two others coloured 2 and 3. W.l.o.g., let  $c(N_5) = 4$ ,  $c(N_0) = 2$ ,  $c(N_1) = 3$ .

Note that the vertices coloured 2 and 3 have already an interference of 0.5, and so none of their vertices at distance 2 can be coloured 2 or 3. In particular, let  $A = \{N_{50}, N_{00}, N_{01}, N_{11}, N_{12}\}$ ; the vertices of  $A$  cannot be coloured 2 or 3. At most one vertex in  $\Gamma^2$  can be coloured 1, otherwise  $I_{V_0}(\mathfrak{T}^2, w_2, c) \geq 1$ . If there is no vertex coloured 1 in  $A$ , we have a contradiction as we cannot have a sequence of five vertices uniquely coloured 4 and 5 (indeed colours should alternate and the vertex in the middle  $N_{01}$  will have interference at least 1). Suppose  $N_4$  is coloured 3, then  $N_{45}$  and  $N_{55}$  can only be coloured 1 and 5; but, as they have different colours, one is coloured 1 and so there is no vertex coloured 1 in  $A$ . So the second vertex coloured 3 in the neighbourhood of  $V_0$  is necessarily  $N_3$  (it cannot be  $N_2$  neighbour of  $N_1$  coloured 3). Then,  $N_4$  cannot be also coloured 5, otherwise  $N_{45}$  is coloured 1 and again there is no vertex coloured 1 in  $A$ . In summary  $c(N_4) = 2$ ,  $c(N_3) = 3$  and the vertex of  $\Gamma^2$  coloured 1 is in  $A$ . But then the five consecutive vertices  $A' = \{N_{23}, N_{33}, N_{34}, N_{44}, N_{45}\}$  can only be coloured 4 and 5. A contradiction as  $I_{N_{34}}(\mathfrak{T}^2, w_2, c) \geq 1$ .

A weighted 0.5-improper 6-colouring of  $(\mathfrak{T}^2, w_2)$  can be obtained by the following construction (see Figure 7(c)): for  $0 \leq j \leq 11$ , let  $B_j = \{(j, 0) + a(12f_1) + b(2f_1 + f_2) \mid \forall a, b \in \mathbb{Z}\}$ . For  $0 \leq j \leq 5$ , assign the colour  $j + 1$  to all the vertices in  $B_j$ ,  $B_6$  with colour 2,  $B_7$  with colour 1,  $B_8$  with colour 4,  $B_9$  with colour 3,  $B_{10}$  with colour 6 and  $B_{11}$  with colour 5.

Now we prove that  $(\mathfrak{T}^2, w_2)$  does not admit a weighted 1-improper 4-colouring. Again, by contradiction, suppose that there exists a weighted 1-improper 4-colouring  $c$  of  $(\mathfrak{T}^2, w_2)$ . We analyse some cases:

- 1) There exist two adjacent vertices in  $\mathfrak{T}$  with the same colour.

Let  $V_0$  and one of its neighbours be both coloured 1. Note that no other neighbour of  $V_0$ , nor the vertices at distance 2 from  $V_0$  are coloured 1 (otherwise,  $I_{V_0}(\mathfrak{T}^2, w_2, c) > 1$ ). We use intensively the following facts:

**Fact 1 ( $F_3$ ).** *There do not exist three consecutive vertices with the same colour (otherwise the vertex in the middle would have interference at least 2).*

**Fact 2 ( $F_5$ ).** *In a sequence of five consecutive vertices there cannot be four of the same colour.*

One colour other than 1 should appear at least twice. Let this colour be denoted 2 (the other colours being denoted 3 and 4).

- a) Two neighbours of  $V_0$  coloured 2 are consecutive, say  $N_0$  and  $N_1$ . By Fact  $F_3$ ,  $N_2$  is coloured 3. None of  $N_{01}$ ,  $N_{11}$ ,  $N_{12}$ ,  $N_{22}$  and  $N_{23}$  can be coloured 2, otherwise  $I_{N_1}(\mathfrak{T}^2, w_2, c) > 1$ . One of  $N_{12}$ ,  $N_{22}$  and  $N_{23}$  is coloured

- 3, otherwise we contradict Fact  $F_3$  with colour 4 and at most one of  $N_{01}, N_{11}, N_{12}, N_{22}$  and  $N_{23}$  is coloured 3, otherwise  $I_{N_2}(\mathfrak{T}^2, w_2, c) > 1$ ; but we have a contradiction with Fact  $F_5$ .
- b) Two neighbours of  $V_0$  coloured 2 are at distance 2, say  $N_0$  and  $N_2$ . Then  $N_{50}, N_{00}$  and  $N_{01}$  (respectively  $N_{12}, N_{22}$  and  $N_{23}$ ) are not coloured 2, otherwise  $I_{N_0}(\mathfrak{T}^2, w_2, c) > 1$  (respectively  $I_{N_2}(\mathfrak{T}^2, w_2, c) > 1$ ). One of  $N_3$  and  $N_5$  is not coloured 1, say  $N_3$ . It is not coloured 2,  $I_{N_3}(\mathfrak{T}^2, w_2, c) > 1$ . Let  $c(N_3) = 3$ . If  $N_4$  or  $N_{11}$  is coloured 2, then  $N_{33}$  and  $N_{34}$  are not coloured 2, otherwise  $I_{N_2}(\mathfrak{T}^2, w_2, c) > 1$  and we have a sequence of 5 vertices  $N_{12}, N_{22}, N_{23}, N_{33}$  and  $N_{34}$  contradicting Fact  $F_5$  as four are of colour 4 (indeed, at most one is coloured 3 due to interference in colour 3 with  $N_3$  or  $N_{22}$ ). So  $N_{11}$  is coloured 3 or 4. If  $N_1$  also is coloured 3 or 4, we have a contradiction with Fact  $F_5$  applied to the five vertices  $N_{00}, N_{01}, N_{11}, N_{12}$  and  $N_{22}$ , by the same previous argument. So  $c(N_1) = 1$ ; furthermore  $N_4$  is not coloured 1 (at most one neighbour coloured 1), nor 2 as we have seen above, nor 3, otherwise we are in the case (a). Therefore  $c(N_4) = 4$  and  $c(N_5) = 3$ , by the same reason. But then  $c(N_{23}) = 4$ , otherwise the interference in  $V_0$  or  $N_2$  or  $N_3$  is greater than 1.  $N_{33}$  and  $N_{34}$  can be only coloured 2, otherwise  $V_0, N_3, N_4$  or  $N_{23}$  will have interference strictly greater than 1, but  $N_{33}$  has interference greater than 1, a contradiction.
- c) Two neighbours of  $V_0$  coloured 2 are at distance 3 say  $N_0$  and  $N_3$ . Then  $N_{50}, N_{00}$  and  $N_{01}$  (respectively  $N_{23}, N_{33}$  and  $N_{34}$ ) are not coloured 2, otherwise  $I_{N_0}(\mathfrak{T}^2, w_2, c) > 1$  (respectively  $I_{N_3}(\mathfrak{T}^2, w_2, c) > 1$ ). W.l.o.g., let  $N_1$  be the vertex coloured 1. Among the four vertices  $N_{12}, N_{22}, N_{44}$  and  $N_{45}$  at most one is coloured 2, otherwise  $I_{N_3}(\mathfrak{T}^2, w_2, c) > 1$ . So, without loss of generality, we can suppose  $N_{44}$  and  $N_{45}$  are coloured 3 or 4; but we have a set of five consecutive vertices  $N_{23}, N_{33}, N_{34}, N_{44}, N_{45}$ , contradicting Fact  $F_5$  (indeed at most one can be of the colour of  $N_4$ ).
- 2) No colour appears in two adjacent vertices of  $\mathfrak{T}$ .
- Let  $V_0$  be coloured 1. No colour can appear four or more times among the neighbours, otherwise there are two neighbours with the same colour.
- a) One colour appears three times among the neighbours of  $V_0$ , say  $c(N_0) = c(N_2) = c(N_4) = 2$ . W.l.o.g., let  $c(N_1) = 3$ . No vertex at distance 2 can be coloured 2.  $N_{01}, N_{11}$  and  $N_{12}$  being neighbours of  $N_1$  cannot be coloured 3 and they cannot be all coloured 4. So one of  $N_{01}, N_{11}, N_{12}$  is coloured 1. Similarly one of  $N_{23}, N_{33}, N_{34}$  is coloured 1 (same reasoning with  $N_3$  instead of  $N_1$ ) and one of  $N_{45}, N_{55}, N_{50}$  is coloured 1, so  $I_{V_0}(\mathfrak{T}^2, w_2, c) > 1$ .
- b) The three colours appear each exactly twice in the neighbourhood of  $V_0$ .
- i) The same colour appears in some  $N_i$  and  $N_{i+2}$ ,  $i \in \{0, 1, 2, 3\}$ . W.l.o.g., let  $c(N_0) = c(N_2) = 2$  and  $c(N_1) = 3$ . Then,  $c(N_3) = c(N_5) = 4$  and  $c(N_4) = 3$ . Then,  $c(N_{50}) = 1$  or 3,  $c(N_{01}) = 1$  or 4. If  $c(N_{50}) = 3$  and  $c(N_{01}) = 4$ , then  $c(N_{00}) = 1$ . Among  $N_{50}, N_{00}, N_{01}$ , at least one has colour 1. Similarly one of  $N_{12}, N_{22}, N_{23}$  has colour 1. So  $I_{V_0}(\mathfrak{T}^2, w_2, c) \geq 1$  and  $c(N_{34}) = c(N_{45}) = 2$ . Consequently, no matter the colour of  $N_{44}$  some vertex will have interference greater than 1.
- ii) We have  $c(N_0) = c(N_3) = 2$ ,  $c(N_1) = c(N_4) = 3$  and  $c(N_2) = c(N_5) = 4$ . Here one of  $N_{50}, N_{00}, N_{01}$  has colour 1 and similarly one of  $N_{12}, N_{22}, N_{23}$  has colour 1 and one of  $N_{34}, N_{44}, N_{45}$ . Therefore  $I_{V_0}(\mathfrak{T}^2, w_2, c) > 1$ , a contradiction.

To obtain a weighted 1-improper 5-colouring of  $(\mathfrak{T}^2, w_2)$ , for  $0 \leq j \leq 4$ , let  $C_j = \{(j, 0) + a(5f_1) + b(2f_1 + f_2) \mid \forall a, b \in \mathbb{Z}\}$ . For  $0 \leq j \leq 4$ , assign the colour  $j + 1$  to all the vertices in  $C_j$ .

$(\mathfrak{T}^2, w_2)$  has a weighted 1.5-improper 4-colouring as depicted in Figure 7(d). Formally, this colouring can be obtained by the following construction: for  $0 \leq j \leq 3$ , let  $D_j = \{(j, 0) + a(4f_1) + b(f_1 + 2f_2) \mid \forall a, b \in \mathbb{Z}\}$ ; then assign colour  $D_0$  with colour 4,  $D_1$  with colour 1,  $D_2$  with colour 3 and  $D_3$  with colour 2. Now, for  $0 \leq j \leq 3$ , let  $D'_j = \{(j, 1) + a(4f_1) + b(f_1 + 2f_2) \mid \forall a, b \in \mathbb{Z}\}$ . Then, for  $0 \leq j \leq 3$ , colour  $j + 1$  to all the vertices in  $D'_j$ .

For determining the lower bounds for the cases in which  $\chi_t(\mathfrak{T}^2, w_2)$  is equal to 3, the proof involved too many subcases to be readable. Then, we used an ILP solver with the integer linear programming formulation we present

in Section 4 to validate it. We verify that the square of triangular grids with 64 vertices did not accept any weighted 2.5-improper 3-colouring.

Now we present the colouring providing the corresponding upper bound.

For a weighted 3-improper 3-colouring of  $(\mathfrak{T}^2, w_2)$  set, for  $0 \leq j \leq 2$ ,  $E_j = \{(j, 0) + a(3f_1) + b(f_2) \mid \forall a, b \in \mathbb{Z}\}$ . Then, for  $0 \leq j \leq 2$ , assign the colour  $j + 1$  to all the vertices in  $E_j$ .

Now we prove that  $(\mathfrak{T}^2, w_2)$  does not admit a weighted 4.5-improper 2-colouring. Again, by contradiction, suppose that there exists a weighted 4.5-improper 2-colouring  $c$  of  $(\mathfrak{T}^2, w_2)$  with the interference function  $w_2$ . A vertex can have at most four neighbours of the same colour as it. We analyse some cases:

- 1) There exists a vertex  $V_0$  with four of its neighbours coloured with its own colour, say 1. Therefore among the vertices of  $\Gamma^2$  at most one is coloured 1. Consider the two neighbours of  $V_0$  coloured 2. First, consider the case in which they are adjacent and let them be  $N_0$  and  $N_1$ . In  $\Gamma^2$ ,  $N_0$  has three neighbours and four vertices at distance 2; since at most one being of colour 1, these vertices produce in  $N_0$  an interference of 4 and as  $N_1$  is also of colour 2, then  $I_{N_0}(\mathfrak{T}^2, w_2, c) \geq 5$ , a contradiction. In case the two neighbours of  $V_0$  coloured 2 are non adjacent, let them be  $N_i$  and  $N_j$ . At least one of them, say  $N_i$  has its three neighbours in  $\Gamma^2$  coloured 2 and it has also at least three vertices at distance 2 in  $\Gamma^2$  coloured 2; taking into account that  $N_j$  is coloured 2 and at distance two from  $N_i$ , we get  $I_{N_i}(\mathfrak{T}^2, w_2, c) \geq 5$ , a contradiction.
- 2) No vertex has four neighbours with its colour and there exists at least one vertex  $V_0$  coloured 1 that has three neighbours of the same colour 1.
  - a) The three other neighbours of  $V_0$  coloured 2 are consecutive and let them be  $N_0, N_1$  and  $N_2$ .  $N_{34}, N_{44}$  and  $N_{45}$  are all coloured 2, otherwise  $N_4$  will have four neighbours coloured 1 and we will be in Case 1. At most one of  $N_{01}, N_{11}$  and  $N_{12}$  has colour 2, otherwise  $N_1$  will have four neighbours coloured 2 and we will be again in Case 1.
    - i)  $N_{11}$  is coloured 2. Then  $c(N_{01}) = c(N_{12}) = 1$ . As already  $I_{V_0}(\mathfrak{T}^2, w_2, c) \geq 4$ , there is at most another vertex in  $\Gamma^2$  coloured 1. So either the three vertices  $N_{22}, N_{23}$  and  $N_{33}$  or the three vertices  $N_{00}, N_{50}$  and  $N_{55}$  are all coloured 2 and then  $I_{N_2}(\mathfrak{T}^2, w_2, c) \geq 5$  or  $I_{N_5}(\mathfrak{T}^2, w_2, c) \geq 5$ , a contradiction.
    - ii)  $N_{01}$  is coloured 2 (the case  $N_{12}$  is symmetric). Then,  $c(N_{11}) = c(N_{12}) = 1$ . One of  $N_{00}$  and  $N_{50}$  is of colour 1 otherwise,  $N_0$  has four neighbours of colour 2. But then  $I_{V_0}(\mathfrak{T}^2, w_2, c) \geq 4.5$  so all the other vertices of  $\Gamma^2$  are coloured 2. Therefore,  $I_{N_2}(\mathfrak{T}^2, w_2, c) \geq 5$ , a contradiction.
    - iii)  $N_{01}, N_{11}$  and  $N_{12}$  all have colour 1. In that case  $I_{V_0}(\mathfrak{T}^2, w_2, c) \geq 4.5$ . Therefore all the other vertices of  $\Gamma^2$  are coloured 2 and  $I_{N_0}(\mathfrak{T}^2, w_2, c) \geq 4.5$ . So the other vertices at distance 2 of  $N_0$  are coloured 1 and then  $I_{N_{01}}(\mathfrak{T}^2, w_2, c) \geq 5$ , a contradiction.
  - b) Among the three vertices of colour 2, only two are consecutive. Without loss of generality, let the three vertices of colour 2 be  $N_0$  and  $N_1$  and  $N_3$ . At least one vertex of  $N_{50}, N_{00}, N_{01}$  is coloured 1, otherwise  $N_0$  has four neighbours of the same colour as it. Similarly at least one vertex of  $N_{01}, N_{11}, N_{12}$  is coloured 1, otherwise  $N_1$  has four neighbours with its colour. At least one vertex of  $N_{23}, N_{33}, N_{34}$  is coloured 1, otherwise  $N_3$  has three consecutive neighbours of the same colour as it and we are in the previous case. Suppose  $N_{01}$  is coloured 2, then  $I_{V_0}(\mathfrak{T}^2, w_2, c) \geq 4.5$  and exactly one of  $N_{50}, N_{00}$  and one of  $N_{11}, N_{12}$  is coloured 1 and  $N_{45}, N_{55}$  are coloured 2, otherwise  $I_{V_0}(\mathfrak{T}^2, w_2, c) \geq 5$ . Then  $I_{N_0}(\mathfrak{T}^2, w_2, c) \geq 5$ , a contradiction. So,  $c(N_{01}) = 1$ . If both  $N_{50}, N_{00}$  are coloured 2, then  $I_{N_0}(\mathfrak{T}^2, w_2, c) \geq 5$  with three neighbours coloured 2 and at least four vertices at distance 2 coloured 2, namely  $N_3$  and three vertices among  $N_{45}, N_{55}, N_{11}, N_{12}$  (at most one vertex of these could be of colour 1, otherwise  $I_{V_0}(\mathfrak{T}^2, w_2, c) \geq 5$ ). So, one of  $N_{50}, N_{00}$  is coloured 1 and all the other vertices in  $\{N_{11}, N_{12}, N_{22}, N_{44}, N_{45}, N_{55}\}$  are coloured 2 implying that  $I_{N_3}(\mathfrak{T}^2, w_2, c) \geq 5$ , a contradiction.
  - c) No two vertices of colour 2 are consecutive. Let these vertices be  $N_0, N_2, N_4$ . The three neighbours of  $N_0$  (resp.  $N_1, N_2$ ) in  $\Gamma^2$  cannot be all coloured 2, otherwise we are in Case (a). So exactly one neighbour of  $N_0, N_1, N_2$  in  $\Gamma^2$  is coloured 1, otherwise  $I_{V_0}(\mathfrak{T}^2, w_2, c) \geq 5$ . Furthermore all the other vertices of  $\Gamma^2$

are all coloured 2. Then, if  $c(N_{12}) = c(N_{45}) = 2$ , we conclude that  $I_{N_0}(\mathfrak{T}^2, w_2, c) \geq 5$ , a contradiction. Consequently, w.l.o.g., suppose that  $c(N_{12}) = 1$ . In this case,  $N_{23}$  has at least three neighbours coloured 2 and we are in some previous case.

- 3) No vertex has three neighbours coloured with its own colour, but there exists at least one vertex, say  $V_0$ , of colour 1 that has two neighbours coloured 1.
  - a) These two neighbours are consecutive say  $N_0$  and  $N_1$ . The neighbours of  $N_3$  and  $N_4$  in  $\Gamma^2$  are all coloured 1, otherwise they would have at least three neighbours with the same colour. Similarly, at least one of  $N_{12}$  and  $N_{22}$  is coloured 1, otherwise  $N_2$  would have at least three neighbours also coloured 2. Then,  $I_{V_0}(\mathfrak{T}^2, w_2, c) \geq 5$ , a contradiction.
  - b) These two neighbours are of the form  $N_i$  and  $N_{i+2}$ , for some  $i \in \{0, 1, 2, 3\}$ . W.l.o.g., let these neighbours be  $N_0$  and  $N_2$ . Thus, the three neighbours of  $N_4$  in  $\Gamma^2$ ,  $N_{34}$ ,  $N_{44}$  and  $N_{45}$  are coloured 1 and at least one vertex of  $N_{23}$  and  $N_{33}$  (resp.  $N_{55}$  and  $N_{50}$ ) is coloured 1. Moreover, at least one vertex of  $N_{01}$ ,  $N_{11}$  and  $N_{12}$  must be coloured 1, otherwise  $N_1$  would have three neighbours with its colour. Consequently,  $I_{V_0}(\mathfrak{T}^2, w_2, c) \geq 5$ , a contradiction.
  - c) These two neighbours are of the form  $N_i$  and  $N_{i+3}$ , for some  $i \in \{0, 1, 2\}$ . W.l.o.g., let these neighbours be  $N_0$  and  $N_3$ . Again, at least three vertices among  $N_{01}$ ,  $N_{11}$ ,  $N_{12}$ ,  $N_{22}$  and  $N_{23}$  and at least three other vertices among  $N_{34}$ ,  $N_{44}$ ,  $N_{45}$ ,  $N_{55}$  and  $N_{50}$  are coloured 1. Consequently,  $I_{V_0}(\mathfrak{T}^2, w_2, c) \geq 5$ , a contradiction.
- 4) No vertex has two neighbours of the same colour. Suppose  $V_0$  is coloured 1 and has only one neighbour  $N_0$  coloured 1. Then, its other five neighbours are coloured 2 and  $N_2$  has two neighbours of the colour 2, a contradiction.

A weighted 5-improper 2-colouring of  $(\mathfrak{T}^2, w_2)$  is obtained as follows: for  $0 \leq j \leq 1$ , let  $F_j = \{(j, 0) + a(2f_1) + b(f_1 + 2f_2) \mid \forall a, b \in \mathbb{Z}\}$  and  $F'_j = \{(j-1, 1) + a(2f_1) + b(f_1 + 2f_2) \mid \forall a, b \in \mathbb{Z}\}$ . Then, for  $0 \leq j \leq 1$ , assign the colour  $j+1$  to all the vertices in  $F_j$  and in  $F'_j$ .

Since each vertex has six neighbours and twelve vertices at distance 2 in  $\mathfrak{T}$ , there is no weighted  $t$ -improper 1-colouring of  $(\mathfrak{T}^2, w_2)$ , for any  $t < 12$ . Obviously, there is a weighted 12-improper 1-colouring of  $\mathfrak{T}^2$ .  $\square$

## 4 Integer Linear Programming Formulations, Algorithms and Results

In this section, we look at how to solve the WEIGHTED IMPROPER COLOURING and THRESHOLD IMPROPER COLOURING for realistic instances. We consider Poisson-Voronoi tessellations as they are good models of antenna networks [3, 9, 10]. We present integer linear programming models for both problems. Then, we introduce two algorithmic approaches for THRESHOLD IMPROPER COLOURING: a simple greedy heuristic and a Branch-and-Bound algorithm.

### 4.1 Integer Linear Programming Formulations and Algorithms

#### 4.1.1 Integer Linear Programming Models

Given an edge-weighted graph  $G = (V, E, w)$ ,  $w : E \rightarrow \mathbb{R}_+^*$ , and a positive real threshold  $t$ , we model WEIGHTED IMPROPER COLOURING by using two kinds of binary variables. Variable  $x_{ip}$  indicates if vertex  $i$  is coloured  $p$  and variable  $c^p$  indicates if colour  $p$  is used, for every  $1 \leq i \leq n$  and  $1 \leq p \leq l$ , where  $l$  is an upper bound for the number of colours needed in an optimal weighted  $t$ -improper colouring of  $G$  (see Section 2). The model follows:

$$\begin{array}{ll}
\min & \sum_{p \in \{1, \dots, l\}} c^p \\
\text{subject to} & \\
& \sum_{i, j \in E: j \neq i} w(i, j) x_{jp} \leq t + M(1 - x_{ip}) \quad (\forall i \in V, \forall p \in \{1, \dots, l\}) \\
& c^p \geq x_{ip} \quad (\forall i \in V, \forall p \in \{1, \dots, l\}) \\
& \sum_{p \in \{1, \dots, l\}} x_{ip} = 1 \quad (\forall i \in V) \\
& x_{ip} \in \{0, 1\} \quad (\forall i \in V, \forall p \in \{1, \dots, l\}) \\
& c^p \in \{0, 1\} \quad (\forall p \in \{1, \dots, l\})
\end{array}$$

where  $M$  is a large integer. For instance, it is sufficient to choose  $M > \sum_{(u,v) \in E} w(u, v)$ .

For THRESHOLD IMPROPER COLOURING, given an edge-weighted graph  $G = (V, E, w)$ ,  $w : E \rightarrow \mathbb{R}_+^*$ , and a positive integer  $k$ , the model we consider is:

$$\begin{array}{ll}
\min & t \\
\text{subject to} & \\
& \sum_{i, j \in E: j \neq i} w(i, j) x_{jp} \leq t + M(1 - x_{ip}) \quad (\forall i \in V, \forall p \in \{1, \dots, k\}) \\
& \sum_{p \in \{1, \dots, k\}} x_{ip} = 1 \quad (\forall i \in V) \\
& x_{ip} \in \{0, 1\} \quad (\forall i \in V, \forall p \in \{1, \dots, k\})
\end{array}$$

#### 4.1.2 Levelling Heuristic

We develop a heuristic to solve THRESHOLD IMPROPER COLOURING. The idea is to try to level the distribution of interference over the vertices. Each vertex is coloured one after the other by the colour minimising the local interference. This is achieved by considering for the nodes not yet coloured the ‘‘potential interference’’, i.e., the interference induced by the already coloured vertices.

Precisely, consider a vertex  $v$  not yet coloured and a colour  $i \in \{1, \dots, k\}$ . We define the potential interference  $I'_{v,i}$  as:

$$I'_{v,i} = \sum_{u \in N(v) \cap V_i} w(u, v),$$

where  $V_i$  is the set of vertices that have already been assigned the colour  $i$ . The order in which vertices are coloured is decided according to the total potential interference, defined as  $I''_v = \sum_{i=1}^k I'_{v,i}$ . The algorithm finds a feasible colouring in the first step and tries to improve it for  $p$  runs, where  $p$  is part of the input.

- The interference target is set  $t_t = M$ ;
- while the number of runs is smaller than  $p$ ;
  - all potential interferences are set to zero;
  - while there are still vertices to colour:
    - \* choose a vertex  $v$  randomly among the uncoloured vertices that have the maximum total potential interference;
    - \* try each colour  $i$  in the order of increasing potential interference  $I'_{v,i}$ :
      - if colouring  $v$  with  $i$  does not result in interference greater than  $t_t$  for  $v$  or any of its neighbours, colour  $v$  with  $i$ , else try a new colour;
      - if all colours resulted in excessive interferences, start new run.
- If all the vertices were successfully coloured, set  $t_t = \max_{v \in V, i \in \{1, \dots, k\}} I_v(G, w, c) - \gcd(w)$  and store the colouring as the best found.

As a *randomised greedy colouring* heuristic, it has to be run multiple times to achieve satisfactory results. This is not a practical issue due to low computational cost of each run. The local immutable colouring decision is taken in time  $O(k\Delta)$ . Then, after each such decision, the interference has to be propagated, which takes time linear in the vertex degree. This gives a computational complexity bound  $O(kn\Delta)$ -time.

### 4.1.3 Branch-and-Bound Algorithm

We also implemented a simple Branch-and-Bound algorithm inspired by the above heuristic. The first step of the algorithm is to define the order in which vertices are coloured. This order is produced by a similar procedure to the one used in the above heuristic. In order to compute this order, we start by marking a random vertex and setting it as the first in a *to colour* list. Then, as long as there are unmarked vertices, we keep choosing a random vertex  $u$  among the unmarked vertices with biggest  $\sum_{v \in N(u) \cap V_m} w(u, v)$ , where  $V_m$  is the set of already marked vertices. Then we mark  $u$  and append it to the *to order*, till we have processed all vertices.

A basic Branch-and-Bound colours vertices in the obtained order. Potential interference, as defined for the heuristic, is tracked with the additional step of decreasing the values when backing off from a colouring. Colours are tried in the order of increasing potential interference. Thanks to that it produces results similar to the heuristic in a short time. On the other hand it is guaranteed to find the optimal solution in a finite time.

In the following, we compare the performance of the ILP models with the one of the Levelling heuristic and the Branch-and-Bound algorithm .

## 4.2 Results

In this section, we look at the performances of the methods to solve the THRESHOLD IMPROPER COLOURING. We consider Delaunay graphs (dual of Voronoi diagram) for a set of random points, see Figure 9(a). This kind of graphs is a natural approximation of a network of irregular cells. The interference model is the one described in Section 3: adjacent nodes interfere by 1 and nodes at distance two interfere by  $1/2$ .

Figure 9 shows a performance comparison of the above-mentioned algorithms. For all the plots, each data point represents an average over a number (between 10 and 100) of different graphs. The same graph is used for all values of colours and time limit. Therefore Figures 9(b) and 9(c) plot how results for a given problem instance get enhanced with increasing time limits. Plots 9(e) and 9(f) show decreasing interference along increasing the number of colours allowed. Finally plot 9(d) shows how well all the programmes scale with increasing graph sizes.

One immediate observation about both the heuristic and Branch-and-Bound algorithm is that they provide solutions in relatively short time. Despite their naive implementation in a high-level programming language, they tend to find near-optimal results in matter of seconds even for graphs of thousands of vertices. On the other hand, with limited time, they fail to improve up to optimal results, especially with a low number of allowed colours. Although it is easy to envision an implementation faster by orders of magnitude, this may still give little improvement — once a near-optimal solution is found, the Branch-and-Bound algorithm does not improve for a very long time (an example near-optimal solution found in around three minutes was not improved in over six days).

ILP solvers with good Branch-and-Cut implementations do not suffer from this problem. However, they can not take advantage of any specialised knowledge of the problem, only the basic integer linear programming representation. Thus it takes much more time to produce first good results. Despite taking advantage of multi-core processing, CPLEX — ILP solver used in this work, does not scale with increasing graph sizes as well as our simple algorithms. Furthermore, Figure 9(e) reveals one problem specific to ILP solvers. When increasing the number of allowed colours, obtaining small interferences gets easier. But this introduces additional constraints in the integer linear programming formulation, thus increasing the complexity for a solver.

Above observations are valid only for the very particular case of the simple interference function and very sparse graphs. The average degree in Delaunay graph  $G$  converges to 6 (this results follows from the observation

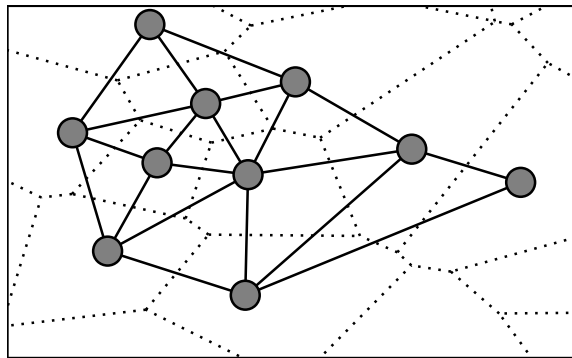

(a) Example Delaunay graph, dotted lines delimit corresponding Voronoi diagram cells

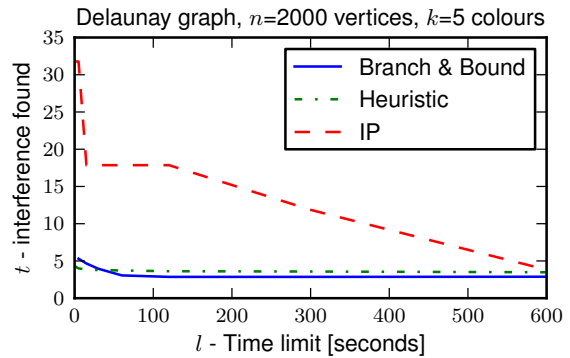

(b) Over time

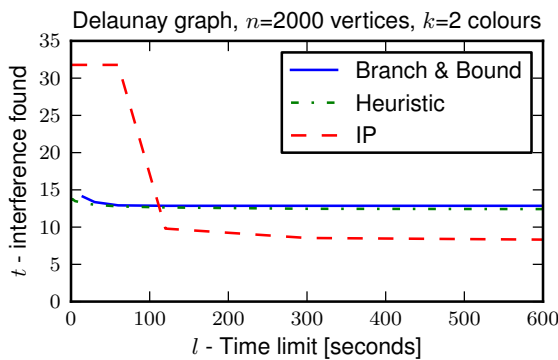

(c) Over time

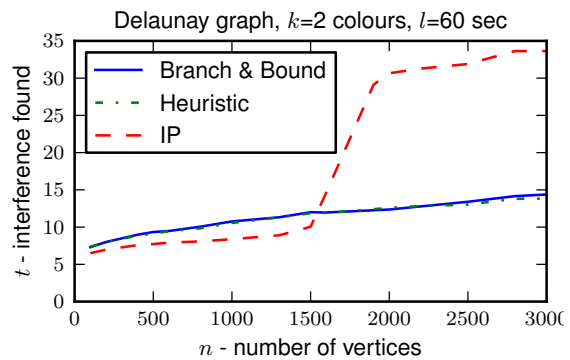

(d) Over size

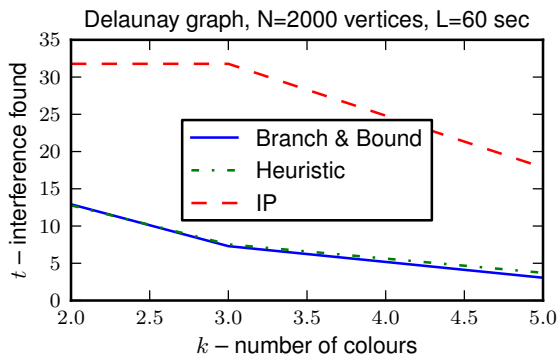

(e) Over colours

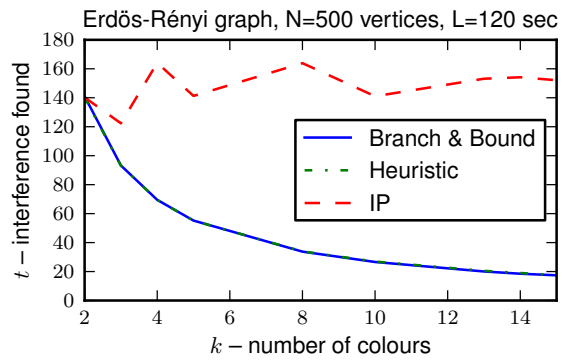

(f) Over colours

Figure 9: Results comparison for Levelling heuristic, Branch-and-Bound algorithm and Integer Linear Programming Formulation.

that  $G$  is planar and triangulated, thus  $|E(G)| = 3|V(G)| - 6$  by Euler's formula). Proposed algorithms also work quite well for denser graphs. Figure 9(f) plots interferences for different numbers of colours allowed found by the programs for an Erdős-Rényi graph with  $n=500$  and  $p=0.1$ . This gives us an average degree of 50. Both Branch-and-Bound and heuristic programs achieve acceptable, and nearly identical, results. But the large number of constraints makes the integer linear programming formulation very inefficient.



## 5 Conclusion, Open Problems and Future Directions

In this paper, we introduced and studied a new colouring problem, WEIGHTED IMPROPER COLOURING. This problem is motivated by the design of telecommunication antenna networks in which the interference between two vertices depends on different factors and can take various values. For each vertex, the sum of the interferences it receives should be less than a given threshold value.

We first give general bounds on the weighted-improper chromatic number. We then study the particular case of infinite paths, trees and grids: square, hexagonal and triangular. For these graphs, we provide their weighted-improper chromatic number for all possible values of  $t$ . Finally, we propose a heuristic and a Branch-and-Bound algorithm to find good solutions of the problem. We compare their results with the one of an integer linear programming formulation on cell-like networks, Poisson-Voronoi tessellations.

Many problems remain to be solved:

- For the study of the grid graphs, we considered a specific function where vertex at distance one interfere by 1 and vertices at distance 2 by  $1/2$ . Other weight functions should be considered. e.g.  $1/d^2$  or  $1/(2^{d-1})$ , where  $d$  is the distance between vertices.
- Other families of graphs could be considered, for example hypercubes.
- Let  $G = (V, E, w)$  be an edge-weighted graph where the weights are all equal to 1 or  $M$ . Let  $G_M$  be the subgraph of  $G$  induced by the edges of weight  $M$ ; is it true that if  $\Delta(G_M) \ll \Delta(G)$ , then  $\chi_t(G, w) \leq \chi_t(G) \leq \left\lceil \frac{\Delta(G, w) + 1}{t + 1} \right\rceil$ ? A similar result for  $L(p, 1)$ -labelling [11] suggests it could be true.

## References

- [1] K.I. Aardal, S.P.M. van Hoesel, A.M.C.A. Koster, C. Mannino, and A. Sassano. Models and solution techniques for frequency assignment problems. *Annals of Operations Research*, 153(1):79–129, 2007.
- [2] S. Alouf, E. Altman, J. Galtier, J.F. Lalande, and C. Touati. Quasi-optimal bandwidth allocation for multi-spot MFTDMA satellites. In *INFOCOM 2005. 24th Annual Joint Conference of the IEEE Computer and Communications Societies. Proceedings IEEE*, volume 1, pages 560–571. IEEE, 2005.
- [3] F. Baccelli, M. Klein, M. Lebourges, and S. Zuyev. Stochastic geometry and architecture of communication networks. *Telecom. Systems*, 7(1):209–227, 1997.
- [4] R. L. Brooks. On colouring the nodes of a network. *Mathematical Proceedings of the Cambridge Philosophical Society*, 37(02):194–197, 1941.
- [5] R. Correa, F. Havet, and J-S. Sereni. About a Brooks-type theorem for improper colouring. *Australasian Journal of Combinatorics*, 43:219–230, 2009.
- [6] L. J. Cowen, R. H. Cowen, and D. R. Woodall. Defective colorings of graphs in surfaces: Partitions into subgraphs of bounded valency. *Journal of Graph Theory*, 10(2):187–195, 1986.
- [7] L.J. Cowen, W. Goddard, and C.E. Jesurum. Defective coloring revisited. *J. Graph Theory*, 24:205–219, 1995.
- [8] M. Fischetti, C. Lepschy, G. Minerva, G. Romanin-Jacur, and E. Toto. Frequency assignment in mobile radio systems using branch-and-cut techniques. *European Journal of Operational Research*, 123(2):241–255, 2000.

- 
- [9] P. Gupta and P.R. Kumar. The capacity of wireless networks. *Information Theory, IEEE Transactions on*, 46(2):388–404, 2000.
- [10] M. Haenggi, J.G. Andrews, F. Baccelli, O. Dousse, and M. Franceschetti. Stochastic geometry and random graphs for the analysis and design of wireless networks. *Selected Areas in Communications, IEEE Journal on*, 27(7):1029–1046, 2009.
- [11] Frédéric Havet, Bruce Reed, and Jean-Sébastien Sereni. L(2,1)-labelling of graphs. In *Proceedings of the nineteenth annual ACM-SIAM symposium on Discrete algorithms*, SODA '08, pages 621–630, Philadelphia, PA, USA, 2008. Society for Industrial and Applied Mathematics.
- [12] R. Karp. Reducibility among combinatorial problems. In R. Miller and J. Thatcher, editors, *Complexity of Computer Computations*, pages 85–103. Plenum Press, 1972.
- [13] L. Lovász. On decompositions of graphs. *Studia Sci. Math. Hungar.*, 1:273–238, 1966.
- [14] C. Mannino and A. Sassano. An enumerative algorithm for the frequency assignment problem. *Discrete Applied Mathematics*, 129(1):155–169, 2003.
- [15] D. R. Woodall. Improper colorings of graphs. In R. Nelson and R. J. Wilson, editors, *Pitman Res. Notes Math. Ser.*, volume 218, pages 45–63. Longman Scientific and Technical, 1990.
- [16] Roger K. Yeh. A survey on labeling graphs with a condition at distance two. *Discrete Mathematics*, 306(12):1217 – 1231, 2006.



---

Centre de recherche INRIA Sophia Antipolis – Méditerranée  
2004, route des Lucioles - BP 93 - 06902 Sophia Antipolis Cedex (France)

Centre de recherche INRIA Bordeaux – Sud Ouest : Domaine Universitaire - 351, cours de la Libération - 33405 Talence Cedex  
Centre de recherche INRIA Grenoble – Rhône-Alpes : 655, avenue de l'Europe - 38334 Montbonnot Saint-Ismier  
Centre de recherche INRIA Lille – Nord Europe : Parc Scientifique de la Haute Borne - 40, avenue Halley - 59650 Villeneuve d'Ascq  
Centre de recherche INRIA Nancy – Grand Est : LORIA, Technopôle de Nancy-Brabois - Campus scientifique  
615, rue du Jardin Botanique - BP 101 - 54602 Villers-lès-Nancy Cedex  
Centre de recherche INRIA Paris – Rocquencourt : Domaine de Voluceau - Rocquencourt - BP 105 - 78153 Le Chesnay Cedex  
Centre de recherche INRIA Rennes – Bretagne Atlantique : IRISA, Campus universitaire de Beaulieu - 35042 Rennes Cedex  
Centre de recherche INRIA Saclay – Île-de-France : Parc Orsay Université - ZAC des Vignes : 4, rue Jacques Monod - 91893 Orsay Cedex

---

Éditeur  
INRIA - Domaine de Voluceau - Rocquencourt, BP 105 - 78153 Le Chesnay Cedex (France)  
<http://www.inria.fr>  
ISSN 0249-6399