



**HAL**  
open science

# Minimum-fuel trajectories for a hypersonic passenger aircraft under a temperature restriction for the thermal protection system

Hans-Josef Pesch

► **To cite this version:**

Hans-Josef Pesch. Minimum-fuel trajectories for a hypersonic passenger aircraft under a temperature restriction for the thermal protection system. SADCO A2CO, Mar 2011, Paris, France. inria-00582978

**HAL Id: inria-00582978**

**<https://inria.hal.science/inria-00582978v1>**

Submitted on 4 Apr 2011

**HAL** is a multi-disciplinary open access archive for the deposit and dissemination of scientific research documents, whether they are published or not. The documents may come from teaching and research institutions in France or abroad, or from public or private research centers.

L'archive ouverte pluridisciplinaire **HAL**, est destinée au dépôt et à la diffusion de documents scientifiques de niveau recherche, publiés ou non, émanant des établissements d'enseignement et de recherche français ou étrangers, des laboratoires publics ou privés.



# **Minimum-fuel trajectories for a hypersonic passenger aircraft under a temperature restriction for the thermal protection system**

**Hans Josef Pesch**

**University of Bayreuth, Germany**

**Hyper Aircraft: Kurt Chudej, Markus Wächter,  
Gottfried Sachs, Florent le Bras**

**Hyper Car: Armin Rund, Wolf von Wahl & Stefan Wendl**

**Workshop on Aerospace Applications of Control and Optimization  
Kick-off Meeting of the Initial Training Network SADCO,  
Paris, France, March. 2-4, 2011**

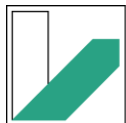

**UNIVERSITÄT  
BAYREUTH**

**Lehrstuhl  
Ingenieur-  
mathematik**



- **Introduction/Motivation**
- **The hypersonic trajectory optimization problem**
- **The instationary heat constraint**
- **Numerical results**
  
- **The hypersonic rocket car problems**
- **Theoretical results**
- **New necessary conditions**
- **Numerical results**
  
- **Conclusion**



- **Introduction/Motivation**

- The hypersonic trajectory optimization problem
- The instationary heat constraint
- Numerical results

- The hypersonic rocket car problems
- Theoretical results
- New necessary conditions
- Numerical results

- **Conclusion**

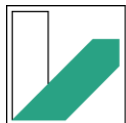

# Introduction: Supersonic Aircraft



Concorde

first flight: March 21, 1969 (Charger, Korolkov) 1976; 20 planes  
first flight: Mach 2.03 (2400 km/h, 8100 ft altitude) 1975; 16 planes  
Mach 2.35 (2500 km/h, 8300 ft altitude)

Crash after take-off: July 25, 2000,  
Paris, Charles de Gaule



UNIVERSITÄT  
BAYREUTH

Lehrstuhl  
Ingenieur-  
mathematik



From Times Online  
February 5, 2008

## **Hypersonic jet could offer day trips Down Under**

**Day trips to Australia came a step closer to reality today when a British firm unveiled plans for a hypersonic passenger jet which could fly from Europe to Sydney in less than five hours.**

**Reaction Engines of Oxfordshire says that its A2 plane could be in service within 25 years, carrying 300 passengers at a top speed of almost 4,000 mph, five times the speed of sound and twice the speed of Concorde.**

**The jet may be more environmentally friendly than other planes because it uses liquid hydrogen for power rather than fossil fuel.**

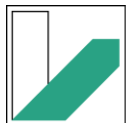

# Introduction: Hypersonic Passenger Jets



[http://www.reactionengines.co.uk/lapcat\\_anim.html](http://www.reactionengines.co.uk/lapcat_anim.html)



UNIVERSITÄT  
BAYREUTH

Project LAPCAT  
Reading Engines, UK

Lehrstuhl  
Ingenieur-  
mathematik



# Motivation: Hypersonic Passenger Jets

quasilinear PDEs  
non-linear boundary conditions  
coupled with ODE

PDE

ODE

$$T \leq T_{\max}$$



UNIVERSITÄT  
BAYREUTH

Project LAPCAT  
Reading Engines, UK

Lehrstuhl  
Ingenieur-  
mathematik





- Introduction/Motivation
- **The hypersonic trajectory optimization problem**
- The instationary heat constraint
- Numerical results
  
- The hypersonic rocket car problems
- Theoretical results
- New necessary conditions
- Numerical results
  
- Conclusion



# Introduction: The German Sanger II Project



Collaborative Research Center,  
Munich: 1989 - 2003

air-breathing  
**turbojet** - ramjet / scramjet

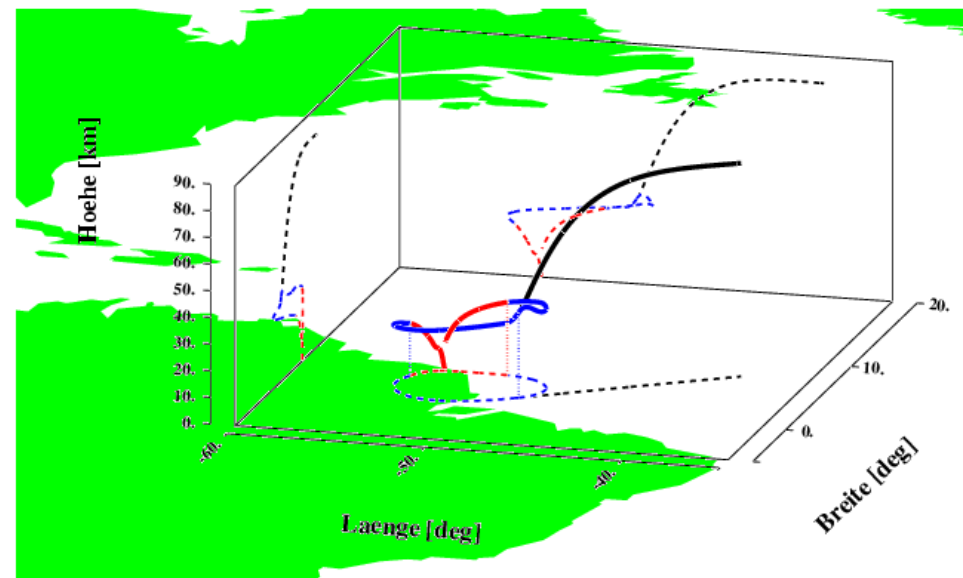

Chudej: 1989; Schnepfer: 1999

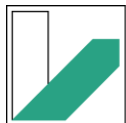

UNIVERSITAT  
BAYREUTH

Lehrstuhl  
Ingenieur-  
mathematik



# Model: Atmosphere

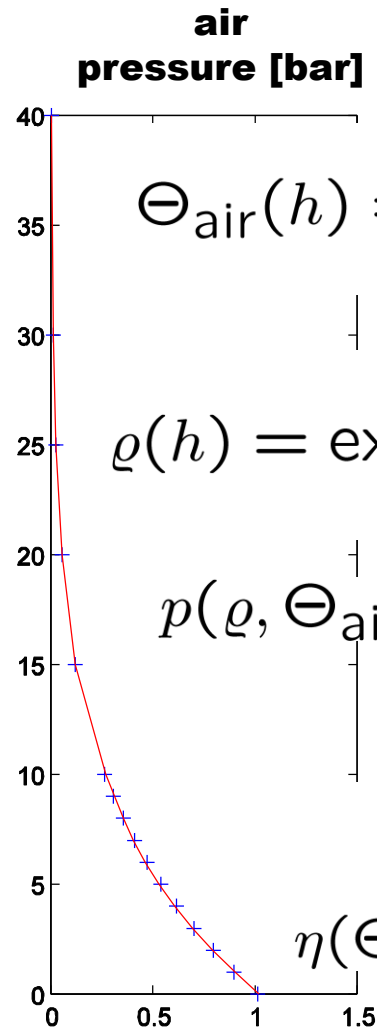
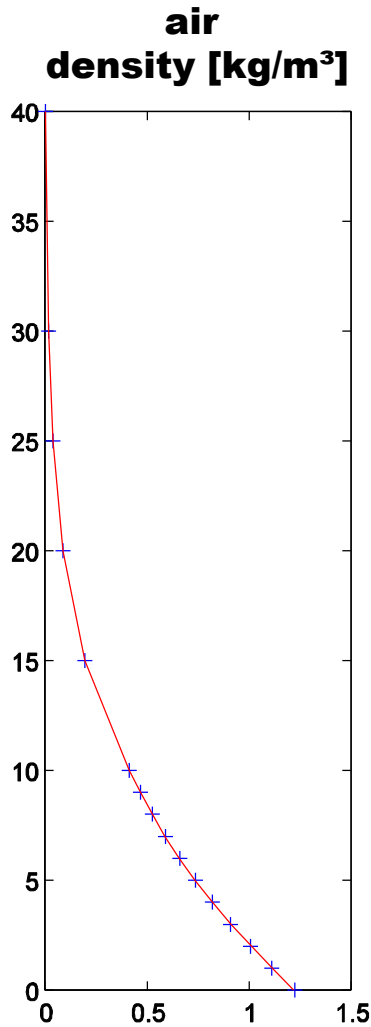
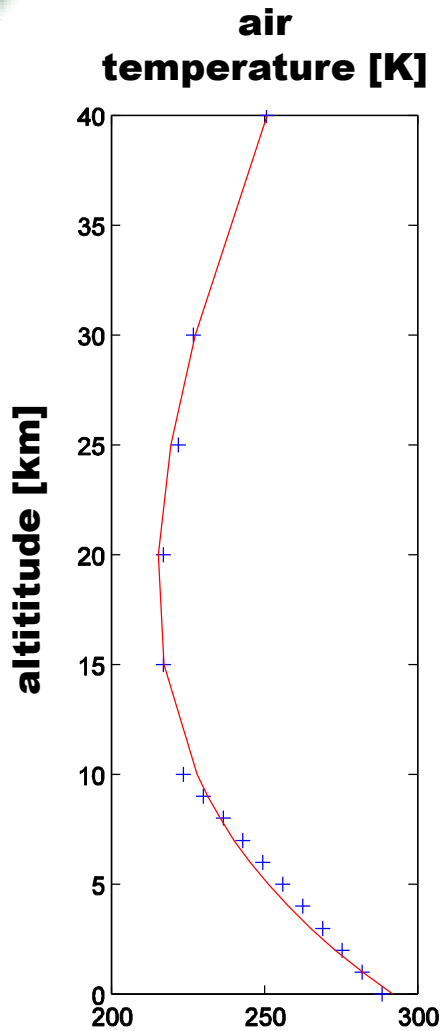

$$\Theta_{\text{air}}(h) = \Theta_0 \sum_{i=0}^5 c_i h^i$$

$$\rho(h) = \exp\left(\frac{\sum_{i=0}^5 a_i h^i}{\sum_{j=0}^3 b_j h^j}\right)$$

$$p(\rho, \Theta_{\text{air}}) = \rho R \Theta_{\text{air}}$$

↓

$$a(h) \quad s(\Theta_{\text{air}})$$

$$\eta(\Theta_{\text{air}}) \quad Pr(\Theta_{\text{air}}, p)$$



## Heat conductivity

$$\lambda(\Theta_{\text{air}}, p) = \begin{cases} \sum_{i=0}^3 g_i \Theta_{\text{air}}^i & \text{if } \Theta_{\text{air}} \leq 1400 \\ \xi_1 \sum_{i=0}^3 g_i \Theta_{\text{air}}^i + \xi_2 P_\lambda(\Theta_{\text{air}}, p) & \text{if } 1400 < \Theta_{\text{air}} < 1600 \\ P_\lambda(\Theta_{\text{air}}, p) & \text{if } 1600 \leq \Theta_{\text{air}} \end{cases}$$

## Heat capacity

$$c_p(\Theta_{\text{air}}) = R \frac{\kappa}{\kappa - 1} \quad \text{with} \quad \kappa = \frac{\sum_{i=0}^5 d_i \Theta_{\text{air}}^i}{\sum_{j=0}^1 e_j \Theta_{\text{air}}^j}$$

$\Theta_{\text{air}}$ : air temperature



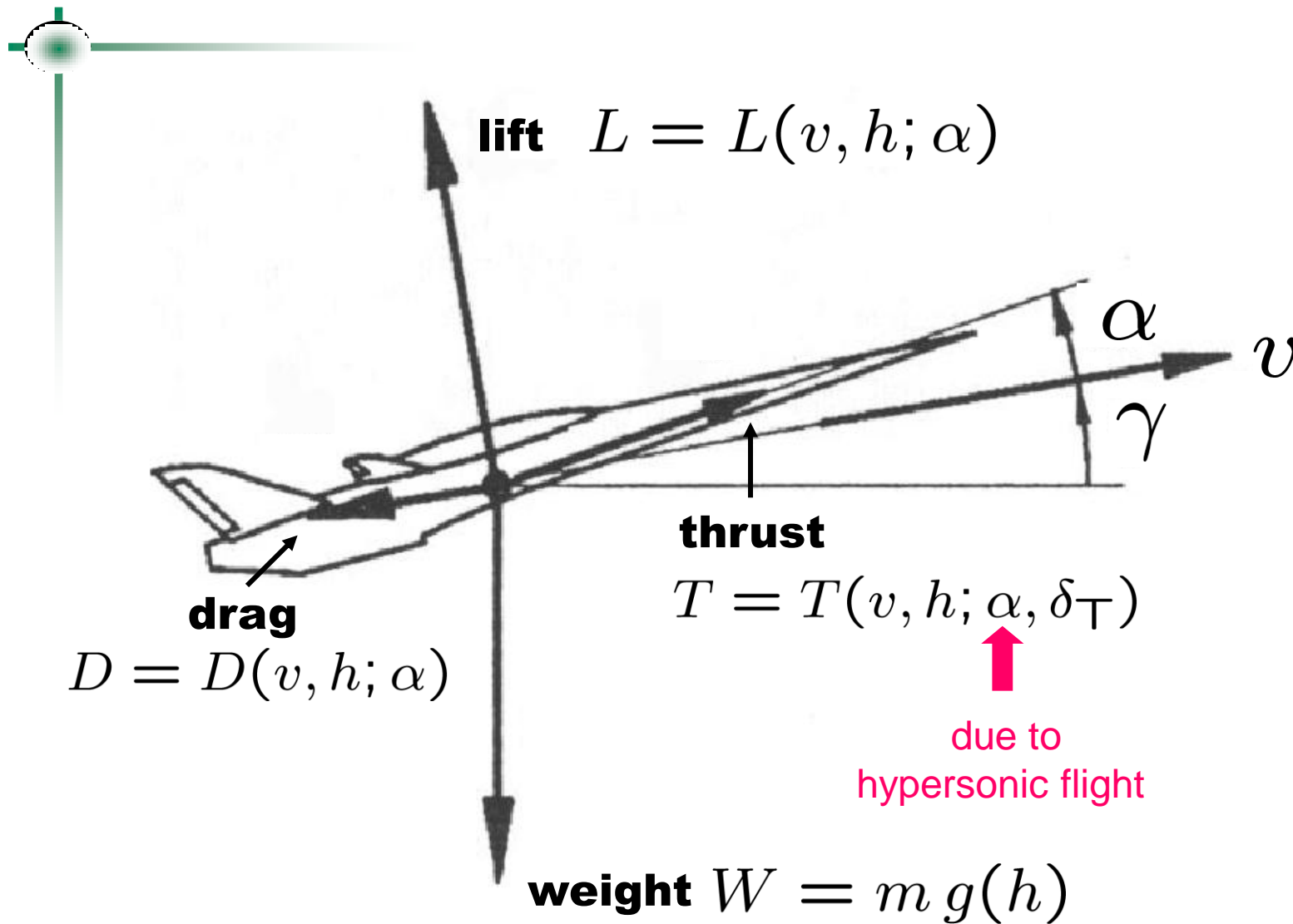

## Two-dimensional flight over a great circle of a rotational Earth

$$\dot{v} = \frac{1}{m} \left[ T(v, h; \alpha, \delta_T) \cos(\alpha + \sigma_T) - D(v, h; \alpha) \right] - g(h) \sin \gamma + \omega_E^2 r(h) \sin \gamma$$

$$\dot{\gamma} = \frac{1}{m v} \left[ T(v, h; \alpha, \delta_T) \sin(\alpha + \sigma_T) + L(v, h; \alpha) \right] + \cos \gamma \left[ \frac{v}{r(h)} - \frac{g(h)}{v} + \frac{\omega_E^2 r(h)}{v} \right] + 2 \omega_E$$

$$\dot{h} = v \sin \gamma$$

$$\dot{\zeta} = v \cos \gamma$$

$$\dot{m} = -\beta_T(v, h; \alpha, \delta_T) \quad \text{or} \quad \dot{m} = -\max \{ \beta_C(v, h; \alpha, \delta_T), \beta_I(v, h; \alpha, \delta_T) \}$$

homotopy parameter  $0 \leq \epsilon \leq 1$



instantaneous  
fuel consumption  
for thrust



instantaneous  
fuel consumption  
for active cooling



# Model: Dynamics: Boundary Conditions

	$v$ [m/s]	$\gamma$ [rad]	$h$ [m]	$\zeta$ [km]	$m$ [to]
$t = 0$	150	0	500	0	244
$t_f$ free	150	0	500	9 000	—

Houston – Rome: 9163 km = 5693 m  
Munich – Houston: 8714 km = 5414 m



## Objective function

$$\max_{\alpha, \delta_T} m(t_f)$$

## Constraints

$$-1.5^\circ \leq \alpha \leq 20^\circ \qquad 0 \leq \delta_T \leq 1$$

angle of attack : box constraints : throttle setting

$$0 \leq n(v, h, m; \alpha) \leq 2 \qquad 10 \leq \bar{q}(v, h) \leq 50 \text{ [kPa]}$$

control-state constr.: load factor

state constr.: dynamic pressure





# Model: Active Engine Cooling

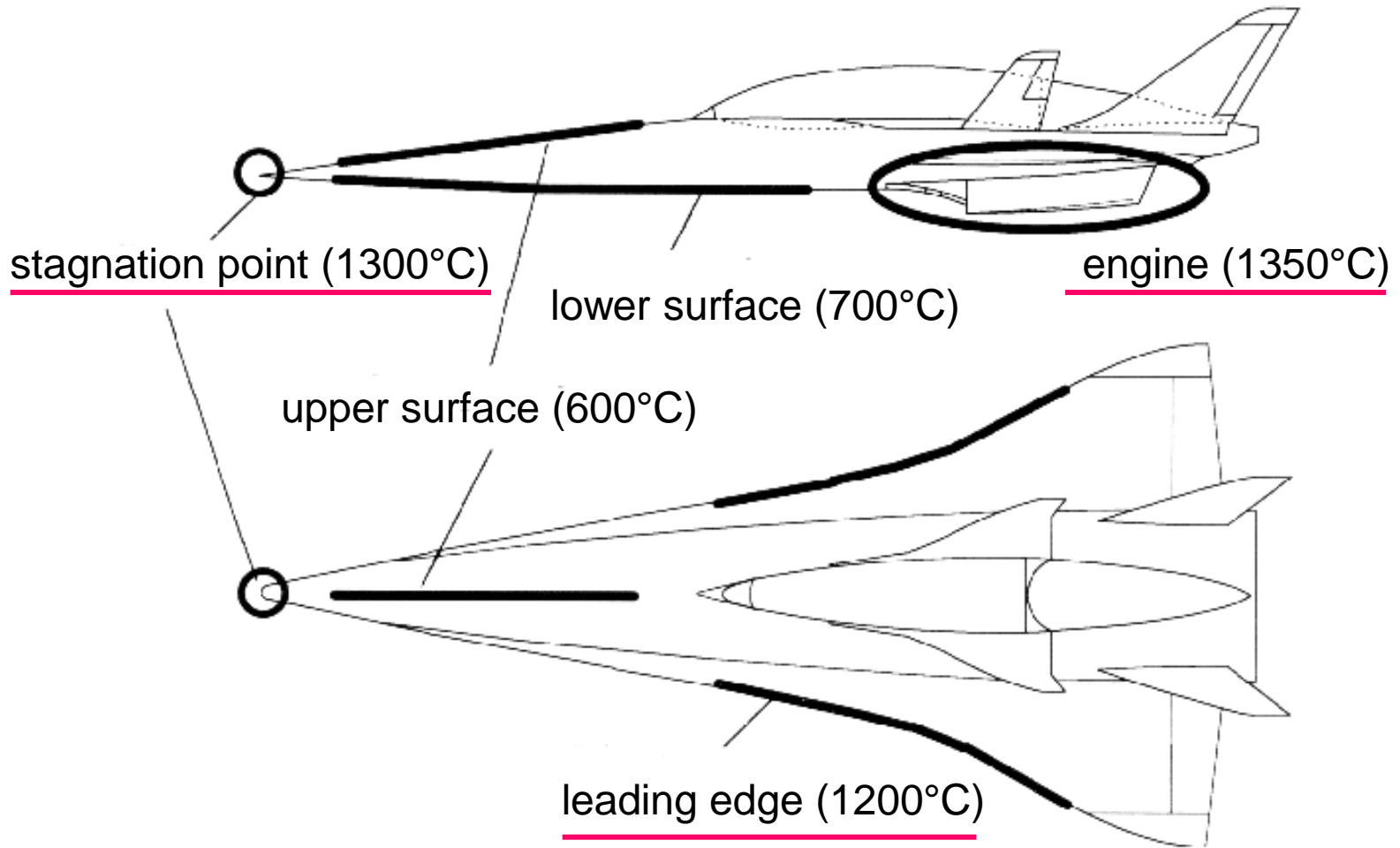

# Model: Active Engine Cooling

$$\beta_C = \sum_{i=0}^8 \beta_i(v, h; \alpha; Re, \phi)$$

instantaneous  
fuel consumption  
for cooling

instantaneous  
fuel consumption  
for thrust

$$\dot{m} = -\beta_T(v, h; \alpha, \delta_T)$$

$$\beta_C \leq \beta_T$$

control-state constraint  
fuel is reused  
for thrust

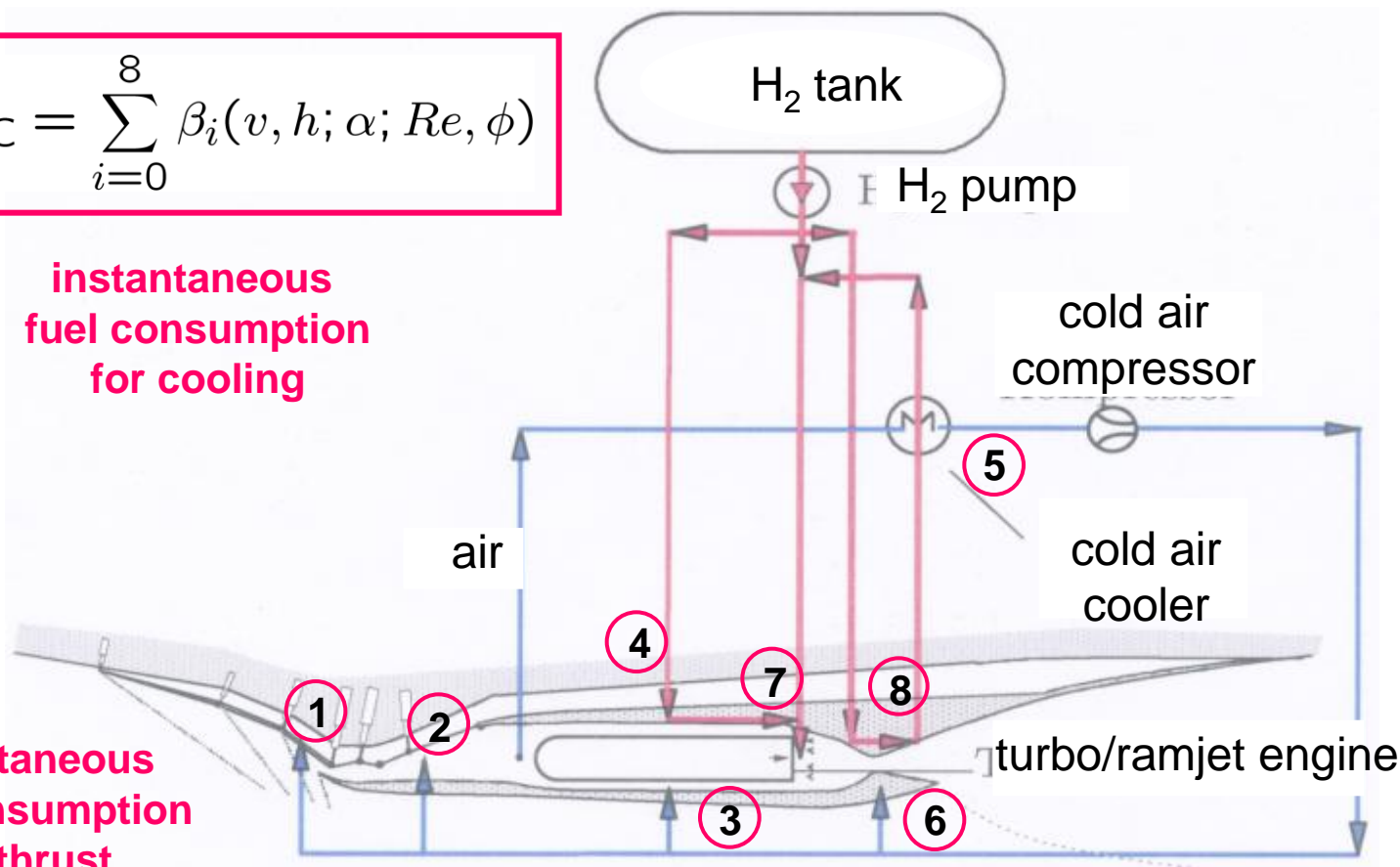

# Numerical Results: State Variables



### velocity [m/s]

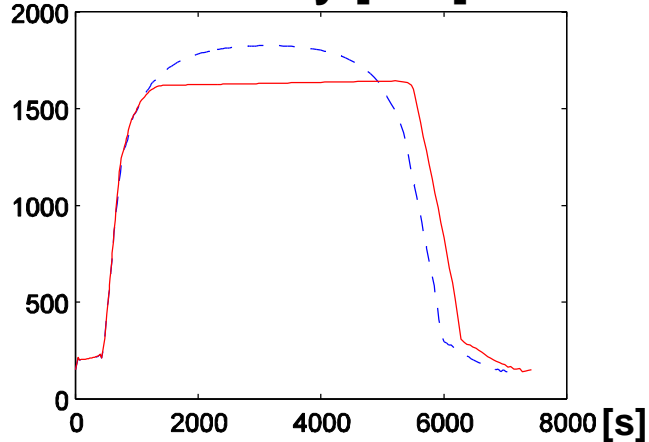

### altitude [10,000 m]

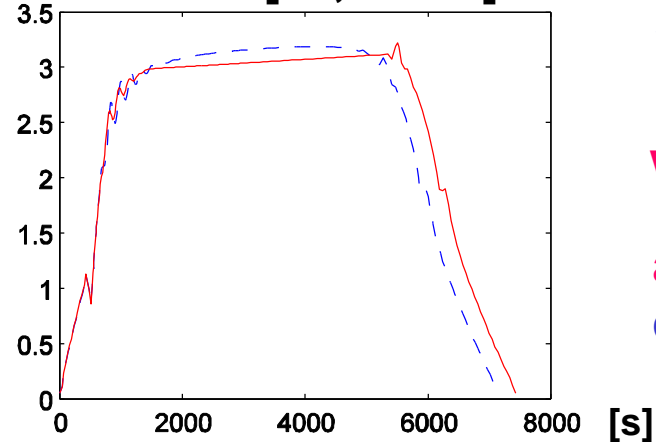

without  
with  
active  
cooling

### path length [1,000 km]

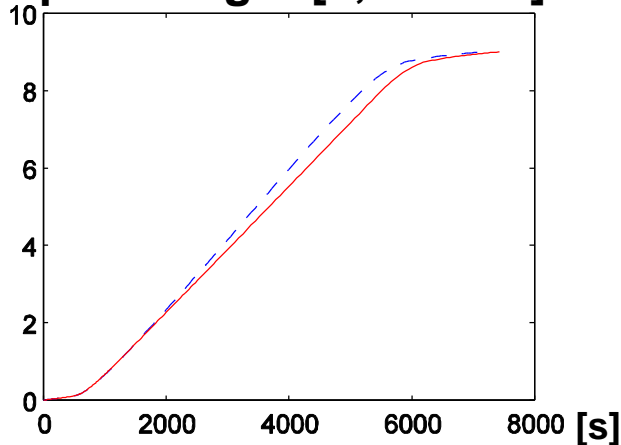

### mass [100,000 kg]

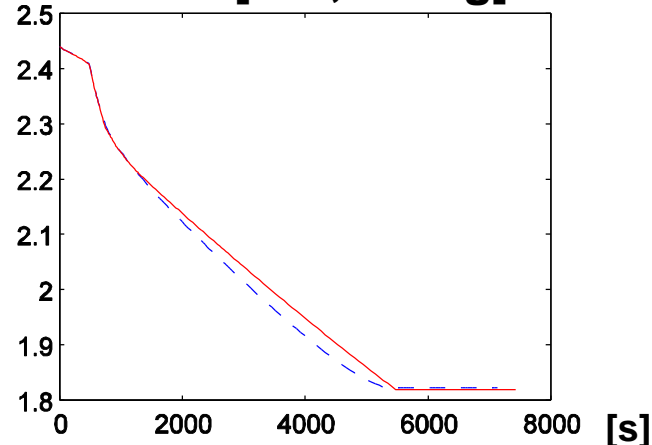

UNIVERSITÄT  
BAYREUTH

Markus Wächter, Kurt Chudej  
Florent Le Bras

Lehrstuhl  
Ingenieur-  
mathematik



# Numerical Results: Control Variables

angle of attack [deg]

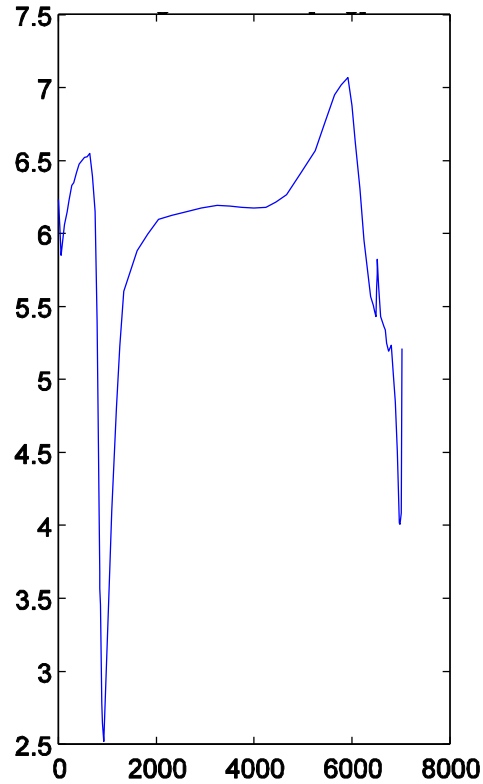

throttle setting

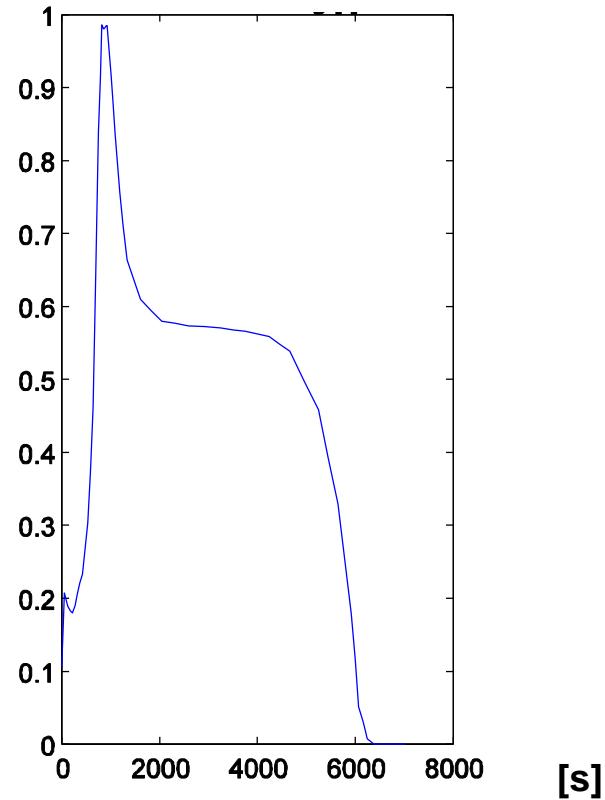

$t_f: 7\,023 \text{ [s]} \implies 7\,500 \text{ [s]}$



- Introduction/Motivation
- The hypersonic trajectory optimization problem
- **The instationary heat constraint**
- Numerical results
  
- The hypersonic rocket car problems
- Theoretical results
- New necessary conditions
- Numerical results
  
- Conclusion
- Appendix: more applications

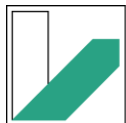

# Model: Instationary Heat Constraint: Thermal Protection System

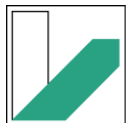
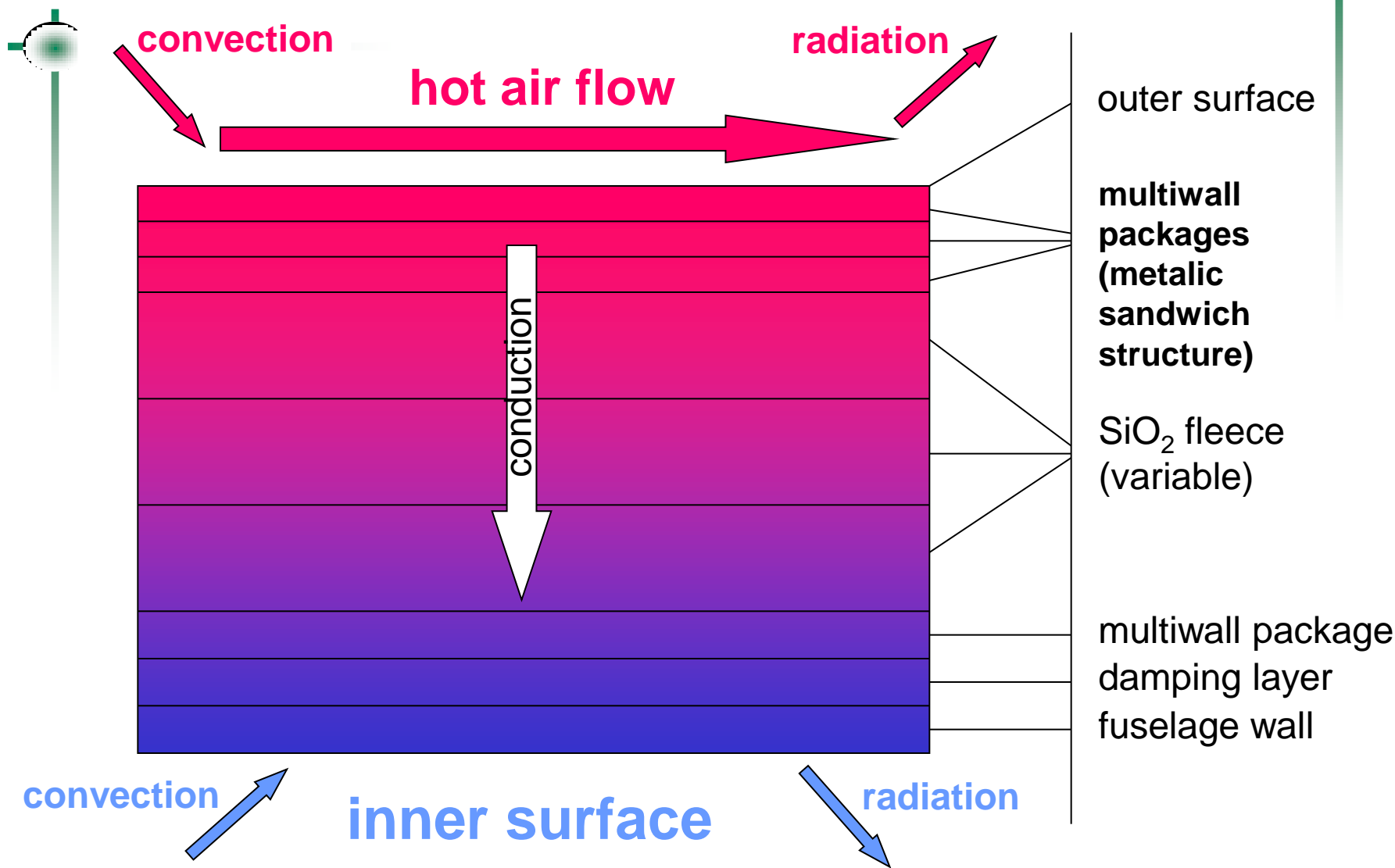

affine linear functions

$$\rho_{\text{TPS}} c_p(\Theta) \frac{\partial \Theta}{\partial t} - \vec{\nabla} \cdot [\lambda(\Theta) \vec{\nabla} \Theta] = 0$$

in  $(\vec{x}, t) \in \Omega \times (0, t_f)$

$$\Theta(\vec{x}, 0) = \Theta_0(\vec{x}) = 300 \text{ [K]} \quad \text{in } \vec{x} \in \Omega$$

nonlinear boundary conditions

$$\frac{\partial \Theta}{\partial \vec{n}}(\vec{x}, t) = q_{\text{conv}}(v, h, \alpha) - q_{\text{rad}}(\Theta, \Theta_{\text{air}}(h))$$

in  $(\vec{x}, t) \in \partial\Omega \times (0, t_f)$

**quasi-linear parabolic initial-boundary value problem  
with nonlinear boundary conditions**



# Model: Instationary Heat Constraint: Boundary Conditions (1)

$$\frac{\partial \Theta}{\partial \vec{n}}(\vec{x}, t) = q_{\text{conv}} - q_{\text{rad}} \quad \text{in} \quad (\vec{x}, t) \in \partial\Omega \times (0, t_f)$$

$$q_{\text{conv}} = q_{\text{air}}(v, h, \Theta_{\text{air}}(h); \alpha; x_L, Q) \quad q_{\text{rad}} = \varepsilon \sigma (\Theta^4 - \Theta_{\text{air}}^4(h))$$

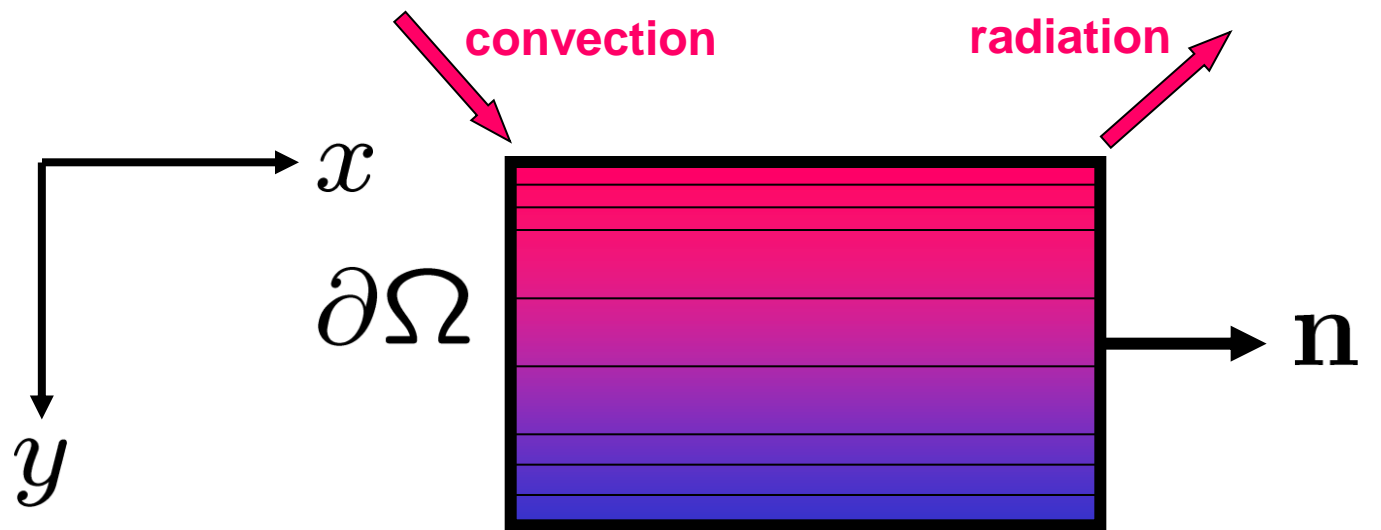

$$q_{\text{conv}} = \alpha_q(\Theta_{\text{int}}) (\Theta - \Theta_{\text{int}})$$

$$q_{\text{rad}} = \varepsilon \sigma (\Theta^4 - \Theta_{\text{int}}^4)$$





**State-constraint for the temperature:**

$$\Theta(\vec{x}, t) \leq \Theta_{\max}(\vec{x}, t) \quad \text{for all} \quad (\vec{x}, t) \in \Omega \times (0, t_f)$$

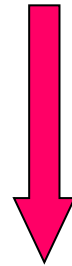

**ODE-PDE state-constrained optimal control problem**

**PDE:** quasilinear parabolic with nonlinear bound. conds.

**CONTROL:** boundary controls indirectly  
via ODE states and controls

**CONSTRAINT:** state constraint

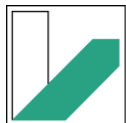

**State-constraint for the temperature:**

$$\Theta(\vec{x}, t) \leq \Theta_{\max}(\vec{x}, t) \quad \text{for all} \quad (\vec{x}, t) \in \Omega \times (0, t_f)$$

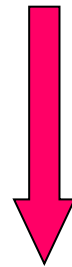

$$\begin{aligned} \tilde{\Omega} &\subset \Omega \\ [t_{\text{in}}, t_{\text{out}}] \end{aligned}$$

**ODE-PDE state-constrained optimal control problem**



- Introduction/Motivation
- The hypersonic trajectory optimization problem
- The instationary heat constraint
- **Numerical results**
- The hypersonic rocket car problems
- Theoretical results
- New necessary conditions
- Numerical results
- Conclusion



# Numerical Method: Semi-Discretization in Space

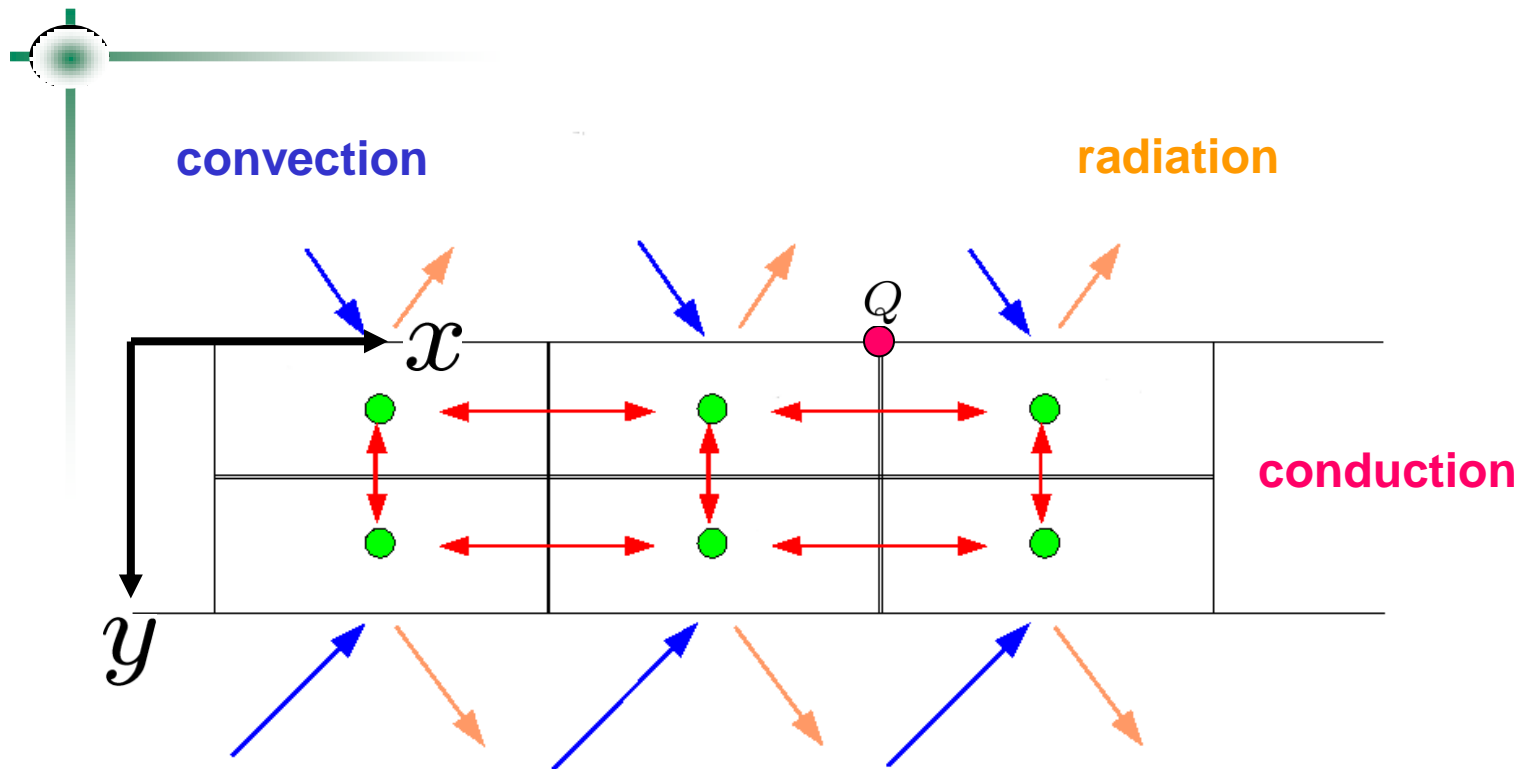

**Finite Volume Method: locally and globally conservative  
second order convergent**



# Numerical Method: Semi-Discretization in Space

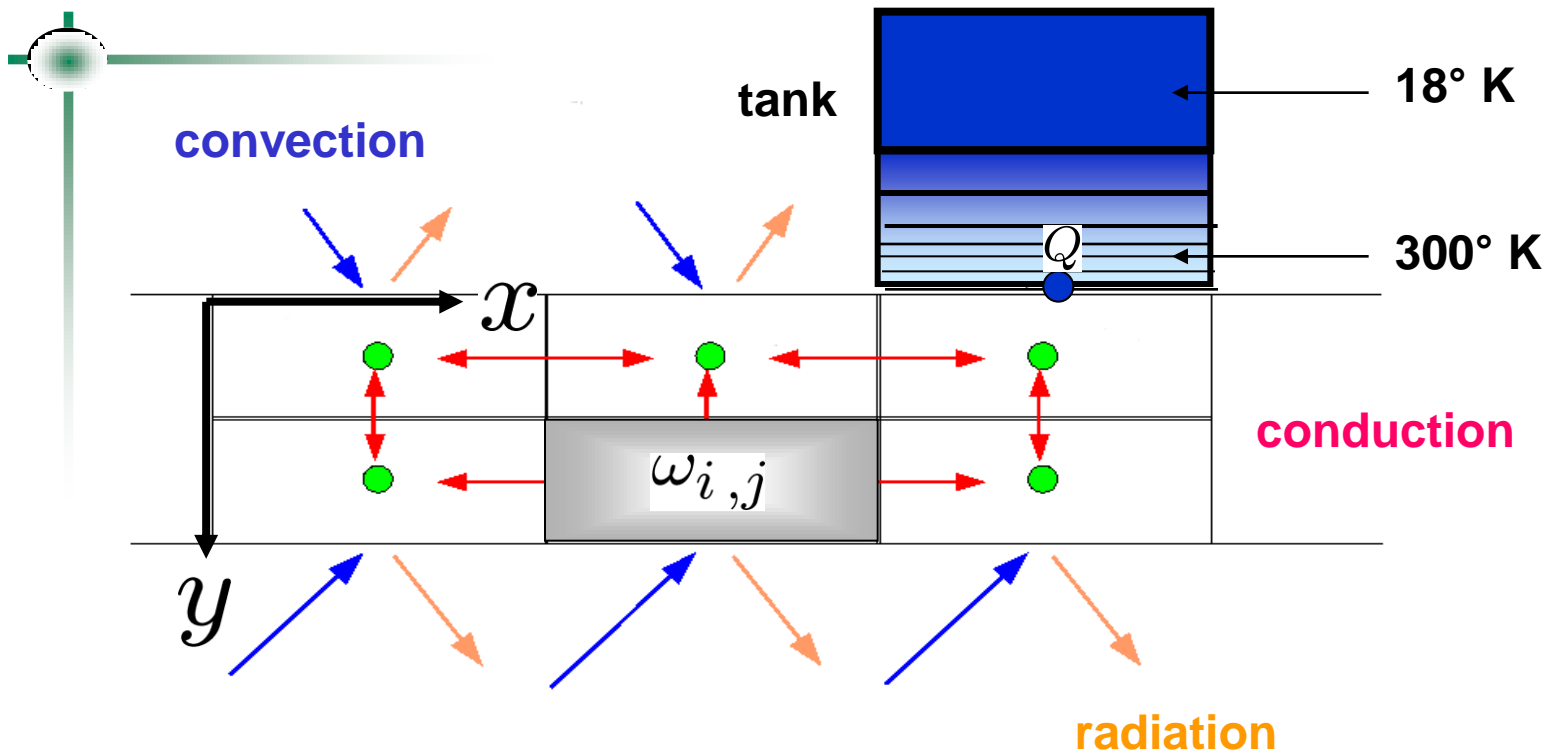

conservation law in each volume

$\omega_{i,j}$

$$\frac{d}{dt} \int_{\omega_{i,j}} \dots d\vec{x} = - \int_{\partial\omega_{i,j}} \dots d\vec{s}$$

second order  
convergent  
FVM



$$\rho_{\text{TPS}} c_p(\Theta) \frac{\partial \Theta}{\partial t} - \vec{\nabla} \circ [\lambda(\Theta) \vec{\nabla} \Theta] = 0$$

$$\rho_{\text{TPS}} c_p(\Theta_i) \dot{\Theta}_i$$

$$-\frac{1}{\Delta x} \left[ \lambda \left( \frac{\Theta_{i-1} + \Theta_i}{2} \right) \frac{\Theta_{i-1} - \Theta_i}{\Delta x} - \lambda \left( \frac{\Theta_i + \Theta_{i+1}}{2} \right) \frac{\Theta_i - \Theta_{i+1}}{\Delta x} \right] = 0$$

1D case

$$\Theta_i := \Theta(x_i, t)$$

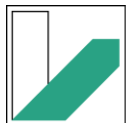

$$\rho_{\text{TPS}} c_p(\Theta_i) \dot{\Theta}_i$$

$$-\frac{1}{\Delta x} \left[ \lambda \left( \frac{\Theta_{i-1} + \Theta_i}{2} \right) \frac{\Theta_{i-1} - \Theta_i}{\Delta x} - \lambda \left( \frac{\Theta_i + \Theta_{i+1}}{2} \right) \frac{\Theta_i - \Theta_{i+1}}{\Delta x} \right] = 0$$

$i = 1$ : **b.c. towards air**

↑  
**coupled with ODE.**

**b.c. towards interior**:  $i = n - 1$

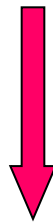

**large scale multiply constrained ODE optimal control problem**



UNIVERSITÄT  
BAYREUTH

DIRCOL (O. v. Stryk) with SNOPT (P. Gill)  
alternatively: NUOCCCS (C. Büskens)  
IPOPT (A. Wächter) with AMPL  
WORHP (Büskens, Gerdt)

Lehrstuhl  
Ingenieur-  
mathematik



# Numerical Results: Stagnation Point (1D)

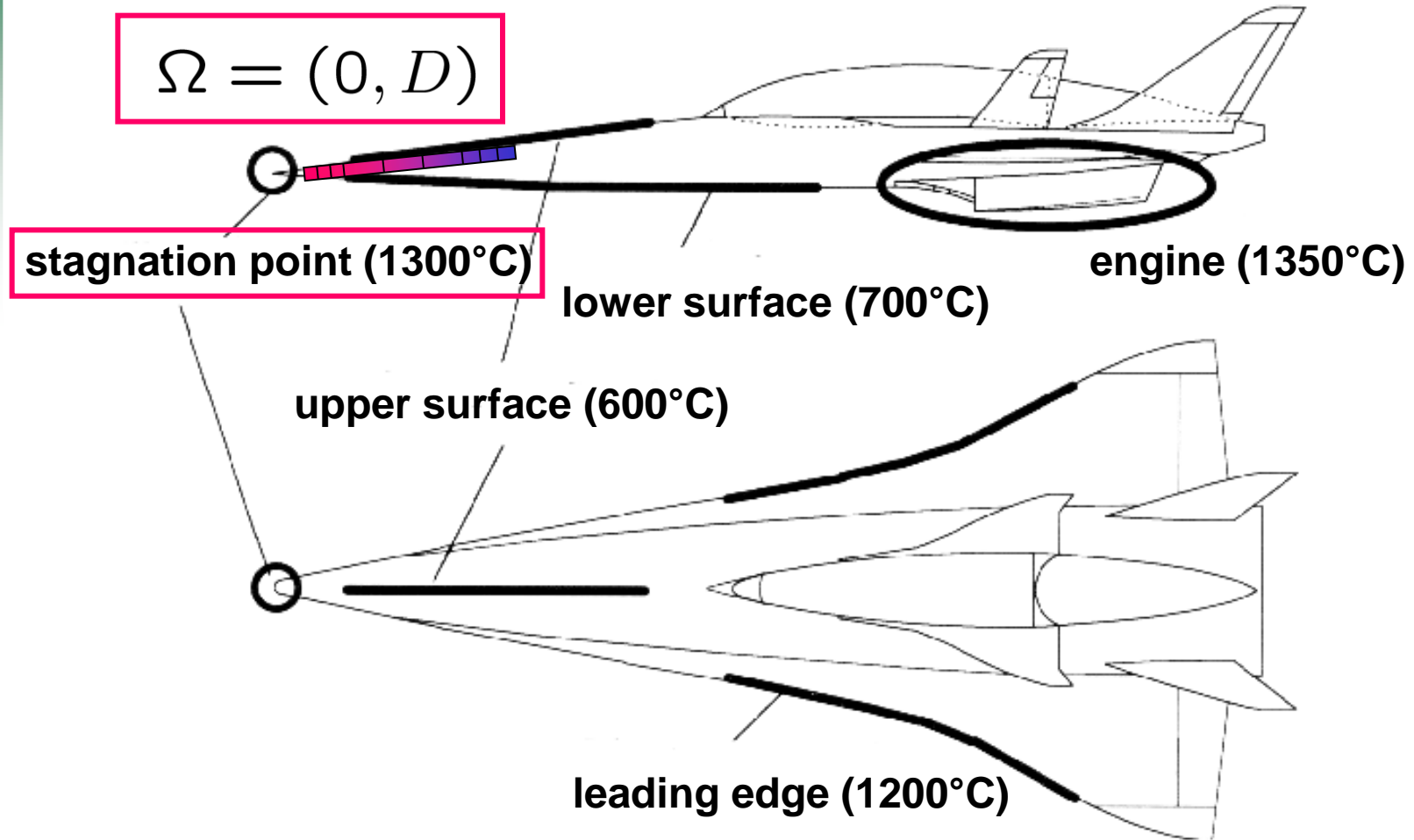



# Numerical Results: Stagnation Point: States, Heat Loads

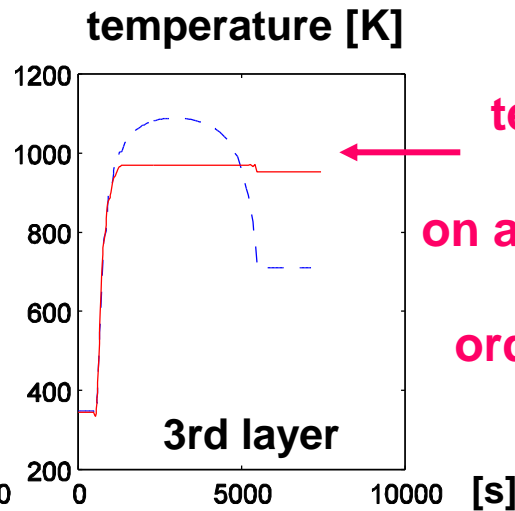
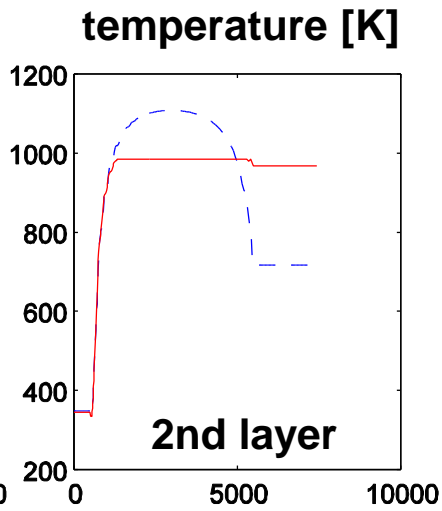
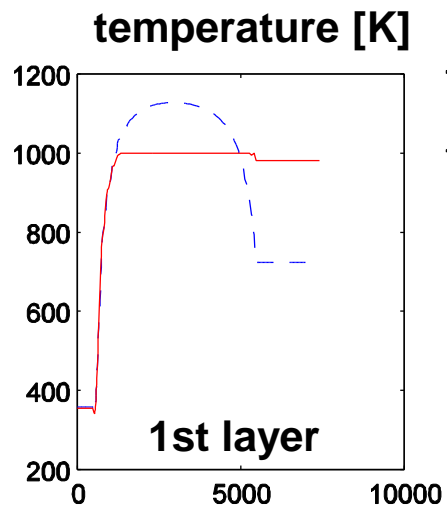
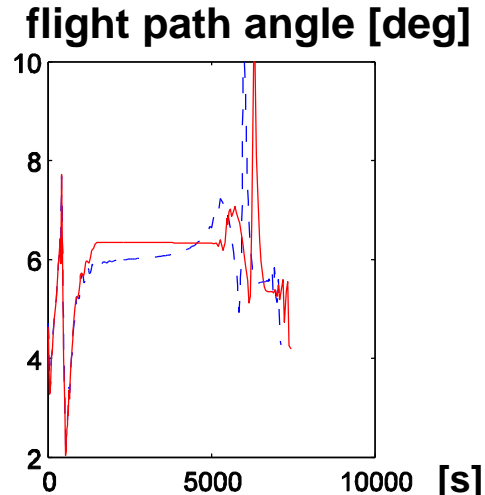
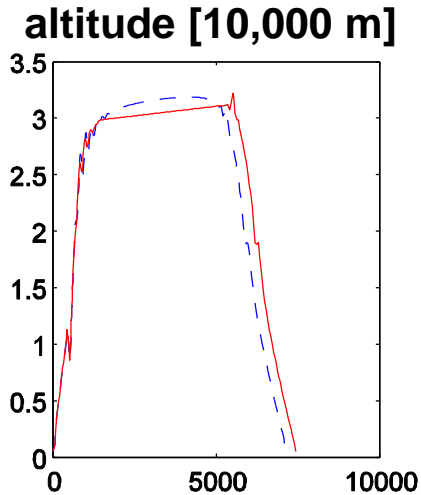
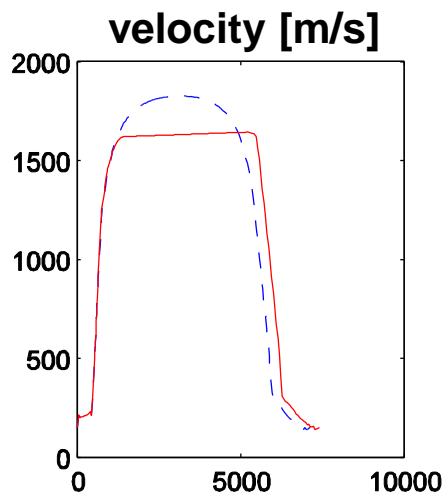
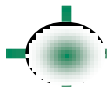

**limit  
temperature  
1000 K  
on a boundary arc  
order concept?**



- Introduction/Motivation
- The hypersonic trajectory optimization problem
- The instationary heat constraint
- Numerical results
- **The hypersonic rocket car problems**
- Theoretical results
- New necessary conditions
- Numerical results
- Conclusion

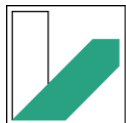

have nothing to do with the supersonic

## Bloodhound-SSC-Projekt

1997, Oct. 15: Thrust SSC  
officially 1.228 km/h  
less than  $Ma\ 1 = 1.234,8\text{ km/h}$   
at  $20^\circ\text{C}$

Aim: 1.000 m/h,  
hence 1.609 km/h,  
faster than a speeding bullet.

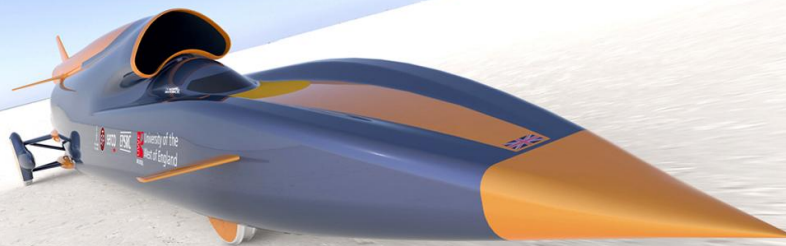

**we are going with *hypersonic* speed**

BLOODHOUND SSC by CURVENTA



UNIVERSITÄT  
BAYREUTH

<http://www.bloodhoundssc.com/>

Lehrstuhl  
Ingenieur-  
mathematik



$$\min_{u \in U} \left\{ t_f + \frac{1}{2} \lambda \int_0^{t_f} u^2 dt \right\}, \quad \lambda \geq 0$$

minimum time    control costs

subject to

$$\ddot{w}(t) = u(t) \quad \text{in } (0, t_f)$$

$$w(0) = w_0, \quad \dot{w}(0) = \dot{w}_0$$

$$w(t_f) = 0, \quad \dot{w}(t_f) = 0$$

$$U := \left\{ u \in L^2(0, t_f) : |u(t)| \leq u_{\max} \text{ a. e. in } [0, t_f] \right\}$$

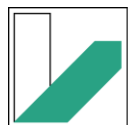

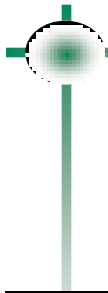

## Problem 1

$$\frac{\partial T}{\partial t}(x, t) - \frac{\partial^2 T}{\partial x^2}(x, t) = g(\dot{w}(t))$$

**friction term**  
**control via ODE state**

in  $(0, l) \times (0, t_f)$

$$T(x, 0) = T_0 = 0 \text{ on } (0, l)$$

$$-\frac{\partial T}{\partial x}(0, t) = -(T(0, t) - T_0)$$

$$\frac{\partial T}{\partial x}(l, t) = -(T(l, t) - T_0) \text{ on } [0, t_f]$$

**instationary heating of the entire vehicle**



$$\frac{\partial T}{\partial t}(x, t) - \frac{\partial^2 T}{\partial x^2}(x, t) = 0$$

## Problem 2

$$\text{in } (0, l) \times (0, t_f),$$

$$T(x, 0) = T_0 = 0 \text{ on } (0, l),$$

$$-\frac{\partial T}{\partial x}(0, t) = -(T(0, t) - T_0),$$

$$\frac{\partial T}{\partial x}(l, t) = -(T(l, t) - T_0) + h(\dot{w}(t)) \text{ on } [0, t_f]$$

Transformation  
to homogeneous  
Robin type b.c.

friction term  
control via  
ODE state

instationary heating at the stagnation point



# The State Constraint

$$T(x, t) \leq T_{\max} \text{ a. e. in } (0, l) \times (0, t_f)$$

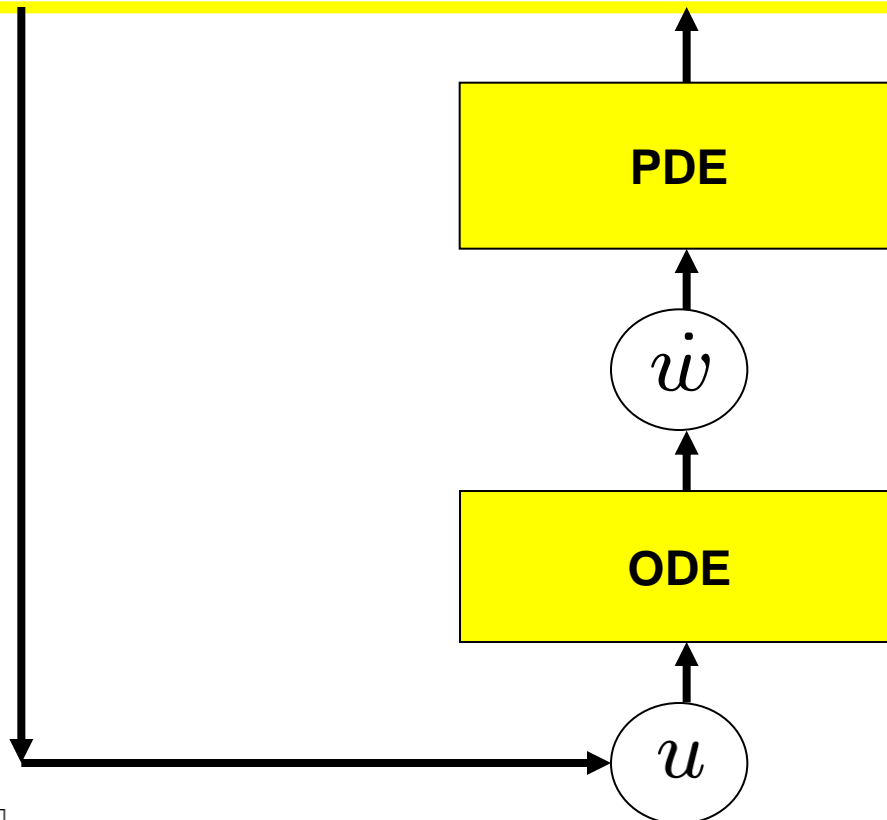

The state constraint  
regenerates  
the PDE with the ODE



# The Optimal Trajectories (Non-regularized, Minimum Time)

## Problem 1

$$\min_{u \in U} \left\{ t_f + \frac{1}{2} \lambda \int_0^{t_f} u^2 dt \right\}, \quad \lambda = 0, \quad u_{\max} = 1$$

$$g(\dot{w}) = \dot{w}^2$$

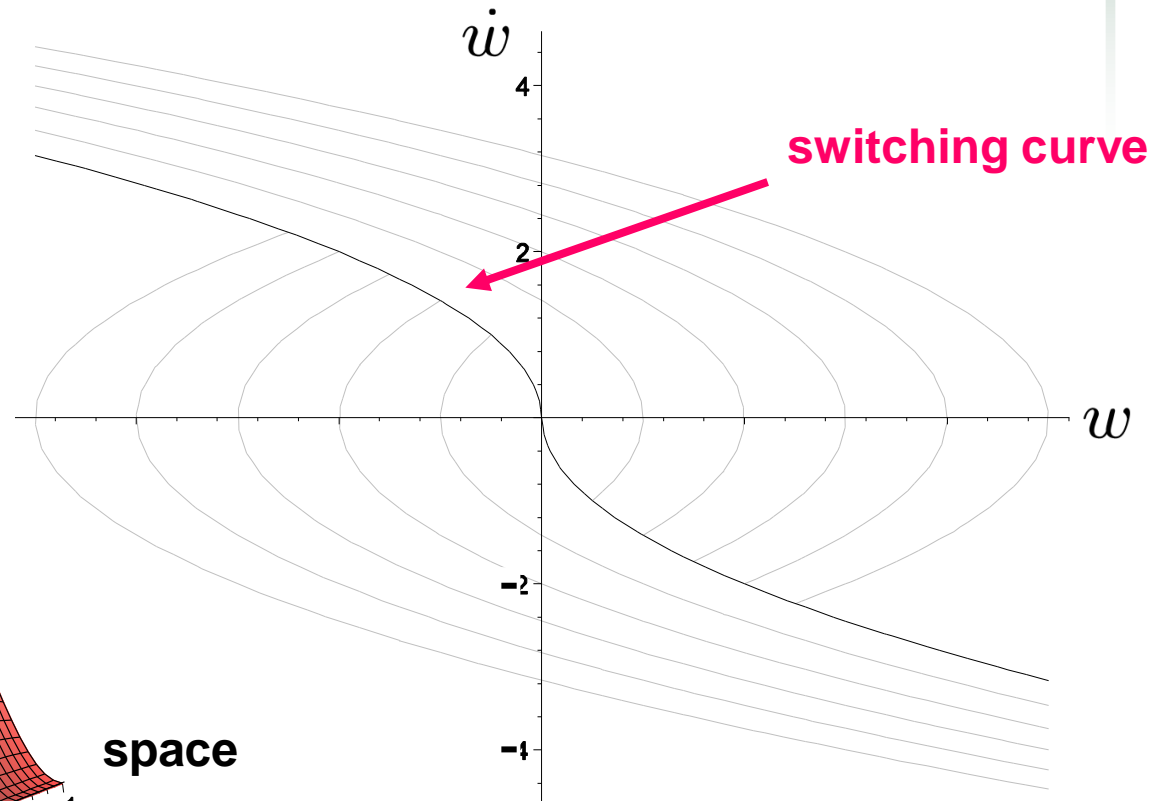
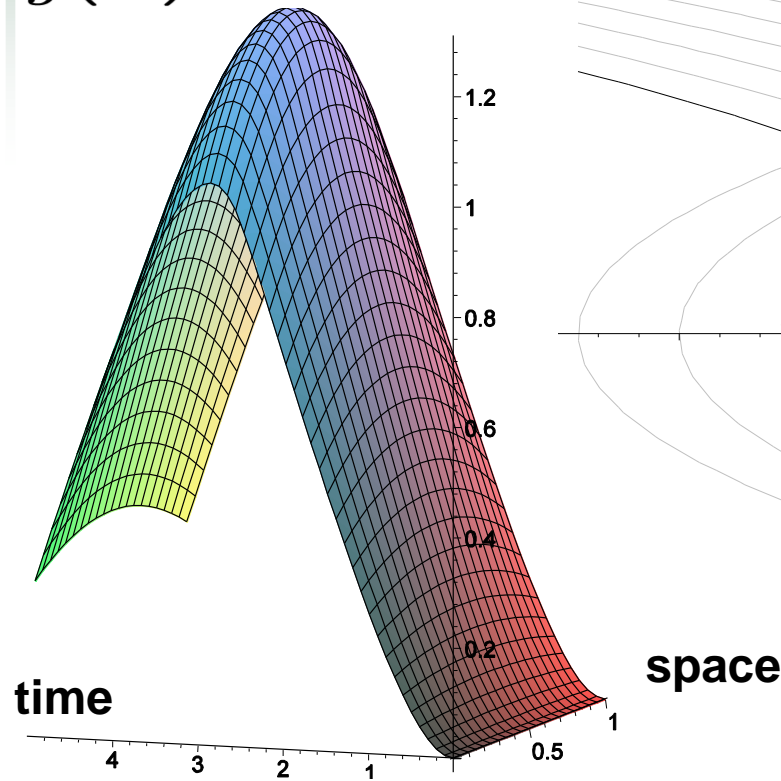

**distributed case**  
**state unconstrained**



UNIVERSITÄT  
BAYREUTH

Lehrstuhl  
Ingenieur-  
mathematik





# The Optimal Trajectories (Regularized, Control Constrained)

## Problem 1

$$\min_{u \in U} \left\{ t_f + \frac{1}{2} \lambda \int_0^{t_f} u^2 dt \right\}, \quad \lambda = \frac{1}{10}, \quad u_{\max} = 1$$

$$g(\dot{w}) = \dot{w}^2$$

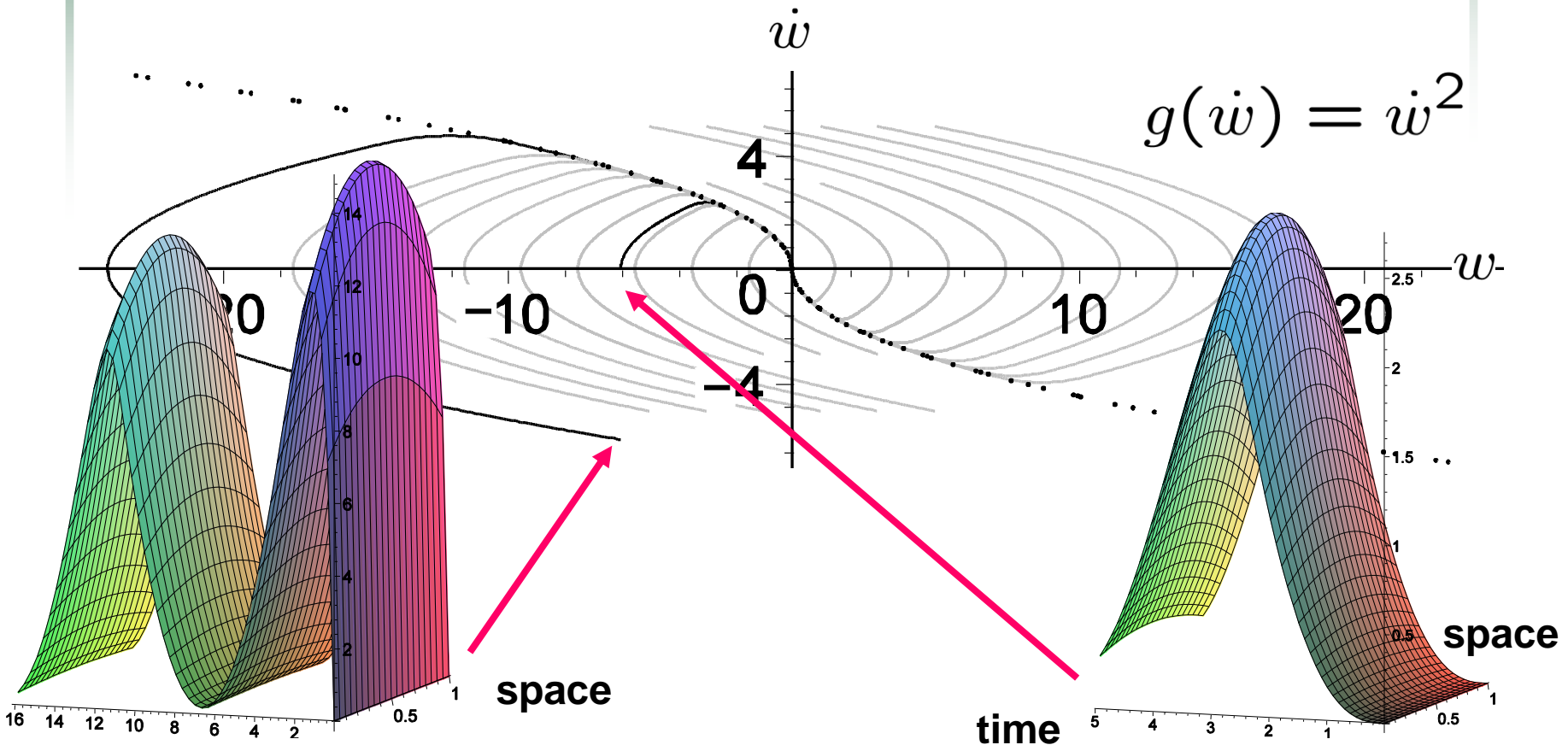

**distributed case  
state unconstrained**



# Boundary Control Case

## Problem 2

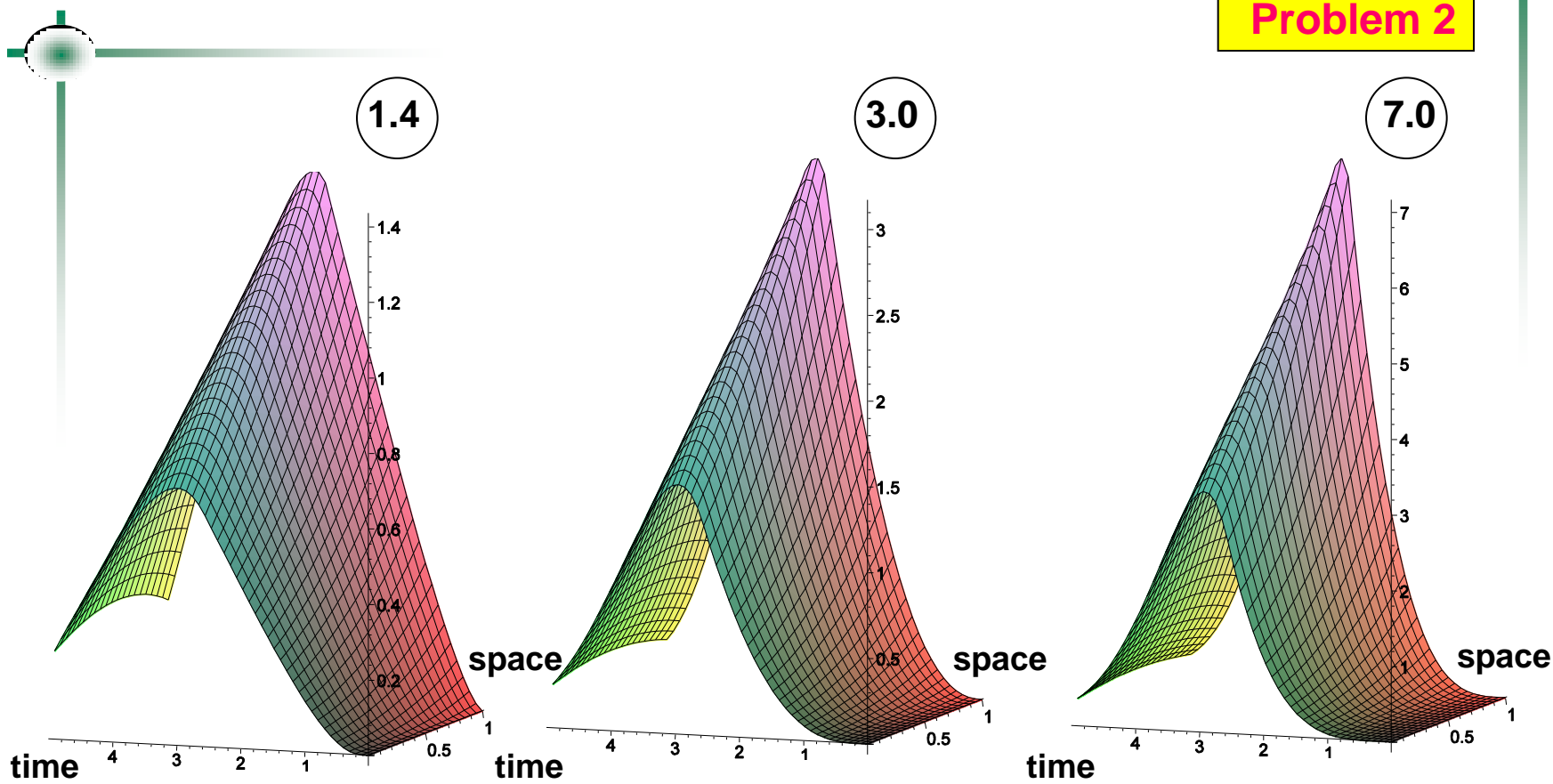

$$h(z) = |z|$$

**Coulomb**

$$h(z) = z^2$$

**Stokes**

$$h(z) = |z|^3$$

**Newton**



- Introduction/Motivation
- The hypersonic trajectory optimization problem
- The instationary heat constraint
- Numerical results
- The hypersonic rocket car problems
- **Theoretical results**
- New necessary conditions
- Numerical results
- Conclusion



# Theoretical results for Problem 1

- Existence, uniqueness, and continuous dependence on data

$$(w, T) \in W_2^1(0, t_f) \times (W_2^{1,0}(Q) \cap C([0, t_f], L^2(0, l)))$$

- Non-negativity of  $T$

- Symmetry  $T(x, t) = T(l - x, t)$

- Strong maximum in  $x = \frac{l}{2}$

- Classical solution  $\frac{d}{dt}T + \mathcal{L}T = g(\dot{w})$

- Maximum regularity

$$T_{tt} \in L^r(\varepsilon, t_f; L^2(0, l)) \quad r \geq 2$$

$$\partial_x^4 T \in L^r(\varepsilon, t_f; L^2(0, l)) \quad \varepsilon > 0$$

Problem 1

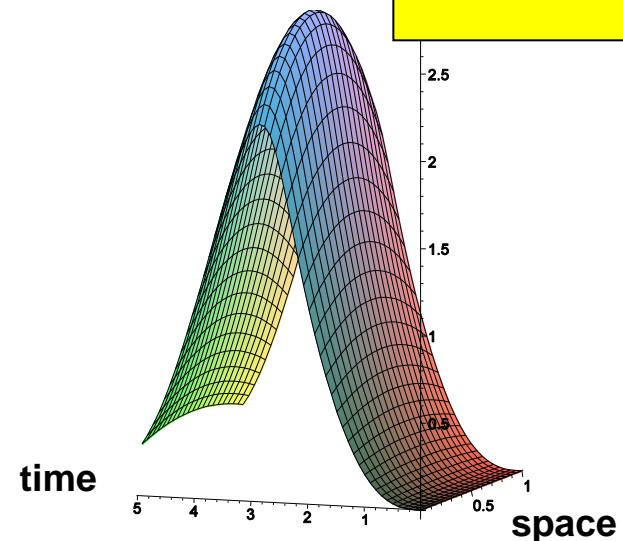

# Theoretical results (two formulations)

## Problem 1: Two equivalent formulations

### 1) as ODE optimal control problem

$$T\left(\frac{l}{2}, t\right) = \sum_{n=1}^{\infty} \tilde{\gamma}_n \left[ \int_0^t g(\dot{w}(s)) e^{-k_n^2(t-s)} ds \right] \leq T_{\max}$$

loss of convergence  
if differentiated

non-local, resp. integro-state constraint

### 2) as PDE optimal control problem

$$T_t + T_{xx} = g\left(\dot{w}_0 + \int_0^t u(s) ds\right)$$

$$T(x, t) \leq T_{\max}$$

non-standard

plus two **isoperimetric constraints** on  $\mathcal{U}$  due two ODE boundary conds.

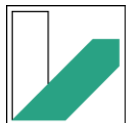

### Integro-state constraint

$$S(t, \mathbf{w}([0, t])) := T\left(\frac{l}{2}, t; w_2([0, t])\right) - T_{\max} \leq 0$$

### Transformation

$$w_3 := T\left(\frac{l}{2}, t; w_2([0, t])\right)$$

$$\dot{w}_3(t) = \frac{d}{dt} T\left(\frac{l}{2}, t; w_2([0, t])\right)$$

$$w_3(0) = 0$$

$$w_3(t_{\text{on}}) = w_3(t_{\text{off}}) = T_{\max}$$

$$w_3(t) \leq T_{\max}$$

**Integro-ODE**

**corresponds to  
Maurer's intermediate  
adjoining approach**

**pointwise**



## Necessary conditions: optimal control law

$$\begin{aligned}\mathcal{L}(\mathbf{w}, u, \mathbf{p}, t_{\text{on}}, t_{\text{off}}, t_f) &:= \int_0^{t_f} 1 + \frac{\lambda}{2} u^2 dt - \int_0^{t_f} (\dot{w}_1 - w_2) p_1 dt - \int_0^{t_f} (\dot{w}_2 - u) p_2 dt \\ &\quad - \int_0^{t_f} \left[ \dot{w}_3 - \frac{d}{dt} T \left( \frac{l}{2}, t; w_2([0, t]) \right) \right] p_3 dt \\ &\quad + \int_0^{t_f} (w_3 - T_{\text{max}}) d\mu \\ &\quad + (w_3(t_{\text{on}}) - T_{\text{max}}) \sigma_{\text{on}} + (w_3(t_{\text{off}}) - T_{\text{max}}) \sigma_{\text{off}}\end{aligned}$$

$\implies$

$$D_u \mathcal{L}[*] (u - u^*) = (\lambda u^* + p_2) (u - u^*) \geq 0 \quad \forall u \in [-u_{\text{max}}, u_{\text{max}}]$$

$\implies$

$$u^*(t) = P_{[-u_{\text{max}}, +u_{\text{max}}]} \left( -\frac{1}{\lambda} p_2 \right)$$



## Necessary conditions: adjoint equations

### Retrograde integro-ODE for the adjoint velocity

$$\dot{p}_2 = -p_1 - g'(w_2(t)) \left( p_3(t) - \int_t^{t_f} \sum_{n=1}^{\infty} k_n^2 \tilde{\gamma}_n e^{-k_n^2(s-t)} p_3(s) ds \right)$$

### Usual jump conditions for adjoint auxiliary state

discontinuities

$$\dot{p}_3 = \begin{cases} 0 & 0 \leq t < t_{\text{on}} \\ -\mu & t_{\text{on}} < t < t_{\text{off}} \\ 0 & t_{\text{off}} < t \leq t_f \end{cases} \quad \begin{aligned} p_3(t_{\text{on/off}}^-) &= p_3(t_{\text{on/off}}^+) - \sigma_{\text{on/off}} \\ p_3(t_f) &= 0, \quad \sigma_{\text{on/off}} \geq 0 \end{aligned}$$

$$\mu(w_3 - T_{\text{max}}) = 0, \quad \mu \geq 0$$

complementarity condition

difficult to solve  
no standard software





## Problem 1

$$\frac{\partial T}{\partial t}(x, t) - \frac{\partial^2 T}{\partial x^2}(x, t) = g \left( \dot{w}_0 + \int_0^t u(s) \, ds \right)$$

$$\text{in } (0, l) \times (0, t_f)$$

$$T(x, 0) = 0 \quad \text{on } (0, l)$$

$$-\frac{\partial T}{\partial x}(0, t) = -T(0, t) \quad \frac{\partial T}{\partial x}(l, t) = -T(l, t) \quad \text{on } [0, t_f]$$

$$\int_0^{t_f} u(t) \, dt = -\dot{w}_0 \quad \int_0^{t_f} \int_0^t u(s) \, ds \, dt = -w_0 - \dot{w}_0 t_f$$

$$T(x, t) \leq T_{\max} \quad \text{in } (0, l) \times (0, t_f)$$

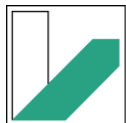

By the above we obtain a continuously differentiable solution operator

$$S: f(u, t_f) := \int_0^{t_f} 1 + \frac{\lambda}{2} u^2(t) dt \stackrel{!}{=} \min_{(u, t_f) \in C}$$

subject to

$$G_1(u, t_f) := \begin{pmatrix} \int_0^{t_f} u(t) dt + \dot{w}_0 \\ \int_0^{t_f} \int_0^{t_f} u(s) ds dt + w_0 + \dot{w}_0 t_f \end{pmatrix} = 0$$

$$G_2(u, t_f) := ( S(u, t_f) - T_{\max} ) \leq_K 0$$

with the convex cone

$$K := \left\{ T \in C([0, l] \times [0, t_f]), \quad T - T_{\max} \leq 0 \text{ a.e.} \right\}$$



**Theorem:** Let  $(u^*, t_f^*)$  be a local solution of the optimization problem.

Let be  $(\tilde{u}, \tilde{t}_f) \in \text{int } C(u^*, t_f^*)$  such that

$$G'_1(u^*, t_f^*)(\tilde{u}, \tilde{t}_f) = 0$$

$$G_2(u^*, t_f^*) + G'_2(u^*, t_f^*)(\tilde{u}, \tilde{t}_f) <_K 0.$$

Then there exists a Lagrange multiplier  $\bar{\mu} \in \mathcal{M}([0, l] \times [0, t_f])$  associated with  $(u^*, t_f^*)$ .

The set of all multipliers belonging to  $(u^*, t_f^*) \in \mathcal{M}$  is bounded.



## Necessary conditions: adjoint equations

$$-q_t(x, t) - q_{xx}(x, t) = \bar{\mu}$$

$$-q_x(0, t) = -q(0, t), \quad -q_x(l, t) = -q(l, t)$$

$$q(x, t_f^*) = 0$$

so far all seems to be standard, but

## Necessary condition: integro optimal control law

$$u^*(t) = P_{[-u_{\max}, u_{\max}]} \left\{ -\frac{1}{\lambda} \left[ \nu_1 + \nu_2 t \quad \boxed{p_2} \right. \right. \\ \left. \left. + \int_t^{t_f} g' \left( \dot{w}_0 + \int_0^t u^*(r) dr \right) \cdot \left( \int_0^l q(x, s) dx \right) ds \right] \right\}$$

**extremely difficult to solve**  
**no standard software**



By comparing the two optimal control laws

$$p_1(t) \hat{=} -\nu_2$$

$$p_2(t) \hat{=} \nu_1 + \nu_2 t + \int_t^{t_f^*} g'(v^*(s)) \cdot \left( \int_0^l q(x, s) dx \right) ds$$

discont. deriv. / jump

$$p_3(t) - \int_t^{t_f^*} \sum_{n=1}^{\infty} k_n^2 \tilde{\gamma}_n e^{-k_n^2 (s-t)} p_3(s) ds \hat{=} \int_0^l q(x, t) dx$$

jump

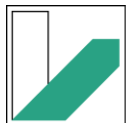

The two formulations allow the comparison of the necessary conditions:

**ODE version** • known theory

- local jump conditions for ODE formulation
- multipoint boundary value problem for integro-ODEs



**PDE version** • existence of Lagrange parameter

- non-local jump conditions for PDE formulation
- projection formula for control with integro-terms



- Introduction/Motivation
- The hypersonic trajectory optimization problem
- The instationary heat constraint
- Numerical results
- The hypersonic rocket car problems
- Theoretical results
- **New necessary conditions**
- Numerical results
- Conclusion

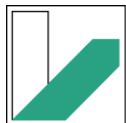

**Jump condition in the direction of  $t$  (equivalent to ODE case):**

$$\left[ \int_0^l q(x, t) \, dx \right]_{t_s^-}^{t_s^+} < 0$$

**Jump condition in the direction of  $x$  (no counterpart in ODE case):**

$$\left[ \int_0^{t_f} q_x(x, t) \, dt \right]_{\frac{l}{2}^-}^{\frac{l}{2}^+} < 0$$





- Introduction/Motivation
- The hypersonic trajectory optimization problem
- The instationary heat constraint
- Numerical results
  
- The hypersonic rocket car problems
- Theoretical results
- New necessary conditions
- **Numerical results**
  
- Conclusion



# Numerical results (Type: Problem 1)

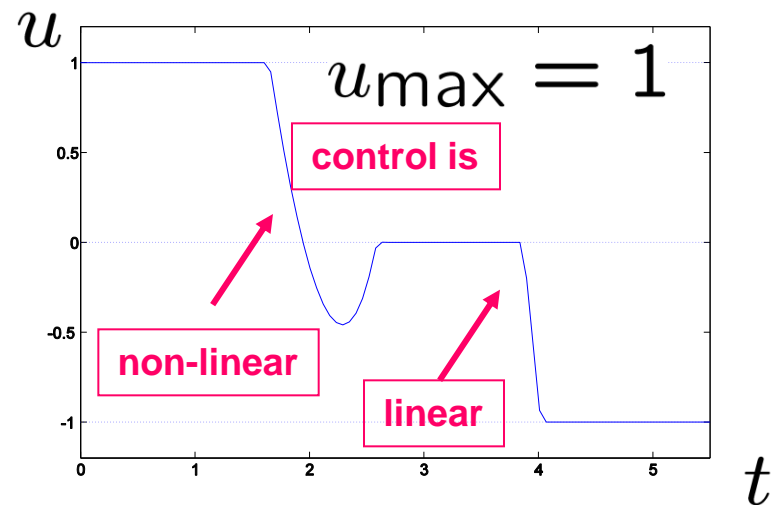
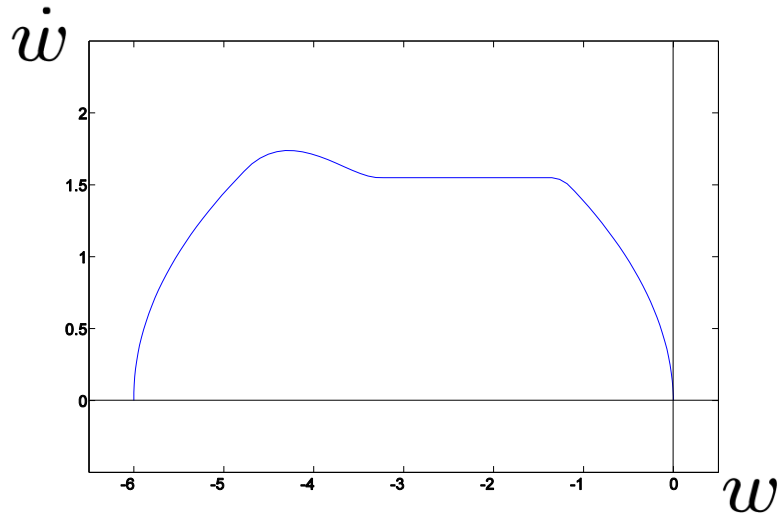
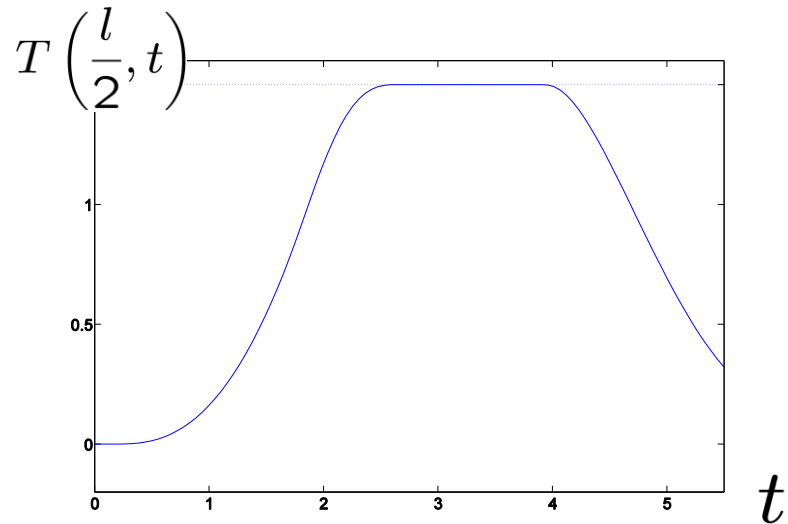
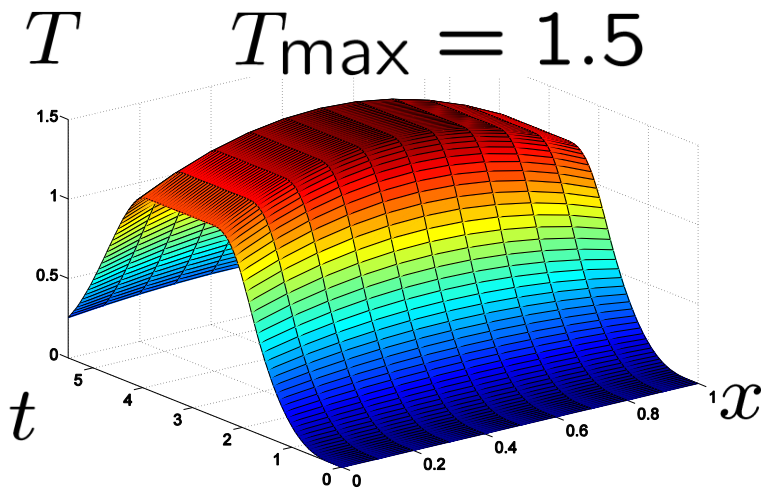

# Numerical results (Type: Problem 1)

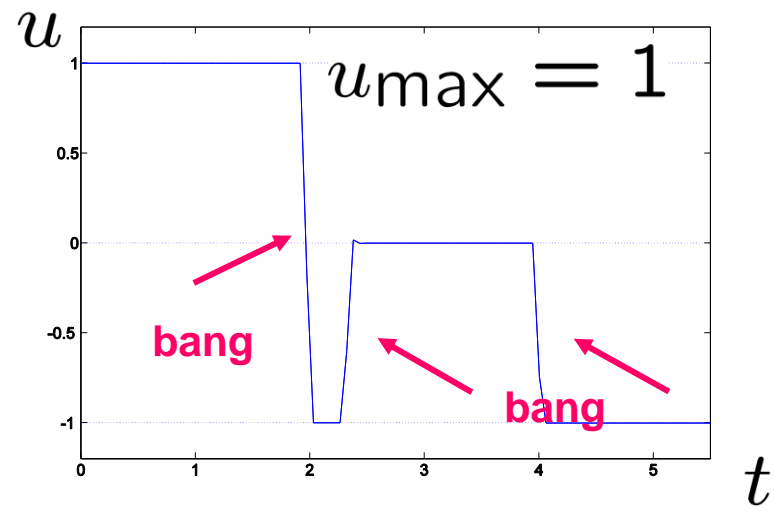
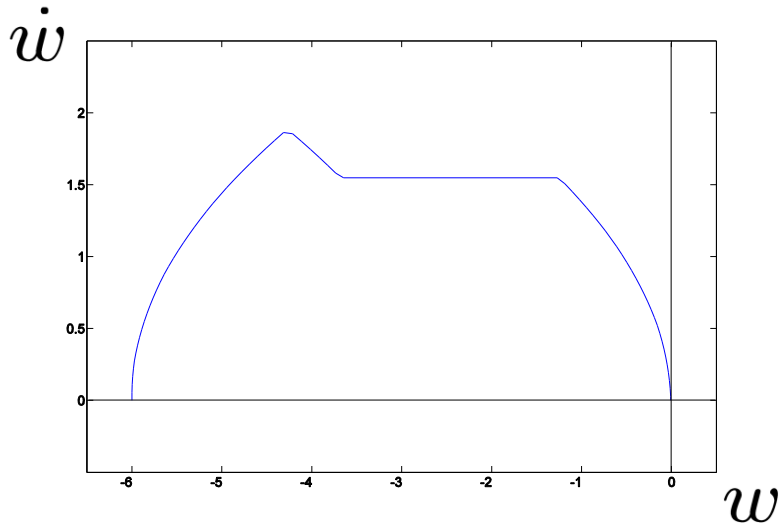
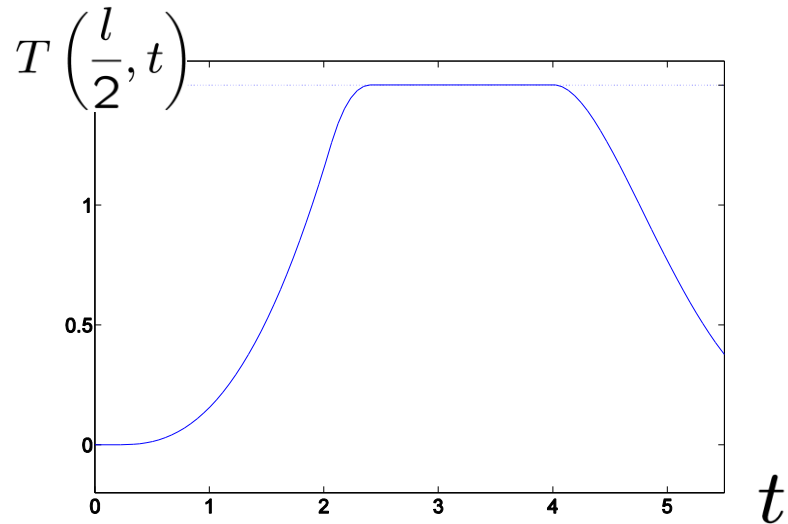
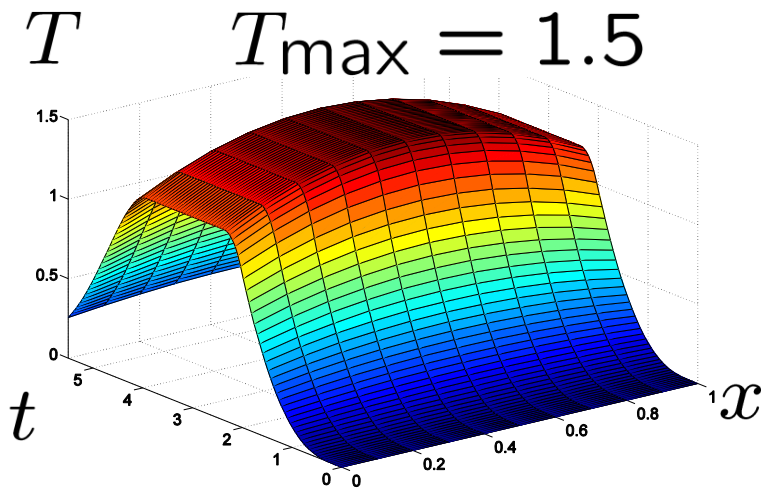

# Numerical results (Type: Problem 1)

time order 2

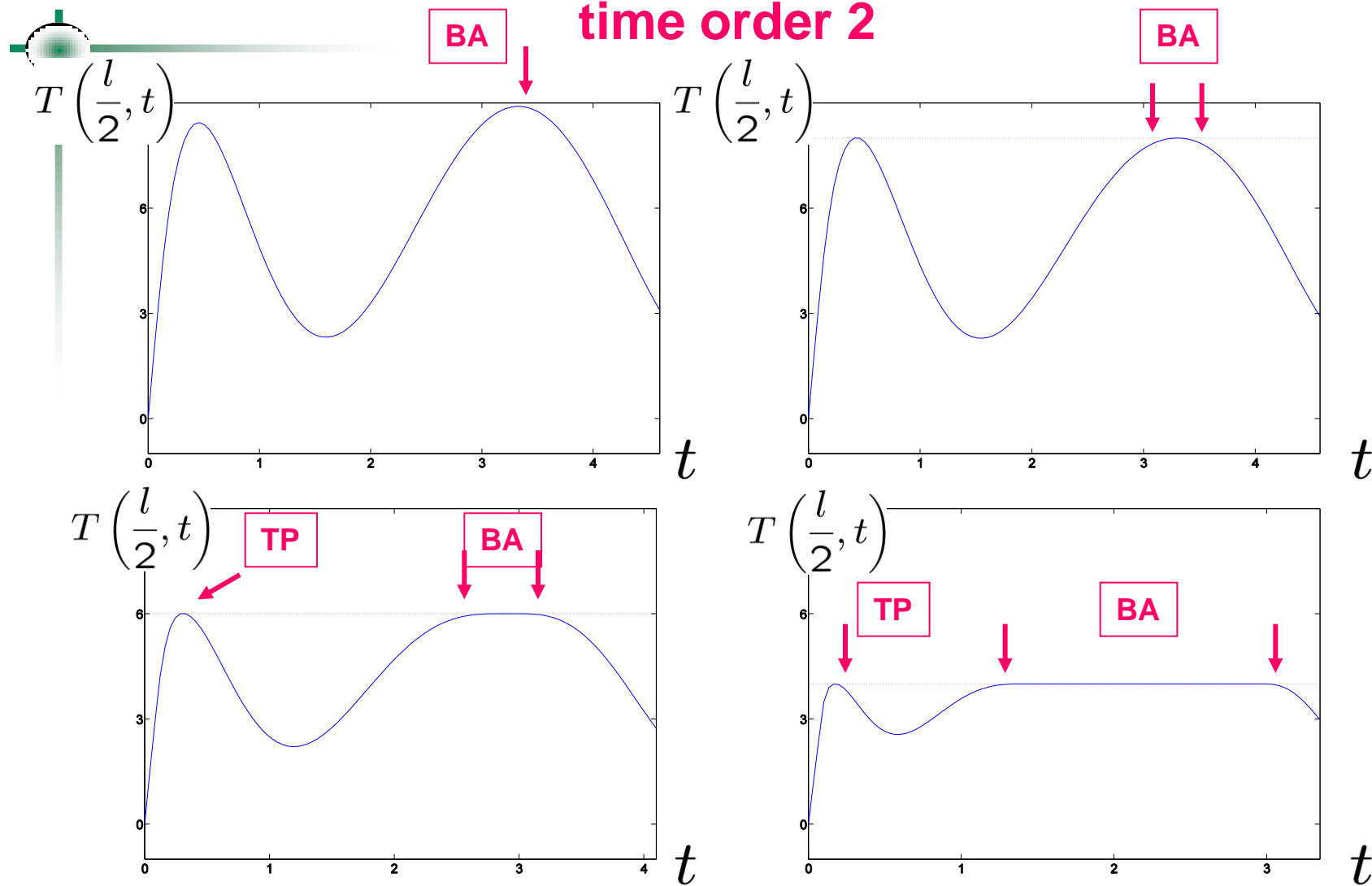

# Numerical results (Type: Problem 2)

$$T_{\max} = 1.5$$

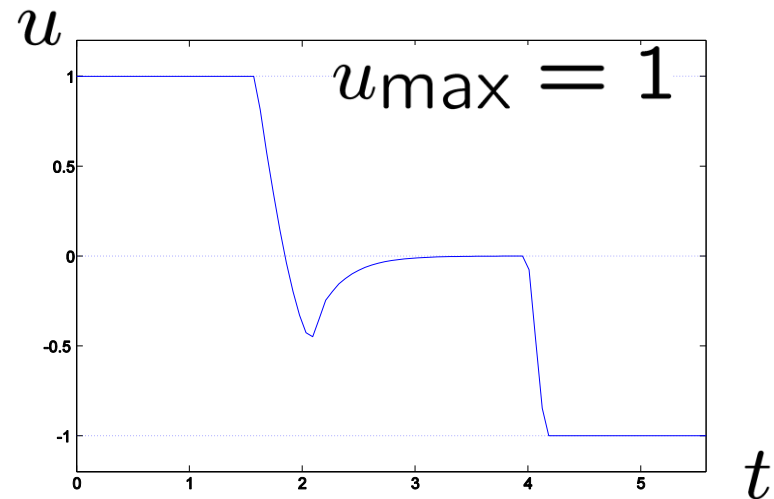
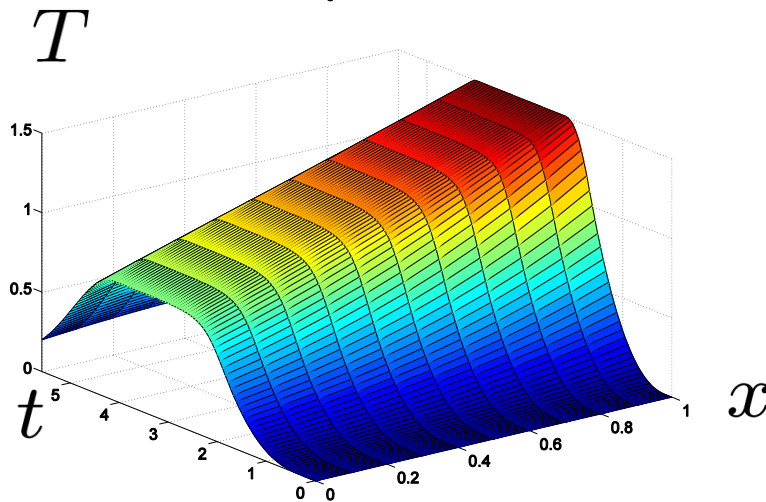
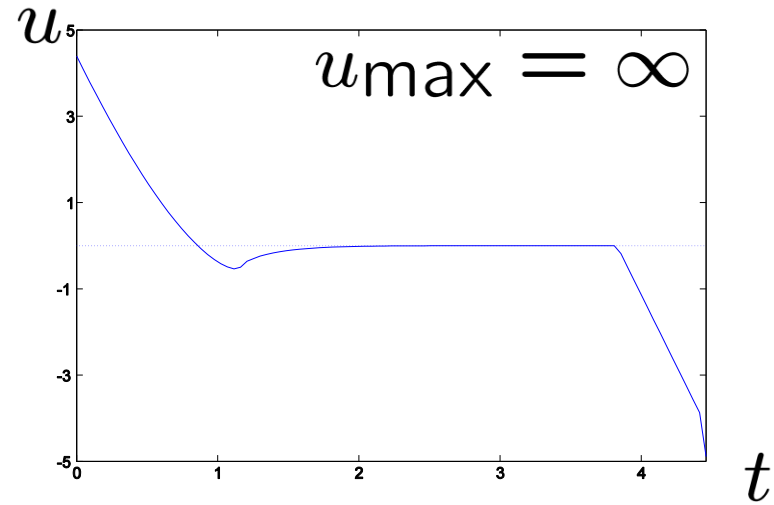
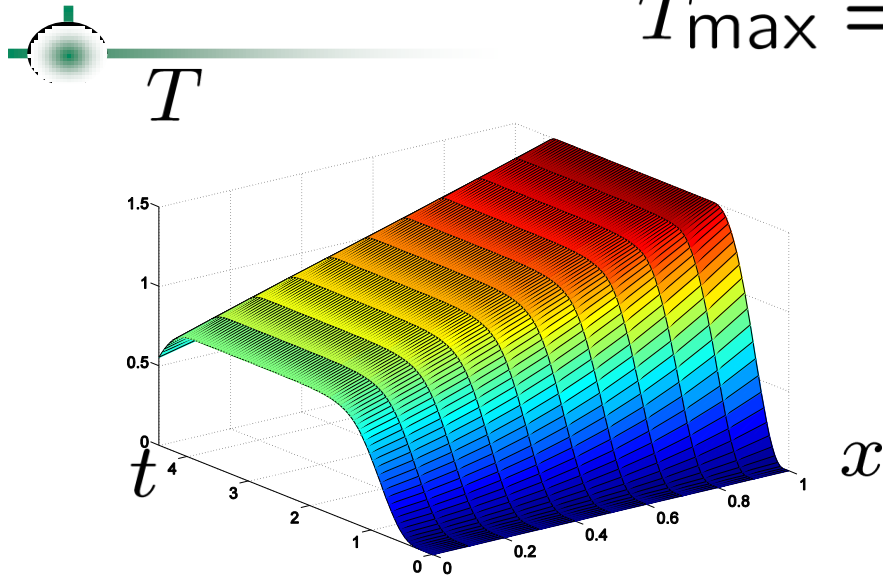

UNIVERSITÄT  
BAYREUTH

$$\lambda = 10^{-1}$$

Lehrstuhl  
Ingenieur-  
mathematik



# Numerical results (Type: Problem 2)

time order 1

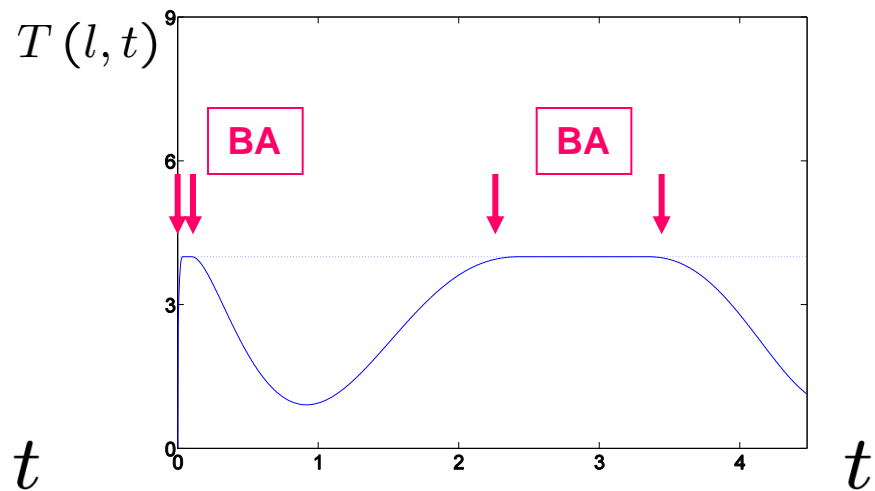
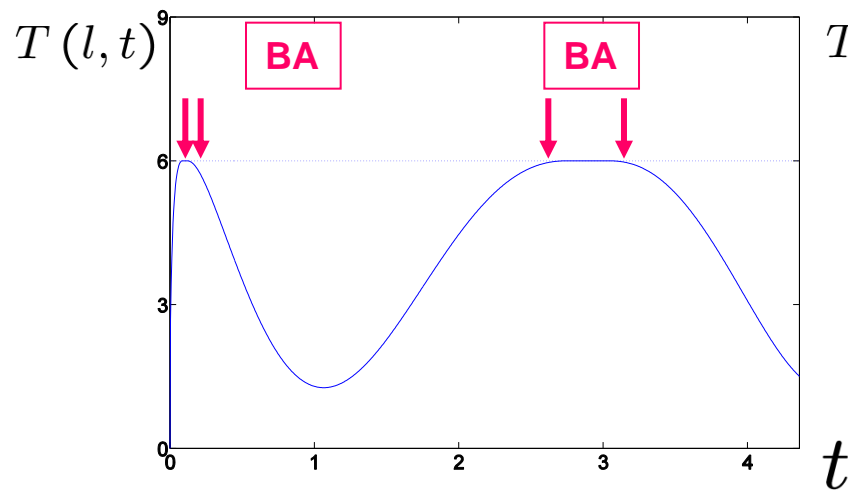
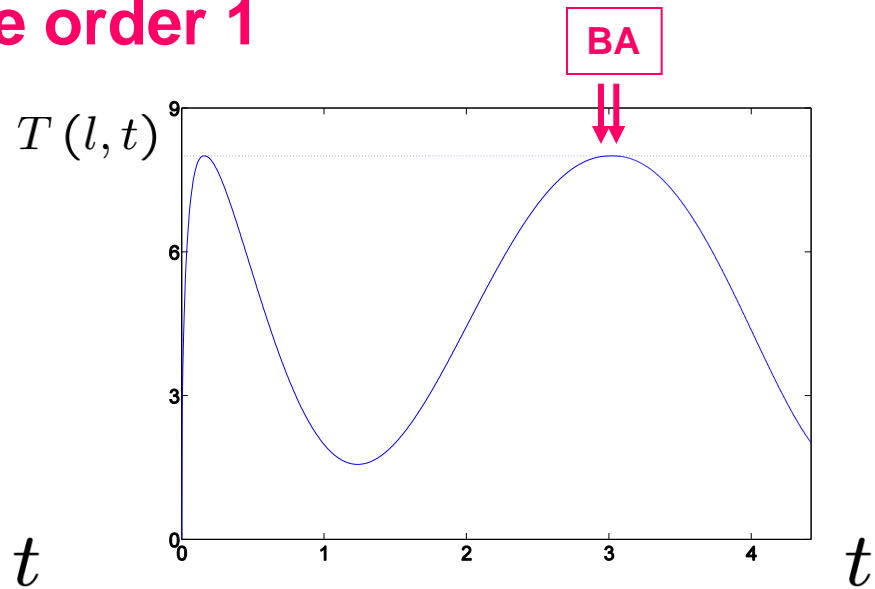
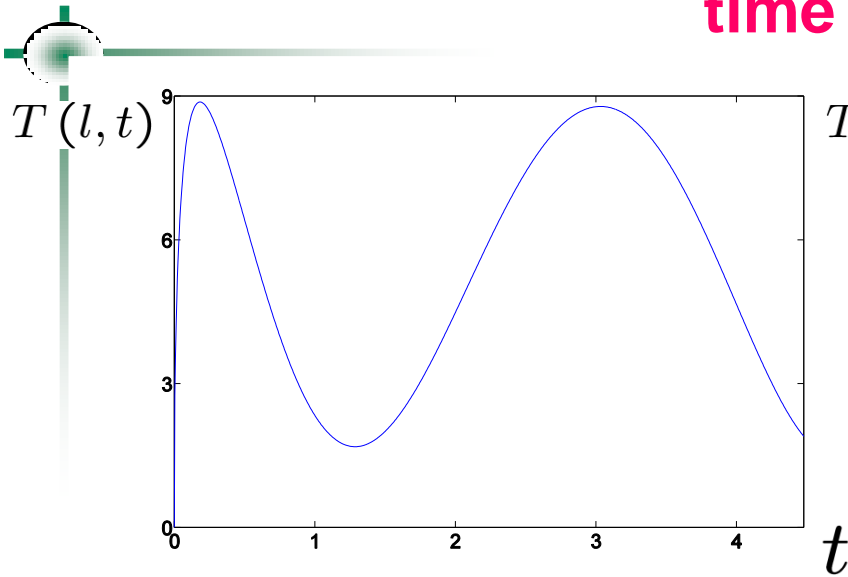

# Numerical results (Type: Problem 2)

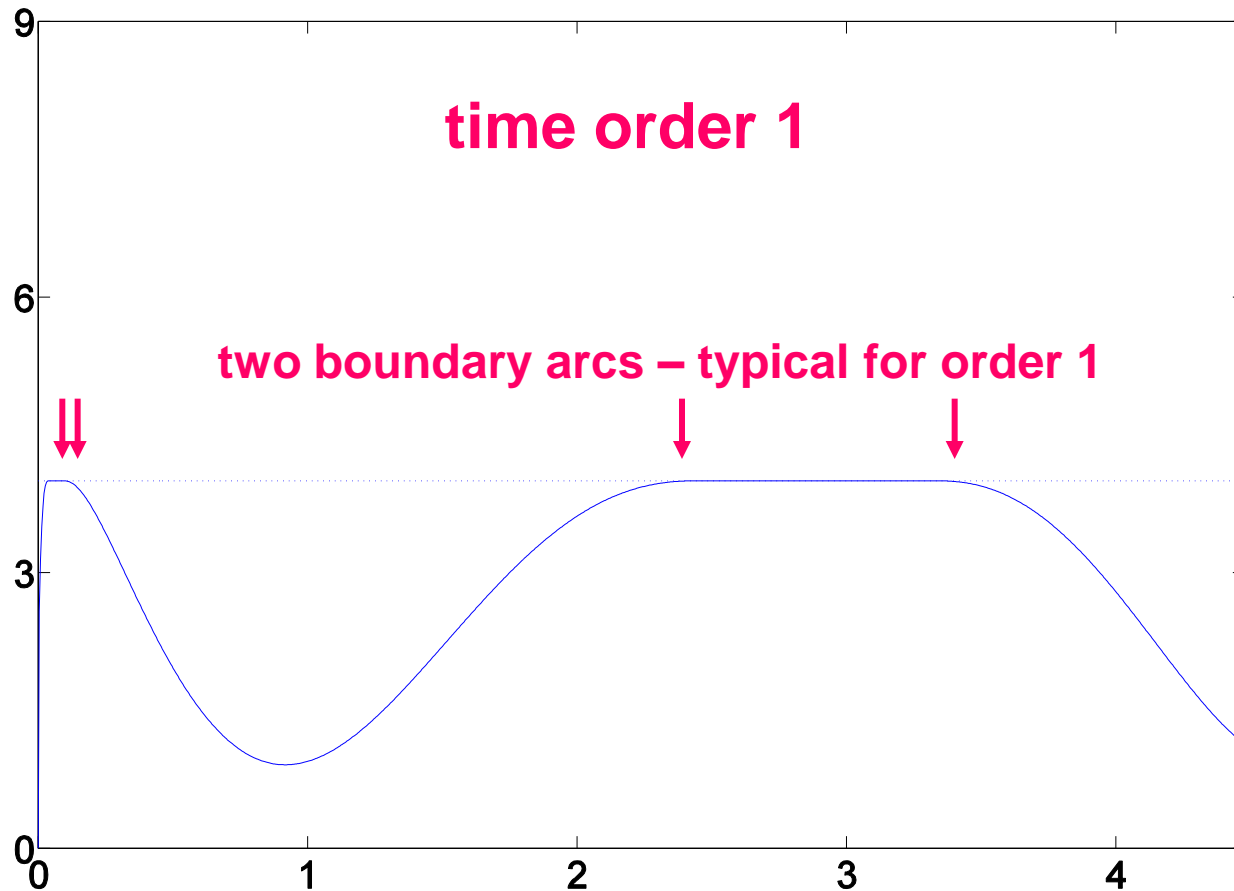

## A posteriori verification of optimality conditions: projection formula (ODE)

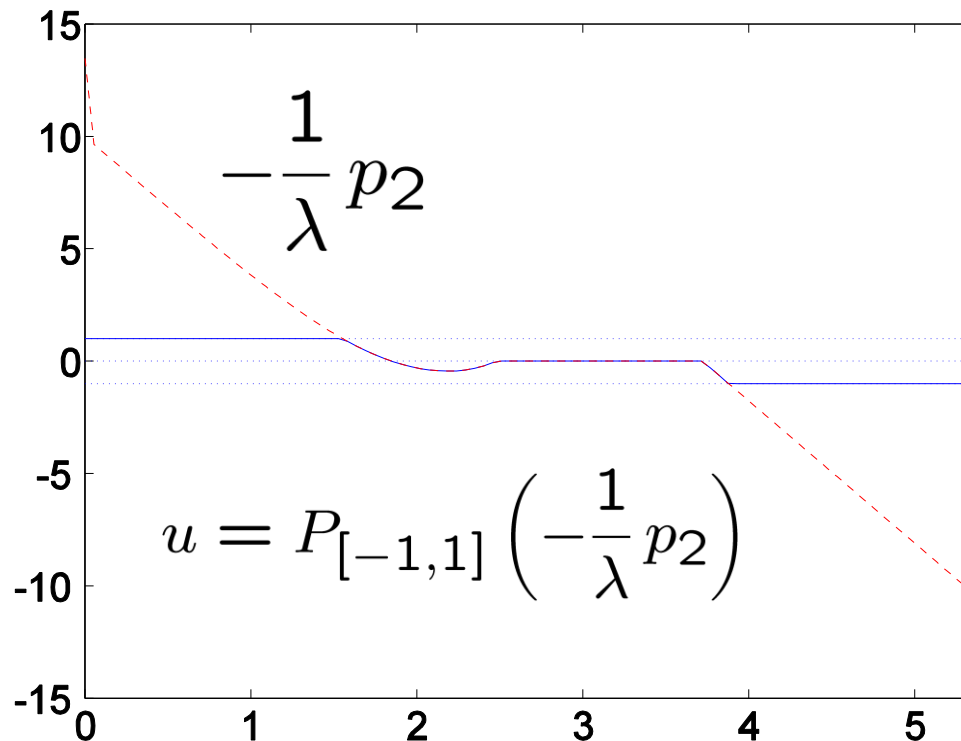

**Method:**  
**Ampl + IPOPT**

**Ref.: IPOPT**  
**Andreas Wächter**  
**2002**





# Numerical results (FOTD vs. FDTO)

**A posteriori verification of optimality conditions:  
The PDE formulation: adjoint temperature**

$$-q_t - q_{xx} = \varrho_1 \delta\left(x - \frac{l}{2}\right) \otimes \left[ \varrho_2 \delta(t - t_{\text{on}}) + \nu(t) + \varrho_3 \delta(t - t_{\text{off}}) \right]$$

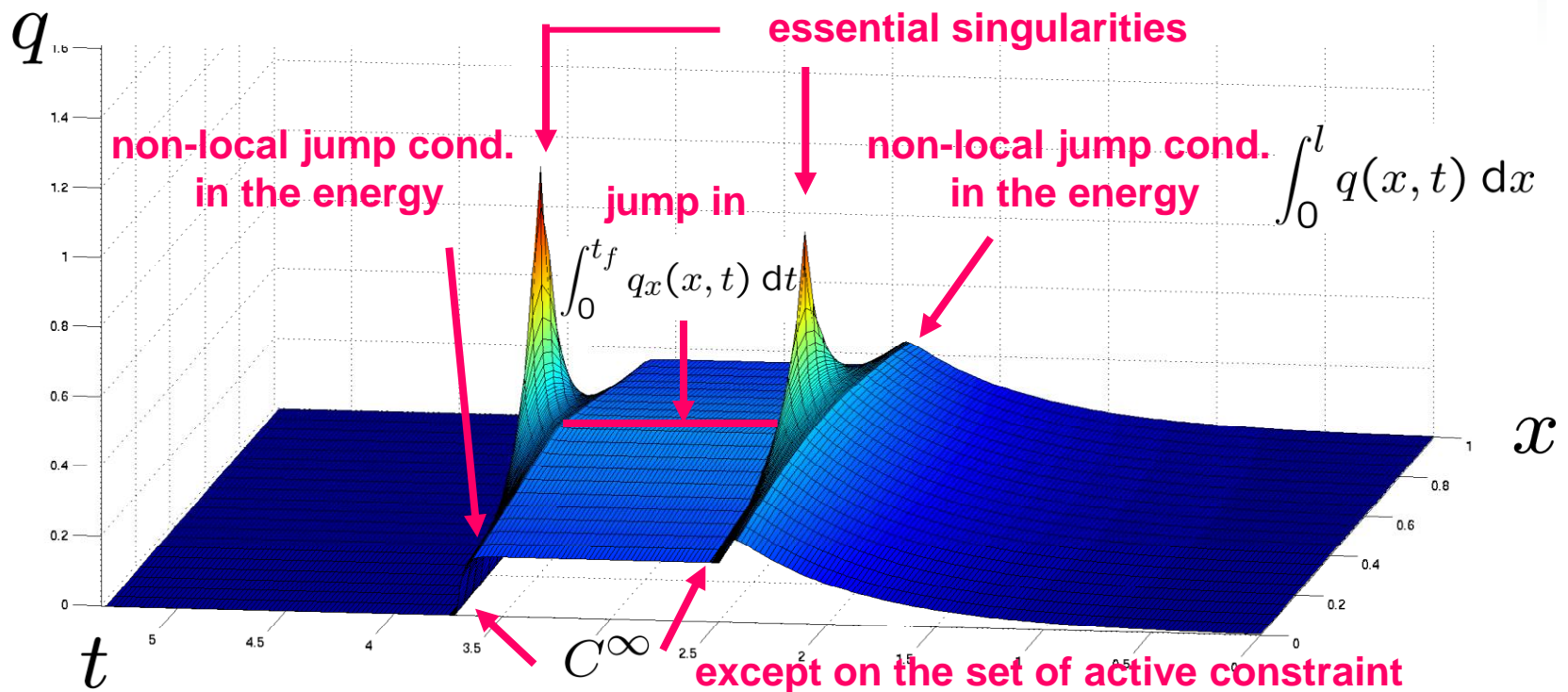

## A posteriori verification of optimality conditions: The PDE formulation: adjoint temperature

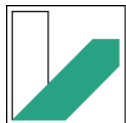
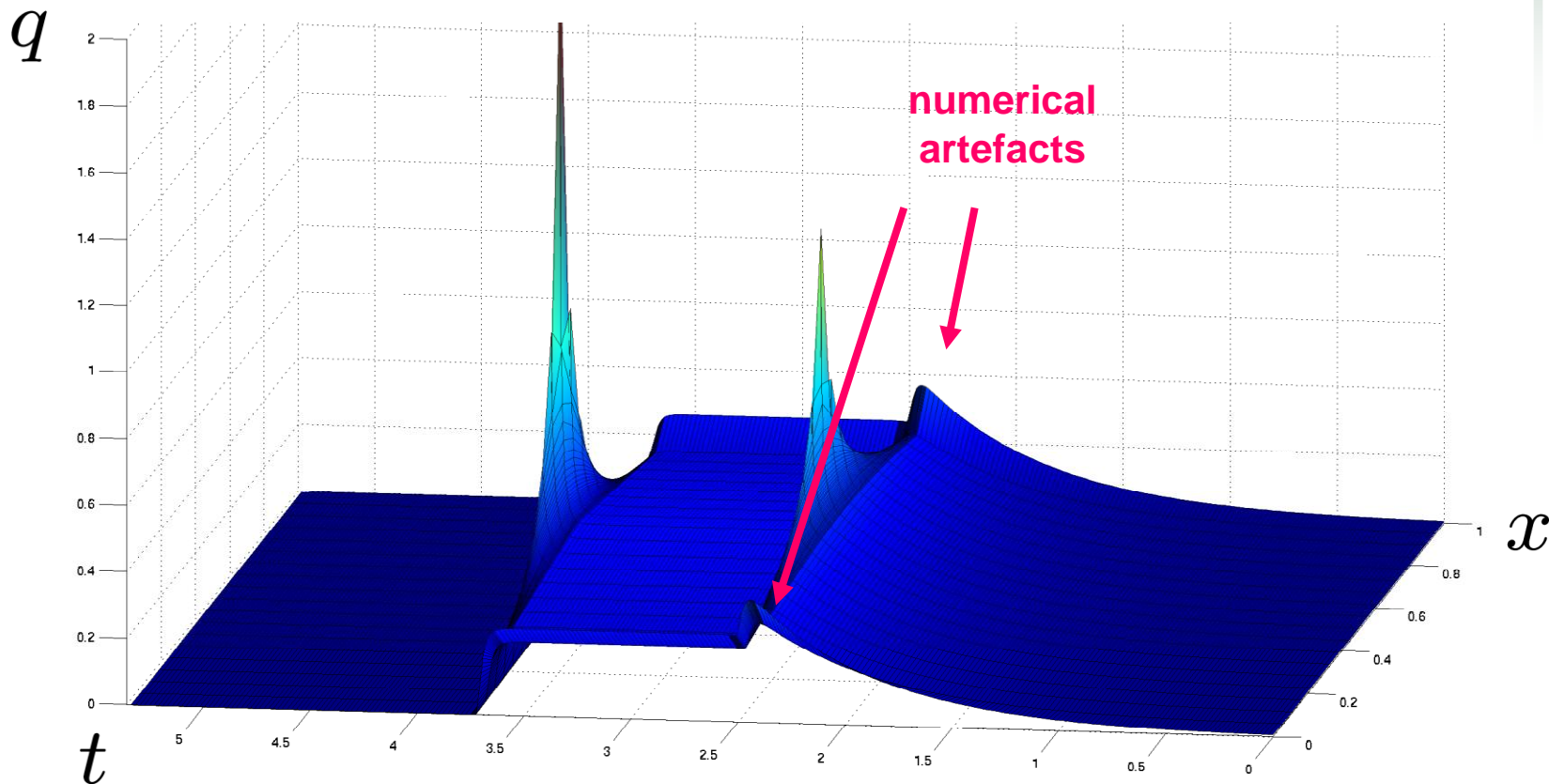

## A posteriori verification of optimality conditions: comparison of adjoints (ODE + PDE)



$$p_2(t) \cong \nu_1 + \nu_2 t + \int_t^{t_f^*} g'(v^*(s)) \cdot \left( \int_0^l q(x, s) dx \right) ds$$



## A posteriori verification of optimality conditions: comparison of adjoints/jump conditions (ODE + PDE)

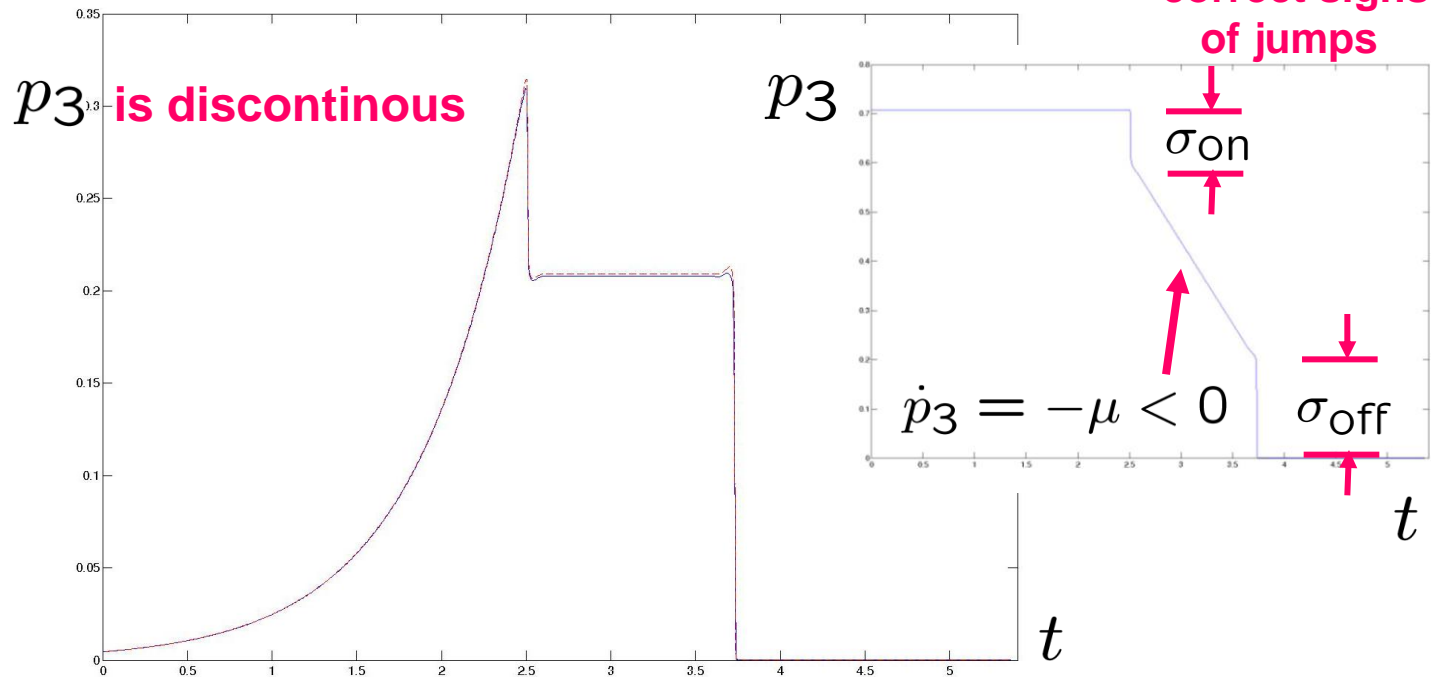

$$p_3(t) - \int_t^{t_f^*} \sum_{n=1}^{\infty} k_n^2 \tilde{\gamma}_n e^{-k_n^2(s-t)} p_3(s) ds \cong \int_0^l q(x, t) dx$$

- Introduction/Motivation
- The hypersonic trajectory optimization problem
- The instationary heat constraint
- Numerical results
- The hypersonic rocket car problems
- Theoretical results
- New necessary conditions
- Numerical results
- **Conclusion**

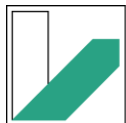

## Pros:

- Detailed model of high complexity for instationary heating
- Reduction of temperature of TPS due to optimal control
- Challenging problem: ODE - PDE state - constrained optimal control

## Cons:

- Lack of theory: nonlinear, state - constrained, ODE-PDE coupling
- Method of lines and SQP methods seem to be at their limits
- Adjoint based methods desirable, but almost impossible to handle



- **Staggered optimal control problems with state constraints**
- **Structural analysis w.r.t. switching structure**
- **Unexpectedly complicated necessary conditions**
- **Problems with free terminal time for PDE problems**
- **Jump conditions in Integro-ODE and PDE optimal control**
- **First optimize, then discretize hardly applicable**
- **First discretize, then optimize with reliable verification of necessary conditions, but with limitations in time and storage**
- **Motivation from hypersonic flight path optimization**

