



HAL
open science

Attitude & orbit control technique and optimal control in trajectory optimization at Thales Alenia Space

Thierry Dargent

► **To cite this version:**

Thierry Dargent. Attitude & orbit control technique and optimal control in trajectory optimization at Thales Alenia Space. SADCO A2CO, Mar 2011, Paris, France. inria-00578247

HAL Id: inria-00578247

<https://inria.hal.science/inria-00578247v1>

Submitted on 18 Mar 2011

HAL is a multi-disciplinary open access archive for the deposit and dissemination of scientific research documents, whether they are published or not. The documents may come from teaching and research institutions in France or abroad, or from public or private research centers.

L'archive ouverte pluridisciplinaire **HAL**, est destinée au dépôt et à la diffusion de documents scientifiques de niveau recherche, publiés ou non, émanant des établissements d'enseignement et de recherche français ou étrangers, des laboratoires publics ou privés.

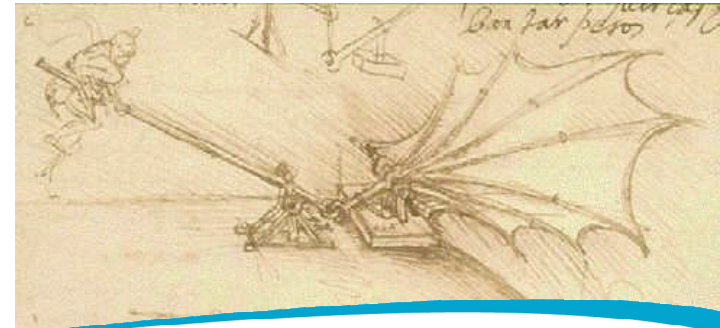
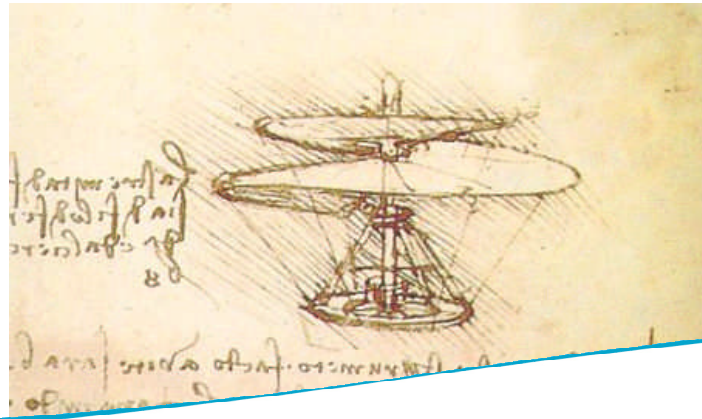
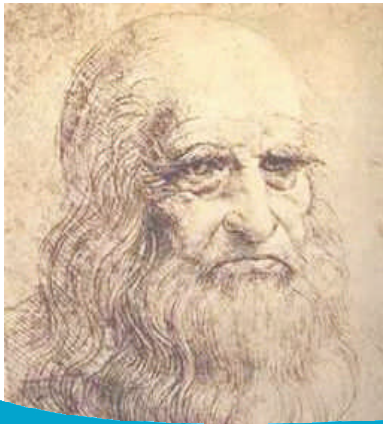

Attitude & orbit control technique and optimal control in trajectory optimization at Thales Alenia Space

Thierry Dargent

Thierry.dargent@thalesaleniastospace.com

- Introduction
- Indirect Method
- Differential Dynamic Programming
- Optimisation framework

In the last past years, low-thrust propulsion has evolved from a technological concept to a realistic option for interplanetary missions, it was considered first for very challenging trajectories to the inner planets, but now also for more classical ones, to Mars or the Moon.

After Deep-Space 1, the first demonstration mission of the use of low-thrust propulsion for interplanetary missions and Smart 1 to the Moon, it becomes the baseline complex interplanetary mission

In that context, Thales Alenia Space as increase its engineering capacity in interplanetary complex missions using chemical and/or low thrust propulsion

1998-2001

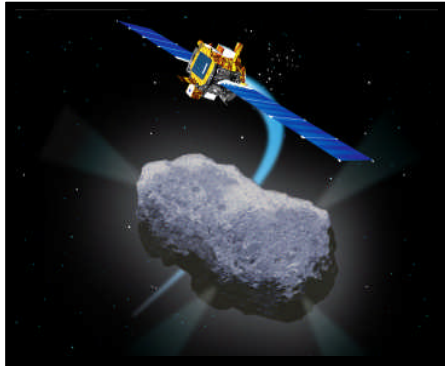

Deep Space 1

Mission: Testing / Flyby
Bodies: Comet Borrelly
Isp: 3100 s

2003-2006

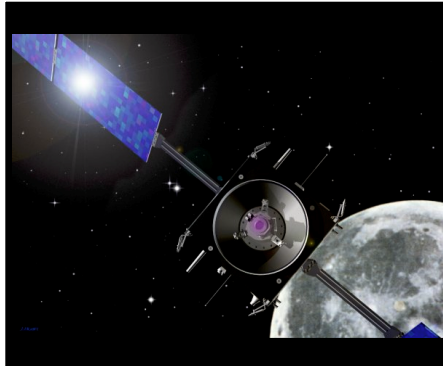

SMART-1

Mission: Orbiter
Bodies: Moon
Isp: 1640 s

2003-2010

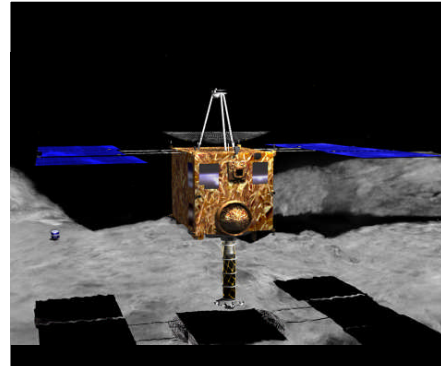

Hayabusa

Mission: Sample Return
Bodies: Itokawa
Isp: 2900 s

2007-2015

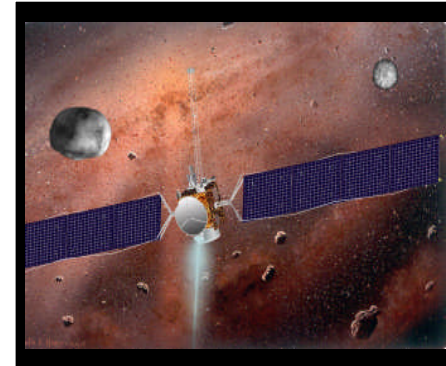

Dawn

Mission: Flyby / Orbiter
Bodies: Mars-Vesta-Ceres
Isp: 3100 s

2013-2019

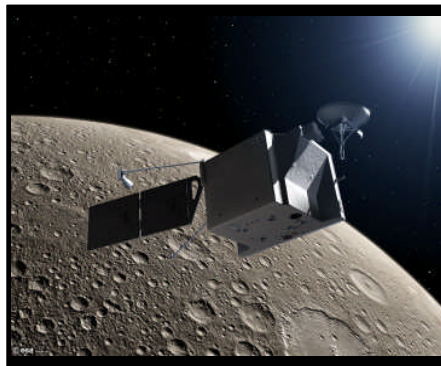

BepiColombo

Mission: Flyby / Orbiter
Bodies: Venus - Mercury
Isp: > 4600 s

>2015

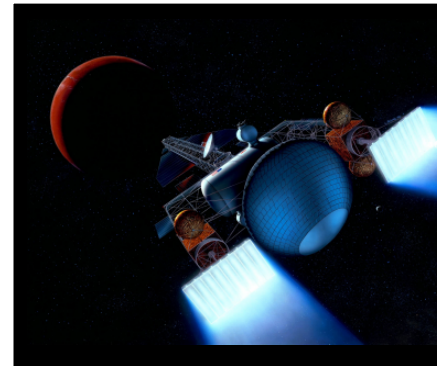

Outer Planet Orbiter

Mission: Flyby / Orbiter
Bodies: ?
Isp: >6000 s

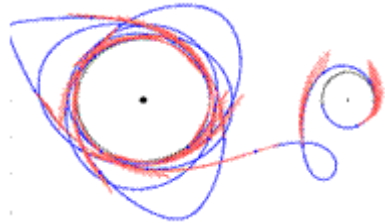

Multi-body problems

Long thrusting periods
→ Large number of control variables

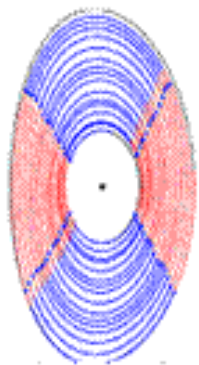
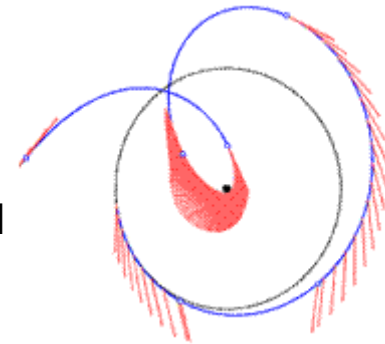

Multi-revolution problems



Constraints

Multiple local minima

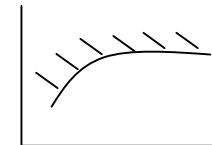
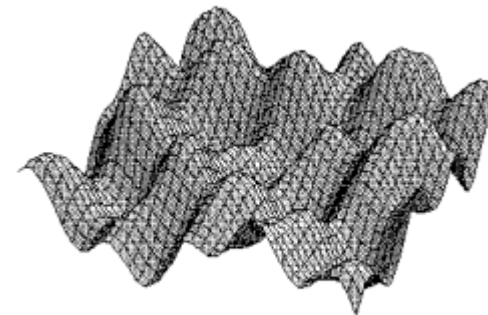

3 main methods exist:

| | Speed | Convergence Robustness | Accuracy |
|-------------------------|-------|---------------------------|----------|
| <i>Direct methods</i> | ★ | ★ ★ | ★ ★ |
| <i>Indirect methods</i> | ★ ★ ★ | ★ | ★ ★ ★ |
| <i>DDP</i> | ★ ★ | ★ ★ ★ | ★ ★ |

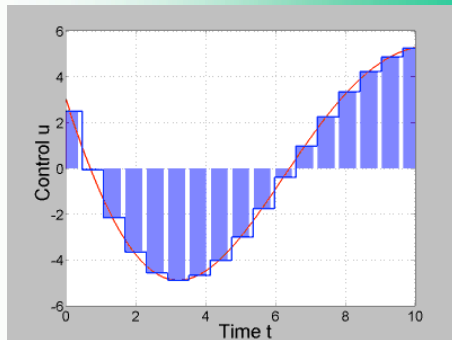

Direct Method

Transform the continuous OCP into a discrete NLP

→ MALTO (JPL),
Copernicus, DIDO, OTIS
(Boeing)

$$\begin{cases} \dot{x} = \frac{\partial H}{\partial \lambda}, \dot{\lambda} = -\frac{\partial H}{\partial x} \\ u^* = \arg \min_u H(x^*, \lambda^*, u) \end{cases}$$

Indirect Method

Rely on the necessary conditions of optimality (Pontryagin)

→ VARITOP (JPL), ETOPH (CNES), T3D (Thales), BNDSCO

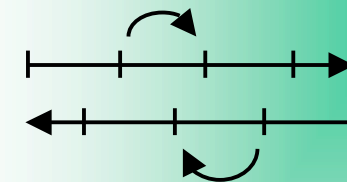

Differential Dynamic Programming (DDP)

Rely on Bellman's Principle of Optimality and quadratic expansions

→ Mystic (JPL), HDDP

Tool objective

- Provide to the mission analysis engineer, an efficient tool for designing orbit transfer in interplanetary and earth mission using low (continuous) thrust propulsion system
- calculate the optimal orbit transfer control strategy for minimum time/maximum mass to orbit problem
- enabling various boundaries condition at initial and final time to handle all the major constraint of the transfer scenario
 - departure on $[a, e, i, \omega, \Omega, v(t_0)]$ or $[x, y, z, V_{inf}]$ with t_0 fix or free
 - rendezvous on $[a, e, i]$, $[a, e, i, \omega, \Omega]$, $[a, e, i, \omega, \Omega, v]$, $[x, y, z]$ ou $[x, y, z, V_{inf}]$
 - RDV with rotating target (final longitude function of time)
- Engine characteristic and thrust define by user
- Easy to use software with an Graphical User Interface

T_3D mathematical formulation is base on

- Use of the maximum principal (indirect method)
 - Advantage
 - low number of optimisation parameters
 - quick calculation
 - good quality of the solution
 - Drawback
 - Necessary condition to be derive by analytical calculation
 - high sensitivity of the solver convergence to the parameter initial guess for multiple revolution and bang bang control
 - extremum solution (min or max) and only necessary condition
- gravitational model: Central body
 - Enough in most of the case: most of the time the thrust acceleration is higher than one order compare to any other perturbation
 - Use of Gauss equation in equinoctial form $[p, ex, ey, hx, hy, l]$ which give nice equations from numerical point of view and engineering feeling for parameters initial guess.

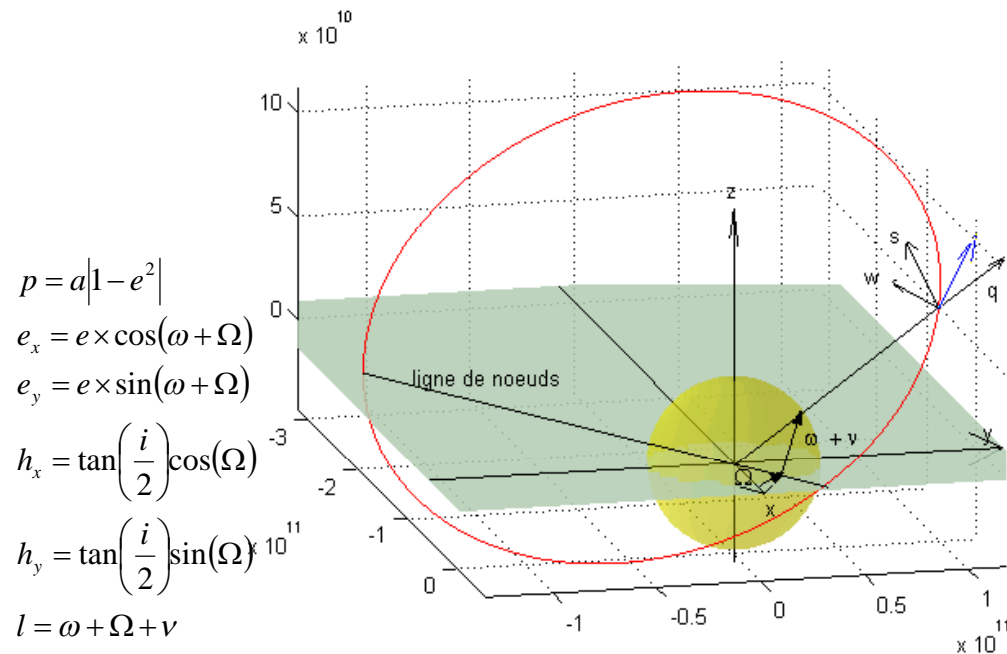

Parameter and local orbital frame definition

$$\frac{dp}{dt} = 2\sqrt{\frac{p^3}{\mu}} \frac{1}{Z} S$$

$$\frac{de_x}{dt} = \sqrt{\frac{p}{\mu}} \frac{1}{Z} (Z \times \sin(l) Q + A \times S - e_y F \times W)$$

$$\frac{de_y}{dt} = \sqrt{\frac{p}{\mu}} \frac{1}{Z} (-Z \times \cos(l) Q + B \times S + e_x F \times W)$$

$$\frac{dh_x}{dt} = \frac{1}{2} \sqrt{\frac{p}{\mu}} \frac{X}{Z} \cos(l) W$$

$$\frac{dh_y}{dt} = \frac{1}{2} \sqrt{\frac{p}{\mu}} \frac{X}{Z} \sin(l) W$$

$$\frac{dl}{dt} = \sqrt{\frac{\mu}{p^3}} Z^2 + \sqrt{\frac{p}{\mu}} \frac{1}{Z} F \times W$$

$$\frac{dm}{dt} = -\frac{T}{g_0 \times Isp}$$

$$Z = 1 + e_x \cos(l) + e_y \sin(l)$$

$$A = e_x + (1 + Z) \cos(l)$$

$$B = e_y + (1 + Z) \sin(l)$$

$$F = h_x \sin(l) - h_y \cos(l)$$

$$X = 1 + h_x^2 + h_y^2$$

Equinoctial dynamic formulation

Let's introduce J the cost function for an optimal orbit transfer type problem and apply minimum principle. The general form of the cost function can be written

$$\bar{J} = \phi[x(t_f), t_f] + v^T \psi[x(t_f), t_f] + \int_{t_0}^{t_f} L[x, u, t] + \lambda^T (f(x, u, t) - \dot{x}) dt$$

The necessary condition of optimality is $\partial \bar{J} = 0$, which after the variation calculation gives:

$$\begin{aligned} \dot{x} &= f(x, u, t) && \text{n differential equations} \\ \dot{\lambda} &= -\left(\frac{\partial f}{\partial x}\right)^T \lambda - \left(\frac{\partial L}{\partial x}\right)^T && \text{n differential equations of the co-state dynamics} \end{aligned}$$

The command $u(t)$ being determined by the relation:

$$\frac{\partial H}{\partial u} = \left(\frac{\partial f}{\partial u}\right)^T \lambda + \left(\frac{\partial L}{\partial u}\right)^T = 0 \quad \text{n algebraic relations}$$

And the boundary conditions:

$$\begin{aligned} x_k(t_0) \text{ given at } t_0 \text{ or } \lambda_k(t_0) &= 0 && \text{n boundary conditions on the state at } t_0 \\ \lambda^T(t_f) &= \left(\frac{\partial \phi}{\partial x} + v^T \frac{\partial \psi}{\partial x}\right)_{t=t_f} && \text{n boundary conditions on the co-state at } t_f \\ \left[\frac{\partial \phi}{\partial t} + v^T \frac{\partial \psi}{\partial t} + \left(\frac{\partial \phi}{\partial x} + v^T \frac{\partial \psi}{\partial x}\right) f + L \right]_{t=t_f} &= 0 && \text{1 boundary condition on the final time} \\ \psi[x(t_f), t_f] &= 0 && \text{q boundary conditions on the state at } t_f. \end{aligned}$$

Departure from Mars around October the 1st, 2013 in $[a, e, i, \omega, \Omega, v(t_0)]$
arrival by crossing Earth orbit position $[x, y, z]$

- Satellite final dry mass fix to 970 kg
- Thrust law $T = 0.3 \text{ N}$ at $r_0 = 1 \text{ AU}$ law: $F = T * (r_0/r)^2$
- specific Impulse $I_{sp} = 4500 \text{ s}$

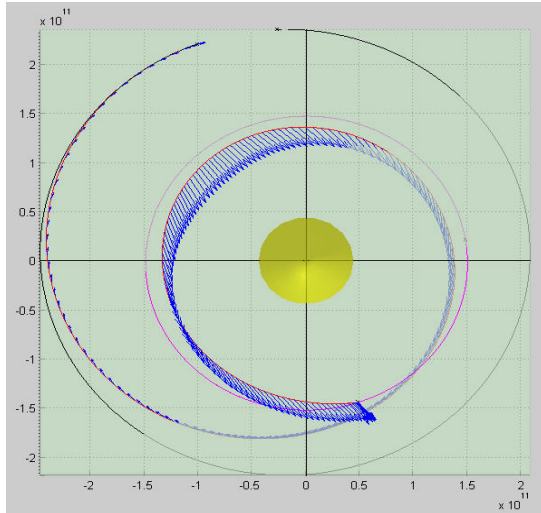

Departure date fix to 1/10/2013
minimum transfer time = 648.6
days
 $m_0 = 1275.6 \text{ kg}$

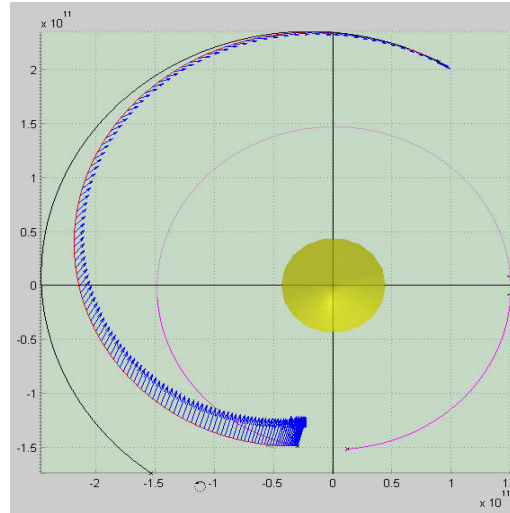

Departure date free: 1/10/2013 - 97
days
minimum transfer time = 348.8
 $m_0 = 1070.8 \text{ kg}$

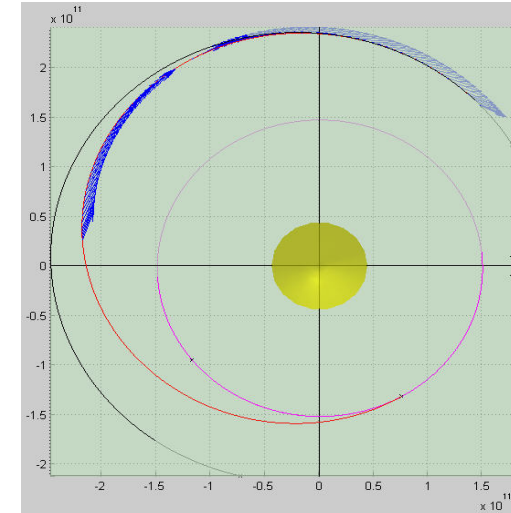

Departure date free: 1/10/2013 - 155
days
Transfer time fix to 450 days
Maximum initial mass $m_0 = 1027.9 \text{ kg}$

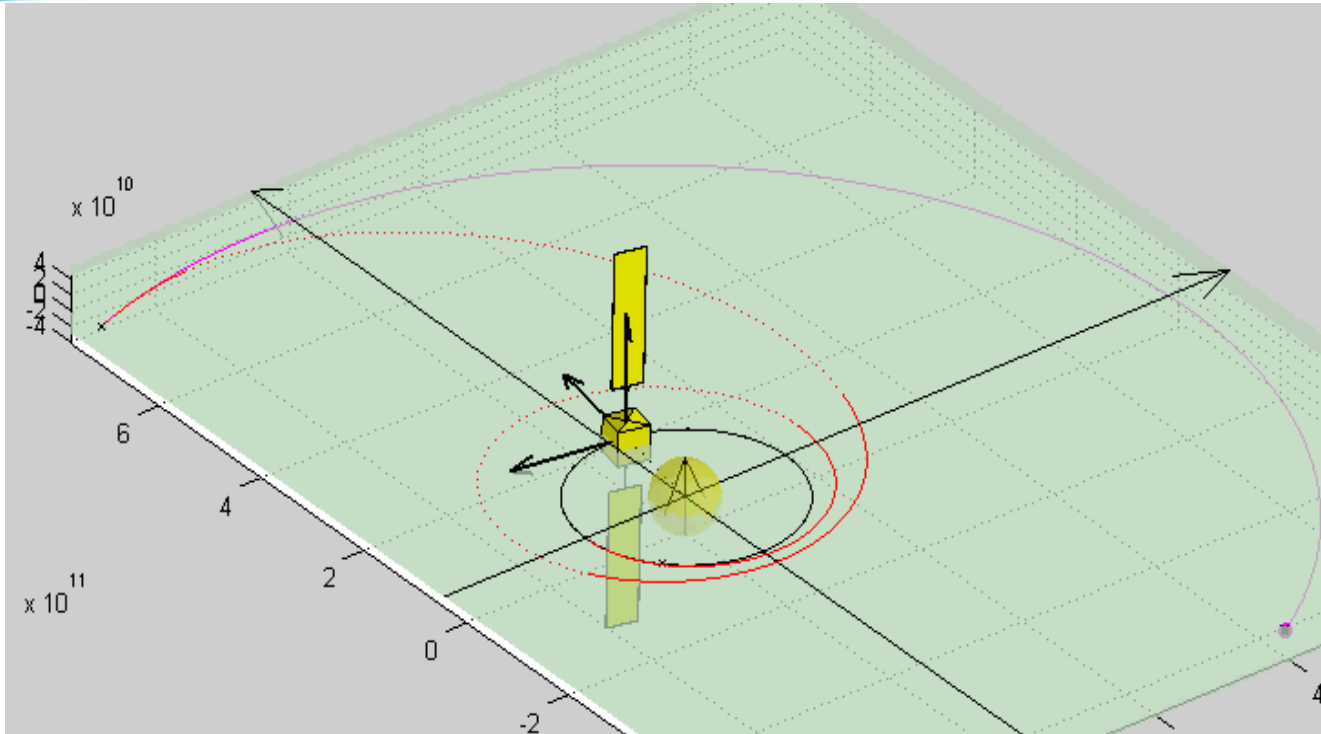

Example coming from paper “Régis Bertrand, Richard Epenoy, CNES Technical note n° 147, December 2002, page 36”

- Satellite mass at departure is 1500 kg. Thrust = 0.33 N and the exhaust velocity to 37278 m/s, which give an Isp of 3801.29 s
- Earth departure date December, 12/2008, the trip time 1965 days.
- Propellant consumption 508.04 kg (508.7 in CNES paper)

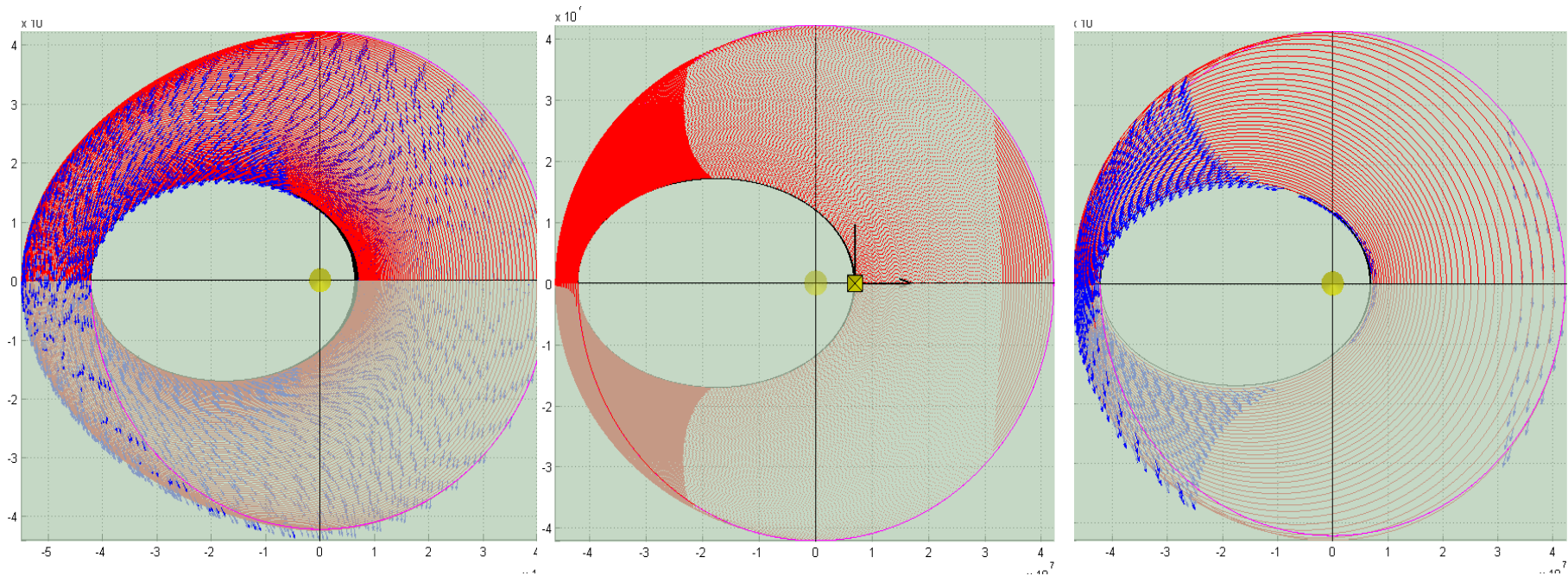

Minimum time transfer 3 tons satellite from AR5 GTO to GEO ($i_0=5^\circ$) with 1N/1500s isp engine. Transfer time 69.53 days and propellant consumption: 408.4 kg

Maximum mass transfer 3 tons satellite from AR5 GTO to GEO ($i_0=5^\circ$) with 1N/1500s isp engine. Transfer duration 100 days and propellant consumption: 319.5 kg

153.7 turns et 344 engine on/off

Maximum mass transfer 3 tons satellite from AR5 GTO to GEO with 4N/1500s isp engine. Transfer duration 25 days and propellant consumption: 321.6 kg

Issue with multi revolution transfer

- to be confident on the the solution
- The mathematical formulation only provide necessary condition
- it give an extremum solution: minimum or maximum
- it give local solution

Difficulty example

- Test case from ref [1] Max mass transfer 8 tons satellite GTO-GEO
 - 8 tons satellite GTO-GEO transfer
 - initial orbit $a=24371.138$ km, $e=0.73$, $i=7^\circ$, $\omega=180^\circ$, $\Omega=41$
 - final orbit $a=37226.138$ km, $e=0.1691822$, $i=0^\circ$, $\omega=180^\circ$, $\Omega=41$
 - engine 35 N, Isp 270s, $g_0 =9.80665$

| Case number | 1 | 2 | 3 | 4 |
|-----------------------|-----------|-----------|-----------|-----------|
| Number of Apoge burn | 14 | 15 | 16 | 16 |
| Number of perige burn | 0 | 1 | 0 | 0 |
| number of turn | 15,0 | 15,2 | 15,4 | 16,2 |
| Propellant mass | 3096,4 kg | 3084,8 kg | 3126,2 kg | 3102,0 kg |
| difference in % | 0,38% | 0,00% | 1,34% | 0,56% |

- > Many local sub optimal solution close to optimal solution which give place to sub-optimal algorithm or close loop technique (like Liapounov control for example)

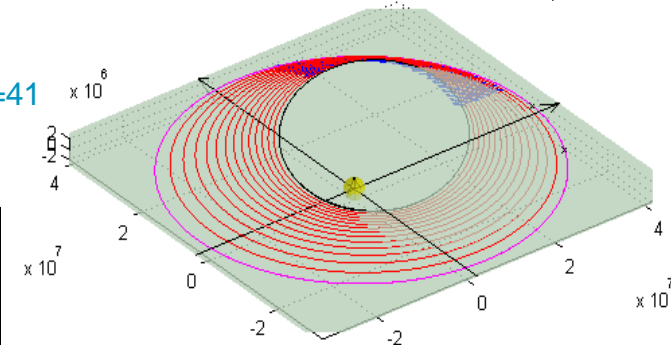
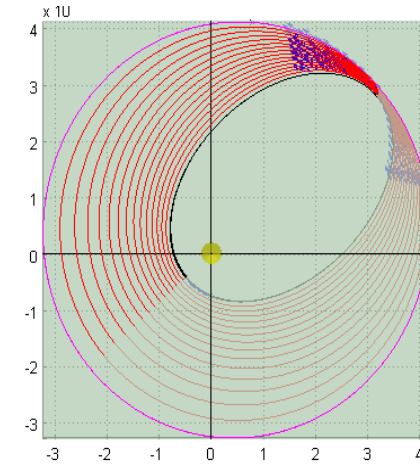

[1] Richard Epenoy, Régis Bertrand, Optimal Control and Smoothing techniques for computing minimum fuel orbital transferts and rendezvous, ISSD 2004

The advantages of indirect method compare to direct one are a low number of optimisation parameters which will give a rather quick calculation of the solution and the high quality of the solution

The main drawback is the need of a good initial guess of the optimisation parameters to allow the convergence of the solver and to be able to have an analytical formulation of the problem. It restricts the method to analytical model and make difficult for example the introduction of a full force perturbation model or multi body environment.

Initial guess of the optimisation parameters

- Use of averaging technique
- Use of equinoxial dynamic simplify the multi revolution solving problem
- Use of smoothing technique on the bang bang control
- Use of multistart procedure for difficult case
- Use of continuation technique (start from simplified sub problem exchange on thrust and time,etc) ease by the graphical interface

Restriction of the method to analytical model

- Use of numerical Automatic Differentiation with innovative muticomplex technique

Numerical differentiation using complex number & multicomplex number:

- base on property of holomorphic function (differentiable function in complex domain). This properties are describe by the Cauchy-Riemann equations:

The Cauchy-Riemann equations of holomorphic a complex-valued function $f(x + iy) = u(x,y) + iv(x,y)$ are the two equations:

$$\frac{\partial u}{\partial x} = \frac{\partial v}{\partial y}$$

$$\frac{\partial u}{\partial y} = -\frac{\partial v}{\partial x}$$

Then defining $z = x + ih$, for small h the first order development of $f(z) = f(x + ih)$ is:

$$f(x + ih) \approx f(x) + ih \times \frac{\partial f(x)}{\partial x}$$

then we can derive the derivative formula:

$$\frac{\partial f}{\partial x} \approx \frac{\text{Im}[f(x + ih)]}{h}$$

MultiComplex numbers (C^n) are extensions of complex numbers in higher dimensions

cross imaginary terms

$$z = x_0 + x_1 i_1 + \dots + x_n i_n + x_{12} i_1 i_2 + \dots + x_{n-1n} i_{n-1} i_n + \dots + x_{1\dots n} i_1 \dots i_n$$

Same formal representation as complex numbers can be used:

$$z = z_1 + z_2 i_n \quad \text{where } z \in C^n \quad \text{and } z_1, z_2 \in C^{n-1}$$

N order derivative formula:
$$f^{(n)}(x) = \frac{\text{Im}_{1\dots n} [f(x + hi_1 + \dots + hi_n)]}{h^n} + O(h^2)$$

More detail in ref: Lantoine, G., Russell, R. P., and Dargent, T., \Using Multicomplex Variables for Automatic Computation of High-Order Derivatives." Paper AAS 10-218, Feb. 2010. AAS/AIAA Space Flight Mechanics Meeting, San Diego, CA.

Dargent, T., \Automatic minimum principle formulation for low thrust optimal control in orbit transfers using complex numbers," Sept. 2009. International symposium on space fights dynamics, Toulouse, France

**Example of high order derivative with Cos(x)
Computation errors up to the 6th derivative for step h from 1e-70 to 1**

1st to 6th Cosinus derivative relative errors

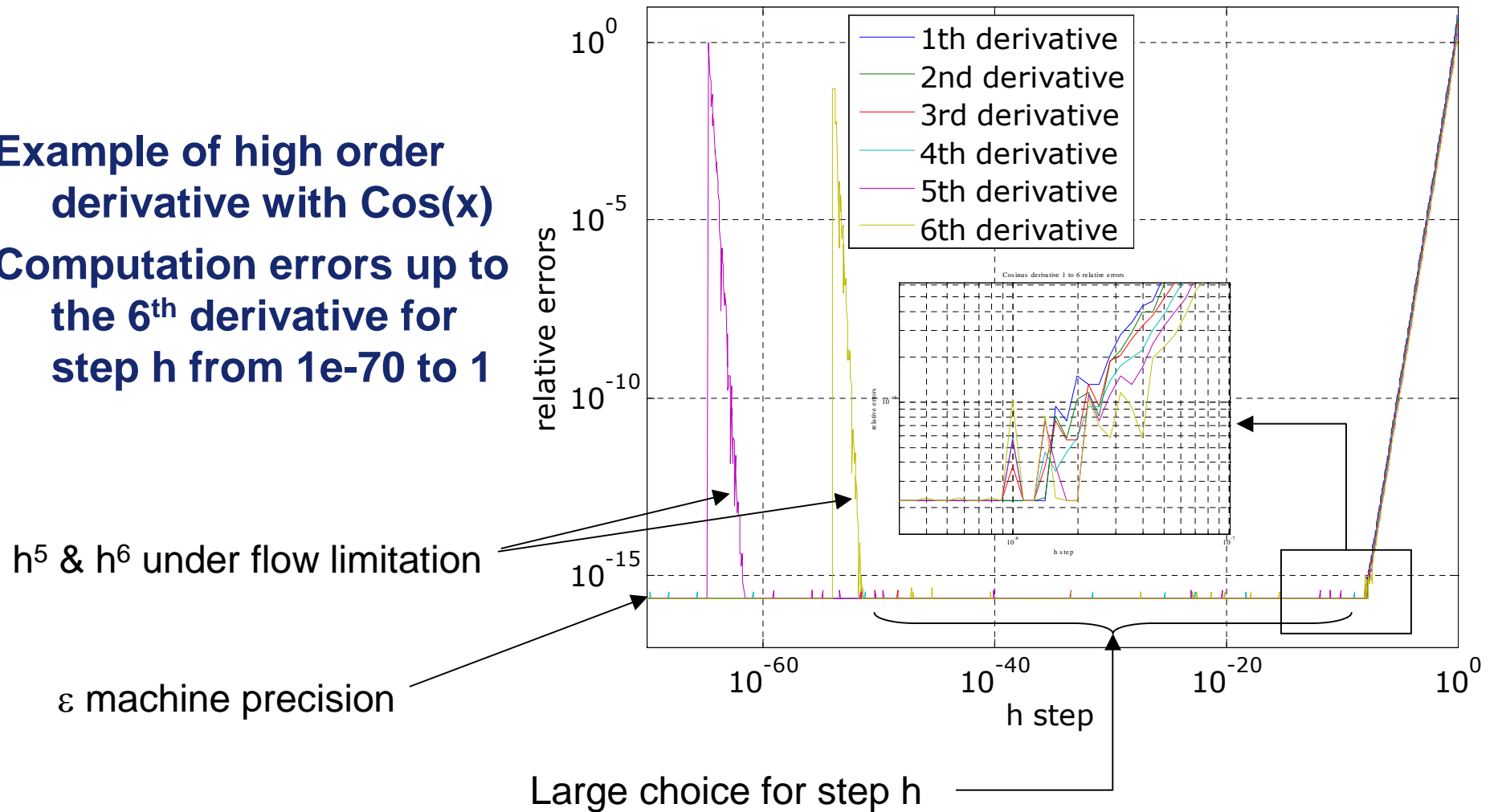

Starting from an existing tool T_3D for low thrust optimal control orbit transfers we have introduced in the dynamic formulation classical perturbation force model:

- Third-body perturbation, All planets & Moon of solar system available with high precision ephemeris
- Solar Radiation Pressure with eclipse model
- Gravitational Fields with Spherical Harmonics decomposition Model

The co-state dynamic $\dot{\lambda} = -\left(\frac{\partial f}{\partial x}\right)^T \lambda$ is computed using the complex method to evaluate the part $\frac{\partial f}{\partial x}$

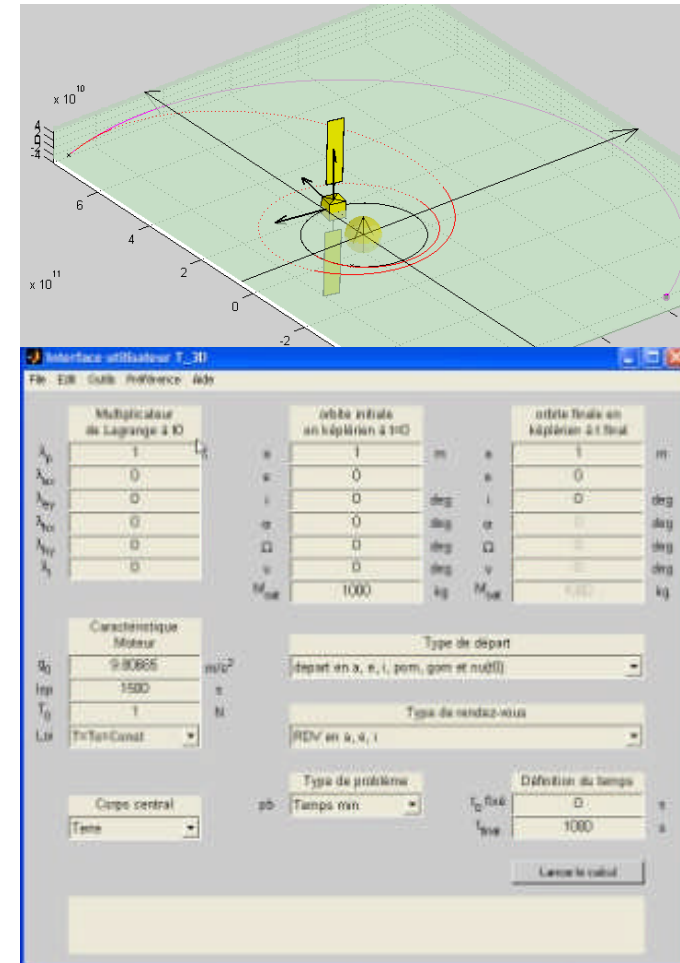

minimal time transfer for a large Geostationary satellite reaching it operational orbit with electrical propulsion :

- The satellite model: Initial mass 4415kg, Electrical motor thrust: 88mN, Isp: 1630s

The perturbation model is the following:

- Third body perturbation: Moon and Sun,
- Solar pressure radiation with a solar arrays surface of 100 m², visible surface absorptivity coefficient 0.7 and specular coefficient 1
- Earth harmonic spherical decomposition 70*70 using gravity model WGS84-EGM96 from NASA/NIMA
- Simulation epoch: 7/06/2006 11:56:21.

| | | | |
|----------------------|------------|----------------------|------------|
| a initial : | 42164.2 km | a final : | 42164.2 km |
| e initial : | 0.14386612 | e final : | 0 |
| i initial : | 1.5 deg | i final : | 0 deg |
| ω initial : | 180 deg | ω final : | 180 deg |
| Ω initial : | 0 deg | Ω final : | 0 deg |
| Geographic longitude | 0 deg | Geographic longitude | 0 deg |
| Initial Mass: | 4415 kg | | |

2 computations have been made one with the non-perturbed dynamical model and one with the perturbed dynamical model. In the first case minimal time transfer is 179.37 days and in second case the transfer time increase to 181.28 days this increase is mainly due to luni-solar out of plane perturbation which impact inclination evolution.

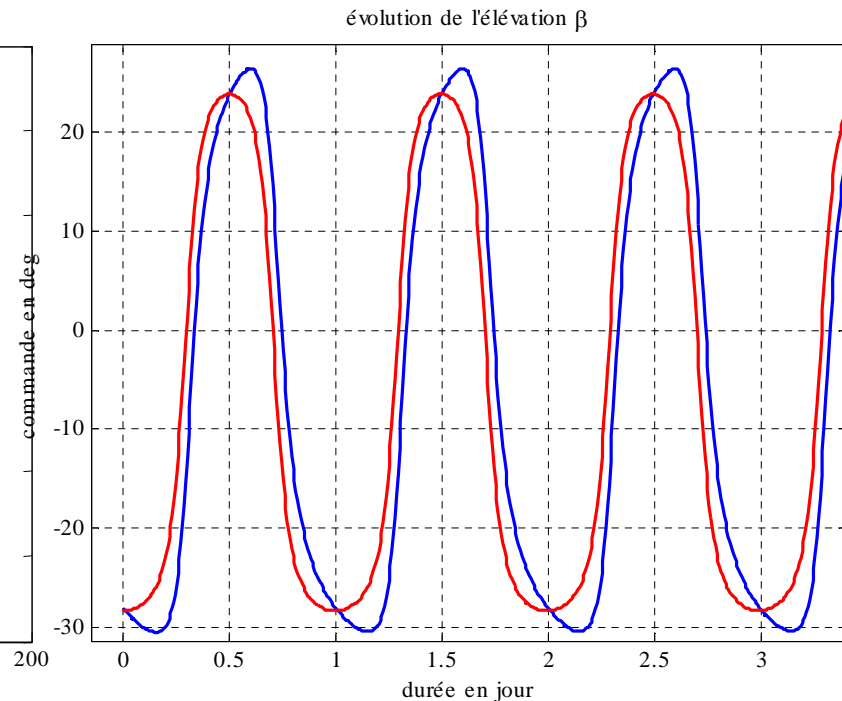
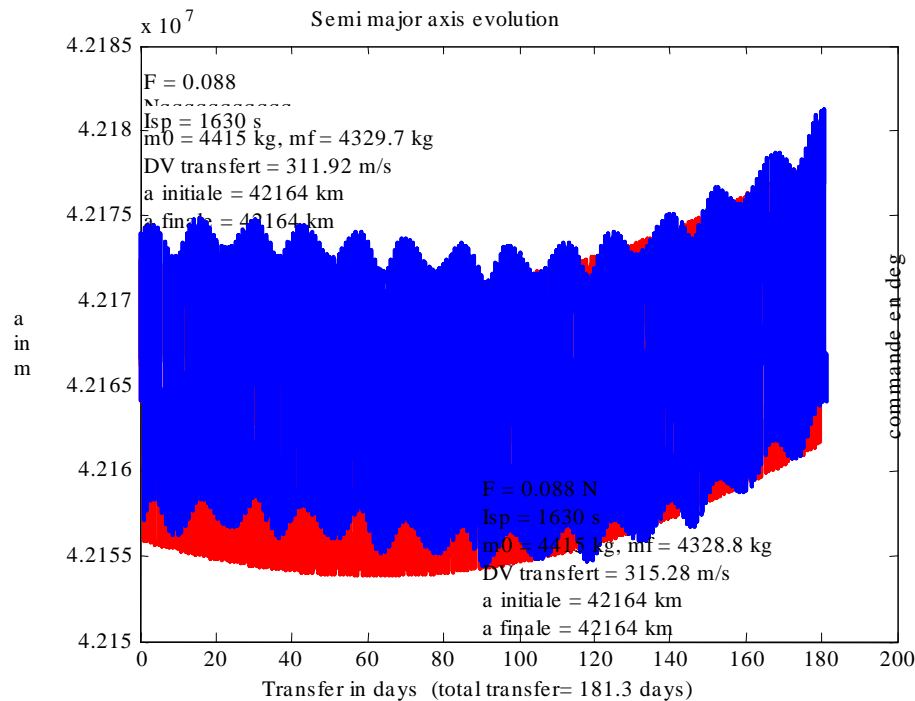

Earth Mars transfer:

- departure from the Earth the 25/12/2010 00:00:00 on a hyperbolic branch with $V_{inf} = 2000$ m/s and arrival at Mars the 20/05/2013 00:00:00 with $V_{inf} = 0$ after 877 days of travel.
- we compare the non-perturbed dynamic with one taking into account the Earth perturbation during the escape phase and also the solar pressure radiation. no perturbation of mars at arrival.

Satellite parameters:

- Initial mass 1000kg, Electrical motor thrust: 100mN, Isp: 1630s

The perturbation model is the following:

- Third body perturbation: Earth
- Solar pressure radiation with solar arrays surface of 100 m² visible surface absorptivity coefficient 0.7 and specular coefficient 1

| | | | |
|--------------------|-----------------------|------------------|-----------------------|
| a initial : | 165204029201.734 m | a final : | 227938895292.028 m |
| e initial : | 0.117101264348358 | e final : | 0.0932908435320234 |
| i initial : | 1.64381795799444 deg | i final : | 1.84866871626778 deg |
| ω initial : | 24.4606910019195 deg | ω final : | -73.4251633741487 deg |
| Ω initial : | 82.8009268548408 deg | Ω final : | 49.5245395633636 deg |
| ν | -13.8292850232281 deg | ν | 790.392105446095 deg |
| Mass: | 1000 kg | time: | 877 days |

The overall performance is quite similar:

- final mass of 763.21kg for the non-perturbed model and 760.276 kg for the perturbed model
- but the thrust profile present significant switching change this example show the need to re-optimize a classical patch-conic approach when using electrical propulsion if we want to catch a precise thrust profile

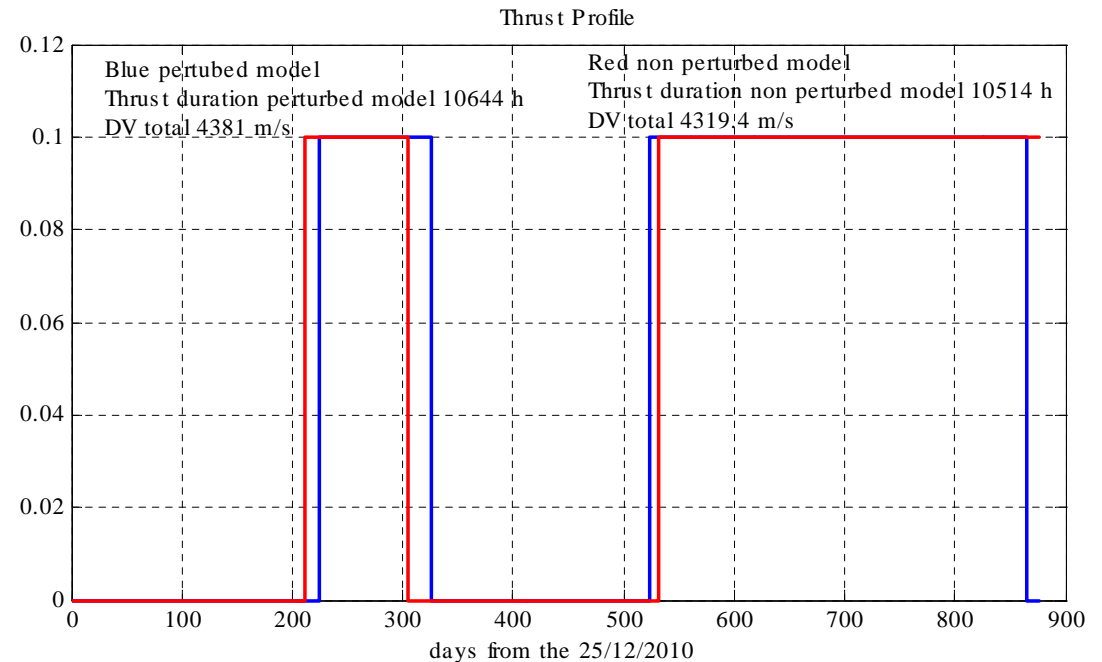
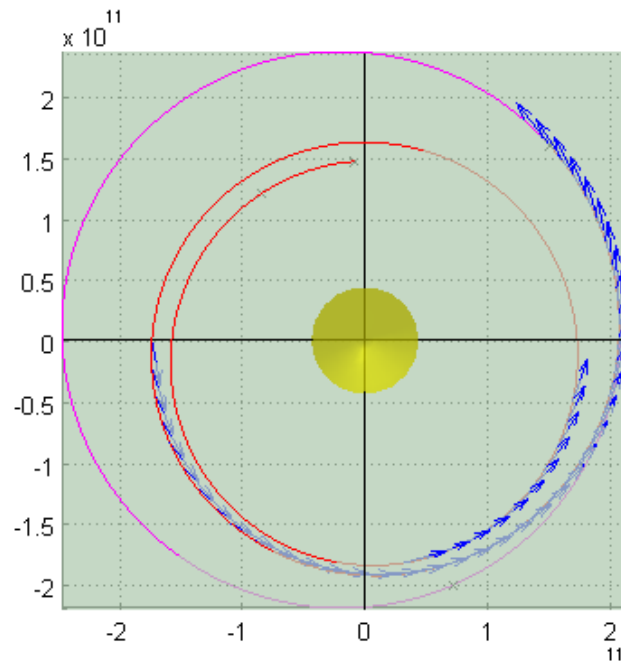

- Created by Mayne and Jacobson (1969), further developed by Yakowitz, Shoemaker, Whiffen...
- Rely on **Bellman's Principle of Optimality**

On an optimal solution, whatever the initial state and controls are, the remaining controls must constitute an optimal policy with regard to the state resulting from the first controls

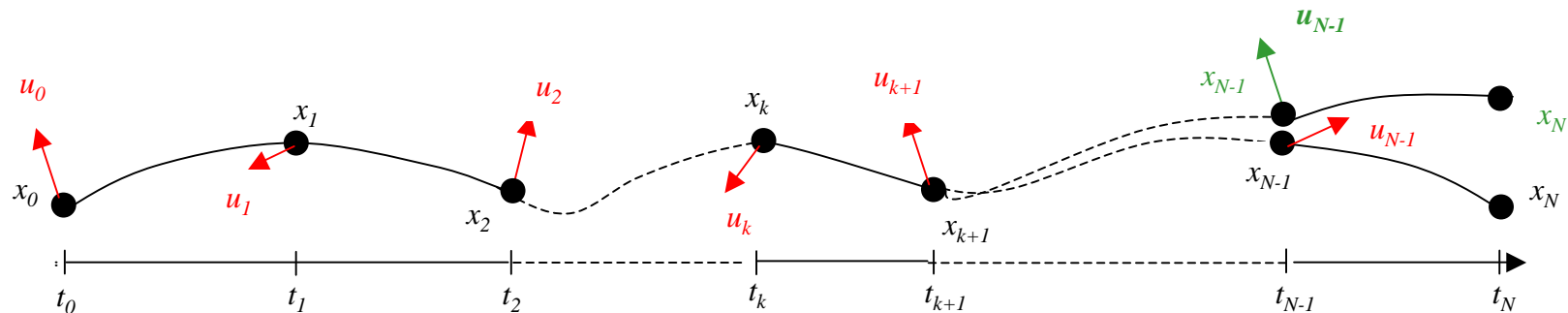

- DDP applies this principle in the neighbourhood of the current trajectory using **quadratic approximations** of the objective function

- DDP is a local method that applies Bellman's principle within a 'tube' of the current trajectory \rightarrow quadratic expansions of the objective function

$$\delta J_k \approx (\nabla_x^T J_k) \delta x_k + (\nabla_u^T J_k) \delta u_k + \frac{1}{2} \delta x_k^T (\nabla_{xx} J_k) \delta x_k + \frac{1}{2} \delta u_k^T (\nabla_{uu} J_k) \delta u_k + \delta x_k^T (\nabla_{xu} J_k) \delta u_k$$

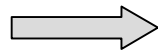

$$\delta u_k = -(\nabla_{uu} J_k)^{-1} (\nabla_u J_k) - (\nabla_{uu} J_k)^{-1} (\nabla_{ux} J_k) \delta x_k$$

- Main steps :

Initialization



Forward Sweep



Backward Sweep

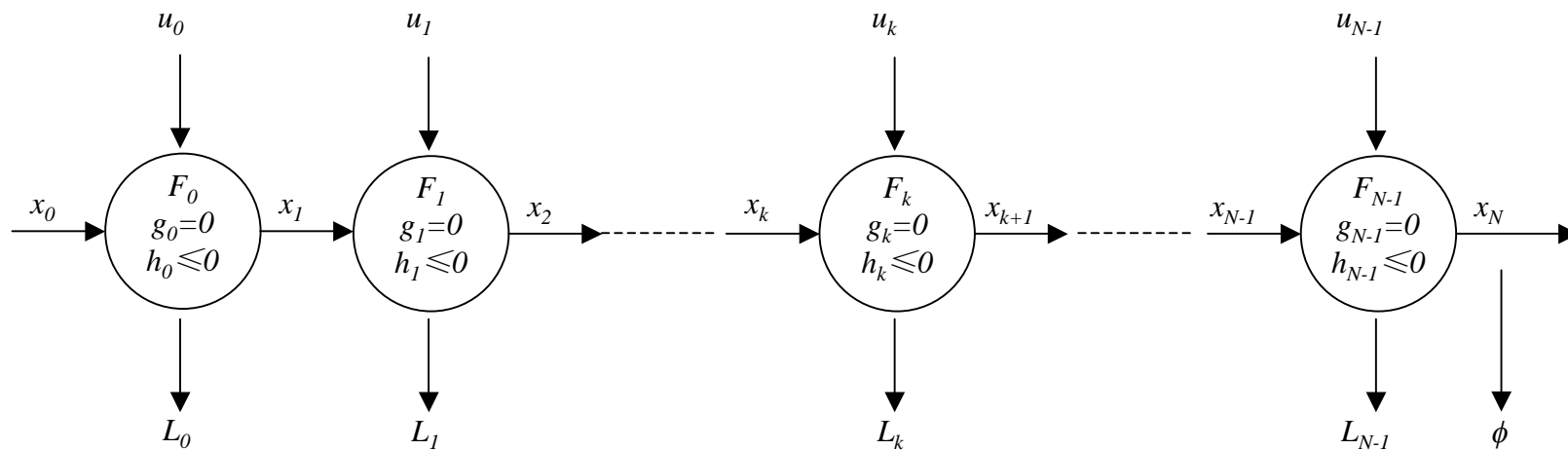

- DDP is a local method that applies Bellman's principle within a 'tube' of the current trajectory \rightarrow quadratic expansions of the objective function

$$\delta J_k \approx (\nabla_x^T J_k) \delta x_k + (\nabla_u^T J_k) \delta u_k + \frac{1}{2} \delta x_k^T (\nabla_{xx} J_k) \delta x_k + \frac{1}{2} \delta u_k^T (\nabla_{uu} J_k) \delta u_k + \delta x_k^T (\nabla_{xu} J_k) \delta u_k$$

$$\delta u_k = -(\nabla_{uu} J_k)^{-1} (\nabla_u J_k) - (\nabla_{uu} J_k)^{-1} (\nabla_{ux} J_k) \delta x_k$$

- Main steps :

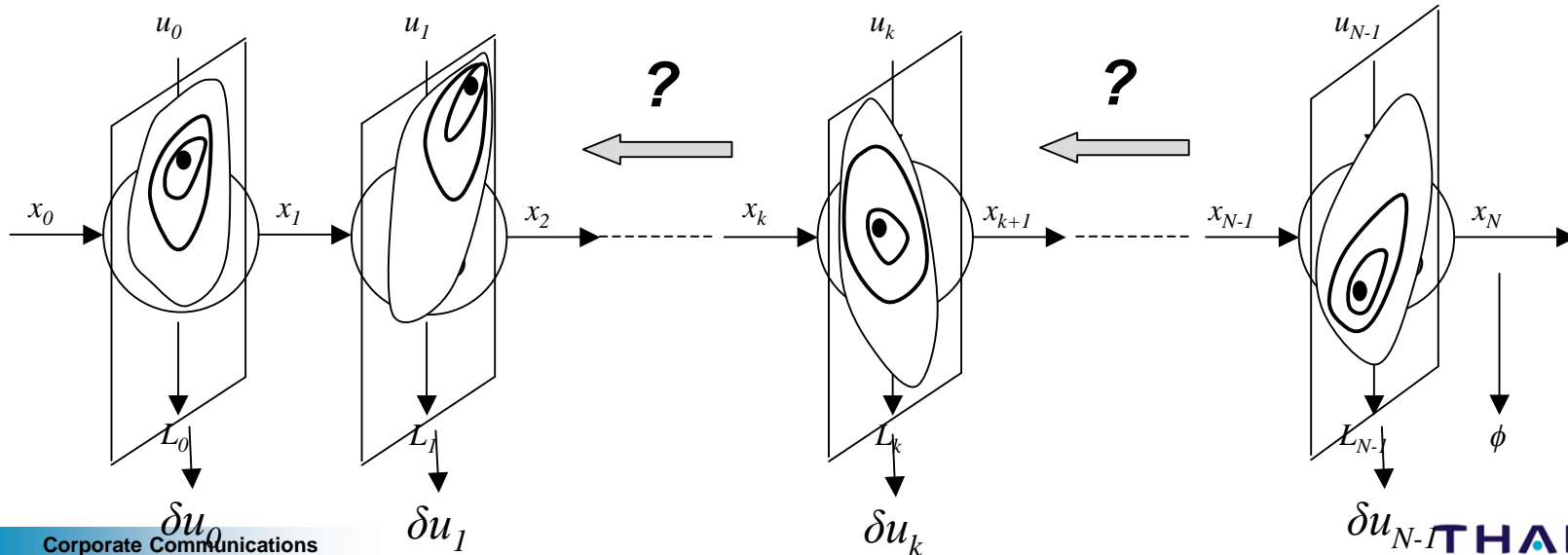

- Classical formulation integrates partials $J_x, J_{xx}, J_u, J_{uu}, J_{xu}$ using Riccati-like equations or integrate State-Transition Matrices (STMs)



computationally intensive !!



- Our formulation allows to use two-body analytic first- and second-order STMs: mapping the perturbations in the spacecraft state from one time to another



$$\begin{bmatrix} \mathbf{r}_{k+1} \\ \mathbf{v}_{k+1} \end{bmatrix} = \begin{bmatrix} f\mathbf{I} & g\mathbf{I} \\ \dot{f}\mathbf{I} & \dot{g}\mathbf{I} \end{bmatrix} \begin{bmatrix} \mathbf{r}_k \\ \mathbf{v}_k \end{bmatrix} \longrightarrow \begin{bmatrix} \delta\mathbf{r}_{k+1} \\ \delta\mathbf{v}_{k+1} \end{bmatrix} = \begin{bmatrix} \delta f\mathbf{I} & \delta g\mathbf{I} \\ \delta \dot{f}\mathbf{I} & \delta \dot{g}\mathbf{I} \end{bmatrix} \begin{bmatrix} \mathbf{r}_k \\ \mathbf{v}_k \end{bmatrix} + \begin{bmatrix} f\mathbf{I} & g\mathbf{I} \\ \dot{f}\mathbf{I} & \dot{g}\mathbf{I} \end{bmatrix} \begin{bmatrix} \delta\mathbf{r}_k \\ \delta\mathbf{v}_k \end{bmatrix}$$

Lambert solution

Analytical derivatives

- Effect of perturbations can be approximated

- Algorithm with analytic STMs is **three order of magnitude** faster than algorithm with numerical STMs

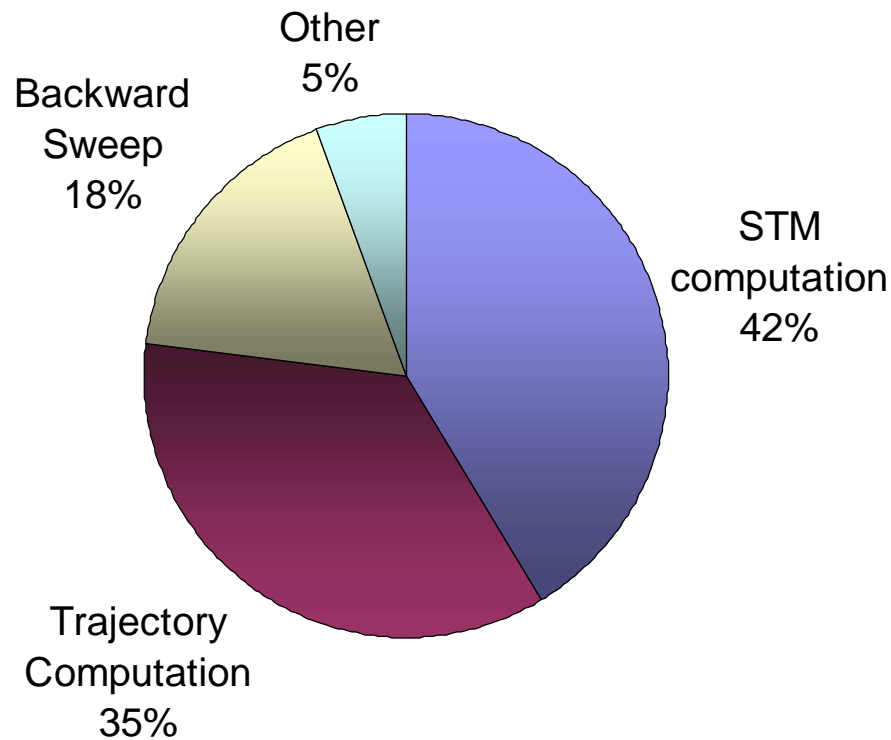

Analytic STMs

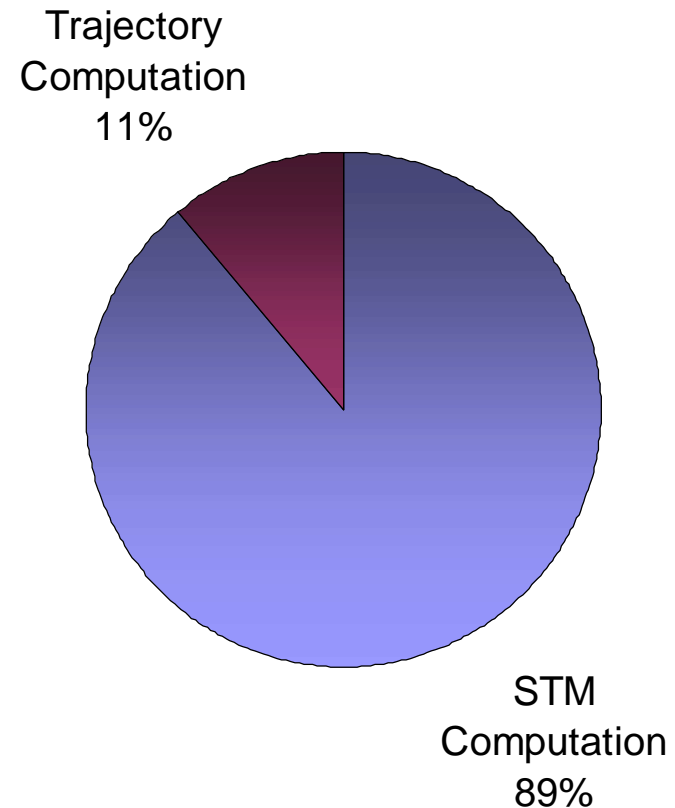

Numerical STMs

- Fuel minimization of a multi-rev LEO-GEO planar orbital transfer
- Perfect bang-bang structure revealed
- Good accuracy due to fine discretization

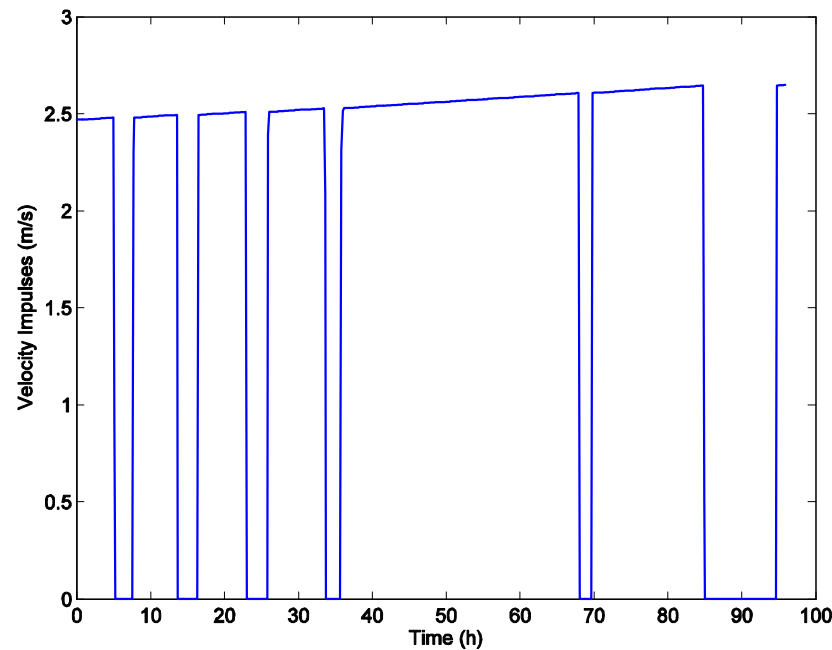

Time evolution of impulses

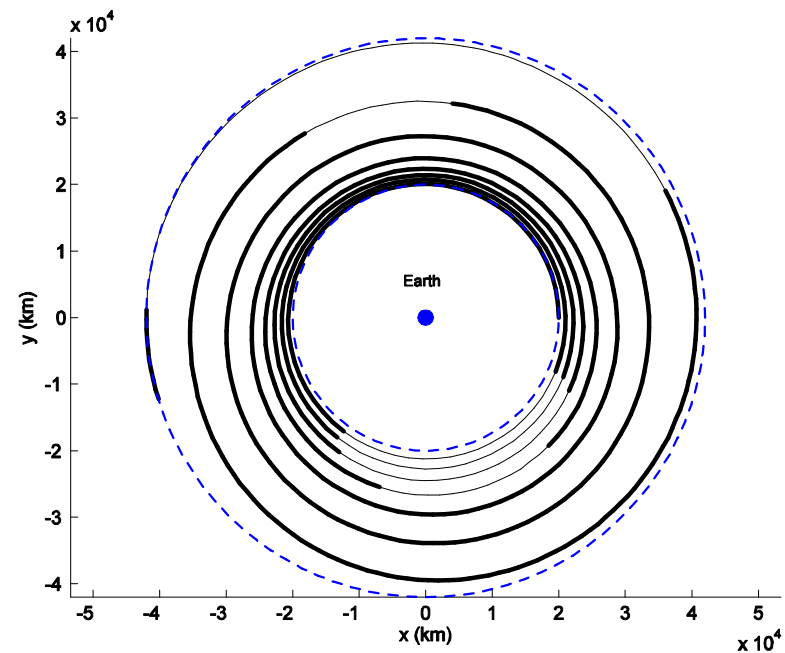

Planar trajectory of the problem

■ Nearly perfect match with the indirect solver T3D

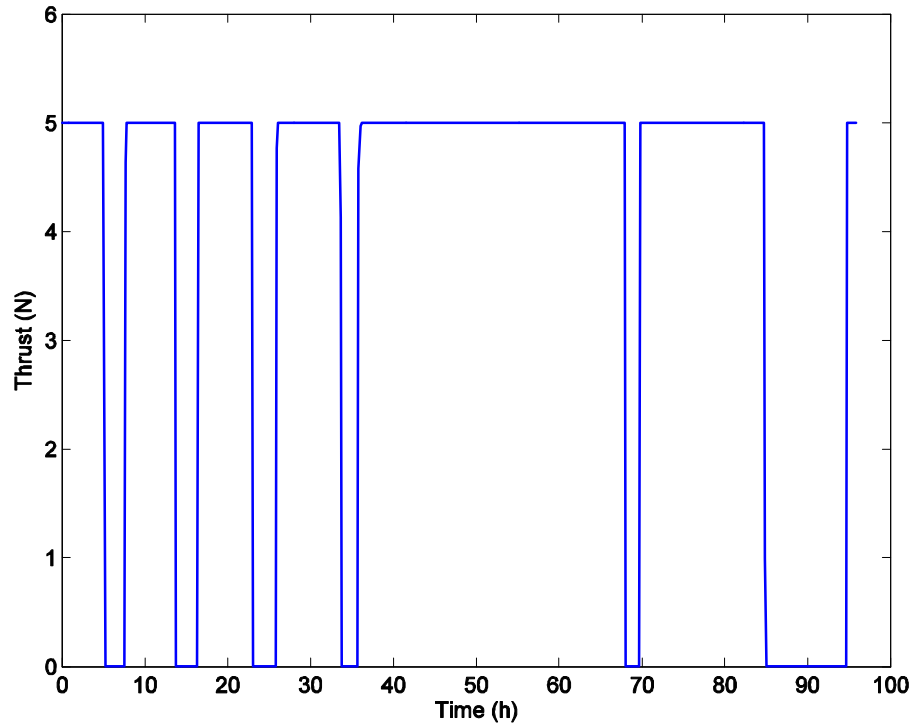

Analytical DDP solution

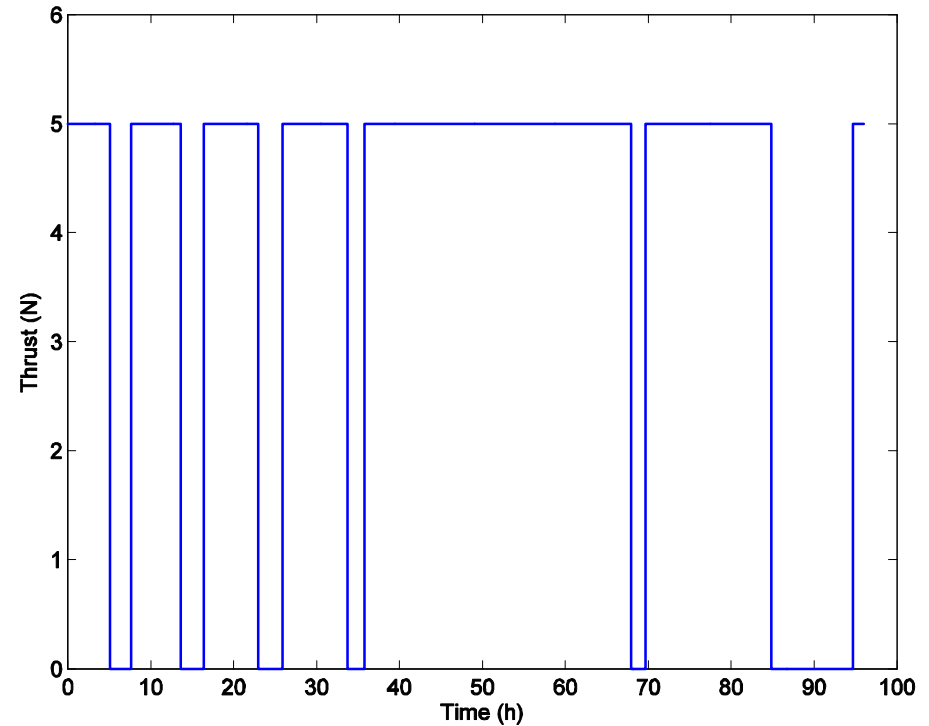

T3D solution



Algorithm validated

- A **fast** and **efficient** optimization algorithm was developed for low-thrust trajectories
- Based on Differential Dynamic Programming
- Discretization scheme with successive impulsive Δv 's
- Computational cost of STM computations is dramatically reduced through the use of **analytic STMs**
- Complex problems like multi-revolution trajectories become easily manageable

Optimization Framework overview

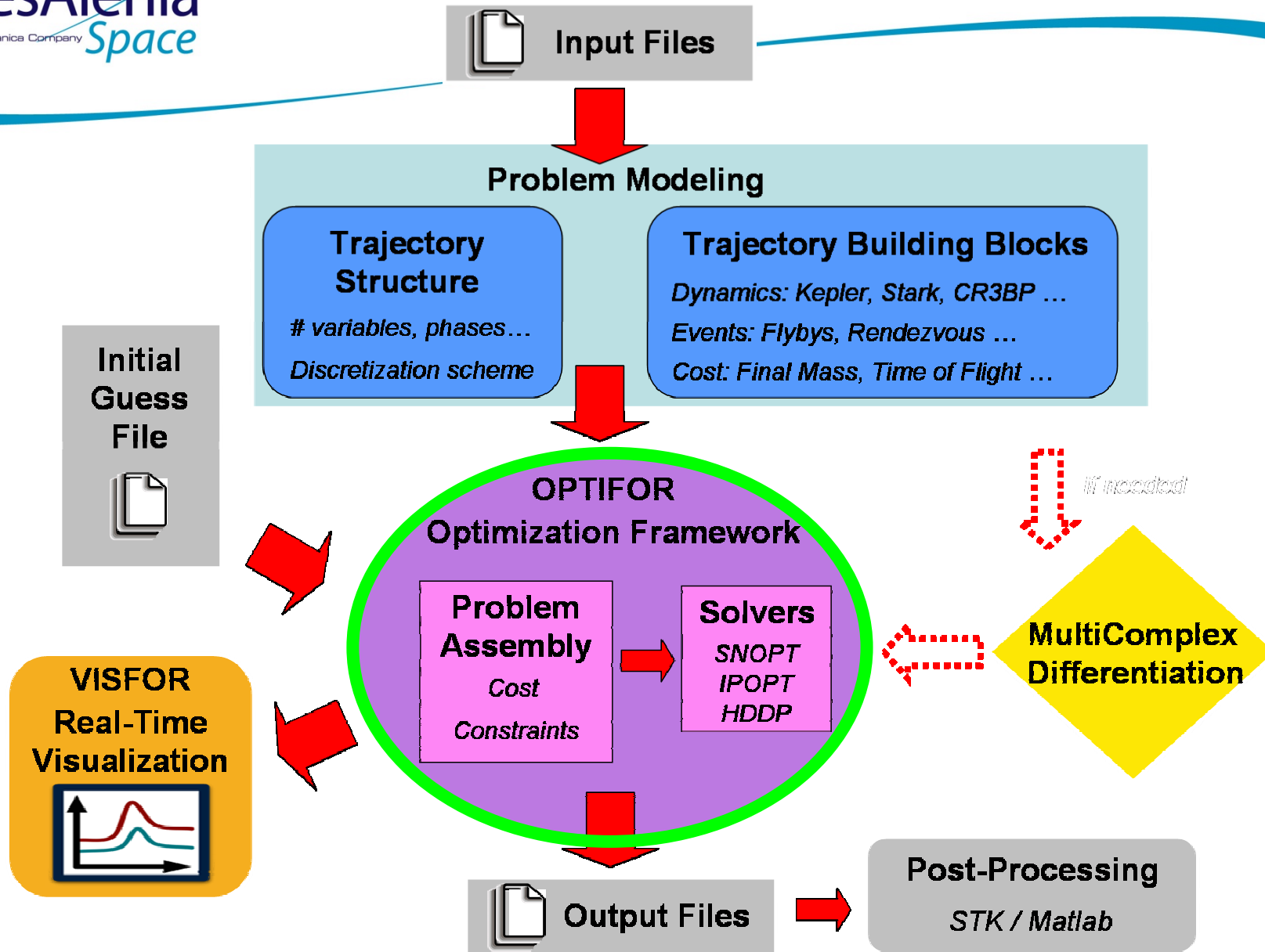

- Multi-phase formulation:
 - Trajectory is divided into phases connected by linkage constraints
 - Phases composed by stages, constraint and initial functions
 - One stage is characterized by propagation, constraint and cost functions

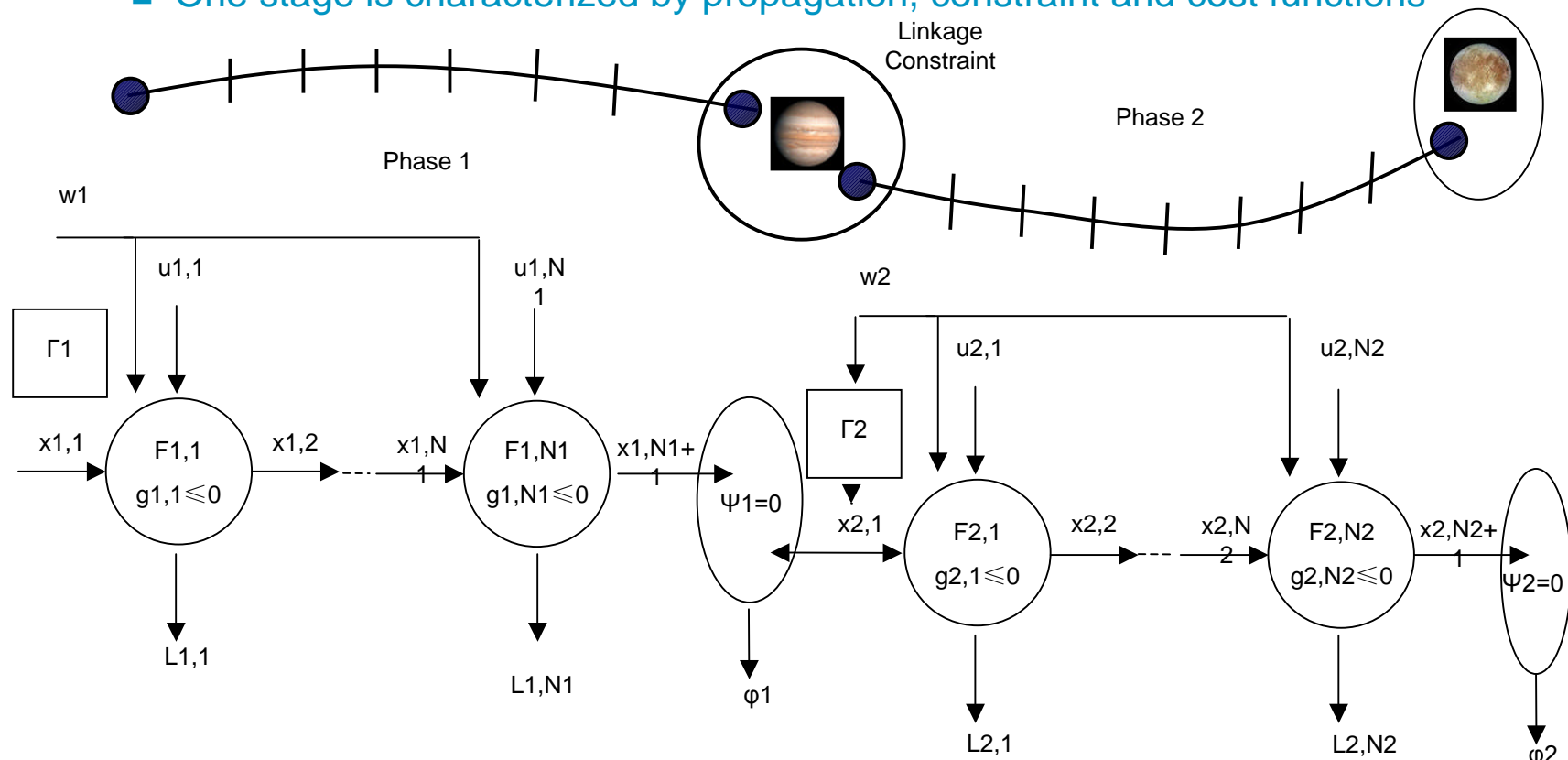

Optimal Control Problem

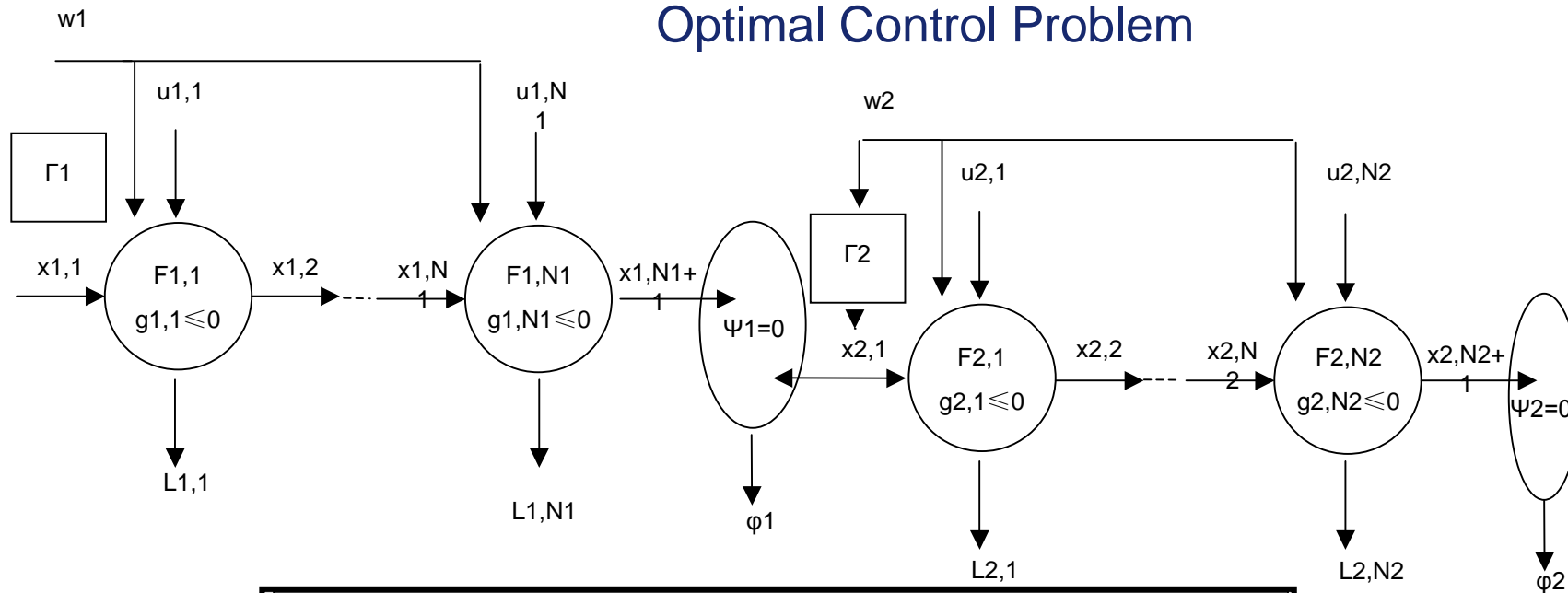

$$\min_{u_0, \dots, u_{N-1}} J = \sum_{i=1}^N \left[\sum_{j=1}^{M_i} (L_{i,j}(x_{i,j}, u_{i,j}, w_i)) + \varphi_i(x_{i,M_i+1}, w_i, x_{i+1,1}, w_{i+1}) \right]$$

subject to

$$\begin{cases} x_{i,1} = \Gamma_i(w_i), & x_{i,j+1} = F_{i,j}(x_{i,j}, u_{i,j}, w_i) \\ g_{i,j}(x_{i,j}, u_{i,j}, w_i) \leq 0 \\ \Psi_i(x_{i,M_i+1}, w_i, x_{i+1,1}, w_{i+1}) \leq 0 \end{cases}$$

- SNOPT and IPOPT = State-of-the-art general-purpose NLP Solver
 - Based on sequential quadratic programming
 - Interface is needed to account for our formulation
 - Take advantage of the sparsity structure of derivatives
 - Second-order derivatives can be provided to IPOPT
- HDDP (Hybrid Differential Dynamic Programming)
 - Based on DDP, created by Mayne and Jacobson (1969), further developed by Yakowitz, Shoemaker, Whiffen...
 - Rely on Bellman's Principle of Optimality
 - DDP applies this principle in the neighborhood of the current trajectory using quadratic approximations of the objective function



Thank you !