



HAL
open science

DVB-T2 Simulation Model for OPNET

Adlen Ksentini, Yassine Hadjadj-Aoul

► **To cite this version:**

Adlen Ksentini, Yassine Hadjadj-Aoul. DVB-T2 Simulation Model for OPNET. [Research Report] PI 1967, 2011, pp.17. inria-00567546

HAL Id: inria-00567546

<https://inria.hal.science/inria-00567546v1>

Submitted on 21 Feb 2011

HAL is a multi-disciplinary open access archive for the deposit and dissemination of scientific research documents, whether they are published or not. The documents may come from teaching and research institutions in France or abroad, or from public or private research centers.

L'archive ouverte pluridisciplinaire **HAL**, est destinée au dépôt et à la diffusion de documents scientifiques de niveau recherche, publiés ou non, émanant des établissements d'enseignement et de recherche français ou étrangers, des laboratoires publics ou privés.

DVB-T2 Simulation Model for OPNET

Adlen Ksentini^{*}, Yassine Hadjadj-Aoul^{**},
Adlen.Ksentini@irisa.fr, Yassine.Hadjadj-aoul@irisa.fr

Abstract: DVB-T2 is offering a new way for broadcasting value-added services to end users, such as High Definition (HD) TV and 3D TV. Thanks to the advances made in digital signal processing, and specifically in channel coding, DVB-T2 brings an increased transfer capacity of 50% and a new flexibility in services' broadcasting in contrast with the first generation DVB-T standard. As DVB-T2 is still in deployment's test, simulation model could be an interesting way to evaluate the performance of this network in supporting new value-added services. In this paper, we describe the new features and enhancements we have integrated within the DVB-T2 module in OPNET, and in particular: (i) a realistic physical model;(ii) an MPEG-TS layer with an IP encapsulator;(iii) hierarchical application layer ables to use pcap traces to simulate real video traces. Also, we include an extensive simulation campaign in order to well understand the performance of DVB-T2 networks.

Key-words: DVB-T2, Simulation, OPNET, Performance Evaluation

Modèle de simulation des réseaux DVB-T2 pour OPNET

Résumé : *DVB-T2 est entrain de devenir le nouveau standard de diffusion de services à forte valeur rajoutée, tel que la télévision haute définition ou la télévision en 3D. Capable d'adresser les stations fixes et mobiles ce qui est largement favorisé par l'augmentation des débits physiques, où on atteint un gain de 50% par rapport au standard précédent DVB-T. Du fait que le DVB-T2 est en cours de test et de déploiement, il est nécessaire de disposer d'un modèle de simulation pour évaluer les performances de ces réseaux et leurs capacité à supporter ces nouveaux services. Dans cet article, nous décrivons les nouvelles fonctionnalités ainsi que les améliorations effectuées pour intégrer un modèle de simulation dans OPNET, et particulièrement : (i) une couche physique réalistique;(ii) la couche MPEG-TS avec un encapsulateur IP; (iii) une couche application capable de lire des traces pcap pour simuler des flux vidéo. De plus, nous présentons une étude détaillée des résultats de simulations pour différents scénarios, fixe et mobile.*

Mots clés : *DVB-T2, Simulation, OPNET, évaluation de performances*

This work is supported by the FUI'9 SVC4QoE project

^{*} Projet Dionysos : équipe commune INRIA, CNRS, ENS, INSA et université de Rennes 1

^{**} Projet Dionysos : équipe commune INRIA, CNRS, ENS, INSA et université de Rennes 1

1 Introduction

DVB-T2 [1] is the second generation standard for digital terrestrial television broadcasting. Thanks to the advances made in digital signal processing, and specifically in channel coding, DVB-T2 brings an increased transfer capacity of 50% and a new flexibility in services' broadcasting when compared to the first generation DVB-T standard published in 1997.

To allow a high robustness against multipath propagation, DVB-T2 uses a Coded Orthogonal Frequency Division Multiplexing (COFDM) multi-carrier modulation, in a similar way to DVB-T. A wider range of schemes is proposed, from 1K carrier up to 32K carrier, to meet the requirements of a wide range of receiving situations (fixed and mobile) and network topologies (single and multiple frequency networks). In terms of channel coding, DVB-T2 uses Low Density Parity Check (LDPC) block codes and Bose-Chaudhuri-Hocquenghene (BCH) coding, which provide more robust error correction than the convolutional and Reed Solomon encoding used in DVB-T. Most of the capacity gain of DVB-T2 comes from this fundamental change of channel coding.

The DVB-T2 physical layer data channel is divided into logical entities called the Physical Layer Pipes (PLP). Each PLP carries one logical data stream. Examples of such a logical data stream, would be an audio-visual multimedia stream along with the associated signaling information, or an hierarchical application streams, which can address at the same time different qualities as it is the case for Scalable Video Coding (SVC) [2]. The PLP architecture is designated to be flexible so that arbitrary adjustments of robustness and capacity can be easily done. Thus, using different PLP enable broadcasting of multiple services or groups of services with separate channel coding and modulation settings on a single radio channel. Broadcasting several service components over the same channel is thus made possible, with differentiated levels of robustness, which was not possible with the previous DVB-T standard. Regarding the upper layers, the DVB-T2 provides two main IP encapsulation protocols, the MPEG-TS [3], packetization, which has been the classical encapsulation scheme for DVB services, and the Generic Stream Encapsulation (GSE) [4], which was designated to provide appropriate encapsulation for IP traffic.

Simulation tools, meanwhile, are a good mean to evaluate the performance of a system in different conditions. This is also useful to dimension a system and optimize its performance, which represent an interesting issues, particularly for DVB-T2 network as it is still in test. OPNET [5], on the other hand, is one of the leading network simulators that provides powerful simulation capability for testing networks architectures and protocols. Reader can refer to [6], for an interesting comparison of several computer simulations, with a brief focus on OPNET.

In this work, we describe the features and enhancements we added to support DVB-T2 simulation in OPNET. The most important features we introduced are: (1) a realistic physical layer that uses measured Bit Error Rate (BER) versus Signal-to-Noise Ratio (SNR) traces for different modulation schemes; (2) MPEG-TS layer, with an IP encapsulator based on Unidirectional Lightweight Encapsulation (ULE) [7]; (3) an application layer that supports hierarchical streams, and associates each stream with a PLP. Also, the developed application layer is able to parse pcap traces to simulate real video traffics. The purpose of this simulation model is to enable the evaluation, in a realistic environment, the capacity of DVB-T2 to support new services, such as High Definition video broadcast, for both fixed and mobile receivers. To the best of our knowledge this is the first simulator platform for DVB-T2 networks. Further, this DVB-T2 simulation model could be extended easily to simulate DVB-H, which shares many features with DVB-T2 (only the physical layer that needs modification).

This paper is organized as follow: section 2 presents the details of the developed DVB-T2 chain in OPNET. In section 3, we show simulation results obtained for the fix and the mobiles scenarios. We conclude this paper in section 4.

2 DVB-T2 OPNET Model

2.1 Model Overview

To simulate and evaluate the performance of DVB-T2 network, we have developed new features and enhanced other features available in OPNET. The proposed model is able to simulate the entire DVB-T2 chain, by including models for the DVB-T2 broadcast gateway (transmitter) as well as fixed and mobile receivers. Each entity includes the IP/ULE/MPEG-TS/PLP transmit/receiver capability as showed in Figure 1. Herein, we describe in details the design and implementation of the proposed features to support DVB-T2 in OPNET.

2.2 The Physical Layer

Radio links provide a broadcast medium; each transmission can potentially affect receivers throughout the network model. Besides, for a given transmission, the radio link of each receiver can exhibit different behavior and timing. The Radio Transceiver proposed in OPNET consists of fourteen stages, most of which must be executed on a per-receiver basis whenever a transmission occurs. The transceiver pipeline stages, shown in Figure 2, are a series of software blocks that perform all the wireless physical layer operations.

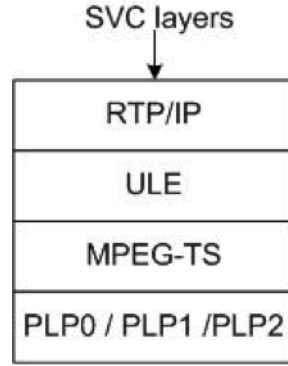

Figure 1: Layered DVB-T2 model OPNET

Whenever OPNET needs to simulate a wireless transmission it has to execute the fourteen-stage radio transceiver pipeline. Most of these fourteen stages must be executed on a per-receiver basis. However, stage 0 is invoked only once for each pair of transmitting and receiving channels in the network. This is done to establish a static binding between each transmitting channel and the set of receiving channels that it is allowed to communicate with. Stage 1 is used to compute a result that is common to all destinations, and therefore can be executed just once per transmission. Finally each individual pipeline sequence might not be fully complete, depending on the result of stage 2, because this stage is responsible of determining if the communication between the transmitter and receiver is possible on a dynamic basis. Similarly, stage 3 might classify a transmission as irrelevant with regard to its effect on a particular receiver channel, thereby preventing the pipeline sequence from reaching the final stages.

The stages from 9 to 12 are invoked to evaluate the performance of the link according to changes in the signal condition. The main modification we added to this model, are both in stage 7 and 11, received power and Bit Error Rate stages, respectively. For more information on the different stages that are not covered in this paper, readers can refer to [5].

2.2.1 Receiver Power Stage

Usually, this stage is dedicated to calculate the received power of the arriving packet signal in watts. This calculation depends on the distance separating receiver and transmitter, the power of the transmitter, the transmission frequency, and transmitter and receiver antenna gains. As the final stage of the computation of the receiver carrier power, the transmitter and receiver antenna gains are extracted from previous stages. Since the antennas gain is given in decibels they must be converted to a non-logarithmic form and then they are multiplied with the other variables of the link budget (transmission power, transmitter antenna gain, receiver antenna gain and path loss). In this stage, the path loss is computed. It depends on the propagation model. For the proposed simulation model we decided to exploit different propagation models, which allow representing different parameters that impact the wave propagation, such as terrain model, city model (urban or sub-urban or open), mobility, Line-Of-Sight (LOS) or No (LOS) communication.

The following models are available in Opnet:

- Free Space model (Gaussian Channel): this model represents a signal propagating through open space with no environment effects. It depends on the power used to transmit the signal and the distance between the transmitter and receiver. This is the simplest way to compute the path loss. It does not consider the effect of terrain or obstacles. It use the following formula to derive the received power.

$$P_r = \frac{P_t G_t G_r \lambda}{(4\pi)^2 d^2 L} \quad (1)$$

where P_r , P_t , G_t and G_r represent, respectively the received signal power, the transmitted signal power, the gains of the receiving and the transmitting antennas. λ is the wave length, L is the system loss, and d is the distance between the transmitter and receiver.

- Longly Rice model: this model is a very detailed model that was developed in the 1960s and has been refined over the years. The model is based on data collected between 40MHz and 100GHz, at ranges starting from 1 to 2000km, and using antennas with heights ranging from 0.5 to 3000m, and for both vertical and horizontal polarization. The model accounts for terrain, climate, and subsoil conditions and ground curvature. Longly Rice model has two modes,

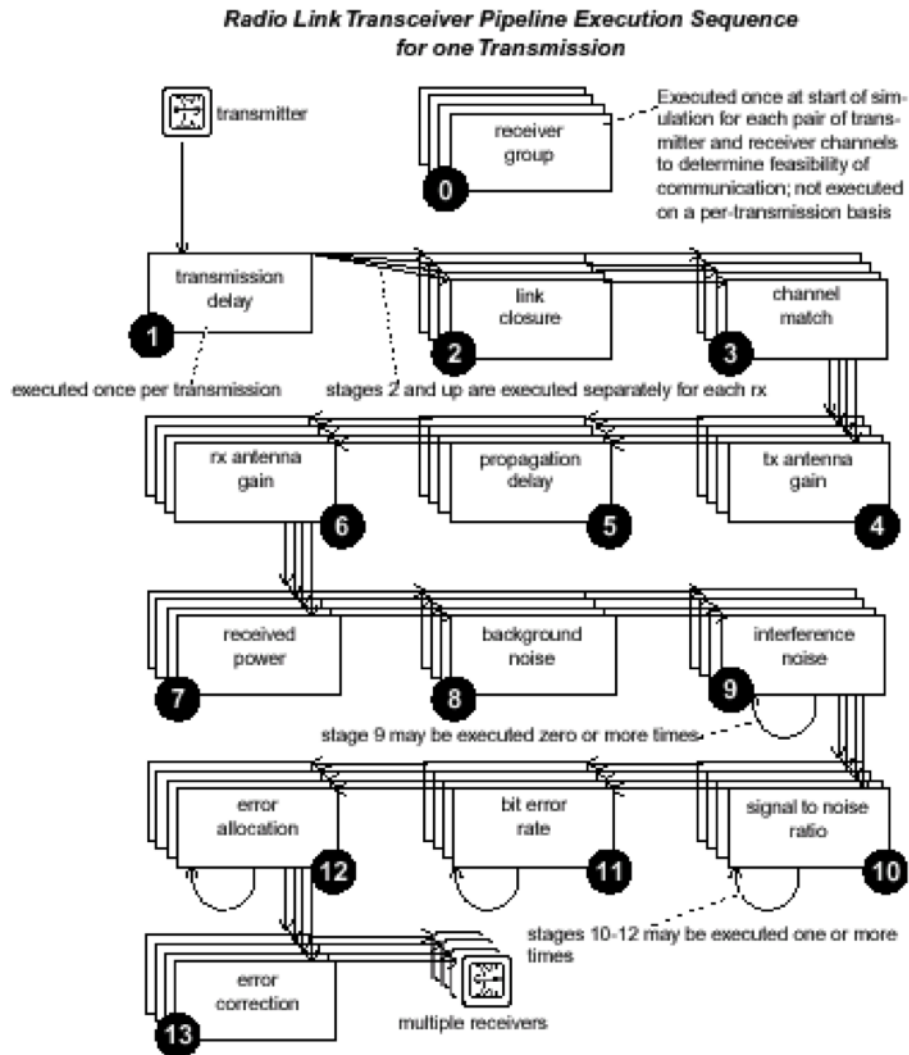

Figure 2: The radio Transceiver execution sequence for one transmission

point-to-point and area. The point-to-point mode makes use of detailed terrain data or characteristics to predict the path loss, whereas the area mode uses general information about the terrain characteristics to predict the path loss.

- **HATA model:** The Hata model (sometimes called the Okumura Hata model) is an empirical formulation that incorporates the graphical information from the Okumura model [8]-[9]. For the Hata model, the prediction area is divided into terrain categories: open area, suburban area, and urban area. The open area model represents locations with open space, no tall trees or buildings in the path, and the land cleared for 300m – 400m ahead (i.e., farmland). The suburban area model represents a village or a highway scattered with trees and houses, some obstacles near the mobile, but not very congested. The urban area model represents a built-up city or large town with large buildings and houses with two or more stories, or larger villages with close houses and tall thickly grown trees. The Hata model uses the urban area as a baseline and then applies correction factors for conversion to other classifications. There are three different formulas for the Hata model: for urban areas, for suburban areas, and for open areas. For instance, the following formula presents the Urban area:

$$L_{50}(db) = 69.55 + 26.16\log(f_c - 13.84\log(h_t - a(h_t) + [44.9 - 6.55\log(h_t)]\log(d)) \quad (2)$$

where f_c , h_t , $a(h_r)$ and d represent, respectively, the transmission frequency, the transmitter antenna height, the receiver antenna height and the distance.

- **CIR model:** this model (originally published by Comité Consultatif International des Radio communications) is a simplified version of the Hata model. It has one parameter: the Building Percentage, which represents the percentage of area covered by buildings.

In most environments, the path loss is sufficiently variable that it must be characterized statistically. This is particularly true for mobile communications where either or both terminals may be moving (changing the relative geometry) and where both are using wide-angle or omnidirectional antennas. Multipath models vary depending upon the type of considered environment and the involved frequencies. While detailed databases of most urban areas are available, statistical modeling based on empirical data (oftentimes fitted to specific empirical data) is still the method of choice. One exception is the planning of fixed LOS links, which can be facilitated by geometric multipath computations using urban databases. To this end, we added the possibility to simulate fading power envelop channel by using Ricean or Rayleigh models. In fact, the probability of various fade depths depend upon the characteristics of the multipath environment. When there are a sufficient number of reflections present and they are adequately randomized (in both phase and amplitude), it is possible to use probability theory to analyze the underlying probability density functions (pdf) and thereby determine the probability that a given fade depth will be exceeded. For the NLOS case, where all elements of the received signal are reflections or diffraction components and no single component is dominant, the analysis draws on the central limit theorem to argue that the in-phase and quadrature components of the received signal will be independent, zero-mean Gaussian random variables with equal variance. In this case, the pdf of the received signal envelope will be a Rayleigh random variable. Using the Rayleigh pdf, the analyst can then determine the probability of any given fade depth being exceeded. It is also possible to optimize the system detection and coding algorithms for Rayleigh fading rather than for Gaussian channel. On the other hand, if there is an LOS component present or if one of the reflections is dominant, then the envelope of the received signal is characterized by a Ricean pdf, rather than a Rayleigh. The determination of the probability of a fade is a little more complicated when the Ricean pdf is used, but it is still tractable.

To obtain more realistic physical layer for DVB-T2, we adapted the Ricean and Rayleigh models presented in [10] for OPNET 10.0 (we use for this simulation OPNET 14.5). In [10] the authors present a simple method of modeling small scale Ricean (or Rayleigh) fading. Small scale fading is caused by movement of the transmitter/receiver, or of other objects in the environment. This motion can be characterized by the Doppler spreading. Fading can be modeled by using frequency-domain random numbers with appropriate statistics and then applying time-correlation by performing spectral shaping on these data using the Doppler spread. Note that, a dataset containing the component of time-sequenced fading envelope is pre-computed. The parameters to be adjusted are time-average power P , the maximum Doppler frequency and the Ricean k factor. For Rayleigh model $k = 0$.

2.2.2 Bit Error Rate stage

The purpose of this stage is to derive the probability of bit errors during the interval of the SNR. This is not an actual rate of bit errors, but the expected rate, which is usually based on the SNR and also depends on the type of modulation used for the transmitted signal.

The process is as follows: the simulator kernel extracts, first, the SNR calculated on stage 10 and adds it to the processing gain to obtain the effective SNR. Then the effective SNR is converted from the log scale and expressed as E_b/N_0 . Where: E_b

Figure 3: 16 QAM BER vs. E_b/N_0 

Figure 4: Transmitter Model

is the received energy per bit (in joules), N_0 is the noise power spectral density (in *watts/hertz*). Then the bit error rate is derived from the effective SNR based on a modulation curve assigned to the receiver. Figure 3 shows the modulation curves with different FEC protections used in the simulation model for DVB-T2. They are based on real traces obtained through a real DVB-T2 decoder. It represents the BER versus the E_b/N_0 for different modulation techniques as well as different FEC protection. Note that, these values are obtained after low Density Parity Check (LDPC) and before Bose-Chaudhuri-Hocquenghene (BCH) correction. From Figure 3 we see clearly that higher is the FEC protection, higher is the robustness of the physical modulation. For instance, only 3db is necessary to decode the physical signal, in case of 16QAM1/2 (2bits sent for 1bit for FEC). For low protection (16QAM5/6), 6db is necessary to begin to decode the signal.

3 Transmitter Model (DVB-T2 Gateway)

Figure 4 presents the transmitter model. This model consists of the application source, the data splitter, the MPEG-TS layer (including the IP encapsulator) and the physical layer.

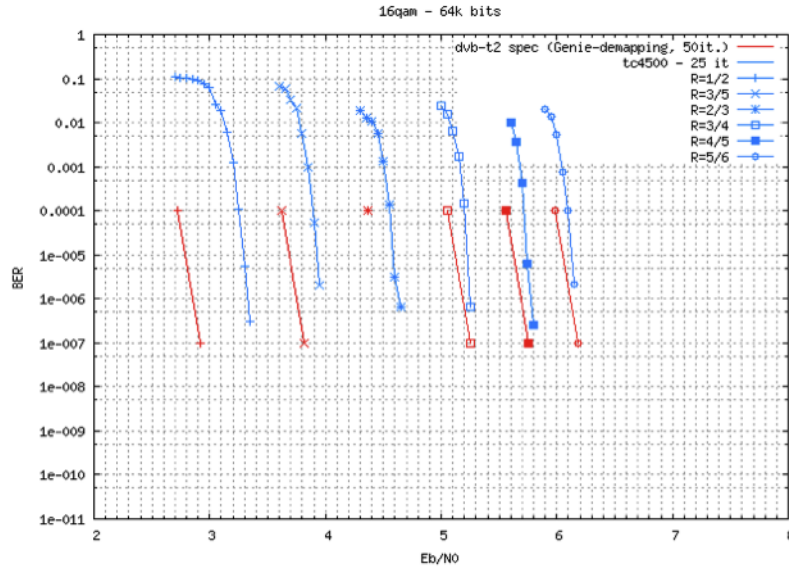
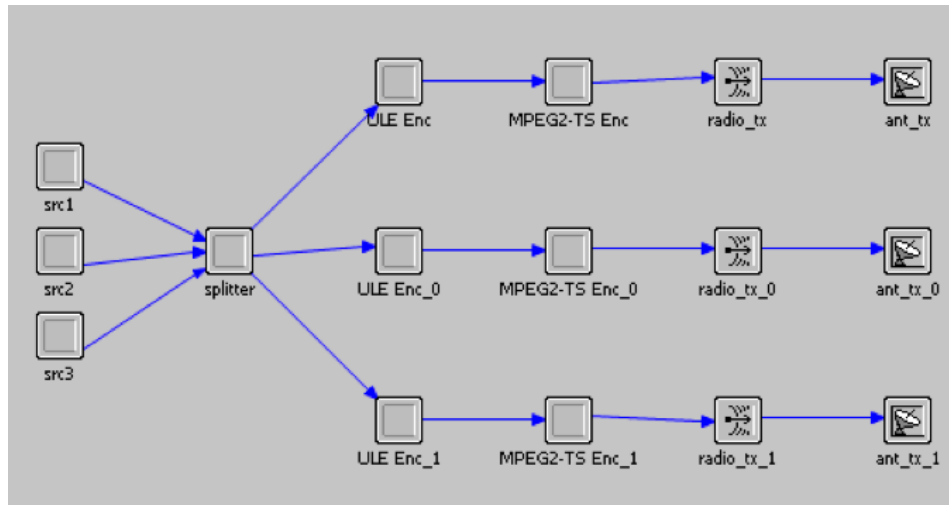
In this model, the physical layer is using three physical layer pipelines (PLP) (the number of PLP is not fixed, it can be extended to n PLP); each PLP has its own physical modulation and FEC protection. To configure one PLP, we have to extend its attributes as shown in Figure 4. Thus, it is possible to define the available physical modulations (16QAM1/2, 64QAM3/5,

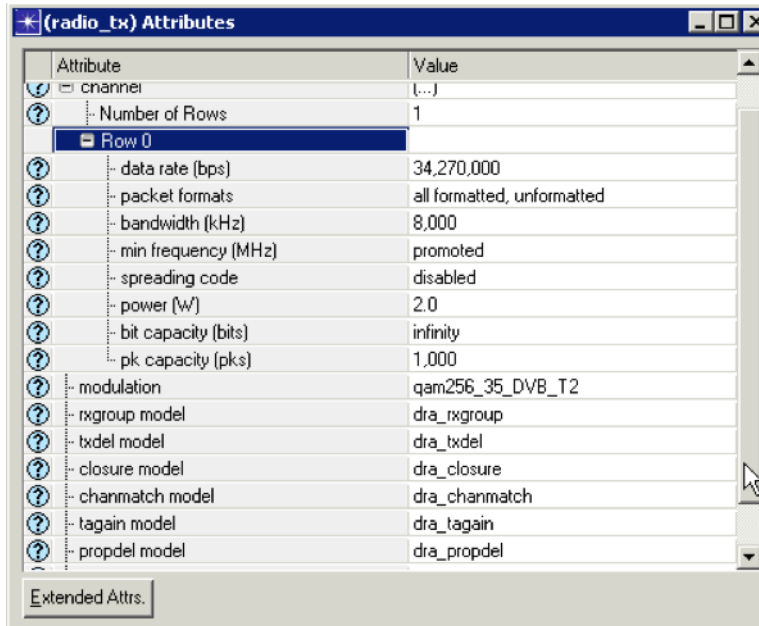

Figure 5: Radio Transmitter Configuration

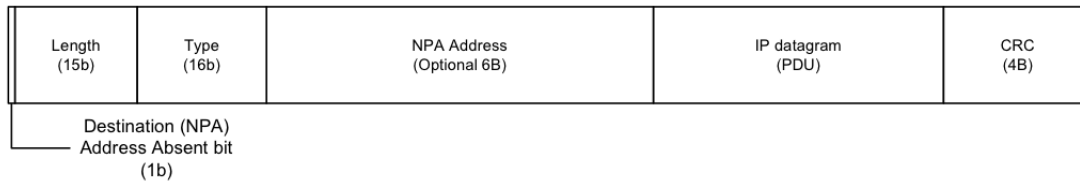

Figure 6: ULE packet format

256QAM3/4, 256QAM3/5 and QAM5/6), the frequency, data rate and the power of transmission for each PLP. Concerning the application, there is three sources attached to the splitter, which represents, for instance, three applications sources (audio/video), or one scalable application like SVC. The main functionality of the splitter is to redirect each application layer data to its associated PLP. Then these data are fragmented (if they exceed the 1500Bytes) in IP packets. To transmit an IP packet in the DVB chain, ULE encapsulation is used. Therefore, each IP packet is encapsulated in ULE packet. Here, it is important to note that the standard way to carry IP datagrams over MPEG2-TS are multiprotocol Encapsulation (MPE) [11] and ULE. The MPE encapsulation adds an overhead to each IP packet. The amount of overhead is a function of the size and timing of the IP packets being sent. MPE provides a range of encapsulation options leading to 4 basic header formats, ranging in size from 16Bytes to 44Bytes. ULE was proposed by the IETF to encapsulate IP in MPEG-TS stream. ULE reduces the basic MPE header from 16Bytes to 8Bytes (see Figure 6). It adds some of the functionality missing from MPE, such as a method for mapping IP addresses to TS Packet IDs (PIDs). This offers a great degree of flexibility, offering support for IPv6 and features such as IP, TCP and IP, UDP, RTP header compression, without the penalties associated with the addition of an LLC/SNAP (Link Layer) header. The new encapsulation employs TS Packet Packing and will only pad TS Packets if there is no data to transmit. The current proposal for the ULE base header contains a 2 – bytes length field, a 2 – bytes type field and a 4 – bytes CRC-32 field. This header is significantly smaller and less complex than the MPE header.

An alternative to MPEG2 TS, for encapsulating IP packets, is Generic Stream Encapsulation (GSE). GSE encapsulation reduces the overhead by a factor of 2 to 3 times when compared to MPEG-TS. However, GSE is not well deployed in the DVB-T2 products. For this simulation model we decided to implement the ULE encapsulation mechanism, since it reduce overhead and ensure more functionalities than MPE.

Each ULE packet is then sent to the MPEG-TS layer. This layer will fragment each ULE Packet into different MPEG-TS packets. The size of MPEG-TS packet is 188Bytes. After that, these packets are directed to the PLP, which transmit them over the radio channel.

Note that, each PLP is associated with an antenna. The same antenna model is used by the three PLPs. The antenna model used for transmission is an Omni directional antenna.

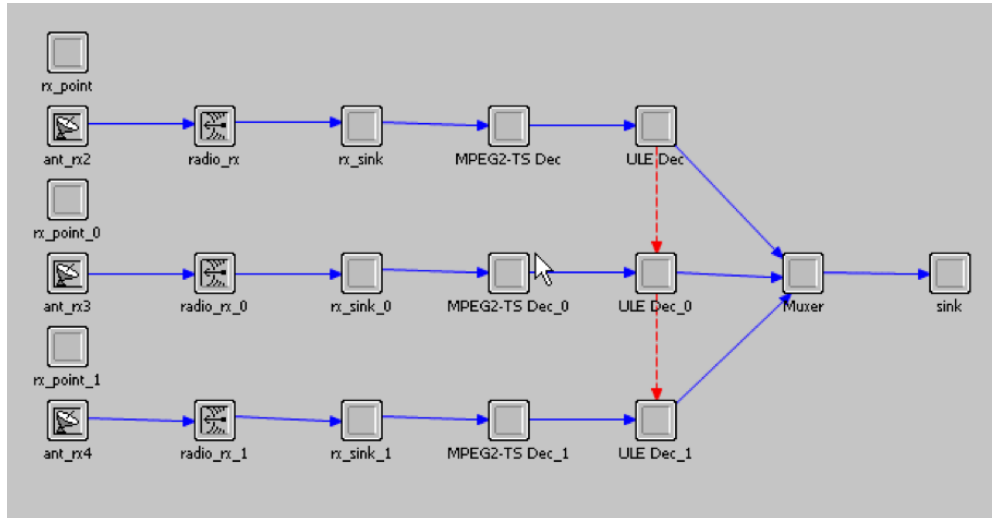

Figure 7: Receiver Model

4 Receiver Model

Figure 7 shows the receiver model. It is used either by fixed or mobile stations. This model is asymmetric to the transmitter model, it is constituted by the same layers (application, MPEG-TS and physical layer). The radio receiver (PLP) begins by receiving the broadcasted frame. Then the received frame is sent to the MPEG-TS layer, which waits for a number of packets to re-constitute ULE packet. The ULE layer receives the ULE packet and extracts the IP packet, which is directed to the muxer. This entity (muxer) will receive the three applications streams sent through the three PLP, and reconstitute the application stream.

The main differences between the transmitter and the receiver models are:

- The antenna model, where a directional antenna is used in case of fixed receiver, and an omnidirectional antenna for mobile receivers;
- The muxer, which reconstitutes the application streams from different PLPs.

5 Simulation Results

5.1 Prelude

We simulated two scenarios. The first one, Full HD, simulates an HD video broadcast for fixed stations. The second one, Mobile Reception, simulates a mobile TV reception. Both scenarios use a scalable video coding with two layers: a Base and an enhanced layers. Each SVC layer is broadcasted through different PLP. The base layer is sent through the most robust PLP, usually PLP0. The enhanced layer is sent through PLP1, which uses the less robust physical modulation but it allows using more data rate.

Table 1 gives an overview of the parameters used to obtain the simulation results presented in the section 5.3.

In the first scenario (HD Full), we changed the distance between the receiver and the DVB-T2 gateway. Thus, for each distance we computed at the receiver, the SNR, the BER and the number of MPEG-TS packet loss (this allows us to see the impact on the application). Concerning the second scenario (mobile reception), we changed the mobile speed (pedestrian 1m/s, city car 50 km/h and urban car 110 km/h). As for the first scenario, we calculated the SNR, the BER and MPEG-TS packet loss during simulation. For both scenarios the antenna height used by the DVB-T2 gateway is 210m.

Note that, for simulating SVC traffics (two layers) we used CBR (Constant Bit Rate) sources. We argue this by the fact that the aims of these scenarios are destined to validate the proposed model and to show the performance of the DVB-T2. Nevertheless, we can easily extend this scenario to SVC, by attaching pcap traces to the sources.

Table 1: Simulation parameters

Scenario Name	PLP	Physical Rate	Physical Modulation	Min. Frequency	Trans. Power	Bandwidth
Full HD	PLP0	34.24 Mbps	256 QAM 3/5	622 Mhz	220 Watt	8 Mhz
	PLP1	47.72 Mbps	256 QAM 5/6	622 Mhz	220 Watt	8 Mhz
Mobile Reception	PLP0	7.8 Mbps	16 QAM 1/2	622 Mhz	220 Watt	8 Mhz
	PLP1	21.1 Mbps	64 QAM 3/5	622 Mhz	220 Watt	8 Mhz

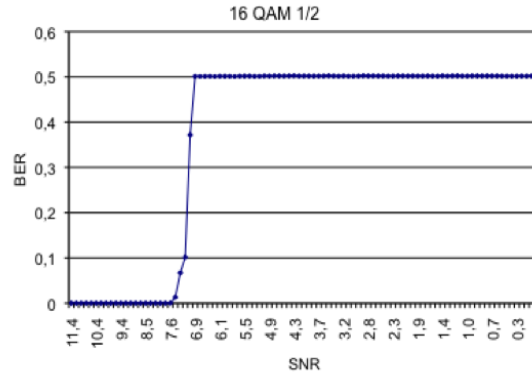

Figure 8: 16 QAM 1/2 Simulated BER vs SNR

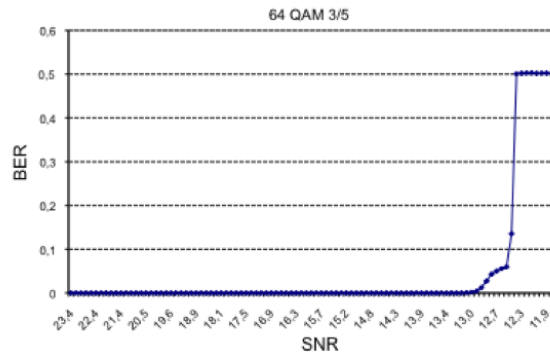

Figure 9: 64 QAM 3/5 Simulated BER vs SNR

5.2 Physical Model Validation

Before presenting the results, we will validate the physical layer model against the DVB-T2 standard requirement. In this way, we show in Figures 8-9-10-11-12 the BER versus SNR for 5 physical modulations, namely 16QAM1/2, 64QAM3/5, 254QAM3/4, 256QAM3/5 and 256QAM5/6.

From these figures, it appears clearly that the physical layer model respects the recommendation of NorDig for DVB-T2 receiver [3]. For instance, the NorDig [12] recommends that in case of Gaussian channel and 16QAM1/2 modulation, the BER is about 10^{-7} when the SNR reaches 6db, which is practically respected by our simulation model (see Figure 9). The same behavior is noticed for the other modulations, where our physical model respects the recommendation of the NorDig.

5.3 Results: Case 1 (Full HD)

As specified before, this scenario represents the High Definition transmission for fixed stations. The simulation duration is 5 minutes. The antenna height used by fixed stations is 10m. Figures 13-14-15 represent the SNR measured by the receiver when the distance between the transmitter and the receiver, is respectively 25km, 50km and 100km. The SNR is calculated for the three fading channels: (i) Ricean with a k factor equals to 2; (ii) Ricean with a k factor equals to 4; (iii) and Rayleigh. We recall that Ricean model is used for LOS communication, where k represents the signal strength of the LOS component, and Rayleigh ($k = 0$) is used for NLOS communication. From these figures we see clearly that Rayleigh channel fades more quickly than the two others models (Ricean-based), which is logical as Rayleigh envelop does not contain a LOS component.

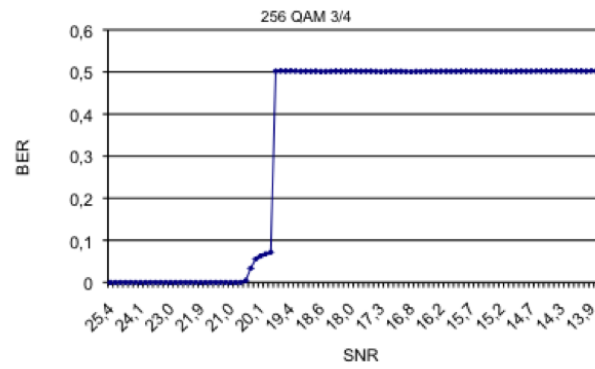

Figure 10: 256 QAM 3/4 Simulated BER vs SNR

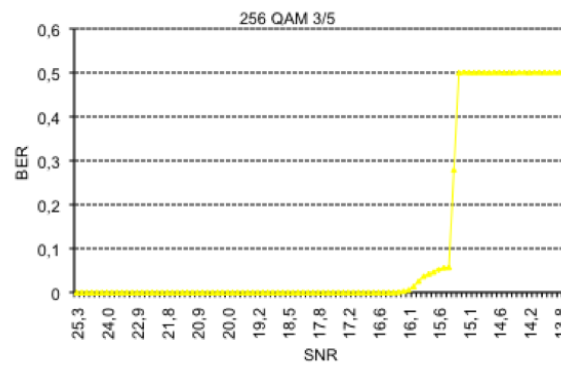

Figure 11: 256 QAM 3/5 Simulated BER vs SNR

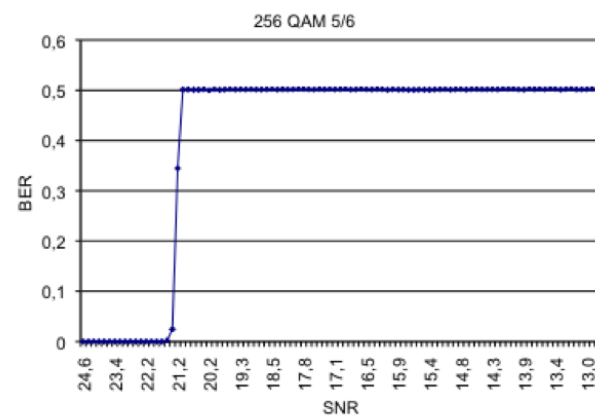

Figure 12: 256 QAM 5/6 Simulated BER vs SNR

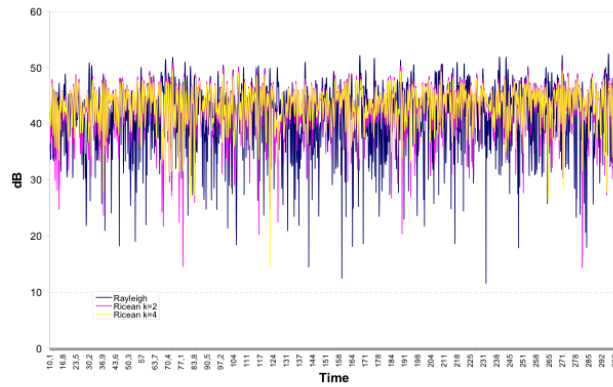

Figure 13: SNR vs simulated time - Dist. 25 Km

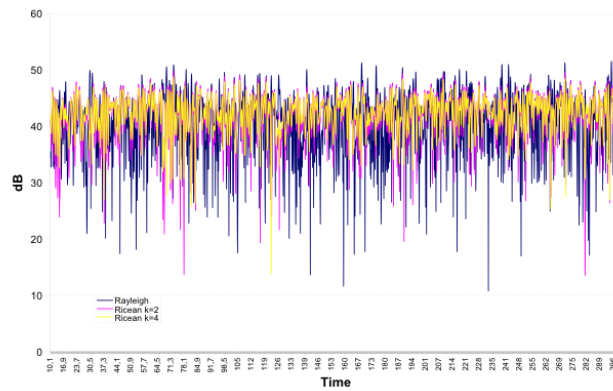

Figure 14: SNR vs simulated time - Dist. 50 Km

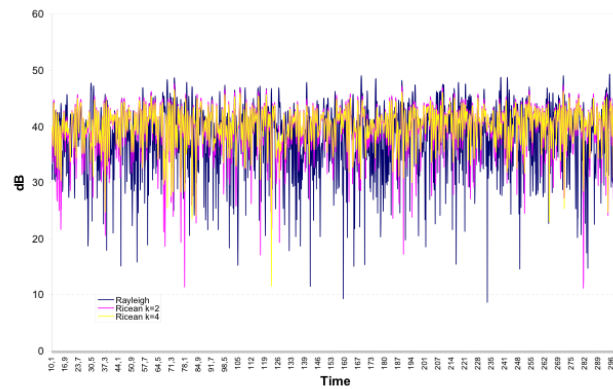

Figure 15: SNR vs simulated time - Dist. 100 Km

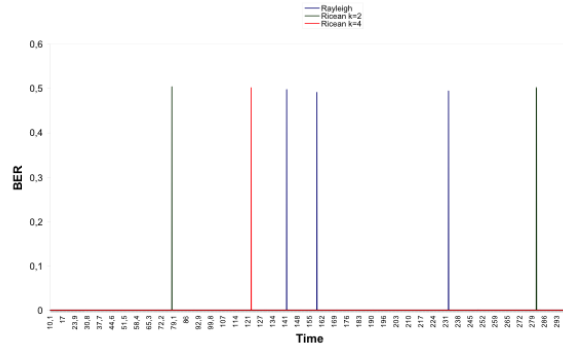

Figure 16: PLP0-Dist 25km - BER vs Simulated time

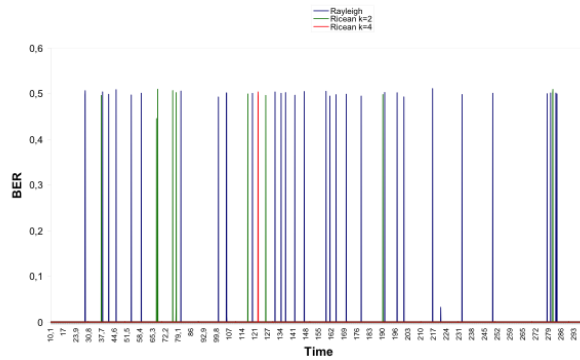

Figure 17: PLP0-Dist 50km - BER vs Simulated time

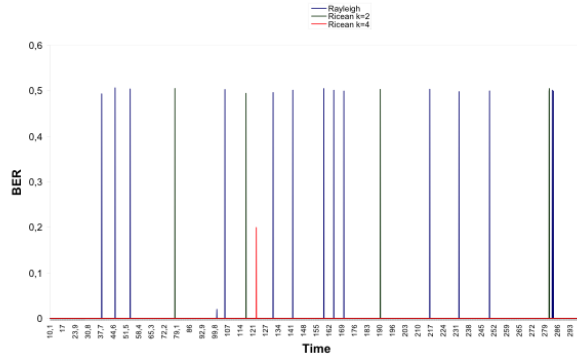

Figure 18: PLP0-Dist 100km - BER vs Simulated time

Also, we notice that Ricean model with high k factor fades more slowly, since the impact of the LOS component is more important on the received signal ($k = 4$).

Figures 16-17-18 show the BER obtained in PLP0 for the three distances. It appears clearly that the BER is higher when the distance increases, which is reasonable as the received signal power decreases with the increase of the distance. Also, we notice that Rayleigh model exhibits the highest BER for the three distances. The most robust in term of BER is Ricean channel with $k = 4$, since the noticed BER is very low.

From Figures 19-20-21, we can clearly see that PLP1 is less robust than PLP0, since it uses less robust modulation and less FEC protection than PLP1. Also, we notice that Rayleigh fading shows the highest BER in all cases.

Figures 22-23-24 show the number of MPEG-TS packets lost during simulation. Here, the results are organized for the three fading channels. Clearly, the worst case is achieved when using the Rayleigh fading, particularly if the distance between the transmitter and the receiver is about 100km. Concerning Ricean channel with high factor ($k = 4$), the number of packet

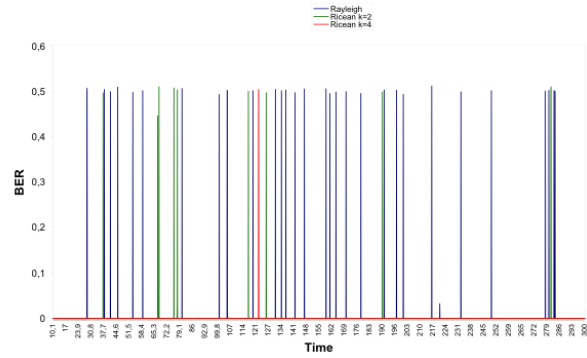

Figure 19: PLP1-Dist 25km - BER vs Simulated time

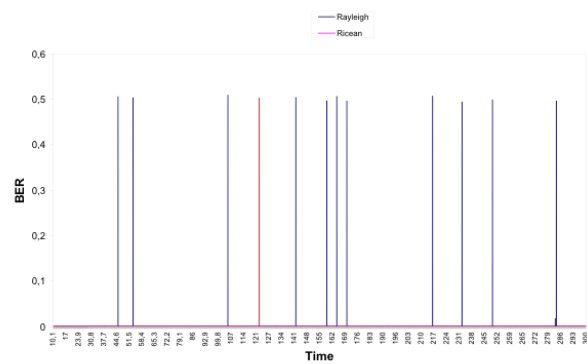

Figure 20: PLP1-Dist 50km - BER vs Simulated time

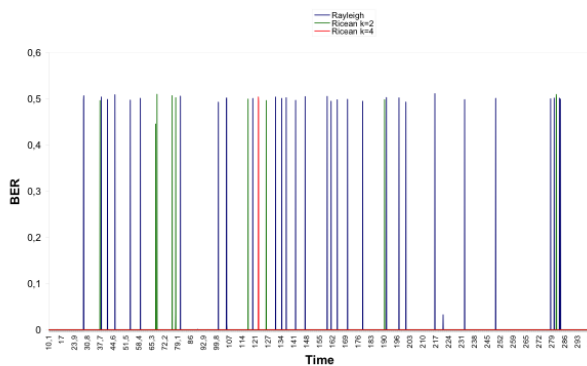

Figure 21: PLP1-Dist 100km - BER vs Simulated time

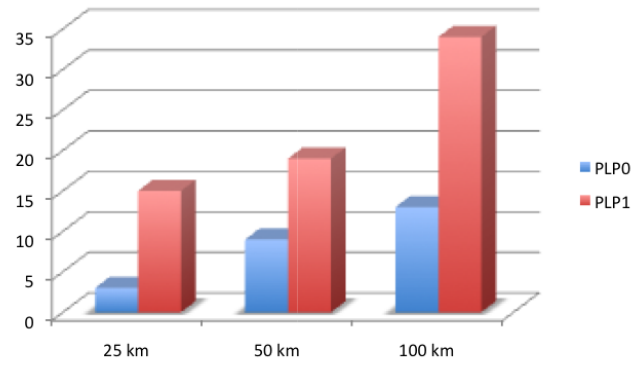

Figure 22: Rayleigh -Number of MPEG-TS packet loss vs. distance

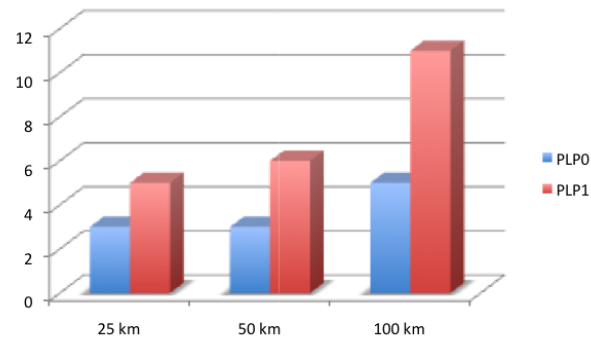

Figure 23: Ricean ($k=2$) -Number of MPEG-TS packet loss vs. distance

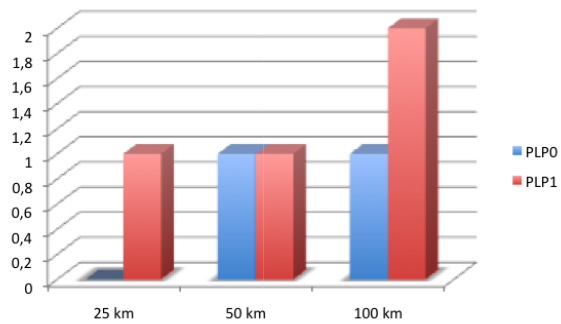

Figure 24: Ricean ($k=4$) -Number of MPEG-TS packet loss vs. distance

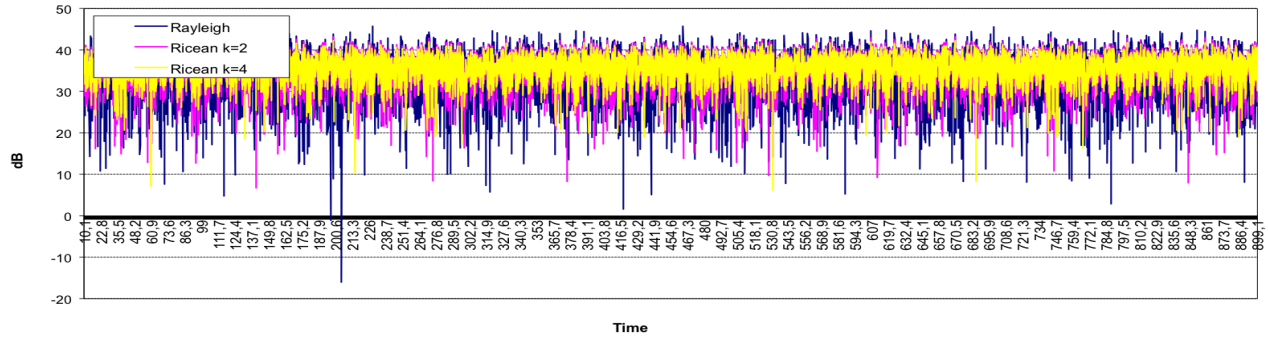

Figure 25: Pedestrian scenario - SNR vs Simulated time

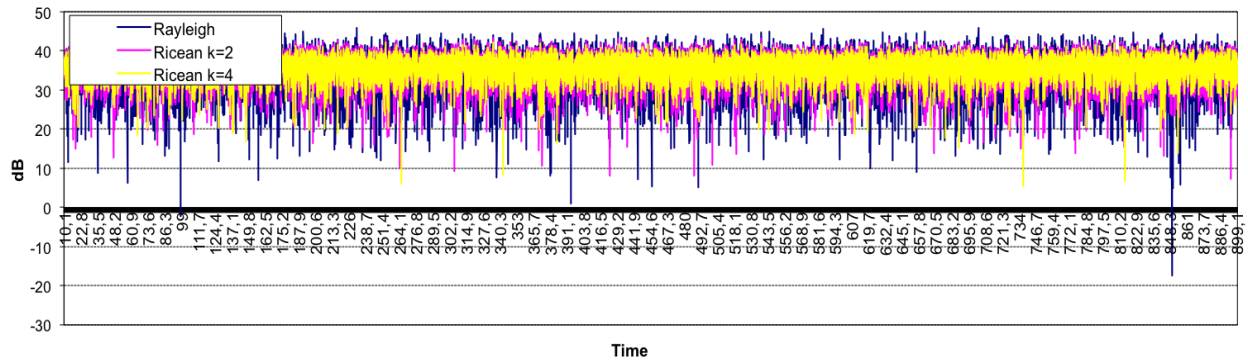

Figure 26: City car scenario - SNR vs Simulated time

loss is acceptable, even for long distance, and it could be easily recoverable by using an appropriate FEC at the application layer.

5.4 Results: Case 2 (Mobile)

For this case, we simulate the movement of mobile user through three scenarios:

- Pedestrian ($1m/s$), where the mobile is placed initially at $1km$ from the transmitter station and it moves to $5km$. The antenna height considered in this scenario is $1m$.
- City car ($50km/h$), where the mobile is placed initially at $1km$ and it moves to $20km$.
- Urban car ($110km/h$). The antenna height for the two last scenario is $2m$.

The simulation duration used in this case is 15 minutes.

Figures 25-26-27 present the obtained SNR versus simulated time for the three scenarios (pedestrian, city car and urban car). We see clearly that the mobility has an impact on the received signal, where the SNR goes to zero in some points. This behavior will generate high BER by report to the fixed scenario (which is confirmed by the MPEG-TS packet loss).

Figures 28-29-30 show the number of MPEG-TS packet lost obtained in PLP0 and PLP1 in the three scenarios during the whole simulation. We can notice that mobility affects the signal quality for both PLP0 and PLP1. The number of packet lost confirms this behavior, since we can clearly see high losses in the case of high mobility. The worst case is reported for Rayleigh fading, particularly for PLP1. Besides that PLP1 has less FEC protection than PLP0, this behavior is mainly due to the fact that Rayleigh channel affects particularly the SNR received in contrast with Ricean channels. Further, we argue that pedestrian scenario shows more losses then city car scenario by the fact that antenna height used in the first scenario ($1m$) is lower than the one used in the second scenario ($2m$). From this results we see clearly the advantages of associating SVC with DVB-T2 to address mobile users, since most of the cases PLP0 layer is correctly received (and hence the video base layer). Thanks, to the hierarchical physical layer (with different protection) and SVC coding scheme.

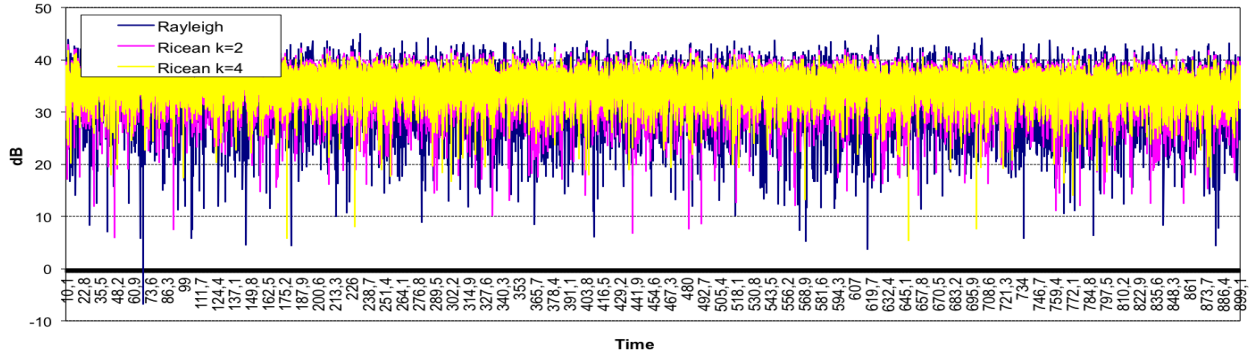

Figure 27: Urban car scenario - SNR vs Simulated time

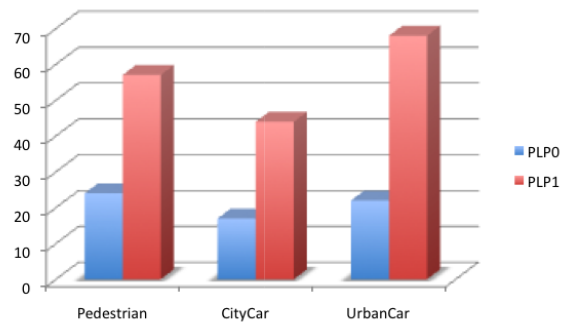

Figure 28: Rayleigh -Number of MPEG-TS packet loss vs. mobility scenario

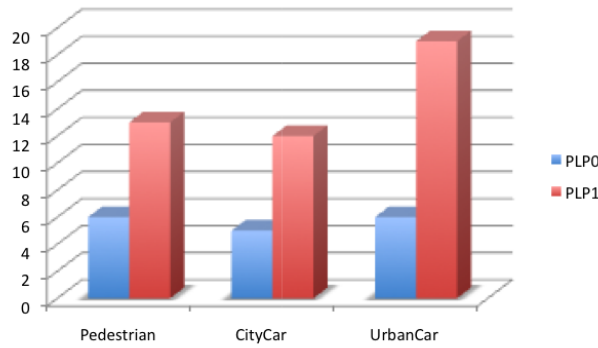

Figure 29: Ricean (k=2) -Number of MPEG-TS packet loss vs. mobility scenario

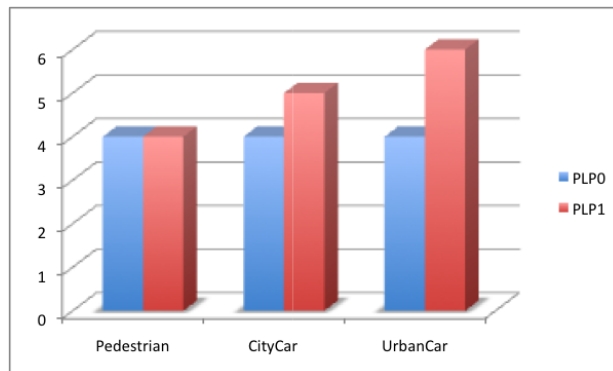

Figure 30: Ricean (k=4) -Number of MPEG-TS packet loss vs. mobility scenario

6 Conclusion

This paper presents design and implementation of new features to support DVB-T2 simulation in OPNET. The proposed features includes realistic physical channel mode, MPEG-TS layer with an IP encapsulator based on ULE, and a hierarchical application layer. We also presented extensive simulation results when evaluating HD video broadcast over DVB-T2 network, for both fixed and mobile receiver. From these results, we can clearly confirm that DVB-T2 could be an interesting solution to broadcast value-added services like HD TV and 3D TV. Further, we noticed that associating SVC with DVB-T2 can address efficiently the mobility, as in most cases mobile users are able to decode PLP0 and hence the video base layer. However, there are some situation, where the quality could not be insured. This happened particularly for NLOS communication, and PLP with low physical protection (FEC and physical modulation).

On the other hand, our DVB-T2 simulation module still has some limitations. Currently, the BER is computed for an MPEG-TS packet (188 Bytes), which not follow the COFDM specifications, where the BER is computed for a block of fixed size (1K or 32K).

References

- [1] "DVB-T2 - the HDTV generation of terrestrial DTV", DVB-TM-3997, MArch 2008.
- [2] Scalable Video Coding, Joint ITU-T Rec. H.264 — ISO/IEC 14496-10 / Amd.3 Scalable Video Coding, November 2007.
- [3] ISO/IEC IS 13818-1,"Information technology - generic coding of moving pictures and associated audio information: systems".
- [4] ETSI TS 102 606 V.1.1.1, "Digital Video Broadcasting (DVB); Generic Stream Encapsulation".
- [5] www.opnet.com/products/opnet-products.html.
- [6] X. J. Chang,"Network simulations with OPNET", Simulation Conference Proceedings 99, pp. 307-314, December 1999.
- [7] IETF RFC 4326, G. Fairhurst, and B. Collini-Nocker, "Unidirectional Lightweight Encapsulation (ULE) for Transmission of IP Datagrams over MPEG-2 Transport Stream (TS)", December 2005.
- [8] N. Blaunstein, "Radio Propagation in Cellular Networks", Artech House, Norwood, MA, 2000, pp. 261264.
- [9] T. S. Rappaport, "Wireless Communications, Principles and Practice", 2nd ed., Prentice-Hall, Upper Saddle River, NJ, 2002, pp. 153154.
- [10] R. Punnoose, P. V. Nikitin, and D. Stancil, "Efficient simulation of Ricean fading within a packet simulator", IEEE VTC Fall 2000, USA.
- [11] ETSI EN 301 192 V 1.4.2, "Digital Video Broadcasting (DVB); DVB specification for data broadcasting", April 2008.
- [12] Requierement to Nordog T2 compliant IRDs, Addendum to the Nordig Requierements.