



**HAL**  
open science

# What can be done with a Badly Calibrated Camera in Ego-Motion Estimation?

Tomas Svoboda, Peter Sturm

► **To cite this version:**

Tomas Svoboda, Peter Sturm. What can be done with a Badly Calibrated Camera in Ego-Motion Estimation?. [Research Report] CTU-CMP-1996-01, 1996, pp.27. inria-00525701

**HAL Id: inria-00525701**

**<https://inria.hal.science/inria-00525701>**

Submitted on 31 May 2011

**HAL** is a multi-disciplinary open access archive for the deposit and dissemination of scientific research documents, whether they are published or not. The documents may come from teaching and research institutions in France or abroad, or from public or private research centers.

L'archive ouverte pluridisciplinaire **HAL**, est destinée au dépôt et à la diffusion de documents scientifiques de niveau recherche, publiés ou non, émanant des établissements d'enseignement et de recherche français ou étrangers, des laboratoires publics ou privés.



Czech Technical University, Prague, Czech Republic  
Center for Machine Perception

---

## RESEARCH REPORT

No. CTU-CMP-1996-01

# What can be done with a badly calibrated Camera in Ego-Motion Estimation?

Tomáš Svoboda and Peter Sturm

svoboda@vision.felk.cvut.cz, peter.sturm@inrialpes.fr

December 5, 1996

### **Acknowledgement:**

*This work was supported by Région Rhône Alpes with the program TEMPRA – East Europe between l'INPG Grenoble and the Czech Technical University in Prague, grant 102/95/1378 of the Grant Agency of the Czech Republic, European Union grant Copernicus No. 1068 RECCAD and Czech Ministry of Education project No. VS 96049*

*This publication can be obtained via anonymous ftp from  
<ftp://cmp.felk.cvut.cz/pub/cv1/ARTICLES/svoboda/weakcal.ps.Z>*

---

Czech Technical University, Faculty of Electrical Engineering  
Department of Control Engineering, Center for Machine Perception,  
Computer Vision Laboratory  
121 35 Prague 2, Karlovo náměstí 13, Czech Republic  
FAX +42 2 290159, phone +42 2 24357465, <http://cmp.felk.cvut.cz>

# What can be done with a badly calibrated Camera in Ego-Motion Estimation?

Tomáš Svoboda and Peter Sturm

Center for Machine Perception  
Czech Technical University  
Karlovo nám. 13  
CZ 121-35 Praha 2, Czech Republic  
tel. +42-2-24.35.74.58  
fax +42-2-29.01.59  
svoboda@vision.felk.cvut.cz

GRAVIR-IMAG  
INRIA Rhône-Alpes  
655, avenue de l'Europe  
38330 Monbonnot, France  
tel. +33-76.61.52.32  
fax +33-76.61.52.52  
peter.sturm@inrialpes.fr

## Abstract

This paper deals with the ego-motion estimation (motion of the camera) from two views. When we want to estimate the ego-motion correctly we have to find correspondences and we need a calibrated camera. We solve the problem how we can incorporate such knowledge about camera calibration errors. We present the linear estimate of the uncertainty of the motion parameters based on the uncertainty in the calibration parameters. We did many tests with synthetic data. We find the relations between noise in the camera parameters and the acceptability of the translation vector. We show that the linear estimate of the translation vector uncertainty is very stable and useful even with a rough calibration. The estimate of the noise in the rotation seems to be less stable and the estimation of the rotation is very sensitive to the accuracy in calibration parameters.

# Contents

<b>1</b>	<b>Introduction</b>	<b>3</b>
<b>2</b>	<b>Fundamentals</b>	<b>3</b>
2.1	Notation . . . . .	3
2.2	The camera model and the camera calibration . . . . .	3
2.3	Two views, fundamental and essential matrix . . . . .	5
<b>3</b>	<b>The uncertainty in the estimation process</b>	<b>6</b>
3.1	Properties of Gaussian random vectors . . . . .	7
3.2	Statistic and analytic approach . . . . .	8
3.3	Covariance of the essential matrix . . . . .	8
3.4	Covariance of the motion parameters . . . . .	9
3.5	Eigenvalues and eigenvectors of a noisy matrix . . . . .	10
3.6	Ego-motion algorithm taking into account uncertainty . . . . .	14
<b>4</b>	<b>Experiments</b>	<b>14</b>
4.1	What do we measure? . . . . .	16
4.2	Approaching motion . . . . .	17
4.3	Lateral motion . . . . .	20
4.4	General motion . . . . .	21
4.5	Which estimate for noisy data? . . . . .	21
<b>5</b>	<b>Conclusion</b>	<b>23</b>
<b>A</b>	<b>How to create correlated random variables</b>	<b>24</b>

# 1 Introduction

We have two images captured by one camera from two different viewpoints. When we find at least eight corresponding points and when we know the calibration parameters of the camera, the Euclidean camera motion can be estimated up to scale. The Euclidean reconstruction of the scene can be done too. This problem has been solved over years ([11, 17]). When the camera parameters are not known other algorithms have to be used. Since we have only two images we can only establish the epipolar geometry, Luong et al. in [12], and we can do only the projective reconstruction. If we want to calibrate the camera we can use some of the many methods developed for the off-line camera calibration. Tsai did it in [16].

Having more images, at least three, we can employ the algorithms for the camera self-calibration which theory was presented by Maybank and Faugeras in [13] or, when the camera undergoes planar motion we can use the algorithm developed by Armstrong et al. in [1]. Hartley has presented an iterative algorithm for Euclidean reconstruction from many uncalibrated views in [5].

In this paper we deal with two views and a roughly calibrated camera. We use linear method intended for a calibrated camera to estimate the ego-motion (motion of the camera). Because of noise in the estimation process, an error analysis is needed. There are two sources of noise: (1) noise in correspondences (2) noise in the calibration parameters. Weng [17] studied the influence of the noise on the motion parameters. Florou and Mohr [4] used the statistic approach to study reconstruction errors with the calibration parameters. In this paper we present a linear algorithm for the estimate of the validity of the motion parameters based on the uncertainty in the calibration parameters.

## 2 Fundamentals

### 2.1 Notation

Vectors will be denoted by bold characters. There will be two types of vector: (a) normal, in conventional sense, this type of vectors will be denoted by small bold characters  $\mathbf{u} = [u_1, u_2, \dots, u_n]^T$ , (b) column vectors which arise from the elements of the matrices, for instance the  $3 \times 3$  matrix  $E$ , rearranged  $9 \times 1$  vector, will be denoted by the capital bold character  $\mathbf{E}$ . The matrices are indicated by capital italics such as  $E$ . This notation will stand also in the subscripts. The sign  $\stackrel{\triangleright}{=}$  we use to define new variables when the variable to be defined is obvious.

### 2.2 The camera model and the camera calibration

We use the pinhole camera model. There are three coordinate systems as it is illustrated in Figure 1. The world coordinate system ( $W, x_w, y_w, z_w$ ), the camera standard coordinate system ( $C, x, y, z$ ) and the coordinate system for the retinal plane ( $c, u, v$ ). Let us introduce the transformations among them:

$$\begin{bmatrix} x \\ y \\ z \end{bmatrix} = [R \mid -R\mathbf{t}] \begin{bmatrix} x_w \\ y_w \\ z_w \\ 1 \end{bmatrix} \stackrel{\triangleright}{=} PM. \quad (1)$$

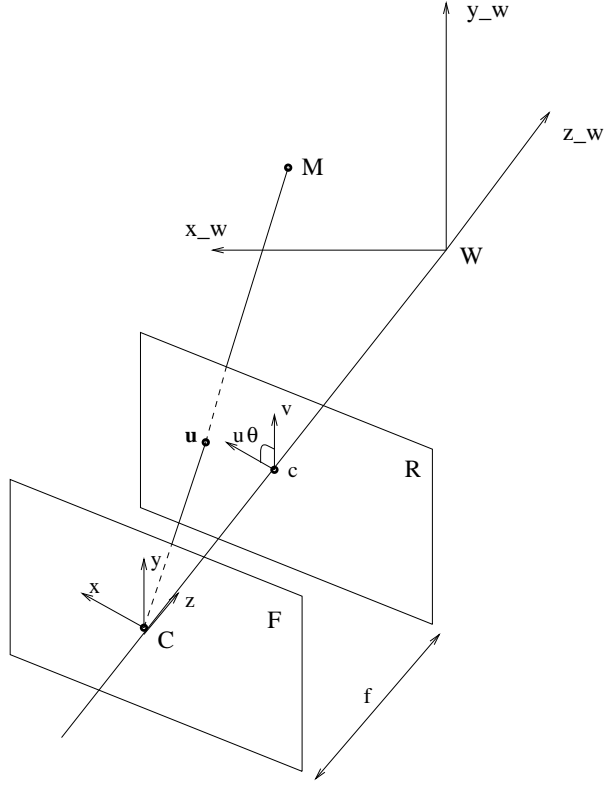

Figure 1: The pinhole camera, retinal (R) and focal (F) plane and three coordinate systems

The rotation matrix  $R$  and the translation vector  $\mathbf{t}$  characterize the orientation and the position of the camera with respect to the world coordinate system. From Figure 1 it is clear that the relationship between image coordinates and 3-D coordinates is

$$\frac{f}{z} = \frac{u}{x} = \frac{v}{y}. \quad (2)$$

We introduce the *normalized image coordinates* as

$$\mathbf{u} = \begin{bmatrix} u \\ v \\ 1 \end{bmatrix} = \begin{bmatrix} f \frac{x}{z} \\ f \frac{y}{z} \\ 1 \end{bmatrix}, \quad (3)$$

where  $f$  is the focal length of the camera. However, when we localize points in the image, we get the coordinates in pixels,  $[q_u, q_v]$ . What is the relationship between those pixel coordinates and the normalized coordinates  $\mathbf{u}$ ? Introducing the *calibration matrix*  $K$ , we can write

$$\begin{bmatrix} u \\ v \\ 1 \end{bmatrix} = \begin{bmatrix} f k_u & f k_u \cos(\theta) & u_0 \\ 0 & \frac{f k_v}{\sin(\theta)} & v_0 \\ 0 & 0 & 1 \end{bmatrix}^{-1} \begin{bmatrix} q_u \\ q_v \\ 1 \end{bmatrix} \triangleq K^{-1} \mathbf{q}. \quad (4)$$

The meaning of the elements of the calibrating matrix is the following.

$f$ : The focal length of the camera, respectively, the distance between the retinal and the focal plane (see Figure 1).

$k_u$  resp.  $k_v$ : These values characterize the horizontal resp. vertical size of the pixels. More precisely  $1/k_u$  resp.  $1/k_v$  is the horizontal resp. vertical size of the pixels in millimeters.

$u_0$  and  $v_0$ : Pixel coordinates of the *principal point*. The principal point is the intersection of the optical axis with the retinal plane, in Figure 1 is denoted by “c”.

$\theta$ : Angle in the retinal coordinate system (“skew”). See Figure 1.

The  $k_u, k_v$  parameters have to be considered together with  $f$ . The skew angle  $\theta$  is usually supposed to be very close  $\pi/2$ , which is a valid approximation in practise. Thus the matrix  $K$  can be rewritten in a simpler form as

$$K = \begin{bmatrix} \alpha_u & 0 & u_0 \\ 0 & \alpha_v & v_0 \\ 0 & 0 & 1 \end{bmatrix}. \quad (5)$$

We can describe the introduced calibration parameters  $\alpha_u$  resp.  $\alpha_v$  as the focal length expressed in the horizontal resp. vertical pixel size. In this paper we assume that the matrix  $K$  is in its simpler form (5). The above parameters are sometimes called *intrinsic* parameters of the camera, whereas  $R$  and  $\mathbf{t}$  are often titled *extrinsic* parameters of the camera. The knowledge of the intrinsic parameters enables the estimation of the Euclidean reconstruction of the scene and the Euclidean motion of the camera from two views. A number of methods for the camera calibration are known, for instance, from earlier off-line method presented by Tsai in [16] over nowadays method for the self-calibration of the camera, which undergoes a planar motion, by Armstrong et al. in [1], till the most general one, the theory of the camera self-calibration, presented by Maybank and Faugeras in [13]. However the approach, how to calibrate the camera, is not the main subject in this paper.

### 2.3 Two views, fundamental and essential matrix

Let us suppose that the camera moves without changing its intrinsic parameters. The geometry of this motion is shown in Figure 2. What can be estimated from two views, depends

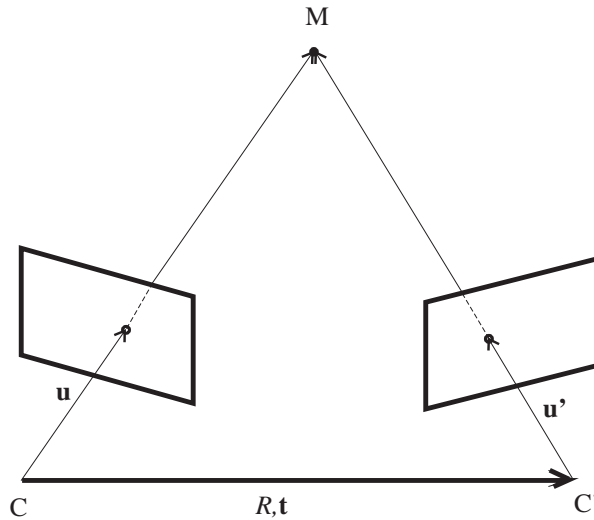

Figure 2: Two views, the geometry and the coplanarity constraint.

whether the camera is calibrated or not ([3, 5]). Both situations, with a calibrated and with an uncalibrated camera, were studied over years. Starting with the article by Longuet-Higgins ([11]), over an article by Weng et al. ([17]), for calibrated cameras, till nowadays either [15] or [12] for the uncalibrated camera.

If the motion between two positions of the camera is given by the rotation matrix  $R$  and the translation vector  $\mathbf{t}$ , and if  $\mathbf{u}$  and  $\mathbf{u}'$  are normalized image coordinates (3) of corresponding points, then the coplanarity constraint is written as:

$$\mathbf{u}'(\mathbf{t} \times R\mathbf{u}) = 0. \quad (6)$$

Introducing the skew-symmetric matrix  $S$

$$S = \begin{bmatrix} 0 & -t_z & t_y \\ t_z & 0 & -t_x \\ -t_y & t_x & 0 \end{bmatrix}, \quad (7)$$

we can rewrite the above coplanarity constraint as

$$\mathbf{u}'^T S R \mathbf{u} \stackrel{\Delta}{=} \mathbf{u}'^T E \mathbf{u} = 0, \quad (8)$$

where  $E$  is the *essential matrix*. Since the  $E$  matrix is the product of a skew-symmetric matrix and the orthonormal matrix  $R$ , it has a number of important properties. Its rank is two. More important is that  $E$  can be decomposed into the skew-symmetric matrix  $S$  post multiplied by the orthonormal rotation matrix  $R$  if and only if one singular value is zero (rank 2) and the other two are equal and non zero. The necessity and the sufficiency of this condition is proved by Huang in [8]. The equality of the nonzero singular values is a very strong attribute of the essential matrix. Svoboda and Pajdla presented an efficient algorithm utilizing this equality [14].

What changes when we do not know the calibration parameters? We suppose that the pixel coordinates of corresponding points  $\mathbf{q}$  resp.  $\mathbf{q}'$  are given. Having at least eight correspondences we can estimate the *fundamental matrix* by solving the set of linear equations

$$\mathbf{q}'_i^T F \mathbf{q}_i = 0. \quad (9)$$

This equations arise from the *epipolar geometry*, this basic constraint which exists for two view-points. An exhaustive study of the epipolar geometry and the estimation of the fundamental matrix can be found in [12]. The uncertainty of the fundamental matrix in the case of noisy data was studied by Csurka et al. in [2]. By replacing  $\mathbf{u}$  through the relationship (4) in the equation (8), it can be verified that the relation between the essential and the fundamental matrix is

$$E = K^T F K. \quad (10)$$

### 3 The uncertainty in the estimation process

We want to estimate the motion of the camera from two views. We suppose that the camera is calibrated. There are several sources of uncertainty in the estimation process. Firstly, the correspondences can only be located with finite precision and some correspondences can be completely mismatched. Secondly, the camera intrinsic parameters are determined with some uncertainty too. The influence of the errors in the correspondences was studied by Weng et



al. [17], for the calibrated camera and partly by Csurka et al. [2] for the uncalibrated case. Florou and Mohr in [4] did statistical tests for the importance of the camera parameters for the 3-D reconstruction error. In the following sections we present how to estimate the uncertainty of the essential matrix and consequently the motion parameters due to the inaccuracy in the calibration parameters.

### 3.1 Properties of Gaussian random vectors

Firstly, we recall several facts about random variables. The attributes of Gaussian random variables are well known from the probability theory thus we give only several remarks. Let  $\mathbf{x}$  be an  $n$  dimensional Gaussian random vector and let  $C_{\mathbf{x}}$  be its  $n \times n$  covariance matrix. The covariance matrix is defined as

$$C_{\mathbf{x}} = \mathbb{E}\{(\mathbf{x}_i - \bar{\mathbf{x}})(\mathbf{x}_i - \bar{\mathbf{x}})^T\}, \quad (11)$$

where  $\bar{\mathbf{x}}$  denotes the mean of the random vector and  $\mathbb{E}\{\mathbf{x}\} = \bar{\mathbf{x}}$  denotes the expectation (the mean). We suppose linear character of errors so we define a random vector  $\mathbf{y} = A\mathbf{x} + \mathbf{b}$ , where  $A$  is a constant matrix and  $\mathbf{b}$  is a constant vector. Then  $\mathbf{y}$  is a Gaussian vector with the mean  $\bar{\mathbf{y}}$  and with the covariance  $C_{\mathbf{y}}$  given by

$$\begin{aligned} \bar{\mathbf{y}} &= A\bar{\mathbf{x}} + \mathbf{b}, \\ C_{\mathbf{y}} &= AC_{\mathbf{x}}A^T. \end{aligned} \quad (12)$$

To better illustrate what information the covariance matrix can offer, consider two random variables  $x, y$ . Thus the covariance matrix is:

$$C_{xy} = \begin{bmatrix} \text{var}^2(x) & r_{xy}\text{var}(x)\text{var}(y) \\ r_{xy}\text{var}(x)\text{var}(y) & \text{var}^2(y) \end{bmatrix}, \quad (13)$$

where  $r_{xy}$  is the so called *correlation coefficient*.  $-1 \leq r_{xy} \leq 1$ . What we call the *variance*, is somewhere else called *standard deviation*. Actually, in this paper for a simple random variable  $\text{var}^2(x) = C_x$  holds. In Figure 3 the situation for correlated variables ( $r_{xy} = 0.95$  and for  $r_{xy} = -0.95$ ) and for uncorrelated variables ( $r_{xy} = 0.00$ ) is demonstrated.

Now we reformulate the above equations for the general case. Let the transformation be

$$\mathbf{y} = f_{\mathbf{xy}}(\mathbf{x}). \quad (14)$$

When the transformation is linear, the equations (12) are directly applicable. When  $f_{\mathbf{xy}}$  is non-linear we use the first order linear approximation. The Jacobian matrix is

$$J_{\mathbf{xy}} = \frac{\partial f_{\mathbf{xy}}}{\partial \mathbf{x}} \text{ at } \mathbf{x} = \bar{\mathbf{x}}. \quad (15)$$

Two or more characters as indexes denote the step from one random variable to another. Then we can rewrite (12) as

$$\begin{aligned} \bar{\mathbf{y}} &= f_{\mathbf{xy}}(\bar{\mathbf{x}}) \\ C_{\mathbf{y}} &= J_{\mathbf{xy}}C_{\mathbf{x}}J_{\mathbf{xy}}^T \end{aligned} \quad (16)$$

The proof of the above equations is easy. Expand  $\mathbf{y}$  into Taylor series at  $\mathbf{x} = \bar{\mathbf{x}}$ :

$$\mathbf{y} = f_{\mathbf{xy}}(\bar{\mathbf{x}}) + \frac{\partial f_{\mathbf{xy}}}{\partial \mathbf{x}}(\mathbf{x} - \bar{\mathbf{x}}) + \mathcal{O}((\mathbf{x} - \bar{\mathbf{x}})^2). \quad (17)$$

Now ignore the second order terms and put the rest of equation (17) into equation (11). The result presented in equations (16) is then obvious.

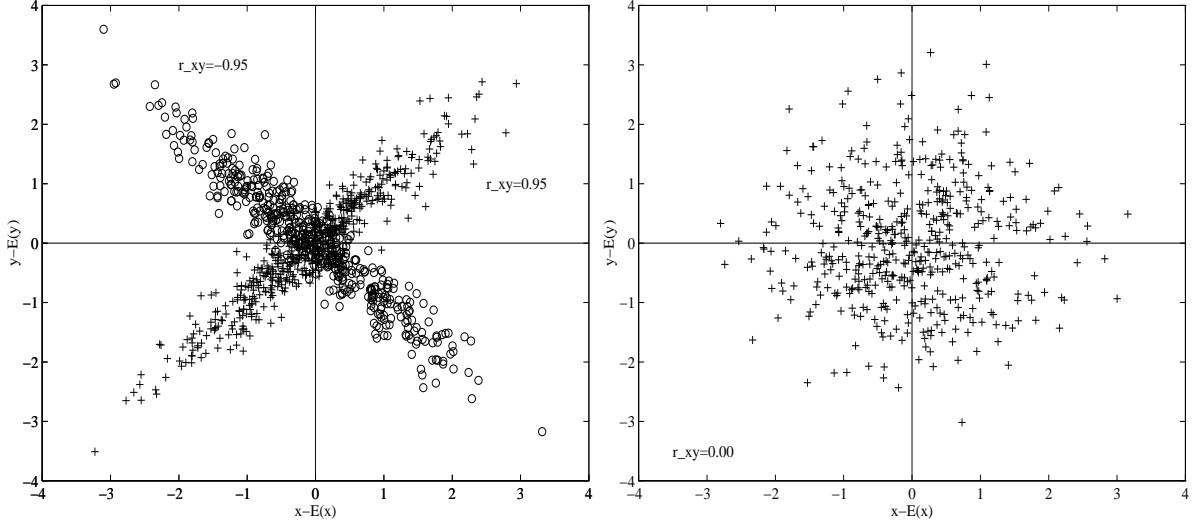

Figure 3: Correlation between two random variables.

### 3.2 Statistic and analytic approach

We describe two basic ways how to assess the uncertainty. At first, we can do many tests with noisy data and repeat them for many types of motion, for many different scenes, and so forth. Then several statistic methods can be used for the analysis of the statistical data [9]. However, this approach is very time expensive and we can not estimate the uncertainty in the concrete situation in a reasonable time. At second, we would derive the analytic relationship  $[E, R, \mathbf{t}] = f(K, F)$  and then compute the Jacobian matrices and finally the covariances employing the procedures described in the previous section. The Maple symbolic computational software was used to derive more complex relationships.

### 3.3 Covariance of the essential matrix

Let us suppose we know the fundamental matrix, which we estimated by the set of equations (9). The essential relationship between the essential and the fundamental matrix is

$$E = K^T F K, \quad (18)$$

where  $K$  is the calibration matrix. We would like to investigate the influence of the uncertainty of the calibration parameters on the essential matrix. Thus we suppose that  $F$  is exact. The  $K$  matrix contains four calibration parameters, equation (5). We consider them as Gaussian random variables with mean covered by  $K$  and with covariance matrix  $C_K$ . Having in mind the equations (16), the sufficient characteristics of the Gaussian essential matrix, the mean and the covariance matrix, can be estimated as

$$\begin{aligned} E &= K^T F K, \\ C_E &= J_{KE} C_K J_{KE}^T, \end{aligned} \quad (19)$$

where  $J_{KE}$  is the Jacobian matrix computed using equation (15).

### 3.4 Covariance of the motion parameters

The motion parameters are the translation vector  $\mathbf{t}$  and the Euler angles  $\mathcal{E} = [\varphi, \vartheta, \psi]$ . The relationship between  $\mathcal{E}$  and the rotation matrix  $R$  [10] is

$$R = \begin{bmatrix} \cos(\varphi) \cos(\psi) \cos(\vartheta) - \sin(\varphi) \sin(\psi) & -\cos(\psi) \sin(\varphi) - \cos(\varphi) \cos(\vartheta) \sin(\psi) & \cos(\varphi) \sin(\vartheta) \\ \cos(\psi) \cos(\vartheta) \sin(\varphi) + \cos(\varphi) \sin(\psi) & \cos(\varphi) \cos(\psi) - \cos(\vartheta) \sin(\varphi) \sin(\psi) & \sin(\varphi) \sin(\vartheta) \\ -\cos(\psi) \sin(\vartheta) & \sin(\psi) \sin(\vartheta) & \cos(\vartheta) \end{bmatrix}. \quad (20)$$

The rotation described by Euler angles is: (i) rotate by  $\varphi$  around the z-axis, (ii) rotate by  $\vartheta$  around the y-axis, (iii) rotate by  $\psi$  around the z-axis again. To obtain  $R$  and  $\mathbf{t}$  from the essential matrix  $E$  we use the method proposed by Hartley in [6]. This method is also used in [14]. Just the essence of it is given here. Using the singular value decomposition we factorize  $E$  as

$$E = UDV^T. \quad (21)$$

We already know that  $E = RS$ . Hartley in [6] proposed the following equations:

$$S = VZV^T, \quad (22)$$

$$R = UYV^T \text{ or } UY^T V^T, \quad (23)$$

where

$$Z = \begin{bmatrix} 0 & -1 & 0 \\ 1 & 0 & 0 \\ 0 & 0 & 0 \end{bmatrix} \text{ and } Y = \begin{bmatrix} 0 & 1 & 0 \\ -1 & 0 & 0 \\ 0 & 0 & 1 \end{bmatrix}. \quad (24)$$

Recall that  $S$  is the skew symmetric matrix containing the translation vector  $\mathbf{t}$ , equation, (7), we rewrite the equation (22) as

$$\mathbf{t} = f_{V\mathbf{t}}(V). \quad (25)$$

We will describe how to estimate the covariance matrices  $C_U, C_V, C_{UV}$  when the matrix  $E$  is perturbed in section 3.5. Let suppose  $C_U, C_V, C_{UV}$  be known, for this moment. Then the covariance matrix of the translation vector is

$$C_{\mathbf{t}} = J_{V\mathbf{t}} C_V J_{V\mathbf{t}}^T, \quad (26)$$

where the Jacobian matrix  $J_{V\mathbf{t}}$  is

$$J_{V\mathbf{t}} = \frac{\partial f_{V\mathbf{t}}}{\partial V_{ii}} \text{ at } V_{ii} = \overline{V}_{ii}. \quad (27)$$

The computation of the covariance matrix of the Euler angles is somewhat complicated. The rotation matrix  $R$  is the product of both  $U$  and  $V$ . This transformation is linear. However we must also find the Jacobian matrix of the inverse relationship of the equation (20). The covariance matrix of  $R$  is

$$C_R = J_{UVR} C_{UV} J_{UVR}^T, \quad (28)$$

where  $J_{UVR}$  is a Jacobian matrix computed like  $J_{V\mathbf{t}}$ . When we find the transformation  $\mathcal{E} = f_{R\mathcal{E}}(R_{ii})$ , we can finally estimate the covariance matrix of Euler angles.

$$C_{\mathcal{E}} = J_{R\mathcal{E}} C_R J_{R\mathcal{E}}^T. \quad (29)$$

### 3.5 Eigenvalues and eigenvectors of a noisy matrix

Let us suppose we have estimated the rank 2 *essential matrix*, whose two nonzero singular values would be equal in the ideal case. The  $E$  matrix can be decomposed by the singular value decomposition as

$$E = UDV^T. \quad (30)$$

Let us also suppose we have estimated the  $9 \times 9$  covariance matrix  $C_E$  using equation (19). The question is, how we can propagate the uncertainty in the essential matrix expressed by the covariance matrix  $C_E$  into  $U$  resp.  $V$  matrix. We describe this approach employing the essential matrix, still this approach can be used for any general matrix as Weng showed in [17] using theory by Wilkinson [18].

Let suppose additive noise. We denote the noise corrupted  $E$  as  $E(\epsilon)$ . We have

$$E(\epsilon) = E + \Delta_E. \quad (31)$$

Similarly for vectors:

$$\mathbf{x}(\epsilon) = \mathbf{x} + \delta_{\mathbf{x}}, \quad (32)$$

where  $\delta_{\mathbf{x}}$  is the error vector. For the next we suppose a Gaussian error distribution with the zero mean. Thus the covariance matrix of the noise vector is

$$C_{\mathbf{x}} = \mathbf{E}\{\delta_{\mathbf{x}}\delta_{\mathbf{x}}^T\}, \quad (33)$$

where  $\mathbf{E}$  denotes mathematical expectation. Assuming two variables  $x$  and  $y$  with small errors, we have

$$x(\epsilon)y(\epsilon) = xy + \delta_x y + x\delta_y + \delta_x\delta_y. \quad (34)$$

As  $\delta_x, \delta_y$  is supposed to be much smaller than other terms in equation (34) we can approximate the the error  $\delta_{xy}$  in  $x(\epsilon)y(\epsilon)$  as

$$\delta_{xy} = \delta_x y + x\delta_y + \delta_x\delta_y \cong \delta_x y + x\delta_y. \quad (35)$$

We keep the linear terms of the error and ignore the higher order terms. Later we use the sign  $\cong$  for the equations that are equal in the linear terms and  $\approx$  for the approximate equality in the usual sense.

Using equation (21) it can be easily verified that

$$EE^T = UD^2U^T, \quad (36)$$

$$E^TE = VD^2V^T. \quad (37)$$

$U$  and  $V$  are orthonormal matrices. Thus the columns of  $U$  are eigenvectors of  $EE^T$  resp. the columns of  $V$  are eigenvectors of  $E^TE$  ([7]). Both  $EE^T$  and  $E^TE$  are  $3 \times 3$  symmetric matrices. For the derivation of the error propagation we use the equation (36). Similarly it holds for equation (37).

Equation (36) can be rewritten as

$$U^{-1}EE^TU = \text{diag}\{\lambda_1, \lambda_2, \lambda_3\}. \quad (38)$$

The  $\lambda_i$  are the eigenvalues of the  $EE^T$  matrix. Recall that  $\sqrt{\lambda_i}$  are the singular values of  $E$ . Let them be ordered in non increasing order  $\lambda_1 \geq \lambda_2 \geq \lambda_3$ . Let express eigenvectors in one matrix

$$U = [\mathbf{u}_1, \mathbf{u}_2, \mathbf{u}_3], \quad (39)$$

where  $\mathbf{u}_1$  is an eigenvector associated with  $\lambda_1$ . Invoking equations (34) and (35) we write the perturbed  $EE^T$  matrix as

$$EE^T(\epsilon) = (E + \Delta_E)(E^T + \Delta_E^T) \stackrel{\cong}{=} EE^T + \Delta_{EE^T}, \quad (40)$$

where

$$\Delta_{EE^T} \cong \Delta_E E^T + E \Delta_E^T. \quad (41)$$

Let  $\mathbf{u}_1(\epsilon)$  be the eigenvector of the perturbed matrix  $EE^T(\epsilon)$  associated with the perturbed eigenvalue  $\lambda_1(\epsilon)$ . The  $\mathbf{u}_1(\epsilon)$  can be written as

$$\mathbf{u}_1(\epsilon) = \mathbf{u}_1 + \delta_{\mathbf{u}_1} \quad (42)$$

with  $\delta_{\mathbf{u}_1} \subset \text{span of}\{\mathbf{u}_2, \mathbf{u}_3\}$ . Letting  $\epsilon$  be the maximum absolute value of the elements  $\Delta_{EE^T}$ , we have

$$\Delta_{EE^T} = \epsilon B \quad (43)$$

with  $b_{ij} = \delta_{EE^T_{i,j}}/\epsilon$ . For a sufficiently small  $\epsilon$  the perturbation of  $\lambda_1$  can be expressed by a convergent series

$$\lambda_1(\epsilon) - \lambda_1 \stackrel{\cong}{=} \delta_{\lambda_1} = p_1\epsilon + p_2\epsilon^2 + p_3\epsilon^3 + \dots \quad (44)$$

and similarly the perturbation vector  $\delta_{\mathbf{u}_1}$  can be expressed by a convergent vector series in the span of  $U_2 = [\mathbf{u}_2, \mathbf{u}_3]$ . For sufficiently small  $\epsilon$  there exist 2-dimensional vectors  $\mathbf{g}_1, \mathbf{g}_2, \dots$  such that

$$\delta_{\mathbf{u}_1} = \epsilon U_2 \mathbf{g}_1 + \epsilon^2 U_2 \mathbf{g}_2 + \dots \quad (45)$$

If we consider just the linear term in equations (44) and (45) we have for the eigenvalue

$$\delta_{\lambda_1} \cong \mathbf{u}_1^T \Delta_{EE^T} \mathbf{u}_1. \quad (46)$$

For the eigenvector holds

$$\delta_{\mathbf{u}_1} \cong U \Delta_1 U^T \Delta_{EE^T} \mathbf{u}_1, \quad (47)$$

where  $\Delta_1$  is

$$\Delta_1 = \text{diag}\{0, (\lambda_1 - \lambda_2)^{-1}, (\lambda_1 - \lambda_3)^{-1}\}. \quad (48)$$

The proof can be found in the appendix of [17] or better with the more theoretical background in [18]. The equation (47) for the assessment of the error in the eigenvector is correct, but remember the properties of the exact essential matrix  $E$ , especially the equality of the nonzero singular values. Consequently the matrix  $EE^T$  or  $E^T E$  has also two equal eigenvalues,  $\lambda_1 - \lambda_2 = 0$ , in the ideal, noise free case. This equality produces an extremely high estimation of the error in the first and the second eigenvector. There is no good reason for such an extremely high assessment. The  $EE^T$  either  $E^T E$  is a real symmetric matrix *if, and only if* the equations (36) and (37) hold ([7]). And both matrices are always symmetric. So, we rewrite equation (47) as

$$\delta_{\mathbf{u}_1} \cong U_2 \Delta'_1 U_2^T \Delta_{EE^T} \mathbf{u}_1, \quad (49)$$

where

$$\Delta'_1 = \begin{bmatrix} \xi & 0 \\ 0 & \frac{1}{\lambda_1 - \lambda_3} \end{bmatrix}. \quad (50)$$

The variable  $\xi$  is defined as

$$\begin{aligned} \text{if } \left(\frac{\lambda_1 - \lambda_2}{\text{mean}[\lambda_1, \lambda_2]}\right) > \text{Tol} \quad \xi &= \frac{1}{\lambda_1 - \lambda_2} \\ \text{otherwise} \quad \xi &= 0, \end{aligned} \quad (51)$$

where  $Tol$  is a user defined tolerance. The  $\Delta'_2$  resp.  $\Delta'_3$  are defined alike.

Let us suppose that we know the  $C_E$ , the  $9 \times 9$  covariance matrix of the essential matrix. How can we estimate the covariance matrix of the eigenvalues of  $EE^T$ ,  $C_\lambda$ , and the covariance matrix of eigenvectors,  $C_U$ ? Recall that  $\delta_{\mathbf{EE}^T}$  is a vector containing the elements of the matrix  $\Delta_{EE^T}$ . We can rewrite equation (46) as

$$\delta_{\lambda_1} = \mathbf{u}_1^T [u_{11}I_3, u_{13}I_3, u_{13}I_3] \delta_{\mathbf{EE}^T} \stackrel{\text{p}}{=} G_{\mathbf{u}_1} \delta_{\mathbf{EE}^T}. \quad (52)$$

Where  $I_3$  is the  $3 \times 3$  identity matrix. Now we need to find the matrix  $G_{EE^T}$  such that

$$\delta_{\mathbf{EE}^T} = G_{EE^T} \delta_{\mathbf{E}}. \quad (53)$$

Using equation (41) we can deduce that

$$G_{EE^T} = \begin{bmatrix} 2E_{11} & 2E_{12} & 2E_{13} & 0 & 0 & 0 & 0 & 0 & 0 \\ E_{21} & E_{22} & E_{23} & E_{11} & E_{12} & E_{13} & 0 & 0 & 0 \\ E_{31} & E_{32} & E_{33} & 0 & 0 & 0 & E_{11} & E_{12} & E_{13} \\ E_{21} & E_{22} & E_{23} & E_{11} & E_{12} & E_{13} & 0 & 0 & 0 \\ 0 & 0 & 0 & 2E_{21} & 2E_{22} & 2E_{23} & 0 & 0 & 0 \\ 0 & 0 & 0 & E_{31} & E_{32} & E_{33} & E_{21} & E_{22} & E_{23} \\ E_{31} & E_{32} & E_{33} & 0 & 0 & 0 & E_{11} & E_{12} & E_{13} \\ 0 & 0 & 0 & E_{31} & E_{32} & E_{33} & E_{21} & E_{22} & E_{23} \\ 0 & 0 & 0 & 0 & 0 & 0 & 2E_{31} & 2E_{32} & 2E_{33} \end{bmatrix}. \quad (54)$$

Having  $G_{EE^T}$  we can replace equation (52) by the

$$\delta_{\lambda_1} = G_{\mathbf{u}_1} G_{EE^T} \delta_{\mathbf{E}} \stackrel{\text{p}}{=} D_{\lambda_1} \delta_{\mathbf{E}}. \quad (55)$$

Thus the square of the eigenvalue variance is

$$\text{var}^2(\lambda_1) = \mathbb{E}\{\delta_{\lambda_1}^T \delta_{\lambda_1}\} = D_{\lambda_1} C_E D_{\lambda_1}^T. \quad (56)$$

In a similar manner we deduce the variances of the other eigenvalues. For the eigenvectors we deduce by the same way

$$\begin{aligned} \delta_{\mathbf{u}_1} &= U_2 \Delta'_1 U_2^T [u_{11}I_3, u_{13}I_3, u_{13}I_3] \delta_{\mathbf{EE}^T}, \\ &\stackrel{\text{p}}{=} G_{U_1} \delta_{\mathbf{EE}^T}, \\ &= G_{U_1} G_{EE^T} \delta_{\mathbf{E}}, \\ &\stackrel{\text{p}}{=} D_{\mathbf{u}_1} \delta_{\mathbf{E}}. \end{aligned} \quad (57)$$

Therefore the  $3 \times 3$  covariance matrix of the first eigenvector is

$$C_{\mathbf{u}_1} = D_{\mathbf{u}_1} C_E D_{\mathbf{u}_1}^T. \quad (58)$$

We need the following to compute the covariance matrix  $C_V$  of  $V$ . The meanings of the symbols with  $V$  or  $\mathbf{v}$  are the same as with  $U$  resp.  $\mathbf{u}$ .

$$\delta_{\mathbf{v}_1} \cong V_2 \Delta_1' V_2^T \Delta_{E^T E} \mathbf{v}_1, \quad (59)$$

$$G_{E^T E} = \begin{bmatrix} 2E_{11} & 0 & 0 & 2E_{21} & 0 & 0 & 2E_{31} & 0 & 0 \\ E_{12} & E_{11} & 0 & E_{22} & E_{21} & 0 & E_{32} & E_{31} & 0 \\ E_{13} & 0 & E_{11} & E_{23} & 0 & E_{21} & E_{33} & 0 & E_{31} \\ E_{12} & E_{11} & 0 & E_{22} & E_{21} & 0 & E_{23} & E_{31} & 0 \\ 0 & 2E_{12} & 0 & 0 & 2E_{22} & 0 & 0 & 2E_{23} & 0 \\ 0 & E_{13} & E_{12} & 0 & E_{23} & E_{22} & 0 & E_{33} & E_{23} \\ E_{13} & 0 & E_{11} & E_{23} & 0 & E_{21} & E_{33} & 0 & E_{31} \\ 0 & E_{13} & E_{12} & 0 & E_{23} & E_{22} & 0 & E_{33} & E_{23} \\ 0 & 0 & 2E_{13} & 0 & 0 & 2E_{23} & 0 & 0 & 2E_{33} \end{bmatrix}. \quad (60)$$

The rest of the equations remains the same.

Now we want to compute the covariance matrices of  $U$  resp.  $V$  and the covariance matrix of the singular values,  $C_\sigma$  of  $E$  instead of the variances of the eigenvalues of  $EE^T$ . From (36), the equation for singular values follows directly:

$$\sigma_E = \sqrt{\lambda_{EE^T}}. \quad (61)$$

Generally we can write  $\sigma_E = f_{\lambda_\sigma}(\lambda_{EE^T})$ . The covariance matrix is

$$C_\sigma = J_{\lambda_\sigma} \text{diag}\{\text{var}^2(\lambda_i)\} J_{\lambda_\sigma}^T, \quad (62)$$

where  $J_{\lambda_\sigma}$  is the Jacobian matrix computed using equation (15). It is known that  $J_{\lambda_{\sigma_{ii}}} = \partial\sqrt{\lambda}/\partial\lambda$  is  $1/2\sqrt{\lambda}$ . A problem occurs when  $\lambda_3 = 0$  holds exactly. Recall that the equality  $\lambda_3 = 0$  demonstrates a good quality of the essential matrix. Thus there is no good reason to expect the variance estimation  $\rightarrow \infty$ . We put  $J_{\lambda_{\sigma_{ii}}} = 0$  instead of  $\infty$ , in this case. For the variance of the  $(\sigma_1 - \sigma_2)$  the holds:

$$\text{var}^2(\sigma_1 - \sigma_2) = [1 - 1] C_\sigma^{[1:2,1:2]} [1 - 1]^T, \quad (63)$$

where  $C_\sigma^{[1:2,1:2]}$  is the first  $2 \times 2$  submatrix of the  $C_\sigma$ . The  $U = [\mathbf{u}_1, \mathbf{u}_2, \mathbf{u}_3]$ . The  $9 \times 9$  covariance matrix  $C_U$  is

$$C_U = D_U C_E D_U^T, \quad (64)$$

where  $D_U$  is the  $9 \times 9$  matrix composed from the rows of  $D_{\mathbf{u}_i}$  matrices.

$$D_U = \begin{bmatrix} \mathbf{D}_{\mathbf{u}_{11}} \\ \mathbf{D}_{\mathbf{u}_{21}} \\ \mathbf{D}_{\mathbf{u}_{31}} \\ \mathbf{D}_{\mathbf{u}_{12}} \\ \mathbf{D}_{\mathbf{u}_{22}} \\ \mathbf{D}_{\mathbf{u}_{32}} \\ \mathbf{D}_{\mathbf{u}_{13}} \\ \mathbf{D}_{\mathbf{u}_{23}} \\ \mathbf{D}_{\mathbf{u}_{33}} \end{bmatrix}. \quad (65)$$

The same computation is done for  $C_V$ . Then the joint covariance matrix of  $U$  and  $V$  is:

$$C_{UV} = \begin{bmatrix} D_U \\ D_V \end{bmatrix} C_E \begin{bmatrix} D_U^T & D_V^T \end{bmatrix}. \quad (66)$$

### 3.6 Ego-motion algorithm taking into account uncertainty

We suppose the  $4 \times 4$  covariance matrix of the calibration parameters  $C_K$  to be given. The estimate of the calibration parameters, the  $3 \times 3$  calibration matrix  $K$ , is also supposed to be known. And we also assume we have at least eight correspondences in two images captured by the same camera from the different viewpoints. We want to estimate the variance of the difference between non-zero singular values of the essential matrix,  $\text{var}_{\sigma_1-\sigma_2}$  and the covariances of the motion parameters, the translation vector,  $C_t$ , and the Euler angles,  $C_{\mathcal{E}}$ . We use the sign  $\rightarrow$  for the denotation of something like “data flow”.

1. Uncalibrated coordinates (in pixels) of at least eight correspondences are in the  $N \times 3$  matrices  $Q_1, Q_2$ , where  $N$  is the number of correspondences.
2. Compute the fundamental matrix:  $Q_1, Q_2 \rightarrow F$  using equation (9).
3. Compute the essential matrix:  $K, F \rightarrow E$  using equation (10).
4. Estimate the covariance matrix of the essential matrix.  $C_K, K, F \rightarrow C_E$  using equation (19).
5. Decompose the essential matrix using the singular value decomposition:  $E \rightarrow U, V, \sigma$ , (21).
6. Calculate the covariance of singular values of the essential matrix:  $C_E, E \rightarrow C_\sigma$  using equation (62).
7. Get variance of the difference between the nonzero singular values:  $C_\sigma, \sigma \rightarrow \text{var}_{\sigma_1-\sigma_2}$  using equation (63)
8. Compute the auxiliary covariance matrices:  $E, C_E \rightarrow C_U, C_V$  using equations (64).
9. Create the covariance matrix of the rotation matrix and the covariance matrix of the translation vector:  $U, V, C_U, C_V \rightarrow C_R, C_t$  using equations (28) resp. (26).
10. Calculate the covariance matrix of Euler angles:  $C_R, R \rightarrow C_{\mathcal{E}}$  using equation (29).

## 4 Experiments

In the previous section we described how to estimate the uncertainty of the essential matrix, and consequently of the motion parameters. Several questions have arisen:

- How accurate is the analytic approach? Remember we use a first order approximation of the error.
- Which calibration parameters are more important in which type of motion or in which type of a scene?
- What happens when the  $F$  matrix is not exact, i.e. when there are some errors in the correspondences?



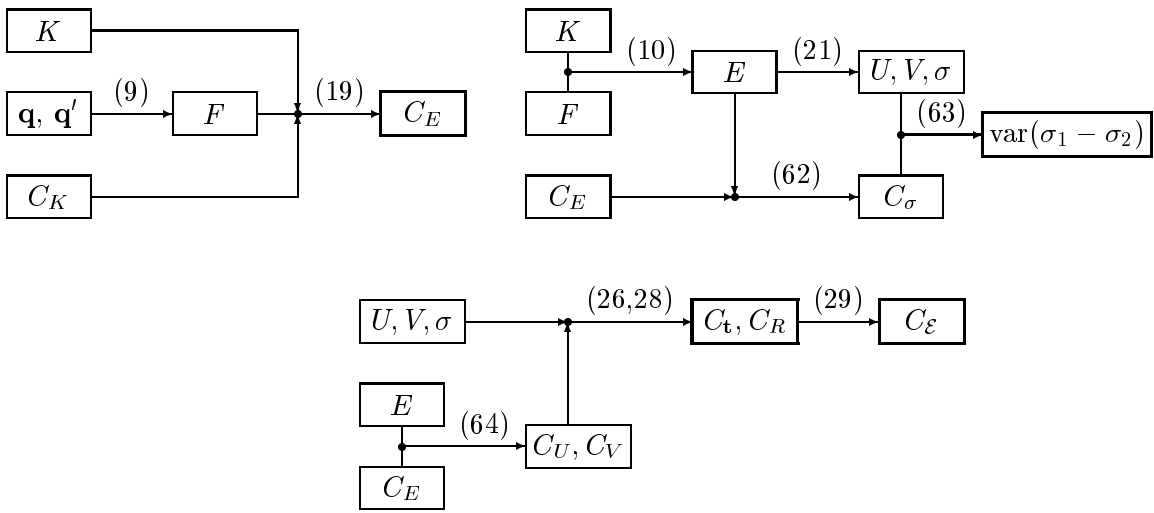

Figure 4: The schematic diagram of the algorithm.

It seems obvious that different types of camera motion altogether with the arrangement of the scene affect the influence of the precision of the calibration parameters on the motion parameters estimation. The magnitude of the motion could also affect that relationship. Actually the influence of the inaccuracy in the calibration parameters depends on the motion of correspondences.

We consider two types of an elementary motion. The lateral motion and the motion toward the scene. We use the synthetic scene “house with a tree”, 15 points were selected as points of interest, consequently their correspondences. The scene and two types of a motion are in Figure 5. How the correspondences move (disparity) due to these types of motion is shown in

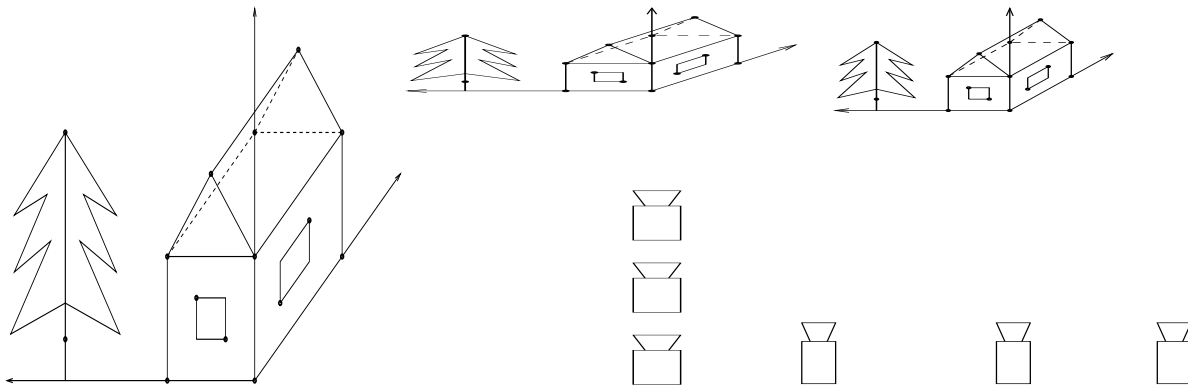

Figure 5: The house with points of interest (correspondences), the approaching, the lateral motion

Figure 6 resp. 7.

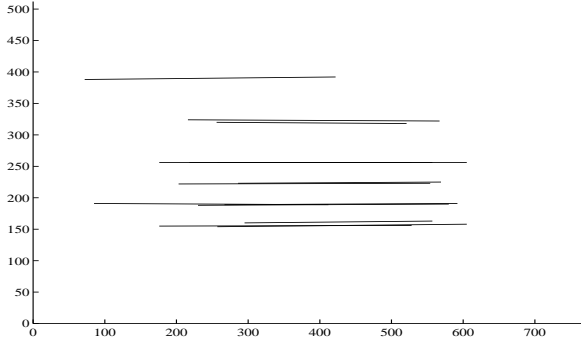

Figure 6: *Disparity of the lateral motion.*

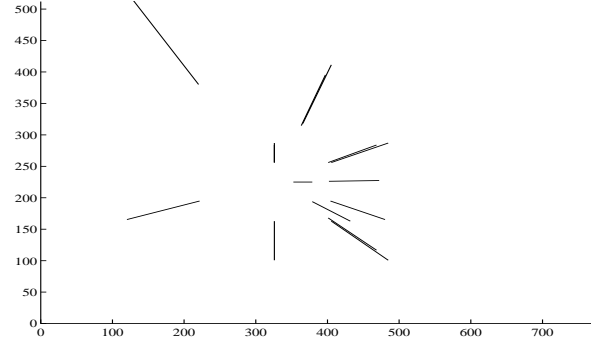

Figure 7: *Disparity of the "toward" motion.*

#### 4.1 What do we measure?

Remember that the equality of the nonzero singular value is a necessary and the sufficient condition for factorization  $E$  into the rotation matrix  $R$  and the skew-symmetric matrix  $S$ . Thus we investigate how the increasing uncertainty in the calibration parameters affects this quality parameter. In the same manner, we search the variances of the translation vector and the Euler angles. By the mathematic expression, we want to find such a quality function  $\mathcal{F}$ :

$$\text{var}(\sigma_1 - \sigma_2), \text{var}(\mathbf{t}_x), \text{var}(\mathbf{t}_y), \text{var}(\mathbf{t}_z), \text{var}(\varphi), \text{var}(\vartheta), \text{var}(\psi) = \mathcal{F}(K(\epsilon), R, \mathbf{t}, \mathbf{q}), \quad (67)$$

where  $K(\epsilon)$  is the perturbed calibration matrix,  $R$  and  $\mathbf{t}$  characterize a motion of the camera, and  $\mathbf{q}$  indicates the arrangement of the points. We compare the analytic assessment computed by equations described in the previous sections with the statistic approach. We characterize the uncertainty in the calibration parameters by the  $\gamma[\%]$ . Thus for the analytic approach:

$$C_K = \begin{bmatrix} (\frac{\gamma}{100}\alpha_u)^2 & C_{\alpha_u, \alpha_v} & C_{\alpha_u, u_0} & C_{\alpha_u, v_0} \\ C_{\alpha_u, \alpha_v} & (\frac{\gamma}{100}\alpha_v)^2 & C_{\alpha_v, u_0} & C_{\alpha_v, v_0} \\ C_{\alpha_u, u_0} & C_{\alpha_v, u_0} & (\frac{\gamma}{100}u_0)^2 & C_{u_0, v_0} \\ C_{\alpha_u, v_0} & C_{\alpha_v, v_0} & C_{u_0, v_0} & (\frac{\gamma}{100}v_0)^2 \end{bmatrix} \quad (68)$$

The elements exclusive of the diagonal express the dependency among the calibration parameters, see equation (13). In the statistic procedure we perturbed many times the calibration parameters by a Gaussian noise  $N(0, \sigma^2)$ , where  $\sigma^2$  is

$$\begin{aligned} \sigma^2 &= \frac{\gamma}{100}\alpha_u, & \text{for } \alpha_u, \\ \sigma^2 &= \frac{\gamma}{100}\alpha_v, & \text{for } \alpha_v, \\ \sigma^2 &= \frac{\gamma}{100}u_0, & \text{for } u_0, \\ \sigma^2 &= \frac{\gamma}{100}v_0, & \text{for } v_0, \end{aligned} \quad (69)$$

Since we want to simulate the situation when the calibration parameters are correlated we need to solve the problem how to generate the correlated random variables. The solution is described in appendix A. The relevant variances were computed using the standard equation (11). For instance for  $\mathbf{t}_x$  we compute

$$\text{var}^2(\mathbf{t}_x) = \text{E}\{(\mathbf{t}_x - \overline{\mathbf{t}_x})(\mathbf{t}_x - \overline{\mathbf{t}_x})^T\}, \quad (70)$$

where  $\overline{\mathbf{t}_x}$  is not the mean of all statistic data but then the value computed with  $\gamma = 0$ .

We suppose that corresponding points are located with pixel precision in the tests with the exact correspondences. The coordinates of the projected points are rounded to the nearest integer number. No mismatched points are supposed. In the graphs, lines with crosses indicate the statistical data and the pure lines indicate the linear estimation of the variances.

## 4.2 Approaching motion

The approaching or toward motion is very common in mobile robot applications. Thus mainly the estimation of the translation is very important. Firstly we test the effect of each calibration parameter separately. One hundred statistical tests were applied. Variances of the parts of the translation vector are showed in graphs 8, 9, 10, and 11. Three values in brackets in the upper left part of each graph are the normalized translation vector resp. Euler angles in the case of the rotation.

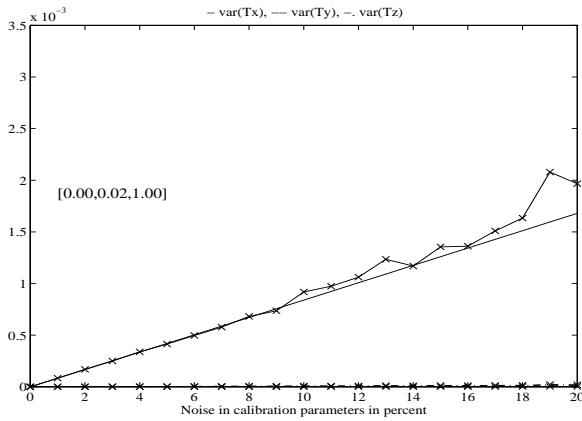

Figure 8: Approaching motion, variances in the translation. Noise in  $\alpha_u$ .

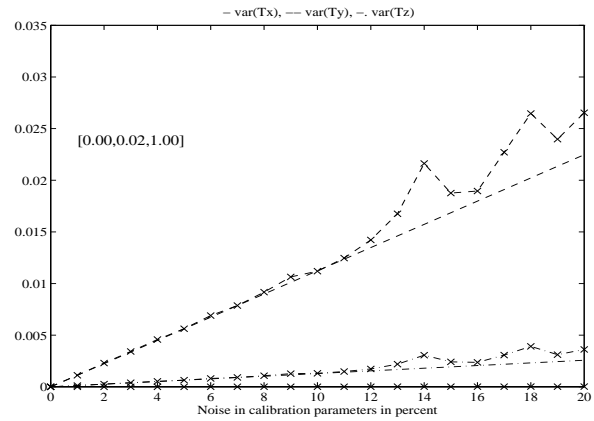

Figure 9: Approaching motion, variances in the translation. Noise in  $\alpha_v$ .

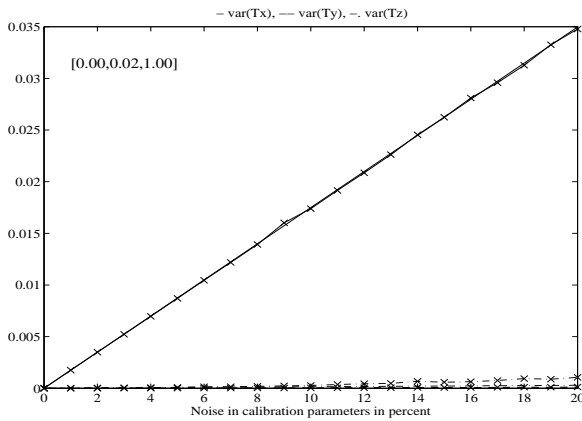

Figure 10: Approaching motion, variances in the translation. Noise in  $u_0$ .

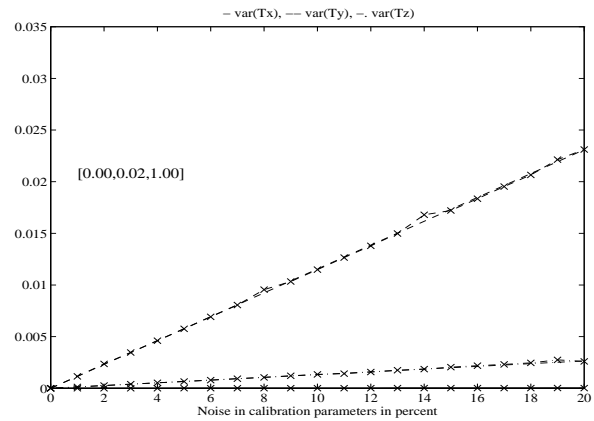

Figure 11: Approaching motion, variances in the translation. Noise in  $v_0$ .

We can observe the relation between “horizontal” resp. “vertical” parameters. The hor-

horizontal calibration parameters  $\alpha_u$  and  $u_0$  mainly affect the horizontal part of the translation vector  $\mathbf{t}_x$ . A similar dependency can be found for  $\alpha_v$  and  $v_0$  with  $\mathbf{t}_y$ . We can see the high credibility of the linear estimate.

The results for the Euler angles are in Figures 12, 13, 14, and 15.

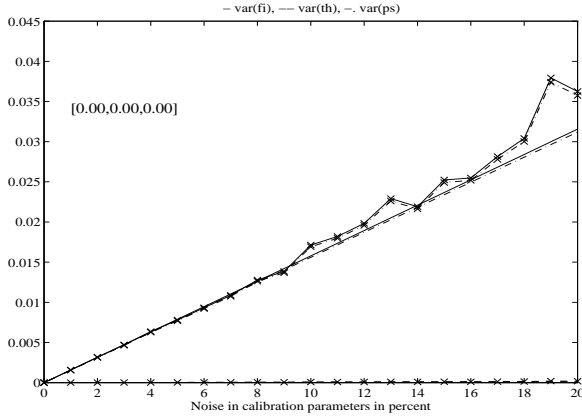

Figure 12: *Approaching motion, variances in the rotation. Noise in  $\alpha_u$ .*

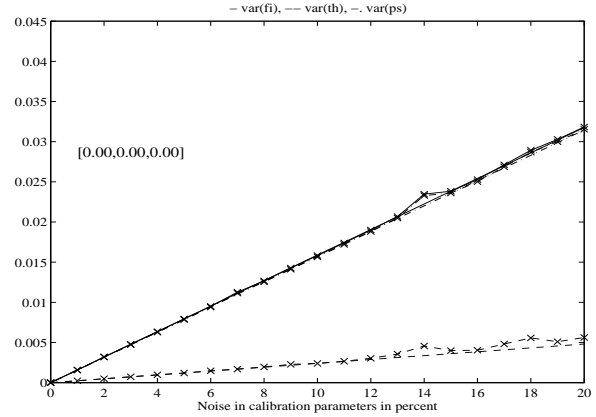

Figure 13: *Approaching motion, variances in the rotation. Noise in  $\alpha_v$ .*

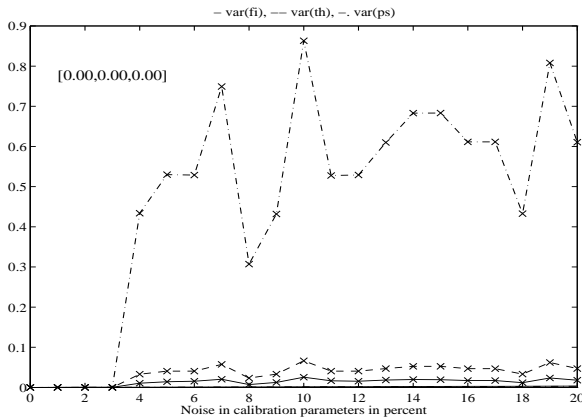

Figure 14: *Approaching motion, variances in the rotation. Noise in  $u_0$ .*

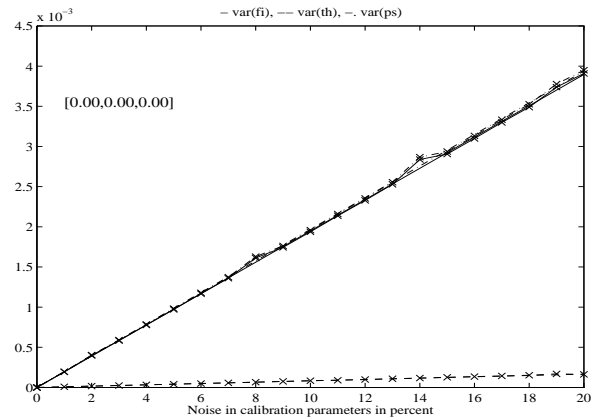

Figure 15: *Approaching motion, variances in the rotation. Noise in  $v_0$ .*

We can see the relatively high variances of the angles  $\varphi$  and  $\psi$ . However this situation could be expected. When the angle  $\vartheta$  is very close to zero, a rotation can be expressed by an arbitrary  $\varphi = -\psi$ . Problems with the linear estimate can be observed in Figure 14. Problems can be caused by the ambiguity mentioned above. We can not find the unique relation between the calibration parameters and the rotation angles as in the case of the translation vector.

Since we would like to simulate realistically the real camera we also did the tests with the correlated noise in the calibration parameters. Florou and Mohr said in [4] that the most significant correlation is between  $\alpha_u$  and  $\alpha_v$  and it is close to  $-1$ . We did tests with  $r_{\alpha_u, \alpha_v} = -0.95$ . The motion and the correspondences are the same as in the case of particular tests. The results are in Figures 16 and 17.

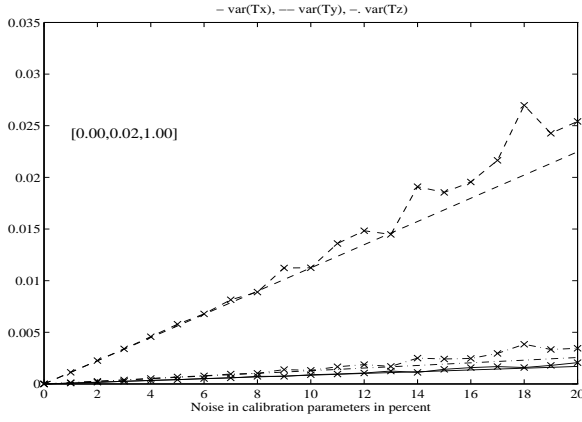

Figure 16: *Approaching motion, variances in the translation. Noise in  $\alpha_u$  and in  $\alpha_v$ , correlation  $r_{\alpha_u, \alpha_v} = -0.95$ .*

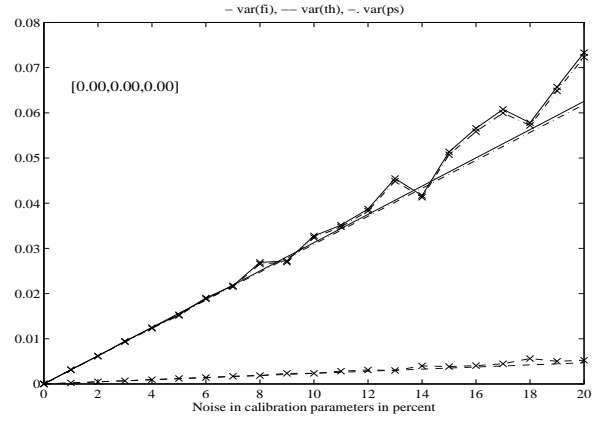

Figure 17: *Approaching motion, variances in the rotation. Noise in  $\alpha_u$  and in  $\alpha_v$ , correlation  $r_{\alpha_u, \alpha_v} = -0.95$ .*

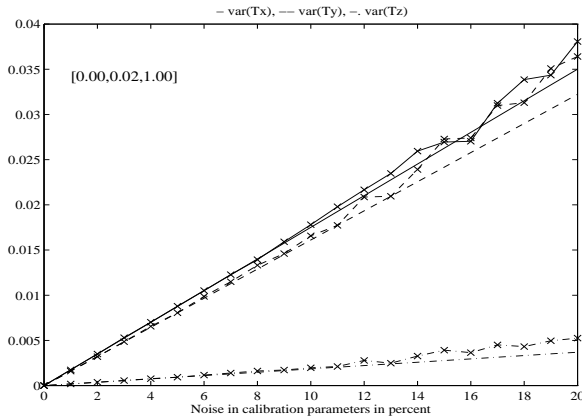

Figure 18: *Approaching motion, variances in the translation. Noise in all calibration parameters, correlation  $r_{\alpha_u, \alpha_v} = -0.95$ .*

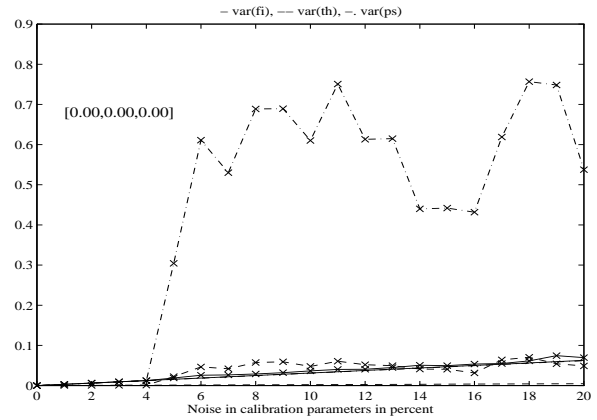

Figure 19: *Approaching motion, variances in the rotation. Noise in all calibration parameters, correlation  $r_{\alpha_u, \alpha_v} = -0.95$ .*

No essential differences can be observed with the comparison to the tests with the particular effect. The results are very close to the superposition of the graphs relating to  $\alpha_u$  and  $\alpha_v$ .

Finally, we tested the case when all calibration parameters are noisy with the correlation between  $\alpha_u$  and  $\alpha_v$  as in the previous test. This situation corresponds to the observation in [4]. The results are in Figures 18 and 19. We can see similar problems with the linear estimate of variances of the Euler angles as in Figure 14.

Anyway, the problem is the credibility of the linear estimate. We increase the noise magnitude up to 100% for all noisy calibration parameters. The correlation  $r_{\alpha_u, \alpha_v} = -0.95$ . Recall to brutal noise. If the noise magnitude is more than 20% the camera parameters can completely change. One thousand cycles for the statistic approach were used. The results are in Figure 20. The breakdown point can be observed around 20% noise in the case of the translation vector and the difference of the nonzero singular values and around 10% in the case of Euler angles. The linear estimate of the variances  $\mathbf{t}$  and of the variance  $(\sigma_1 - \sigma_2)$  (the non zero

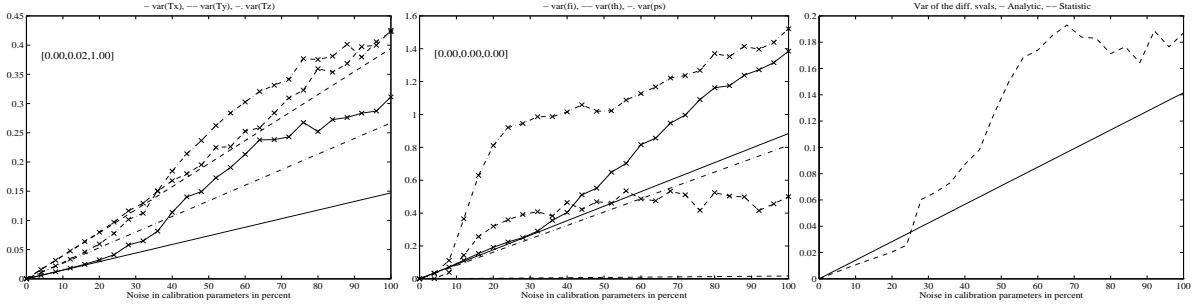

Figure 20: *The linear estimate versus statistics in the case of a large noise. From left to right: Variances in translation vectors, in Euler angles, and variance of the difference between nonzero singular values of the essential matrix.*

singular values of  $E$ ) is more stable than the estimation of the uncertainty in the rotation.

### 4.3 Lateral motion

The lateral motion and the rotation around y-axis affects nearly the same motion of correspondences or motion field. Thus it is very difficult to distinguish between these two possibilities. We did the same tests for the lateral motion as for the approaching motion. The results are in Figures 21, 22, 23, 24, 25, 26, 27 and 28.

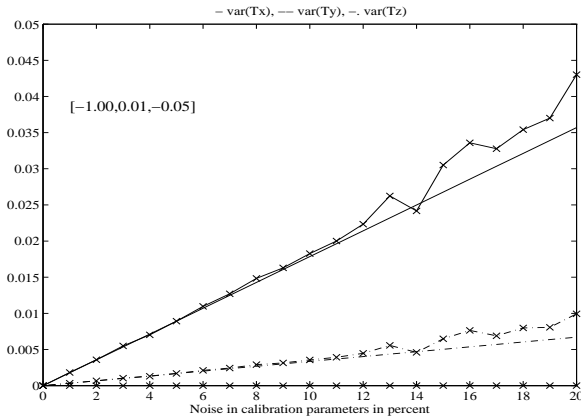

Figure 21: *Lateral motion, variances in the translation. Noise in  $\alpha_u$ .*

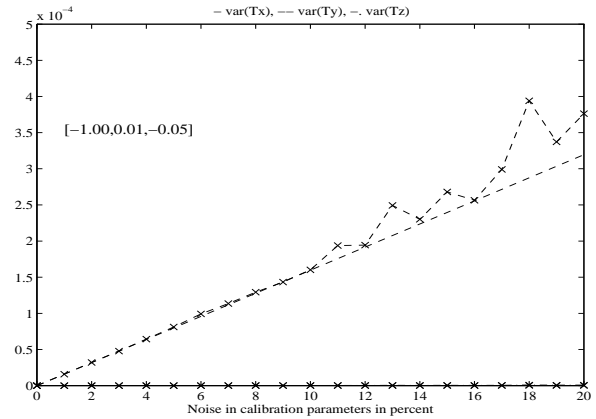

Figure 22: *Lateral motion, variances in the translation. Noise in  $\alpha_v$ .*

Observing the graphs with variances in the translation vector, we can find a similar relationship between “horizontal” parameters and between “vertical” parameters as in the approaching motion. However the linear estimate of the variances in the Euler angles spoils. More in detail, we can observe that noise in  $\alpha_u$  and  $u_0$  causes the bad estimate in the angle  $\vartheta$  which characterizes the rotation around the y-axis. The “vertical” calibration parameters mostly influence angles which characterize rotation around z-axis. Remember if  $\varphi = -\psi$  holds the values can be arbitrary in the case  $\vartheta = 0$ . We say more about this problem in the section 4.4.

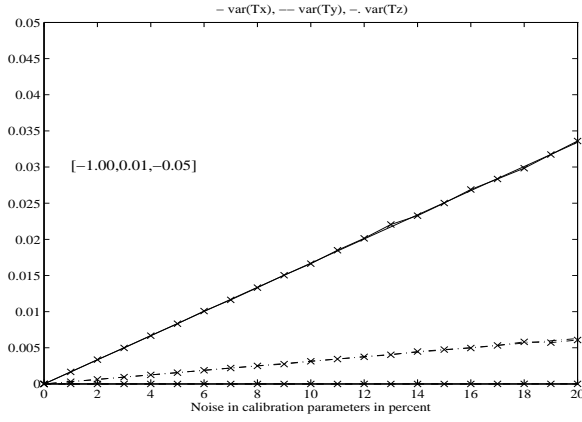

Figure 23: *Lateral motion, variances in the translation. Noise in  $u_0$ .*

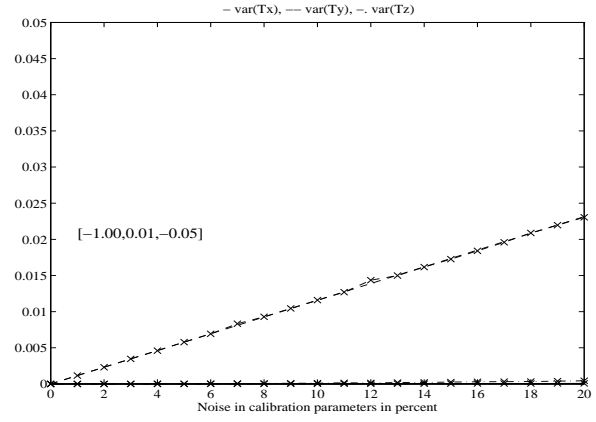

Figure 24: *Lateral motion, variances in the translation. Noise in  $v_0$ .*

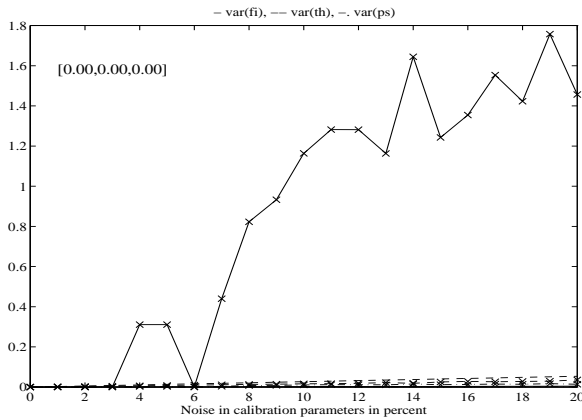

Figure 25: *Lateral motion, variances in the rotation. Noise in  $\alpha_u$ .*

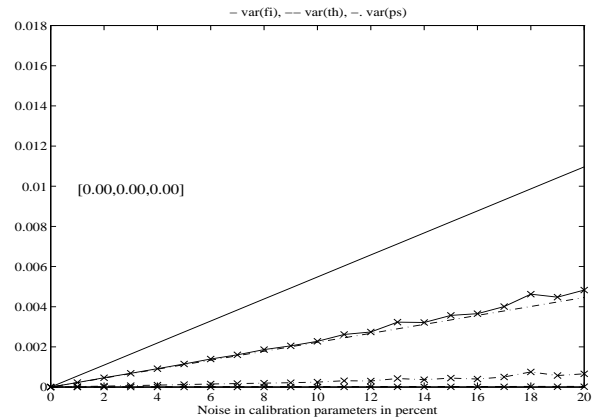

Figure 26: *Lateral motion, variances in the rotation. Noise in  $\alpha_v$ .*

#### 4.4 General motion

We were faced to the problem of the low credibility of the linear estimate in the Euler angles variances In the previous section. The question is, when can we consider this linear estimate as trustworthy? We did many tests and we observed that the problem appears when the motion along the z-axis direction is small. The estimate of the rotation is unstable in the case of the motion which is close to the lateral one. The successful estimate both for translation and for rotation when all calibration parameters are noisy is illustrated in Figure 29 and 30. more than 5% the variances of the Euler angles are too high. Therefore we can say that parameters of the rotation are much more sensitive to uncertainty in the calibration parameters than the translation vector.

#### 4.5 Which estimate for noisy data?

Remember that we assume exact coordinates of correspondences with only pixel accuracy. Now we want to investigate how the reliability of the linear estimate changes with noisy correspon-

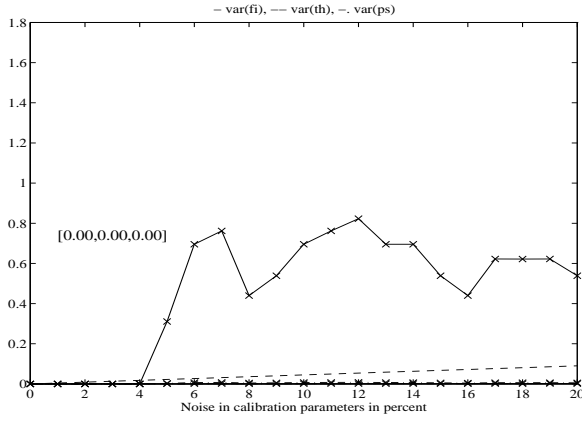

Figure 27: Lateral motion, variances in the rotation. Noise in  $u_0$ .

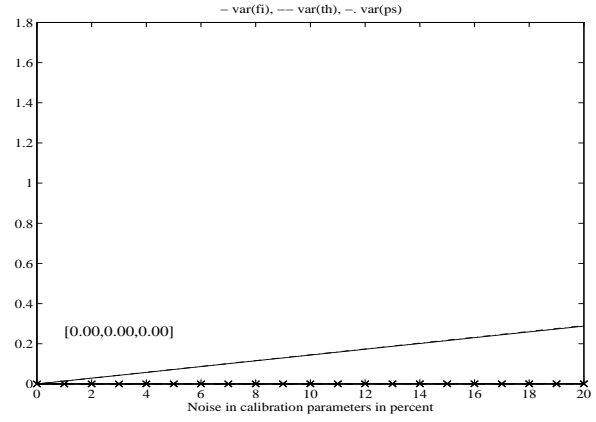

Figure 28: Lateral motion, variances in the rotation. Noise in  $v_0$ .

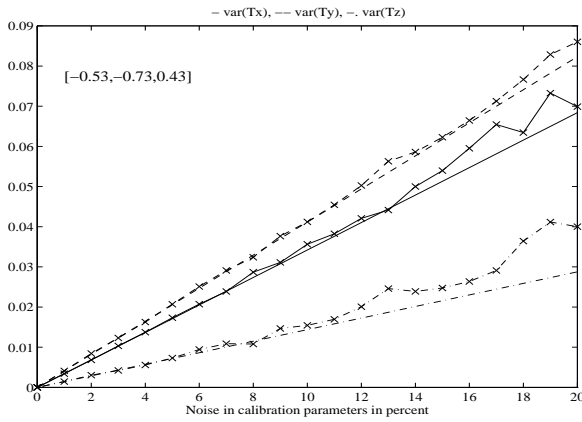

Figure 29: General motion, variances in the translation. Noise in all calibration parameters, correlation  $r_{\alpha_u, \alpha_v} = -0.95$ .

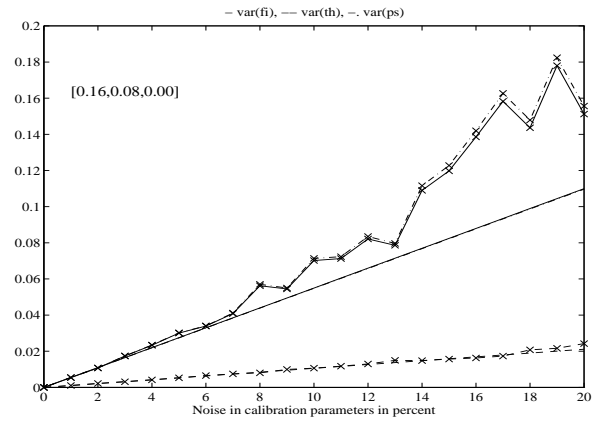

Figure 30: General motion, variances in the rotation. Noise in all calibration parameters, correlation  $r_{\alpha_u, \alpha_v} = -0.95$ .

dences. We have the general motion also with rotation. Since we suppose more problems we test the calibration uncertainty up to 10%. The most general noise in all calibration parameters with correlation  $r_{\alpha_u, \alpha_v} = -0.95$  is applied. We add a Gaussian noise  $N(0, \sigma^2)$  to the coordinates of the correspondences then the coordinates are quantized to the nearest pixel. Fifty statistic tests were applied to generate noisy calibration matrix and fifty tests were used to generate noisy correspondences. Results for the data perturbed by quantization noise only is in Figure 31. Figure (32) shows the results for data perturbed by Gaussian noise with  $\sigma^2 = 1$  pixel and by a quantization noise. We can observe high credibility of the estimate for the translation and high statistical variance of  $\varphi$  angle. However the high linear estimate for this angle signalizes a low credibility of the estimated rotation.



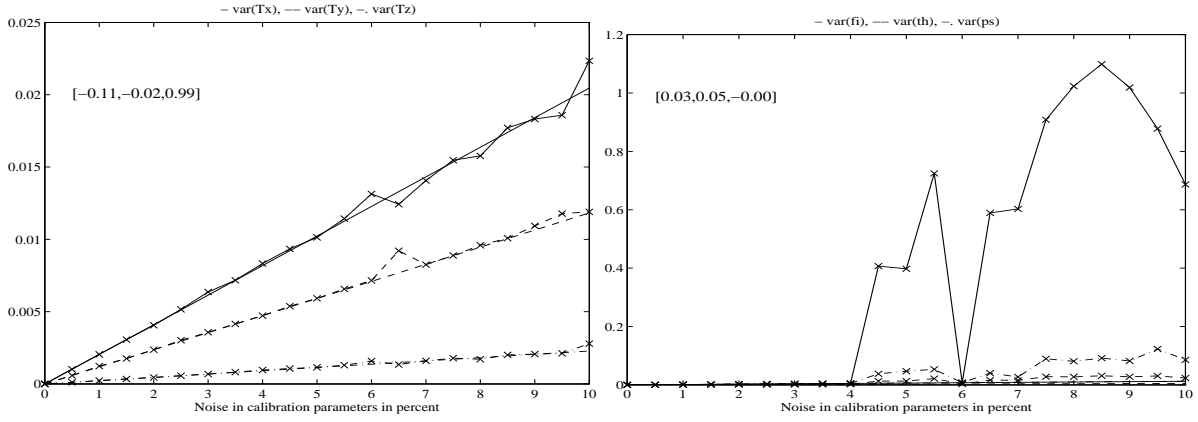

Figure 31: *General motion, noise in all calibration parameters, correspondences perturbed by quantization noise (exact data).*

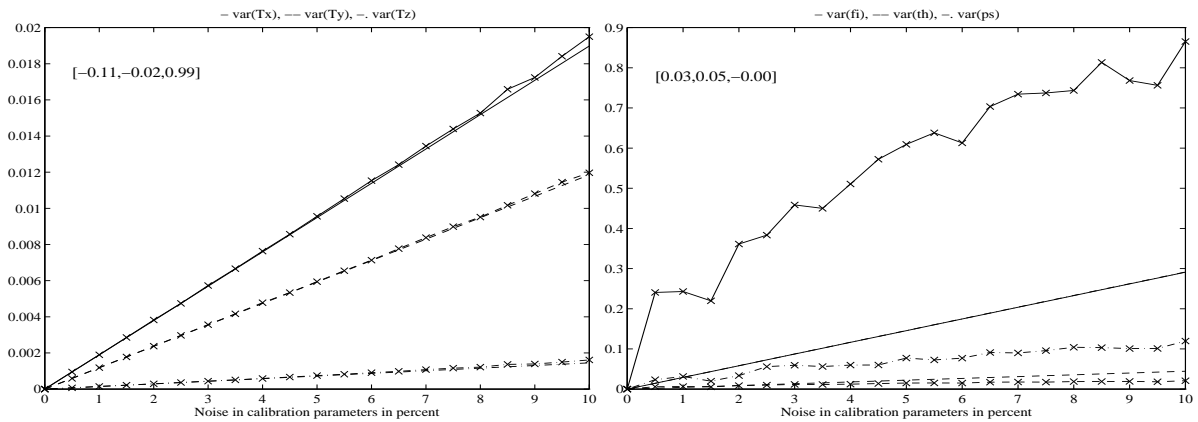

Figure 32: *General motion, noise in all calibration parameters, correspondences perturbed by Gaussian noise  $N(0, 1\text{pixel})$  and by quantization noise.*

## 5 Conclusion

We have presented an algorithm for the estimate of the variances of the camera motion parameters of the camera when we can characterize the uncertainty in the calibration parameters by their covariance matrix. We used the first order approximation to linearize the nonlinear relationship between the calibration parameters and the motion parameters. We have done tests with synthetic scenes, correspondences were located with only pixel accuracy, i.e. no subpixel technique for the localization of the correspondences was supposed. We found that the estimate of the translation uncertainty is very stable and useful. We have found that the accuracy in the “horizontal” calibration parameters,  $\alpha_u$  and  $u_0$ , affects mainly the “horizontal” part of the translation,  $\mathbf{t}_x$ . We have observed the similar relationship for the “vertical” parameters,  $\alpha_v, v_0, \mathbf{t}_y$ . The estimate of the variance of the non-zero singular values difference was observed as very stable and credible and we hope that it can be used to increase the efficiency of the algorithm [14]. However, the estimate of the rotation uncertainty fails when the motion is close to the lateral one. To solve this problem it is necessary either to improve the algorithm or to employ an other representation of the rotation. We have not found such a definite relationship

for the rotation parameters as in the translation ones. In addition we have observed that the rotation parameters are more sensitive to the accuracy in the calibration.

Several questions remain for the future work. We need to improve the algorithm for the estimate rotation. We plan to associate the presented algorithm with the algorithm [17] to include the uncertainty in the correspondences. We would like to derive an algorithm for the estimate of the error in the 3-D reconstruction. Is it possible to include the rough information about the camera into the algorithms utilizing more images?

## Acknowledgements

This work was partly done during Tomáš Svoboda's four month visit in MOVI group in spring 1996. T. Svoboda acknowledges Prof. Roger Mohr who enabled this stay. Thanks to Radim Šára giving us the advice with the problem of the generating correlated artificial noise.

## A How to create correlated random variables

Imagine that we want to generate  $N$  times four random variables  $x, y, w, z$  with the mutual covariance matrix  $C_{xyzw}$ . In a matrix form, we need

$$N_{xyzw} = \begin{bmatrix} x_1 & y_1 & w_1 & z_1 \\ x_2 & y_2 & w_2 & z_2 \\ \vdots & \vdots & \vdots & \vdots \\ x_N & y_N & w_N & z_N \end{bmatrix}. \quad (71)$$

Firstly generate the random matrix  $X$  (the same size as  $N_{xyzw}$ ) using a standard random generator for Gaussian noise. Compute the covariance matrix  $C_X$ . Thus

$$N_{xyzw} = XA, \quad (72)$$

where

$$A = (\sqrt{C_X})^{-1} \sqrt{C_{xyzw}}. \quad (73)$$

**Proof:** Using equation (12), the covariance matrix of the generated random data is

$$C_{xyzw} = A^T C_X A. \quad (74)$$

The above equation can be rewritten as:

$$C_{xyzw} = \sqrt{C_{xyzw}} \sqrt{C_{xyzw}} = (\sqrt{C_X} A)^T (\sqrt{C_X} A). \quad (75)$$

Now it is easy to derive equation (73).

## References

- [1] Martin Armstrong, Andrew Zisserman, and Richard Hartley. Self-calibration from image triplets. In Bernard Buxton and Roberto Cipolla, editors, *4th European Conference on Computer Vision 1996*, pages 1–16. Springer-Verlag, LNCS 1064, April 1996.

- [2] Gabriella Csurka, Cyril Zeller, Zhengyou Zhang, and Olivier Faugeras. Characterizing the uncertainty of the fundamental matrix. Research report 2560, INRIA, June 1995.
- [3] D. Olivier Faugeras. What can be seen in three dimensions with an uncalibrated stereo rig? In *2nd European Conference on Computer Vision 1992*, pages 563–578. Springer-Verlag, LNCS 588, 1994.
- [4] Giannoula Florou and Roger Mohr. What accuracy for 3D measurement with cameras? In *International Conference on Pattern Recognition 1996*, pages 354–358, Los Alamitos, California, August 1996. IEEE Computer Society Press.
- [5] R.I. Hartley. Euclidean reconstruction from uncalibrated views. In *DARPA-ESPIRIT workshop on Applications of Invariance in Computer Vision*, pages 187–202, October 1993.
- [6] Richard I. Hartley. Estimation of relative camera positions for uncalibrated cameras. In *2nd European Conference on Computer Vision*, pages 579–587. Springer - Verlag,, May 1992.
- [7] Roger A. Horn and Charles R. Johnson. *Matrix Analysis*. Cambridge University Press, 1985. 1987 reprinted with corrections, 1988,1990,1991,1992,1993.
- [8] T.S. Huang and O.D. Faugeras. Some properties of the e matrix in two-view motion estimation. *IEEE Transactions on Pattern Analysis and Machine Inteligence*, 11(12):1310–1312, December 1989.
- [9] Peter J. Huber. *Robust Statistics*. Willey series in probability and mathematical statistics. John Willey and Sons, 1981.
- [10] Kenichi Kanatani. *Group-Theoretic Methods in Image Understanding*. Springer-Verlag, 1990.
- [11] H.C. Longuet-Higgins. A computer algorithm for reconstruction a scene from two projections. *Nature*, pages 133–135, 1981.
- [12] Quang-Tuan Luong, Rachid Deriche, Olivier Faugeras, and Theo Papadopoulo. On determining the fundamental matrix: Analysis of different methods and experimental results. Research report 1894, INRIA, Avril 1993.
- [13] Stephen J. Maybank and Olivier D. Faugeras. A theory of self-calibration of a moving camera. *IEEE Journal Computer Vision*, 8(2):123 – 151, april 1992.
- [14] T. Svoboda and T. Pajdla. Efficient motion analysis. Research report K335/95/95, CTU FEE, October 1995. 29 pages.
- [15] P.H.S. Torr and D.V. Murray. A review of robust methods to estimate the fundamental matrix. submitted to IJCV, 1995.
- [16] Roger Y. Tsai. A versatile camera calibration technique for high-accuracy 3D machine vision metrology using off-the-shelf cameras and lenses. *IEEE Journal of Robotics and Automation*, RA-3(4):323 – 344, August 1987.

- [17] Juyang Weng, Thomas S. Huang, and Ahuja Narendra. Motion and structure from two perspective views: Algorithms, error analysis, and error estimation. *IEEE Transactions on Pattern Analysis and Machine Intelligence*, 11(5):451–476, May 1989.
- [18] J.H. Wilkinson. *The Algebraic Eigenvalue Problem*. Oxford University Press, 1965.