



HAL
open science

Model-free control of dc/dc converters

Loïc Michel, Cédric Join, Michel Fliess, Pierre Sicard, Ahmed Chériti

► **To cite this version:**

Loïc Michel, Cédric Join, Michel Fliess, Pierre Sicard, Ahmed Chériti. Model-free control of dc/dc converters. 12th IEEE Workshop on Control and Modeling for Power Electronics (COMPEL), Jun 2010, Boulder, Colorado, United States. pp.CDROM, 10.1109/COMPEL.2010.5562385 . inria-00495776

HAL Id: inria-00495776

<https://inria.hal.science/inria-00495776>

Submitted on 29 Jun 2010

HAL is a multi-disciplinary open access archive for the deposit and dissemination of scientific research documents, whether they are published or not. The documents may come from teaching and research institutions in France or abroad, or from public or private research centers.

L'archive ouverte pluridisciplinaire **HAL**, est destinée au dépôt et à la diffusion de documents scientifiques de niveau recherche, publiés ou non, émanant des établissements d'enseignement et de recherche français ou étrangers, des laboratoires publics ou privés.

Model-free control of dc/dc converters

Loïc MICHEL¹, Cédric JOIN², Michel FLIESS³, Pierre SICARD¹ and Ahmed CHÉRITI¹

¹ GRÉI - Département de Génie Électrique et Génie Informatique
Université du Québec à Trois-Rivières

C.P. 500, Trois-Rivières G9A 5H7, Canada, QC

E-mail: {Loic.Michel, Pierre.Sicard, Ahmed.Cheriti}@uqtr.ca

² INRIA-ALIEN & CRAN (CNRS, UMR 7039)

Nancy-Université, BP 239, 54506 Vandœuvre-lès-Nancy, France

E-mail: cedric.join@cran.uhp-nancy.fr

³ INRIA-ALIEN & LIX (CNRS, UMR 7161)

École polytechnique, 91128 Palaiseau, France

E-mail: Michel.Fliess@polytechnique.edu

Abstract—A new “model-free” control methodology is applied for the first time to power converters, and in particular to a buck converter, and to a Ćuk converter. We evaluate its performances regarding load and supply variations. Our approach, which utilizes “intelligent” PI controllers, does not require any converter identification while ensuring the stability and the robustness of the control synthesis. Simulation and experimental results show that, with a simple control structure, insensitivity to power supply fluctuations and to large load variations is ensured.

Index Terms—dc/dc converters, buck converters, Ćuk converters, model-free control, intelligent PI controllers, numerical differentiation.

I. INTRODUCTION

The digital control of dc/dc converters has been deeply studied in recent years in order to improve dynamic performances and preserving converter robustness including disturbance rejection properties. Classical control methods, such that PID [1], are very efficient when

- the converter model is well-known,
- the working-point of the load is well defined.

If the dynamics of the whole converter is more complex, varying and/or uncertain, advanced control laws have to be introduced:

- In [2] a comparison is carried on for generalized PI (GPI) controllers, sliding mode methods, and various backstepping and linearization techniques. According to [3], even if stability is guaranteed, those control designs are perhaps a little bit too involved for practitioners.
- More recently, adaptive control law has been developed in [4], [5], [6], a fractional order control strategy in [7], a fuzzy control in [8], [9], and genetic algorithms in [10].
- Robust control theory is used for power converters with wide changes in operating conditions in [11], [12], [13]. Although robust control can ensure robustness to load and parameter model variations, it is difficult to design it without a solid mathematical background and advanced design tools [14]. In most cases, moreover, the load with its uncertainties must be characterized to ensure stability

and optimal dynamic performance, and this condition is almost always impossible to satisfy.

We evaluate here the performances of a new “model-free” control design ([15], [16]) applied to nonlinear dc/dc converters with unknown loads. Model-free control and its corresponding “intelligent” PID controllers yield a controller that is continuously updated according to the dynamic changes of the whole converter (including its load). The whole converter is modeled as a lumped reduced order model, defined only for a small time duration and no identification procedure is needed.

The paper is structured as follows. Section II presents an overview of the model-free control methodology including its advantages in comparison with more classical methodologies. Section III discusses the application of the model-free control to the simulated buck converter. Section IV contains some experimental results and is devoted to the Ćuk converter. Some concluding remarks may be found in Section V.

II. MODEL-FREE CONTROL: A BRIEF OVERVIEW

A. General principles

1) *The ultra-local model:* We only assume that the plant behavior is well approximated in its operational range by a system of ordinary differential equations, which might be highly nonlinear and time-varying.¹ The system, which is SISO, may be therefore described by the input-output equation

$$E(t, y, \dot{y}, \dots, y^{(\iota)}, u, \dot{u}, \dots, u^{(\kappa)}) = 0 \quad (1)$$

where

- u and y are the input and output variables,
- E , which might be unknown, is assumed to be a sufficiently smooth function of its arguments.

Assume that for some integer n , $0 < n \leq \iota$, $\frac{\partial E}{\partial y^{(n)}} \neq 0$. From the implicit function theorem we may write locally

$$y^{(n)} = \mathfrak{E}(t, y, \dot{y}, \dots, y^{(n-1)}, y^{(n+1)}, \dots, y^{(\iota)}, u, \dot{u}, \dots, u^{(\kappa)})$$

¹See [15], [16] for further details.

By setting $\mathfrak{E} = F + \beta u$ we obtain the *ultra-local* model

$$y^{(n)} = F + \beta u \quad (2)$$

where

- $\beta \in \mathbb{R}$ is a *non-physical* constant parameter, such that F and βu are of the same magnitude;
- the numerical value of F , which contains the whole “structural information”, is determined thanks to the knowledge of u , β , and of the estimate of the derivative $y^{(n)}$.

In all the numerous known examples it was possible to set $n = 1$ or 2 .

2) *Numerical value of β* : Let us emphasize that one only needs to give an approximate numerical value to β . It would be meaningless to refer to a precise value of this parameter.

B. Intelligent PI controllers

1) *Generalities*: If $n = 1$, we close the loop via the *intelligent PI controller*, or *i-PI controller*,

$$u = -\frac{F}{\beta} + \frac{\dot{y}^*}{\beta} + K_P e + K_I \int e \quad (3)$$

where

- y^* is the output reference trajectory, which is determined via the rules of flatness-based control ([17], [18]);
- $e = y^* - y$ is the tracking error;
- K_P , K_I are the usual tuning gains.

The i-PI controller (3) is compensating the poorly known term F . Controlling the system therefore boils down to the control of a precise and elementary pure integrator. The tuning of the gains K_P and K_I becomes therefore quite straightforward.

2) *Classic controllers*: See [19] for a comparison with classic PI controllers.

3) *Applications*: See [20], [21], [22], [23], [24], [25], [26] for already existing applications in various domains.

C. Numerical differentiation of noisy signals

Numerical differentiation, which is a classic field of investigation in engineering and in applied mathematics, is a key ingredient for implementing the feedback loop (3). Our solution has already played an important role in model-based nonlinear control and in signal processing (see [27] for further details and related references).

The estimate of the 1st order derivative of a noisy signal y reads (see, e.g., [28])

$$\hat{y} = -\frac{3!}{T^3} \int_0^T (T - 2t)y(t)dt$$

where $[0, T]$ is a quite “short” time window.² This window is sliding in order to get this estimate at each time instant.

²It implies in other words that we obtain real-time techniques.

Denoising of y leads to the estimate

$$\hat{y} = \frac{2!}{T^2} \int_0^T (2T - 3t)y(t)dt$$

The above results are the basis of our estimation techniques. Important theoretical developments, which are of utmost importance for the computer implementation, may be found in [29].

D. An first academic example: a stable monovaryable linear system

Introduce as in [15], [16] the stable transfer function

$$\frac{(s + 2)^2}{(s + 1)^3} \quad (4)$$

1) *A classic PID controller*: We apply the well known method due to Bröida (see, e.g., [30]) by approximating System (4) via the following delay system

$$\frac{K e^{-\tau s}}{(Ts + 1)}$$

$K = 4$, $T = 2.018$, $\tau = 0.2424$ are obtained thanks to graphical techniques. The gain of the PID controller are then deduced [30]: $K_P = \frac{100(0.4\tau + T)}{120K\tau} = 1.8181$, $K_I = \frac{1}{1.33K\tau} = 0.7754$, $K_D = \frac{0.35T}{K} = 0.1766$.

2) *i-PI*: We are employing $\dot{y} = F + u$ and the i-PI controller

$$u = -[F]_e + \dot{y}^* + \text{PI}(e)$$

where

- $[F]_e = [\dot{y}]_e - u$,
- y^* is a reference trajectory,
- $e = y^* - y$,
- $\text{PI}(e)$ is an usual PI controller.

3) *Numerical simulations*: Figure 1(a) shows that the i-PI controller behaves only slightly better than the classic PID controller (Fig. 1(b)). When taking into account on the other hand the ageing process and some fault accommodation there is a dramatic change of situation: Figure 1(c) indicates a clear cut superiority of our i-PI controller if the ageing process corresponds to a shift of the pole from 1 to 1.5, and if the previous graphical identification is not repeated (Fig. 1(d)).

4) *Some consequences*:

- It might be useless to introduce delay systems of the type

$$T(s)e^{-Ls}, \quad T \in \mathbb{R}(s), \quad L \geq 0$$

for tuning classic PID controllers, as often done today in spite of the quite involved identification procedure.

- This example demonstrates also that the usual mathematical criteria for robust control become to a large irrelevant.
- As also shown by this example some fault accommodation may also be achieved without having recourse to a general theory of diagnosis.

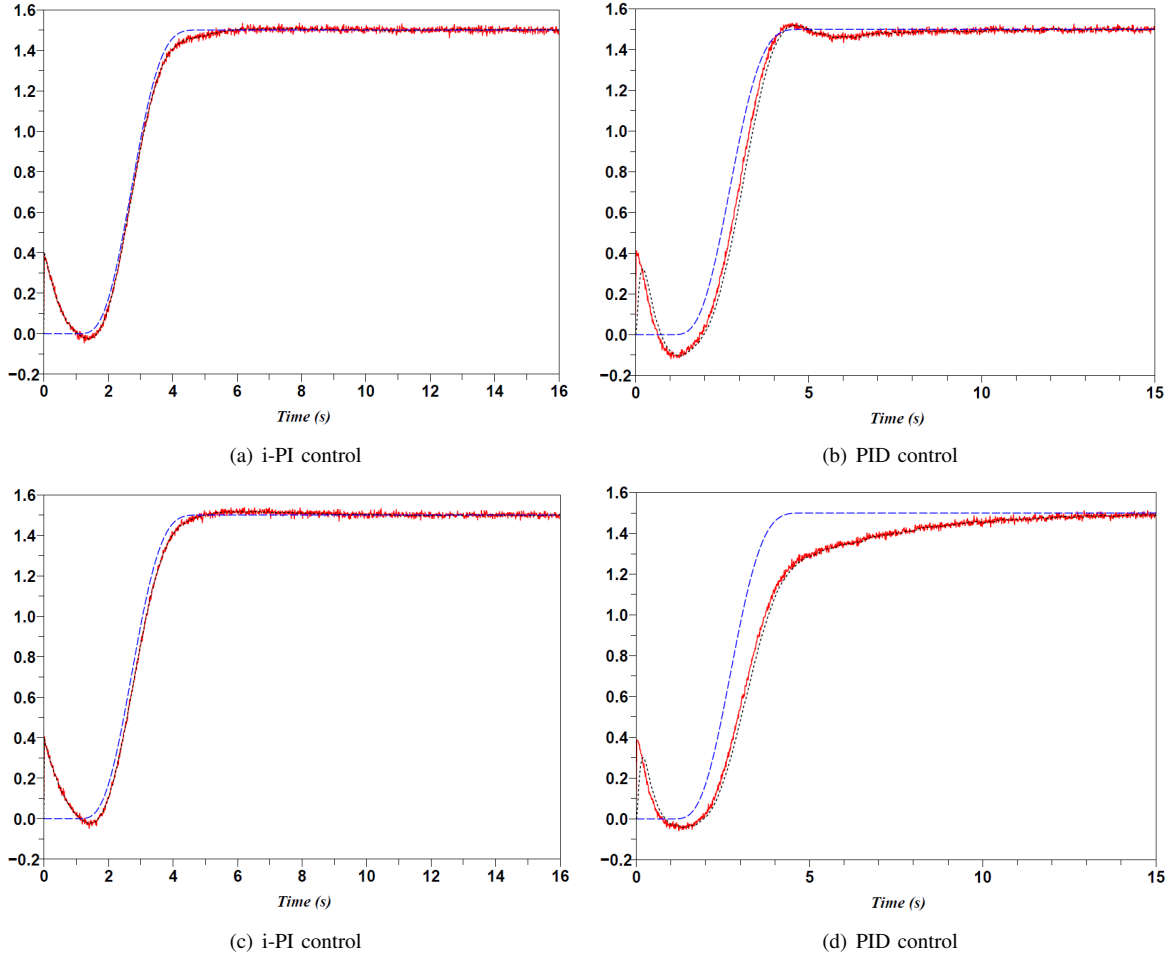

Figure 1. Stable linear monovariate system (Output (-); reference (- -); denoised output (. .)).

III. DIGITAL MODEL-FREE CONTROL OF A DC/DC POWER CONVERTER

A. Local converter model

In the general case, a converter can be described by Equation (1) where u is the converter input and y is the controlled converter output. The proposed control strategy replaces the mathematical model of the converter E , including its load, by a “phenomenological” model, valid only over a short period of time. For the k^{th} iteration, the local model F is defined such that:

$$\left. \frac{dy}{dt} \right|_{k-1} = F_{k-1} + \beta u_{k-1} \quad (5)$$

where β is a non-physical constant design parameter. F is estimated online from the knowledge of u , β and the estimate of \dot{y} . Equation (5) yields an “intelligent” digital PI controller, which is of the form

$$u_k = -\frac{1}{\beta} \left(F_{k-1} - \left. \frac{dy^*}{dt} \right|_k \right) + C(y^* - y)|_k \quad (6)$$

where

- C is a corrector, typically a PI controller,
- y^* is the desired output.

B. Buck converter

1) *Principle:* Consider the dc/dc buck converter (Fig. 2) where u is the duty-cycle and $E = 20V$, $L = 1$ mH, $C = 10$ μF .

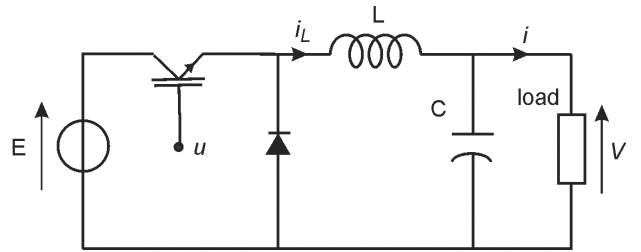

Figure 2. Classical buck converter.

Our intelligent controller reads

$$u_k = u_{k-1} - \frac{1}{\beta} \left(\left. \frac{d\mathcal{X}}{dt} \right|_{k-1} - \left. \frac{d\mathcal{X}^*}{dt} \right|_k \right) + C(\mathcal{X}^* - \mathcal{X})|_k$$

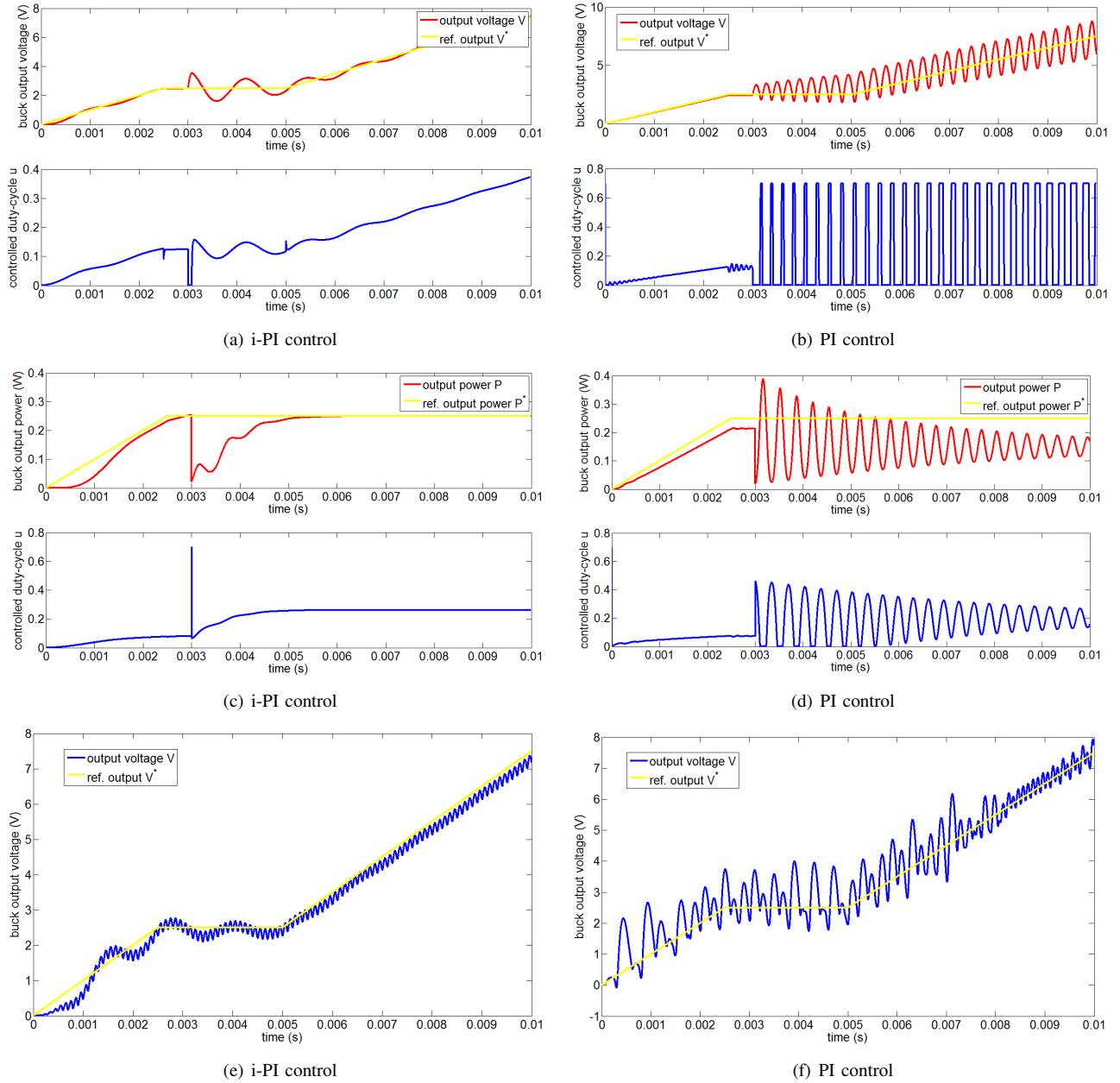

Figure 3. Controlled buck converter.

where C is a constant such that $C(s) = K_p$, $K_p = 2$ and $(\mathcal{X}, \mathcal{X}^*)$ are either (V, V^*) or $(\mathcal{P}, \mathcal{P}^*)$.

2) *Simulation example*: Figure 3 presents the response of the averaged modeled buck when both resistor load and power supply are varying. Consider the resistor load R such that:

$$R = \begin{cases} 10 \Omega & \text{if } 0 \leq t \leq 3 \text{ ms} \\ 10 k\Omega & \text{if } t > 3 \text{ ms} \end{cases}$$

and the varying power supply \tilde{E} such that:

$$\tilde{E} = E + \sin(1000\pi t)$$

Figure 3 presents the response of the buck output using PI and

i-PID control in two cases:

- *voltage control* V : tracking of voltage reference input V^* (Fig 3(a) and Fig. 3(b)).
- *power control* $\mathcal{P} = v \cdot i$: tracking of power reference input \mathcal{P}^* (Fig 3(c) and Fig. 3(d)).

Figures 3(e) and 3(f) present the response of the generalized averaged buck converter [31] [32] in the same conditions as Fig. 3(a) and 3(b). The output voltage ripple is increasing according to the output reference voltage. In each case, the model-free control provides stable and precise tracking of the input reference, even with load and supply variations. Notice that our i-PI controller does not need to be tuned properly in order to ensure output stability and robustness.

IV. EXPERIMENTAL VALIDATION

A. Model-free control of the Ćuk converter

To validate experimentally the proposed approach, a Ćuk converter (Fig. 4) was built. The parameters of the circuit are given in Table I. To control the converter, an FPGA development board has been used.

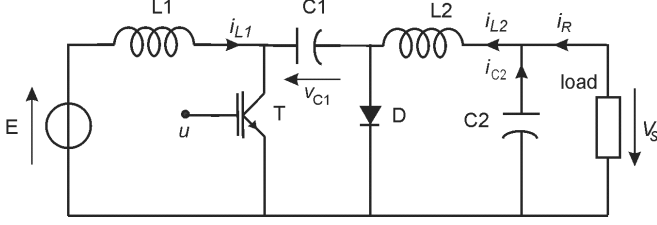

Figure 4. Ćuk converter.

The state-space averaged model of this circuit reads

$$\begin{cases} L_1 \frac{di_1}{dt} = E - (1-u)v_{C1} \\ L_2 \frac{di_2}{dt} = uv_{C1} - v_s \\ C_1 \frac{dv_{C1}}{dt} = (1-u)i_{L1} - u i_{L2} \\ C_2 \frac{dv_{C2}}{dt} = i_{L2} - i_r \end{cases}$$

where u is the PWM duty cycle. This model is nonlinear [33], and in particular, the averaged output voltage $\langle v_s \rangle$ is related to the averaged control variable $\langle u \rangle$ as follows

$$\langle v_s \rangle = \frac{\langle u \rangle}{1 - \langle u \rangle} E \quad (7)$$

Figure 5 illustrates the static response of the Ćuk converter with respect to u .

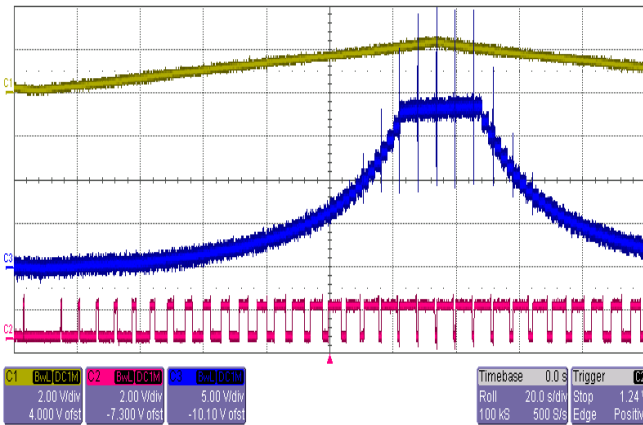

Figure 5. Response of the Ćuk to a ramp.

In this case, the control variable u , represented as the yellow curve, is varying as a ramp with positive and then negative slopes. The blue curve is associated to the measured Ćuk output v_s . The red curve represents the PWM control signal,

Table I
PARAMETER OF THE ĆUK CONVERTER.

Component	Value
L1	5 mH
L2	5 mH
C1	10 μ F
C2	10 μ F
R	0 - 150 Ω

which is associated to u . The control variable u is saturated in order to limit the output voltage of the Ćuk converter to 20 V. Figure 8 presents the simulation of the Ćuk converter, using an averaged model, under variable input voltage reference.

B. Presentation of the set-up

A digital implementation of the control is realized using a FPGA (Xilinx® / Virtex™-II Pro). The FPGA is running at the 100 MHz main clock frequency. Figure 6 describes the synopsis of the power converter control loop and Fig. 7 presents the implementation of the model-free control inside the FPGA.

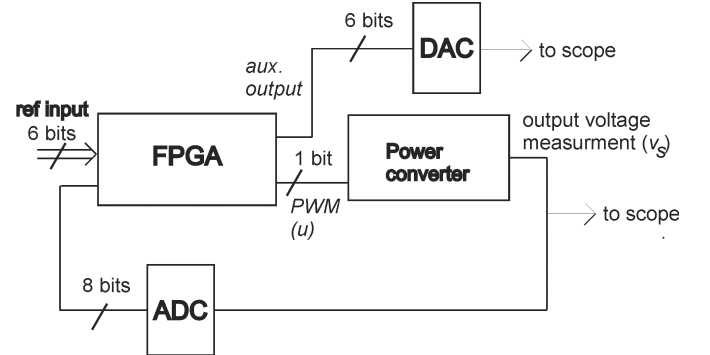

Figure 6. Scheme of the converter control loop.

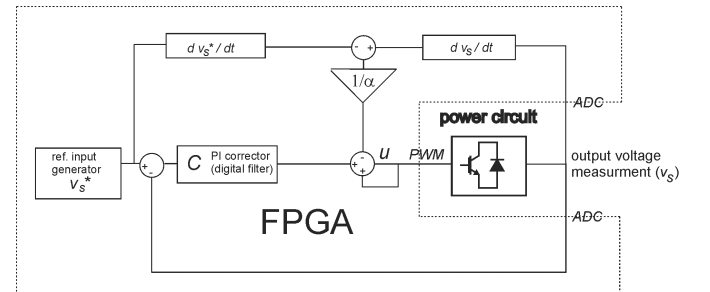

Figure 7. Control structure within the FPGA.

All the digital vectors are 30 bit-unsigned vectors. The reference input v_s^* control is programmed inside the FPGA over 6 bits. A free-running analog-digital converter samples the Ćuk output voltage at 1 MHz into a 8-bit digital signal. A 10kHz saw-tooth carrier function is programmed into the FPGA for

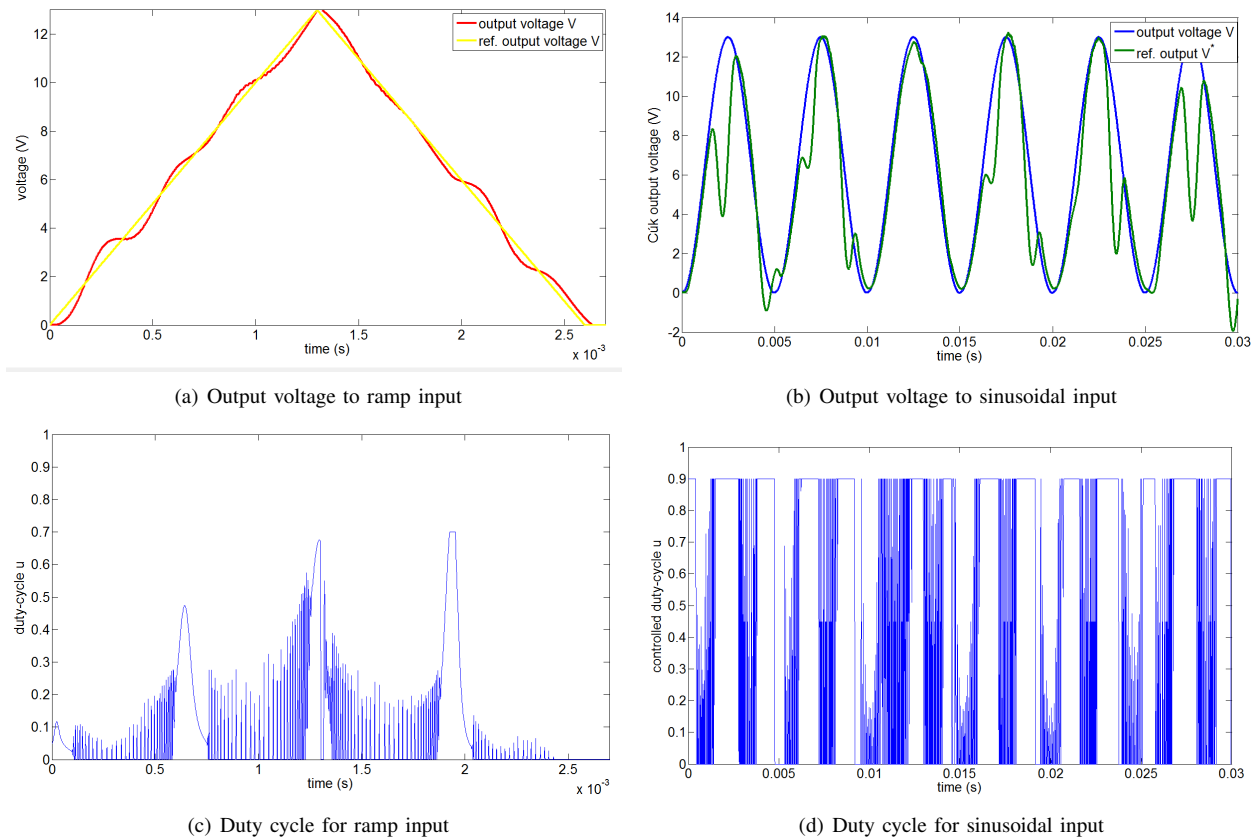

Figure 8. Simulation results for the Ćuk converter with i-P control.

PWM generation, and 1 FPGA output bit is used for the PWM output. An auxiliary 6-bit FPGA output allows to monitor internal FPGA variables using a 6-bit $R - 2R$ digital-analog converter. This auxiliary output allows, for example, to monitor the reference input control. Calculations are performed at the FPGA main clock frequency. This allows to update the PWM output at 10 kHz. Figure 9 presents a picture of the experimental set-up.

C. Experimental results

Measured Ćuk output voltage is presented Fig. 10 in comparison with the output voltage reference v_s . A triangular signal (yellow curve) has been used in order to demonstrate the tracking of the output voltage v_s (blue curve). Figure 10 presents the tracking of the Ćuk output voltage under different working point: Fig. 10(a) presents the response for $R = 45 \Omega$; Fig. 10(b) presents the response for $R = 150 \Omega$ and Fig. 10(c) presents the response for $R = 5 \Omega$. Figure 10(d) presents the tracking of the Ćuk output voltage under power supply disturbances.

V. CONCLUSION AND FUTURE WORK

The simulations on the buck power converters show that the model-free control methodology yields robust performances with respect to disturbance rejection. This methodology moreover does not need any well-defined mathematical model,

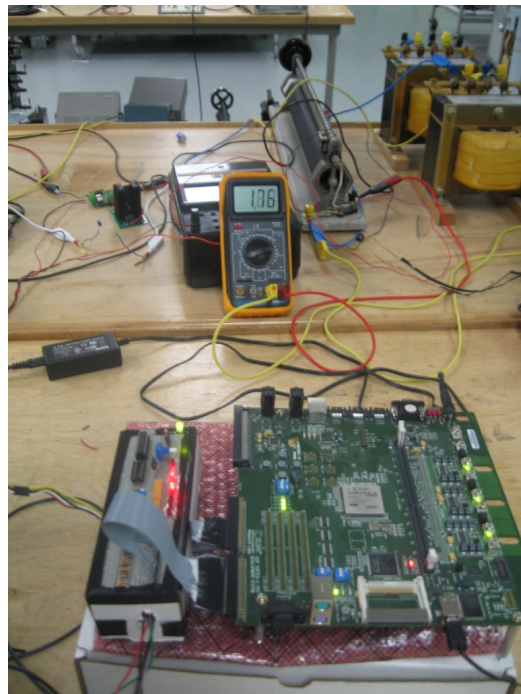
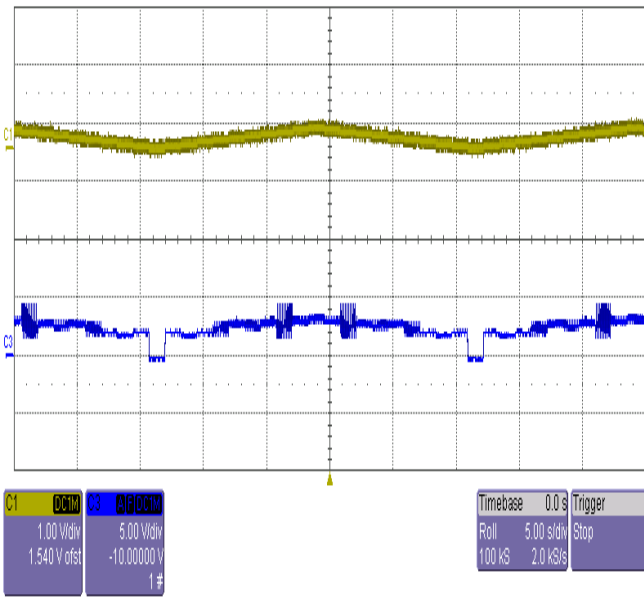
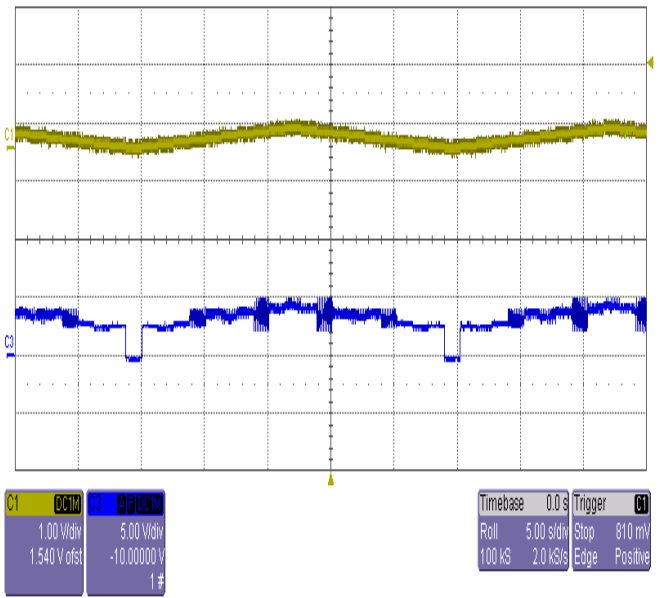

Figure 9. Picture of the set-up including the FPGA device in the foreground and the Ćuk converter in the background.



(a) Output resistive load $R = 45 \Omega$



(b) Output resistive load $R = 150 \Omega$

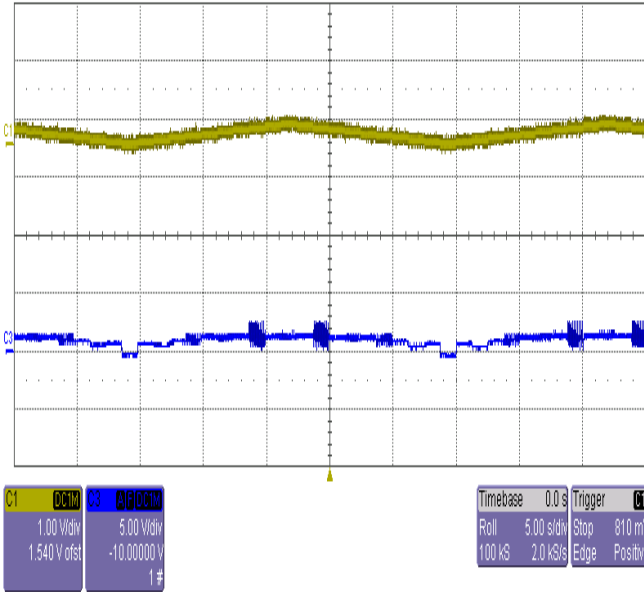

(c) Output resistive load $R = 5 \Omega$

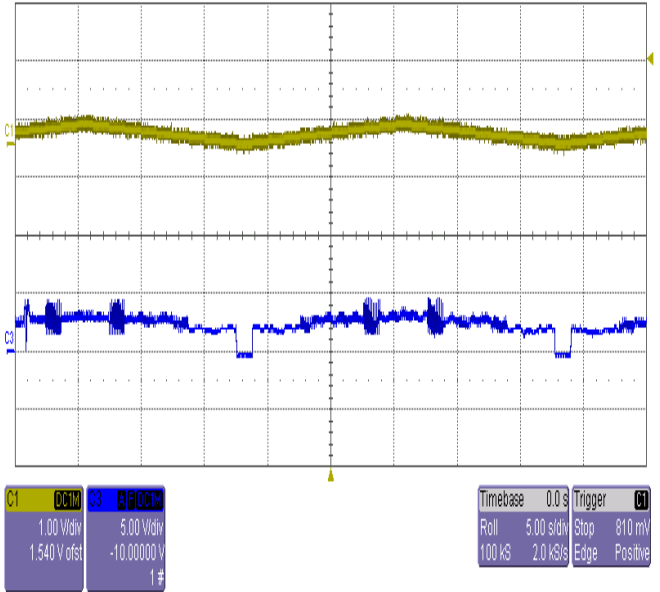

(d) Output resistive load $R = 45 \Omega$ with supply disturbances

Figure 10. Experimental $\hat{C}uk$ output voltage to a triangular input for different resistive loads.

that would require some complex identification procedure. A single parameter only, β , needs to be tuned properly in order to ensure a large variety of working points. The $\hat{C}uk$ converter presents more complex dynamics and positive results were achieved with a rough implementation of the model-free controller. Preliminary experimental results are also very encouraging.

Future works will deal with the application of model-free control to other systems in power electronics, such that multi-level inverters, in order to obtain a “universal” control law, which will be able to control time varying loads (see [25] for hydroelectric power plants), or electrical networks and micro-

grids. The auto-tuning of the β parameter (see Section II-A2) will also be studied in order to extend model-free control to hybrid (see, *e.g.*, [34]) and more complex systems.

ACKNOWLEDGMENT

The first author is grateful to Prof. Sirois and T. Ould Bachir from the École Polytechnique de Montréal (Canada, Québec) for their technical support.

REFERENCES

- [1] A.J. Forsyth and S.V. Mollow, “Modelling and control of DC-DC converters”, IEE Power Engineering J., vol. 12, pp. 229-236, 1998.
- [2] H. Sira-Ramirez and R. Silva-Ortigoza, “Control Design Techniques in Power Electronics Devices”, Springer, 2009.

- [3] Tan Siew-Chong, Y.M. Lai, M.K.H. Cheung and C.K. Tse, "On the practical design of a sliding mode voltage controlled buck converter", *IEEE Trans. Power Electron.*, vol. 20, pp. 425-437, 2005.
- [4] A. Astolfi, D. Karagiannis and R. Ortega, "Towards applied nonlinear adaptive control", *Annual Rev. Control*, vol. 32, pp. 136-148, 2008.
- [5] J. Morroni, R. Zane and D. Maksimovic, "Design and implementation of an adaptive tuning system based on desired phase margin for digitally controlled DC-DC converters", *IEEE Trans. Power Electron.*, vol. 24, pp. 559-564, 2009.
- [6] J. Morroni, L. Corradini, R. Zane and D. Maksimovic, "Adaptive tuning of switched-mode power supplies operating in discontinuous and continuous conduction modes", *IEEE Trans. Power Electron.*, vol. 24, pp.2603-2611, 2009.
- [7] A.J. Calderón, B.M. Vinagre and V. Feliu, "Fractional order control strategies for power electronic buck converters", *Signal Processing*, vol. 86, pp. 2803-2819, 2006.
- [8] P. Mattavelli, L. Rossetto, G. Spiazzi and P. Tenti, "General-purpose fuzzy controller for DC-DC converters", *IEEE Trans. Power Electron.*, vol. 12, pp. 79-86, 1997.
- [9] C. Elmas, O. Deperlioglu and H.H. Sayan, "Adaptive fuzzy logic controller for DCDC converters", *Expert Systems Appl.*, vol. 36, pp. 1540-1548, 2009.
- [10] C.-H. Cheng, P.-J. Cheng and M.-J. Xie, "Current sharing of paralleled DC-DC converters using GA-based PID controllers", *Expert Systems Appl.*, vol. 37, pp. 733-740, 2010
- [11] M. Rafiei, R. Ghazi, R. Asgharian, H. A. Toliyat and M. Barakati, "Robust control methodologies for dc/dc PWM converters under wide changes in operating conditions", *Proc. 6th WSEAS Internat. Conf. Syst. Theory Scientif. Comput.*, Elounda, pp. 200-210, 2006.
- [12] H. Fujioka, C.-Y. Kao, S. Almér and U. Jönsson, "Robust tracking with H_∞ performance for PWM systems", *Automatica*, vol. 45, pp. 1808-1818, 2009.
- [13] H. El Fadil and F. Giri, "Robust nonlinear adaptive control of multiphase synchronous buck power converters", *Control Engin. Practice*, vol. 17, pp. 1245-1254, 2009.
- [14] M. J. Grimble, "Robust Industrial Control Systems Optimal Design Approach for Polynomial Systems", Wiley, 2006.
- [15] M. Fliess and C. Join, "Commande sans modèle et commande à modèle restreint", *e-STA*, vol. 5 (n° 4), pp. 1-23, 2008 (available at <http://hal.inria.fr/inria-00288107/en/>).
- [16] M. Fliess and C. Join, "Model-free control and intelligent PID controllers: Towards a possible trivialization of nonlinear control", *15th IFAC Symp. System Identif.*, Saint-Malo, 2009 (available at <http://hal.inria.fr/inria-00372325/en/>).
- [17] M. Fliess, J. Lévine, P. Martin and P. Rouchon, "Flatness and defect of non-linear systems: introductory theory and examples", *Int. J. Control*, vol. 61, pp. 1327-1361, 1995.
- [18] H. Sira-Ramírez and S. Agrawal, "Differentially Flat Systems", Marcel Dekker, 2004.
- [19] B. d'Andréa-Novél, M. Fliess, C. Join, H. Mounier and B. Steux, "A mathematical explanation via "intelligent" PID controllers of the strange ubiquity of PIDs", *18th Medit. Conf. Control Automation*, Marrakech, 2010 (available at <http://hal.inria.fr/inria-00480293/en/>).
- [20] B. d'Andréa-Novél, C. Boussard, M. Fliess, O. El Hamzaoui, H. Mounier and B. Steux, "Commande sans modèle de vitesse longitudinale d'un véhicule électrique", *6^e Conf. Internat. Francoph. Automatique*, Nancy, 2010 (available at <http://hal.inria.fr/inria-00463865/en/>).
- [21] S. Choi, B. d'Andréa-Novél, M. Fliess and H. Mounier, "Model-free control of automotive engine and brake for stop-and-go scenario", *10th IEEE Conf. Europ. Control Conf.*, Budapest, 2009 (available at <http://hal.inria.fr/inria-00419445/en/>).
- [22] P.-A. Gédouin, C. Join, E. Delaleau, J.-M. Bourgeot, S. Arbab-Chirani and S. Calloch, "Model-free control strategy for shape memory alloys antagonistic actuators", *17th IFAC World Congress*, Seoul, 2008 (available at <http://hal.inria.fr/inria-00261891/en/>).
- [23] P.-A. Gédouin, C. Join, E. Delaleau, J.-M. Bourgeot, S. Arbab-Chirani and S. Calloch, "A new control strategy for shape memory alloys actuators", *8th Europ. Symp. Martensitic Transformations*, Prague, 2009 (available at <http://hal.inria.fr/inria-00424933/en/>).
- [24] C. Join, J. Masse and M. Fliess, "Étude préliminaire d'une commande sans modèle pour papillon de moteur", *J. europ. syst. automat.*, vol. 42, pp. 337-354, 2008 (available at <http://hal.inria.fr/inria-00187327/en/>).
- [25] C. Join, G. Robert and M. Fliess, "Vers une commande sans modèle pour aménagements hydroélectriques en cascade", *6^e Conf. Internat. Francoph. Automat.*, Nancy, 2010 (available at <http://hal.inria.fr/inria-00460912/en/>).
- [26] J. Villagra and C. Balaguer, "Robust motion control for humanoid robot flexible joints", *18th Medit. Conf. Control Automation*, Marrakech, 2010.
- [27] M. Fliess, C. Join and H. Sira-Ramírez, "Non-linear estimation is easy", *Int. J. Model. Identif. Control*, vol. 4, pp. 12-27, 2008 (available at <http://hal.inria.fr/inria-00158855/en/>).
- [28] F.A. García Collado, B. d'Andréa-Novél, M. Fliess and H. Mounier, "Analyse fréquentielle des dérivateurs algébriques", *XXII^e Coll. GRETSI*, Dijon, 2009 (available at <http://hal.inria.fr/inria-00394972/en/>).
- [29] M. Mboup, C. Join and M. Fliess, "Numerical differentiation with annihilators in noisy environment", *Numer. Algor.*, vol. 50, pp. 439-467, 2009.
- [30] D. Dindeleux, "Technique de la régulation industrielle", Eyrolles, 1981.
- [31] S.R. Sanders, J.M. Noworolski, X.Z. Liu and G.C. Verghese, "Generalized averaging method for power conversion circuits", *IEEE Trans. Power Electron.*, vol.6, pp.251-259, 1991.
- [32] J.Mahdavi, A. Emaadi, M.D. Bellar and M. Ehsani, "Analysis of power electronic converters using the generalized state-space averaging approach", *IEEE Transactions on Circuits and Systems I: Fundamental Theory and Applications*, vol.44, no.8, pp.767-770, Aug 1997.
- [33] K.M. Smedley and S. Cuk, "Dynamics of one-cycle controlled Cuk converters", *IEEE Trans. Power Electron.*, vol.10, pp. 634-639, 1995.
- [34] R. Bourdais, M. Fliess, C. Join and W. Perruquetti, "Towards a model-free output tracking of switched nonlinear systems", *7th IFAC Symp. Nonlinear Control Systems*, Pretoria, 2007 (available at <http://hal.inria.fr/inria-00147702/en/>).