



HAL
open science

Omnidirectional Vision Attachment for Medical Endoscopes

Ryusuke Sagawa, Takurou Sakai, Tomio Echigo, Keiko Yagi, Masatsugu Shiba, Kazuhide Higuchi, Tetsuo Arakawa, Yasushi Yagi

► **To cite this version:**

Ryusuke Sagawa, Takurou Sakai, Tomio Echigo, Keiko Yagi, Masatsugu Shiba, et al.. Omnidirectional Vision Attachment for Medical Endoscopes. The 8th Workshop on Omnidirectional Vision, Camera Networks and Non-classical Cameras - OMNIVIS, Rahul Swaminathan and Vincenzo Caglioti and Antonis Argyros, Oct 2008, Marseille, France. inria-00325318

HAL Id: inria-00325318

<https://inria.hal.science/inria-00325318>

Submitted on 28 Sep 2008

HAL is a multi-disciplinary open access archive for the deposit and dissemination of scientific research documents, whether they are published or not. The documents may come from teaching and research institutions in France or abroad, or from public or private research centers.

L'archive ouverte pluridisciplinaire **HAL**, est destinée au dépôt et à la diffusion de documents scientifiques de niveau recherche, publiés ou non, émanant des établissements d'enseignement et de recherche français ou étrangers, des laboratoires publics ou privés.

Omnidirectional Vision Attachment for Medical Endoscopes

Ryusuke Sagawa¹, Takuro Sakai¹, Tomio Echigo², Keiko Yagi³, Masatsugu Shiba⁴, Kazuhide Higuchi⁵, Tetsuo Arakawa⁴, and Yasushi Yagi¹

¹ The Institute of Scientific and Industrial Research, Osaka University, Japan,
{sagawa,t-sakai,yagi}@am.sanken.osaka-u.ac.jp,

² Dept. of Engineering Informatics, Faculty of Information and Communication Engineering, Osaka Electro-Communication University, echigo@isc.osakac.ac.jp,

³ Kobe Pharmaceutical University,

⁴ Osaka City University Graduate Medical School,

⁵ 2nd Department of Internal Medicine Osaka Medical College,
{shiba,arakawat}@med.osaka-cu.ac.jp,

Abstract. Medical endoscopes are equipped with wide-angle lenses to provide a wide field of view operating doctors. However, it has been pointed out that there is a backward looking blind area for endoscopes such that an affected area could be overlooked since the gastrointestinal system is intricate and the inside shaped by plicae. In this paper, we propose an omnidirectional vision attachment that has a convex mirror fitted at the tip of an endoscope. The attachment enables backward observations with the endoscope by providing a 360 degrees view. The issue related to developing this attachment is illumination of the field of view. Because the light source is usually only the light at the tip of the endoscope when it is inside the organ, we designed an attachment to illuminate the back-looking viewing field by reflecting light in a mirror. In the experiment, we measured the field of view and the illuminated field, and confirmed that the field behind an endoscope tip can be observed using the attachment.

1 Introduction

Examining digestive organs, such as the esophagus, stomach, duodenum, and large intestine using a medical endoscope is one of the most common methods for digestive disease investigations. The numbers of examinations are about 5, 6.2 and 3.2 million a year in Japan, US, and UK/Germany/France, respectively. In an examination, a doctor operates an endoscope by watching the video captured by a camera positioned at the tip of the probe. Especially, for examinations of the large intestine, it is necessary to sophisticatedly manipulate an endoscope according to the intestinal shape. Since the camera has only a forward looking view, much manipulation is required to view the complete intestine. Therefore, it is difficult to examine without missing something. For example, at the bending section between transverse and descending colon, the inner side of the place of flexion is usually blind and so could be overlooked. Furthermore, there are many

plicae in an intestine; the reverse side of a plica is occluded from the forward view and so the probe needs to be bent backward to observe the reverse side. This increased operational requirement is a burden for both doctors and patients. Although the frontal view of the camera is suitable for inserting the probe and operating forceps, it is not always optimal for finding affected areas. Instead, a 360-degree panoramic view of lateral and backward directions is more suitable since it can simultaneously observe all the intestinal wall.

To obtain a lateral or backward field of view, various endoscopes have been proposed. For an endoscope with a lateral field of view, lateral- or oblique-viewing endoscopes have been used [1, 2]. However, the field of view of these endoscopes is rather narrow to obtain the 360-degree panoramic view. For endoscopes with lateral and backward views, systems that use a secondary backward looking camera [3] and an endoscope with a conic mirror at the tip [4] have been proposed. However, these approaches have practical problems for examinations. Since [3] uses the forceps channel for the secondary camera, forceps cannot be used with this system. In [4], the tip of the endoscope is covered by a capsule and the conic mirror has a small hole for a 20-degree forward view. Thus, forceps cannot be used with the endoscope and the forward field of view is rather narrow for manipulation. Moreover, since it is not an attachment to an existing endoscope, a special endoscope is required.

In this paper, we propose an omnidirectional vision attachment for an endoscope to resolve the issue described above. This attachment has an annular convex mirror and is positioned at the tip of an endoscope. It enables a lateral and backward view in addition to the frontal one, thus providing a 360-degree view. Therefore, it is useful for examine bending sections and the reverse sides of plicae. Hence, a doctor can examine an intestine more efficiently with less manipulation. Since the oversight in an examination is expected to be reduce, the burden on a patient will also be reduced. Additionally, since the proposed attachment uses an annular mirror, a forceps can be used as with existing endoscopes.

In the following sections, we explain our omnidirectional vision attachment and detail its optical characteristics. We also give an experimental evaluation of the effectiveness and safety by using a model of the intestine and an animal experiment.

2 Omnidirectional Vision Attachment

The goal of the omnidirectional attachment proposed in this paper is to observe the lateral and backward directions of an endoscope. To achieve this, the attachment should enable not only a backward field of view but should also illuminate the field of view. In this section, we explain the requirements of the attachment based on a preliminary experiment described in Section 3.1. Finally, the prototype of the attachment is presented.

2.1 Practical Requirements for Designing an Attachment

For designing an attachment, the requirements from the point of operability and safety must be estimated, as well as the fields of view in lateral and backward directions. We describe the requirements for designing an attachment based on

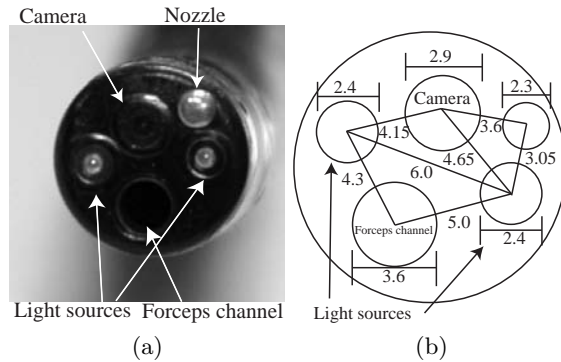

Fig. 1. The tip of an endoscope has a camera, two light sources, a forceps channel, and air/water nozzle.

the results obtained from a preliminary experiment. First, the requirements from practical viewpoints are as follows.

1. Inserting a probe

When an endoscope is inserted into the large intestine, the end of the probe needs to bend flexibly according to the shape of the intestine. Several centimeters from the tip are usually inflexible because the camera and lens are housed there. The length of the inflexible part strongly affects the operability of inserting a probe. Therefore, doctors request that any proposed attachment is not larger than the existing endoscopic attachments. Additionally, since a doctor pushes the intestine with the tip of the probe while inserting it, the attachment needs to be robust to carry out the operation.

2. Operating a forceps

One of the advantages of digestive endoscopy is that a doctor can treat an affected area using a forceps as well as observing it. Thus, it is important that the proposed attachment can be simultaneously used with a forceps.

3. Washing optical components

Because the optical components become blurred by residue and mucus in the intestine, they are constantly washed by water injected from a water nozzle. It is desirable that the attachment can also be washed if it becomes similarly blurred.

2.2 Design of Proposed Attachment

The proposed approach provides lateral and backward fields of view utilizing a catadioptric imaging system in which a convex mirror is positioned at the tip of the endoscope. We designed an experimental attachment for an Olympus CF-240AI. The tip of the probe is shown in Fig. 1. It has a camera, two light sources, a forceps channel and air/water nozzle. The position of the camera is not the center of the probe. The positions of the light sources are different from the camera and not symmetrical with respect to the camera.

In an omnidirectional catadioptric imaging system, a convex mirror is usually placed on the axis of the camera lens. Similarly, it is desirable to place a convex

mirror on the axis of a lens to omnidirectionally illuminate a scene. Therefore, two approaches were considered. The first approach was that three mirrors be used for the camera and the two light sources, separately. The second was that a single mirror be used for both observation and illumination.

An endoscopic camera usually has a wide field of view; for example, the CF-240AI has 140 degrees. Thus, the mirrors for the first approach must be small and be placed very close to the camera and light sources. Contrarily, the backward direction is occluded by the probe itself if the mirrors are close. Moreover, it is undesirable to place a mirror close to the lens from the point of focal depth. We created mirror samples of 5mm in diameter. After testing, doctors suggested that small mirrors may injure the intestine if a small prominence was to exist at the tip. Although one can use a hemispherical cover for a mirror, it is not practical from the point of washing. Therefore, we determined our first approach was not practical.

In this paper, we adopt the second approach. This uses a convex mirror for both observation and illumination. This approach can use a mirror with a diameter as large as that of the probe. It makes it easy to realize both lateral and backward fields of view. It is also desirable from the point of focal depth. An issue related to this approach is the illumination of the scene because the positions of the camera and light sources are different. The luminance may not be uniform because of the displacement of the field of view and illumination. However, by placing a mirror distant from the lens, we can reduce the effect of displacement. As well, the inter-reflection of the intestinal wall is expected to work for ambient illumination. Since it is impossible to place a single mirror on the axis of both camera and light sources, we decided to place the axis of the proposed mirror on the center of the probe because the gravity of the illuminating and imaging system is near the center of the probe.

Based on the requirements described in Section 2.1, we designed an attachment that consisted of a single convex mirror and a body to support the mirror. The external and cross-section view are shown in Fig. 2 and Fig. 3, respectively.

The shape of the experimental mirror is a body of revolution around z -axis given by

$$z = \frac{cr^2}{1 + \sqrt{1 - (1+k)c^2r^2}}, \quad (1)$$

where r is the radial coordinate, c is the curvature (the reciprocal of the radius), and k is the conic constant. If $k < -1$, (1) represents a hyperboloid. By considering the size of mirror and the field of view of the endoscopic camera, we determined the distance between the mirror and the front of the probe is 5.62mm. To achieve the lateral and backward field of view, the parameters are determined as $c = -0.219$ and $k = -1.19$. The hole of the mirror is 8mm in diameter to enable operating a forceps.

The annular hyperboloidal mirror has three supports making it easy to wash while keeping it stable. The width of the supports is 1.23mm, decided by considering the stress during an operation. One of the supports is placed at the near side of camera and others at the far side to minimize any occlusion.

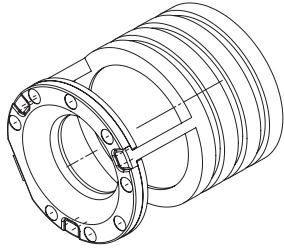

Fig. 2. External view of the experimental attachment.

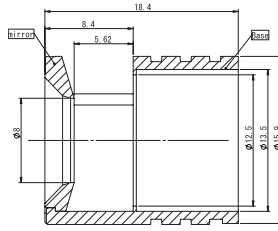

Fig. 3. Cross-sectional view of the experimental attachment.



Fig. 4. Omnidirectional vision attachment positioned at the tip of an endoscope.

The attachment with the cylindrical body is positioned at the tip of an endoscope and fixed with tape. The difference in the diameters of the attachment and the endoscope is 2.5mm. The front field of view is about 70 degrees, as shown in the cross sectional figure. The attachment body and mirror are made from polycarbonate, a material that is often used for medical equipment, and formed by a molding process. Therefore, it is disposable and sanitary. Fig. 4 shows the omnidirectional vision attachment positioned on an endoscope. The size of the attachment is 16mm in width and 18mm in height. The length of the part that sticks out from the probe is 9mm, which is less than the existing attachment.

3 Evaluation of the Experimental Attachment

In this section, we first estimate the characteristics of the endoscopic camera and light sources in a preliminary experiment. Second, we measure the field of view by computing the viewing ray of the camera with the omnidirectional vision attachment. Third, we measure the field of illumination by examining the light reflected by the mirror. Fourth, we estimate the luminance of a scene illuminated by reflected light using the endoscopic camera. Finally, we explain the results of evaluations by doctors.

3.1 Preliminary Experiment

As shown in Fig. 1(a), the tip of the endoscope has a camera, two light sources, a forceps channel, and an air/water nozzle. Their configuration is shown in Fig. 1(b). The distance between the camera and light sources is 4.1-4.6mm. Therefore, the line of sight is different from the rays of the illumination. This is an issue to address in designing the attachment.

We investigated the field of view of the camera and the distribution of the illumination. First, the viewing angle of the endoscopic camera is 140 degrees diagonally. Since the diameter of the lens is 2.9mm, we assumed that the focal point of the camera was 0.53mm inside the lens front, as shown in Fig. 5. Next, we measured the distribution of the light power of the light sources. We placed a white diffusing plate in front of the endoscope and captured the image of the diffuser using another camera. The light power in each direction was measured by the brightness of the diffuser. Fig. 6 shows the results. The vertical axis indicates the relative power with respect to direction. In the figure, the front direction is 90 degrees. From this result, the power at an angle 30 degrees from the front direction was reduced by half.

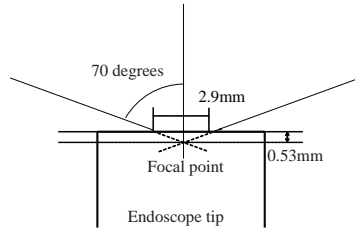

Fig. 5. The viewing angle of the endoscopic camera is 140 degrees diagonally. Since the diameter of the lens is 2.9mm, we assumed that the focal point of the camera was 0.53mm inside the lens front.

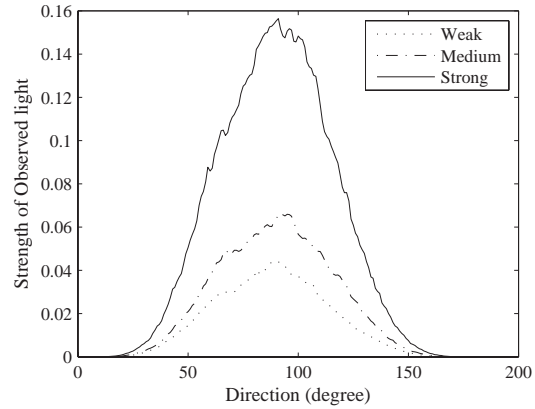

Fig. 6. The distribution of light power is measured. The vertical axis indicates the relative power with respect to direction. The front direction is 90 degrees.

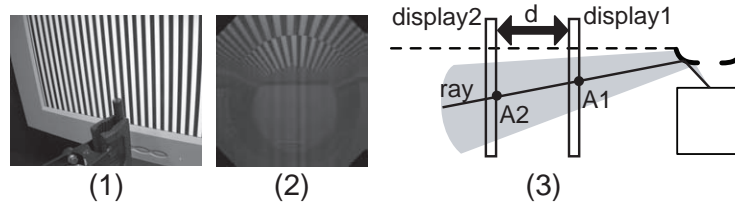

Fig. 7. (1) The field of view is measured by using structured light on a flat display. (2) An example of the camera image of the structured light. (3) the direction of a viewing ray is computed by projective structured light patterns from the display at two positions, for which the relative distance d was known.

3.2 Measuring the Field of View

Method We measured the field of view of the camera with the proposed omnidirectional attachment using structured light patterns. We placed a flat display by the side of the attachment, as shown in Fig. 7(1). The structured light patterns on the display were captured by the camera. The coordinate of the display was associated with that of the camera using the structured light patterns [5]. If the structured light patterns were projected from the display at two positions, for which the relative distance d was known, as shown in Fig. 7(3), the direction of a viewing ray could be computed. If a pixel of the camera image corresponds to points A_1 and A_2 in the display, the direction of the ray is computed from A_1 , A_2 and d [6]. We measured the field of view by computing the viewing rays for all pixels.

Result Fig. 8 shows the field of view of the endoscopic camera with the attachment. We measured the field of view in three directions, as shown in the top-left figure. The viewing rays are indicated by white lines in the cross-sectional views. The regions between the dashed lines are the backward fields of view obtained by mirror reflection. The forward and backward fields of view intersect each other.

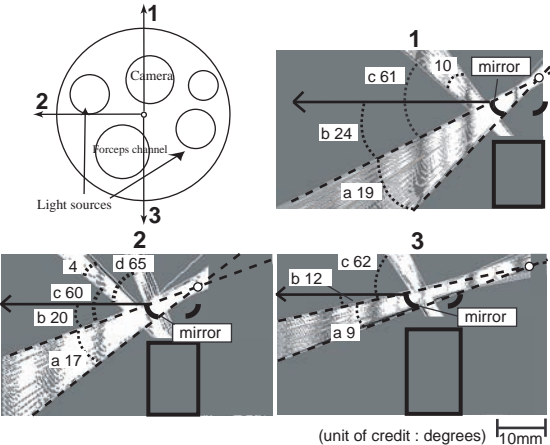

Fig. 8. Top-left: the field of view is measured in three directions. Top-right, Bottom-left, and Bottom-right: the viewing rays are indicated by white lines in the cross-sectional views for Direction 1, 2, and 3, respectively. The backward viewing angle is a , the angle between the horizontal plane and the backward field of view is b , and the angle between the forward and backward fields of view is c . For Direction 2, the angle between the horizontal plane and the inner forward field of view is d .

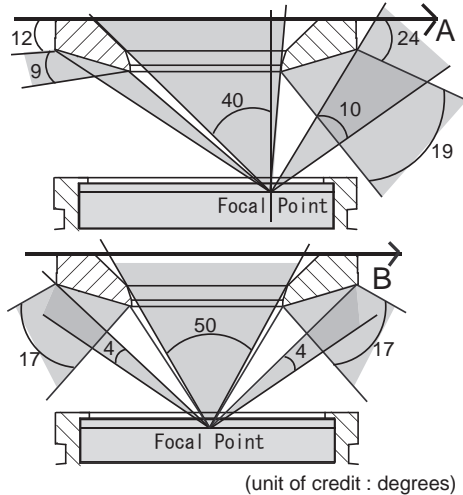

Fig. 9. Summary of the results for the viewing angles: cross-sections A and B are parallel to Directions 1 and 2 in Fig. 8, respectively. The minimum backward viewing angle is between 12 and 24 degrees and the maximum backward viewing angle between 24 and 43, as shown in A. The forward field of view has 50 degrees in B and more than 40 degrees in A.

Because the camera is not at the center of the probe, the observed forward field of views are different: outside the mirror for Direction 1, inside for Direction 3, and both sides for Direction 2. The curved line indicates the position of the mirror. The backward viewing angle is a , the angle between the horizontal plane

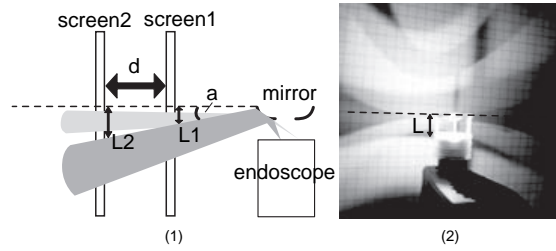

Fig. 10. The field of illumination was measured by projecting the light of the endoscope onto screens. We projected the light onto two screens for which the relative distance d was known, as shown in (1). The distance between the horizontal line and the illuminated area was measured. The angle a was computed from L_1 , L_2 and d . The distances L_1 and L_2 are given by measuring the distance L between the horizontal line, which is indicated by the dashed line, and the edge of the illuminated area as shown in (2).

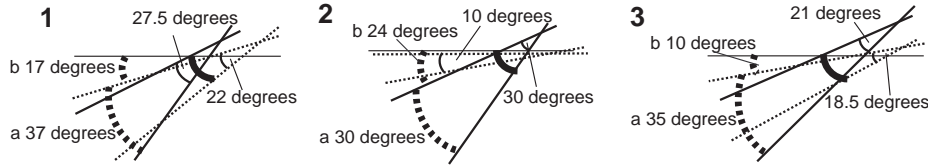

Fig. 11. The measured results of the backward field of illumination in three directions in Fig. 8: the solid lines indicate the light by the near one and the dashed lines indicate the other of two light sources. The thick curved lines indicate the position of the mirror. The angle a of the illuminated area and the angle b between the horizontal line and the illuminated area were measured.

and the backward field of view is b , and the angle between the forward and backward fields of view is c . For Direction 2, the angle between the horizontal plane and the inner forward field of view is d .

The results for the viewing angles are summarized in Fig. 9. Cross-sections A and B are parallel to Directions 1 and 2 in Fig. 8, respectively. The backward field of view is maximized in Direction 1 and minimized in Direction 3 because of the relative positions of the camera and the mirror. The maximum and minimum backward viewing angles can be computed from the angles a and b in each direction. The minimum angle is between 12 and 24 degrees and the maximum angle between 24 and 43, as shown in Fig. 9A. The forward field of view has 50 degrees in Fig. 9B and more than 40 degrees in Fig. 9A. This difference is caused by the shift of the centers between the camera and the mirror.

3.3 Measuring the Field of Illumination

Method The field of illumination was measured by projecting the light of the endoscope onto screens. We projected the light onto two screens for which the relative distance d was known, as shown in Fig. 10(1). The distance between the horizontal line and the illuminated area was measured. The angle a was computed from L_1 , L_2 and d . The illuminated screen is shown in Fig. 10(2). The distances L_1 and L_2 are given by measuring the distance L between the horizon-

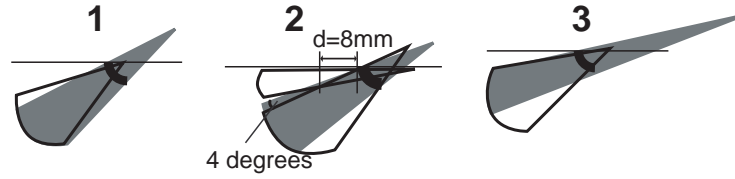

Fig. 12. The gray areas indicate the fields of view and the areas closed with solid lines indicate the fields of illumination. For Directions 1 and 3, the field of view indicated by the gray area is covered by the field of illumination indicated by the solid lines. For Direction 2, the area illuminated insufficiently is about 4 degrees. However, if an observed object is close to the endoscope, it can be illuminated.

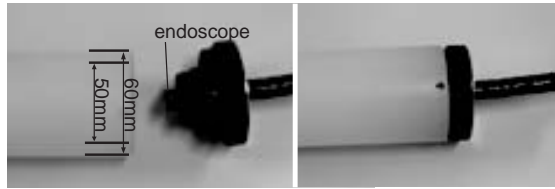

Fig. 13. The distribution of illumination is measured by capturing an image in an acrylic pipe.

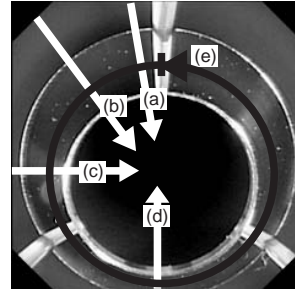

Fig. 14. The distribution of illumination is measured in the five directions, four radial directions (a), (b), (c) and (d) and a circumferential direction (e).

tal line, which is indicated by the dashed line, and the edge of the illuminated area.

Result Fig. 11 shows the measured results of the field of illumination in three directions in Fig. 8. Since the endoscope has two light sources, the solid lines indicate the light by the near one and the dashed lines indicate the other. The thick curved lines indicate the position of the mirror. The field of illumination is regarded as the area illuminated by one of two light sources for Directions 1 and 3, and the area illuminated by the near one for Direction 2. We measured the angle a of the illuminated area and the angle b between the horizontal line and the illuminated area.

Next, we compared the field of view and the illumination. Fig. 12 shows the field of view overlapped with the field of illumination. For Directions 1 and 3, the field of view indicated by the gray area is covered by the field of illumination indicated by the solid lines. Thus, the field of view is successfully illuminated. For Direction 2, the area illuminated insufficiently is about 4 degrees. However, if an observed object is close to the endoscope, it can be illuminated.

3.4 Measuring the Distribution of Illumination

Method Next, we evaluated the distribution of illumination with the attachment. To simulate the situation that the endoscope is in an intestine, we fixed the

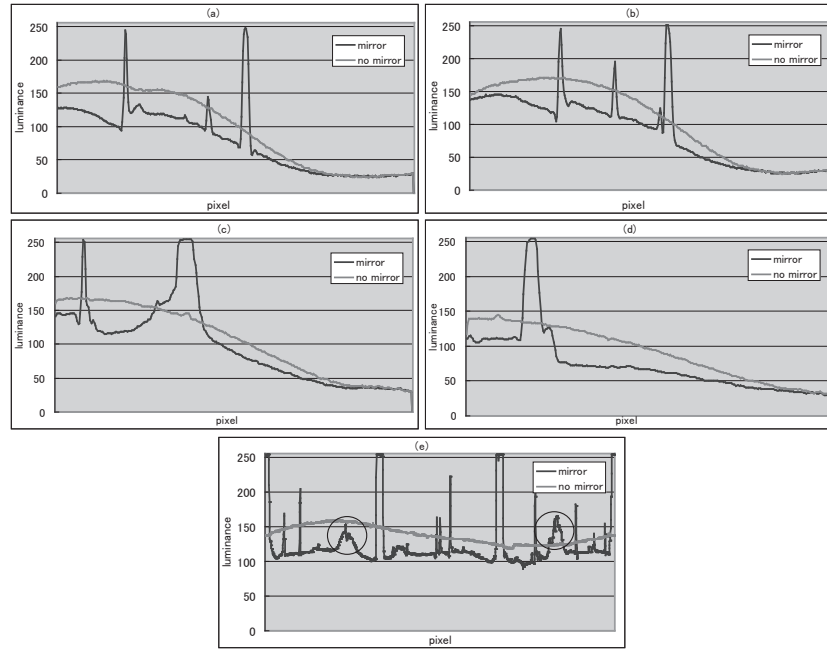

Fig. 15. The distributions of illumination in the radial and circumferential directions: the intensity observed with the attachment is 70-80% of the result without the attachment. For the direction (c) that correspond to Direction 2, the scene was illuminated uniformly. Thus, a field of view within 25mm from the camera can be sufficiently illuminated. The large peaks indicate the mirror supports and the small peaks indicate dust and small blemishes in the mirror. The circles in (e) are caused by the irregular reflection at the edge of the mirror.

endoscope in a 50mm diameter acrylic pipe, a white diffusing object, as shown in Fig. 13. The distribution of illumination was measured by capturing an image with the endoscopic camera. If the intensity of the image is similar to the case without the attachment, the field of view had been sufficiently illuminated. We evaluated four radial directions (a), (b), (c) and (d) and a circumferential direction (e) shown in Fig. 14. Directions (a), (c) and (d) correspond to Directions 1, 2 and 3 in Fig. 8.

Result The distributions of illumination in the radial and circumferential directions are shown in Fig. 15. For radial directions, the intensities of the area observed by mirror reflection and the outside area directly observed are nearly similar. The intensity observed with the attachment is 70-80% of the result without the attachment. The peak parts in the graphs indicate the edge of the mirror. For the circumferential direction, the large peaks indicate the mirror supports and the small peaks indicate dust and small blemishes in the mirror.

Since the image observed with the attachment was captured without saturation or black-out, it was shown to be successfully illuminated. For the direction (c) that correspond to Direction 2, the scene was illuminated uniformly. Thus,

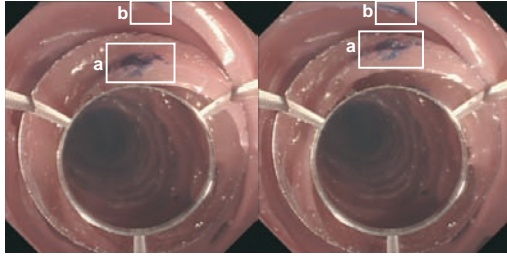

Fig. 16. Marks on both sides of a plica in an intestine model: a. reverse side b. front side. The attachment enables to observe both marks.

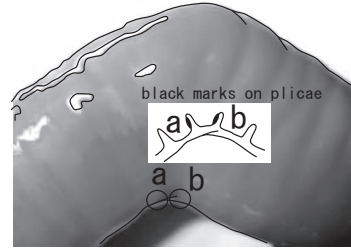

Fig. 17. Marks on a bending section: a. front side b. back side.

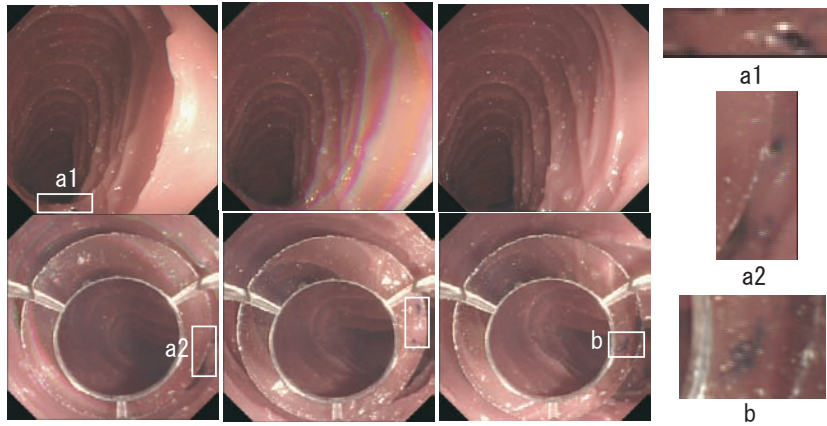

Fig. 18. Without the attachment, while the mark a can be observed as a_1 , the mark b cannot be observed. With the attachment, the both marks can be observed as a_2 and b in the image sequence of the bending section.

a field of view within 25mm from the camera can be sufficiently illuminated. The circles in Fig. 15(e) are caused by the irregular reflection at the edge of the mirror. Since the intensities are not saturated, it does not degrade the image.

From these experiments, we showed that the proposed attachment simultaneously provided forward and backward fields of view. Therefore, it satisfied the requirements set for its design.

3.5 Evaluating the Field of View by using an Intestine Model

Method To evaluate the field of view with the attachment, we next tested the attachment by capturing images in an intestine model. We painted small black marks inside the model as reference points. If the attachment provided a desirable field of view, the marks would be observable even on the reverse side of a plica or the inner side in a bending section. Fig. 16 shows the marks on the reverse side of a plica. We painted some marks on the front and back side of a bending section as shown in Fig. 17. We captured an image sequence as shown in Fig. 18.

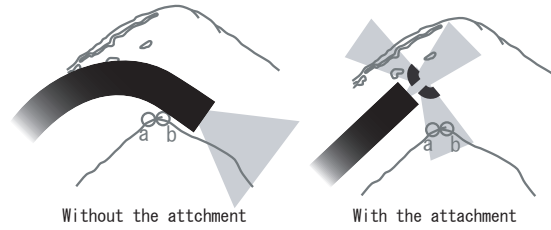

Fig. 19. The attachment enables the observation of the inner side of a bending section without complicated manipulations of the endoscope.

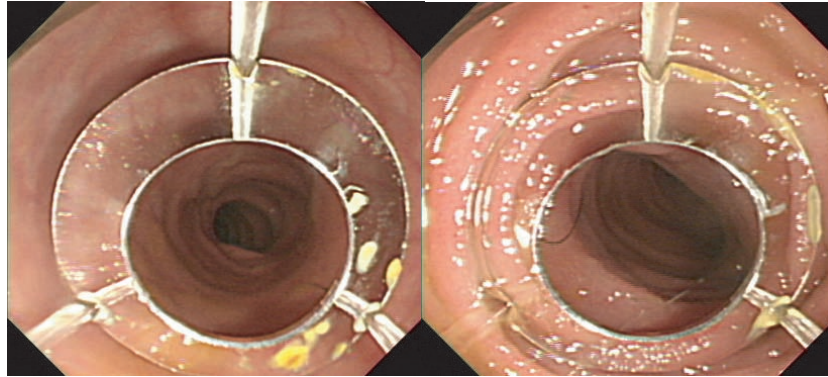

Fig. 20. Example of images of an intestine with the omnidirectional vision attachment: the lateral and backward directions can be observed in the mirror part.

Result In Fig. 16, the attachment was shown to enable the observation of a mark *a* on the reverse side of a plica *b* in the mirror part. The mark cannot be observed in the forward field of view. Meanwhile, Fig. 18 shows that the inner side of a bending section could be observed by using the attachment. Without the attachment, we can observe a mark *a* in the front, but cannot observe a mark *b* at the back. With the attachment, we can observe both *a* and *b*. As shown in Fig. 19, it is difficult to observe the mark *b* without the attachment because of the restriction that the maximum curvature of bending an endoscope is limited because of the intestine diameter. By contrast, the attachment enabled us to observe both *a* and *b* without complicated manipulations of the endoscope. These results showed that the attachment was useful to observe areas occluded from the forward field of view.

3.6 Evaluation by Doctors Based on an Animal Experiment

Finally, an evaluation of the attachment by three expert endoscopists based on an experiment with a model of intestine and an animal experiment are presented. First, the endoscopists tested the attachment using a model. They verified that the endoscopic video obtained images with the attachment and that the reverse side of a plica, a bending section, and the pylorus could be observed.

Next, an animal experiment using a dog was evaluated. Fig. 20 shows examples of the images of an intestine with the omnidirectional vision attachment.

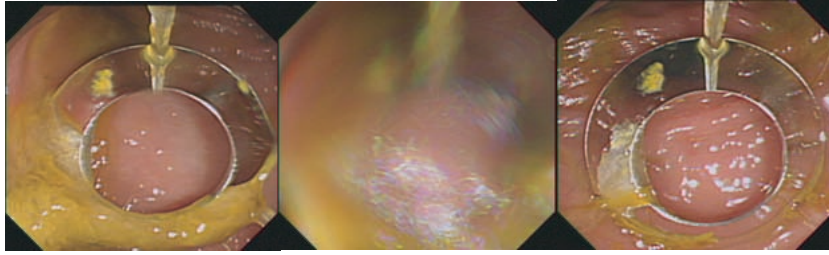

Fig. 21. Washing the attachment: one issue found in the experiment was that the mirror became blurred by residue in the intestine and could not be washed clearly in some cases.

The lateral and backward directions can be observed in the mirror part. From this experiment, we verified that endoscopists can operate an endoscope without breaking the attachment or damaging the intestine. One issue found in the experiment was that the mirror became blurred by residue in the intestine and could not be washed clearly in some cases, as shown in Fig. 21. Based on this evaluation, we plan to improve the washing method.

Another issue was that the attachment narrows the forward field of view. The evaluation by the endoscopists showed that the endoscope with the attachment could be operated in similar manner to an endoscope without the attachment when inserted for an intestinal examination. However, the image in the mirror part is disturbing for beginner endoscopists to operate an endoscope with the attachment. This is because the motion in the mirror part is in the opposite direction to the forward field of view image; however, this problem was resolved by carrying out several training exercises to use the endoscope with the attachment. In this experiment, medical endoscopists determined that they could examine an intestine even if part of the forward field of view was occluded by the attachment. This was because the outer part of the forward field of view provides images in a fine resolution. We plan to continue our evaluations to determine all practical issues.

4 Conclusion

In this paper, we proposed an omnidirectional vision attachment that enabled observations of lateral and backward panoramic field of view around an endoscopic camera. These directions are usually blind when using existing endoscopes. Since the requirements for the attachment are to provide forward and backward directional views and to maintain operability of the endoscope and forceps, we determined that the attachment would consist of an annular hyperboloidal mirror with three supports. The experimental attachment was manufactured by a molding process. We experimented with various optical characteristics of the fields of view and illumination. It was verified that the attachment provided lateral and backward fields of view with sufficient illumination. Through experimental evaluations by medical endoscopists, we showed that the panoramic field of view obtained was useful and that operability was maintained. However, since the input video is not intuitive for beginners, we plan to improve the video representation when using the attachment.

References

1. Yamaguchi, T., Nakamoto, M., Sato, Y., Nakajima, Y., Konishi, K., Hashizume, M., Nishii, T., Sugano, N., Yoshikawa, H., Yonenobu, K., Tamura, S.: Camera model and calibration procedure for oblique-viewing endoscope. In: Proc. Medical Image Computing and Computer-Assisted Intervention (MICCAI 2003). Volume 2879 of LNCS. (2003) 373–381
2. Misra, S., Dwivedi, M.: Colonoscopy and colonoscopic polypectomy using side-viewing endoscope: a useful, effective and safe procedure. *Digestive Diseases and Sciences* (2007)
3. Triadafilopoulos, G., Watts, H.D., Higgins, J., Dam, J.V.: A novel retrograde-viewing auxiliary imaging device (third eye retroscope) improves the detection of simulated polyps in anatomic models of the colon. *Gastrointestinal Endoscopy* **65**(1) (2007) 139–144
4. Arber, N., Grinshpon, R., Maor, L., Bar-Meir, S., Rex, D.: Proof-of-concept study of the Aer-O-Scope omnidirectional colonoscopic viewing system in ex vivo and in vivo porcine models. *Endoscopy* **39**(1) (2007) 412–417
5. Sagawa, R., Takatsuji, M., Echigo, T., Yagi, Y.: Calibration of lens distortion by structured-light scanning. In: Proc. 2005 IEEE/RSJ International Conference on Intelligent Robots and Systems, Edmonton, Canada (August 2005) 1349–1354
6. Grossberg, M.D., Nayar, S.K.: A general imaging model and a method for finding its parameters. In: Proc. International Conference on Computer Vision. (2001) 108–115