



**HAL**  
open science

# Guarding curvilinear art galleries with vertex or point guards

Menelaos Karavelas, Elias Tsigaridas

► **To cite this version:**

Menelaos Karavelas, Elias Tsigaridas. Guarding curvilinear art galleries with vertex or point guards. [Research Report] RR-6132, 2007. inria-00132988v7

**HAL Id: inria-00132988**

**<https://inria.hal.science/inria-00132988v7>**

Submitted on 16 Feb 2008 (v7), last revised 18 Feb 2008 (v8)

**HAL** is a multi-disciplinary open access archive for the deposit and dissemination of scientific research documents, whether they are published or not. The documents may come from teaching and research institutions in France or abroad, or from public or private research centers.

L'archive ouverte pluridisciplinaire **HAL**, est destinée au dépôt et à la diffusion de documents scientifiques de niveau recherche, publiés ou non, émanant des établissements d'enseignement et de recherche français ou étrangers, des laboratoires publics ou privés.



INSTITUT NATIONAL DE RECHERCHE EN INFORMATIQUE ET EN AUTOMATIQUE

*Guarding curvilinear art galleries with vertex or  
point guards*

Menelaos I. Karavelas — Elias P. Tsigaridas

**N° 6132**

February 2007

Thème SYM

A large, light gray stylized 'R' logo is positioned to the left of the text 'Rapport de recherche'.

*Rapport  
de recherche*





## Guarding curvilinear art galleries with vertex or point guards

Menelaos I. Karavelas\*<sup>†</sup>, Elias P. Tsigaridas<sup>‡</sup> §

Thème SYM — Systèmes symboliques  
Projet VEGAS

Rapport de recherche n° 6132 — February 2007 — 26 pages

**Abstract:** One of the earliest and most well known problems in computational geometry is the so-called *art gallery problem*. The goal is to compute the minimum possible number guards placed on the vertices of a simple polygon in such a way that they cover the interior of the polygon. We consider the problem of guarding an art gallery which is modeled as a polygon with curvilinear walls. Our main focus is on polygons the edges of which are convex arcs pointing towards the exterior or interior of the polygon (but not both), named piecewise convex and piecewise concave polygons. We prove that, in the case of piecewise convex polygons, if we only allow vertex guards,  $\lfloor \frac{4n}{7} \rfloor - 1$  guards are sometimes necessary, and  $\lfloor \frac{2n}{3} \rfloor$  guards are always sufficient. Moreover, an  $O(n \log n)$  time and  $O(n)$  space algorithm is described that produces a vertex guarding set of size at most  $\lfloor \frac{2n}{3} \rfloor$ . When we allow point guards the afore-mentioned lower bound drops down to  $\lfloor \frac{n}{2} \rfloor$ . In the special case of monotone piecewise convex polygons we can show that  $\lfloor \frac{n}{2} \rfloor + 1$  vertex or  $\lfloor \frac{n}{2} \rfloor$  point guards are always sufficient and sometimes necessary. In the case of piecewise concave polygons, we show that  $2n - 4$  point guards are always sufficient and sometimes necessary, whereas it might not be possible to guard such polygons by vertex guards. We conclude with bounds for other types of curvilinear polygons and future work.

**Key-words:** art gallery, curvilinear polygons, vertex guards, point guards, piecewise convex polygons, piecewise concave polygons

This work is partially supported by the european project ACS (Algorithms for Complex Shapes, IST FET Open 006413) and ARC ARCADIA (<http://www.loria.fr/~petitjea/Arcadia/>)

\* University of Crete, Department of Applied Mathematics, GR-714 09 Heraklion, Greece

<sup>†</sup> Foundation for Research and Technology - Hellas, Institute of Applied and Computational Mathematics P.O. Box 1385, GR-711 10 Heraklion, Greece

<sup>‡</sup> LORIA-INRIA Lorraine, Nancy, FRANCE

§ The work on this project started while at INRIA Sophia-Antipolis.

## Garder les galeries d'art curvilignes avec des gardes de sommet ou de point

**Résumé :** Un des plus anciens et plus célèbres problèmes en géométrie algorithmique est le problème dit de *galerie d'art* qui consiste à calculer le nombre minimal des gardians qui sont nécessaires afin de couvrir l'intérieur d'un polygone simple s'ils sont placés sur ses sommets.

Dans cet article, nous considérons le problème de garde d'une galerie d'art qui est modélisée par un polygone avec des murs courbés. En particulier, nous considérons des polygones dont les bords sont des arcs convexes qui se dirigent vers l'extérieur ou l'intérieur du polygone (mais pas les deux au même temps), appelés polygones par morceaux convexes ou concaves respectivement. Nous montrons que, dans le cas de polygones par morceaux convexes, si nous permettons seulement des gardians de sommets, alors  $\lfloor \frac{4n}{7} \rfloor - 1$  gardians sont parfois nécessaires, et  $\lfloor \frac{2n}{3} \rfloor$  gardians sont toujours suffisants. D'ailleurs, nous décrivons un algorithme,  $O(n \log n)$  en temps et  $O(n)$  en espace, qui produit l'ensemble des sommets de garde de taille au plus  $\lfloor \frac{2n}{3} \rfloor$ . Dans le cas particulier de polygones monotones et par morceaux convexes nous pouvons montrer que  $\lfloor \frac{n}{2} \rfloor + 1$  gardians de sommets ou  $\lfloor \frac{n}{2} \rfloor$  gardians de points sont toujours suffisants et parfois nécessaires.

Dans le cas des polygones par morceaux concaves, nous prouvons que  $2n - 4$  gardians de points sont toujours suffisants et parfois nécessaires, tandis qu'il ne peut être possible de garder de tels polygones par des gardians de sommets. Nous concluons avec des limites pour d'autres types de polygones courbés et perspectives pour le futur.

**Mots-clés :** galerie d'art; polygones courbés, gardians de sommet, gardians de point, polygones par morceau convexes, polygones par morceau concaves

## 1 Introduction

Consider a simple polygon  $P$  with  $n$  vertices. What is the worst-case bound on the number of guards that we need to place on the vertices of  $P$  so that any point in  $P$  is visible from at least one guard — two points in  $P$  are visible from each other if the line segment connecting them lies entirely inside  $P$ . This problem, the minimization version of which is known as the *art gallery problem*, has been one of the earliest problems in Computational Geometry. Applications areas include robotics [21, 36], motion planning [24, 28], computer vision and pattern recognition [32, 37, 2, 33], graphics [26, 7], CAD/CAM [4, 15] and wireless networks [16]. In the late 1980's to mid 1990's interest moved from linear polygonal objects to curvilinear objects [35, 9, 11, 10] — see also the paper by Dobkin and Souvaine [13] that extends linear polygon algorithms to curvilinear polygons, as well as the recent book edited by Boissonnat and Teillaud [3] for a collection of results on computational geometry for curves and surfaces. In this context this paper addresses the classical art gallery problem for various classes of polygonal regions the edges of which are arcs of curves. To the best of our knowledge this is the first time that the art gallery problem is considered in this context.

The first results on the art gallery problem or its variations date back to the 1970's. Chvátal [8] was the first to prove that any simple polygon with  $n$  vertices can always be monitored with  $\lfloor \frac{n}{3} \rfloor$  vertices; this bound is tight in the worst case. The proof by Chvátal was quite tedious and Fisk [18] gave a much simpler proof by means of triangulating the polygon and coloring its vertices using three colors in such a way so that no triangle in the triangulation of the polygon contains two vertices of the same color. The algorithm proposed by Fisk runs in  $O(T(n) + n)$  time, where  $T(n)$  is the time to triangulate a simple polygon. Following Chazelle's linear-time algorithm for triangulating a simple polygon [5, 6], the algorithm proposed by Fisk runs in  $O(n)$  time. Lee and Lin [22] showed that computing the minimum number of vertex guards for a given simple polygon is NP-hard, which was extended to point guards by Aggarwal [1]. Soon afterwards other types of polygons were considered. Kahn, Klawe and Kleitman [19] showed that simple orthogonal polygons of size  $n$ , i.e., simple polygons with axes-aligned edges, can always be monitored with  $\lfloor \frac{n}{4} \rfloor$  vertex guards, which is also the worst-case lower bound. Several  $O(n)$  algorithms have been proposed for this variation of the problem, notably by Sack [30], who gave the first such algorithm, and later on by Lubiw [25]. Edelsbrunner, O'Rourke and Welzl [14] gave a linear time algorithm for monitoring orthogonal polygons with  $\lfloor \frac{n}{4} \rfloor$  point guards.

Beside simple polygons and simple orthogonal polygons, polygons with holes, and orthogonal polygons with holes have been investigated. As far as the type of guards is concerned, *edge guards* and *mobile guards* have been considered. An edge (resp. mobile) guard is an edge (resp. edge or diagonal) of the polygon, and a point is visible from it if it is visible from at least one point on the edge (resp. edge or diagonal). Other types of guarding problems have also been studied in the literature, notably, the *fortress problem* (monitor the exterior of the polygon against enemy raids) and the *prison yard problem* (monitor both the interior and the exterior of the polygon which represents a prison: prisoners must be monitored in the interior of the prison and should not be allowed to escape out of the prison). For a detailed discussion of these variations and the corresponding results the interested reader should refer to the book by O'Rourke [29], the survey paper by Shermer [31] and the book chapter by Urrutia [34].

In this paper we are primarily interested in the case of vertex guards, although results about point guards are also described. In our case, polygons are not required to have linear edges. On the contrary we consider polygons that have smooth curvilinear edges. Clearly, the minimization versions of these problems are NP-hard, since they are direct generalizations of the corresponding art gallery problems for polygons with linear edges. The main focus of this paper is the class of polygons that are either locally convex or locally concave (except possibly at the vertices), the edges of which are convex arcs; we call such polygons *piecewise-convex* and *piecewise-concave polygons*, respectively.

For the first class of polygons we show that it is always possible to monitor them with  $\lfloor \frac{2n}{3} \rfloor$  vertex guards, where  $n$  is the number of polygon vertices. On the other hand we describe families of piecewise-convex polygons that require a minimum of  $\lfloor \frac{4n}{7} \rfloor - 1$  vertex guards and  $\lfloor \frac{n}{2} \rfloor$  point guards. Aside from the worst-case upper (resp. lower) bound on the number of guards that are sufficient (resp. necessary) in order to monitor a piecewise-convex polygon, we describe an  $O(n \log n)$  time and  $O(n)$  space algorithm which computes a vertex guard set of size at most  $\lfloor \frac{2n}{3} \rfloor$ . Our algorithm should be viewed as a generalization of Fisk's algorithm [18]; in fact, when applied to polygons with linear edges, it produces a guard set of size at most  $\lfloor \frac{n}{3} \rfloor$ . For the purposes of our complexity analysis and results, we assume, throughout the paper, that the curvilinear edges of our polygons are arcs of algebraic curves of constant degree; as a result all predicates required by the algorithms described in this paper take  $O(1)$  time in the Real RAM computation model. The central idea for both obtaining the worst-case upper bound, as well as for designing our algorithm, is to approximate the piecewise-convex polygon by a linear polygon (a polygon with line segments as edges). Additional Steiner vertices are added on the boundary of the curvilinear polygon in order to achieve this. The resulting linear polygon is a simple polygon and captures the essentials of the geometry of the piecewise-convex polygon; for obvious reasons we term this linear polygon the *polygonal approximation*. Once the polygonal approximation has been constructed, we compute a guard set for it by applying a slight modification of Fisk's algorithm [18]. The guard set just computed for the polygonal approximation turns out to be a guard set for the original curvilinear polygon. The final step of both the proof and our algorithm consists in mapping the guard set of the polygonal approximation to a vertex guard set consisting of vertices of the original polygon only.

For piecewise-concave polygons vertex guards may not be sufficient in order to monitor the interior of the polygon (see Fig. 15(a)). We thus turn our attention to point guards, and we show that  $2n - 4$  point guards are always sufficient and sometimes necessary. Our method for showing the sufficiency result is similar to the technique used to illuminate sets of disjoint convex objects on the plane [17]. Given a piecewise-concave polygon  $P$ , we construct a new locally concave polygon  $Q$ , contained inside  $P$ , and such that the tangencies between edges of  $Q$  are maximized. The problem of monitoring  $P$  then reduces to the problem of monitoring  $Q$ , which essentially consists of a number of faces with pairwise disjoint interiors. The faces of  $Q$  require, each, two point guards in order to be monitored, and are in 1–1 correspondence with the triangles of an appropriately defined triangulation graph  $\mathcal{T}(R)$  of a polygon  $R$  with  $n$  vertices. Thus the number of point guards required to monitor  $P$  is at most two times the number of faces of  $\mathcal{T}(R)$ , i.e.,  $2n - 4$ .

The rest of the paper is structured as follows. In Section 2 we introduce some notation and provide various definitions. In Section 3 we present our algorithm for computing a vertex guard set,

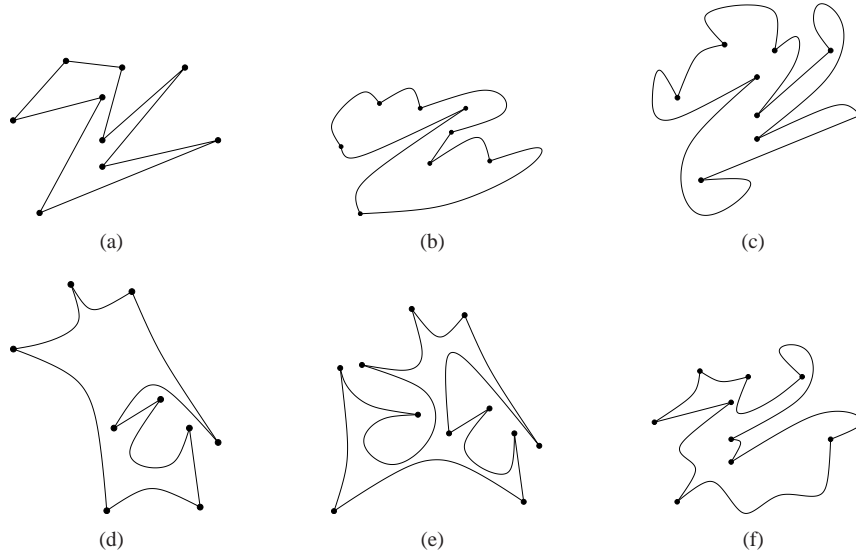

Figure 1: Different types of curvilinear polygons: (a) a linear polygon, (b) a piecewise-convex polygon, (c) a locally convex polygon, (d) a piecewise-concave polygon, (e) a locally concave polygon and (f) a general polygon.

of size  $\lfloor \frac{2n}{3} \rfloor$ , for a piecewise-convex polygon with  $n$  vertices, and present families of piecewise-convex polygons that require a minimum of  $\lfloor \frac{4n}{7} \rfloor - 1$  vertex or  $\lfloor \frac{n}{2} \rfloor$  point guards in order to be monitored. In Section 4 we present our results for piecewise-concave polygons, namely, that  $2n - 4$  point guards are always necessary and sometimes sufficient for this class of polygons. The final section of the paper, Section 5, discusses further results and states open problems.

## 2 Definitions

**Types of curvilinear polygons.** Let  $V$  be a sequence of points  $v_1, \dots, v_n$ ,  $n \geq 2$ , and  $A$  a set of curvilinear arcs  $a_1, \dots, a_n$ , such that  $a_i$  has as endpoints the points  $v_i$  and  $v_{i+1}$ <sup>1</sup>. We will assume that the arcs  $a_i$  and  $a_j$ ,  $i \neq j$ , do not intersect, except when  $j = i - 1$  or  $j = i + 1$ , in which case they intersect only at the points  $v_i$  and  $v_{i+1}$ , respectively. We define a *curvilinear polygon*  $P$  to be the closed region delimited by the arcs  $a_i$ . The points  $v_i$  are called the vertices of  $P$ . An arc  $a_i$  is a *convex arc* if every line on the plane intersects  $a_i$  at either at most two points or along a linear segment.

<sup>1</sup>Indices are considered to be evaluated modulo  $n$ .



A polygon  $P$  is a *linear polygon* if its edges are line segments (see Fig. 1(a)). A polygon  $P$  is *locally convex* (see Fig. 1(c)), (resp. *locally concave* (see Fig. 1(e))), if for every point  $p$  on the boundary of  $P$ , with the possible exception of  $P$ 's vertices, there exists disk with its center on  $p$ , say  $D_p$ , such that  $P \cap D_p$  is convex (resp. concave). A polygon  $P$  is *piecewise-convex* (see Fig. 1(b)), (resp. *piecewise-concave* (see Fig. 1(d))), if it is locally convex (resp. concave), and the portion of the boundary between every two consecutive vertices is a convex arc. Finally, a polygon is said to be a *general polygon* if we impose no restrictions on the type of its edges (see Fig. 1(f)). We will use the term *curvilinear polygon* to refer to a polygon the edges of which are either line or curve segments.

**Guards and guard sets.** In our setting, a *guard* or *point guard* is a point in the interior or on the boundary of a curvilinear polygon  $P$ . A guard of  $P$  that is also a vertex of  $P$  is called a *vertex guard*. We say that a curvilinear polygon  $P$  is *monitored* by a set  $G$  of guards if every point in  $P$  is visible from at least one point in  $G$ , where two points  $p$  and  $q$  inside  $P$  are visible from each other if the line segment  $pq$  lies entirely inside  $P$ . The set  $G$  that has this property is called a *guard set* for  $P$ . A guard set that consists solely of vertices of  $P$  is called a *vertex guard set*.

### 3 Piecewise-convex polygons

In this section we present an algorithm which, given a piecewise-convex polygon  $P$  of size  $n$ , computes a vertex guard set  $G$  of size  $\lfloor \frac{2n}{3} \rfloor$ . The basic steps of the algorithm are as follows:

1. Compute the polygonal approximation  $\tilde{P}$  of  $P$ .
2. Compute a constrained triangulation  $\mathcal{T}(\tilde{P})$  of  $\tilde{P}$ .
3. Compute a guard set  $G_{\tilde{P}}$  for  $\tilde{P}$ , by coloring the vertices of  $\mathcal{T}(\tilde{P})$  using three colors.
4. Compute a guard set  $G_P$  for  $P$  from the guard set  $G_{\tilde{P}}$ .

#### 3.1 Polygonalization of a piecewise-convex polygon

Let  $a_i$  be a convex arc with endpoints  $v_i$  and  $v_{i+1}$ . We call the convex region  $r_i$  delimited by  $a_i$  and the line segment  $v_i v_{i+1}$  a *room*. A room is called degenerate if the arc  $a_i$  is a line segment. A line segment  $pq$ , where  $p, q \in a_i$  is called a *chord*, and the region delimited by the chord  $pq$  and  $a_i$  is called a *sector*. The chord of a room  $r_i$  is defined to be the line segment  $v_i v_{i+1}$  connecting the endpoints of the corresponding arc  $a_i$ . A degenerate sector is a sector with empty interior. We distinguish between two types of rooms (see Fig. 2):

1. *empty rooms*: these are non-degenerate rooms that do not contain any vertex of  $P$  in their interior or in the interior of their chord.
2. *non-empty rooms*: these are non-degenerate rooms that contain at least one vertex of  $P$  in their interior or in the interior of their chord.

In order to polygonalize  $P$  we are going to add new vertices in the interior of non-linear convex arcs. To distinguish between the two types of vertices, the  $n$  vertices of  $P$  will be called *original vertices*, whereas the additional vertices will be called *Steiner vertices*.

More specifically, for each empty room  $r_i$  we add a vertex  $w_{i,1}$  (anywhere) in the interior of the arc  $a_i$  (see Fig. 3). For each non-empty room  $r_i$ , let  $X_i$  be the set of vertices of  $P$  that lie in the interior of the chord  $v_i v_{i+1}$  of  $r_i$ , and  $R_i$  be the set of vertices of  $P$  that are contained in the interior of  $r_i$  or belong to  $X_i$  (by assumption  $R_i \neq \emptyset$ ). If  $R_i \neq X_i$ , let  $C_i$  be the set of vertices on the convex

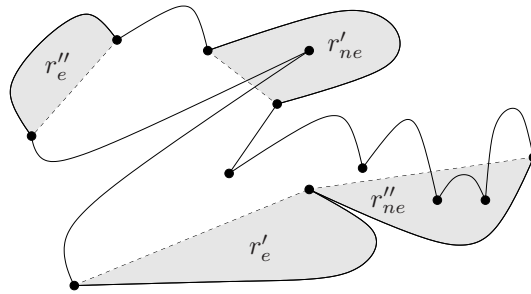

Figure 2: The two types of rooms in a piecewise-convex polygon:  $r'_e$  and  $r''_e$  are empty rooms, whereas  $r'_{ne}$  and  $r''_{ne}$  are non-empty rooms.

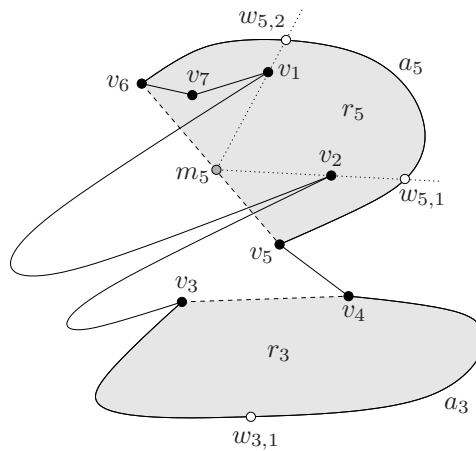

Figure 3: The Steiner vertices (white points) for rooms  $r_3$  (empty) and  $r_5$  (non-empty).  $w_{3,1}$  is a point in the interior of  $a_3$ .  $m_5$  is the midpoint of  $v_5$  and  $v_6$ , whereas  $w_{5,1}$  and  $w_{5,2}$  are the intersections of the lines  $m_5 v_2$  and  $m_5 v_1$  with the arc  $a_5$ , respectively. In this example  $R_5 = \{v_1, v_2, v_7\}$ , whereas  $C_5^* = \{v_1, v_2\}$ .

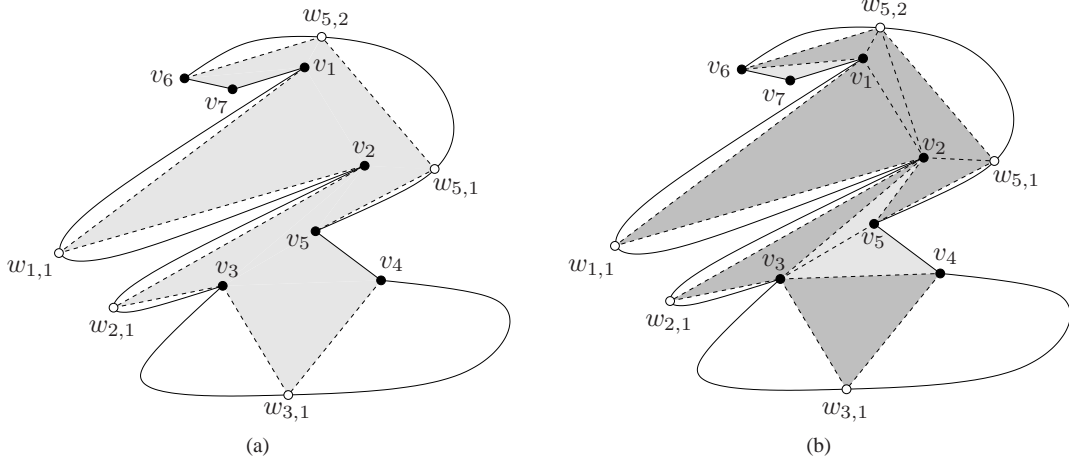

Figure 4: (a) The polygonal approximation  $\tilde{P}$ , shown in gray, of the piecewise-convex polygon  $P$  with vertices  $v_i$ ,  $i = 1, \dots, 7$ . (b) The constrained triangulation  $\mathcal{T}(\tilde{P})$  of  $\tilde{P}$ . The dark gray triangles are the constrained triangles. The polygonal region  $v_5 w_{5,1} w_{5,2} v_6 v_1 v_2 v_5$  is a crescent. The triangles  $w_{5,1} v_2 v_5$  and  $v_1 w_{5,2} v_6$  are boundary crescent triangles. The triangle  $v_2 w_{5,2} v_1$  is an upper crescent triangle, whereas the triangle  $v_2 w_{5,1} w_{5,2}$  is a lower crescent triangle.

hull of the vertex set  $(R_i \setminus X_i) \cup \{v_i, v_{i+1}\}$ ; if  $R_i = X_i$ , let  $C_i = X_i \cup \{v_i, v_{i+1}\}$ . Finally, let  $C_i^* = C_i \setminus \{v_i, v_{i+1}\}$ . Clearly,  $v_i$  and  $v_{i+1}$  belong to the set  $C_i$  and, furthermore,  $C_i^* \neq \emptyset$ .

Let  $m_i$  be the midpoint of  $v_i v_{i+1}$  and  $\ell_i^\perp(p)$  the line perpendicular to  $v_i v_{i+1}$  passing through a point  $p$ . If  $C_i^* \neq X_i$ , then, for each  $v_k \in C_i^*$ , let  $w_{i,j_k}$ ,  $1 \leq j_k \leq |C_i^*|$ , be the (unique) intersection of the line  $m_i v_k$  with the arc  $a_i$ ; if  $C_i^* = X_i$ , then, for each  $v_k \in C_i^*$ , let  $w_{i,j_k}$ ,  $1 \leq j_k \leq |C_i^*|$ , be the (unique) intersection of the line  $\ell_i^\perp(v_k)$  with the arc  $a_i$ .

Now consider the sequence  $\tilde{V}$  of the original vertices of  $P$  augmented by the Steiner vertices added to empty and non-empty rooms; the order of the vertices in  $\tilde{V}$  is the order in which we encounter them as we traverse the boundary of  $P$  counterclockwise. The linear polygon defined by the sequence  $\tilde{V}$  of vertices is denoted by  $\tilde{P}$  (see Fig. 4(a)). It is easy to show that:

**Lemma 1** *The linear polygon  $\tilde{P}$  is a simple polygon.*

*Proof.* It suffices show that the line segments replacing the curvilinear segments of  $P$  do not intersect other edges of  $P$  or  $\tilde{P}$ .

Let  $r_i$  be an empty room, and let  $w_{i,1}$  be the point added in the interior of  $a_i$ . The interior of the line segments  $v_i w_{i,1}$  and  $w_{i,1} v_{i+1}$  lie in the interior of  $r_i$ . Since  $P$  is a piecewise-convex polygon, and  $r_i$  is an empty room, no edge of  $P$  could potentially intersect  $v_i w_{i,1}$  or  $w_{i,1} v_{i+1}$ . Hence replacing  $a_i$  by the polyline  $v_i w_{i,1} v_{i+1}$  gives us a new piecewise-convex polygon.

Let  $r_i$  be a non-empty room. Let  $w_{i,1}, \dots, w_{i,K_i}$  be the points added on  $a_i$ , where  $K_i$  is the cardinality of  $C_i^*$ . By construction, every point  $w_{i,k}$  is visible from  $w_{i,k+1}$ ,  $k = 1, \dots, K_i - 1$ , and every point  $w_{i,k}$  is visible from  $w_{i,k-1}$ ,  $k = 2, \dots, K_i$ . Moreover,  $w_{i,1}$  is visible from  $v_i$  and  $w_{i,K_i}$  is visible from  $v_{i+1}$ . Therefore, the interior of the segments in the polyline  $v_i w_{i,1} \dots w_{i,K_i} v_{i+1}$  lie in the interior of  $r_i$  and do not intersect any arc in  $P$ . Hence, substituting  $a_i$  by the polyline  $v_i w_{i,1} \dots w_{i,K_i} v_{i+1}$  gives us a new piecewise-convex polygon.

As a result, the linear polygon  $\tilde{P}$  is a simple polygon.  $\square$

We call the linear polygon  $\tilde{P}$ , defined by  $\tilde{V}$ , the *straight-line polygonal approximation* of  $P$ , or simply the *polygonal approximation* of  $P$ . An obvious result for  $\tilde{P}$  is the following:

**Corollary 2** *If  $P$  is a piecewise-convex polygon the polygonal approximation  $\tilde{P}$  of  $P$  is a linear polygon that is contained inside  $P$ .*

We end this subsection by proving a tight upper bound on the size of the polygonal approximation of a piecewise-convex polygon. We start by stating and proving an intermediate result, namely that the sets  $C_i^*$  are pairwise disjoint.

**Lemma 3** *Let  $i, j$ , with  $1 \leq i < j \leq n$ . Then  $C_i^* \cap C_j^* = \emptyset$ .*

*Proof.* Consider an arc  $a_i$  of  $P$ , delimited by the vertices  $v_i$  and  $v_{i+1}$  and let  $\pi_i$  denote the shortest path between them. Note that the internal vertices of  $\pi_i$  are vertices of  $C_i^*$ , and so  $\pi_i$  is also a convex arc. The convex arcs  $a_i$  and  $\pi_i$  bound a (curvilinear) polygon, that we denote by  $Q_i$ , for which  $\pi_i$  is locally concave. That is, every point in  $C_i^*$  is a reflex vertex of  $Q_i$ , and so every point in  $C_i^*$  is a reflex (i.e., locally concave) vertex of  $P$  as well. At every vertex  $w \in C_i^*$ , the bisector of the internal angle of  $P$  enters the polygon  $Q_i$  and leaves  $Q_i$  (and  $P$ ) at some point along  $a_i$ .

Consider the bisector of the internal angle at every reflex vertex  $w$  of  $P$ . If the bisector intersects some arc  $a_j$ , then  $w$  can belong to the set  $C_j^*$ . Since every bisector intersects at most one arc  $a_j$ , every vertex  $w$  belongs to at most one set  $C_j^*$ .  $\square$

An immediate consequence of Lemma 3 is the following corollary that gives us a tight bound on the size of the polygonal approximation  $\tilde{P}$  of  $P$ .

**Corollary 4** *If  $n$  is the size of a piecewise-convex polygon  $P$ , the size of its polygonal approximation  $\tilde{P}$  is at most  $3n$ . This bound is tight (up to an additive constant).*

*Proof.* Let  $a_i$  be a convex arc of  $P$ , and let  $r_i$  be the corresponding room. If  $r_i$  is an empty room, then  $\tilde{P}$  contains one Steiner vertex due to  $a_i$ . Hence  $\tilde{P}$  contains at most  $n$  Steiner vertices attributed to empty rooms in  $P$ . If  $a_i$  is a non-empty room, then  $\tilde{P}$  contains  $|C_i^*|$  Steiner vertices due to  $a_i$ . By Lemma 3 the sets  $C_i^*$ ,  $i = 1, \dots, n$  are pairwise disjoint, which implies that  $\sum_{i=1}^n |C_i^*| \leq |P| = n$ . Therefore  $\tilde{P}$  contains the  $n$  vertices of  $P$ , contains at most  $n$  vertices due to empty rooms in  $P$ , and at most  $n$  vertices due to non-empty rooms in  $P$ . We thus conclude that the size of  $\tilde{P}$  is at most  $3n$ .

The upper bound of the paragraph above is tight up to an additive constant. Consider the piecewise-convex polygon  $P$  of Fig. 5. It consists of  $n - 1$  empty rooms and one non-empty room  $r_1$ , such that  $|C_1^*| = n - 2$ . It is easy to see that  $|\tilde{P}| = 3n - 3$ .  $\square$

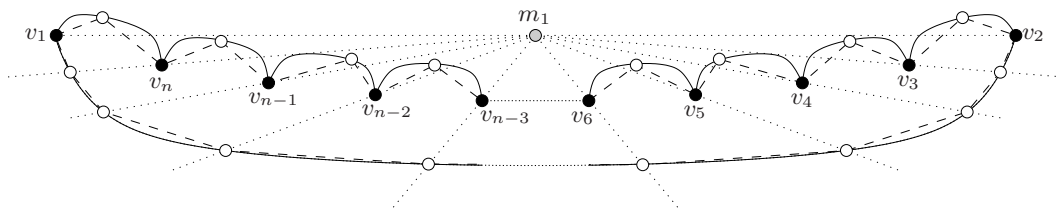

Figure 5: A piecewise-convex polygon  $P$  of size  $n$  (solid curve), the polygonal approximation  $\tilde{P}$  of which consists of  $3n - 3$  vertices (dashed polyline).

### 3.2 Triangulating the polygonal approximation

Let  $P$  be a piecewise-convex polygon,  $\tilde{P}$  its polygonal approximation, and  $S_{\tilde{P}}$  the set of Steiner vertices in  $\tilde{P}$ . We are going to construct a *constrained triangulation* of  $\tilde{P}$ , i.e., we are going to triangulate  $\tilde{P}$ , while enforcing some triangles to be part of this triangulation. More precisely, we are going to enforce the way the triangles of  $\mathcal{T}(\tilde{P})$  are created in the neighborhoods of the vertices in  $S_{\tilde{P}}$ . By enforcing the triangles in these neighborhoods, we effectively triangulate parts of  $\tilde{P}$ . The remaining untriangulated parts of  $\tilde{P}$  consist of one or more interior disjoint polygons, which can then be triangulated in linear time and space. The pre-specified triangles in  $\mathcal{T}(\tilde{P})$  will be referred to as *constrained triangles*. The rationale behind the way this particular constrained triangulation is constructed is to ensure that:

1. every triangle of  $\mathcal{T}(\tilde{P})$ , that contains a vertex in  $S_{\tilde{P}}$ , also contains at least one vertex of  $P$ , i.e., no triangles contain only Steiner vertices,
2. every vertex in  $S_{\tilde{P}}$  belongs to at least one triangle in  $\mathcal{T}(\tilde{P})$  the other two vertices of which are both vertices of  $P$ , and
3. the triangles of  $\mathcal{T}(\tilde{P})$  that contain vertices of  $\tilde{P}$  can be monitored by vertices of  $P$ .

These properties are going to be exploited in Step 4 of the algorithm presented later in this subsection.

Let us proceed to define the constrained triangles in  $\mathcal{T}(\tilde{P})$ . If  $r_i$  is an empty room, and  $w_{i,1}$  is the point added on  $a_i$ , add the edges  $v_i v_{i+1}$ ,  $v_i w_{i,1}$  and  $w_{i,1} v_{i+1}$ , thus forming the constrained triangle  $v_i w_{i,1} v_{i+1}$  (see Fig. 4(b)). If  $r_i$  is a non-empty room,  $c_1, \dots, c_{K_i}$  the vertices in  $C_i^*$ ,  $K_i = |C_i^*|$ , and  $w_{i,1}, \dots, w_{i,K_i}$  the vertices added on  $a_i$  ( $w_{i,j}$  has been added on  $a_i$  due to  $c_j$ ), add the following edges, if they do not already exist:

1.  $c_k, c_{k+1}$ , for  $k = 1, \dots, K_i - 1$ , and  $v_i c_1, c_{K_i} v_{i+1}$ ;
2.  $c_k w_{i,k}$ , for  $k = 1, \dots, K_i$ ;
3.  $c_k w_{i,k+1}$ , for  $k = 1, \dots, K_i - 1$ ;

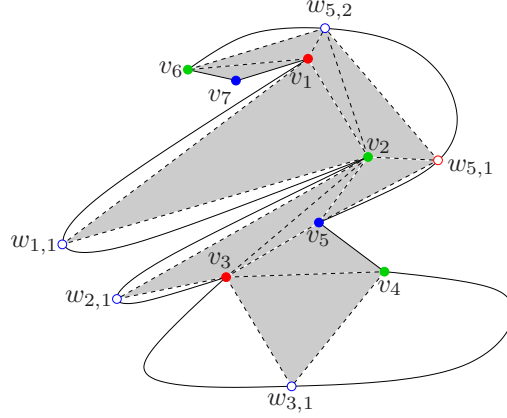

Figure 6: The three guard sets for  $\tilde{P}$ , are also guard sets for  $P$ , as Lemma 5 suggests.

4.  $w_{i,k}, w_{i,k+1}$ , for  $k = 1, \dots, K_i - 1$ , and  $v_i w_{i,1}, w_{i,K_i} v_{i+1}$ .

These edges form  $2K_i$  constrained triangles:  $c_k c_{k+1} w_{i,k+1}$ , for  $k = 1, \dots, K_i - 1$ ;  $c_k w_{i,k} w_{i,k+1}$ , for  $k = 1, \dots, K_i - 1$ ;  $v_i c_1 w_{i,1}$  and  $v_{i+1} c_{K_i} w_{i,K_i}$ . We call the polygonal region delimited by these triangles a *crescent*. The triangles  $v_i c_1 w_{i,1}$  and  $v_{i+1} c_{K_i} w_{i,K_i}$  are called *boundary crescent triangles*, the triangles  $c_k c_{k+1} w_{i,k+1}$ ,  $k = 1, \dots, K_i - 1$  are called *upper crescent triangles* and the triangles  $c_k w_{i,k} w_{i,k+1}$ ,  $k = 1, \dots, K_i - 1$  are called *lower crescent triangles*.

Note that the points  $w_{i,j}$ ,  $j < K_i$  (resp.  $w_{i,K_i}$ ) are vertices of exactly one triangle (resp. exactly two triangles) in  $\mathcal{T}(\tilde{P})$ , such that the other two vertices of the triangle (resp. of each of the two triangles) belong to  $P$ .

### 3.3 Computing a guard set for the original polygon

Assume that we have colored the vertices  $\tilde{V}$  of  $\tilde{P}$  with three colors, so that no triangle in  $\mathcal{T}(\tilde{P})$  contains two vertices of the same color. This can be easily done by the standard three-coloring algorithm for linear polygons presented in [27, 18]. Let red, green and blue be the three colors, and let  $K_A, \Pi_A$  and  $M_A$  be the set of vertices of red, green and blue color, respectively, in a subset  $A$  of  $\tilde{P}$ . Clearly, all three sets  $K_{\tilde{P}}, \Pi_{\tilde{P}}$  and  $M_{\tilde{P}}$  are guard sets for  $\tilde{P}$ . In fact, they are also guard sets for  $P$ , as the following lemma suggests (see also Fig. 6).

**Lemma 5** *Each one of the sets  $K_{\tilde{P}}, \Pi_{\tilde{P}}$  and  $M_{\tilde{P}}$  is a guard set for  $P$ .*

*Proof.* Let  $G_{\tilde{P}}$  be one of  $K_{\tilde{P}}, \Pi_{\tilde{P}}$  and  $M_{\tilde{P}}$ . By construction,  $G_{\tilde{P}}$  monitors all triangles in  $\mathcal{T}(\tilde{P})$ . To show that  $G_{\tilde{P}}$  is a guard set for  $P$ , it suffices to show that  $G_{\tilde{P}}$  also monitors the non-degenerate sectors defined by the edges of  $\tilde{P}$  and the corresponding convex subarcs of  $P$ .

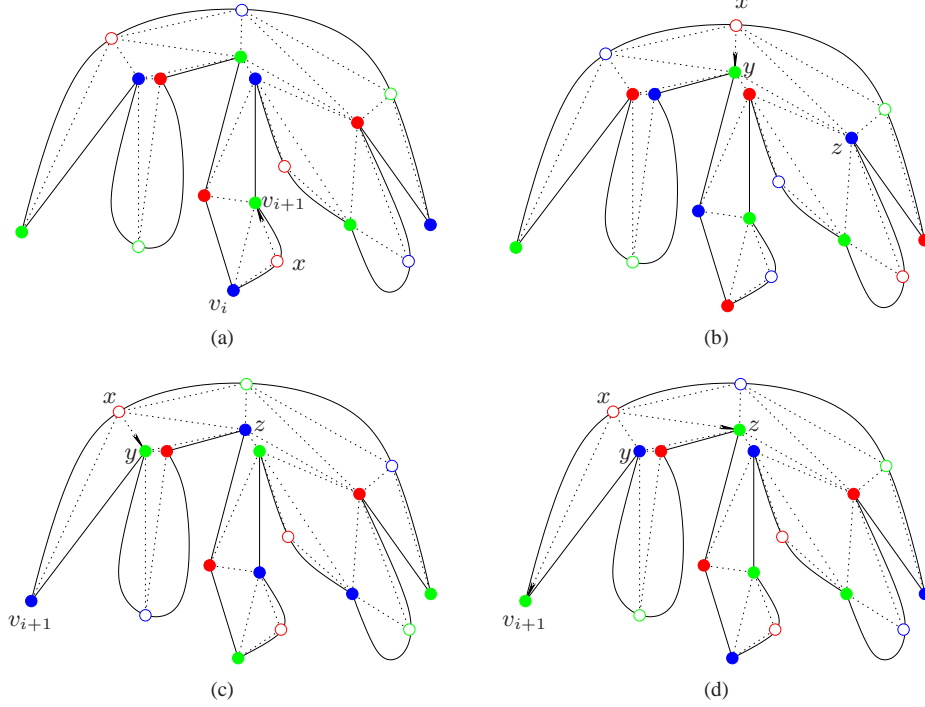

Figure 7: The three cases in the definition of the mapping  $f$ . Case (a):  $x$  is a Steiner vertex in an empty room. Case (b):  $x$  is a Steiner vertex in a non-empty room and is not the last Steiner vertex added on the curvilinear arc. Cases (c) and (d):  $x$  is the last Steiner vertex added on the curvilinear arc of a non-empty room (in (c)  $|f(x)| = 1$ , whereas in (d)  $|f(x)| = 2$ ).

Indeed, let  $s$  be a non-degenerate sector associated with the convex arc  $a_i$ , and let  $T \in \mathcal{T}(\tilde{P})$  be the triangle incident to the chord of  $s$ . If  $r_i$  is an empty room, each of the three vertices of  $T$  monitors  $r_i$  (and therefore also  $s$ ). If  $r_i$  is a non-empty room, the vertex of  $T$  that is not an endpoint of the chord of  $s$  is a vertex in  $C_i^*$  and monitors  $s$  by construction. Clearly, one of the three vertices of  $T$  belongs to  $G_{\tilde{P}}$ .  $\square$

Let us now assume, without loss of generality, that  $|K_P| \leq |\Pi_P| \leq |M_P|$ . Define the mapping  $f$  from  $K_{S_{\tilde{P}}}$  to the power set  $2^{\Pi_P}$  of  $\Pi_P$  by mapping a vertex  $x$  in  $K_{S_{\tilde{P}}}$  to all the neighboring vertices of  $x$  in  $\mathcal{T}(\tilde{P})$  that belong to  $\Pi_P$  (see Fig. 7 for the three possible cases for  $x$ ). Notice that  $1 \leq |f(x)| \leq 2$ .

Finally, define the set  $G_P = K_P \cup f(K_{S_{\tilde{P}}})$ , where  $f(K_{S_{\tilde{P}}}) = \bigcup_{x \in K_{S_{\tilde{P}}}} f(x)$ . We claim that  $G_P$  is a guard set for  $P$ .

**Lemma 6** *The set  $G_P = K_P \cup f(K_{S_{\tilde{P}}})$  is a guard set for  $P$ .*

*Proof.* The regions in  $P^\alpha$  are sectors defined by a curvilinear arc, which is a subarc of an edge of  $P$  and the corresponding chord connecting the endpoints of this subarc. To show that  $G_P$  is a guard set for  $P$ , it suffices show that every triangle in  $\mathcal{T}(\tilde{P})$  and every sector in  $P^\alpha$  is monitored by at least one vertex in  $G_P$ .

If  $T$  is a triangle in  $\mathcal{T}(\tilde{P})$  that is defined over vertices of  $P$ , one of its vertices is in  $K_P \subseteq G_P$ . If  $T$  is a triangle inside an empty room, or a boundary crescent triangle, either the unique Steiner vertex of  $T$  is in  $K_{\tilde{P}}$ , in which case one of the other two vertices of  $T$  belongs to  $f(K_{S_{\tilde{P}}})$ , or the Steiner vertex of  $T$  is not in  $K_P$ , in which case one of the other two vertices of  $T$  belongs to  $K_P$ . Moreover, the sector/sectors adjacent to an edge of  $T$  in  $r_i$  is/are visible by both vertices of  $T$  in  $P$  and thus monitored by one of them. Finally, upper and lower crescent triangles come in pairs. Let  $T$  be an upper crescent triangle in a non-empty room  $r_i$ . Let  $x, y$  be the vertices of  $T$  in  $P$ , and let  $z$  be its vertex in  $S_{\tilde{P}}$ ; it is assumed here that  $z$  is the intersection of  $m_i y$  with  $a_i$ . Let  $T'$  be the lower crescent triangle adjacent to  $T$  along the edge  $xz$ ,  $w$  be the third vertex of  $T'$ , and  $s$  be the sector in  $P^\alpha$  adjacent to  $zw$ . Since  $x$  and  $y$  belong to  $C_i^*$ , either  $x$  or  $y$  monitors  $T, T'$  and  $s$ . We end the proof by claiming that either  $x$  or  $y$  belongs to  $G_P$ : if  $x$  or  $y$  belongs to  $K_P$  the claim is obvious; if neither  $x$  nor  $y$  belongs to  $K_P$ , then  $z \in K_P$  in which case one of  $x$  and  $y$  belongs to  $f(K_{S_{\tilde{P}}})$ .  $\square$

Since  $f(K_{S_{\tilde{P}}}) \subseteq \Pi_P$  we get that  $G_P \subseteq K_P \cup \Pi_P$ . Since  $K_P$  and  $\Pi_P$  are the two sets of smallest cardinality among  $K_P, \Pi_P$  and  $M_P$ , we conclude that  $|G_P| \leq |K_P| + |\Pi_P| \leq \lfloor \frac{2n}{3} \rfloor$ , and thus arrive at the following theorem.

**Theorem 7** *Let  $P$  be a piecewise-convex polygon with  $n \geq 2$  vertices.  $P$  can be monitored with at most  $\lfloor \frac{2n}{3} \rfloor$  vertex guards.*

We close this subsection by making two remarks:

**Remark 1** *The bound on the size of the vertex guard set in Theorem 7 is tight: our algorithm will produce a vertex guard set of size exactly  $\lfloor \frac{2n}{3} \rfloor$  when applied to the piecewise-convex polygon of Fig. 5 or the crescent-like piecewise-convex polygon of Fig. 11.*

**Remark 2** *When the input to our algorithm is a linear polygon all rooms are degenerate; consequently, no Steiner vertices are created, and the guard set computed corresponds to the set of colored vertices of smallest cardinality, hence producing a vertex guard set of size at most  $\lfloor \frac{n}{3} \rfloor$ . In that respect, our algorithm can be viewed as a generalization of Fisk's algorithm [18] to the class of piecewise-convex polygons.*

**Remark 3** *Given a linear polygon  $P$  with  $r \geq 2$  reflex vertices, we can view  $P$  as a piecewise-convex polygon the edges of which are  $c$  convex polylines, where  $c \geq r$ . In this context Theorem 7 can be "translated" as follows:*

*Consider a linear polygon  $P$  with  $r \geq 2$  reflex vertices. If  $P$  can be decomposed into  $c \geq r$  convex polylines pointing towards the exterior of the polygon, then  $P$  can be monitored with at most  $\lfloor \frac{2c}{3} \rfloor$  vertex guards.*



### 3.4 Time and space complexity

In this subsection we will show how to compute the vertex guard set  $G_P$  in  $O(n \log n)$  time and  $O(n)$  space. It is straightforward to show that Steps 2–4 of our algorithm (see beginning of Section 3) can be implemented in linear time and space. To complete our time and space complexity analysis, we need to show how to compute the polygonal approximation  $\tilde{P}$  of  $P$  in  $O(n \log n)$  time and linear space. In order to compute the polygonal approximation  $\tilde{P}$  of  $P$ , it suffices to compute for each room  $r_i$  the set of vertices  $C_i^*$ . If  $C_i^* = \emptyset$ , then  $r_i$  is empty, otherwise we have the set of vertices we wanted. From  $C_i^*$  we can compute the points  $w_{i,k}$  and the linear polygon  $\tilde{P}$  in  $O(n)$  time and space.

The underlying idea is to split  $P$  into  $y$ -monotone piecewise-convex subpolygons. For each room  $r_i$  within each such  $y$ -monotone subpolygon we will then compute the corresponding set  $C_i^*$ . This will be done by first computing a subset  $S_i$  of the set  $R_i$  of the points inside the room  $r_i$ , such that  $S_i \supseteq C_i^*$ , and then applying an optimal time and space convex hull algorithm to the set  $S_i \cup \{v_i, v_{i+1}\}$  in order to compute  $C_i$ , and subsequently from that  $C_i^*$ . In the discussion that follows, we assume that for each convex arc  $a_i$  of  $P$  we associate a set  $S_i$ , which is initialized to be the empty set. The sets  $S_i$  will be progressively filled with vertices of  $P$ , so that in the end they fulfill the containment property mentioned above.

Splitting  $P$  into  $y$ -monotone piecewise-convex subpolygons is done in two steps:

1. First we split each convex arc  $a_i$  into  $y$ -monotone pieces. Let  $P'$  be the piecewise-convex polygon we get by introducing the  $y$ -extremal points for each  $a_i$ . Since each  $a_i$  can yield up to three  $y$ -monotone convex pieces, we conclude that  $|P'| \leq 3n$ . Obviously splitting the convex arcs  $a_i$  into  $y$ -monotone pieces takes  $O(n)$  time and space. A vertex added to split a convex arc into  $y$ -monotone pieces will be called an *added extremal vertex*.
2. Second, we apply to  $P'$  the standard algorithm for computing  $y$ -monotone subpolygons of a linear polygon (cf. [23] or [12]). The algorithm in [23] (or [12]) is valid not only for line segments, but also for piecewise-convex polygons consisting of  $y$ -monotone arcs (such as  $P'$ ). Since  $|P'| \leq 3n$ , we conclude that computing the  $y$ -monotone subpolygons of  $P'$  takes  $O(n \log n)$  time and requires  $O(n)$  space.

Note that a non-split arc of  $P$  belongs to exactly one  $y$ -monotone subpolygon.  $y$ -monotone pieces of a split arc of  $P$  may belong to at most three  $y$ -monotone subpolygons (see Fig. 8).

Suppose now that we have a  $y$ -monotone polygon  $Q$ . The edges of  $Q$  are either convex arcs of  $P$ , or pieces of convex arcs of  $P$ , or line segments between mutually visible vertices of  $P$ , added in order to form the  $y$ -monotone subpolygons of  $P$ ; we call these line segments *bridges* (see Fig. 8). For each non-bridge edge  $e_i$  of  $Q$ , we want to compute the set  $C_i^*$ . This is done by sweeping  $Q$  in the negative  $y$ -direction (i.e., by moving the sweep line from  $+\infty$  to  $-\infty$ ). The events of the sweep correspond to the  $y$  coordinates of the vertices of  $Q$ , which are all known before-hand and can be put in a decreasing sorted list. There are four different types of events:

1. the first event: corresponds to the top-most vertex of  $Q$ ,
2. the last event: corresponds to the bottom-most vertex of  $Q$ ,
3. a left event: corresponds to a vertex of the left  $y$ -monotone chain of  $Q$ , and

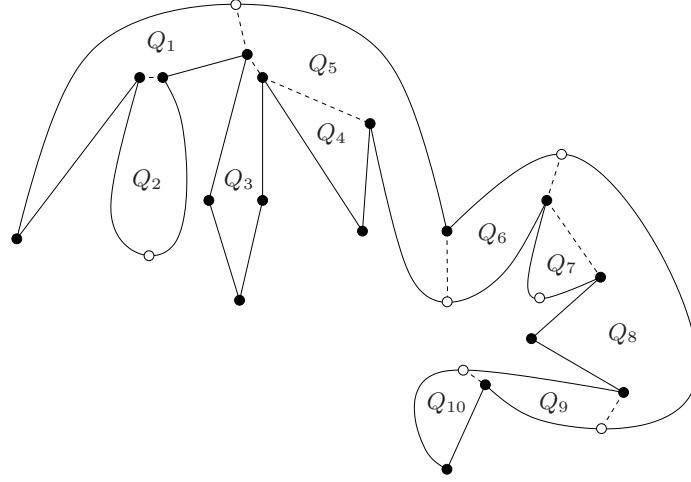

Figure 8: Decomposition of a piecewise-convex polygon into ten  $y$ -monotone subpolygons. The white points are added extremal vertices that have been added in order to split non- $y$ -monotone arcs to  $y$ -monotone pieces. The bridges are shown as dashed segments.

4. a right event: corresponds to a vertex of the right  $y$ -monotone chain of  $Q$ .

Our sweep algorithm proceeds as follows. Let  $\ell$  be the sweep line parallel to the  $x$ -axis at some  $y$ . For each  $y$  in between the  $y$ -maximal and  $y$ -minimal values of  $Q$ ,  $\ell$  intersects  $Q$  at two points which belong to either a left edge  $e_l$  or a left vertex  $v_l$  (i.e., an edge or vertex on the left  $y$ -monotone chain of  $Q$ ), and either a right edge  $e_r$  or a right vertex  $v_r$  (i.e., a edge or vertex on the right  $y$ -monotone chain of  $Q$ ). We associate the current left edge  $e_l$  at position  $y$  to a point set  $S_L$  and the current right edge at position  $y$  to a point set  $S_R$ . If the edge  $e_l$  (resp.  $e_r$ ) is a non-bridge edge, the set  $S_L$  (resp.  $S_R$ ) will contain vertices of  $Q$  that are inside the room of the convex arc of  $P$  corresponding  $e_l$  (resp.  $e_r$ ).

When the  $y$ -maximal vertex  $v_{max}$  is encountered, i.e., during the first event, we initialize  $S_L$  and  $S_R$  to be the empty set. When a left event is encountered due a vertex  $v_l$ , let  $e_{l,up}$  be the left edge above  $v_l$  and  $e_{l,down}$  be the left edge below  $v_l$  and let  $e_r$  be the current right edge. If  $e_{l,up}$  is a non-bridge edge, and  $a_i$  is the corresponding convex arc of  $P$ , we augment the set  $S_i$  by the vertices in  $S_L$ . Then, irrespectively of whether or not  $e_{l,up}$  is a bridge edge, we re-initialize  $S_L$  to be the empty set. Finally, if  $e_r$  is a non-bridge edge, and  $a_k$  is the corresponding convex arc in  $P$ , we check if  $v_l$  is inside the room  $r_k$  or lies in the interior of the chord of  $r_k$ ; if this is the case we add  $v_l$  to  $S_R$ . When a right event is encountered our sweep algorithm behaves symmetrically. When the last event is encountered due to the  $y$ -minimal vertex  $v_{min}$ , let  $e_l$  (resp.  $e_r$ ) be the left (resp. right) edge of  $Q$  above  $v_{min}$ . If  $e_l$  (resp.  $e_r$ ) is a non-bridge edge, let  $a_i$  (resp.  $a_j$ ) be the corresponding convex arc in  $P$ . In this case we simply augment  $S_i$  (resp.  $S_j$ ) by the vertices in  $S_L$  (resp.  $S_R$ ).

We claim that our sweep-line algorithm computes a set  $S_i$  such that  $S_i \supseteq C_i^*$ . To prove this we need the following intermediate result:

**Lemma 8** *Given a non-empty room  $r_i$  of  $P$ , with  $a_i$  the corresponding convex arc, the vertices of the set  $C_i^*$  belong to the  $y$ -monotone subpolygons of  $P'$  computed via the algorithm in [23] (or [12]), which either contain the entire arc  $a_i$  or  $y$ -monotone pieces of  $a_i$ .*

*Proof.* Let  $u$  be a vertex of  $P$  in  $C_i^*$  that is not a vertex of any of the  $y$ -monotone subpolygons of  $P'$  (computed by the algorithm in [23] or [12]) that contain either the entire arc  $a_i$  or  $y$ -monotone pieces of  $a_i$ . Let  $v_{max}$  (resp.  $v_{min}$ ) be the vertex of  $P$  of maximum (resp. minimum)  $y$ -coordinate in  $C_i$ ; ties are broken lexicographically. Let  $\ell_u$  be the line parallel to the  $x$ -axis passing through  $u$ . Consider the following cases:

1.  $u \in C_i^* \setminus \{v_{min}, v_{max}\}$ . Without loss of generality we can assume that  $u$  is a vertex in the right  $y$ -monotone chain of  $C_i$  (see Figs. 9(a) and 9(b)). Let  $u'$  be the intersection of  $\ell_u$  with  $a_i$ . Let  $Q$  (resp.  $Q'$ ) be the  $y$ -monotone subpolygon of  $P'$  that contains  $u$  (resp.  $u'$ ); by our assumption  $Q \neq Q'$ . Finally, let  $u_+$  (resp.  $u_-$ ) be the vertex of  $C_i$  above (resp. below)  $u$  in the right  $y$ -monotone chain of  $C_i$ .

The line segment  $uu'$  cannot intersect any edges of  $P$ , since this would contradict the fact that  $u \in C_i^*$ . Similarly,  $uu'$  cannot contain any vertices of  $P'$ : if  $v$  is a vertex of  $P$  in the interior of  $uu'$ ,  $u$  would be inside the triangle  $vu_+u_-$ , which contradicts the fact that  $u \in C_i^*$ , whereas if  $v$  is a vertex of  $P' \setminus P$  in the interior of  $uu'$ ,  $P$  would not be locally convex at  $v$ , a contradiction with the fact that  $P$  is a piecewise-convex polygon. As a result, and since  $Q \neq Q'$ , there exists a bridge edge  $e$  intersecting  $uu'$ . Let  $w_+, w_-$  be the two endpoints of  $e$  in  $P'$ , where  $w_+$  lies above the line  $\ell_u$  and  $w_-$  lies below the line  $\ell_u$ . In fact neither  $w_+$  nor  $w_-$  can be a vertex in  $P' \setminus P$ , since the algorithm in [23] (or [12]) will connect a vertex in  $P' \setminus P$  inside a room  $r_k$  with either the  $y$ -maximal or the  $y$ -minimal vertex of  $C_k$  only. Let  $\ell_+$  (resp.  $\ell_-$ ) be the line passing through the vertices  $u$  and  $u_+$  (resp.  $u$  and  $u_-$ ). Finally, let  $s$  be the sector delimited by the lines  $\ell_+, \ell_-$  and  $a_i$ . Now, if  $w_+$  or  $w_-$  lies inside  $s$ , then  $u$  will be inside the triangle  $w_+u_+u_-$  or inside the triangle  $w_-u_+u_-$ , respectively (see Fig. 9(a)). In either case we get a contradiction with the fact that  $u \in C_i^*$ . If neither  $w_+$  nor  $w_-$  lie inside  $s$ , then both  $w_+$  and  $w_-$  have to be vertices inside  $r_i$ , and moreover  $u$  will lie inside the convex quadrilateral  $w_+u_+u_-w_-$ ; again this contradicts the fact that  $u \in C_i^*$  (see Fig. 9(b)).

2.  $u \equiv v_{max}$ . By the maximality of the  $y$ -coordinate of  $u$  in  $C_i$ , we have that the  $y$ -coordinate of  $u$  is larger than or equal to the  $y$ -coordinates of both  $v_i$  and  $v_{i+1}$ . Therefore, the line  $\ell_u$  intersects the arc  $a_i$  exactly twice, and, moreover,  $a_i$  has a  $y$ -maximal vertex of  $P' \setminus P$  in its interior, which we denote by  $v'_{max}$  (see Fig. 9(c)). Let  $u'$  be the intersection of  $\ell_u$  with  $a_i$  that lies to the right of  $u$ , and let  $Q$  (resp.  $Q'$ ) be the  $y$ -monotone subpolygon of  $P'$  that contains  $u$  (resp.  $u'$ ). By assumption  $Q \neq Q'$ , which implies that there exists a bridge edge  $e$  intersecting the line segment  $uu'$ . Notice, that, as in the case  $u \in C_i^* \setminus \{v_{min}, v_{max}\}$ , the line segment  $uu'$  cannot intersect any edges of  $P$ , or cannot contain any vertex  $v$  of  $P' \setminus P$ ; the former would contradict the fact that  $u \in C_i^*$ , whereas as the latter would contradict the fact that  $P$  is

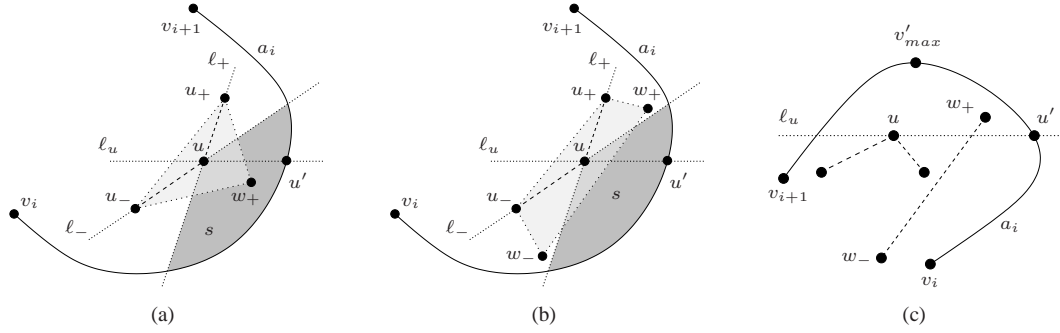

Figure 9: Proof of Lemma 8. (a) The case  $u \in C_i^* \setminus \{v_{min}, v_{max}\}$ , with  $w_+ \in s$ . (b) The case  $u \in C_i^* \setminus \{v_{min}, v_{max}\}$ , with  $w_+, w_- \notin s$ . (c) The case  $u \equiv v_{max}$ .

piecewise-convex. Furthermore,  $uu'$  cannot contain vertices of  $P$  since this would contradict the maximality of the  $y$ -coordinate of  $u$  in  $C_i$ .

Let  $w_+$  and  $w_-$  be the endpoints of  $e$  above and below  $\ell_u$ , respectively. Notice that  $e$  cannot have  $v'_{max}$  as endpoint, since the only bridge edge that has  $v'_{max}$  as endpoint is the bridge edge  $v'_{max}u$ . But then  $w_+$  must be a vertex of  $P$  lying inside  $r_i$ ; this contradicts the maximality of the  $y$ -coordinate of  $u$  among the vertices in  $C_i$ .

3.  $u \equiv v_{min}$ . This case is entirely symmetric to the case  $u \equiv v_{max}$ . □

An immediate corollary of the above lemma is the following:

**Corollary 9** For each convex arc  $a_i$  of  $P$ , the set  $S_i$  computed by the sweep algorithm described above is a superset of the set  $C_i^*$ .

Let us now analyze the time and space complexity of Step 1 of the algorithm sketched at the beginning of this subsection. Computing the polygonal approximation  $\tilde{P}$  of  $P$  requires subdividing  $P$  into  $y$ -monotone subpolygons. This subdivision takes  $O(n \log n)$  time and  $O(n)$  space. Then we need to compute the sets  $S_i$  for each convex arc  $a_i$  of  $P$ . The sets  $S_i$  can be implemented as red-black trees. During the course of our algorithm we only perform insertions on the  $S_i$ 's. A vertex  $v$  of  $P$  is inserted at most  $\deg(v)$  times in some  $S_i$ , where  $\deg(v)$  is the degree of  $v$  in the  $y$ -monotone decomposition of  $P$ . Since the sum of the degrees of the vertices of  $P$  in the  $y$ -monotone decomposition of  $P$  is  $O(n)$ , we conclude that the total size of the  $S_i$ 's is  $O(n)$  and that we perform  $O(n)$  insertions on the  $S_i$ 's. Therefore we need  $O(n \log n)$  time and  $O(n)$  space to compute the  $S_i$ 's and the  $C_i^*$ 's. The analysis above thus yields the following:

**Theorem 10** Let  $P$  be a piecewise-convex polygon with  $n \geq 2$  vertices. We can compute a guard set for  $P$  of size at most  $\lfloor \frac{2n}{3} \rfloor$  in  $O(n \log n)$  time and  $O(n)$  space.

### 3.5 Lower bound constructions

In this subsection we are going to present a piecewise-convex polygon that requires a minimum of  $\lfloor \frac{4n}{7} \rfloor - 1$  vertex (resp.  $\lfloor \frac{n}{2} \rfloor$  point) guards in order to be monitored.

Let us first consider the windmill-like piecewise-convex polygon  $W$  with seven vertices of Fig. 10(a), a detail of which is shown in Fig. 10(b). The *double ear* defined by the vertices  $v_3, v_4$  and  $v_5$  and the convex arcs  $a_3$  and  $a_4$  is constructed in such a way so that neither  $v_3$  nor  $v_5$  can monitor both rooms  $r_3$  and  $r_4$  by itself. This is achieved by ensuring that  $a_3$  (resp.  $a_4$ ) intersects the line  $v_4v_5$  (resp.  $v_3v_4$ ) twice. Note that both  $a_3$  and  $a_4$  intersect the line  $mv_4$  only at  $v_4$ , where  $m$  is the midpoint of the line segment  $v_3v_5$ . The double ear defined by the vertices  $v_5, v_6$  and  $v_7$  and the convex arcs  $a_5$  and  $a_6$  is constructed in an analogous way. Moreover, the vertices  $v_1, v_2, v_4$  and  $v_6$  are placed in such a way so that they do not (collectively) monitor the interior of the triangle  $v_3v_5v_7$  (for example the lengths of the edges  $v_1v_7$  and  $v_2v_3$  are considered to be big enough, so that  $v_2$  does not see too much of the triangle  $v_3v_5v_7$ ). As a result of this construction, the windmill-like piecewise-convex polygon  $W$  cannot be monitored by two vertex guards, but can be monitored with three. There are actually only five possible guard triplets:  $\{v_3, v_4, v_6\}$ ,  $\{v_3, v_5, v_6\}$ ,  $\{v_3, v_5, v_7\}$ ,  $\{v_4, v_5, v_7\}$  and  $\{v_4, v_6, v_7\}$ . Any guard set that contains either  $v_1$  or  $v_2$  has cardinality at least four. The vertices  $v_1$  and  $v_2$  will be referred to as *base vertices*.

Consider now the crescent-like polygon  $C$  with  $n$  vertices of Fig. 11. The vertices of  $C$  are in strictly convex position. This fact has the following implication: if  $v_i, v_{i+1}, v_{i+2}$  and  $v_{i+3}$  are four consecutive vertices of  $C$ , and  $u$  is the point of intersection of the lines  $v_iv_{i+1}$  and  $v_{i+2}v_{i+3}$ , then the triangle  $v_{i+1}uv_{i+2}$  is monitored if and only if either  $v_{i+1}$  or  $v_{i+2}$  is in the guard set of  $C$ . As

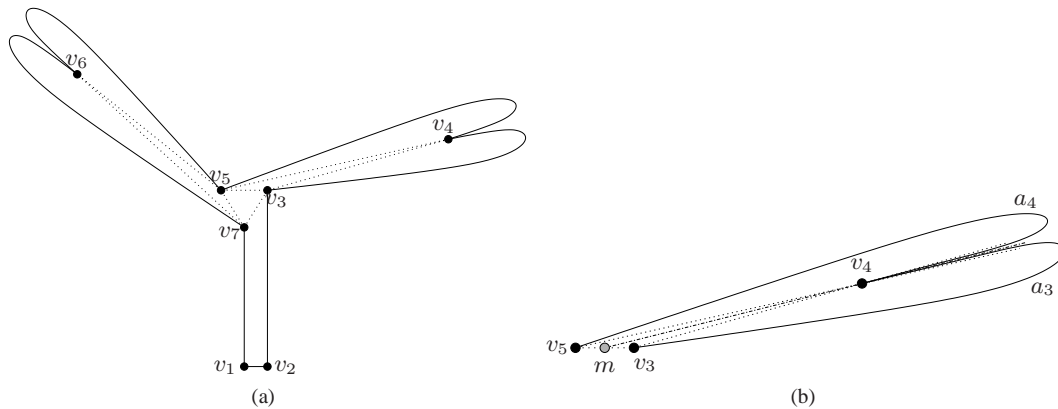

Figure 10: The windmill-like piecewise-convex polygon  $W$  that requires at least three vertex guards in order to be monitored. The only triplets of guards that monitor  $W$  are  $\{v_3, v_4, v_6\}$ ,  $\{v_3, v_5, v_6\}$ ,  $\{v_3, v_5, v_7\}$ ,  $\{v_4, v_5, v_7\}$  and  $\{v_4, v_6, v_7\}$ .

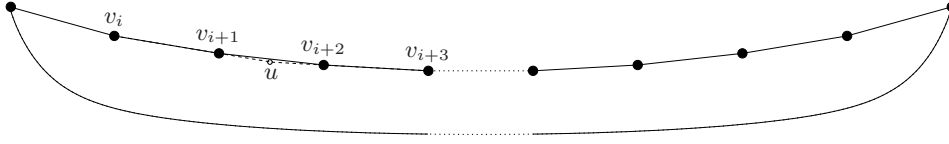

Figure 11: The crescent-like piecewise-convex polygon  $C$ , that requires a guard set of at least  $\lfloor \frac{n}{2} \rfloor$  vertex guards.

a result, it is easy to see that  $C$  cannot be monitored with less than  $\lfloor \frac{n}{2} \rfloor$  vertices, since in this case there will be at least one edge both endpoints of which would not be in the guard set for  $C$ .

In order to construct the piecewise-convex polygon that gives us the lower bound mentioned at the beginning of this subsection, we are going to merge several copies of  $W$  with  $C$ . More precisely, consider the piecewise-convex polygon  $P$  of Fig. 12 with  $n = 7k$  vertices. It consists of copies of the polygon  $W$  merged with  $C$  at every other linear edge of  $C$ , through the base points of the  $W$ 's.

In order to monitor any of the windmill-like subpolygons, we need at least three vertices per such polygon, none which can be a base point. This gives a total of  $3k$  vertices. On the other hand, in order to monitor the crescent-like part of  $P$  we need at least  $k - 1$  guards among the base points. To see that, notice that there are  $k - 1$  linear segments connecting base points; if we were to use less than  $k - 1$  guards, we would have at least one such line segment  $e$ , both endpoints of which would not participate in the guard set of  $G$ . But then, as in the case of  $C$ , there would be a triangle, adjacent to  $e$ , which would not be monitored. Therefore, in order to monitor  $P$  we need a minimum of  $4k - 1 = \lfloor \frac{4n}{7} \rfloor - 1$  vertex guards.

The lower bound for point guards can be established much more easily. Consider the comb-like piecewise-convex polygon  $C$  shown in Fig. 13. It can be readily seen that we need one point guard per prong of  $C$ ; since  $C$  contains  $\lfloor \frac{n}{2} \rfloor$  prongs, we conclude that a minimum of  $\lfloor \frac{n}{2} \rfloor$  point guards are required in order to monitor  $P$ . We, thus, arrive at the following theorem.

**Theorem 11** *There exists family of piecewise-convex polygons with  $n$  vertices any vertex (resp. point) guard set of which has cardinality at least  $\lfloor \frac{4n}{7} \rfloor - 1$  (resp.  $\lfloor \frac{n}{2} \rfloor$ ).*

## 4 Piecewise-concave polygons

In this section we deal with the problem of monitoring piecewise-concave polygons using point guards. Monitoring a piecewise-concave polygon with vertex guards may be impossible even for very simple configurations (see Fig. 15(a)). In particular we prove the following:

**Theorem 12** *Let  $P$  be a piecewise-concave polygon with  $n$  vertices.  $2n - 4$  point guards are always sufficient and sometimes necessary in order to monitor  $P$ .*

*Proof.* To prove the sufficiency of  $2n - 4$  point guards we essentially apply the technique in [17] for illuminating disjoint compact convex sets — please refer to Fig. 14. We denote by  $A_i$  the

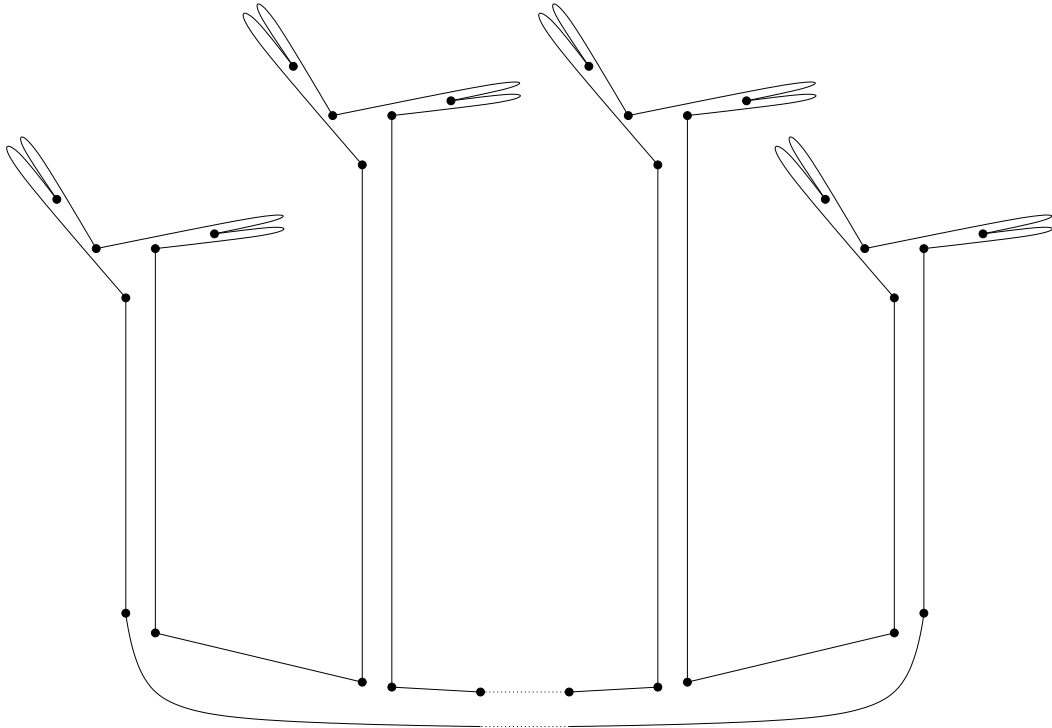
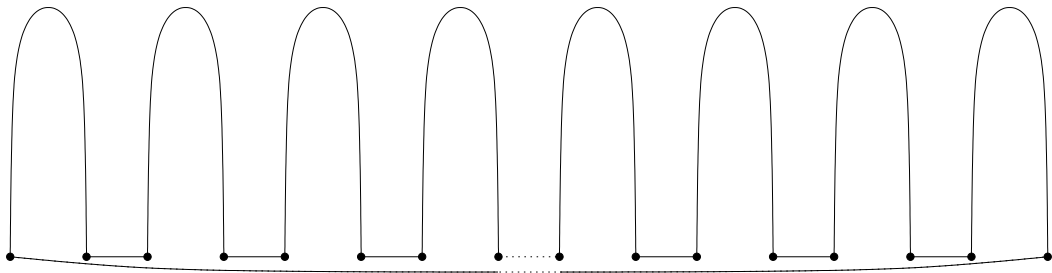

Figure 12: The lower bound construction.

Figure 13: A comb-like piecewise-convex polygon that requires  $\lfloor \frac{n}{2} \rfloor$  point guards in order to be monitored: one point guard is required per prong.

convex object delimited by  $a_i$  and the chord  $v_i v_{i+1}$  of  $a_i$ . Let  $t_i(v_j)$  be the tangent line to  $a_i$  at  $v_j$ ,

$j = i, i + 1$ , and let  $b_{i+1}$  be the bisecting ray of  $t_i(v_{i+1}), t_{i+1}(v_{i+1})$  pointing towards the interior of  $P$ .

Construct a set of locally convex arcs  $\mathcal{K} = \{\kappa_1, \kappa_2, \dots, \kappa_n\}$  that lie entirely inside  $P$  as such that (cf. [17]):

- (a) the endpoints of  $\kappa_i$  are  $v_i, v_{i+1}$ ,
- (b)  $\kappa_i$  is tangent to  $b_i$  (resp.  $b_{i+1}$ ) at  $v_i$  (resp.  $v_{i+1}$ ),
- (c) if  $S_i$  is the locally convex object defined by  $\kappa_i$  and its chord  $v_i v_{i+1}$ , then  $A_i \subseteq S_i, 1 \leq i \leq n$ ,
- (d) the arcs  $\kappa_i$  are pairwise non-crossing, and
- (e) the number of tangencies between the elements of  $\mathcal{K}$  is maximized.

Let  $Q$  be the piecewise-concave polygon defined by the sequence of the arcs in  $\mathcal{K}$ .

Suppose now that  $\kappa_i$  and  $\kappa_{\sigma(j)}$  are tangent,  $1 \leq j \leq m$ , and let  $\ell_{i,\sigma(j)}$  be the common tangent to  $\kappa_i$  and  $\kappa_{\sigma(j)}$ . Let  $s_{i,\sigma(j)}$  be the line segment on  $\ell_{i,\sigma(j)}$  between the points of intersection of  $\ell_{i,\sigma(j)}$  with  $\ell_{i,\sigma(j-1)}$  and  $\ell_{i,\sigma(j+1)}$ . Let  $\Pi_i$  be the polygonal region defined by the chord  $v_i v_{i+1}$  and the line segments  $s_{i,\sigma(j)}$ .  $\Pi_i$  is a linear polygon with at most two reflex vertices (at  $v_i$  and/or  $v_{i+1}$ ). It is easy to see that placing guards on the vertices of the  $\Pi_i$ 's monitors both  $P$  and  $Q$ . Let  $G_Q$  be the guard set of  $P$  constructed this way. Construct, now, a planar graph  $\Gamma$  with vertex set  $\mathcal{K}$ . Two vertices  $\kappa_i$  and  $\kappa_j$  of  $\Gamma$  are connected via an edge if  $\kappa_i$  and  $\kappa_j$  are tangent. The graph  $\Gamma$  is a planar graph combinatorially equivalent to the triangulation graph  $\mathcal{T}(R)$  of a polygon  $R$  with  $n$  vertices. The edges of  $\Gamma$  connecting the arcs  $\kappa_i, \kappa_{i+1}, 1 \leq i \leq n$ , are the boundary edges of  $R$ , whereas all other edges of  $\Gamma$  correspond to diagonals in  $\mathcal{T}(R)$ . Let  $Q^\circ$  denote the interior of  $Q$ . Observing that  $Q^\circ$  consists of a number of faces that are in 1–1 correspondence with the triangles in  $\mathcal{T}(R)$ , we conclude that  $Q^\circ$  consists of  $n - 2$  faces, each containing three guards of  $G_Q$ . In fact, each face of  $Q^\circ$  can actually be monitored by only two of the three guards it contains and thus we can eliminate one of them per face of  $Q^\circ$ . The new guard set  $G$  of  $Q$  constructed above is also a guard set for  $P$  and contains  $2(n - 2)$  point guards.

To prove the necessity, refer to the piecewise-concave polygon  $P$  in Fig. 15(b). Each one of the pseudo-triangular regions in the interior of  $P$  requires exactly two point guards in order to be monitored. Consider for example the pseudo-triangle  $\tau$  shown in gray in Fig. 15(b). We need one point along each one of the lines  $l_1, l_2$  and  $l_3$  in order to monitor the regions near the corners of  $\tau$ , which implies that we need at least two points in order to monitor  $\tau$  (two out of the three points of intersection of the lines  $l_1, l_2$  and  $l_3$ ). The number of such pseudo-triangular regions is exactly  $n - 2$ , thus we need a total of  $2n - 4$  point guards to monitor  $P$ .  $\square$

## 5 Discussion and open problems

In this paper we have considered the problem of monitoring a polygonal art gallery, the walls of which are allowed to be arcs of curves. In the case of piecewise-convex polygons with  $n$  vertices, it is always possible to monitor the polygon with  $\lfloor \frac{2n}{3} \rfloor$  vertex guards, whereas  $\lfloor \frac{4n}{7} \rfloor - 1$  vertex



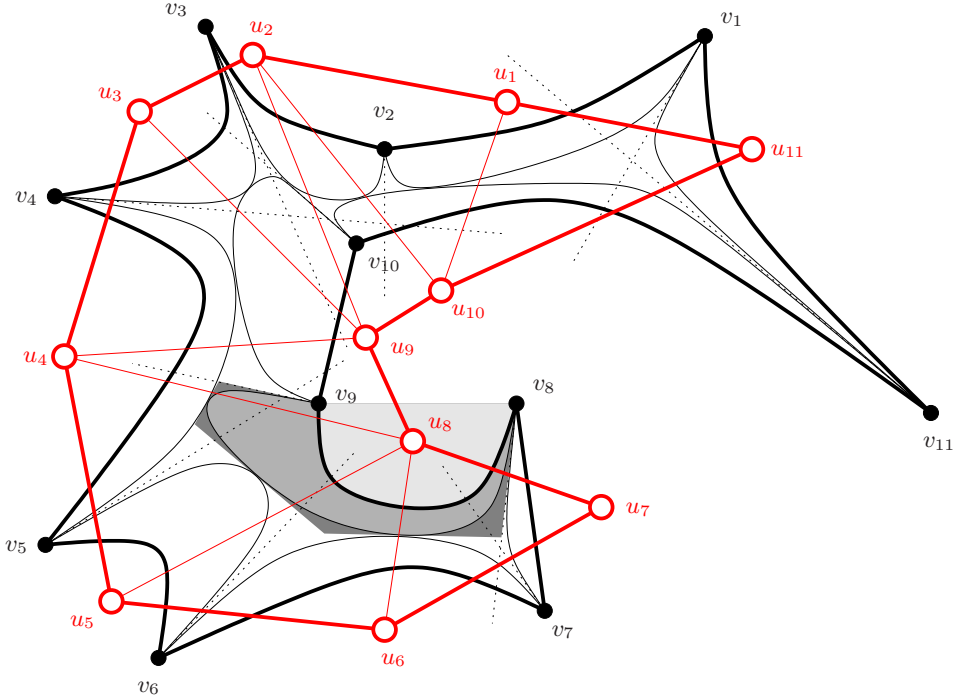

Figure 14: The proof for the upper bound of Theorem 12. The polygon  $P$  is shown with thick solid curvilinear arcs. The arcs  $\kappa_i$  are shown as thin solid arcs. The dotted rays are the bisecting rays  $b_i$ , whereas the dashed ray is the ray  $r_8(v_9)$ . The regions  $A_8$ ,  $S_8 \setminus A_8$  and  $\Pi_8 \setminus S_8$  are also shown using three levels of gray; note that  $\Pi_8$  has one reflex vertex at  $v_9$ . The graph  $\Gamma$  (i.e., the triangulation graph  $\mathcal{T}(R)$ ) is shown in red: the node  $u_i$  corresponds to the arc  $a_i$  and the polygon  $R$  is depicted via thick segments.

guards are sometimes necessary. Furthermore, we have described an  $O(n \log n)$  time and  $O(n)$  space algorithm for computing a vertex guard set of size at most  $\lfloor \frac{2n}{3} \rfloor$ . For piecewise-concave polygons with  $n$  vertices we have shown that  $2n - 4$  point guards are always sufficient and sometimes necessary.

Up to now we have not found a piecewise-convex polygon that requires more than  $\lfloor \frac{4n}{7} \rfloor + O(1)$  vertex (resp.  $\lfloor \frac{n}{2} \rfloor$  point) guards, nor have we devised a polynomial time algorithm for monitoring a piecewise-convex polygon with less than  $\lfloor \frac{2n}{3} \rfloor$  vertex guards. Closing the gap between the upper and lower bounds, for both vertex and point guards, remains an open problem. The worst-case upper and lower bound on the size of guard sets that we have shown for piecewise-concave polygons is of existential nature. Transforming the proof into an algorithm remains elusive. It is possible, however, to compute, in  $O(n \log \log n)$  time and linear space, a linear-size point guard set by decomposing

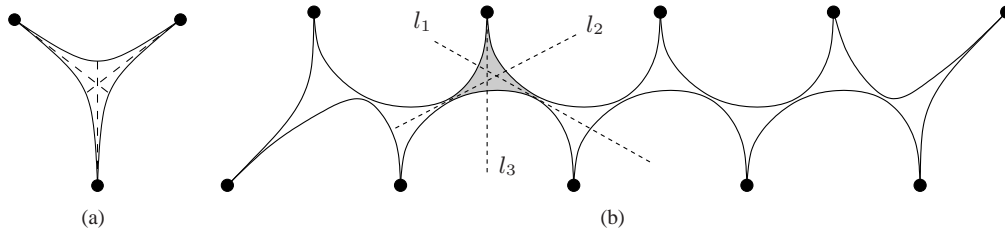

Figure 15: (a) A piecewise-concave polygon  $P$  that cannot be monitored solely by vertex guards. Two consecutive edges of  $P$  have a common tangent at the common vertex and as a result the three vertices of  $P$  see only the points along the dashed segments. (b) A piecewise-concave polygon  $P$  that requires  $2n - 4$  point guards in order to be monitored.

the piecewise-concave polygon into a linear number of trapezoids (cf. [13]) and then monitor each trapezoid with a constant number of guards. This construction, however, can yield a guard set of size larger than  $2n - 4$ .

Beyond the two classes of polygons considered in this paper, it is straightforward to prove the following results (the details can be found in the relevant technical report [20]):

1. Given a *monotone* piecewise-convex polygon  $P$  with  $n$  vertices (i.e., a piecewise-convex polygon  $P$  for which there exists a line  $L$  such that any line  $L^\perp$  perpendicular to  $L$  intersects the boundary of  $P$  at most twice),  $\lfloor \frac{n}{2} \rfloor + 1$  vertex (resp.  $\lfloor \frac{n}{2} \rfloor$  point) guards are always sufficient and sometimes necessary in order to monitor  $P$ .
2. Given a locally convex polygon  $P$  with  $n$  vertices,  $n$  point guards are always sufficient and sometimes necessary in order to monitor  $P$ . In particular, the  $n$  vertices of  $P$  are a guard set for  $P$ .
3. Given a *monotone* locally convex polygon (defined in direct analogy to monotone piecewise-convex polygons),  $\lfloor \frac{n}{2} \rfloor + 1$  vertex or point guards are always sufficient and sometimes necessary.
4. Finally, there exist *general polygons* that cannot be monitored with a finite number of point guards.

Other types of guarding problems have been studied in the literature, which either differ on the type of guards (e.g., edge or mobile guards), the topology of the polygons considered (e.g., polygons with holes) or the guarding model (e.g., the fortress problem or the prison yard problem, mentioned in Section 1); see the book by O'Rourke [29], the survey paper by Shermer [31] of the book chapter by Urrutia [34] for an extensive list of the variations of the art gallery problem with respect to the types of guards or the guarding model. It would be interesting to extend these results to the families of curvilinear polygons presented in this paper.

## Acknowledgements

The authors wish to thank Ioannis Z. Emiris and Hazel Everett for useful discussions about the problem. Work partially supported by the IST Programme of the EU (FET Open) Project under Contract No IST-006413 – (ACS - Algorithms for Complex Shapes with Certified Numerics and Topology).

## References

- [1] A. Aggarwal. *The art gallery problem: Its variations, applications, and algorithmic aspects*. PhD thesis, Dept. of Comput. Sci., Johns Hopkins University, Baltimore, MD, 1984.
- [2] D. Avis and H. ElGindy. A combinatorial approach to polygon similarity. *IEEE Trans. Inform. Theory*, IT-2:148–150, 1983.
- [3] J.-D. Boissonnat and M. Teillaud, editors. *Effective Computational Geometry for Curves and Surfaces*. Mathematics and Visualization. Springer, 2007.
- [4] W. Bronsvoort. Boundary evaluation and direct display of CSG models. *Computer-Aided Design*, 20:416–419, 1988.
- [5] B. Chazelle. Triangulating a simple polygon in linear time. In *Proc. 31st Annu. IEEE Sympos. Found. Comput. Sci.*, pages 220–230, 1990.
- [6] B. Chazelle. Triangulating a simple polygon in linear time. *Discrete Comput. Geom.*, 6(5):485–524, 1991.
- [7] B. Chazelle and J. Incerpi. Triangulation and shape-complexity. *ACM Trans. Graph.*, 3(2):135–152, 1984.
- [8] V. Chvátal. A combinatorial theorem in plane geometry. *J. Combin. Theory Ser. B*, 18:39–41, 1975.
- [9] C. Coullard, B. Gamble, W. Lenhart, W. Pulleyblank, and G. Toussaint. On illuminating a set of disks. Manuscript, 1989.
- [10] J. Czyzowicz, B. Gaujal, E. Rivera-Campo, J. Urrutia, and J. Zaks. Illuminating higher-dimensionall convex sets. *Geometriae Dedicata*, 56:115–120, 1995.
- [11] J. Czyzowicz, E. Rivera-Campo, J. Urrutia, and J. Zaks. Protecting convex sets. *Graphs and Combinatorics*, 19:311–312, 1994.
- [12] M. de Berg, M. van Kreveld, M. Overmars, and O. Schwarzkopf. *Computational Geometry: Algorithms and Applications*. Springer-Verlag, Berlin, Germany, 2nd edition, 2000.
- [13] D. P. Dobkin and D. L. Souvaine. Computational geometry in a curved world. *Algorithmica*, 5:421–457, 1990.

- 
- [14] H. Edelsbrunner, J. O'Rourke, and E. Welzl. Stationing guards in rectilinear art galleries. *Comput. Vision Graph. Image Process.*, 27:167–176, 1984.
- [15] K. Eo and C. Kyung. Hybrid shadow testing scheme for ray tracing. *Computer-Aided Design*, 21:38–48, 1989.
- [16] D. Eppstein, M. T. Goodrich, and N. Sitchinava. Guard placement for efficient point-in-polygon proofs. In *Proc. 23rd Annu. ACM Sympos. Comput. Geom.*, pages 27–36, 2007.
- [17] L. Fejes Tóth. Illumination of convex discs. *Acta Math. Acad. Sci. Hungar.*, 29(3–4):355–360, 1977.
- [18] S. Fisk. A short proof of Chvátal's watchman theorem. *J. Combin. Theory Ser. B*, 24:374, 1978.
- [19] J. Kahn, M. M. Klawe, and D. Kleitman. Traditional galleries require fewer watchmen. *SIAM J. Algebraic Discrete Methods*, 4:194–206, 1983.
- [20] M. I. Karavelas and E. P. Tsigaridas. Guarding curvilinear art galleries with vertex or point guards. Research Report 6132, INRIA, Feb 2007.
- [21] R. Kuc and M. Siegel. Efficient representation of reflecting structures for a sonar navigation model. In *Proc. 1987 IEEE Int. Conf. Robotics and Automation*, pages 1916–1923, 1987.
- [22] D. Lee and A. Lin. Computational complexity of art gallery problems. *IEEE Trans. Inform. Theory*, 32(2):276–282, 1986.
- [23] D. T. Lee and F. P. Preparata. Location of a point in a planar subdivision and its applications. *SIAM J. Comput.*, 6(3):594–606, 1977.
- [24] T. Lozano-Pérez and M. A. Wesley. An algorithm for planning collision-free paths among polyhedral obstacles. *Commun. ACM*, 22(10):560–570, 1979.
- [25] A. Lubiw. Decomposing polygonal regions into convex quadrilaterals. In *Proc. 1st Annu. ACM Sympos. Comput. Geom.*, pages 97–106, 1985.
- [26] M. McKenna. Worst-case optimal hidden-surface removal. *ACM Trans. Graph.*, 6:19–28, 1987.
- [27] G. Meisters. Polygons have ears. *Amer. Math. Monthly*, 82:648–651, 1975.
- [28] J. S. B. Mitchell. An algorithmic approach to some problems in terrain navigation. In D. Kapur and J. Mundy, editors, *Geometric Reasoning*. MIT Press, Cambridge, MA, 1989.
- [29] J. O'Rourke. *Art Gallery Theorems and Algorithms*. The International Series of Monographs on Computer Science. Oxford University Press, New York, NY, 1987.
- [30] J.-R. Sack. *Rectilinear computational geometry*. Ph.D. thesis, School Comput. Sci., Carleton Univ., Ottawa, ON, 1984. Report SCS-TR-54.

- [31] T. C. Shermer. Recent results in art galleries. *Proc. IEEE*, 80(9):1384–1399, Sept. 1992.
- [32] J. Stenstrom and C. Connolly. Building wire frames for multiple range views. In *Proc. 1986 IEEE Conf. Robotics and Automation*, pages 615–650, 1986.
- [33] G. T. Toussaint. Pattern recognition and geometrical complexity. In *Proc. 5th IEEE Internat. Conf. Pattern Recogn.*, pages 1324–1347, 1980.
- [34] J. Urrutia. Art gallery and illumination problems. In J.-R. Sack and J. Urrutia, editors, *Handbook of Computational Geometry*, pages 973–1027. North-Holland, 2000.
- [35] J. Urrutia and J. Zaks. Illuminating convex sets. Technical Report TR-89-31, Dept. Comput. Sci., Univ. Ottawa, Ottawa, ON, 1989.
- [36] S. Xie, T. Calvert, and B. Bhattacharya. Planning views for the incremental construction of body models. In *Proc. Int. Conf. Pattern Recongition*, pages 154–157, 1986.
- [37] M. Yachida. 3-D data acquisition by multiple views. In *Robotics Research: Third Int. Symp.*, pages 11–18, 1986.



---

Unité de recherche INRIA Lorraine  
LORIA, Technopôle de Nancy-Brabois - Campus scientifique  
615, rue du Jardin Botanique - BP 101 - 54602 Villers-lès-Nancy Cedex (France)

Unité de recherche INRIA Futurs : Parc Club Orsay Université - ZAC des Vignes  
4, rue Jacques Monod - 91893 ORSAY Cedex (France)

Unité de recherche INRIA Rennes : IRISA, Campus universitaire de Beaulieu - 35042 Rennes Cedex (France)

Unité de recherche INRIA Rhône-Alpes : 655, avenue de l'Europe - 38334 Montbonnot Saint-Ismier (France)

Unité de recherche INRIA Rocquencourt : Domaine de Voluceau - Rocquencourt - BP 105 - 78153 Le Chesnay Cedex (France)

Unité de recherche INRIA Sophia Antipolis : 2004, route des Lucioles - BP 93 - 06902 Sophia Antipolis Cedex (France)

---

Éditeur  
INRIA - Domaine de Voluceau - Rocquencourt, BP 105 - 78153 Le Chesnay Cedex (France)

<http://www.inria.fr>

ISSN 0249-6399