



HAL
open science

Some examples and counterexamples for $(\min,+)$ filtering operations

Anne Bouillard, Eric Thierry

► **To cite this version:**

Anne Bouillard, Eric Thierry. Some examples and counterexamples for $(\min,+)$ filtering operations.
[Research Report] RR-6095, INRIA. 2007, pp.14. inria-00123709v2

HAL Id: inria-00123709

<https://inria.hal.science/inria-00123709v2>

Submitted on 11 Jan 2007

HAL is a multi-disciplinary open access archive for the deposit and dissemination of scientific research documents, whether they are published or not. The documents may come from teaching and research institutions in France or abroad, or from public or private research centers.

L'archive ouverte pluridisciplinaire **HAL**, est destinée au dépôt et à la diffusion de documents scientifiques de niveau recherche, publiés ou non, émanant des établissements d'enseignement et de recherche français ou étrangers, des laboratoires publics ou privés.

*Some examples and counterexamples for $(\min, +)$
filtering operations*

Anne Bouillard and Éric Thierry

N° 6095

Janvier 2007

Thème COM



*Rapport
de recherche*

Some examples and counterexamples for $(\min, +)$ filtering operations

Anne Bouillard * and Éric Thierry †

Thème COM — Systèmes communicants
Projet Distribcom

Rapport de recherche n° 6095 — Janvier 2007 — 14 pages

Abstract: This paper collects a serie of examples and counterexamples encountered in the study of the algorithmics of Network Calculus operations.

Network Calculus is a deterministic queuing theory which aims at providing bounds on the performances of communication networks thanks to a nice formalization in $(\min, +)$ algebra. Often presented as a $(\min, +)$ filtering theory by analogy with the $(+, \times)$ filtering of traditional system theory, it makes use a well-defined set of operations.

Their algorithmic aspects have not been much addressed. For this reason, we describe and analyze in [2] a set of algorithms implementing these Network Calculus operations for a well-chosen class of functions. During this work, we had to construct some examples and counterexamples in order to draw the limits of our results or to illustrate them. Many of them have been omitted in [2], and are now presented in this companion-paper.

Key-words: Network Calculus, functional $(\min, +)$ algebra, computational complexity.

* Anne.Bouillard@bretagne.ens-cachan.fr

† Eric.Thierry@ens-lyon.fr

Exemples et contre-exemples pour les opérations des fonctions

$(\min, +)$

Résumé : Ce rapport rassemble une série d'exemples et de contre-exemples rencontrés dans l'étude de l'algorithmique des opérations du *Network Calculus*.

Le *Network Calculus* est une théorie développée pour calculer des bornes déterministes des performances des réseaux de communication, grâce à une formalisation dans l'algèbre $(\min, +)$. Mais les aspects algorithmiques de cette théorie n'ont pas encore été explorés. Nous décrivons et analysons dans [2] un ensemble d'algorithmes implémentant les opérations du *Network Calculus* pour une classe de fonctions bien choisie. Dans ce travail, nous avons construit un certain nombre d'exemples et de contre-exemples justifiant les limites de notre classe choisie. Beaucoup ont été omis dans [2] et c'est pourquoi nous les présentons maintenant.

Mots-clés : Network Calculus, algèbre des fonctions $(\min, +)$, complexité

1 Definitions and notation

Network Calculus is a theory of deterministic queuing systems encountered in communications networks and based on $(\min, +)$ algebra. It enables to analyze complex systems and to prove deterministic bounds on delays, backlogs and other Quality-of-Service (QoS) parameters. To get some introductory material about this theory, the reader is urged to look at the two reference books: Chang's book [3] and Le Boudec and Thiran's book [1].

In [2], we study the algorithmic aspects of the $(\min, +)$ functional operations used in Network Calculus. In particular, we provide algorithms for a class of input functions for which we prove stability (i.e. the output always belongs to the class). This section presents the operations and the classes of functions studied in [2]. Then Section 2 is a patchwork of remarks, examples and counterexamples about the mathematical properties of the Network Calculus operations for the considered classes of input functions.

1.1 The main operations

In the usual setting, Network Calculus functions take their values in the dioid $(\mathbb{R}_{\min}, \min, +)$, which is defined on $\mathbb{R}_{\min} = \mathbb{R} \cup \{+\infty\}$ and where the two basic operations are the usual minimum \min and addition $+$. These functions are also commonly supposed to be non-decreasing.

However, for sake of generality, we will allow functions which are not necessarily increasing and with values within $\overline{\mathbb{R}} = \mathbb{R} \cup \{-\infty, +\infty\}$.

Let $X = \mathbb{N}$ or \mathbb{R}_+ and f, g be two functions from X into $\overline{\mathbb{R}}$, the Network Calculus makes use of the following operations:

1. **Minimum:** $\forall t \in X, \min(f, g)(t) = \min(f(t), g(t))$. We will also use the infix notation \oplus : $f \oplus g = \min(f, g)$.
2. **Addition:** $\forall t \in X, (f + g)(t) = f(t) + g(t)$.
3. **Convolution:** $\forall t \in X, (f * g)(t) = \inf_{0 \leq s \leq t} (f(s) + g(t - s))$.
4. **Deconvolution:** $\forall t \in X, (f \oslash g)(t) = \sup_{u \geq 0} (f(t + u) - g(u))$.
5. **Subadditive closure:** $\forall t \in X, f^*(t) = \inf_{n \geq 0} f^{(n)}(t)$, where $f^{(n)}(t) = \underbrace{(f * \dots * f)}_{n \text{ times}}(t)$ for $n \geq 1$, and $f^{(0)}(t) = 0$

if $t = 0$ and $+\infty$ if $t > 0$.

Note that we can similarly define the **maximum** (\max) and the **subtraction** ($-$) of two functions.

Depending on whether $X = \mathbb{N}$ or $X = \mathbb{R}_+$, we will denote by \mathcal{D} the set of all functions from \mathbb{N} into $\overline{\mathbb{R}}$ (**discrete model**) and by \mathcal{F} the set of all functions from \mathbb{R}_+ into $\overline{\mathbb{R}}$ (**fluid model**). Let $f \in \mathcal{D}$ or \mathcal{F} , the subset $\text{Supp}(f) = \{t \in X \mid |f(t)| < +\infty\}$ is called the *support* of f .

The first comment on these operations is that the output function is always well-defined, unless some infinite values interfere. We actually consider that $(+\infty) + (-\infty)$, $(+\infty) - (+\infty)$ and $(-\infty) - (-\infty)$ are undefined values and any operation on two given functions whose definition involves such cases will lead to an undefined output. Checking whether a combination of functions and operations is undefined for some arguments is easy (from both mathematical and algorithmic points of view).

Let $f, g \in \mathcal{D}$ or \mathcal{F} , $\min(f, g)$ and $\max(f, g)$ are always defined, $f + g$ is undefined if $\exists t, f(t) = +\infty$ and $g(t) = -\infty$ (or the contrary), $f - g$ is undefined if $\exists t, f(t) = g(t) = +\infty$ (or $-\infty$), $f * g$ is undefined if $\exists t_1, t_2, f(t_1) = +\infty$ and $g(t_2) = -\infty$ (or the contrary), $f \oslash g$ is undefined if $\exists t_1 \leq t_2, f(t_2) = g(t_1) = +\infty$ (or $-\infty$), f^* is undefined if $\exists t_1, t_2, f(t_1) = +\infty$ and $f(t_2) = -\infty$.

Thus in the paper, each time we write formulas, we will assume that all conditions are fulfilled so that they are well-defined for *all* arguments.

When $f \in \mathcal{D}$ or \mathcal{F} , the subadditive closure can be equivalently defined as $f^*(0) = 0$ and for $t > 0$,

$$f^*(t) = \inf_{k \in \mathbb{N}, t_1, \dots, t_k \geq 0, t_1 + \dots + t_k = t} (f(t_1) + \dots + f(t_k)). \quad (1)$$

When $f \in \mathcal{D}$ and $f(0) \geq 0$, the subadditive closure also has an equivalent recursive definition: $f^*(0) = 0$ and for $t > 0$, $f^*(t) = \min[f(t), \min_{0 < s < t} (f^*(s) + f^*(t - s))]$ (see [3]).

Concerning the *deconvolution*, we should say *truncated deconvolution* since the usual definition gives a function $f \oslash g$ which is defined on \mathbb{Z} in the discrete model or \mathbb{R} in the fluid model, rather than \mathbb{N} or \mathbb{R}_+ . However in the context of Network Calculus where we will combine all these operations starting from functions in \mathcal{D} or \mathcal{F} , we can restrict ourselves to the definition on \mathbb{N} or \mathbb{R}_+ without loss of generality, as it can be seen from the definitions of the operations (where the arguments of functions are always non negative).

1.2 Classes of functions

Stability of classes. A class of functions is *closed* under some set of operations if combining members of the class with any of these operations outputs (if defined) a function which remains in the class. The *closure* of a class of functions under some set of operations is the smallest class containing these functions and closed under these operations.

Asymptotic behaviors.

Definition 1. Let f be a function from X into $\overline{\mathbb{R}}$ where $X = \mathbb{N}$ or \mathbb{R}_+ , then:

- f is affine if $\exists \sigma, \rho \in \mathbb{R}, \forall t \in X, f(t) = \rho t + \sigma$ or $\forall t \in X, f(t) = +\infty$ (resp. $-\infty$).
- f is ultimately affine if $\exists T \in X, \exists \sigma, \rho \in \mathbb{R}, \forall t > T, f(t) = \rho t + \sigma$ or $\forall t > T, f(t) = +\infty$ (resp. $-\infty$).
- f is pseudo-periodic if $\exists (c, d) \in \mathbb{R} \times X^*, \forall t \in X, f(t+d) = f(t) + c$.
- f is ultimately pseudo-periodic if $\exists T \in X, \exists (c, d) \in \mathbb{R} \times X^*, \forall t > T, f(t+d) = f(t) + c$.
- f is ultimately plain if $\exists T \in X, \forall t > T, f(t) \in \mathbb{R}$, or $\forall t > T, f(t) = +\infty$ or $\forall t > T, f(t) = -\infty$.
- f is plain if it is ultimately plain and $\forall 0 \leq t < T, f(t) \in \mathbb{R}$, and $f(T) \in \mathbb{R}$ or possibly $f(T) = +\infty$ (resp. $-\infty$) if $\forall t > T, f(t) = +\infty$ (resp. $-\infty$).

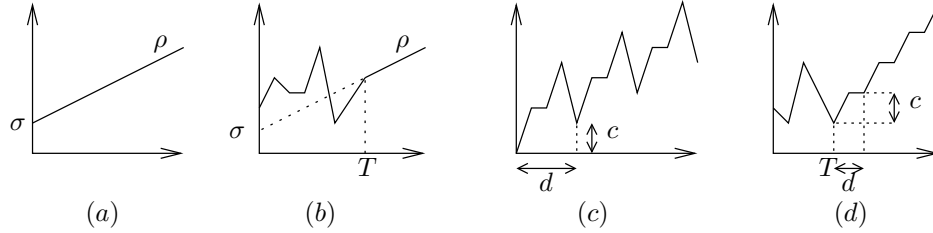

Figure 1: Classes of functions : (a) affine function; (b) ultimately affine function; (c) pseudo-periodic function; (d) ultimately pseudo-periodic function.

For affine and ultimately affine functions, ρ is the *growth rate*. For a pseudo-periodic function f , d is called a *period* of f , c is its associated *increment*, and the *period* of f is its smallest period (if different from 0). For an ultimately affine (resp. ultimately pseudo-periodic) function, we also say that it is ultimately affine (resp. ultimately pseudo-periodic) *from* T , and we say that T is a *rank* of the function. Given an ultimately pseudo-periodic function, there exists a smallest rank of pseudo-periodicity, called *the rank* of the function. More generally let $f, g \in \mathcal{F}$, we say that *ultimately* $f = g$ if $\exists T \in \mathbb{N}, \forall t > T, f(t) = g(t)$. An ultimately affine function is clearly ultimately plain and pseudo-periodic, and admits any $\epsilon > 0$ as a period. Note that being plain is equivalent to have a support equal to $[0, T]$ or $[0, T[$ where $T \in \mathbb{R} \cup \{+\infty\}$. A non-decreasing function is always ultimately plain, and if $f(0) \in \mathbb{R}$, it is plain.

Remark 1. We have chosen to define ultimately as $\exists T \in X, \forall t > T$, but we could also have put $\forall t \geq T$. Note that for all the properties we investigate, having ultimately the property for each of these definitions is equivalent, for the simple reason that if a function has the studied property when $t > T$, then for any $T' > T$, it also has the property when $t \geq T'$. Inversely if it has the property when $t \geq T$, then it also works when $t > T$. In fact, our choice was guided by the definition of rank as T satisfying the property. With the first definition and the properties we investigate, there always exists a smallest rank from which the property is true (the infimum of all ranks is still a rank). On the contrary, with the second definition, a smallest rank always exists in the discrete model or for continuous functions in the fluid model, but without continuity this is not necessarily the case (e.g. consider the ultimately affine function equal to 0 at $t = 0$ and to 1 elsewhere). The existence of a smallest rank is useful to define the compressed form of the ultimately pseudo-periodic functions. However note that in some proofs, e.g. the stability of ultimately affine functions under $*$, it will be sometimes more convenient to use the second definition with \geq (in the example of ultimately affine functions, it enables to get rid of a term in the asymptotic formula, note that one can also do the proof with $>$, it requires to keep this later term but the final result is exactly the same).

Piecewise affine functions.

Definition 2. We say that a function $f \in \mathcal{F}$ is piecewise affine if there exists an increasing sequence $(a_i)_{i \in \mathbb{N}}$ which tends to $+\infty$, such that $a_0 = 0$ and $\forall i \geq 0$, f is affine on $]a_i, a_{i+1}[$, i.e. $\forall t \in]a_i, a_{i+1}[$, $f(t) = +\infty$ or $\forall t \in]a_i, a_{i+1}[$, $f(t) = -\infty$ or $\exists \sigma_i, \rho_i \in \mathbb{R}$, $\forall t \in]a_i, a_{i+1}[$, $f(t) = \sigma_i + \rho_i t$. The (a_i) 's are called jump points.

Let $f \in \mathcal{F}$ a piecewise affine function and $a \in \mathbb{R}_+$, the right limit of f at a is defined as $f(a+) = \lim_{t \rightarrow a, t > a} f(t)$ and the left limit of f at a is defined as $f(a-) = \lim_{t \rightarrow a, t < a} f(t)$. Those limits exist.

Let $X \subseteq \mathbb{R}_+$ and $Y \subseteq \mathbb{R}$, we denote by $\mathcal{F}[X, Y]$ the set of all piecewise linear functions in \mathcal{F} such that there exists a sequence $(a_i)_{i \in \mathbb{N}}$ with the properties above and satisfying $\forall i \geq 0$, $a_i \in X$ and $f(a_i), f(a_i+), f(a_i-) \in Y \cup \{-\infty, +\infty\}$.

We will mainly consider $\mathcal{F}[\mathbb{N}, \mathbb{R}]$, $\mathcal{F}[\mathbb{Q}_+, \mathbb{R}]$, $\mathcal{F}[\mathbb{R}_+, \mathbb{R}]$ or $\mathcal{F}[\mathbb{Q}_+, \mathbb{Q}]$.

Note that a piecewise affine function up to $T + d$ which is ultimately pseudo-periodic of period d from T is clearly piecewise affine with regard to Definition 2.

2 Mathematical properties

2.1 Some algebraic properties

The distributivity between some operators can be easily checked from their definitions. The next proposition is not new, but we wish to emphasize that it applies to infinite families of functions. We will use it later.

Proposition 1 (Distributivity). Let $(f_i)_{i \in I}$ and $(g_j)_{j \in J}$ be two families of functions both in \mathcal{D} (or both in \mathcal{F}) where I and J are any sets (possibly infinite). Then, as long as the output functions are well defined,

$$\left(\sup_{i \in I} f_i\right) \circ \left(\inf_{j \in J} g_j\right) = \sup_{i \in I, j \in J} (f_i \circ g_j) \quad (2)$$

$$\left(\inf_{i \in I} f_i\right) * \left(\inf_{j \in J} g_j\right) = \inf_{i \in I, j \in J} (f_i * g_j) \quad (3)$$

The following proposition concerns the multiplication by a positive constant and is a simple consequence of the definitions of the operations (we do not refer to this property as linearity because in this work we may switch between $(+, \times)$ -linearity and $(\min, +)$ -linearity). Multiplying by a negative constant exchanges min and max (inf and sup) in the definitions. Here we abusively denote by $\alpha f(t)$ the function $t \mapsto \alpha f(t)$.

Proposition 2 (Multiplying by a constant). Multiplying functions by a fixed positive constant commutes with the Network Calculus operations. More precisely, let $f, g \in \mathcal{D}$ or \mathcal{F} , and $\alpha \in \mathbb{R}_+$. Then

- $\alpha f(t) + \alpha g(t) = \alpha(f + g)(t)$,
- $\alpha f(t) - \alpha g(t) = \alpha(f - g)(t)$,
- $\min(\alpha f(t), \alpha g(t)) = \alpha \min(f, g)(t)$,
- $\max(\alpha f(t), \alpha g(t)) = \alpha \max(f, g)(t)$,
- $(\alpha f(t)) * (\alpha g(t)) = \alpha(f * g)(t)$,
- $(\alpha f(t)) \circ (\alpha g(t)) = \alpha(f \circ g)(t)$,
- $(\alpha f(t))^* = \alpha f^*(t)$.

The next proposition shows that transforming functions by adding linear terms $t \mapsto \lambda t$ or constant terms $t \mapsto \mu$ does not complicate calculations, since the new outputs can be easily deduced from the former ones. Here we abusively denote by $f(t) + \lambda t + \mu$ the function $t \mapsto f(t) + \lambda t + \mu$.

Proposition 3 (Lifting). Let $f, g \in \mathcal{D}$ or \mathcal{F} , and $\lambda, \mu \in \mathbb{R}$. Then

- $(f(t) + \lambda t + \mu) + (g(t) + \lambda t + \mu) = (f + g)(t) + 2\lambda t + 2\mu$,
- $(f(t) + \lambda t + \mu) - (g(t) + \lambda t + \mu) = (f - g)(t)$,
- $\min((f(t) + \lambda t + \mu), (g(t) + \lambda t + \mu)) = \min(f, g)(t) + \lambda t + \mu$,

- $\max((f(t) + \lambda t + \mu), (g(t) + \lambda t + \mu)) = \max(f, g)(t) + \lambda t + \mu,$
- $(f(t) + \lambda t + \mu) * (g(t) + \lambda t + \mu) = (f * g)(t) + \lambda t + 2\mu,$
- $(f(t) + \lambda t + \mu) \odot (g(t) + \lambda t + \mu) = (f \odot g)(t) + \lambda t,$
- $(f(t) + \lambda t)^* = f^*(t) + \lambda t$ (adding μ may induce more complex changes).

The proof is also a direct consequence of the definitions of the operations. The transformation $f(t) \mapsto f(t) + \lambda t$ can be seen as a “lifting”, in particular it enables to transform any function $f \in \mathcal{D}$ or \mathcal{F} such that $\exists p \in \mathbb{R}_+, \forall t < t', f(t') - f(t) \geq -p \cdot (t' - t)$, into a non-decreasing function by choosing $\lambda = p$. As a consequence, it is not clear that it is possible to take advantage of monotony properties of input functions to design faster algorithms than the ones for the general case.

2.2 From discrete to fluid calculations: several issues

All the results of Subsection 2.3 in [2] show how to use fluid calculations to perform discrete ones by first interpolating the discrete input functions, then making fluid calculations and finally coming back to a discrete output function. We may wish to set a kind of reciprocal property, like in the next proposition. However it only applies to a very restricted set of operations ! Its proof is easy.

Proposition 4. *Let f, g be two continuous functions in $\mathcal{F}[\mathbb{N}, \mathbb{R}]$, whenever $\odot = +, -, *$, we have*

$$[[f]_{\mathbb{N}} \odot_{\mathbb{N}} [g]_{\mathbb{N}}]_{\mathbb{R}} = f \odot_{\mathbb{R}} g.$$

This proposition works neither for \min, \max (intersections may occurs at non-integer points) nor for \odot (see the next subsection where the piecewise affine shape is lost). Some issues also arise for the convolution, even if we consider non-decreasing functions f, g s.t. $f(0) = g(0) = 0$. The convolution $f * g$ of the functions depicted on Figure 2 (in bold), has a jump point at $t = T + \frac{(r_1 - r_2)T_1}{R - r_2}$ which is usually not an integer even if $T_1, T \in \mathbb{N}$ and $r_1, r_2, R \in \mathbb{Q}$.

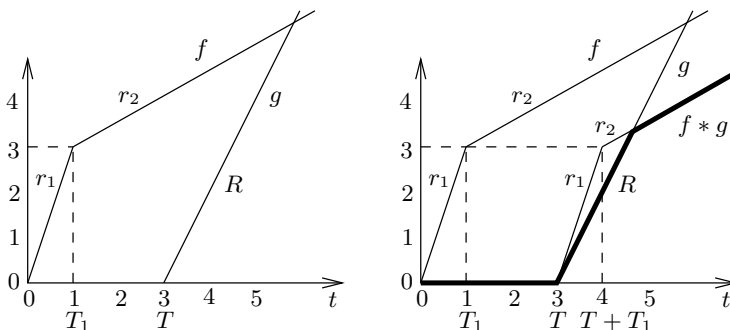

Figure 2: Growth rates satisfy $r_1 > R > r_2 > 0$.

The same kind of problem appears for the subadditive closure f^* of $f \in \mathcal{F}[\mathbb{N}, \mathbb{R}]$ continuous, even if the function is non-decreasing and $f(0) = 0$. On the example on Figure 3, the function f^* represented on the right (in bold) has a jump point at $t = 4.5$.

2.3 Unstability of piecewise affine functions

The next proposition implies that the class of piecewise affine functions is not stable for the deconvolution.

Proposition 5. *Let h be any convex C^1 function on $[0, 1]$. Then there exists $f, g \in \mathcal{F}[\mathbb{N}, \mathbb{R}]$ such that $h = f \odot g$ on $[0, 1]$.*

To exhibit such functions, we use the following lemmas.

Lemma 1. *Let ϕ be any application from \mathbb{N} into $[0, 1]$ s.t. $\phi(\mathbb{N})$ is dense within $[0, 1]$ (e.g. any surjection $\mathbb{N} \rightarrow \mathbb{Q} \cap [0, 1]$). Let p_x be the equation of the tangent to h at x (i.e. $p_x(t) = \sigma_x + \rho_x \cdot t = h'(x) \cdot (t - x) + h(x)$). Then $h = \sup_{n \in \mathbb{N}} p_{\phi(n)}$.*

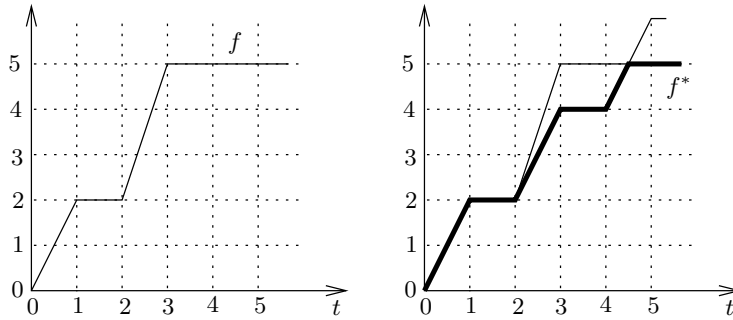

Figure 3: $f \in \mathcal{F}[\mathbb{N}, \mathbb{R}]$ is continuous and $f(0) = 0$, but $f^* \notin \mathcal{F}[\mathbb{N}, \mathbb{R}]$.

We do not develop the proof of this classical result which states that the envelope of a dense set of tangents matches the initial convex function.

Lemma 2. For all $n \geq 0$, consider the functions defined on \mathbb{R} by

$$f_n(t) = \begin{cases} p_{\phi(n)}(t - 2n) & \text{on } [2n, 2n + 1], \\ -\infty & \text{elsewhere.} \end{cases}$$

$$g_n(t) = \begin{cases} \alpha_n \cdot (t - 2n) & \text{on } [2n, 2n + 1], \\ +\infty & \text{elsewhere.} \end{cases}$$

where α_n is any constant at least $\rho_{\phi(n)} = h'(\phi(n))$,

Then

$$\forall i \in \mathbb{N}, f_i \circ g_i = p_{\phi(i)} \text{ on } [0, 1],$$

$$\forall i \neq j \in \mathbb{N}, f_i \circ g_j = -\infty \text{ on } [0, 1].$$

The results of this lemma are a direct application of Lemma 8 in [2] which describes the deconvolution of two segments.

Proof of Proposition 5. Given h , consider the functions f_n and g_n defined in Lemma 2, and aggregate these segments by taking $f = \sup_{i \in \mathbb{N}} f_i$ and $g = \inf_{j \in \mathbb{N}} g_j$.

The general distributivity stated in Proposition 1 with Lemma 1 and 2 implies that:

$$\begin{aligned} f \circ g &= \sup_{i,j} f_i \circ g_j \\ &= \sup_i f_i \circ g_i \quad \text{on } [0, 1] \\ &= \sup_i p_{\phi(i)} \quad \text{on } [0, 1] \\ &= h \quad \text{on } [0, 1]. \end{aligned}$$

■

The functions f and g may seem pathological and far from what is encountered in Network Calculus (they are non-increasing and their supports are $\cup_{n \in \mathbb{N}} [2n, 2n + 1]$). However this example may be easily adjusted in order to provide some regular properties to the functions.

Proposition 6. Let h be any convex C^1 function on $[0, 1]$ s.t. $h'(0) > 0$, thus strictly increasing. Then there exists increasing continuous functions $f, g \in \mathcal{F}[\mathbb{N}, \mathbb{R}]$ such that $h = f \circ g$ on $[0, 1]$.

Proof. The principle remains the same but special care is given to the connections between the segments on the intervals $[2n, 2n + 1]$.

We define f and g as continuous increasing functions such that for all $n \in \mathbb{N}$,

$$f = f_n \text{ on } [2n, 2n + 1], f = \tilde{f}_n \text{ on } [2n + 1, 2n + 2],$$

$$g = g_n \text{ on } [2n, 2n + 1], g = \tilde{g}_n \text{ on } [2n + 1, 2n + 2],$$

where f_n is a segment on $[2n, 2n + 1]$ equal to $-\infty$ elsewhere, \tilde{f}_n is a segment on $[2n + 1, 2n + 2]$ equal to $-\infty$ elsewhere, g_n is a segment on $[2n, 2n + 1]$ equal to $+\infty$ elsewhere, \tilde{g}_n is a segment on $[2n + 1, 2n + 2]$ equal

to $+\infty$ elsewhere. The functions f_n and g_n correspond the ones introduced in the proof of Proposition 5, the functions \tilde{f}_n and \tilde{g}_n are the adjustment functions chosen to ensure regular properties but without changing the deconvolution on $[0, 1]$.

We first define f_n and g_n on $[2n, 2n + 1]$ by:

$$\begin{aligned} f_n(t) &= h'(\phi(n)) \cdot (t - 2n) + f(2n) \\ g_n(t) &= h'(\phi(n)) \cdot (t - 2n) + g(2n). \end{aligned}$$

Thus f_n and g_n are parallel segments and we will set $f(2n)$ and $g(2n)$ such that $f(2n) - g(2n) = \sigma_{\phi(n)}$.

For the interval $[2n + 1, 2n + 2]$, we consider two cases: we know that $f(2n + 1) - g(2n + 1) = \sigma_{\phi(n)}$ (due to f_n and g_n parallel and $f(2n) - g(2n) = \sigma_{\phi(n)}$). Then if $\sigma_{\phi(n+1)} \geq \sigma_{\phi(n)}$,

$$\begin{aligned} \tilde{f}_n &= \text{segment such that } \begin{cases} \tilde{f}_n(2n + 1) = f_n(2n + 1) \\ \tilde{f}_n(2n + 2) = f_n(2n + 1) + \sigma_{\phi(n+1)} - \sigma_{\phi(n)} \end{cases} \quad \text{and} \\ \tilde{g}_n &= \text{segment such that } \tilde{g}_n(2n + 2) = \tilde{g}_n(2n + 1) = g_n(2n + 1). \end{aligned}$$

If $\sigma_{\phi(n+1)} < \sigma_{\phi(n)}$,

$$\begin{aligned} \tilde{f}_n &= \text{segment such that } \tilde{f}_n(2n + 2) = \tilde{f}_n(2n + 1) = f_n(2n + 1) \quad \text{and} \\ \tilde{g}_n &= \text{segment such that } \begin{cases} \tilde{g}_n(2n + 1) = g_n(2n + 1) \\ \tilde{g}_n(2n + 2) = g_n(2n + 1) + \sigma_{\phi(n)} - \sigma_{\phi(n+1)}. \end{cases} \end{aligned}$$

In both cases, we guarantee that $f(2n + 2) - g(2n + 2) = \tilde{f}_n(2n + 2) - \tilde{g}_n(2n + 2) = \sigma_{\phi(n+1)}$, and f, g are continuous and increasing.

The distributivity for the deconvolution implies that, on $[0, 1]$,

$$f \otimes g = \sup_i (f|_{[i, i+1]} \otimes g|_{[i, i+1]}) \vee \sup_i (f|_{[i+1, i+2]} \otimes g|_{[i, i+1]}).$$

This equation can be rewritten as, on $[0, 1]$,

$$f \otimes g = \sup_{n \in \mathbb{N}} (f_n \otimes g_n) \vee \sup_{n \in \mathbb{N}} (\tilde{f}_n \otimes \tilde{g}_n) \vee \sup_{n \in \mathbb{N}} (\tilde{f}_n \otimes g_n) \vee \sup_{n \in \mathbb{N}} (f_{n+1} \otimes \tilde{g}_n). \quad (4)$$

We choose ϕ such that the slopes of the adjustment segments of f and g on $\cup_{n \in \mathbb{N}} [2n + 1, 2n + 2]$ are \leq the slopes on $\cup_{n \in \mathbb{N}} [2n, 2n + 1]$.

The slopes on $\cup_{n \in \mathbb{N}} [2n, 2n + 1]$ are all $\geq h'(0)$. Now choose any $0 < \alpha \leq h'(0)$ (which is possible since $h'(0) > 0$). The application $x \mapsto \sigma_x = h(x) - xh'(x)$ is continuous on $[0, 1]$ which is compact, thus it is uniformly continuous and $\exists \epsilon > 0, \forall x, y \in [0, 1], |x - y| \leq \epsilon \implies |\sigma_x - \sigma_y| \leq \alpha$.

The slope of \tilde{f}_n or \tilde{g}_n is always 0 or $|\sigma_{\phi(n+1)} - \sigma_{\phi(n)}|$, thus it is sufficient to choose ϕ such that $\forall n \in \mathbb{N}, |\phi(n + 1) - \phi(n)| \leq \epsilon$. We must also have $\phi(\mathbb{N})$ dense within $[0, 1]$ to ensure $h = \sup_{n \in \mathbb{N}} p_{\phi(n)}$.

One way to fulfill both constraints on ϕ is to choose k such that $\frac{1}{2^k} \leq \epsilon$, and

$$\begin{aligned} \forall i, 0 \leq i < 2^k, \phi(i) &= \frac{i}{2^k} \\ \forall i, 0 \leq i < 2^{k+1}, \phi(i + 2^k) &= 1 - \frac{i}{2^{k+1}} \\ \forall i, 0 \leq i < 2^{k+2}, \phi(i + 2^k + 2^{k+1}) &= \frac{i}{2^{k+2}} \\ &\dots \end{aligned}$$

It goes forth and back on $[0, 1]$, refining the subdivision at each new pass.

Now we analyze the terms of Equation 4. We directly give the output on $[0, 1]$ of the deconvolution of the segments, by using Lemma 8 in [2]. Let $n \in \mathbb{N}$, the next equalities apply on $[0, 1]$.

- $f_n \otimes g_n = p_{\phi(n)}$

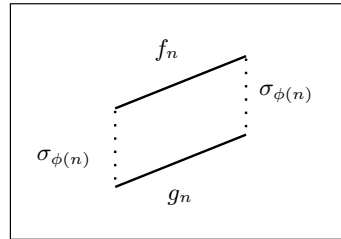

- $\tilde{f}_n \circledast \tilde{g}_n(t) = \text{constant}$
 $= \sigma_{\phi(n)}$ if $\sigma_{\phi(n)} > \sigma_{\phi(n+1)}$
 $\leq \sigma_{\phi(n)} + \rho_{\phi(n)}t$
 $\leq f_n \circledast g_n(t).$

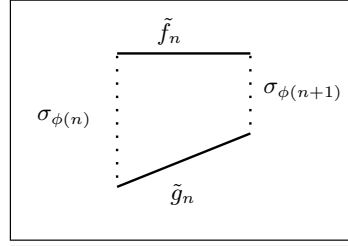

- $\tilde{f}_n \circledast \tilde{g}_n(t) = \text{constant}$
 $= \sigma_{\phi(n+1)}$ if $\sigma_{\phi(n)} \leq \sigma_{\phi(n+1)}$
 $\leq \sigma_{\phi(n+1)} + \rho_{\phi(n+1)}t$
 $\leq f_{n+1} \circledast g_{n+1}(t),$

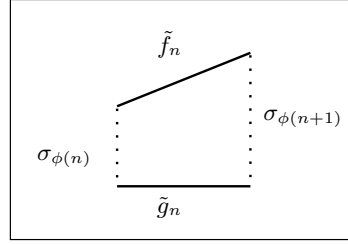

so $\tilde{f}_n \circledast \tilde{g}_n$ disappears in $f \circledast g$.

- $\tilde{f}_n \circledast g_n(t) = (\text{slope of } \tilde{f}_n) \times t + \text{value at } 0$
 $= (\text{slope of } \tilde{f}_n) \times t + \sigma_{\phi(n)}$
 $\leq \rho_{\phi(n)}t + \sigma_{\phi(n)}$
 $\leq f_n \circledast g_n(t).$

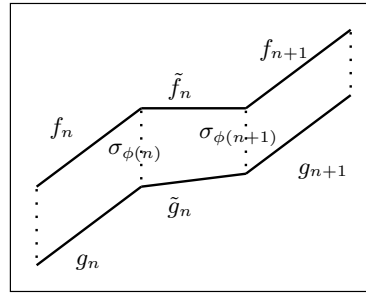

- $f_{n+1} \circledast \tilde{g}_n(t) = (\text{slope of } \tilde{g}_n) \times t + \text{value at } 0$
 $= (\text{slope of } \tilde{g}_n) \times t + \sigma_{\phi(n+1)}$
 $\leq \rho_{\phi(n+1)}t + \sigma_{\phi(n+1)}$
 $\leq f_{n+1} \circledast g_{n+1}(t),$

so these terms disappear in $f \circledast g$.

Finally, on $[0, 1]$, we have $f \circledast g = \sup_{n \in \mathbb{N}} f_n \circledast g_n = \sup_{n \in \mathbb{N}} p_{\phi(n)} = h$.

The next figure illustrates the schematic shape of f and g , note that the two curves may cross each other but since the increment of $\sigma_{\phi(n)}$ is always bounded by α , the distance between the two curves evolves in a regular way.

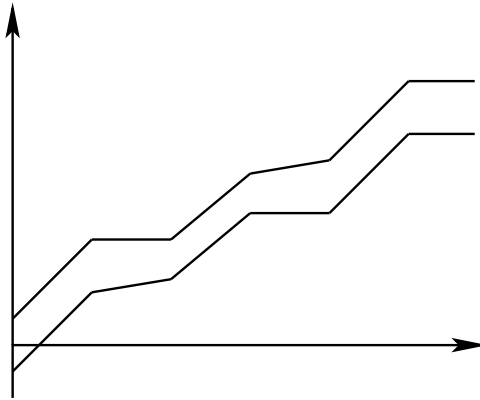

■

Remark 2.

- If h is a rational function (quotient of polynomials) with coefficients in \mathbb{Q} , then we can add that $f, g \in \mathcal{F}[\mathbb{N}, \mathbb{Q}]$.
- These constructions remain valid if the interval is $]0, 1[$ where h is C^1 and convex (e.g. $t \mapsto 1/(1-t)$). In order to construct the sweeping function ϕ , go forth and back on a sequence of closed intervals $[l_n, r_n]$

s.t. l_n (resp. r_n) is decreasing (resp. increasing) and tends to 0 (resp. 1), and where each interval $[l_n, r_n]$ leads to a step ϵ_n (instead of ϵ) of uniform continuity constraining the movement.

This result shows that, without ultimate pseudo-periodicity, one can not ensure that the deconvolution preserves piecewise affine shapes. For functions in $\mathcal{F}[\mathbb{R}_+, \mathbb{R}]$, even with pseudo-periodicity, other pathological phenomena may occur when the ratio between the periods of the two input functions is irrational. The next proposition provides such an example in case (i) where the output may not remain piecewise affine (and thus gives a new example for the unstability of $\mathcal{F}[\mathbb{R}_+, \mathbb{R}]$). Moreover an example of loss of the plain property is given in case (iii).

Let $S \subseteq \mathbb{R}_+$ (resp. \mathbb{N}), we denote by $\mathbb{1}_S$ the indicator function of S , i.e. $\forall t \in \mathbb{R}_+$ (resp. \mathbb{N}), $\mathbb{1}_S(t) = 1$ if $t \in S$ and $= 0$ otherwise. With this definition, note that $\mathbb{1}_S \in \mathcal{F}[\mathbb{R}_+, \mathbb{R}]$ if and only if S admits no finite accumulation point (a real which is the limit of a sequence of different values extracted from S). We also denote by $\text{dist}(t, S)$ the distance of t from S , i.e. $\inf\{|t - s|, s \in S\}$.

Let $\alpha, \beta \in \mathbb{R}_+^*$, we will use the notations $\mathbb{N}\alpha = \{s \in \mathbb{R} \mid \exists n \in \mathbb{N}, s = n\alpha\}$, $\mathbb{Z}\alpha = \{s \in \mathbb{R} \mid \exists n \in \mathbb{Z}, s = n\alpha\}$ and $\mathbb{N}\alpha - \mathbb{N}\beta = \{s \in \mathbb{R} \mid \exists p, q \in \mathbb{N}, s = p\alpha - q\beta\}$. It is known that if $\alpha/\beta \in \mathbb{Q}$, then $\mathbb{N}\alpha - \mathbb{N}\beta = \mathbb{Z}(\alpha \wedge \beta)$, and if $\alpha/\beta \notin \mathbb{Q}$, then $\mathbb{N}\alpha - \mathbb{N}\beta$ is dense within \mathbb{R} .

Proposition 7. *Let $\alpha, \beta \in \mathbb{R}_+^*$ (resp. $\alpha \in 2\mathbb{N}$, $\beta \in \mathbb{N}$) and $f, g \in \mathcal{F}$ (resp. \mathcal{D}), then:*

- (i) *Let $f = \mathbb{1}_{\mathbb{N}\alpha}$ and $g = 1 - \mathbb{1}_{\mathbb{N}\beta}$, then $f \circledast g = \mathbb{1}_{\mathbb{N}\alpha - \mathbb{N}\beta}$. If $\beta/\alpha \in \mathbb{Q}$, then $f \circledast g = \mathbb{1}_{\mathbb{Z}(\alpha \wedge \beta) \cap \mathbb{R}_+}$. If $\beta/\alpha \notin \mathbb{Q}$, then $f \circledast g \notin \mathcal{F}[\mathbb{R}_+, \mathbb{R}]$.*
- (ii) *Let $f(t) = \text{dist}(t, \mathbb{N}\alpha)$ and $g(t) = \text{dist}(t, \mathbb{N}\beta)$. If $\beta/\alpha \in \mathbb{Q}$, then $(f \circledast g)(t) = \frac{\alpha}{2} - \text{dist}(t, \mathbb{Z}(\alpha \wedge \beta)) + \frac{\alpha}{2}$. If $\beta/\alpha \notin \mathbb{Q}$, then $(f \circledast g)(t) = \frac{\alpha}{2}$.*
- (iii) *Let $f(t) = t \cdot \text{dist}(t, \mathbb{N}\alpha)$ and $g(t) = t \cdot \text{dist}(t, \mathbb{N}\beta)$. If $\beta/\alpha \in \mathbb{N}$, then $(f \circledast g)(t) = t \frac{\alpha}{2}$ if $t \in \mathbb{N}\alpha$ and $= +\infty$ if $t \notin \mathbb{N}\alpha$. If $\beta/\alpha \notin \mathbb{N}$, then $f \circledast g = +\infty$ over \mathbb{R}_+ .*

Proof.

- (i) From the definitions, it is clear that $\forall t \in \mathbb{R}_+$ (resp. \mathbb{N}), $(f \circledast g)(t) \in \{-1, 0, +1\}$. In fact $(f \circledast g)(t) = \sup_{s \geq 0} (f(t+s) - g(s)) \geq 0$ by choosing $s \in \mathbb{N}\beta$. Now $(f \circledast g)(t) = \sup_{s \geq 0} (f(t+s) - g(s)) = 1$ if and only if $\exists s \geq 0$, $f(t+s) = 1$ and $g(s) = 0$, i.e. $t+s \in \mathbb{N}\alpha$ and $s \in \mathbb{N}\beta$. This can occur if and only if $t \in \mathbb{N}\alpha - \mathbb{N}\beta$. Thus $f \circledast g = \mathbb{1}_{(\mathbb{N}\alpha - \mathbb{N}\beta) \cap \mathbb{R}_+}$. The end of the statement is the consequence of the form of $\mathbb{N}\alpha - \mathbb{N}\beta$ depending on whether $\alpha/\beta \in \mathbb{Q}$ or not. Note however that in both cases and as expected $f \circledast g$ has a period α like f .
- (ii) Let $t \in \mathbb{R}_+$ (resp. \mathbb{N}), the deconvolution at t is $(f \circledast g)(t) = \sup_{s \geq 0} (\text{dist}(t+s, \mathbb{N}\alpha) - \text{dist}(s, \mathbb{N}\beta)) = \sup_{s \geq 0} (\text{dist}(s, \mathbb{N}\alpha - t) - \text{dist}(s, \mathbb{N}\beta))$. It is clear that $(f \circledast g)(t) \leq \frac{\alpha}{2}$ and by considering $s \in \mathbb{N}\beta$, we also have $(f \circledast g)(t) \geq 0$. Let us first show that the supremum in $(f \circledast g)(t)$ can be taken for $s \in \mathbb{N}\beta$ instead of $s \geq 0$ without changing its value. Let $s \geq 0$, consider $a \in \mathbb{N}\alpha - t$ (resp. $b \in \mathbb{N}\beta$) such that $|s - a| = \text{dist}(s, \mathbb{N}\alpha - t)$ (resp. $|s - b| = \text{dist}(s, \mathbb{N}\beta)$). These three numbers s, a, b may have a few different relative positions:
 - Suppose that $s \leq a < b$ or $b < a \leq s$, then $\text{dist}(s, \mathbb{N}\alpha - t) - \text{dist}(s, \mathbb{N}\beta) = \text{dist}(s, a) - \text{dist}(s, b) < 0$ whereas $(f \circledast g)(t) \geq 0$, thus such s is not necessary in the supremum.
 - Suppose that $s \leq b \leq a$ or $a \leq b \leq s$, then moving s towards b does not change the value $\text{dist}(s, a) - \text{dist}(s, b)$ and a and b remain its closest points in respectively $\mathbb{N}\alpha - t$ and $\mathbb{N}\beta$. In other terms, by choosing $s' = b \in \mathbb{N}\beta$, we have $\text{dist}(s, \mathbb{N}\alpha - t) - \text{dist}(s, \mathbb{N}\beta) = \text{dist}(s, a) - \text{dist}(s, b) = \text{dist}(s', a) - \text{dist}(s', b) = \text{dist}(s', \mathbb{N}\alpha - t) - \text{dist}(s', \mathbb{N}\beta)$.
 - Suppose that $a \leq s \leq b$. By definition of a , we have $a \leq s \leq a + \frac{\alpha}{2} \leq b$. Either $a \leq s \leq a + \frac{\alpha}{2} \leq a + \alpha < b$ and such s is not necessary in the supremum since $\text{dist}(s, a) - \text{dist}(s, b) = \text{dist}(s, \mathbb{N}\alpha - t) - \text{dist}(s, \mathbb{N}\beta) \leq 0$, or $a \leq s \leq a + \frac{\alpha}{2} \leq b \leq a + \alpha$. In this later case, when moving s towards $a + \frac{\alpha}{2}$, $\text{dist}(s, a) - \text{dist}(s, b)$ increases and a et b remain the closest point in $\mathbb{N}\alpha - t$ and $\mathbb{N}\beta$. Thus with $s' = a + \frac{\alpha}{2}$, we have $\text{dist}(s, \mathbb{N}\alpha - t) - \text{dist}(s, \mathbb{N}\beta) = \text{dist}(s, a) - \text{dist}(s, b) \leq \text{dist}(s', a) - \text{dist}(s', b) = \text{dist}(s', \mathbb{N}\alpha - t) - \text{dist}(s', \mathbb{N}\beta)$. Then when moving s' towards b , the closest points in respectively $\mathbb{N}\alpha - t$ and $\mathbb{N}\beta$ become $a + \alpha$ and b , and the value $\text{dist}(s', \mathbb{N}\alpha - t) - \text{dist}(s', \mathbb{N}\beta) = \text{dist}(s', a + \alpha) - \text{dist}(s', b)$ does not change. Thus with $s'' = b \in \mathbb{N}\beta$, we have $\text{dist}(s'', \mathbb{N}\alpha - t) - \text{dist}(s'', \mathbb{N}\beta) = \text{dist}(s', \mathbb{N}\alpha - t) - \text{dist}(s', \mathbb{N}\beta) \geq \text{dist}(s, \mathbb{N}\alpha - t) - \text{dist}(s, \mathbb{N}\beta)$.

- Suppose that $b \leq s \leq a$. It is symmetric to the previous case but one should be careful about one detail. As above, we can restrict ourselves to the case $a - \alpha \leq b \leq a - \frac{\alpha}{2} \leq s \leq a$. Moving s to $s' = a - \frac{\alpha}{2}$ increases $\text{dist}(s, \mathbb{N}\alpha - t) - \text{dist}(s, \mathbb{N}\beta)$, we only have to check that $s' \geq 0$: it is true since $b \in \mathbb{N}\beta$ and thus $0 \leq b \leq a - \frac{\alpha}{2}$. Then when moving $s' = a - \frac{\alpha}{2}$ to $s'' = b$, to do the same reasoning as the previous case, we have to check that the new potential closest point $a - \alpha$ actually belongs to $\mathbb{N}\alpha - t$: it is true since $a \in \mathbb{N}\alpha - t$, $t \geq 0$ and $0 \leq s \leq a$ implies that $a \in \mathbb{N}^* - t$.

We have shown that $(f \circ g)(t) = \sup_{s \geq 0} (\text{dist}(s, \mathbb{N}\alpha - t) - \text{dist}(s, \mathbb{N}\beta)) = \sup_{s \in \mathbb{N}\beta} (\text{dist}(s, \mathbb{N}\alpha - t) - \text{dist}(s, \mathbb{N}\beta))$. Thus

$$\begin{aligned} (f \circ g)(t) &= \sup_{s \in \mathbb{N}\beta} \text{dist}(s, \mathbb{N}\alpha - t) \\ &= \frac{\alpha}{2} - \inf_{s \in \mathbb{N}\beta} \text{dist}(s, \mathbb{N}\alpha + \frac{\alpha}{2} - t) \\ &= \frac{\alpha}{2} - \text{dist}(\mathbb{N}\beta, \mathbb{N}\alpha + \frac{\alpha}{2} - t) \\ &= \frac{\alpha}{2} - \text{dist}(\mathbb{N}\alpha - \mathbb{N}\beta, t - \frac{\alpha}{2}) \end{aligned}$$

If $\beta/\alpha \in \mathbb{Q}$, we have $\mathbb{N}\alpha - \mathbb{N}\beta = \mathbb{Z}(\alpha \wedge \beta)$ and $(f \circ g)(t) = \frac{\alpha}{2} - \text{dist}(t, \mathbb{Z}(\alpha \wedge \beta) + \frac{\alpha}{2})$. If $\beta/\alpha \notin \mathbb{Q}$, the set $\mathbb{N}\alpha - \mathbb{N}\beta$ is dense within \mathbb{R} , thus there exists a sequence $a_n\alpha - b_n\beta$, $a_n, b_n \in \mathbb{N}$, which tends to $t - \frac{\alpha}{2}$. It means that $\text{dist}(\mathbb{N}\alpha - \mathbb{N}\beta, t - \frac{\alpha}{2}) = 0$ and $(f \circ g)(t) = \frac{\alpha}{2}$.

(iii) Let $t \in \mathbb{R}_+$, we have

$$\begin{aligned} (f \circ g)(t) &= \sup_{s \geq 0} ((t+s) \cdot \text{dist}(t+s, \mathbb{N}\alpha) - s \cdot \text{dist}(s, \mathbb{N}\beta)) \\ &= t \cdot \sup_{s \geq 0} \text{dist}(t+s, \mathbb{N}\alpha) + \sup_{s \geq 0} (s \cdot \text{dist}(t+s, \mathbb{N}\alpha) - s \cdot \text{dist}(s, \mathbb{N}\beta)) \\ &= t \frac{\alpha}{2} + \sup_{s \geq 0} (s \cdot \text{dist}(t+s, \mathbb{N}\alpha) - s \cdot \text{dist}(s, \mathbb{N}\beta)) \end{aligned}$$

Analyzing the second term leads to several cases:

- Suppose that $\beta/\alpha \notin \mathbb{Q}$. The second term is larger than $\sup_{s \geq \mathbb{N}\beta} (s \cdot \text{dist}(t+s, \mathbb{N}\alpha) - s \cdot \text{dist}(s, \mathbb{N}\beta)) = \sup_{s \in \mathbb{N}\beta} s \cdot \text{dist}(s, \mathbb{N}\alpha - t)$. Since $\mathbb{N}\beta - \mathbb{N}\alpha$ is dense within \mathbb{R} , we know that there exists a sequence $b_n\beta - a_n\alpha$, $a_n, b_n \in \mathbb{N}$, which tends to $\frac{\alpha}{2} - t$ without ever reaching this value. It implies that the set $\{b_n, n \in \mathbb{N}\}$ is infinite and we can extract a subsequence $b_{\phi(n)}$ which is increasing. We have $\sup_{s \in \mathbb{N}\beta} s \cdot \text{dist}(s, \mathbb{N}\alpha - t) \geq \sup_{n \in \mathbb{N}} b_{\phi(n)}\beta \cdot \text{dist}(b_{\phi(n)}\beta, \mathbb{N}\alpha - t) = +\infty$ since $b_{\phi(n)} \rightarrow +\infty$ and $\text{dist}(b_{\phi(n)}\beta, \mathbb{N}\alpha - t) = \text{dist}(b_{\phi(n)}\beta - a_{\phi(n)}\alpha, \mathbb{N}\alpha - t) \rightarrow \text{dist}(\frac{\alpha}{2} - t, \mathbb{N}\alpha - t) = \frac{\alpha}{2}$. Thus $(f \circ g)(t) = +\infty$.
- If $\beta/\alpha \in \mathbb{Q}$, we know from case (ii) that $h(t) = \sup_{s \geq 0} (\text{dist}(t+s, \mathbb{N}\alpha) - \text{dist}(s, \mathbb{N}\beta)) = \frac{\alpha}{2} - \text{dist}(t, \mathbb{Z}(\alpha \wedge \beta) + \frac{\alpha}{2})$. This supremum $h(t)$ is equal to 0 if and only if $\frac{\alpha \wedge \beta}{2} = \frac{\alpha}{2}$ and $t \in \mathbb{Z}(\alpha \wedge \beta)$, i.e. $\beta/\alpha \in \mathbb{N}$ and $t \in \mathbb{N}\alpha$ (since $t \geq 0$). In this case, we have $\sup_{s \geq 0} (s \cdot \text{dist}(t+s, \mathbb{N}\alpha) - s \cdot \text{dist}(s, \mathbb{N}\beta)) = \sup_{s \geq 0} s \cdot (\text{dist}(s, \mathbb{N}\alpha) - \text{dist}(s, \mathbb{N}\beta)) = 0$ and finally $(f \circ g)(t) = t \frac{\alpha}{2}$. Otherwise $h(t)$ is strictly positive, and there exists some $s_0 \geq 0$ s.t. $\text{dist}(t+s_0, \mathbb{N}\alpha) - \text{dist}(s_0, \mathbb{N}\beta) = c > 0$. In this latter case, consider the sequence $s_n = s_0 + n(\alpha \vee \beta)$, $n \in \mathbb{N}$. We have $\text{dist}(t+s_n, \mathbb{N}\alpha) - \text{dist}(s_n, \mathbb{N}\beta) = c$ for all $n \in \mathbb{N}$. Thus $\sup_{n \in \mathbb{N}} (s_n \cdot \text{dist}(t+s_n, \mathbb{N}\alpha) - s_n \cdot \text{dist}(s_n, \mathbb{N}\beta)) = +\infty$ and finally $(f \circ g)(t) = +\infty$. ■

Remark 3. Note that the example $g(t) = t \cdot \text{dist}(t, 2\mathbb{N})$ giving $(g \circ g)(t) = t$ if t is even and $= +\infty$ otherwise, was already considered in Remark ??? in [2] where it was proved for $f \in \mathcal{D}$, $f(t) = t$ if t is odd and $= 0$ otherwise, and stated for $[f]_{\mathbb{R}} = g$ without proof.

2.4 Illustrations for the stability big picture

Figure 2.4 sums up the main stability results presented in [2]. The arrows between boxes indicate where the output function lands when applying the operations which label each arrow. If an arrow ends out of its starting point, it means that there exists some input functions whose output does not belong any longer to the initial class. In [2], examples illustrating some of those “unstability” arrows are given. This subsection completes this study by presenting the missing examples in order to illustrate the whole picture.

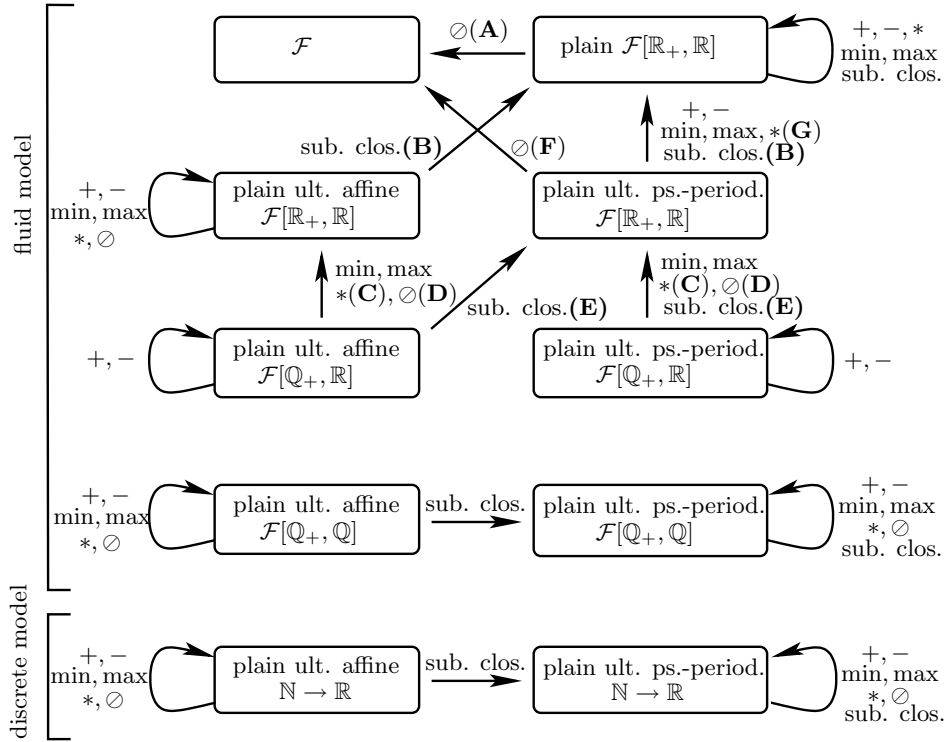

The next lemmas provide some interesting examples of convolution and subadditive closure outputs. Let $S \subseteq \mathbb{R}_+$ (resp. \mathbb{N}), we will denote by $\overline{S} = \mathbb{R}_+ \setminus S$ (resp. $\mathbb{N} \setminus S$) the complementary of S and by $\mathbb{N}S = \{s \mid \exists k \in \mathbb{N}^*, \exists s_1, \dots, s_k \in S, \exists n_1, \dots, n_k \in \mathbb{N}, s = n_1 s_1 + \dots + n_k s_k\}$ the finite sums of elements of S . In the same way, $\mathbb{N}^*S = \{s \mid \exists k \in \mathbb{N}^*, \exists s_1, \dots, s_k \in S, \exists n_1, \dots, n_k \in \mathbb{N}^*, s = n_1 s_1 + \dots + n_k s_k\}$. Note that $\mathbb{N}S = \mathbb{N}^*S \cup \{0\}$. We denote by $\mathbb{1}_S$ the indicator function of S i.e. $\forall t \in \mathbb{R}_+$ (resp. \mathbb{N}), $\mathbb{1}_S(t) = 1$ if $t \in S$ and $= 0$ otherwise. We also recall that the function $dist(t, S) = \inf\{|t - s|, s \in S\}$ gives the distance between t and the set S .

Lemma 3. Let $\alpha, \beta \in \mathbb{R}_+^*$ (resp. \mathbb{N}^*) and $f, g \in \mathcal{F}$ (resp. \mathcal{D}), then:

(i) Let $f = \mathbb{1}_{\overline{\mathbb{N}\alpha}}$ and $g = \mathbb{1}_{\overline{\mathbb{N}\beta}}$, then $f * g = \mathbb{1}_{\overline{\mathbb{N}\alpha + \mathbb{N}\beta}}$.

(ii) Let $f(t) = dist(t, \mathbb{N}\alpha)$ and $g(t) = dist(t, \mathbb{N}\beta)$, then $(f * g)(t) = dist(t, \mathbb{N}\alpha + \mathbb{N}\beta)$.

In both cases, if $f, g \in \mathcal{F}$ and $\beta/\alpha \notin \mathbb{Q}$, then $f * g$ is not ultimately pseudo-periodic.

Proof.

(i) It is a clear consequence of the definition of $*$.

(ii) Let $t_1, t_2 \in \mathbb{R}_+$ s.t. $t_1 + t_2 = t$, then $\exists s_1 \in \mathbb{N}\alpha$ (resp. $s_2 \in \mathbb{N}\beta$) s.t. $f(t_1) = dist(t_1, \mathbb{N}\alpha) = |t_1 - s_1|$ (resp. $g(t_2) = dist(t_2, \mathbb{N}\beta) = |t_2 - s_2|$). We have $f(t_1) + g(t_2) = |t_1 - s_1| + |t_2 - s_2| \geq |t - (s_1 + s_2)| \geq dist(t, \mathbb{N}\alpha + \mathbb{N}\beta)$, and thus $(f * g)(t) \geq dist(t, \mathbb{N}\alpha + \mathbb{N}\beta)$. On the other hand, let $t \geq 0$, then exist $s_1 \in \mathbb{N}\alpha$, $s_2 \in \mathbb{N}\beta$ s.t. $dist(t, \mathbb{N}\alpha + \mathbb{N}\beta) = |t - (s_1 + s_2)|$. If $s_1 = s_2 = 0$, then $(f * g)(t) \leq dist(t, \mathbb{N}\alpha + \mathbb{N}\beta)$ since it is clear that $(f * g)(t) \leq |t|$ for all t . Otherwise $s_1 > 0$ or $s_2 > 0$. Suppose that $s_2 > 0$. Choose $t_1 = s_1$ and $t_2 = t - s_1$, we have $t_1 + t_2 = t$ and $t_2 \geq 0$, since if $t_2 < 0$, it would mean that $|t - s_1| = |t_2| < |t_2 - s_2| = dist(t, \mathbb{N}\alpha + \mathbb{N}\beta)$ which is impossible. Thus $(f * g)(t) \leq f(t_1) + g(t_2) = 0 + dist(t - s_1, \mathbb{N}\alpha + \mathbb{N}\beta) = dist(t, \mathbb{N}\alpha + \mathbb{N}\beta)$ since $t - s_1 \geq 0$. It ends the proof that $(f * g)(t) = dist(t, \mathbb{N}\alpha + \mathbb{N}\beta)$.

The lack of ultimate pseudo-periodicity when $\beta/\alpha \notin \mathbb{Q}$ is due to the fact that in this case $\mathbb{N}\beta - \mathbb{N}\alpha$ is dense within \mathbb{R} . ■

Lemma 4. Let $S \subseteq \mathbb{R}_+$ (resp. \mathbb{N}) and $f \in \mathcal{F}$ (resp. \mathcal{D}), then:

(i) If $f(t) = \mathbb{1}_{\overline{S}}(t)$, then $f^*(t) = \mathbb{1}_{\overline{\mathbb{N}S}}(t)$.

Case	Examples
(A)	see Proposition 5 (piecewise affine shape lost) or Proposition 7 (i) (subdivision by a discrete set of jump points lost) or Proposition 7 (iii) (plain property lost)
(B)	choose $f(t) = \text{dist}(t, \{a, b\})$ or $f(t) = \mathbb{1}_{\{a, b\}}(t)$ with $a/b \notin \mathbb{Q}_+$ (and apply Lemma 4)
(C)	consider Figure 2 with appropriate $r_1, r_2, R \in \mathbb{R}$
(D)	use the construction of Proposition 5 which enables to output some non-decreasing continuous convex function in $\mathcal{F}[\mathbb{R}_+, \mathbb{R}]$ but not in $\mathcal{F}[\mathbb{Q}_+, \mathbb{R}]$, with inputs in $\mathcal{F}[\mathbb{N}, \mathbb{R}]$
(E)	consider Figure 3 with e.g. $f(3) = 5 + \epsilon$, $0 < \epsilon < 1$, $\epsilon \notin \mathbb{Q}_+$
(F)	see Proposition 7 (i) or (ii)
(G)	see Lemma 3

Table 1: Examples/counterexamples for the stability picture.

(ii) If $f(t) = \text{dist}(t, S)$, then $f^*(t) = \text{dist}(t, \mathbb{N}^*S)$ for all $t > 0$ (and $f^*(0) = 0$).

Proof. In both cases, we use Equation 1 defining the subadditive closure, where w.l.o.g. we allow that $t_i \geq 0$ (instead of the overall equivalent $t_i > 0$). For statement (i), it is clear that $f^*(t) = 0$ if and only if $t \in \mathbb{N}S$, and otherwise $1 \leq f^*(t) \leq f(t) = 1$. For statement (ii), let $\epsilon \in \mathbb{R}_+$, let $t_1, \dots, t_k > 0$ s.t. $t = t_1 + \dots + t_k$, then $\forall 1 \leq i \leq k$, $\exists s_i \in S$ s.t. $|t_i - s_i| - \frac{\epsilon}{k} \leq f(t_i) = \text{dist}(t_i, S) \leq |t_i - s_i|$ (if S has no accumulation point outside S , we have in fact the equality $\text{dist}(t_i, S) = |t_i - s_i|$). Then $f(t_1) + \dots + f(t_k) \geq \sum_{1 \leq i \leq k} |t_i - s_i| - \frac{\epsilon}{k} \geq |t - (s_1 + \dots + s_k)| - \epsilon \geq \text{dist}(t, \mathbb{N}S) - \epsilon$. It is true for all $\epsilon > 0$, thus it implies $f^*(t) \geq \text{dist}(t, \mathbb{N}S)$. Now let $\epsilon > 0$, $t > 0$ and consider the smallest integer $k \geq 1$ s.t. $\exists s_1, \dots, s_k \in S$, $\text{dist}(t, \mathbb{N}S) \leq |t - (s_1 + \dots + s_k)| \leq \text{dist}(t, \mathbb{N}S) + \epsilon$ (if the infimum is achieved for some element of $\mathbb{N}S$, let $\epsilon = 0$ and manipulate an equality, it occurs for instance in the discrete model or if S is finite). Choose $t_1 = s_1, \dots, t_{k-1} = s_{k-1}, t_k = t - (s_1 + \dots + s_{k-1})$, then $t_1 + \dots + t_{k-1} + t_k = t$ and $t_k \geq 0$, since either $k = 1$ and $t_k = t \geq 0$, or $k \geq 2$ and $t_k \geq 0$ because $t_k < 0$ would imply that $|t_k| \leq |t_k - s_k|$ which contradicts the minimality of k . Then $\forall 1 \leq i \leq k-1$, $f(t_i) = 0$ and $f(t_k) = \text{dist}(t_k, S) \leq \text{dist}(t_k, s_k) = |t_k - s_k| = |t - (s_1 + \dots + s_k)|$. Thus $f^*(t) \leq f(t_1) + \dots + f(t_k) \leq \text{dist}(t, \mathbb{N}S) + \epsilon$, and it is true for all $\epsilon > 0$. It ends the proof that $f^*(t) = \text{dist}(t, \mathbb{N}S)$. ■

Note that, in case $f(t) = \text{dist}(t, S)$, it is possible to “lift” this function into a *non-decreasing* function by considering $f(t) + t$ for which the subadditive closure is $f^*(t) + t$ (the non-decrease also works for $f(t) = \mathbb{1}_{\overline{S}}(t)$ but only in the discrete model). To get a continuous subadditive closure, ensure that $0 \in S$ and then $f^*(t) = \text{dist}(t, \mathbb{N}S)$ for all $t \geq 0$.

Table 1 provides some examples which complete the justification of Figure 2.4. Each case is designated by a letter which labels the corresponding operation and arrow on Figure 2.4.

2.5 Computational complexity of compressed outputs

Proposition 8. *Let f an ultimately pseudo-periodic function in $\mathcal{F}[\mathbb{Q}_+, \mathbb{Q}]$, computing the smallest rank from which f^* is pseudo-periodic is NP-hard. This remains true even if f is continuous, non-decreasing and ultimately affine.*

Proof. As in the proof for the discrete case (see [2]), we build a reduction from the Frobenius problem. Let a_1, \dots, a_n be integers such that $\text{gcd}(a_1, \dots, a_n) = 1$. The Frobenius problem consists in computing $\text{Frob}(a_1, \dots, a_n) = \min\{t_0 \in \mathbb{N} \mid \forall t \geq t_0, t \in \mathbb{N}a_1 + \dots + \mathbb{N}a_n\}$. It is known to be NP-hard [4].

A first idea is to follow the proof of the discrete case, i.e. choose $f = \mathbb{1}_{\mathbb{N} \setminus (\mathbb{N}a_1 + \dots + \mathbb{N}a_n)}$, and add a step in the reduction by considering $[f]_{\mathbb{R}} \in \mathcal{F}[\mathbb{N}, \mathbb{N}]$. Although it is not true for this particular function that $[f]_{\mathbb{R}}^* = [f^*]_{\mathbb{R}}$, one can prove that the smallest rank from which $[f]_{\mathbb{R}}$ is ultimately pseudo-periodic is either $\text{Frob}(a_1, \dots, a_n)$ (if $\exists i, j, |a_i - a_j| = 1$) or $\text{Frob}(a_1, \dots, a_n) - 1/2$ (otherwise). This is due to the shape of the interpolation. It shows that the initial Frobenius problem can be easily deduced from the computation of the smallest rank of pseudo-periodicity, which is thus NP-hard.

However to avoid a case study, another proof consists in choosing another function having its zeros at $\{0, a_1, \dots, a_n\}$. For all $t \in \mathbb{R}_+$, consider the function $f(t) = \text{dist}(t, \{0, a_1, \dots, a_n\}) = \min\{|t - a| \mid a \in \{0, a_1, \dots, a_n\}\}$. This function measures the distance of t from the set $\{0, a_1, \dots, a_n\}$, it is continuous and ultimately affine from $\max(a_1, \dots, a_n)$. A careful application of Equation 1 gives $f^*(t) = \text{dist}(t, \mathbb{N}a_1 + \dots + \mathbb{N}a_n)$

(see Lemma 4). This function is ultimately pseudo-periodic of period 1 and its smallest rank of pseudo-periodicity is exactly $Frob(a_1, \dots, a_n) - 1/2$. Consequently its computation is NP-hard.

To add a non-decrease hypothesis, “lift” the function $f(t)$ by considering $f(t) + t$. Since the slopes in f are +1 or -1, $f(t) + t$ is non-decreasing. Moreover $(f(t) + t)^* = f^*(t) + t$, and the smallest rank of pseudo-periodicity is exactly the same as the one for f . ■

References

- [1] J.-Y. Le Boudec and P. Thiran. *Network Calculus: A Theory of Deterministic Queuing Systems for the Internet*, volume LNCS 2050. Springer-Verlag, 2001.
- [2] A. Bouillard and E. Thierry. An algorithmic toolbox for network calculus. Technical report, INRIA, 2007.
- [3] C. S. Chang. *Performance Guarantees in Communication Networks*. TNCS, 2000.
- [4] J. L. Ramirez-Alfonsin. Complexity of the Frobenius problem. *Combinatorica*, 16(1):143–147, 1996.



Unité de recherche INRIA Rennes
IRISA, Campus universitaire de Beaulieu - 35042 Rennes Cedex (France)

Unité de recherche INRIA Futurs : Parc Club Orsay Université - ZAC des Vignes
4, rue Jacques Monod - 91893 ORSAY Cedex (France)

Unité de recherche INRIA Lorraine : LORIA, Technopôle de Nancy-Brabois - Campus scientifique
615, rue du Jardin Botanique - BP 101 - 54602 Villers-lès-Nancy Cedex (France)

Unité de recherche INRIA Rhône-Alpes : 655, avenue de l'Europe - 38334 Montbonnot Saint-Ismier (France)

Unité de recherche INRIA Rocquencourt : Domaine de Voluceau - Rocquencourt - BP 105 - 78153 Le Chesnay Cedex (France)

Unité de recherche INRIA Sophia Antipolis : 2004, route des Lucioles - BP 93 - 06902 Sophia Antipolis Cedex (France)

Éditeur
INRIA - Domaine de Voluceau - Rocquencourt, BP 105 - 78153 Le Chesnay Cedex (France)
<http://www.inria.fr>
ISSN 0249-6399