



HAL
open science

Mécanismes de Transmission Multipoint pour Réseaux Locaux Sans Fil IEEE 802.11

Thierry Turetletti, Yongho Seok

► **To cite this version:**

Thierry Turetletti, Yongho Seok. Mécanismes de Transmission Multipoint pour Réseaux Locaux Sans Fil IEEE 802.11. [Research Report] 2006, pp.23. inria-00104699v1

HAL Id: inria-00104699

<https://inria.hal.science/inria-00104699v1>

Submitted on 9 Oct 2006 (v1), last revised 12 Oct 2006 (v2)

HAL is a multi-disciplinary open access archive for the deposit and dissemination of scientific research documents, whether they are published or not. The documents may come from teaching and research institutions in France or abroad, or from public or private research centers.

L'archive ouverte pluridisciplinaire **HAL**, est destinée au dépôt et à la diffusion de documents scientifiques de niveau recherche, publiés ou non, émanant des établissements d'enseignement et de recherche français ou étrangers, des laboratoires publics ou privés.



INSTITUT NATIONAL DE RECHERCHE EN INFORMATIQUE ET EN AUTOMATIQUE

*Practical Rate-Adaptive Multicast Schemes for
Multimedia over IEEE 802.11 WLANs*

Yongho Seok — Thierry Turetli

N° ????

Octobre 2006

Thème COM

 *rapport
de recherche*



Practical Rate-Adaptive Multicast Schemes for Multimedia over IEEE 802.11 WLANs

Yongho Seok , Thierry Turetli

Thème COM — Systèmes communicants
Projet Planète

Rapport de recherche n° 6666 — Octobre 2006 — 20 pages

Abstract: The current IEEE 802.11 standard does not address the basic requirements of multicast communication. More specifically, multicast packets are sent in an open-loop fashion as broadcast packets, i.e., without any acknowledgements. This basic multicast transmission mechanism prevents the implementation of *congestion control*, *transmission reliability*, and *physical data rate adaptation* algorithms. In this paper, we propose new mechanisms based on the *leader based* approach to enhance the legacy multicast transmission scheme in WLANs. We focus on practical solutions that can be deployed in current and future WiFi devices and are compatible with legacy 802.11 devices. We propose two mechanisms to adapt the PHY data rate of multicast flows: the *simplest leader-based mechanism (LB-ARF)* and the *Robust Rate Adaptive Multicast mechanism (RRAM)*. Our simulations show that for static environments, LB-ARF and RRAM can achieve high multicast throughput and fairness between the set of multicast receivers. LB-ARF is sufficient to outperform the legacy multicast mechanism when the stations are fixed. RRAM improves the reliability of the multicast transmission and obtains high throughput independently of the number of multicast receivers and the maximal speed of stations.

Key-words: IEEE 802.11, leader-based approach, multicast transmission, PHY rate adaptation

Mécanismes de Transmission Multipoint pour Réseaux Locaux Sans Fil IEEE 802.11

Résumé : Le standard IEEE 802.11 est inefficace pour la transmission multimédia en multipoint. En particulier, les paquets multipoints sont envoyés en boucle ouverte de la même manière que les paquets broadcast. L'absence d'acquittements rend impossible la mise en œuvre de mécanismes de contrôle de congestion, de mécanisme de fiabilisation de la transmission ainsi que d'algorithmes d'adaptation du débit de transmission physique. Dans ce rapport, nous proposons de nouveaux mécanismes de transmission multipoint qui se basent sur une approche *leader* pour renvoyer des acquittements. Nous nous intéressons à des solutions pratiques qui sont susceptibles d'être implantés dans les cartes réseaux sans fil actuelles et futures et qui restent compatibles avec les stations IEEE 802.11 standards. Nous proposons deux mécanismes pour adapter le débit de transmission physique des flots multipoints: un mécanisme simplifié appelé LB-ARF et un mécanisme plus robuste appelé RRAM. Nos simulations montrent que pour des environnements statiques, un mécanisme aussi simple que LB-ARF suffit pour obtenir de bonnes performances. Le mécanisme RRAM est quant à lui aussi efficace dans des environnements statiques que lorsque les stations sont mobiles.

Mots-clés : IEEE 802.11, algorithmes d'adaptation du débit de transmission physique, transmission multipoint

1 Introduction

The IEEE 802.11 protocol suite aka WiFi is very popular today because it represents a cost effective solution to provide relatively high bandwidth connectivity to wireless LANs (WLANs). Most of today's current personal digital assistants (PDAs) and laptops have by default a WiFi interface. Moore's law and advances in multimedia communication techniques (e.g., compression) make these devices increasingly more capable of handling live multimedia applications. As hot spots become more ubiquitous, people on the move will be able to use their wireless devices (PDAs, cell phones, etc) to receive multimedia data (e.g., watch live broadcasts of news, presentations, etc).

It is well known that multicasting flows instead of streaming them individually results in a much more efficient use of the shared wireless medium. Whereas all these new applications are very likely to appear soon with upcoming WiMAX or DVB-H enabled devices, the IEEE 802.11 standard does not address multicast data requirements [20]. In particular, the current 802.11 standard sends multicast packets similarly to broadcast packets, i.e., without acknowledgements. This basic multicast transmission mechanism poses three main problems, which are described below.

The most critical one is the fact that, without any feedback mechanism, *congestion control* is not possible for multicast flows resulting in unfairness with other concurrent unicast flows. In IEEE 802.11, unicast flows use the DCF access scheme, where contention windows (CW) change dynamically to adapt to the contention level: Upon each collision, a node doubles its CW to reduce further collision risks. Upon a successful transmission, the CW is reset, assuming that the contention level has dropped. Without feedback, multicast flows are not able to adapt their contention window according to the network state. Consequently, they can not only starve concurrent unicast flows but also severely congest the network.

The second problem concerns *transmission reliability*. Although multimedia applications can tolerate a certain percentage of packet loss, their performance may degrade severely in the presence of persistent transmission errors or high channel load. Indeed, contrary to unicast transmissions, no MAC retransmission mechanism is provided for multicast. Corrupted frames (due to transmission errors or collisions) are simply dropped.

The third problem deals with *physical data rate selection*. To achieve high performance under varying channel conditions, IEEE 802.11 devices adapt their PHY transmission rate dynamically. Several mechanisms have been proposed in the literature such as RBAR [10] or CLARA [21] or the commercial ARF [8] protocol. But these mechanisms are not usable with the current open-loop multicast transmission protocol. Indeed, most commercial access points (APs) to-date use a fixed and relatively very low transmission rate for multicast transmissions. Such a case exhibits the 802.11 anomaly [16], and the performance of other unicast stations is seriously degraded as the multicast traffic overwhelms the wireless bandwidth due to the fixed and low data rate [20].

As discussed in the following section, several solutions have been proposed recently to solve these problems, but none of them can actually be used today because of implementation issues or compatibility problems with legacy 802.11 devices. In this paper, we focus on practical solutions that can be adopted by current and future 802.11 devices.

The remainder of this paper is organized as follows. In Section 2, we present a review of solutions proposed so far to enhance the 802.11 multicast transmission mechanism and we discuss implementation issues of solutions. Section III and Section IV describe our solutions composed of a leader election protocol and two multicast PHY rate adaptation algorithms. Especially, in Section 4.1, we describe the simplest solution that could be used with current devices in static environments. Then we describe in Section 4.2 the proposed Robust Rate Adaptive Multicast mechanism (RRAM) which aims to provide an efficient solution for mobile 802.11 environments and dynamic channel conditions. In Section 5, we evaluate the performance of RRAM against the current IEEE 802.11 multicast transmission protocol. Finally, we conclude in Section 6 and present directions for future work.

2 Related work and Discussion

One of the alternatives to improve the current 802.11 multicast mechanism for reliable transmissions is the leader-based reliable multicast scheme [15]. In a nutshell, this solution proposes to select one of the receivers to send acknowledgement frames back to the sender. To transmit a multicast frame, the AP first sends a non-standard multicast-RTS frame. If a leader is ready to receive the multicast frame, it replies with a CTS frame. Other stations send a non-standard NCTS (Not Clear to Send) frame if they are not ready to receive the multicast frame. In other cases, the leader and other stations do not send any frame. If the AP hears a CTS from the leader, it starts a multicast transmission. Else, it performs a backoff to retransmit the multicast frame. Upon receiving the multicast frame, if the leader receives it without error, it sends an ACK frame. Otherwise, the leader and other stations send a non-standard negative acknowledgment (NAK) frame. As with regular unicast transmissions, the multicast sender can use a PHY rate selection mechanism such as ARF [8] and lost frames can be retransmitted as it is the case for unicast flows. Furthermore, the leader-based approach provides fairness with other concurrent unicast flows because the same algorithm also adjusts the contention window according to the perceived congestion conditions.

Another approach to solving the problem of lack of congestion control, proposed by Choi et al, dynamically adapts the contention window for multicast frames according to the number of competing stations in the wireless LAN [12]. However, this solution does not improve transmission reliability and still uses a fixed PHY data rate.

In [11], Villalon et al. have proposed a solution, called auto rate selection mechanism (ARSM), to solve the three problems identified for the IEEE 802.11 multicast mechanism. Basically, ARSM dynamically selects the multicast PHY rate based on channel conditions perceived by the receiving stations. In order to reduce the rate of feedback collision, ARSM uses the SNR value of the station to decide when the feedback frame is transmitted. The station with the worst SNR has the highest priority to send its feedback frame. Then, the AP can select the station with the lowest SNR value as the leader. The main flaw of the ARSM mechanism is that it uses new control frames for the feedback mechanism which makes it incompatible with current 802.11 stations.

The easiest way to solve the three problems identified with the current 802.11 standard's multicast mechanism is to emulate unicast transmission using a leader-based approach, which, in a nutshell, means that one of the receiving stations is responsible to send acknowledgements on behalf of the intended receiving stations. This feedback is used to trigger possible retransmissions, adapt the contention window, and select the PHY data rate. Our possible leader selection policy is to choose the receiver with the worst channel conditions. However, the overhead associated with leader election increases with the number of multicast receiving stations, so, it is not efficient to choose a new leader for each new transmission. On the other hand, the algorithm to select the PHY data rate requires per-packet feedback. The fact that these algorithms run at two different timescales can cause situations where the current leader does not correspond to the receiver which experiments the worst channel conditions. In particular, for a simple PHY rate selection algorithm such as ARF [8] used in combination with a leader-based mechanism, when the leader decides to increment the PHY rate, it is not guaranteed that other receivers can afford the rate increment. In extreme cases, some receivers can even become disconnected from the data session. A way to prevent such a problem is to allow feedback from any receivers before taking critical decisions such as rate increase.

It is important to note that the PHY data rate selection algorithm supplements the leader selection mechanism because it enhances transmission reliability even when the current leader does not correspond to the worst receiver in the group. Two different types of statistics can be used to select the PHY data rate: statistics on previous packets sent (used by ARF [8]/AARF [9]) or SINR statistics (used by RBAR [10], CLARA [21]). There are pros/cons for both approaches. The main problem with ARF/AARF is that they are not as reactive than SINR-based solutions and may generate bad experiments or periodic losses. On the other hand, SINR-based solutions can be device-dependent, and the SINR information may sometimes be imprecise. The mechanisms proposed in this paper consider both approaches.

It is also important to propose solutions that do not use negative acknowledgement (NAK) frames like the leader-based reliable multicast scheme [15] because they have important implementation issues. In particular, the decision to send NAK frames has to be immediate (and sometimes wired in the hardware).

In this paper, we focus on practical solutions that try to limit implementation issues and keep compatible with legacy IEEE 802.11 devices. Leader-based mechanisms are composed of two main algorithms, that select the leader and select the PHY data rate. We first describe the leader election protocol in Section 3 which will be used by the multicast PHY rate adaptation mechanisms in Section 4.

3 Leader Election Protocol

The proposed Leader Election Protocol (LEP) dynamically selects the receiving station with the worst current channel conditions as the leader. The LEP mechanism is based on IGMP and consists of the following four phases.

Figure 1: Modified IGMP format (for MR and GSQ).

3.1 Collection Phase

To select the leader, LEP needs to estimate the channel conditions of each multicast receiver. To this end, multicast receivers periodically send modified IGMP Membership Reports (MR) that include the SINR indication (7 bits) within the MRT¹ field, see Figure 1. The duplicated bit (D bit) reserved for the leader reelection is reset to 0.

When the AP receives an IGMP Membership Report with a non-zero MRT, it assumes that the station supports the LEP mechanism. Then, the AP stores the multicast group address, the MAC address and the SINR of the station.

3.2 Election Phase

Whenever receiving an IGMP Membership Reports, the AP chooses the station with the lowest SINR. If the current leader is not the worst station, the AP sends a modified IGMP Group Specific Query (GSQ) which includes the SINR of the selected worst station within MRT field. If more than one stations have the same lowest SINR value, the AP sets the duplicated bit to 1. Otherwise the duplicated bit is set to 0. The duplicated bit corresponds to the **D bit** of Figure 1.

Once receiving IGMP Group Specific Query, each mobile station checks the source IP address of the IGMP Group Specific Query. If the source IP address does not correspond to the AP, the packet is considered as a legacy IGMP Group Specific Query coming from the multicast routers. So, each multicast receiver sends the legacy IGMP Membership Report after some delay time. Otherwise, each mobile station carries out the following *Confirmation Phase*.

3.3 Confirmation Phase

Through the MRT field of the IGMP Group Specific Query, each multicast receiver can know the previous SINR of the new elected leader. So, each multicast receiver compares the reported SINR during the *Collection Phase* with the SINR of new elected leader. Then, the multicast receiver having the same SINR does the followings according to the duplicated bit.

- **Duplicated bit == 0** : send the additional IGMP Membership report with same SINR to confirm the leader election. The duplicated bit of the IGMP Membership Report is reset to 0.

¹MRT specifies the maximum allowed time before sending a responding report but is meaningful only in an IGMP Membership Query message sent by a multicast router. In other messages, the MRT is set to 0 by a sender and ignored by receivers.

- **Duplicated bit == 1** : send the additional IGMP Membership report with the random number instead of same SINR to carry out the *Reelection Phase*. Duplicated bit of the IGMP Membership Report is set to 1.

Finally, if the AP receives the IGMP Membership Report with same SINR value, then the AP terminates the leader election algorithm.

Else if the AP does not receive the IGMP Membership Report, the AP will retransmit the IGMP Group Specific Query with the confirmation. Otherwise, the AP will try the *Reelection Phase*. This confirmation phase is very important. Because the IGMP Group Specific Query is simply broadcasted without any acknowledgement.

3.4 Reelection Phase

If the AP receives the IGMP Membership Report of which the duplicated bit is set to 1, it does not change the SINR statistic about this station because this IGMP Membership Report is just used for the leader reelection. Then, the AP sends the additional IGMP Group Specific Query. However, the MRT field of IGMP Group Specific Query is equal to one of previously received IGMP Membership Report (i.e., the random number choosed by station). The duplicated bit of this Group Specific Query is set to 0.

4 Multicast PHY Rate Adaptation Mechanism

In this section, we propose two PHY rate adaptation mechanisms, LB-ARF and RRAM both of which work in tandem with LEP.

4.1 LB-ARF

First we propose the simplest leader-based mechanism (or LB-ARF) for rate-adaptive multicast. In LB-ARF, the leader elected by LEP sends an acknowledgement frame to the AP once a multicast frame has been successfully received.

Then, the AP controls the multicast PHY rate similarly to ARF. When the timer expires or once 10 consecutive ACKs are received, the multicast PHY transmission rate is increased to the next higher rate and the timer is reset. When losses occur, after two consecutive lost frames, the PHY transmission rate is decremented and the timer is restarted.

If the worst station is always elected as the leader, LB-ARF can provide throughput fairness between multicast receivers but also achieves high multicast throughput. However, LB-ARF is not appropriate for mobile environments. Because the channel conditions of the receivers are changing quickly.

4.2 RRAM

The Robust rate adaptive multicast mechanism (RRAM) aims to extend LB-ARF targeting dynamic environments (e.g., due to mobility).

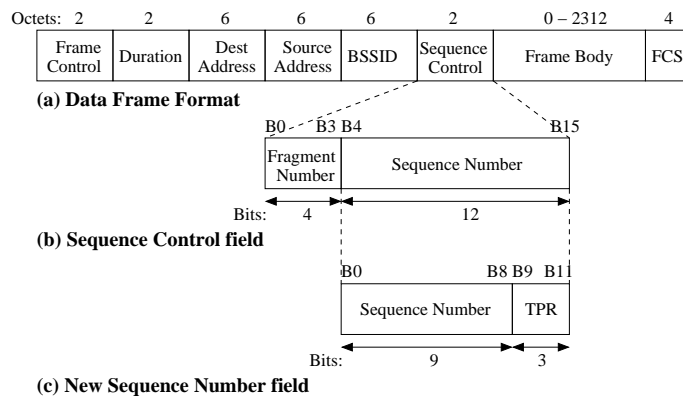

Figure 2: New Sequence Number field in multicast frame.

As we mentioned in Section 2, it is important to allow feedback from any receivers before taking critical decisions such as rate increase because the leader may not have the worst channel conditions at this time. So, RRAM requires a mechanism to inform all receivers that the leader is about to increase the PHY transmission rate.

To this end, RRAM requires a minor modification in the MAC header of multicast data frames. The 802.11 MAC header contains a 16-bit field called *Sequence Control* field which is composed of two subfields: *Sequence Number* and *Fragment Number*. These subfields are used for retransmission and fragmentation only in point-to-point transmissions.

Therefore, in RRAM we propose to use the *Sequence Control* field to inform multicast receivers that the leader is about to increase the PHY transmission rate. As shown in Figure 2, a new 3-bit field termed *Target Probe Rate (TPR)* is added and the *Sequence Number* field is encoded in 9 bits in the multicast case. The *TPR* field will encode the value of the PHY transmission rate that the leader wants to enforce. Since the length of the *TPR* field is 3 bits, 8 different PHY transmission rates can be supported.

So, when multicast receivers receive data frames with a *TPR* value larger than current PHY transmission rate, they can deduce that the leader requires a PHY rate increase. In this case, each multicast receiver has to check if its current SINR value is compatible with the *TPR* rate. Table 1 shows an example of the minimal (or target) SINRs for using each PHY rate based for the Atheros chipset [24]. In case the current SINR value is less than the target SINR, the multicast receiver has to acknowledge the next receiving data frame. Then, a ACK collision will occur with the leader, and the AP will use the *ClearChannelAssessment(CCA)* function to realize that the PHY rate increase is incompatible with some of the receivers in the multicast group.

Table 1: target SINRs for using *TPR* in IEEE 802.11a.

TPR	target SINR (dB)
54 Mbps	24.56
48 Mbps	24.05
36 Mbps	18.80
24 Mbps	17.04
18 Mbps	10.79
12 Mbps	9.03
9 Mbps	7.78
6 Mbps	6.02

4.2.1 PHY Rate Adaptation Mechanism

The PHY rate adaptation mechanism of RRAM utilizes the state machine shown in Figure 3. In this Figure, solid lines represent the successful transmissions, dashed lines represent failed transmissions; *min* and *max* stand for the minimum PHY rate and the maximum PHY rate, respectively. Remark that this state machine is implemented in the MAC layer of the AP.

- **Initial State**

In the initial state, the AP chooses the multicast PHY rate according to the SINR of the new leader. Function $F(SINR)$ returns the highest PHY rate satisfying the following condition. The SINR should be larger than target SINR for using the choosed PHY rate.

- **Success States**

In case of successful transmission, the AP counts the number of consecutive successful transmission. $S(i)$ stands for the i^{th} consecutive successful transmissions.

However, after the state $S(7)$, the following state is decided according to the SINR of the ACK frame received in the AP. If the received SINR of this ACK frame is higher than the target SINR for using the next higher PHY rate, the state is kept unchanged, $S(8)$. Otherwise, the state remains at the current state, $S(7)$.

In the state $S(8)$, the AP probes the channel conditions of non-leader stations to increase the multicast PHY rate. This channel probe operation consists of two phases.

First, the AP increases the TPR value to the next higher PHY rate as shown in $S(8)$.

Second, the AP transmits the multicast frame and waits for the ACK frame. This corresponds to the state $S(9)$. Other stations except the *Leader* compare the SINR with the target SINR for using the TPR. If the SINR of some stations is less than

the target SINR, these stations also temporally become *Leaders* for this multicast transmission. Consequently, a ACK collision from several leaders can occur.

So, if the AP correctly receives the ACK frame, it means that the SINR of other stations are larger than the target SINR for using next higher PHY rate.

In the state $S(10)$, the AP increases both the multicast PHY rate and TPR for probing the channel conditions of the leader. It is similar to the legacy ARF mechanism because the PHY rate in ARF is increased after 10 consecutive successful transmissions.

Finally, in the state $S(1)$, if the multicast PHY rate reaches the maximum PHY rate, the state is kept unchanged.

- **Failure States**

In case of the transmission failures, the AP also counts the number of consecutive transmission failures. $F(1)$ and $F(2)$ stand for 1 and 2 consecutive failed transmissions, except for the state $S(10)$. In the state $S(10)$, once the multicast transmission is failed, it immediately triggers a PHY rate decrease procedure.

As with ARF, two consecutive failed multicast transmissions triggers a PHY rate decrease procedure. Especially, in the state $S(10)$, if the next multicast transmission fails, the state is changed to $F(2)$ and the multicast PHY rate is immediately decreased. Finally, in the state $F(1)$, if the multicast PHY rate reaches the minimum PHY rate, the state is kept unchanged.

4.2.2 Implementation Issues

First, stations need to know whether the currently associated AP supports the RRAM mechanism or not. On this purpose, each multicast receiver checks the duration field of the multicast frame. In the IEEE 802.11 MAC protocol, the duration field of the multicast frame is set to 0. If the duration field for the multicast frame is not equal to 0, this means that the AP supports RRAM.

Second, to implement RRAM, leader stations should turn on the acknowledgement function for multicast frames. But, most of IEEE 802.11 network interface card do not allow to send ACK frames for multicast frames. However, such an option could be easily integrated into the upcoming IEEE 802.11n standard [6].

5 Performance Evaluation

We evaluate the performance of LB-ARF and RRAM with an extended version of the NS-2 Simulator [22]². First, in Section 5.1, we study the *reliability problem* and the

²Simulation codes and scripts are available at the following URL: <http://www-sop.inria.fr/planete/software/>.

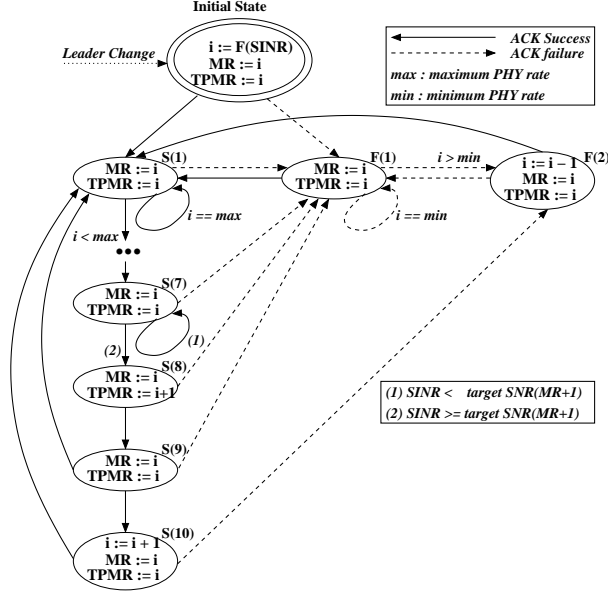

Figure 3: State transition diagram for multicast transmission rate adaptation.

congestion control problem of the multicast transmission as the number of multicast receivers increases, with a static environment scenario. Then, we compare the physical data rate selection mechanism of legacy IEEE 802.11a, LB-ARF and RRAM, with a static environment scenario. Second, in Section 5.2, we compare the performance of legacy IEEE 802.11a, LB-ARF and RRAM, in a mobile environment. Especially, we analyze the multicast throughput, packet loss rate and multicast rate as the maximum speed of receivers increases. Furthermore to study the scalability of each mechanism, we carry out the simulations with a varying number of multicast receivers, from 5 stations to 25 stations.

Each mobile station is operated in IEEE 802.11a infrastructure mode. In order to support IEEE 802.11a protocol, we use the enhanced IEEE 802.11a NS-2 module [23] that comprises the following new features,

(a) *BER-based PHY layer model* : In the PHY layer, the packet error rate is determined by the BER and the frame length. In order to compute the BER, the PHY layer model records SINR variations during a frame reception. After receiving the frame, the PHY layer model can compute a more exact BER value even though it requires a high computation complexity because the BER is recomputed whenever the SINR is changed.

(b) *IEEE 802.11a multi-rate* : IEEE 802.11a supports 8 different physical data rates, 6Mbps, 9Mbps, 12Mbps, 18Mbps, 24Mbps, 36Mbps, 48Mbps and 54Mbps.

(d) *ARF and AARF [9] rate adaptation mechanisms* : ARF is a well-known rate adaptation mechanism for point-to-point connection. Adaptive Auto Rate Fallback (AARF) is an extended mechanism of ARF that improves upon ARF to provide both short-term and long-term adaptation.

To simulate indoor office environments, we use a log-distance path-loss model with the path-loss exponent of three [13]. Additionally, in order to consider multipath fading effect, we use the Ricean propagation model [14]. When there is a dominant stationary signal component present, such as with line-of-sight propagation path, the small-scale fading envelope has a Ricean distribution.

5.1 Static Scenarios

5.1.1 Scalability Issues

A group is composed of five multicast receivers. The number of unicast stations increases from 1 to 20 stations. All stations are located near the AP (i.e., 10 m). But, we turn off the rate adaptation mechanism of LB-ARF and RRAM, so the multicast transmission rate of each mechanism is fixed to 6Mbps.

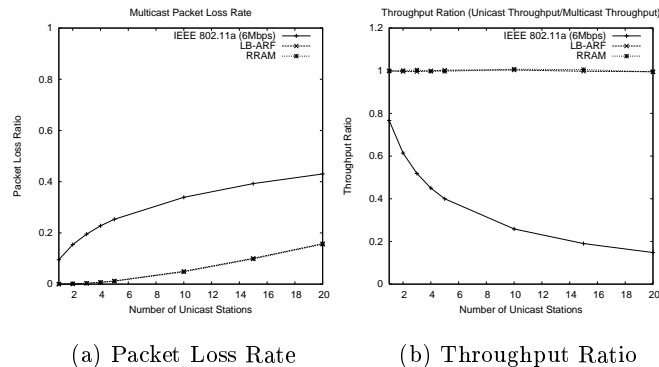

Figure 4: Fairness performance according to the number of unicast stations.

We first compute the multicast packet loss rate of each mechanism, IEEE 802.11a, LB-ARF and RRAM, as the number of unicast stations increases. As shown in Figure 4 (a), the multicast packet loss rate for the IEEE 802.11a standard is too high, even when only one unicast station competes with the multicast sender. LB-ARF and RRAM both obtain lower multicast packet loss rate than the legacy IEEE 802.11a protocol.

In Figure 4 (b), we compute the throughput ratio between the unicast and the multicast connections, the average unicast throughput / the average multicast throughput. When the sender use the legacy IEEE 802.11a protocol, it can not carry out the binary exponential backoff mechanism. So, we can observe severe unfairness between the unicast throughput and

the multicast throughput. However, by enabling the binary exponential backoff mechanism for multicast transmissions, LB-ARF and RRAM are both fair between unicast and multicast flows.

5.1.2 Wireless Channel Fading Issue

We compare the performance of the IEEE 802.11a legacy multicast, LB-ARF and RRAM, according to the distance between the AP and the multicast receivers. On this purpose, Five stations join the multicast group. Initially, the multicast receivers are located to 10 meters away from the AP (with an excellent channel quality), and only one of the 5 stations is located between 0 and 160 meters from AP.

Two unicast stations generate a saturated background traffic. These unicast stations are also located near the AP. We measure the average throughput of the *best multicast receiver* and the *worst multicast receiver* that have the best channel conditions and the worst channel conditions respectively. Although we measure the average throughput of the unicast stations, we do not show the results because the results are very similar to the throughput of the best multicast receiver.

We use the Ricean channel model in order to take into account the multipath fading effect. In Figures 5 (a) and (b), we compare the IEEE 802.11a protocol with both solutions, respectively LB-ARF and RRAM. The IEEE 802.11a protocol has the lowest throughput for the multicast connection. When the distance between the worst receiver and the AP is larger than 100 meters, the worst receiver experiences some wireless channel errors. Although the multicast transmission of IEEE 802.11a uses the lowest PHY rate, some frames are lost because there is no retransmission mechanism for multicast.

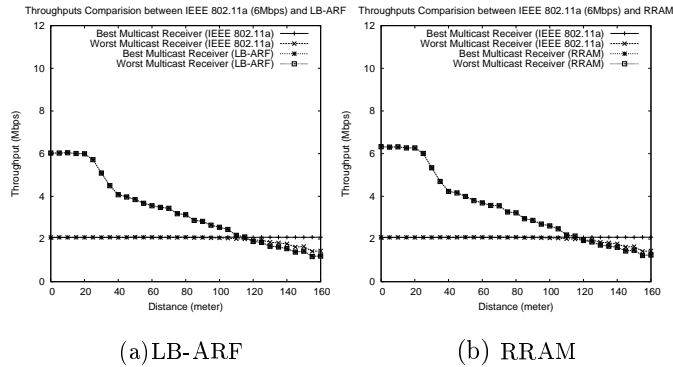

Figure 5: Performance comparison of IEEE 802.11, LB-ARF and RRAM with a Ricean channel model.

In Figure 5 (a), when using LB-ARF, the throughput of the best multicast receiver and the worst multicast receiver are similar. It means that LB-ARF correctly chooses

the multicast transmission rate according to the channel conditions of the worst multicast receiver. In Figure 5 (b), when using RRAM, the worst multicast receiver and the best multicast receiver also obtain similar throughput than LB-ARF.

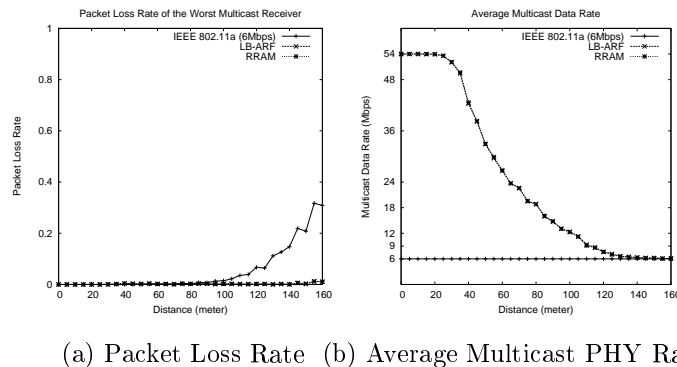

Figure 6: Packet loss rate and multicast PHY rate comparison.

Figures 6 (a) shows respectively the average packet loss rates of the worst multicast receiver. The average packet loss rates of LB-ARF and RRAM are less than 5%. However, in the case of IEEE 802.11a, the packet loss rate increases after long distance (i.e., 100 meters), because the IEEE 802.11 MAC protocol does not retransmit corrupted multicast frames caused by wireless channel errors. Figures 6 (b) shows respectively the average multicast PHY rates. The average multicast PHY rates of LB-ARF and RRAM decrease as the channel conditions of the worst station decreases. Also, there is very few difference between the average multicast PHY rates of LB-ARF and RRAM. Figures 5 and 6 show that LB-ARF outperform the legacy IEEE 802.11a protocol in static environments, but LB-ARF shows the problem in the random mobility environments because it is required to more frequently change leader. We analyze these issues in the following Section.

5.2 Mobile Scenarios

5.2.1 Scalability Issue

First we compare the scalability of LB-ARF and RRAM mechanisms by increasing the number of multicast receivers, with a random mobility model. The number of multicast receivers increases from 5 receivers to 25 receivers. One receiver among the set of multicast receivers, corresponding to the the best receiver, is fixed near the AP. The others move within a square area (60 m by 60 m) with a random waypoint mobility model. The maximal velocity of moving receivers is 3 m/s and the pause time is set to 1 s. We also use the Ricean channel model. Two unicast stations, located near the AP, are used to generate a saturated traffic.

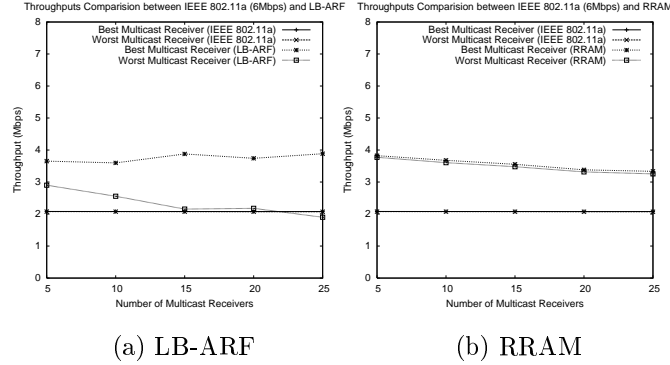
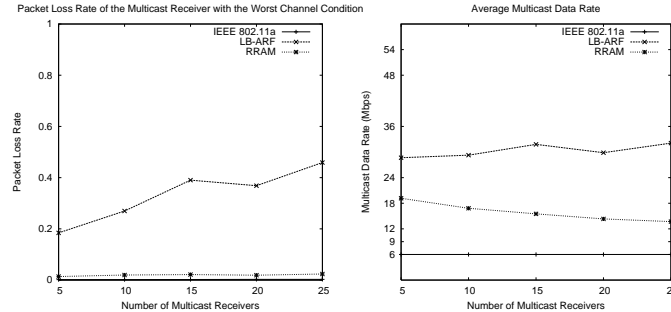

Figure 7: Performance comparison of IEEE 802.11a, LB-ARF and RRAM.

In Figures 7 (a) and (b), we compare the IEEE 802.11a protocol with both solutions, respectively LB-ARF and RRAM. As shown in Figure 7 (a), when using LB-ARF, the throughputs of the best multicast receiver and the worst multicast receiver exhibit a large difference. Especially, as the number of multicast receivers increases, the throughput difference between the best multicast receiver and the worst multicast receivers increases. As the number of multicast receivers increases, the worst stations is more frequently changed. But, LB-ARF can not quickly change the leader whenever the worst multicast receiver changes, because the timescale of leader election is relatively longer than the one of channel variation. However, RRAM provides a high transmission reliability for multicast frames. In Figure 7 (b), when using RRAM, the throughputs of the best multicast receiver and the worst multicast receiver are very similar. Although the number of multicast receivers increases, RRAM provides the reliable transmission and the high throughgput. It means that RRAM chooses the appropriate PHY rate for the channel condition of the worst multicast receiver.

Figures 8 (a) shows the average packet loss rates of the worst multicast receiver. The average packet loss rates of IEEE 802.11a and RRAM are less than 3%. However, in the case of LB-ARF, the packet loss rate is larger than 20% and it also increases as the number of multicast receivers increases. Because the corrupted multicast frame of the worst station is never retransmitted, when the worst stations is not elected to the leader. Figures 8 (b) shows the average PHY multicast transmission rates. In the case of LB-ARF, a high multicast PHY rate is selected. When the worst station is not selected as the leader, the AP will use the higher transmission rate. In fact, with LB-ARF, it is difficult to quickly detect the worst station. However, RRAM allows to select the appropriate multicast PHY rate that is higher than 6Mbps of IEEE 802.11a. Figures 7 and 8, LB-ARF has the problem in a mobile environment.



(a) Packet Loss Rate (b) Average Multicast PHY Rate

Figure 8: Packet loss rate and multicast PHY rate comparison.

5.2.2 Mobility Issue

We compare the performance of LB-ARF and RRAM by increasing the maximum speed of multicast receivers, from 0.1 m/s to 5 m/s. The number of multicast receivers is fixed to 5 receivers. One of the multicast receivers is located near the AP. (it corresponds to the best multicast receiver.) The others move in square area (60 m by 60 m) with a random waypoint mobility model. We also use the Ricean channel model. Two unicast stations located near to the AP are used to generate a saturated traffic.

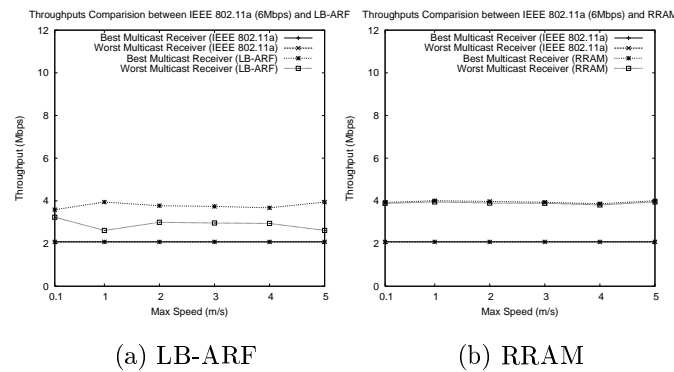

(a) LB-ARF

(b) RRAM

Figure 9: Performance comparison of IEEE 802.11a, LB-ARF and RRAM.

In Figures 9 (a) and (b), we compare the IEEE 802.11a protocol with both solutions, respectively LB-ARF and RRAM. As shown in Figure 9 (a), in the case of LB-ARF, the throughput of the worst multicast receiver is similar than the throughput of the best mul-

multicast receiver at the very low speed such as 0.1 m/s. However, as the speed increases, we observe a large difference of throughput between the best multicast receiver and the worst multicast receiver. Although the number of multicast receivers is very small, LB-ARF does not achieve throughput fairness between the set of multicast receivers. In the case of RRAM, as shown in Figure 9 (b), the throughputs of the best multicast receiver and the worst multicast receiver are similar. Especially, even though the speed of the multicast receivers increases, RRAM provides high throughput fairness between the best multicast receiver and the worst multicast receiver. Because RRAM can choose an appropriate multicast transmission rate even when the worst station is not elected to the leader.

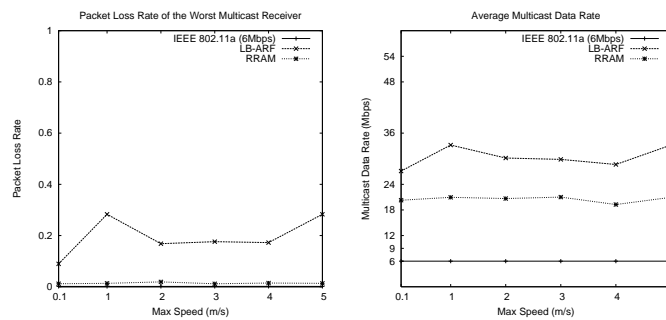

(a) Packet Loss Rate (b) Average Multicast PHY Rate

Figure 10: Packet loss rate and multicast PHY rate comparison.

Figures 10 (a) and (b) show the average packet loss rates of the worst multicast receiver and the average multicast transmission rates, respectively. In the case of LB-ARF, the packet loss rate of the worst multicast receiver is very high. But, the packet loss rates of IEEE 802.11a and RRAM are less than 2%. Even though the stations' speed increases, RRAM can choose the transmission rate corresponding to channel conditions of the worst station. Consequently, the rate adaptation mechanism of RRAM is more robust even with a large number of multicast receivers or with high mobility of stations.

6 Conclusion

In this paper, we propose practical solutions that make possible the deployment of multicast multimedia applications in WLANs. Our solutions are based on the leader-based approach. Because the leader election mechanism cannot run at the same timescale than the PHY rate adaptation mechanism, we propose that the PHY rate adaptation mechanism authorizes feedback from any receivers in the group before taking critical decisions such as rate increase. We describe and evaluate the LB-ARF mechanism for static environments and its extended version called RRAM which is efficient both for fixed and mobile stations.

To implement RRAM, we do not require additional functions such as a negative acknowledgement in LBP [15] neither new 802.11 control frames such as with ARSM [11]. However, our solutions require the possibility to turn on the acknowledgement function for multicast frames when necessary.

Acknowledgments

This work has been partially supported by the French Ministry of Research RNRT Project "DIVINE" and the Korea Research Foundation Grant funded by the Korean Government (KRF-2005-214-D00340). The authors wish to thank Katia Obraczka for providing valuable comments in the paper.

References

- [1] IEEE WG, "Part 11: Wireless LAN Medium Access Control (MAC) and Physical Layer (PHY) Specifications," IEEE 802.11 Standard, 1999.
- [2] IEEE WG, "Part 11: Wireless LAN Medium Access Control (MAC) and Physical Layer (PHY) Specifications: High-speed Physical Layer in the 5GHz Band," IEEE 802.11 Standard, 1999.
- [3] IEEE WG, "Part 11: Wireless LAN Medium Access Control (MAC) and Physical Layer (PHY) Specifications: Higher-Speed Physical Layer Extension in the 2.4 GHz Band," IEEE 802.11 Standard, 1999.
- [4] IEEE WG, "Part 11: Wireless LAN Medium Access Control (MAC) and Physical Layer (PHY) Specifications: Amendment 4: Further Higher Data rate Extension in the 2.4 GHz Band," IEEE 802.11 Standard, 2003.
- [5] IEEE WG, "Part 11: Wireless LAN Medium Access Control (MAC) and Physical Layer Specifications: Amendment : Medium Access Control Quality of Service Enhancements," IEEE 802.11 Standard, 2005.
- [6] IEEE WG, "Part 11: Wireless LAN Medium Access Control (MAC) and Physical Layer (PHY) Specifications: Enhancements for Higher Throughput," IEEE 802.11n D0.02., February 2006.
- [7] W. Fenner, "Internet Group Management Protocol, Version 2," RFC 2236, November 1997.
- [8] A. Kamerman, and L. Monteban, "WaveLAN II: A high-performance wireless LAN for the unlicensed band," Bell Labs Technical Journal, page 118-133, Summer 1997.
- [9] M. Lacage, M. H. Manshaei, and T. Turetli, "IEEE 802.11 rate adaptation: a practical approach," in Proc. of ACM MSWiM 2004, Venice, Italy, 2004.

-
- [10] G. Holland, N. Vaidya, and P. Bahl, "A rate-adaptive MAC protocol for multi-hop wireless networks," in Proc.s of ACM MOBICOM 2001, Rome, Italy, 2001.
 - [11] J. Villalon, Y. Seok, and T. Turletti, "Auto Rate Selection for Multicast in Multi-rate Wireless LANs," in Proc. of IFIP PWC 2006, Albacete, Spain, 2006
 - [12] N. Choi, J. Ryu, Y. Seok, Y. Choi, and T. Kwon, "Unicast-Friendly Multicast in IEEE 802.11 Wireless LANs," in Proc. of IEEE CCNC 2006, Las Vegas, USA, 2006.
 - [13] T.S. Rappaport, "Wireless Communications: Principle and Practice," Englewood Cliffs, NJ: Prentice-Hall, 1996.
 - [14] Ratish J. Punnoose, Pavel V. Nikitin, and D. Stancil, "Efficient simulation of ricean fading within a packet simulator," in Proc. of IEEE VTC, 2000.
 - [15] Joy Kuri and Sneha Kumar Kasera, "Reliable Multicast in Multi-access WLANs," ACM Wireless Networks, Vol. 7, No. 4, 2001.
 - [16] M. Heusse, F. Rousseau, G. Berger-Sabbatel, and A. Duda, "Performance Anomaly of 802.11b," in Proc. of IEEE INFOCOM, April 2003.
 - [17] G. R. Cantieni, Q. Ni, C. Barakat and T. Turletti, "Performance Analysis of Finite Load Sources in 802.11b Multirate Environments", Computer Communications Journal, Vol. 28, No 10, pp. 1095-1109, June 2005.
 - [18] Y. Seok, Y. Choi, T. Kwon and Jean-Marie BONNIN, "Temporal Fairness Guarantee in Multi-rate Wireless LANs for Per-Flow Protection," to appear in ACM/Kluwer Wireless Networks (WINET), 2006.
 - [19] M. Heusse, F. Rousseau, R. Guillier and A. Duda, "Idle Sense: An Optimal Access Method for High Throughput and Fairness in Rate Diverse Wireless LANs," in Proc. of ACM SIGCOMM, Aug. 2005.
 - [20] D. Dujovne and T. Turletti, "Multicast in 802.11 WLANs: An Experimental Study," in Proc. of ACM/IEEE MSWiM, 2006.
 - [21] C. Hoffmann, H. Manshaei, T. Turletti, "CLARA: Closed-Loop Adaptive Rate Allocation for IEEE 802.11 WLANs", IEEE WirelessCom'05, Hawai, USA, 2005.
 - [22] "The Network Simulator 2," <http://www.isi.edu/nsnam/ns/>, online link.
 - [23] "New 802.11 PHY and MAC modules," <http://yans.inria.fr/ns-2-80211/>, online link.
 - [24] "Atheros Communications Inc., "Measured Performance of 5-GHz 802.11a Wireless LAN Systems," Atheros Com. Inc., Aug. 2001.

Contents

1	Introduction	3
2	Related work and Discussion	4
3	Leader Election Protocol	5
3.1	Collection Phase	6
3.2	Election Phase	6
3.3	Confirmation Phase	6
3.4	Reelection Phase	7
4	Multicast PHY Rate Adaptation Mechanism	7
4.1	LB-ARF	7
4.2	RRAM	7
4.2.1	PHY Rate Adaptation Mechanism	9
4.2.2	Implementation Issues	10
5	Performance Evaluation	10
5.1	Static Scenarios	12
5.1.1	Scalability Issues	12
5.1.2	Wireless Channel Fading Issue	13
5.2	Mobile Scenarios	14
5.2.1	Scalability Issue	14
5.2.2	Mobility Issue	16
6	Conclusion	17



Unité de recherche INRIA Sophia Antipolis
2004, route des Lucioles - BP 93 - 06902 Sophia Antipolis Cedex (France)

Unité de recherche INRIA Futurs : Parc Club Orsay Université - ZAC des Vignes
4, rue Jacques Monod - 91893 ORSAY Cedex (France)

Unité de recherche INRIA Lorraine : LORIA, Technopôle de Nancy-Brabois - Campus scientifique
615, rue du Jardin Botanique - BP 101 - 54602 Villers-lès-Nancy Cedex (France)

Unité de recherche INRIA Rennes : IRISA, Campus universitaire de Beaulieu - 35042 Rennes Cedex (France)

Unité de recherche INRIA Rhône-Alpes : 655, avenue de l'Europe - 38334 Montbonnot Saint-Ismier (France)

Unité de recherche INRIA Rocquencourt : Domaine de Voluceau - Rocquencourt - BP 105 - 78153 Le Chesnay Cedex (France)

Éditeur

INRIA - Domaine de Voluceau - Rocquencourt, BP 105 - 78153 Le Chesnay Cedex (France)

<http://www.inria.fr>

ISSN 0249-6399