



HAL
open science

On deterministic control problem : an approximation procedure for the optimal cost

Roberto L. Gonzalez, Edmundo Rofman

► **To cite this version:**

Roberto L. Gonzalez, Edmundo Rofman. On deterministic control problem : an approximation procedure for the optimal cost. RR-0151, INRIA. 1982. inria-00076409

HAL Id: inria-00076409

<https://inria.hal.science/inria-00076409>

Submitted on 24 May 2006

HAL is a multi-disciplinary open access archive for the deposit and dissemination of scientific research documents, whether they are published or not. The documents may come from teaching and research institutions in France or abroad, or from public or private research centers.

L'archive ouverte pluridisciplinaire **HAL**, est destinée au dépôt et à la diffusion de documents scientifiques de niveau recherche, publiés ou non, émanant des établissements d'enseignement et de recherche français ou étrangers, des laboratoires publics ou privés.

IRIA

CENTRE DE ROCQUENCOURT

Institut National
de Recherche
en Informatique
et en Automatique

Domaine de Voluceau
Rocquencourt
B.P. 105
78153 Le Chesnay Cedex
France
Tél. 954 90 20

Rapports de Recherche

N° 151

ON DETERMINISTIC CONTROL PROBLEM: AN APPROXIMATION PROCEDURE FOR THE OPTIMAL COST

**Roberto GONZALEZ
Edmundo ROFMAN**

Juillet 1982

ON DETERMINISTIC CONTROL PROBLEMS :
AN APPROXIMATION PROCEDURE FOR THE OPTIMAL COST

R. GONZALEZ^(*) and E. ROFMAN^(**)

ABSTRACT

We study deterministic optimal control problems having stopping time, continuous and impulse controls in each strategy.

We obtain the optimal cost -considered as the maximum element of a suitable set of subsolutions of the associated Hamilton-Jacobi equation- using an approximation method. A particular derivative discretization scheme is employed.

Convergence of approximate solutions is shown taking advantage of a discrete maximum principle which is also proved.

For the numerical solutions of approximate problems we use a method of relaxation type. The algorithm is very simple ; it can be run in computers of small central memory.

Finally we apply our results to a short-run model of energy production management.

(*) Electronic Department - University of ROSARIO - ARGENTINE (Partly supported by grant n° 9977/81 of CONICET, Argentine).

(**) INRIA, Domaine de Voluceau, 78153 LE CHESNAY CEDEX (France).

RESUME

On étudie le contrôle optimal déterministe de systèmes différentiels où l'on dispose du temps d'arrêt et des contrôles continus et impulsionnels pour chaque stratégie.

On obtient le coût optimal, considéré comme élément maximum d'un convenable ensemble de sous-solutions de l'équation de Hamilton-Jacobi associée, moyennant un procès d'approximation. Un schéma particulier pour les discrétisation des dérivées est utilisé.

La convergence des solutions approchées est montrée à l'appui d'un principe de maximum discrète dont la justification est donnée.

Pour la résolution numérique des problèmes approchés, on applique une méthode de type relaxation et on présente un algorithme computationnel très simple qui occupe très peu d'espace de mémoire.

Finalement on applique ces résultats à la solution du problème de gestion optimale à court terme d'un système de production d'énergie électrique.

INTRODUCTION

Previously [9], we have dealt with the numerical solution of some optimal deterministic problems using as basic tool of analysis the characterization (introduced in [7], [8]) of the optimal cost function as the maximum element of a suitable set of sub-solutions of the associated Hamilton-Jacobi equation. In this paper, to compute this maximum element, we present a new algorithm who makes possible to solve non-trivial problems in computers of small central memories.

In part I we study the stationary case.

In part I.1. is introduced a control problem with a cost function J to be minimized. We consider in each strategy stopping times, continuous and impulse control ; so $V(x) = \inf_{\tau, u(\cdot), z(\cdot)} J(x ; \tau, u(\cdot), z(\cdot))$. After defini-

tion of a fitted set W of subsolutions and following the same techniques used in [7], [8], [9] we characterize $V(x)$ as the unique solution of the equivalent problem (P) : Find the maximum element of the set W .

In I.2. we consider the discretized problem (P_h) , its solution (\bar{w}_h) , the algorithm to compute it and its properties. Using a particular scheme to discretize the partial derivatives of the functions in consideration we are enabled to define an algorithm that, iterative and successively, increases the values of these functions in the vertices of the triangulation employed, until the approximate solution \bar{w}_h is found.

In I.3. it is proved the convergence of \bar{w}_h to the solution $V(x)$ of (P). An estimation of the rate of convergence is given.

In part II we consider the non stationary case. In particular we give a solution to the problem of computing the optimal control of an electricity production system, applying the methodology described in this paper. Systems with a significant number of thermal generators may be optimized in this form.

I. THE STATIONARY PROBLEM

I.1. The optimal control problem and an equivalent formulation (the problem (P)).

To control a system with trajectories in an open bounded set $\Omega \in \mathbb{R}^n$ we use stopping time control, impulse control and continuous control.

In the intervals of time free of the action of impulse controls, the trajectory of the system satisfies the differential equation

$$\begin{cases} \frac{dy}{dt} = f(y, u) \\ y(0) = x \end{cases} \quad x \in \Omega \subset \mathbb{R}^n \quad (1.1)$$

where $u(\cdot)$ is a measurable function of time with values in a compact set $U \subset \mathbb{R}^m$.

At times θ_ν ($0 \leq \theta_1 < \theta_2 < \dots$) impulses $z(\theta_\nu)$ are applied; they produce jumps of amplitude g_ν in the trajectory of the system:

$$y(\theta_\nu^+) = y(\theta_\nu^-) + g(y(\theta_\nu^-), z(\theta_\nu)) \quad (1.2)$$

$y(\theta_\nu^+)$, $(y(\theta_\nu^-))$ is the right (left) limit of the trajectory $y(\cdot)$. The set Z of admissible impulse controls is a compact set of \mathbb{R}^p .

The control strategy is determined by the stopping time $\tau \geq 0$, the function $u(\cdot)$, the times $\{\theta_\nu\}$ and the impulses $\{z(\theta_\nu)\}$; it will be noted by $(\tau, u(\cdot), z(\cdot))$.

In the following we shall suppose that $\forall t, y(t) \in \Omega$.

We assign to each strategy of control the cost value J :

$$\begin{aligned}
J(x ; \tau, u(\cdot), z(\cdot)) &= \int_0^{\tau} e^{-\alpha s} \ell(y(s), u(s)) ds + \\
&+ \phi(y(\tau)) e^{-\alpha \tau} + \sum_{\nu} e^{-\alpha \theta_{\nu}} g(y(\theta_{\nu}^{-}), z(\theta_{\nu}))
\end{aligned} \tag{1.3}$$

being ℓ the instantaneous cost, ϕ the final cost, $\alpha > 0$ the instantaneous actualisation factor and $q > 0$ the cost of application of an impulse.

Our aim is to find the optimal cost function $V(x)$ defined by :

$$V(x) = \inf_{\tau, u(\cdot), z(\cdot)} J(x ; \tau, u(\cdot), z(\cdot)) \quad \forall x \in \Omega . \tag{1.4}$$

The characterization of $V(x)$ given in Theorem 1.2. concerns lipschitzean functions. So it is useful to recall the following result, which is easily obtained as a combination of those shown in [9] :

Theorem 1.1. (Lipschitzeannity of $V(x)$)

If the following hypothesis are verified :

- i) f, ℓ, ϕ, g, q are continuous and bounded functions (M_f, \dots, M_q being the bounds) ;
- ii) f, ℓ, ϕ, g, q are lipschitzean functions of y (L_f, \dots, L_q being the lipschitz constants) ;
- iii) $\alpha > L_f + \mu_{\delta} \ln \lambda_g$ (if $\lambda_g > 1$) or
 $\alpha > L_f$ (if $\lambda_g \leq 1$),

with

$$\lambda_g = \sup \left\{ \frac{\|x + g(x, z) - x' - g(x', z)\|}{\|x - x'\|} / x \neq x' ; x, x' \in \Omega, z \in Z \right\}$$

$$\mu_\delta = \frac{2 e(M_\ell + \alpha M_\phi)}{q_0}, \quad \mu_0 = \frac{2 e(M_\ell + \alpha M_\phi)}{\alpha q_0}, \quad q_0 = \inf_{\substack{x \in \Omega \\ z \in Z}} q(x, z) > 0$$

then $V(x)$ is a lipschitzian function, i.e.

$$|V(x) - V(x')| \leq L_V \|x - x'\| \quad \forall x, x' \in \Omega$$

being

$$L_V = L_\ell \lambda_g^{\mu_0} \frac{1}{\alpha - L_f - \mu_\delta \ln \lambda_g} + L_q \frac{e^{\frac{\alpha - L_f}{\alpha}}}{1 - \lambda_g e^{\frac{L_f - \alpha}{\mu_\delta}}} +$$

$$+ L_\phi \lambda_g^{\mu_0} \text{ if } \lambda_g > 1 \text{ or } \frac{\alpha - L_f}{\alpha}$$

$$L_V = L_\ell \frac{1}{\alpha - L_f} + L_q \frac{e^{\frac{\alpha - L_f}{\alpha}}}{1 - \lambda_g e^{\frac{L_f - \alpha}{\mu_\delta}}} + L_\phi \text{ if } \lambda_g \leq 1. \quad \square$$

As a consequence $V(x)$ is a.e. differentiable in Ω . Using the techniques of dynamic programming is possible to show (cf[9]) that $V(x)$ is a solution of the Hamilton-Jacobi inequality associated to the optimal control problem, i.e.

$$\min_{u \in U} \left(\frac{\partial V(x)}{\partial x} \cdot f(x, u) + \ell(x, u) - \alpha V(x) \right) \geq 0 \quad x \text{ a.e. in } \Omega \quad (1.5)$$

$$V(x) - \min_{z \in Z} (V(x + g(x, z)) + q(x, z)) \leq 0 \quad \forall x \in \Omega \quad (1.6)$$

$$V(x) - \phi(x) \leq 0 \quad \forall x \in \Omega \quad (1.7)$$

For all x of differentiability, $V(x)$ verifies the equality in one at least of the precedents (1.5), (1.6), (1.7) (1.8)

Following the technique used in [7], [8] we have proved in [9] the

Theorem 1.2. (Characterization of $V(x)$)

Let be

$$W = \{w : \Omega \rightarrow \mathbb{R} / (1.10), (1.11), (1.12), (1.13)\} \quad (1.9)$$

where

$$w \text{ is a lipshitzean function} \quad (1.10)$$

$$\min_{u \in U} \left(\frac{\partial w(x)}{\partial x} \cdot f(x, u) + l(x, u) - \alpha w(x) \right) \geq 0, \text{ a.e. } x \in \Omega \quad (1.11)$$

$$w(x) - \min_{z \in Z} (w(x + g(x, z)) + q(x, z)) \leq 0, \forall x \in \Omega \quad (1.12)$$

$$w(x) \leq \phi(x) \quad \forall x \in \Omega ; \quad (1.13)$$

then $V(x)$ is the maximum element of the set (1.9) i.e. $V(x) \in W$ and

$$V(x) \geq w(x), \forall x \in \Omega, \forall w \in W. \quad \square \quad (1.14)$$

Clearly Theorem 1.2. makes possible to find the optimal cost function defined in (1.4) solving the equivalent problem

(P) : find the maximum element of the set \hat{W} defined by (1.9).

1.2. The discretized problem (P_h)

2.0 Preliminary comments

In this chapter I.2. we shall introduce sets W^h , finite dimensional approximations of W , looking for a numerical derive to compute $V(x)$. Following this idea, after a discretization Ω^h of the set Ω , we shall define W^h by functions w^h verifying properties related to (1.10)-(1.13). The main difficulty of this approach is the choice of W^h having maximum element w^h .

In fact, after introducing in W^h the natural partial order :

$$w_1 \leq w_2 \iff w_1(x_i^h) \leq w_2(x_i^h) \quad \forall x_i^h \text{ vertex of } \Omega^h \quad (2.1)$$

it is not possible, in general, to insure the existence of \bar{w}^h . We show in what follows, that thanks to a criterion used in the discretization of the derivatives that appear in (1.11) (see (2.3)) we obtain :

- a) the existence of an unique maximal element in W^h ; furthermore , this maximal element is also the maximum element \bar{w}^h ,
- b) a characterization of \bar{w}^h that enables us to compute it with an iterative algorithm of relaxation type.

2.1 The discretization procedure

- a) the set Ω is approximated with a triangulation Ω^h (union of simplices)

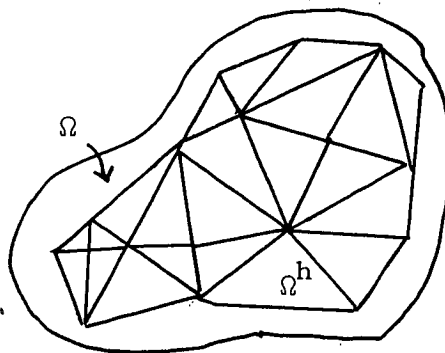

FIGURE 1

- b) we consider, in place of W , the set W^h of functions $w^h : \bar{\Omega}^h \rightarrow \mathbb{R}$, w^h continuous in Ω^h , $\frac{\partial w^h}{\partial x}$ constant in the interior of each simplex of Ω^h (i.e. w^h are linear finite elements) satisfying $\forall x_i^h$ vertex of Ω^h the restrictions (2.2), (2.4), (2.5), (discretization of (1.11), (1.12), (1.13) :

$$\frac{\partial w^h}{\partial x_f}(x_i^h; u) \cdot \|f(x_i^h, u)\| + \ell(x_i^h, u) - \alpha w^h(x_i^h) \geq 0 \quad (2.2)$$

$\forall u \in U^h \in U$, finite set that approximates the set of admissible continuous controls U .

With $\frac{\partial w^h}{\partial x_f}(x_i^h; u)$ we denote the derivative of w^h in the direction of f , more precisely (see Figure 2) :

$$\left\{ \begin{array}{l} \frac{\partial w^h}{\partial x_f}(x_i^h; u) \cdot \|f(x_i^h, u)\| = \frac{w^h(a_i(u)) - w^h(x_i^h)}{\|a_i(u) - x_i^h\|} \cdot \|f(x_i^h, u)\|, \\ \text{if } f(x_i^h, u) \neq 0; \\ \frac{\partial w^h}{\partial x_f}(x_i^h; u) \cdot \|f(x_i^h, u)\| = 0 \text{ if } f(x_i^h, u) = 0 \end{array} \right. \quad (2.3)$$

$$w^h(x_i^h) \leq w^h(x_i^h + g(x_i^h, z)) + q(x_i^h, z), \quad \forall z \in Z^h \subset Z \quad (2.4)$$

with Z^h finite set that approximates the set of admissible impulse controls Z ;

$$w^h(x_i^h) \leq \phi(x_i^h) \quad (2.5)$$

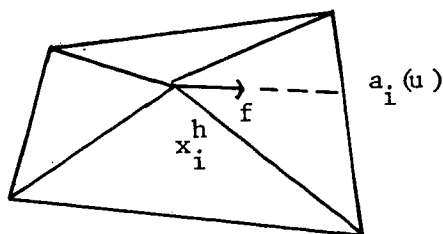

FIGURE 2

c) We introduce the problem (P_h) , discretization of problem (P) :

(P_h) : Find the maximum element \bar{w}^h of the set W^h considering in W^h the partial order (2.1).

d) Remarks to point b)

d₁) We suppose that always $x_i^h + g(x_i^h, z) \in \Omega^h$ in order to insure that (2.4) has sense.

d₂) If D is the diameter of a simplex, $\exists \gamma_1 > 0 / \forall$ simplex of Ω^h there exists a sphere of radius $r \geq \gamma_1 D$ in the interior of the simplex.

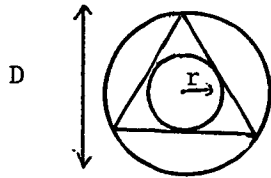

FIGURE 3

d₃) Denoting with $\|h\|$ the maximum of the diameters of the simplices of Ω^h , the sets U^h and Z^h approach the sets U and Z in the following sense :

$$U^h \subset U, Z^h \subset Z,$$

$$\|h\| \leq \|h'\| \Rightarrow U^{h'} \subset U^h, Z^{h'} \subset Z^h$$

$$\bigcup_h U_h = U, \quad \bigcup_h Z_h = Z$$

2.2. Existence of solution of problem (P_h)

In the set W^h is defined a partial order ; in consequence we can speak of maximal elements but, as it was said before, it is not obvious, a priori, the existence of a maximum element. To prove the point a) of 2.0. we will previously transform the restrictions (2.2) and (2.4) in more useful equivalent relations (2.2)' and (2.4)'.

Considering that $a_i(u)$ and $x_i^h + g(x_i^h, z)$ are linear convex combinations of the simplices to whom they belong, we have :

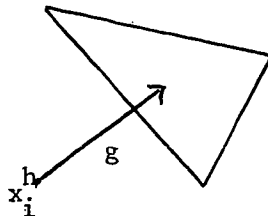

FIGURE 4

$$a_i(u) = \sum_{j=1}^{n_h} \lambda_j(x_i^h, u) \cdot x_j^h, \lambda_j \geq 0, \sum_{j=1}^{n_h} \lambda_j = 1 \quad (2.6)$$

$$x_i^h + g(x_i^h, z) = \sum_{j=1}^{n_h} \lambda'_j(x_i^h, z) \cdot x_j^h, \lambda'_j \geq 0, \sum_{j=1}^{n_h} \lambda'_j = 1$$

Being w^h an affine function, (2.2) and (2.4) are equivalent to :

$$w^h(x_i^h) \leq \min_{u \in U^h} [\beta_1(x_i^h, u) \sum_{j=1}^{n_h} \lambda_j(x_i^h, u) \cdot w^h(x_j^h) + \beta_2(x_i^h, u) \ell(x_i^h, u)] \quad (2.2)'$$

$$w^h(x_i^h) \leq \min_{z \in Z^h} [\sum_{j=1}^{n_h} \lambda'_j(x_i^h, z) \cdot w^h(x_j^h) + q(x_i^h, z)] \quad (2.4)'$$

where

$$\left\{ \begin{array}{l} \beta_1(x_i^h, u) = 0 \quad \text{if } f(x_i^h, u) = 0 \\ \beta_1(x_i^h, u) = \frac{\|f(x_i^h, u)\|}{\|f(x_i^h, u)\| + \alpha \|a_i(u) - x_i^h\|}, \text{ if } f(x_i^h, u) \neq 0. \end{array} \right.$$

$$\left\{ \begin{array}{l} \beta_2(x_i^h, u) = \frac{1}{\alpha} \quad \text{if } f(x_i^h, u) = 0 \\ \beta_2(x_i^h, u) = \frac{\|a_i(u) - x_i^h\|}{\|f(x_i^h, u)\| + \alpha \|a_i(u) - x_i^h\|}, \text{ if } f(x_i^h, u) \neq 0. \end{array} \right.$$

So, we can now consider W^h as the set of linear finite elements on Ω^h satisfying (2.2)', (2.4)', (2.5), and we can pass to

Theorem 2.1. : There exists \bar{w}^h , maximum element of W^h .

Proof

Let be

$$\hat{w}^h(x_i^h) = \sup \{w^h(x_i^h) / w^h \in W^h\} \quad (2.7)$$

\hat{w}^h is well defined by virtue of (2.5). From (2.5), (2.7) it follows that \hat{w}_h verifies (2.5).

In (2.2)', (2.4)' the factors that multiply $w^h(x_j^h)$ are non-negative ; then by virtue of (2.2)' and (2.7) we have :

$$w^h(x_i^h) \leq \min_{u \in U^h} [\beta_1(x_i^h, u) \cdot \sum_{j=1}^{n_h} \lambda_j(x_i^h, u) \hat{w}^h(x_j^h) + \beta_2(x_i^h, u) \ell(x_i^h, u)],$$

and taking into account (2.7) :

$$\hat{w}^h(x_i^h) \leq \min_{u \in U^h} (\beta_1(x_i^h, u) \cdot \sum_{j=1}^{n_h} \lambda_j(x_i^h, u) \cdot \hat{w}^h(x_j^h) + \beta_2(x_i^h, u) \ell(x_i^h, u))$$

i.e. \hat{w}^h verifies (2.2)'. In a similar way it is proved that \hat{w}^h verifies (2.4)' and in consequence $\hat{w}^h \in W^h$. Now, by virtue of (2.7), \hat{w}_h is the maximum element of W^h , i.e. $\hat{w}^h = \bar{w}^h$.

2.3 Characterization of the maximum element \bar{w}^h

We define the operator $M : \mathbb{R}^{n_h} \rightarrow \mathbb{R}^{n_h}$ in the following form :

$$(Mw^h)(x_i^h) = \min \left\{ \min_{u \in U^h} [\beta_1(x_i^h, u) \cdot \sum_{j=1}^{n_h} \lambda_j(x_i^h, u) \cdot w^h(x_j^h) + \beta_2(x_i^h, u) \ell(x_i^h, u)] , \right. \\ \left. \min_{z \in Z^h} \left[\sum_{j=1}^{n_h} \lambda_j(x_i^h, z) w^h(x_j^h) + q(x_i^h, z) \right], \phi(x_i^h) \right\} \quad (2.8)$$

and we obtain the following characterization of \bar{w}^h :

Theorem 2.2. \bar{w}^h is the maximum element of W^h if and only if $\bar{w}^h \equiv M \bar{w}^h$ (i.e. if and only if $\forall x_i^h \in \Omega^h$ one at least of (2.2)' (2.4)', (2.5) is an equality).

a) Proof of the necessary condition

Let be \bar{w}^h the maximum element of W^h and suppose that $\exists i_0, \varepsilon > 0/$

$$\bar{w}^h(x_{i_0}^h) + \varepsilon \leq (M \bar{w}^h)(x_{i_0}^h). \quad (2.9)$$

$$\text{We define } \begin{cases} \bar{w}^h(x_i^h) = \bar{w}^h(x_i^h), \forall i \neq i_0, \\ \bar{w}^h(x_{i_0}^h) = \bar{w}^h(x_{i_0}^h) + \varepsilon. \end{cases} \quad (2.10)$$

Then, by virtue of (2.9) and the monotony of M , we obtain

$$\begin{cases} \bar{w}^h(x_i^h) = \bar{w}^h(x_i^h) \leq (M \bar{w}^h)(x_i^h) = (M \bar{w}^h)(x_i^h), \forall i \neq i_0 \\ \bar{w}^h(x_{i_0}^h) \leq (M \bar{w}^h)(x_{i_0}^h) \leq (M \bar{w}^h)(x_{i_0}^h). \end{cases}$$

In consequence $\bar{w}^h \in W^h$ and by (2.10), $\bar{w}^h > \bar{w}^h$; this contradiction has the origin in (2.9). So $\bar{w}^h(x_i^h) = M \bar{w}^h(x_i^h) \forall i$, i.e. $\bar{w}^h \equiv M \bar{w}^h$.

For the proof of the sufficient condition we will introduce the following

Lemma 2.1. DISCRETE MAXIMUM PRINCIPLE

Let be C^h a subset of vertices of Ω^h and S^h its complementary. If $\forall x_i \in C^h$

$$\min_{u \in U_i^h} \left(\frac{\partial w^h}{\partial x_i^h} (x_i^h; u) \cdot \|f(x_i^h, u)\| + \ell(x_i^h, u) - \alpha w^h(x_i^h) \right) \geq 0 \quad (2.11)$$

then, there exists γ , $0 < \gamma < 1$ such that

$$\max_{x_i^h \in C^h} w^h(x_i^h) \leq \gamma [\max_{x_j^h \in S^h} w^h(x_j^h) \vee 0] + \frac{1}{\alpha} [\max_{\substack{x_i^h \in C^h \\ u \in U_i^h}} \ell(x_i^h, u) \vee 0] \quad (2.12)$$

Proof

We rewrite (2.11) in its equivalent form (2.2)' :

$$w^h(x_i^h) \leq \min_{u \in U_i^h} \left(\beta_j(x_i^h, u) \sum_{j=1}^n \lambda_j(x_i^h, u) w^h(x_j^h) + \beta_2(x_i^h, u) \ell(x_i^h, u) \right) \quad (2.13)$$

Let be $x_{i_0}^h \in C^h$ such that

$$w^h(x_{i_0}^h) = \max_{x_i^h \in C^h} (w^h(x_i^h)) = M_{C^h}^h ;$$

we denote

$$M_{S^h}^+ = \max_{x_j^h \in S^h} (w^h(x_j^h) \vee 0), \quad M_{\ell}^+ = \max_{\substack{x_j^h \in C^h \\ u \in U_i^h}} (\ell(x_j^h, u) \vee 0) \quad (2.14)$$

and we have $\forall u \in U_{i_0}^h$ from (2.13) :

$$\begin{aligned} M_{C^h}^h = w^h(x_{i_0}^h) &\leq \beta_1(x_{i_0}^h, u) \left(\sum_{j/x_j^h \in C^h} \lambda_j(x_{i_0}^h, u) M_{C^h}^h + \right. \\ &\quad \left. + \sum_{j/x_j^h \in S^h} \lambda_j(x_{i_0}^h, u) M_{S^h}^+ \right) + \beta_2(x_{i_0}^h, u) M_{\ell}^+ . \end{aligned} \quad (2.15)$$

After putting $\lambda^C(x_{i_0}^h, u) = \sum_{j/x_j^h \in C^h} \lambda_j(x_{i_0}^h, u)$ we obtain

$\sum_{j/x_j \in S^h} \lambda_j(x_{i_0}^h, u) = 1 - \lambda^C(x_{i_0}^h, u)$; so we can rewrite

(2.15) as follows :

$$M_{C^h} \leq \left. \begin{aligned} & \frac{\beta_1(x_{i_0}^h, u)(1 - \lambda^C(x_{i_0}^h, u))}{1 - \beta_1(x_{i_0}^h, u) \lambda^C(x_{i_0}^h, u)} M_{S^h}^+ + \frac{\beta_2(x_{i_0}^h, u) M_{\ell}^+}{1 - \beta_1(x_{i_0}^h, u) \lambda^C(x_{i_0}^h, u)} \end{aligned} \right\} \quad (2.16)$$

$\forall u \in U_{i_0}^h$.

As $0 \leq \beta < 1$, $0 \leq \lambda^C \leq 1$ we have

$$\frac{\beta_1(x_{i_0}^h, u)(1 - \lambda^C(x_{i_0}^h, u))}{1 - \beta_1(x_{i_0}^h, u) \lambda^C(x_{i_0}^h, u)} \leq \beta_1(x_{i_0}^h, u),$$

$$\frac{1}{1 - \beta_1(x_{i_0}^h, u) \lambda^C(x_{i_0}^h, u)} \leq \frac{1}{1 - \beta_1(x_{i_0}^h, u)} ;$$

so, (2.16) say us that

$$M_{C^h} \leq \beta_1(x_{i_0}^h, u) M_{S^h}^+ + \frac{\beta_2(x_{i_0}^h, u)}{1 - \beta_1(x_{i_0}^h, u)} M_{\ell}^+, \quad \forall u \in U_{i_0}^h ; \quad (2.17)$$

but, taking in account the definition of β_1, β_2 :

$$\frac{\beta_2(x_{i_0}^h, u)}{1 - \beta_1(x_{i_0}^h, u)} = \frac{1}{\alpha}.$$

Furthermore, always from the definition of β_1 , it is $\forall x_i^h$,
 $0 \leq \beta_1(x_i^h, u) < 1$; so $\exists 0 < \gamma < 1 / \forall x_i^h, \forall u \in U_i^h, \beta_1(x_i^h, u) \leq \gamma$.

Using this relations in (2.17) we obtain (2.12). \square

Remarks to Lemma 2.1.

.) As $0 < \gamma < 1$ is also truth :

$$M_C^h \leq M_S^+ + \frac{1}{\alpha} M_\ell^+ \quad (2.18)$$

.) If $\forall x_i^h \in C^h, \forall u \in U_i^h, \ell(x_i^h, u) = 0$, then

$$M_C^h \leq \gamma M_S^+ \quad (2.19)$$

.) Even if γ is independent of x_i^h and u , it depends of the triangulation Ω_h . We could put it in evidence noting $\gamma = \gamma(h) < 1$.

.) In the proof we have suppose the set of controls U^h depending of x_i^h ; for that we have denote U_i^h this set.

We can now pass to the

b) Proof of the sufficient condition

Let be w^h an arbitrary element of W^h and \bar{w}^h such that $\bar{w}^h \equiv M w^h$. We define :

$$\tilde{w}(x_i^h) = w^h(x_i^h) - \bar{w}(x_i^h), \forall x_i^h \in \Omega^h \quad (2.20)$$

and a partition of the vertices of Ω^h in three disjoint sets :

$$S^h = \{x_j^h / \bar{w}(x_j^h) = \phi(x_j^h)\} \quad (2.21)$$

$$I^h = \{x_i^h \notin S^h / \bar{w}(x_i^h) = \min_{z \in Z^h} \{q(x_i^h, z) + \sum_j \lambda_j^!(x_i^h, z) \bar{w}(x_j^h)\}\} \quad (2.22)$$

$$C^h = \{x_i^h \notin I^h \cup S^h / \bar{w}(x_i^h) = \min_{u \in U^h} \{\beta_1(x_i^h, u) \sum_j \lambda_j(x_i^h, u) \bar{w}(x_j^h) + \beta_2(x_i^h, u) \cdot \ell(x_i^h, u)\}\} \quad (2.23)$$

Remark : From the definition of M and the hypothesis $\bar{w}^h = M \bar{w}^h$ we have

$$\Omega^h = S^h \cup I^h \cup C^h.$$

From (2.5) and (2.21) we obtain

$$w^h(x_i^h) \leq \bar{w}^h(x_i^h) = \phi(x_i^h), \quad \forall x_i^h \in S^h$$

To achieve our proof we need similar inequalities in C^h and I^h .

Let be \bar{u}_i^h a control for which equality (2.23) holds. So (we use the equivalent form (2.2))

$$\frac{\partial \bar{w}^h}{\partial x_f^h}(x_i^h, \bar{u}_i^h) \cdot ||f(x_i^h, \bar{u}_i^h)|| + \ell(x_i^h, \bar{u}_i^h) - \alpha \bar{w}^h(x_i^h) = 0, \quad \forall x_i^h \in C^h;$$

but, as $w^h \in W^h$, is

$$\frac{\partial w^h}{\partial x_f^h}(x_i^h, \bar{u}_i^h) \cdot ||f(x_i^h, \bar{u}_i^h)|| + \ell(x_i^h, \bar{u}_i^h) - \alpha w^h(x_i^h) \geq 0 \quad \forall x_i^h \in \Omega^h$$

we have, $\forall x_i^h \in C^h$:

$$\frac{\partial \bar{w}^h}{\partial x_f^h}(x_i^h, \bar{u}_i^h) \cdot ||f(x_i^h, \bar{u}_i^h)|| - \alpha \bar{w}^h(x_i^h) \geq 0 \quad (2.25)$$

We can now to apply the lemma 2.1 with C^h given by (2.23), $S^h \cup I^h$ as its complementary and $U_i^h = \{\bar{u}_i^h\}$. (2.12), (2.19), (2.24) say us that $\exists \gamma, 0 < \gamma < 1$ such that

$$\begin{aligned} \min_{x_i^h \in C^h} \tilde{w}(x_i^h) &\leq \gamma [\max_{x_i^h \in S^h} \tilde{w}(x_i^h) \vee \max_{x_i^h \in I^h} \tilde{w}(x_i^h)]^+ \leq \\ &\leq \gamma \max_{x_i^h \in I^h} \tilde{w}(x_i^h) \vee 0. \end{aligned} \quad (2.26)$$

On the other hand, let be \bar{z}_i^h an impulse control s for which (2.22) holds :

$$\bar{w}^h(x_i^h) = q(x_i^h, \bar{z}_i^h) + \sum_j \lambda_j^!(x_i^h, \bar{z}_i^h) \bar{w}^h(x_j^h), \forall x_i^h \in I^h. \quad (2.27)$$

As before, being $w^h \in W^h$ we have in \bar{z}_i^h :

$$w^h(x_i^h) \leq q(x_i^h, \bar{z}_i^h) + \sum_j \lambda_j^!(x_i^h, \bar{z}_i^h) w^h(x_j^h), \forall x_i^h \in \Omega^h;$$

in consequence

$$\bar{w}^h(x_i^h) \leq \sum_j \lambda_j^!(x_i^h, \bar{z}_i^h) \bar{w}^h(x_j^h), \forall x_i^h \in I^h. \quad (2.28)$$

Looking for an upper bound of $\max_{x_i^h \in I^h} \bar{w}^h(x_i^h)$ we shall introduce the set of indices

$$I_M^h = \{x_i^h \in I^h / \bar{w}^h(x_i^h) = \max_{x_j^h \in I^h} \bar{w}^h(x_j^h)\}$$

and the vertex

$$x_{i_0}^h / \bar{w}^h(x_{i_0}^h) = \min_{x_i^h \in I_M^h} \bar{w}^h(x_i^h).$$

As $x_{i_0}^h \in I_h$ we have, after (2.27)

$$\begin{aligned} \bar{w}^h(x_{i_0}^h) &= q(x_{i_0}^h, \bar{z}_{i_0}^h) + \sum_{j/x_j^h \in I^h} \lambda_j^!(x_{i_0}^h, \bar{z}_{i_0}^h) \bar{w}^h(x_j^h) + \\ &+ \sum_{j/x_j^h \notin I^h} \lambda_j^!(x_{i_0}^h, \bar{z}_{i_0}^h) \bar{w}^h(x_j^h). \end{aligned} \quad (2.29)$$

We will suppose that

$$\lambda_j^!(x_{i_0}^h, \bar{z}_{i_0}^h) = 0 \quad \forall j / x_j^h \notin I_h. \quad (2.30)$$

In this case (2.28) shows that

$$\tilde{w}^h(x_{i_0}^h) \leq \sum_{j/x_j^h \in I^h} \lambda_j^!(x_{i_0}^h, z_{i_0}^{-h}) \tilde{w}^h(x_j^h). \quad (2.31)$$

As $x_{i_0}^h \in I_M^h$, (2.31) gives

$$\tilde{w}^h(x_{i_0}^h) \leq \lambda_j^!(x_{i_0}^h, z_{i_0}^{-h}) \tilde{w}^h(x_j^h) + \sum_{k \neq j; k/x_k^h \in I^h} \lambda_k^!(x_{i_0}^h, z_{i_0}^{-h}) \tilde{w}^h(x_k^h).$$

$$\text{As } \sum_{\substack{i \neq j \\ k/x_k^h \in I^h}} \lambda_k^!(x_{i_0}^h, z_{i_0}^{-h}) = 1 - \lambda_j^!(x_{i_0}^h, z_{i_0}^{-h})$$

we obtain

$$\tilde{w}^h(x_{i_0}^h) \lambda_j^!(x_{i_0}^h, z_{i_0}^{-h}) \leq \lambda_j^!(x_{i_0}^h, z_{i_0}^{-h}) \tilde{w}^h(x_j^h)$$

which implies,

$$\forall j / \lambda_j^!(x_{i_0}^h, z_{i_0}^{-h}) \neq 0, \tilde{w}^h(x_j^h) = \tilde{w}^h(x_{i_0}^h) \quad \text{i.e. } x_j^h \in I_M^h.$$

If we use this result in (2.29), (2.30) taking with account the definition of $x_{i_0}^h$, we have

$$\begin{aligned} \bar{w}^h(x_{i_0}^h) &= q(x_{i_0}^h, z_{i_0}^{-h}) + \sum_{j/x_j^h \in I_M^h} \lambda_j^!(x_{i_0}^h, z_{i_0}^{-h}) \bar{w}^h(x_j^h) \geq \\ &\geq q(x_{i_0}^h, z_{i_0}^{-h}) + \bar{w}^h(x_{i_0}^h) \end{aligned}$$

i.e. $q(x_{i_0}^h, z_{i_0}^{-h}) \leq 0$ in contradiction with our initial hypothesis $q > 0$

(see '1.3)).

This contradiction has origin in supposition (2.30). Then there exists at least a vertex $x_j^h \notin I_h$ such that $\lambda_j^!(x_{i_0}^h, z_{i_0}^{-h}) > 0$.

We return to (2.28) and we have

$$\begin{aligned} \tilde{w}(x_{i_0}^h) &\leq \sum_{j/x_j \in I_h} \lambda_j^!(x_{i_0}^h, \bar{z}_{i_0}^h) \cdot \tilde{w}^h(x_j^h) + \sum_{j/x_j \notin I_h} \lambda_j^!(x_{i_0}^h, \bar{z}_{i_0}^h) \cdot \tilde{w}^h(x_j^h) \leq \\ &\leq \left(\sum_{j/x_j \in I_h} \lambda_j^!(x_{i_0}^h, \bar{z}_{i_0}^h) \right) \tilde{w}^h(x_{i_0}^h) + \left(\sum_{j/x_j \notin I_h} \lambda_j^!(x_{i_0}^h, \bar{z}_{i_0}^h) \right) \max_{x_j^h \in C^h \cup S^h} \tilde{w}^h(x_j^h), \end{aligned}$$

and, as

$$1 - \sum_{j/x_j \in I^h} \lambda_j^!(x_{i_0}^h, \bar{z}_{i_0}^h) = \sum_{j/x_j \notin I^h} \lambda_j^!(x_{i_0}^h, \bar{z}_{i_0}^h) > 0,$$

we obtain

$$\begin{aligned} \max_{x_j^h \in I^h} \tilde{w}(x_j^h) = \tilde{w}^h(x_{i_0}^h) &\leq \max_{x_j^h \in C^h \cup S^h} \tilde{w}(x_j^h) \leq \\ &\leq \left(\max_{x_j^h \in C^h} \tilde{w}^h(x_j^h) \right) \vee 0. \end{aligned} \tag{2.32}$$

So, after (2.24), (2.32), if \tilde{w}^h has a positive maximum will follow that $\max_{x_j^h \in C^h} \tilde{w}^h(x_j^h) > 0$. But from (2.26), (2.32) :

$$\max_{x_i^h \in C^h} \tilde{w}^h(x_i^h) \leq \gamma \max_{x_j^h \in I^h} \tilde{w}^h(x_j^h) \vee 0 \leq \gamma \max_{x_j^h \in C^h} \tilde{w}^h(x_j^h) \vee 0. \tag{2.33}$$

Then, if $\max_{x_j^h \in C^h} \tilde{w}^h(x_j^h) > 0$ we have in (2.33)

$$(1 - \gamma) \max_{x_j^h \in C^h} \tilde{w}^h(x_j^h) \leq 0$$

$$\text{i.e. } \max_{x_j^h \in C^h} \tilde{w}^h(x_j^h) \leq 0$$

in contradiction with our previous supposition.

We conclude $\tilde{w}^h(x_i^h) \leq 0 \quad \forall x_i^h \in \Omega^h$, i.e.

$$\bar{w}^h(x_i^h) \geq w^h(x_i^h) \quad \forall x_i^h \in \Omega^h.$$

As w^h is an arbitrary element of W^h , the sufficient condition is proved.

2.4. Algorithm to compute \bar{w}^h

We will take advantage of the characterization of \bar{w}^h given in Theorem 2.2 to define an algorithm generating an increasing sequence of functions w_{ν}^h , convergent to a function satisfying $Mw^h = w^h$, i.e., convergent to \bar{w}^h .

Algorithm :

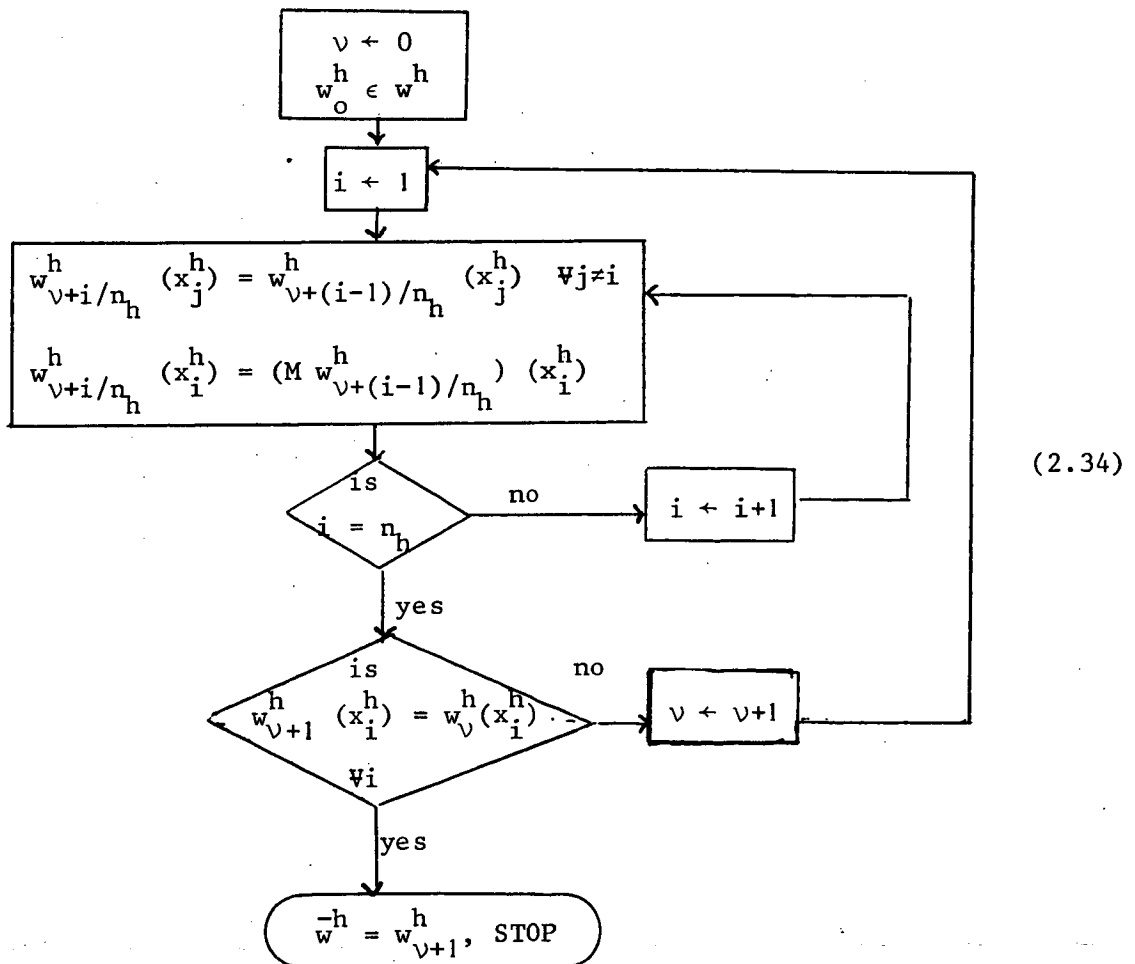

This algorithm gives the solution of problem (P_h) in the following sense :

Theorem 2.3.

The algorithm finishes at \bar{w}^{-h} in a finite number of steps or generates a sequence $\{w_v^h\}$ convergent to \bar{w}^{-h} .

Proof

If the algorithm finishes in a finite number of steps (\bar{v}) that means $w_{\bar{v}}^h$ is not modified in the last loop, i.e. $w_{\bar{v}}^h(x_i^h) = M w_{\bar{v}}^h(x_i^h)$, $\forall i$; then, by virtue of Theorem 2.2, $w_{\bar{v}}^h = \bar{w}^{-h}$.

If this is not the case, being $w_0^h \in W^h$, it results by induction :

$$w_{v+1/n_h}^h \leq W^h \text{ and } w_v^h \leq \dots \leq w_{v+(i-1)/n_h}^h \leq w_{v+i/n_h}^h \dots \leq \\ \leq w_{v+1}^h \leq \dots \leq \phi ;$$

$$\text{then, } \exists w^{vh} / \lim_{v \rightarrow \infty} w_{v+i/n_h}^h = w^{vh}, \forall i = 1, \dots, n_h . \quad (2.35)$$

We remark that by definition of the operator M we have $w^h \in W^h \iff w^h \leq M w^h$; $w^h \leq \tilde{w}^h \iff M w^h \leq M \tilde{w}^h$; hence, as (2.34) imposes $w_{v+i/n_h}^h(x_i^h) = M w_{v+(i-1)/n_h}^h(x_i^h)$, from (2.35) we obtain $w^{vh}(x_i^h) = M w^{vh}(x_i^h)$

i.e. by theorem 2.2, $\lim_{v \rightarrow \infty} w_v^h = \bar{w}^{-h}$. \square

Remarks to (2.34)

a) The algorithm needs only the values of the functions $w_{v+(i-1)/n_h}^h$ at the points $a_i(x)$ and $x_i^h + g(x_i^h, z)$ to compute $w_{v+i/n_h}^h(x_i^h)$.

Then, in general, it is only necessary to have in the central memory of the computer the values of $w_{v+(i-1)/n_h}^h(x_j^h)$ for a little number of vertices x_j^h . This property allows the application of this algorithm in computers with small central memories (minicomputers).

b) As theorem 2.3. shows the convergence of the algorithm does not depend of the order of the vertices x_j^h of the triangulation Ω^h ; however a careful choice of that order may allows;

1° An easy retrieval of the information needed for the computation, from the masive memory to the central memory of the computer.

2° An acceleration of the convergence of the algorithm.

c) The algorithm implies the saturation of at least one of the restrictions (2.2)', (2.4)', (2.5) in each iteration. In practice, the convergence will not be lost if that saturation is omitted in some steps.

I.3. CONVERGENCE OF DISCRETE SOLUTIONS $\bar{w}^h(x)$ TO THE OPTIMAL COST FUNCTIONS $V(x)$

3.0. Preliminary comments

The result will be achieved with a two steps work. In the first step we will reduce ourselves to consider only stopping time problems (P_S).

$V_S(x)$ will be, in this case, our optimal cost function and to show

$V_S(x) \leq \lim_{||h|| \rightarrow 0} \bar{w}^h(x)$ we introduce the same techniques used in [9]. But

the Discrete Maximum Principle will be essential to show $V_S(x) \geq \overline{\lim}_{||h|| \rightarrow 0} \bar{w}^h(x)$.

Furthermore, this DMP gives implicitly the stability of the method.

In a second step we consider the original problem (P), with intervention of continuous and impulse controls. We introduce a suitable sequence of stopping-time problems able to define a sequence of solutions convergent to $V(x)$.

3.1. Convergence in stopping time problems (P_S)

In the dynamics (1.1) of the system

$$\left\{ \begin{array}{l} \frac{dy}{dt} = f(y, u) \\ y(0) = x \end{array} \right. \quad (3.1)$$

we consider a constant value of $u \in U$ and we look for

$$V_S(x) = \inf_{0 \leq \theta} \int_0^\theta e^{-\alpha s} \ell(y(s), u) ds + e^{-\alpha \theta} \psi(y(\theta)) \quad (3.2)$$

If we suppose ψ lipschitzean (L_ψ its Lipschitz constant) we obtain following what it was done in Theorem 1.1 and Theorem 1.2 that $V_S(x)$ is lipschitzean ($L_S = \frac{L_\ell}{\alpha - L_f} + L_\psi$) and it is the maximum element of the set :

$$W_S = \{w : \Omega \rightarrow \mathbb{R} / (3.4), (3.5), (3.6)\} \quad (3.3)$$

$$w(x) \text{ is lipschitzean} \quad (3.4)$$

$$\frac{\partial w(x)}{\partial x} \cdot f(x, u) + \ell(x, u) - \alpha w(x) \geq 0 \quad (3.5)$$

$$w(x) \leq \psi(x) \quad \forall x \in \Omega \quad (3.6)$$

As in 2.1 we introduce the discretization procedure and we put the approximate problem (over the same triangulations of problem (P^h)) :

$$(P_S^h) : \text{Find the maximum element } \bar{w}_S^h \text{ of the set} \quad (3.7)$$

$$W_S^h = \{w^h : \Omega^h \rightarrow \mathbb{R} / (3.8), (3.9), (3.10)\}$$

$$w^h \text{ is a linear finite element characterized by the values } w^h(x_i^h) \quad (3.8)$$

$$\frac{\partial w^h}{\partial x_f}(x_i^h; u) \cdot \|f(x_i^h, u)\| + \ell(x_i^h, u) - \alpha w^h(x_i^h) \geq 0 \quad (3.9)$$

$$\forall x_i^h \text{ vertex of } \Omega^h$$

$$w^h(x_i^h) \leq \psi(x_i^h), \quad \forall x_i^h \text{ vertex of } \Omega^h. \quad (3.10)$$

Similarly to what it was done in 2.2 we show that (P_S^h) has an unique solution \bar{w}_S^h given by

$$\begin{aligned} \bar{w}_S^h(x_i^h) = \min & (\psi(x_i^h), \beta_1(x_i^h, u) \sum_j \lambda_j(x_i^h, u) \cdot \bar{w}_S^h(x_j^h) + \\ & + \beta_2(x_i^h, u) \cdot \ell(x_i^h, u)) \end{aligned} \quad (3.11)$$

with the equivalent relation of (3.9) :

$$\begin{aligned} w^h(x_i^h) \leq & \beta_1(x_i^h, u) \cdot \sum_j \lambda_j(x_i^h, u) \cdot w^h(x_j^h) + \beta_2(x_i^h, u) \ell(x_i^h, u), \\ & \forall x_i^h \in \Omega^h. \end{aligned} \quad (3.12)$$

To show the uniform convergence of \bar{w}_S^h to V_S we introduce three hypothesis ;

H₁) There exists an open set containing $\bar{\Omega}$ for which it is possible to give continuous prolongations of $f(x, u)$ and $\ell(x, u)$ in such a way that the lipschitzianity of f and ℓ is conserved (with the same constants L_f and L_ℓ),

H₂) There exists $\eta > 0$ and an injective continuous differentiable mapping $A_\eta : \Omega \rightarrow \mathbb{R}^n$ such that :

$$\exists c_1 > 0 \quad / \quad \left\| \frac{\partial A_\eta(x)}{\partial x} - I \right\| \leq \frac{c_1}{2} \eta, \quad \forall x \in \Omega \quad (3.13)$$

with I the unit matrix of $\mathbb{R}^{n \times n}$;

$$\|A_\eta(x) - x\| \leq \eta, \quad \forall x \in \Omega \quad (3.14)$$

$$\Omega + B_{\eta/2} \subset A_\eta(\Omega)$$

$$\text{with } B_{\eta/2} = \{y \in \mathbb{R}^n / \|y\| \leq \frac{\eta}{2}\} \quad (3.15)$$

REMARK

(3.13) implies the existence and continuity of $\frac{\partial A^{-1}}{\partial x}$; furthermore :

$$\left\| \frac{\partial A^{-1}}{\partial x}(x) - I \right\| \leq c_1 \eta, \quad \forall \eta \leq \frac{1}{c_1} \quad (3.13)'$$

H₃) $\forall x_i^h$ vertex of the boundary of Ω^h there exists $\varepsilon_i^h > 0$ such that for $0 \leq \varepsilon \leq \varepsilon_i^h$ the segment $x_i^h + \varepsilon f(x_i^h, u)$ belongs to Ω^h ; so $\frac{\partial w^h}{\partial x_f}(x_i^h, u)$ is well defined.

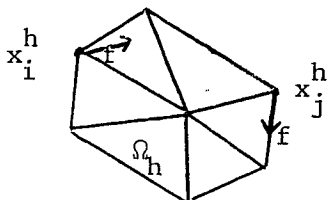

The convergence will be obtained in Theorem 3.1. as an immediate consequence of the following two Lemmas (which proofs will be given after the theorem) :

LEMMA 3.1.

If H₁), H₂), H₃) hold there exists a real single valued function $G_1(\eta, \rho, ||h||)$ such that

$$V_S(x_i^h) - G_1(\eta, \rho, ||h||) \leq \frac{-h}{w_S(x_i^h)}, \quad \forall x_i^h \in \Omega^h \quad (3.16)$$

with $0 < \rho \leq \frac{1}{4} \eta$, ρ regularization parameter and

$$\begin{aligned} G_1(\eta, \rho, ||h||) = & \eta L_S + \rho L_S(1 + c_1 \eta) + L_\psi(\eta + \rho) + \\ & + \frac{1}{\alpha} \{ \eta [L_S(c_1 M_f + L_f) + L_\varrho] + \rho [L_S(1 + c_1 \eta) L_f + L_\varrho] \} + \\ & + [c_3 L_S(1 + c_1 \eta) M_f] \frac{||h||}{\rho}, \end{aligned} \quad (3.17)$$

with c_3 constant.

LEMMA 3.2.

With the same hypothesis of Lemma 3.1. there exists a real single valued function $G_2(\eta, \rho, ||h||)$ such that

$$\bar{w}_S^h(x_i^h) \leq V_S(x_i^h) + G_2(\eta, \rho, ||h||), \quad \forall x_i^h \in \Omega^h \quad (3.18)$$

with $0 < \rho < \frac{1}{4}\eta$ and

$$\begin{aligned} G_2(\eta, \rho, ||h||) &= \eta(3 L_S + L_\psi) + \rho[3 L_S(1 + c_1\eta) + L_\psi] + \\ &+ \frac{1}{\alpha} \{ \eta[L_S(c_1 M_f + L_f) + L_\ell] + \rho[L_S(1 + c_1\eta) L_f + L_\ell] \} + \\ &+ c_3 L_S M_f \frac{||h||}{\rho} (1 + c_1 \eta). \end{aligned} \quad (3.19)$$

THEOREM 3.1.

If $H_1), H_2), H_3$ hold the functions $\bar{w}_S^h(x)$ converge uniformly to $V_S(x)$.

Proof

After Lemmas 3.1. and 3.2. if we put $\rho = ||h||^{1/2}$, $\eta = 4\rho$ we obtain, from (3.16), (3.17), (3.18) and (3.19) a positive constant C such that $\forall x_i^h$ (vertex) of Ω^h :

$$V_S(x_i^h) - C ||h||^{1/2} \leq \bar{w}_S^h(x_i^h) \leq V_S(x_i^h) + C ||h||^{1/2} \quad (3.20)$$

We consider now an arbitrary point $x \in \Omega^h$. As we know we can express x as

$$x = \sum_j \hat{\lambda}_j x_j^h \quad \hat{\lambda}_j \geq 0 \quad \sum_j \hat{\lambda}_j = 1 ;$$

so we can obtain

$$\begin{aligned}
V_S(x) - \bar{w}_S^h(x) &= (V_S(x) - \sum_j \hat{\lambda}_j V_S(x_j^h)) + (\sum_j \hat{\lambda}_j V_S(x_j^h) - \sum_j \hat{\lambda}_j \bar{w}_S^h(x_j^h)) = \\
&= \sum_j \hat{\lambda}_j (V_S(x) - V_S(x_j^h)) + \sum_j \hat{\lambda}_j (V_S(x_j^h) - \bar{w}_S^h(x_j^h)) \leq \\
&\leq \sum_j \hat{\lambda}_j \cdot L_S ||x - x_j^h|| + \sum_j \hat{\lambda}_j C ||h||^{1/2} \leq \\
&\leq L_S ||h|| + C ||h||^{1/2}.
\end{aligned} \tag{3.21}$$

In the same way

$$V_S - \bar{w}_S^h(x) \geq - (L_S ||h|| + C ||h||^{1/2}),$$

which gives, with (3.21)

$$\max_{x \in \Omega^h} | \bar{w}_S^h(x) - V_S(x) | \leq L_S ||h|| + C ||h||^{1/2}$$

and the proof is achieved. \square

Proof of Lemma 3.1.

By a constructive device we shall obtain $V_S^h \in W_S^h$ such that

$$V_S(x_i^h) - G_1(\eta, \rho, ||h||) \leq V_S^h(x_i^h), \quad \forall x_i^h \in \Omega^h; \tag{3.22}$$

then, as $V_S^h(x_i^h) \leq \bar{w}_S^h(x_i^h)$, (3.16) will hold.

The construction of V_S^h needs four steps :

a) Using H_2) we introduce the lipschitzean function

$$V_\eta(x) = V_S(A_\eta^{-1}(x)) \quad \forall x \in A_\eta(\Omega) \tag{3.23}$$

$\frac{\partial V_\eta}{\partial x}$ exists a.e. in $A_\eta(\Omega)$. So, from $\frac{\partial V_\eta}{\partial x} = \frac{\partial}{\partial A_\eta^{-1}(x)} V_S(A_\eta^{-1}(x)) \cdot \frac{\partial A_\eta^{-1}(x)}{\partial x}$

using (3.13) we have :

$$\left\| \frac{\partial V_\eta}{\partial x}(x) \right\| \leq L_S(1 + c_1\eta), \quad \text{a.e. } x \in A_\eta(x). \quad (3.24)$$

We remarks that the domain of V_η contains the set $\Omega + B_{\eta/2}$ (from definition of V_η and (3.15)).

We compute some bounds concerning $V_\eta(x)$:

$$|V_S(x) - V_\eta(x)| = |V_S(x) - V_S(A_\eta^{-1}(x))| \leq L_S \|x - A_\eta^{-1}(x)\|; \quad (3.25)$$

but, after (3.15), $x \in \Omega \Rightarrow \exists y \in \Omega / x = A_\eta(y)$;

so $\|x - A_\eta^{-1}(x)\| = \|A_\eta(y) - y\|$ which, after (3.14) is bounded by η .
Then, in (3.25) we have

$$|V_S(x) - V_\eta(x)| \leq L_S \cdot \eta \quad \forall x \in \Omega. \quad (3.26)$$

On the other hand, thanks to (3.6), (3.14) :

$$\begin{aligned} V_\eta(x) - \psi(x) &= V_S(A_\eta^{-1}(x)) - \psi(A_\eta^{-1}(x)) + (\psi(A_\eta^{-1}(x)) - \psi(x)) \leq \\ &\leq L_\psi \|A_\eta^{-1}(x) - x\| \leq L_\psi \cdot \eta \quad \forall x \in A_\eta(x). \end{aligned} \quad (3.27)$$

If we compute the first member of (3.5) with $V_\eta(x)$ at the place of $w(x)$, we have

$$\frac{\partial V_\eta(x)}{\partial x} \cdot f(x, u) + \ell(x, u) - \alpha V_\eta(x) = \frac{\partial V_S}{\partial x}(A_\eta^{-1}(x)) f(A_\eta^{-1}(x), u) + \quad (3.28)$$

$$+ \ell(A_\eta^{-1}(x), u) - \alpha V_S(A_\eta^{-1}(x)) + \gamma_\eta(x),$$

$$\text{with } \gamma_\eta(x) = \frac{\partial V_S}{\partial x}(A_\eta^{-1}(x)) \left(\frac{\partial A_\eta^{-1}(x)}{\partial x} - I \right) f(x, u) + \frac{\partial V_S}{\partial x}(A_\eta^{-1}(x)) (f(x, u) -$$

$$- f(A_\eta^{-1}(x), u)) + \ell(x, u) - \ell(A_\eta^{-1}(x), u).$$

Using H_2), (3.13), (3.14), we have

$$|\gamma_\eta(x)| \leq L_S c_1 \eta M_f + L_S L_f \eta + L_\lambda \eta.$$

and in (3.28) we obtain (recalling (3.5)) :

$$\frac{\partial V_\eta(x)}{\partial x} f(x,u) + \ell(x,u) - \alpha V_\eta(x) \geq -\eta [L_S(c_1 M_f + L_f) + L_\lambda], \quad (3.29)$$

$$\forall x \in A_\eta(x).$$

b) Regularization of $V_\eta(x)$:

Let be $\beta_1(\cdot)$ a function such that

$$\beta_1(\cdot) \in C^\infty(\mathbb{R}^n) ; \beta_1(x) \geq 0 \quad \forall x ; \text{supp } \beta_1 \subset B_1 ; \int_{\mathbb{R}^n} \beta_1(x) dx = 1.$$

We define $\beta_\rho(x) = \frac{1}{\rho^n} \beta_1\left(\frac{x}{\rho}\right)$, $\rho \in \mathbb{R}^+$. As $\forall \rho < \frac{\eta}{4}$ is $\text{dom } V_\eta \supset \Omega + B_{\eta/2}$ we can define

$$V_{\eta,\rho}(x) = (V_\eta * \beta_\rho)(x), \quad \forall x \in \Omega + B_{\eta/4}.$$

We remark that $V_{\eta,\rho}$ is infinitely differentiable ; furthermore

$$\left\| \frac{\partial}{\partial x} V_{\eta,\rho}(x) \right\| \leq \left\| \frac{\partial V_\eta}{\partial x} \right\| ; \text{ so}$$

$$\left\| \frac{\partial}{\partial x} V_{\eta,\rho}(x) \right\| \leq L_S(1 + c_1 \eta), \quad \forall x \in \Omega + B_{\eta/4} \quad (3.30)$$

$$\left\| \frac{\partial^2}{\partial x_i \partial x_j} V_{\eta,\rho}(x) \right\| \leq c_2 \cdot \frac{1}{\rho} \left\| \frac{\partial V_\eta}{\partial x} \right\| \leq c_2 \frac{1}{\rho} L_S(1 + c_1 \eta), \quad (3.31)$$

with c_2 constant depending of $\beta_1(\cdot)$.

As before we compute some bounds concerning $V_{\eta,\rho}$.

Using (3.24), (3.26) and the properties of convolution operator :

$$\begin{aligned} |V_S(x) - V_{\eta,\rho}(x)| &\leq |V_S(x) - V_\eta(x)| + |V_\eta(x) - V_{\eta,\rho}(x)| \leq \\ &\leq L_S \eta + \rho L_S(1 + c_1 \eta), \quad \forall x \in \Omega \end{aligned} \quad (3.32)$$

Using (3.27) :

$$\begin{aligned} V_{\eta,\rho}(x) - \psi(x) &= ((V_{\eta} - \psi) * \beta_{\rho})(x) + (\psi * \beta_{\rho} - \psi)(x) \leq \\ &\leq L_{\psi} \cdot \eta + L_{\psi} \cdot \rho . \end{aligned} \quad (3.33)$$

Now in (3.5)

$$\begin{aligned} \frac{\partial V_{\eta,\rho}(x)}{\partial x} \cdot f(x,u) + \ell(x,u) - \alpha V_{\eta,\rho}(x) &= \\ &= \left(\frac{\partial V_{\eta}}{\partial x}(\cdot) \cdot f(\cdot,u) + \ell(\cdot,u) - \alpha V_{\eta}(\cdot) \right) * \beta_{\rho}(\cdot)(x) + \gamma_{\rho}(x) \end{aligned} \quad (3.34)$$

$$\text{with } \gamma_{\rho}(x) = \int_{B_{\rho}} \left\{ \frac{\partial V_{\eta}}{\partial x}(x-y) [(f(x) - f(x-y))] + (\ell(x) - \ell(x-y)) \right\} B_{\rho}(y) dy$$

and from H_2) and (3.24) :

$$|\gamma_{\rho}(x)| \leq (L_S(1 + c_1\eta) L_f + L_{\ell})\rho$$

It follows after (3.29) and (3.34) :

$$\begin{aligned} \frac{\partial}{\partial x} V_{\eta,\rho}(x) \cdot f(x,u) + \ell(x,u) - \alpha V_{\eta,\rho}(x) &\geq -\eta(L_S(c_1 M_f + L_f) + L_{\ell}) - \\ &- \rho(L_S(1 + c_1\eta) L_f + L_{\ell}), \quad \forall x \in \Omega + B_{\eta/4} \end{aligned} \quad (3.35)$$

c) Discretization

In Ω^h we define $V_{\eta,\rho}^h$ linear interpolation of $V_{\eta,\rho}$, taking its values in the vertex x_i^h of Ω^h , i.e. :

$$V_{\eta,\rho}^h(x_i^h) = V_{\eta,\rho}(x_i^h), \quad \forall x_i^h \in \Omega^h . \quad (3.36)$$

Some properties of $V_{\eta,\rho}^h(x_i^h)$ are, by (3.32) :

$$|V_S(x_i^h) - V_{\eta,\rho}^h(x_i^h)| \leq L_S\eta + \rho L_S(1 + c_1\eta), \quad \forall x_i^h \in \Omega^h \quad (3.37)$$

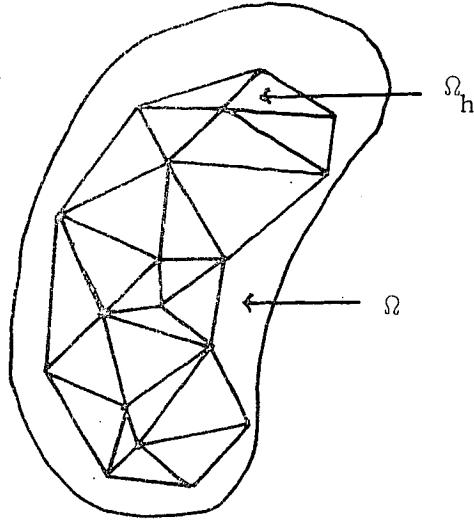

and by (3.33) :

$$V_{\eta,\rho}^h(x_i^h) - \psi(x_i^h) = v_{\eta,\rho}(x_i^h) - \psi(x_i^h) \leq L_\psi(\eta+\rho), \quad \forall x_i^h \in \Omega^h. \quad (3.38)$$

On the other hand, from (3.31) :

$$\begin{aligned} & \left| \frac{\partial v_{\eta,\rho}^h}{\partial x_f}(x_i^h, u) \cdot ||f(x_i^h, u)|| - \frac{\partial v_{\eta,\rho}}{\partial x}(x_i^h) \cdot f(x_i^h, u) \right| \leq \\ & \leq c_4 \left| \frac{\partial^2}{\partial x_i \partial x_j} v_{\eta,\rho} \right| ||h|| M_f \leq c_3 \frac{1}{\rho} L_S(1 + c_1 \eta) ||h|| M_f ; \end{aligned} \quad (3.39)$$

in consequence (3.35) and (3.39) allow us to write

$$\begin{aligned} & \frac{\partial v_{\eta,\rho}^h}{\partial x_f}(x_i^h, u) \cdot ||f(x_i^h, u)|| + \ell(x_i^h, u) - \alpha v_{\eta,\rho}^h(x_i^h) = \\ & = \frac{\partial v_{\eta,\rho}}{\partial x}(x_i^h) \cdot f(x_i^h, u) + \ell(x_i^h, u) - \alpha v_{\eta,\rho}(x_i^h) + \\ & + \left(\frac{\partial v_{\eta,\rho}^h}{\partial x_f}(x_i^h, u) \cdot ||f(x_i^h, u)|| - \frac{\partial v_{\eta,\rho}}{\partial x}(x_i^h) \cdot f(x_i^h, u) \right) \geq \\ & \geq -\eta(L_S(L_f + c_1 M_f) + L_\ell) - \rho(L_S(1 + c_1 \eta) L_f + L_\ell) - \\ & - c_3 L_S(1 + c_1 \eta) M_f \frac{||h||}{\rho}, \quad \forall x_i^h \in \Omega^h. \end{aligned} \quad (3.40)$$

d) Definition of V_S^h :

We define $\forall x \in \Omega^h$ the function V_S^h as the linear interpolation of the values in the vertex given by :

$$\begin{aligned}
V_S^h(x_i^h) &= v_{\eta, \rho}^h(x_i^h) - L_\psi(\eta + \rho) - \frac{1}{\alpha} \{ (L_S(c_1 M_f + L_f) + L_\ell) \eta + \\
&+ (L_S(1 + c_1 \eta) L_f + L_\ell) \rho + c_3 L_S(1 + c_1 \eta) M_f \} \frac{||h||}{\rho}.
\end{aligned} \tag{3.41}$$

We will show that

$$V_S^h \leq \bar{w}_S^h \tag{3.42}$$

In fact, after (3.38), (3.40) and (3.41) we can easily obtain,

$$\frac{\partial V_S^h}{\partial x_f}(x_i^h, u) \cdot ||f(x_i^h, u)|| + \ell(x_i^h, u) - \alpha V_S^h(x_i^h) \geq 0 \tag{3.43}$$

$$V_S^h(x_i^h) \leq \psi(x_i^h) \quad \forall x_i^h \text{ vertex of } \Omega^h; \tag{3.44}$$

so, $V_S^h \in W_S^h$, and by definition of \bar{w}_S^h we have

$$V_S^h(x_i^h) \leq \bar{w}_S^h(x_i^h), \quad \forall x_i^h \in \Omega^h. \quad \square$$

Furthermore, from (3.17), (3.37) and (3.41) :

$$\begin{aligned}
|V_S^h(x_i^h) - v_{\eta, \rho}^h(x_i^h)| &\leq |V_S^h(x_i^h) - v_{\eta, \rho}^h(x_i^h)| + |v_{\eta, \rho}^h(x_i^h) - v_S^h(x_i^h)| \leq \\
&\leq G_1(\eta, \rho, ||h||);
\end{aligned}$$

so (3.22) is proved and also the lemma 3.1. \square

Proof of Lemma 3.2

We recall that functions V_S verifies (see [9], pag 3) :

$$\frac{\partial V_S}{\partial x}(x) f(x, u) + \ell(x, u) - \alpha V_S(x) = 0 \quad \text{a.e. } x \in C \tag{3.45}$$

with

$$C = \{x \in \Omega / V_S(x) < \psi(x)\} \tag{3.46}$$

$$S = \{x \in \Omega / V_S(x) = \psi(x)\} \tag{3.47}$$

In the following we will consider the functions V_η , $V_{\eta,\rho}$ and $V_{\eta,\rho}^h$ as they were defined in the proof of Lemma 3.1. We put

$$S_\eta = \{x \in A_\eta(\Omega) / d(x, S) \leq \eta\} \quad (3.48)$$

$$C_\eta = \{x \in A_\eta(\Omega) / x \notin S_\eta\}. \quad (3.49)$$

Let us consider V_η and its behaviour in S_η , C_η . If $x \in C_\eta$ it follows $d(x, S) > \eta$; so after to recall that $\|x - A_\eta^{-1}(x)\| < \eta$ we have $d(A_\eta^{-1}(x), S) > 0$, that implies $A_\eta^{-1}(x) \in C$. In consequence, using (3.28) and (3.45) we have

$$\begin{aligned} \left| \frac{\partial V_\eta(x)}{\partial x} \cdot f(x, u) + \lambda(x, u) - \alpha V_\eta(x) \right| &\leq |\gamma_\eta(x)| \leq \\ &\leq \eta [L_S(c_1 M_f + L_f) + L_\lambda] \quad \text{a.e. } x \in C_\eta. \end{aligned} \quad (3.50)$$

If $x \in S_\eta$, $\exists \{x_\xi\}$, $x_\xi \in S$, $\xi = 1, 2, \dots / \|x_\xi - x\| \rightarrow d(x, S)$ if $\xi \rightarrow \infty$.

Using (3.14), (3.47) we obtain

$$\begin{aligned} |V_\eta(x) - \psi(x)| &= |V_S(A_\eta^{-1}(x)) - \psi(x)| = |V_S(A_\eta^{-1}(x)) - V_S(x)| + \\ &+ |V_S(x) - V_S(x_\xi)| + |V_S(x_\xi) - \psi(x_\xi)| + |\psi(x_\xi) - \psi(x)| \leq \\ &\leq L_S \eta + L_S \|x - x_\xi\| + L_\psi \|x - x_\xi\|. \end{aligned}$$

Finally for $\xi \rightarrow \infty$:

$$|V_\eta(x) - \psi(x)| \leq \eta (2 L_S + L_\psi), \quad \forall x \in S_\eta. \quad (3.51)$$

Now we consider $V_{\eta,\rho}(x)$. We define

$$S_\rho = \{x \in \Omega + B_{\eta/4} / d(x, S_\eta) \leq \rho\} \quad (3.52)$$

$$C_\rho = \{x \in \Omega + B_{\eta/4} / x \notin S_\rho\} \quad (3.53)$$

If $x \in C_\rho$ it follows $(x-y) \in C_\eta$, $\forall y / \|y-x\| \leq \rho$. So, using (3.34), (3.50), we have

$$\left| \frac{\partial V_{\eta,\rho}(x)}{\partial x} \cdot f(x,u) + \ell(x,u) - \alpha V_{\eta,\rho}(x) \right| \leq (\eta(L_S(c_1 M_f + L_f) + L_\ell) * \beta_\rho)(x) + \quad (3.54)$$

$$+ |\gamma_\rho(x)| \leq \eta(L_S(c_1 M_f + L_f) + L_\ell) + (L_S(1 + c_1\rho) + L_\ell) \quad \forall x \in C_\rho$$

If $x \in S_\rho$ we use a sequence $\{x_\xi\} \subset S_\eta / \lim_{\xi \rightarrow \infty} \|x_\xi - x\| = d(x, S_\eta) \leq \rho$; we obtain ((3.24), (3.51)).

$$|V_{\eta,\rho}(x) - \psi(x)| \leq |V_{\eta,\rho}(x) - V_\eta(x)| + |V_\eta(x) - V_\eta(x_\xi)| + |V_\eta(x_\xi) - \psi(x_\xi)| +$$

$$+ |\psi(x_\xi) - \psi(x)| \leq L_S(1 + c_1\eta)\rho + L_S(1 + c_1\eta) \|x - x_\xi\| +$$

$$+ \eta(2 L_S + L_\psi) + L_\psi \|x - x_\xi\|, \text{ and for } \xi \rightarrow \infty$$

$$|V_{\eta,\rho}(x) - \psi(x)| \leq \eta(2 L_S + L_\psi) + \rho(2 L_S(1 + c_1\eta) + L_\psi), \quad \forall x \in S_\rho. \quad (3.55)$$

Finally concerning $V_{\eta,\rho}^h$ we define S_h, C_h , sets of vertices of Ω^h , ($S_h \cap C_h = \emptyset$) :

$$S_h = \{x_i^h / x_i^h \in S_\rho\}, \quad (3.56)$$

$$C_h = \{x_i^h / x_i^h \in C_\rho\}. \quad (3.57)$$

If $x_i^h \in S_h$, as $V_{\eta,\rho}^h(x_i^h) = V_{\eta,\rho}(x_i^h)$ we obtain after (3.55) :

$$|V_{\eta,\rho}^h(x_i^h) - \psi(x_i^h)| \leq \eta(2 L_S + L_\psi) + \rho(2 L_S(1 + c_1\eta) + L_\psi) \quad (3.58)$$

If $x_i^h \in C_h$ we have after (3.39), (3.54) :

$$\begin{aligned}
& \left| \frac{\partial v_{\eta, \rho}^h(x_i^h, u)}{\partial x_f} \right| |f(x_i^h, u)| + \ell(x_i^h, u) - \alpha v_{\eta, \rho}^h(x_i^h) \leq \\
& \leq \left| \frac{\partial v_{\eta, \rho}(x_i^h)}{\partial x} \right| \cdot |f(x_i^h, u) + \ell(x_i^h, u) - \alpha v_{\eta, \rho}(x_i^h)| + \\
& + c_3 \frac{L_S}{\rho} (1 + c_1 \eta) M_f \| |h| \| \leq \eta (L_S (c_1 M_f + L_f) + L_\ell) + \\
& + \rho (L_S (1 + c_1 \eta) L_f + L_\ell) + c_3 \frac{L_S}{\rho} (1 + c_1 \eta) M_f \| |h| \|. \tag{3.59}
\end{aligned}$$

Let us define $\tilde{w}^h = \bar{w}_S^h - v_{\eta, \rho}^h$; as $\bar{w}^h \in W_S^h$ we obtain after (3.9), (3.10) (3.58), (3.59) :

$$\tilde{w}^h(x_i^h) \leq \psi(x_i^h) - v_{\eta, \rho}^h(x_i^h) \leq \eta (2 L_S + L_\psi) + \tag{3.60}$$

$$+ \rho (2 L_S (1 + c_1 \eta) + L_\psi), \quad \forall x_i^h \in S_h,$$

$$\begin{aligned}
& \frac{\partial \tilde{w}^h(x_i^h, u)}{\partial x_f} \cdot |f(x_i^h, u)| - \alpha \tilde{w}^h(x_i^h) + \{\eta [L_S (c_1 M_f + L_f) + L_\ell] + \\
& + \rho (L_S (1 + c_1 \eta) L_f + L_\ell) + c_3 \frac{L_S}{\rho} (1 + c_1 \eta) M_f \| |h| \| \} \geq 0, \tag{3.61}
\end{aligned}$$

$$\forall x_i^h \in C^h.$$

Using (3.60), (3.61) and lemma 2.1. (Discrete maximum principle) we can insure that

$$\begin{aligned}
& \tilde{w}^h(x_i^h) \leq \eta (2 L_S + L_\psi) + \rho (2 L_S (1 + c_1 \eta) + L_\psi) + \\
& + \frac{1}{\alpha} \{\eta (L_S (c_1 M_f + L_f) + L_\ell) + \rho (L_S (1 + c_1 \eta) L_f + L_\ell) + \\
& + c_3 \frac{1}{\rho} L_S (1 + c_1 \eta) M_f \| |h| \| \}, \quad \forall x_i^h \in C_h. \tag{3.62}
\end{aligned}$$

Finally (3.37), (3.60), (3.61) give as

$$\begin{aligned}
& \bar{w}_S^h(x_i^h) = v_{\eta, \rho}^h(x_i^h) + \tilde{w}^h(x_i^h) \leq \tilde{w}^h(x_i^h) + v_S(x_i^h) + \eta L_S + \\
& + \rho L_S (1 + c_1 \eta) \leq v_S(x_i^h) + G_2(\eta, \rho, \| |h| \|), \quad \forall x_i^h \in \Omega^h. \quad \square
\end{aligned}$$

3.2. The convergence in the frame of problem P)

FIRST PART

As it was said in 3.0 we begin by showing :

LEMMA 3.3.

If the hypothesis of Theorem 1.1. and $H_1), H_2), H_3)$ hold there exist a single real function $G_3(\eta, \rho, ||h||)$ defined for $\rho \leq \frac{\eta}{4}$ such that :

$$a) V(x_i^h) \leq \bar{w}^h(x_i^h) + G_3(\eta, \rho, ||h||), \forall x_i^h \in \Omega^h \quad (3.63)$$

$$b) \text{ If } \eta = 4\rho, \quad \rho = ||h||^{1/2}$$

$$\lim_{||h|| \rightarrow 0} G_3(4||h||^{1/2}, ||h||^{1/2}, ||h||) = 0 \quad (3.64)$$

Proof

As it was done in Lemma 3.1. we define the function

$$V_\eta(x) = V(A_\eta^{-1}(x)), \forall x \in A_\eta(\Omega)$$

and, for convolution, we regularize it by introducing

$$V_{\eta,\rho}(x) = (V_\eta * \beta_\rho)(x) \quad \forall x \in \Omega + B_{\eta/4}, \quad \rho \leq \frac{\eta}{4} .$$

We consider the function $V_{\eta,\rho}^h(x)$, linear interpolation of $V_{\eta,\rho}(x) - \Gamma$ with

$$V_{\eta,\rho}^h(x_i^h) = V_{\eta,\rho}(x_i^h) - \Gamma \quad \forall \text{ vertex } x_i^h \in \Omega^h \quad (3.65)$$

with the constant Γ given by

$$\Gamma = L_\phi(\eta + \rho) + \frac{1}{\alpha} \{ \eta [L_V(c_1 M_f + L_f) + L_\ell] + \rho [L_V(1 + c_1 \eta) L_f + L_\ell] + c_3 L_V(1 + c_1 \eta) M_f \frac{\|h\|}{\rho} \} \quad (3.66)$$

Following the techniques in Lemma 3.1. it is possible to show :

$$v_{\eta, \rho}^h(x_i^h) \leq \phi(x_i^h), \quad \forall x_i^h \quad (3.67)$$

$$\frac{\partial v_{\eta, \rho}^h}{\partial x_f} (x_i^h, u) \cdot \|f(x_i^h, u)\| + \ell(x_i^h, u) - \alpha v_{\eta, \rho}^h(x_i^h) \geq 0 \quad (3.68)$$

$$\forall x_i^h \in \Omega^h, \quad \forall u \in U^h.$$

After remarking that the constant

$$v_K^h = -\frac{M_\ell}{\alpha} - M_\phi$$

verifies (3.67) and (3.68) we introduce the function $V^h(x)$ as a convex combinations of $v_{\eta, \rho}^h$ and v_K^h :

$$V^h(x) = (1 - \lambda) v_{\eta, \rho}^h(x) + \lambda v_K^h(x), \quad \forall x \in \Omega^h \quad (3.69)$$

with

$$\lambda = \frac{1}{q_0} \{ 2 L_V[\eta + (1 + c_1 \eta)\rho] + L_V(1 + c_1 \eta) \|h\| \} \quad (3.70)$$

$$0 \leq \lambda \leq 1. \quad (3.71)$$

(3.71) is satisfied for values enough small of $\|h\|$, η and ρ , so for these values, $V^h(x)$ is well defined. Remark, also, that $V^h(x)$ verifies (3.67) (3.68). We have also

$$\begin{aligned} V^h(x_i^h) - V^h(x_i^h + g(x_i^h, z)) &= (1 - \lambda)(v_{\eta, \rho}^h(x_i^h) - v_{\eta, \rho}^h(x_i^h + g(x_i^h, z))) = \\ &= (1 - \lambda)(v_{\eta, \rho}^h(x_i^h) - \sum_j \lambda_j^!(x_i^h, g) v_{\eta, \rho}^h(x_j^h)). \end{aligned} \quad (3.72)$$

Taking in account (3.32) we obtain

$$|V(x) - V_{\eta, \rho}(x)| \leq L_V \eta + L_V(1 + c_1 \eta) \rho, \quad \forall x \in \Omega + B_{\eta/4};$$

and, recalling that $\forall j / \lambda'_j(x_i^h, g) > 0$ is $||x_j^h - (x_i^h + g(x_i^h, z))|| \leq ||h||$, what implies, using (3.30)

$$|V_{\eta, \rho}(x_j^h) - V_{\eta, \rho}(x_i^h + g(x_i^h, z))| \leq L_V(1 + c_3 \eta) ||h||$$

we obtain in (3.72)

$$\begin{aligned} V^h(x_i^h) - V^h(x_i^h + g(x_i^h, z)) &\leq (1 - \lambda)(V(x_i^h) - V_{\eta, \rho}(x_i^h + g(x_i^h, z))) + \\ &+ L_V(\eta + (1 + c_1 \eta) \rho) + L_V(1 + c_1 \eta) ||h|| \leq \\ &\leq (1 - \lambda)(V(x_i^h) - V(x_i^h + g(x_i^h, z))) + 2 L_V(\eta + (1 + c_1 \eta) \rho) + \\ &+ L_V(1 + c_1 \eta) ||h||. \end{aligned} \tag{3.73}$$

As $\forall x \in \Omega, \forall z \in Z, V(x) - V(x + q(x, z)) \leq g(x, z)$, (3.73) becomes, using definition of λ :

$$\begin{aligned} V^h(x_i^h) - V^h(x_i^h + g(x_i^h, z)) &\leq (1 - \lambda) q(x_i^h, z) + 2 L_V(\eta + (1 + c_1 \eta) \rho) + \\ &+ L_V(1 + c_1 \eta) ||h|| \leq q(x, z) - \lambda q_0 + \\ &+ 2 L_V(\eta + (1 + c_1 \eta) \rho) + L_V(1 + c_1 \eta) ||\eta|| \leq q(x, z). \end{aligned} \tag{3.74}$$

After (3.67), (3.68), (3.74), $V^h \in W^h$; this implies $V^h \leq \bar{w}^h$. We study now the difference between V^h and V :

$$\begin{aligned} |V(x_i^h) - V^h(x_i^h)| &\leq |V(x_i^h) - V_{\eta, \rho}(x_i^h)| + |V_{\eta, \rho}(x_i^h) - V_{\eta, \rho}^h(x_i^h)| + \\ &+ |V_{\eta, \rho}^h(x_i^h) - V^h(x_i^h)| \leq \eta L_V + \rho L_V(1 + c_1 \eta) + \Gamma + \lambda |V_{\eta, \rho}^h(x_i^h) - V_K^h(x_i^h)| \end{aligned}$$

But, after the definition of $V_{\eta, \rho}^h$ and V_K^h :

$$|V_{\eta, \rho}^h(x_i^h) - V_K^h(x_i^h)| \leq 2 \left(\frac{M_\lambda}{\alpha} + M_\phi \right) + \Gamma;$$

so

$$\begin{aligned} V(x_i^h) &\leq |V(x_i^h) - V^h(x_i^h)| + V^h(x_i^h) \leq \\ &\leq \{ \eta L_V + \rho L_V(1 + c_1 \eta) + \Gamma + \lambda(2(\frac{M_\lambda}{\alpha} + M) + \Gamma) \} + \\ &+ \bar{w}^h(x_i^h) \quad \forall x_i^h \in \Omega^h. \end{aligned} \quad (3.75)$$

The quantity {...} verifies (3.64). So the proof is achieved. \square

REMARK : With the same technique used in Theorem 3.1. We obtain :

$$V(x) \leq \tilde{G}_3(\eta, \rho, ||h||) + \bar{w}^h(x), \quad \forall x \in \Omega^h \quad (3.76)$$

with $\tilde{G}_3(\eta, \rho, ||h||) = G_3(\eta, \rho, ||h||) + L_V ||h||$.

Furthermore, (3.76) implies

$$\lim_{||h|| \rightarrow \infty} \bar{w}^h(x) \geq V(x) \quad (3.77)$$

SECOND PART

After (3.77) the convergence will be insured after showing an inequality as the following

$$\overline{\lim}_{||h|| \rightarrow \infty} \bar{w}^h(x) \leq V(x) \quad (3.78)$$

To obtain (3.78), let us consider a suitable sequence of stopping time problems having as solution the sequence of functions $V_{\mu, \nu, i}$.

Definition of $V_{\mu, \nu, i}$:

To simplify the redaction we will suppose that the sets of controls U and Z are finite sets :

$$U = \{u_i ; i = 1, \dots, n_u\} \quad Z = \{z_k ; k = 1, \dots, n_z\}$$

We introduce the set of control policies

$$U_{\mu, \nu, i} = \{(u(\cdot), z(\cdot) / a), b\} \quad (3.79)$$

a) $u(\cdot)$ is a left continuous piecewise constant function with a maximum of ν switching points, with values in U and $u(0) = u_i$.

b) $z(\cdot)$ has a maximum of μ impulses and $z(\theta_s) \in Z$.

Corresponding to (3.79) we introduce the functions

$$V_{\mu, \nu, i}(x) = \inf \{J(x, u(\cdot), z(\cdot), \theta) / (u(\cdot), z(\cdot)) \in U_{\mu, \nu, i}, \theta \geq 0\} \quad (3.80)$$

having the following properties as it is easy to verify from the definition (3.80) : $\forall x \in \Omega$

$$V_{\mu, \nu, i}(x) \leq V_{\mu', \nu, i}(x) \text{ if } \mu > \mu' \quad (3.81)$$

$$V_{\mu, \nu, i}(x) \leq V_{\mu, \nu', j}(x) \text{ if } \nu > \nu', \forall j = 1, \dots, n_u \quad (3.82)$$

$$V(x) \leq V_{\mu, \nu, i}(x) \quad \forall \mu \geq 0, \nu \geq 0, i = 1, \dots, n_u \quad (3.83)$$

Furthermore, V is the limit of $V_{\mu, \nu, i}$ in the sense specified in the following

Proposition 3.1.

$$\exists \delta_{\mu, \nu}(x) / V_{\mu, \nu, i}(x) - V(x) \leq \delta_{\mu, \nu}(x) \quad \forall x \in \Omega \quad (3.84)$$

with $\lim_{(\nu, \mu) \rightarrow \infty} \delta_{\mu, \nu}(x) = 0$

We can also characterize $V_{\mu, \nu, i}$ as solutions of stopping time problems. In fact we have, as follows using dynamic programming techniques.

Proposition 3.2.

$V_{\mu, \nu, i}$ is the optimal cost function of a stopping time problem defined by a recursive device :

$$V_{\mu, \nu, i}(x) = \min_{\theta \geq 0} \left(\int_0^\theta e^{-\alpha s} \ell(y(s), u_i) ds + e^{-\alpha \theta} \psi_{\mu, \nu, i}(y(\theta)) \right) \quad (3.85)$$

with

$$\frac{dy}{ds} = f(y, u_i)$$

$$y(0) = x$$

and $\psi_{\mu, \nu, i}$ defined by

$$\begin{aligned} \psi_{\mu, \nu, i}(x) = \min \{ & \min_{\substack{j=1, n_u \\ j \neq i}} V_{\mu, \nu-1, j}(x), \min_{k=1, n_z} (q(x, z_k) + \\ & + V_{\mu-1, \nu, i}(x + g(x, z_k)), \phi(x) \} , \text{ if } \nu \geq 1, \mu \geq 1 \\ \psi_{0, \nu, i}(x) = \min \{ & \min_{\substack{j=1, n_u \\ j \neq i}} V_{0, \nu-1, j}(x), \phi(x) \} \text{ if } \mu = 0, \nu \geq 1 \end{aligned} \quad (3.86)$$

$$\psi_{\mu, 0, i}(x) = \min_{k=1, n_z} \{ (q(x, z_k) + V_{\mu-1, 0, i}(x + g(x, z_k))) \phi(x) \}$$

if $\nu = 0, \mu \geq 1$

$$\psi_{0, 0, i}(x) = \phi(x) \text{ if } \nu = 0, \mu = 0 .$$

In the same way that we show the lipschitzeanity of $V(x)$ it is possible to insure

Proposition 3.3.

$V_{\mu, \nu, i}$ are equilibilipschitzean ; furthermore

$$|V_{\mu, \nu, i}(x) - V_{\mu, \nu, i}(x')| \leq L_V \|x - x'\|, \quad \forall x, x' \in \Omega \quad (3.87)$$

As a consequence of (3.87) and in the frame of (1.9)-(1.14) we have :

$V_{\mu, \nu, i}$ is the maximum element of the set $W_{\mu, \nu, i}$ with

$$W_{\mu, \nu, i} = \{w : \Omega \rightarrow \mathbb{R} / \text{a) b) c)\}$$

a) w lipschitzean

b) $w(x) \leq \psi_{\mu, \nu, i}(x), \quad \forall x \in \Omega$

c) $\frac{\partial w(x)}{\partial x} f(x, u_i) + \ell(x, u_i) - \alpha w(x) \geq 0, \text{ a.e. } x \in \Omega$

(3.88)

After introducing a triangulation Ω^h in Ω we put, as in (3.86) :

$$\begin{aligned} \psi_{\mu, \nu, i}^h(x_s^h) &= \min\{\phi(x_s^h), \min_{\substack{j=1, n_u \\ j \neq i}} \bar{w}_{\mu, \nu-1, j}^{-h}(x_s^h), \min_{k=1, n_z} (q(x_s^h, z_k) + \\ &+ \bar{w}_{\mu-1, \nu, i}^{-h}(x_s^h + g(x_s^h, z_k)))\} \quad \text{if } \mu \geq i, \nu \geq i, \\ \psi_{0, \nu, i}^h(x_s^h) &= \min\{\phi(x_s^h), \min_{\substack{j=1, n_u \\ j \neq i}} (\bar{w}_{0, \nu-1, j}^{-h}(x_s^h))\}, \quad \text{if } \mu = 0, \nu \geq 1, \end{aligned} \quad (3.89)$$

$$\begin{aligned} \psi_{\mu, 0, i}^h(x_s^h) &= \min\{\phi(x_s^h), \min_{k=1, n_z} (q(x_s^h, z_k) + \bar{w}_{\mu-1, 0, i}^{-h}(x_s^h + \\ &+ g(x_s^h, z_k)))\} \quad \text{if } \mu \geq 1, \nu = 0, \end{aligned}$$

$$\psi_{0, 0, i}^h(x_s^h) = \phi(x_s^h) \quad \text{if } \mu = 0, \nu = 0,$$

where $\bar{w}_{\mu,\nu,i}^h$ is iteratively obtained from (3.89) using (3.90) :

$$\begin{aligned} \bar{w}_{\mu,\nu,i}^h & \text{ is the maximum element of } W_{\mu,\nu,i}^h \text{ with} \\ W_{\mu,\nu,i}^h & = \{w^h : \Omega^h \rightarrow \mathbb{R} / b^h ; c^h\} \end{aligned} \quad (3.90)$$

$$b^h) \quad w^h(x_s^h) \leq \psi_{\mu,\nu,i}^h(x_s^h), \quad \forall x_s^h \text{ vertex of } \Omega^h$$

$$c^h) \quad \frac{\partial w^h}{\partial x_f} (x_s^h, u_i) \quad ||f(x_s^h, u_i)|| + \ell(x_s^k, u_i) - \alpha w^h(x_s^h) \geq 0.$$

Simultaneously we introduce the functions $\hat{w}_{\mu,\nu,i}^h$:

$$\begin{aligned} \hat{w}_{\mu,\nu,i}^h & \text{ is the maximum element of } \hat{W}_{\mu,\nu,i}^h \text{ with} \\ \hat{W}_{\mu,\nu,i}^h & = \{w^h : \Omega^h \rightarrow \mathbb{R} / \hat{b}^h, c^h\} \end{aligned} \quad (3.91)$$

$$\hat{b}^h) \quad w^h(x_s^h) \leq \psi_{\mu,\nu,i}^h(x_s^h).$$

We remark the character of finite linear elements of w^h in (3.90), (3.91).

Some properties of $\bar{w}_{\mu,\nu,i}^h$ and $\hat{w}_{\mu,\nu,i}^h$.

After pointing out that using (3.86) we obtain

$$|\psi_{\mu,\nu,i}(x) - \psi_{\mu,\nu,i}(x')| \leq (\max \{L_\phi, L_V, L_q + L_V(1 + L_g)\}) \cdot ||x - x'||,$$

we can assume as instant of Lipschitz of $\psi_{\mu,\nu,i}$, independent of μ, ν, i

$$L_\psi = L_q + L_V(1 + L_g) . \quad (3.92)$$

So, using Lemmas 3.1. and 3.2. related to the function \hat{w}^h and the stopping time problem (3.85) we can insure, with L_ψ given by (3.92) :

$$\max_{x_s^h} |\hat{w}_{\mu,\nu,i}^h(x_s^h) - v_{\mu,\nu,i}(x_s^h)| \leq G_4(\eta, \rho, ||h||) \quad (3.93)$$

with $G_4(\eta, \rho, ||h||) \rightarrow 0$, for $\eta = 4\rho$, $\rho = ||h||^{1/2}$, if $||h|| \rightarrow 0$.

Now as it was done in Theorem 3.1. :

$$\begin{aligned} \max_{x \in \Omega^h} |\hat{w}_{\mu, \nu, i}^h(x) - v_{\mu, \nu, i}(x)| &\leq G_4(\eta, \rho, ||h||) + \\ &+ L_V ||h|| = G_5(\eta, \rho, ||h||) \end{aligned} \quad (3.94)$$

Proposition 3.4.

The approximate solution \bar{w}^h verifies

$$\bar{w}^h(x_s^h) \leq \bar{w}_{\mu, \nu, i}^h(x_s^h), \forall x_s^h, \forall (\mu, \nu), \forall i. \quad (3.95)$$

Proof

As $\forall u_i$, \bar{w}^h verifies (3.90, c^h) it is enough to show that $\bar{w}^h(x_s^h) \leq \psi_{\mu, \nu, i}(x_s^h)$, $\forall x_s^h$ to insure $\bar{w}^h \in W_{\mu, \nu, i}^h$, which gives (3.95) because $\bar{w}_{\mu, \nu, i}^h$ is the maximum element of $W_{\mu, \nu, i}^h$.

So we will show that

$$\bar{w}^h \leq \psi_{\mu, \nu, i}, \forall \mu = 0, 1, \dots; \forall \nu = 0, 1, \dots; \forall i = 1, n_u \quad (3.96)$$

First, for $\mu = 0$, $\nu = 0$ we have by definition of \bar{w}^h :

$$\psi_{0, 0, i}(x_s^h) = \phi(x_s^h) \geq \bar{w}^h(x_s^h) \quad \forall x_s^h ;$$

now we will suppose that

$$\bar{w}^h(x_s^h) \leq \psi_{\mu, \nu, i}(x_s^h), \forall x_s^h, \forall i = 1, n_u \quad (3.97)$$

and we will show that (3.98), (3.99) hold :

$$\bar{w}^h(x_s^h) \leq \psi_{\mu, \nu+1, j}(x_s^h) \quad \forall x_s^h; \quad \forall j = 1, n_u \quad (3.98)$$

$$\bar{w}^h(x_s^h) \leq \psi_{\mu+1, \nu, i}(x_s^h) \quad \forall x_s^h; \quad \forall i = 1, n_u \quad (3.99)$$

Recalling that

$$\bar{w}^h(x_s^h) \leq \min_{k=1, n_z} (q(x_s^h, z_k) + \bar{w}^h(x_s^h + g(x_s^h, z_k)))$$

and taking into account that by (3.97) :

$$\bar{w}^h(x_s^h) \leq \bar{w}_{\mu, \nu, i}^h(x_s^h) \quad \forall x_s^h, \quad \forall i = 1, n_u \quad (3.100)$$

we have

$$\bar{w}^h(x_s^h) \leq \min_{k=1, n_z} (q(x_s^h, z_k) + \bar{w}_{\mu, \nu, i}^h(x_s^h + g(x_s^h, z_k))). \quad (3.101)$$

So, from (3.86), (3.97), (3.101) we obtain (3.99). Also, from (3.100) we obtain $\bar{w}^h(x_s^h) \leq \min_{i=1, n_u} (\bar{w}_{\mu, \nu, j}^h(x_s^h))$; from here it follows,

using (3.86), (3.97), inequality (3.98). \square

Proposition 3.5.

$$\max_{x_s^h} (\bar{w}_{\mu, \nu, i}^h(x_s^h) - \hat{w}_{\mu, \nu, i}(x_s^h)) \leq \max_{x_s^h} (\psi_{\mu, \nu, i}^h(x_s^h) - \psi_{\mu, \nu, i}(x_s^h))^+ \quad (3.102)$$

Proof

As $\bar{w}_{\mu, \nu, i}^h$ verifies (3.90, c^h), the function

$\tilde{w}_{\mu, \nu, i}^h = \bar{w}_{\mu, \nu, i}^h - \max_{x_s^h} (\psi_{\mu, \nu, i}^h(x_s^h) - \psi_{\mu, \nu, i}(x_s^h))^+$ will also verifies it. Now,

recalling that $\bar{w}_{\mu, \nu, i}^h(x_s^h) \leq \psi_{\mu, \nu, i}^h(x_s^h)$, $\forall x_s^h$, we obtain

$$\tilde{w}_{\mu,\nu,i}^h(x_s^h) \leq \psi_{\mu,\nu,i}^h(x_s^h) - \max_{x_s^h} (\psi_{\mu,\nu,i}^h(x_s^h) - \psi_{\mu,\nu,i}^h(x_s^h))^+ \leq \psi_{\mu,\nu,i}^h(x_s^h) \forall x_s^h.$$

So, $\tilde{w}_{\mu,\nu,i}^h$ verifies (3.91, b^h) which implies $\tilde{w}_{\mu,\nu,i}^h \in \hat{W}_{\mu,\nu,i}^h$. Finally, by the definition of $\hat{w}_{\mu,\nu,i}^h$ we have $\tilde{w}_{\mu,\nu,i}^h(x_s^h) \leq \hat{w}_{\mu,\nu,i}^h(x_s^h)$; from here we obtain (3.102). \square

Proposition 3.6.

For all x_s^h and for all $i = 1, n_u$ the positive part of $\psi_{\mu,\nu,i}^h - \psi_{\mu,\nu,i}$ has the following bounds :

$$\begin{aligned} \max_{x_s^h} (\psi_{\mu,\nu,i}^h(x_s^h) - \psi_{\mu,\nu,i}(x_s^h))^+ &\leq \max\{\max_{x_s^h; j=1, n_u} (\bar{w}_{\mu,\nu-1,j}^h(x_s^h) - \\ &V_{\mu,\nu-1,j}(x_s^h))^+, \max_{x \in \Omega^h} (\bar{w}_{\mu-1,\nu,i}^h(x) - V_{\mu-1,\nu,i}(x))^+\}, \text{ if } \mu \geq 1, \nu \geq 1; \\ \max_{x_s^h} (\psi_{0,\nu,i}^h(x_s^h) - \psi_{0,\nu,i}(x_s^h))^+ &\leq \max_{x_s^h; j=1, n_u} (\bar{w}_{0,\nu-1,j}^h(x_s^h) - V_{0,\nu-1,j}(x_s^h))^+ \end{aligned} \quad (3.103)$$

if $\mu = 0, \nu \geq 1$;

$$\max_{x_s^h} (\psi_{\mu,0,i}^h(x_s^h) - \psi_{\mu,0,i}(x_s^h))^+ \leq \max_{x \in \Omega^h} (\bar{w}_{\mu-1,\nu,i}^h(x) - V_{\mu-1,\nu,i}(x))^+$$

if $\mu \geq 1, \nu = 0$;

$$\max_{x_s^h} (\psi_{0,0,i}^h(x_s^h) - \psi_{0,0,i}(x_s^h))^+ = 0 \text{ if } \mu = \nu = 0.$$

Proof

Let us begin the proof taking in consideration two functions $a(\xi, x)$ and $a'(\xi, x)$ having a finite number of values. After calling $\beta(x) = \min_{\xi} a(\xi, x)$ $\beta'(x) = \min_{\xi} a'(\xi, x)$ it is possible to show that

$$\max_x (\beta(x) - \beta'(x)) \leq \max_{x, \xi} (a(\xi, x) - a'(\xi, x)). \quad (3.104)$$

In fact, if we denote $\hat{\xi}(x)$ such value given $\beta'(x) = a'(\hat{\xi}(x), x)$ we have

$$\begin{aligned} \beta(x) - \beta'(x) &= \beta(x) - a'(\hat{\xi}(x), x) \leq a(\hat{\xi}(x), x) - a'(\hat{\xi}(x), x) \leq \\ &\leq \max_{\xi} (a(\xi, x) - a'(\xi, x)) \end{aligned}$$

and (3.104) follows immediately.

Now, because

$$\begin{aligned} &\max_{x_s^h, k=1, n_z} (\bar{w}_{\mu, \nu, i}^{-h}(x_s^h + g(x_s^h, z_k)) - v_{\mu, \nu, i}(x_s^h + g(x_s^h, z_k))) \leq \\ &\leq \max_{x \in \Omega} (\bar{w}_{\mu, \nu, i}^{-h}(x) - v_{\mu, \nu, i}(x)) \end{aligned}$$

we can obtain (3.103) using for $\psi_{\mu, \nu, i}^h$ and $\psi_{\mu, \nu, i}$ the result (3.104).

Proposition 3.7.

$$\max_{\substack{x \in \Omega^h \\ i=1, n_u}} (\bar{w}_{\mu, \nu, i}^{-h}(x) - v_{\mu, \nu, i}(x)) \leq (1 + \mu + \nu) G_5(\eta, \rho, \|h\|) \quad (3.105)$$

Proof

We will recall a property concerning double index sequences :

if in $\{a_{\mu, \nu}\}$, $\mu \geq 0, \nu \geq 0$ the following inequalities hold :

$$\begin{aligned} a_{\mu, \nu} &\leq b + \max(a_{\mu-1, \nu}, a_{\mu, \nu-1}) & \forall \nu \geq 1, \mu \geq 1 \\ a_{0, \nu} &\leq b + a_{0, \nu-1} & \forall \nu \geq 1 \\ a_{\mu, 0} &\leq b + a_{\mu-1, 0} & \forall \mu \geq 1 \\ a_{0, 0} &\leq b \end{aligned} \quad (3.106)$$

then

$$a_{\mu, \nu} \leq (1 + \nu + \mu)b, \quad \forall \mu \geq 0, \nu \geq 0 \quad (3.107)$$

Now let us call

$$\max_{\substack{x \in \Omega^h \\ i=1, n_u}} (\bar{w}_{\mu, \nu, i}^{-h}(x) - V_{\mu, \nu, i}(x)) = a_{\mu, \nu}; \quad (3.108)$$

using (3.94) we have

$$a_{\mu, \nu} \leq \max_{\substack{i=1, n_u \\ x_s}} (\bar{w}_{\mu, \nu, i}^{-h}(x_s^h) - \hat{w}_{\mu, \nu, i}^h(x_s^h)) + G_5(\eta, \rho, ||h||)$$

and, by (3.102)

$$a_{\mu, \nu} \leq \max_{\substack{i=1, n_u \\ x_s}} (\psi_{\mu, \nu, i}^h(x_s^h) - \psi_{\mu, \nu, i}(x_s^h)) + G_5(\eta, \rho, ||h||) \quad (3.109)$$

Obviously (3.106) holds with definition introduced in (3.108), and $b = G_5(\eta, \rho, ||h||)$. So (3.107) implies (3.105) after using in second members of (3.103) that $\max_{x_s^h} (\cdot) \leq \max_{x \in \Omega^h} (\cdot)$. \square

We are now able to conclude

THEOREM 3.2.

The solution \bar{w}^h of (P_h) converges uniformly to $V(x)$.

To begin we remark that as it was done in (3.20) we can, using (3.75) and (3.76) to insure that for $\eta = 4\rho$, $\rho = ||h||^{1/2}$, $\exists C_5 > 0$ such that

$$V(x) - C_5 ||h||^{1/2} \leq \bar{w}^h(x), \quad \forall x \in \Omega, \quad \forall ||h|| \leq ||h_0||, \quad (3.110)$$

with h_0 denoted a fixe "initial" triangulation.

Taking into account the affinity of functions \bar{w}^h , $\bar{w}_{\mu, \nu, i}^h$ we obtain from (3.95)

$$\bar{w}^h(x) \leq \bar{w}_{\mu, \nu, i}^h(x), \quad \forall x \in \Omega^h,$$

allowing us, taking advantage of (3.105) to write

$$\bar{w}^h(x) \leq V_{\mu, \nu, i}(x) + (1 + \nu + \mu) G_5(\eta; \rho, ||h||)$$

and, to insure the existence of a positive constant C_6 such that

$$\bar{w}^h(x) \leq V_{\mu, \nu, i}(x) + (1 + \nu + \mu) C_6 ||h||^{1/2},$$

$$\forall x \in \Omega, \quad \forall ||h|| < ||h_0||. \quad (3.111)$$

Using (3.84) in (3.111) we have

$$\bar{w}^h(x) \leq V(x) + \delta(\mu, \nu) + (1 + \nu + \mu) C_6 ||h||^{1/2} \quad (3.112)$$

$$\text{with } \delta(\mu, \nu) \rightarrow 0 \text{ if } (\mu, \nu) \rightarrow \infty \quad (3.113)$$

To finish, after (3.113) $\forall \epsilon > 0 \exists (\mu_\epsilon, \nu_\epsilon) / \delta(\mu_\epsilon, \nu_\epsilon) < \frac{\epsilon}{2}$;
if we choose

$$||h_\epsilon|| = \min \left\{ \left(\frac{\epsilon}{C_6} \right)^2, \left(\frac{\frac{\epsilon}{2} C_6}{1 + \mu_\epsilon + \nu_\epsilon} \right)^2 \right\}$$

we obtain, using (3.110), (3.112)

$$|V(x) - \bar{w}^h(x)| \leq \epsilon, \quad \forall x \in \Omega^h, \quad \forall ||h|| \leq ||h_\epsilon||$$

i.e. the thesis. \square

3.3. An estimation of the rate of convergence

We reduce our control policy to stopping time and impulse controls. Because we have not continuous control we neglect the parameter ν in (3.84) and, following the same technique used in [9] we can show that

$$\delta(\mu) \leq 2 e^{(M_\phi + \frac{M_\ell}{\alpha})} e^{-\mu p}, \quad p = \frac{q_0}{2 e^{(\frac{M_\ell}{\alpha} + M_\phi)}}.$$

So (3.111) becomes

$$w^{-h}(x) \leq V(x) + 2 e^{(M_\phi + \frac{M_\ell}{\alpha})} e^{-\mu p} + (1 + \mu) C_6 ||h||^{1/2} \quad (3.114)$$

$$\forall \mu = 0, 1, \dots, \quad \forall ||h|| \leq ||h_0||.$$

Using in (3.114) as μ the integer part of $\frac{-1}{p} \log \frac{C_5 ||h||^{1/2}}{2 e^{(M_\phi + \frac{M_\ell}{\alpha})}}$

we can insure the existence of a constant C_7 such that

$$|\bar{w}^h(x) - V(x)| \leq C_7 |\log ||h|||. ||h||^{1/2}, \quad (3.115)$$

$$\forall x \in \Omega_h, \quad \forall ||h|| \leq ||h_0||.$$

II. THE NON-STATIONARY CASE

II.1. The theoretical approach

There are not too much difficulties to extend the results of the first part I to the case in which the dynamics depends explicitly of the time t . In general, we will limit ourselves to give the results concerning the non-stationary case; we will only remark and analyse those for which there are some important differences.

The original problem and its equivalent formulation

In this case the system satisfies in absence of impulse controls the differential equation

$$\left| \begin{array}{ll} \frac{dy}{ds} = f(y,u,s) & x \in \Omega \subset \mathbb{R}^n \\ y(t) = x & t \in [0,T] \end{array} \right. \quad (1.1)$$

$u(\cdot)$ is a measurable function of the time, with values in a compact set $U \subset \mathbb{R}^m$.

In a finite set of times θ_ν ($\nu = 1, 2, \dots, \mu$) impulses $z(\theta_\nu) \in Z$ are applied; the trajectory jumps are

$$y(\theta_\nu^+) = y(\theta_\nu^-) + g(y(\theta_\nu^-), z(\theta_\nu), \theta_\nu) \quad (1.2)$$

Z is a compact set of \mathbb{R}^p .

We denote by $(u(\cdot), z(\cdot), \tau)$ a control strategy with the stopping-time $\tau \in [0, T[$.

The cost associated to each strategy is

$$\begin{aligned}
J(x,t;u(\cdot),z(\cdot),\tau) &= \int_t^\tau e^{-\alpha(s-t)} \ell(y(s),u(s),s) ds + \\
&+ \sum_{\nu} q(y(\theta_{\nu}^-),z(\theta_{\nu}^-),\theta_{\nu}^-) e^{-\alpha(\theta_{\nu}^- - t)} + \\
&+ e^{-\alpha(\tau-t)} \phi(y(\tau),\tau) \cdot \chi_{[t,T[}
\end{aligned} \tag{1.3}$$

$\chi_{[t,T[}(\cdot)$ characteristic function of the interval $[t,T[$.

The optimal cost function is $V(x,t) \in Q$

$$V(x,t) = \inf J(x,t;u(\cdot),z(\cdot),\tau) \tag{1.4}$$

$$Q = \Omega \times [0,T] . \tag{1.5}$$

In the following we will suppose

- i) f, ℓ, ϕ, g, q are continuous and bounded functions; they are lipschitzean functions in (x,t) .
- ii) $\phi(x,T) \geq 0$, $\forall x \in \Omega$
- iii) $q(x,z,t) \geq q_0 > 0$ $\forall (x,t) \in Q$, $\forall z \in Z$.
- iv) $\forall t$, $y(t) \in \Omega$, independently of the strategy.

We can give the following characterization of $V(x,t)$.

THEOREM 1.1 :

$V(x,t)$ is the maximum element of the set W , with

$$\begin{aligned}
W &= \{w(x,t) \rightarrow \mathbb{R} / (1.6) - (1.10)\} \\
w(x,t) &\text{ lipschitzean function in } (x,t)
\end{aligned} \tag{1.6}$$

$$\begin{aligned}
\frac{\partial w(x,t)}{\partial t} + \min_{u \in U} \left[\frac{\partial w(x,t)}{\partial x} \cdot f(x,u,t) + \ell(x,u,t) - \alpha w(x,t) \right] &\geq 0 \\
\text{a.e. } (x,t) &\in Q
\end{aligned} \tag{1.7}$$

$$w(x,t) \leq \min_{z \in Z} (q(x,z,t) + w(x+g(x,z,t),t)) \quad (1.8)$$

$$\forall (x,t) \in Q$$

$$w(x,t) \leq \phi(x,t) \quad , \quad \forall (x,t) \in Q \quad (1.9)$$

$$w(x,T) \leq 0 \quad , \quad \forall x \in \Omega \quad (1.10)$$

The proof follows the method used in [9], p. 29.

II.2. The discretized problem (P_h)

a) The set Q is approximated with a triangulation Q^h , union of simplices of vertices (x_p, t_q) ; $p = 0, M_x$; $q = 0, N_T$, $t_q = q \cdot \delta$, $\delta = \frac{T}{N_T}$.

This triangulation is "regular in t " in the following sense :

i) each simplex of Q^h has its vertices in two hyperplanes with equations $t = t_q$, $t = t_{q+1}$.

ii) if a face of a simplex of Q^h is contained in the hyperplane $\{t = t_q\}$ we will have a "mirror image" of that face in the hyperplanes $\{t = t_{q-1}\}$, $\{t = t_{q+1}\}$; they are themselves faces of simplices of Q^h .

Exemple :

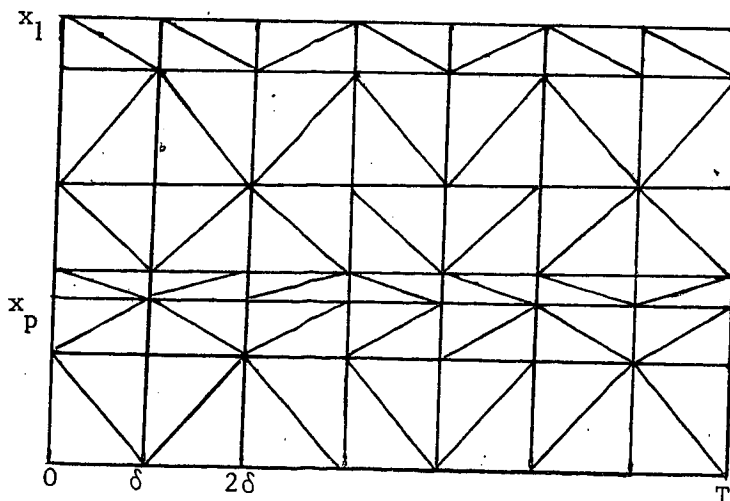

b) In the set of linear finite elements w^h defined in Q^h we consider the set W :

$$W = \{w^h : Q^h \rightarrow \mathbb{R} / (2.1), (2.3), (2.4), (2.5)\}$$

$$\frac{\partial w^h}{\partial t}(x_p, t_q; u) + \frac{\partial w^h}{\partial x_f}(x_p, t_q, u) \|f(x_p, u, t_q)\| + \ell(x_p, u, t_q) - \alpha w^h(x_p, t_q) \geq 0 \tag{2.1}$$

where

$$\frac{\partial w^h}{\partial t}(x_p, t_q; u) + \frac{\partial w^h}{\partial x_f}(x_p, t_q; u) \|f(x_p, u, t_q)\|$$

is the product of the derivate of w^h in the direction of the vector $(1, f(x_p, u, t_q)) \in \mathbb{R}^{n+1}$ by the norm of such vector ; for example, related to the following pictures, is equal to $\frac{w^h(a, t^a) - w^h(x_p, t_q)}{\Delta}$

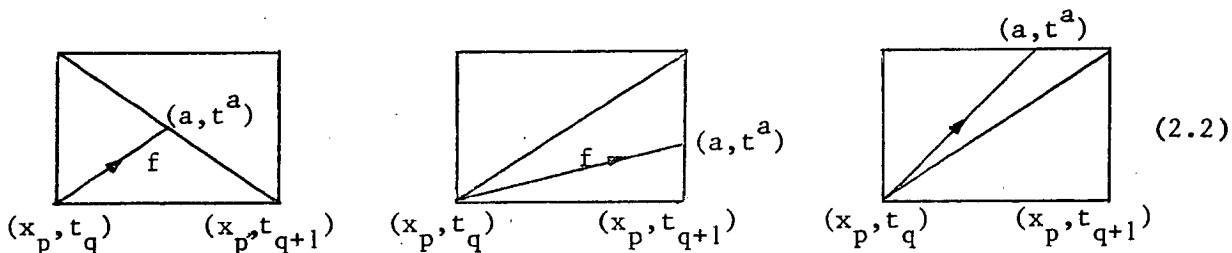

with $\Delta = t^a - t_q$;

$$w^h(x_p, t_q) \leq q(x_p, z, t_q) + w^h(x_p + g(x_p, z, t_q), t_q) \tag{2.3}$$

$$\forall z \in Z^h, \forall x_p, p = 0, N_x ; \forall t_q, q = 0, N_T - 1 ;$$

$$w^h(x_p, t_q) \leq \phi(x_p, t_q), \quad \forall p = 0, N_x, \quad \forall q = 0, N_T - 1 \tag{2.4}$$

$$w^h(x_p, t_{N_T}) \leq 0, \quad \forall p = 0, N_x \quad (2.5)$$

Remarks : Similar to those did in d) of I.2.1.

c) We introduce the following partial order " \leq " :

$$w^h \leq \tilde{w}^h \iff w^h(x_p, t_q) \leq \tilde{w}^h(x_p, t_q) \quad (2.6)$$

$$\forall p = 0, N_x ; \quad q = 0, N_T$$

and we put the discretized problem :

(P_h) : Find the maximum element \bar{w}^h of the set W^h related to the partial order " \leq ".

2.2. The solution of (P_h) and its properties

(2.1) and (2.3) will be transformed in equivalent and more useful relations.

As the picture shows we express the point (a, t^a) as a convex combination of points (x', t_p) and (a', t_{p+1}) :

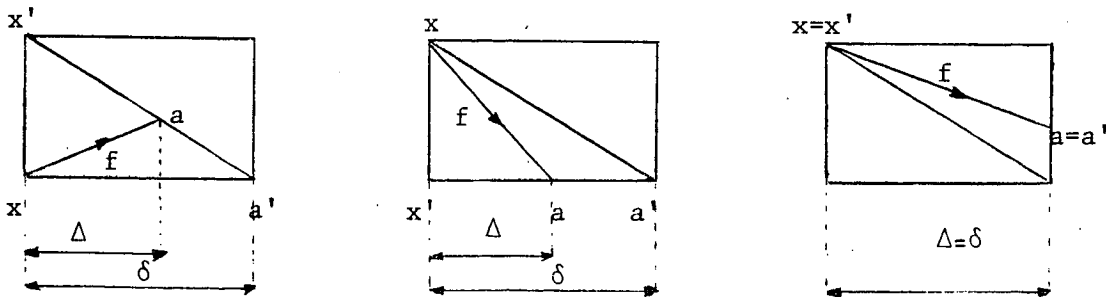

$$(a, t^a) = \frac{\Delta}{\delta} (a', t_{p+1}) + \left(1 - \frac{\Delta}{\delta}\right) (x', t_p) \quad (2.7)$$

Furthermore, taking in account that x' and a' are, in general, interior points of faces (or aristas) of some simplex, we will present this points as convex combinations of the vertices of the faces they are

belonging :

$$a(u) = \sum_j \lambda_j(x_p, t_q, u) x_j \quad (2.8)$$

$$x'(u) = \sum_j \hat{\lambda}_j(x_p, t_q, u) x_j \quad (2.9)$$

so, because (1.17) and the affinity of w^h , (2.1) becomes

$$\begin{aligned} w^h(x_p, t_q) \leq \min_{x \in U^h} \frac{1}{(1+\alpha\Delta)} \left\{ \frac{\Delta}{\delta} \sum_j \lambda_j(x_p, t_q, u) \cdot w^h(x_j, t_{q+1}) + \right. \\ \left. + (1 - \frac{\Delta}{\delta}) \sum_j \hat{\lambda}_j(x_p, t_q, u) w^h(x_j, t_q) + \Delta \ell(x_p, u, t_q) \right\}. \end{aligned} \quad (2.10)$$

In the same way we put

$$x_p + g(x_p, z, t_q) = \sum_j \lambda'_j(x_p, t_q, z) x_j \quad (2.11)$$

and (2.3) is rewritten in the equivalent form

$$w^h(x_p, t_q) \leq \min_{z \in Z^h} (q(x_p, z, t_q) + \sum_j \lambda'_j(x_p, t_q, z) w^h(x_j, t_p)) \quad (2.12)$$

$$\forall p = 0, N_x; q = 0, N_T - 1.$$

We will use (2.10) and (2.12) to define the real operator M , (w^h denotes a linear finite element in Q^h) :

$$\text{if } q = N_T \quad (Mw^h)(x_p, t_q) = 0$$

$$\text{if } q = 0, \dots, N_T - 1 \quad (Mw^h)(x_p, t_q) = \min\{\phi(x_p, t_q),$$

$$\min_{z \in Z^h} (q(x_p, z, t_q) + \sum_j \lambda'_j(x_p, t_q, z) w^h(x_j, t_q))\}, \quad (2.13)$$

$$\min_{u \in U^h} \frac{1}{1+\alpha\Delta} \left[\frac{\Delta}{\delta} \sum_j \lambda_j(x_p, t_q, z) w^h(x_j, t_{q+1}) + \right. \\ \left. + (1 - \frac{\Delta}{\delta}) \sum_j \hat{\lambda}_j(x_p, t_q, u) w^h(x_j, t_q) + \ell(x_p, u, t_q) \right].$$

After (2.13) we define Mw^h for all point of Q^h by a linear interpolations of the values in the vertices of the triangulation.

Some properties of Mw^h of immediat verification are :

$$w^h \geq \hat{w}^h \rightarrow Mw^h \geq M\hat{w}^h \quad (2.14)$$

$$w^h \in W^h \iff w^h \leq Mw^h \quad (2.15)$$

Remark : (2.15) give us a characterization of W^h .

Finally the most important property is given by

THEOREM 2.1 :

There exists \bar{w}^h , maximum element of W^h ; furthermore \bar{w}^h is characterized by the condition $\bar{w}^h = M\bar{w}^h$, i.e.

$$\bar{w}^h = M\bar{w}^h \iff \bar{w}^h \geq w^h, \quad \forall w^h \in W^h. \quad (2.16)$$

Proof

We can follow what it was done in Theorem I.2.2, using this new formulation of the DISCRETE MAXIMUM PRINCIPLE :

LEMMA 2.1 :

Let us call S^h a subset of all vertices of Q^h and C^h its complementary. Let be w^h some linear finite element defined in Q^h such

that $w^h(x_p, t_{N_T}) \leq 0$, and $r : \Omega \times U \times [0, T] \rightarrow \mathbb{R}$.

If exists $U_{p,q} \subset U^h$ such that $\forall (x_p, t_q) \in C^h$,

$$\min_{u \in U_{p,q}} \left[\frac{\partial w^h(x_p, t_q; u)}{\partial t} + \frac{\partial w^h(x_p, t_q; u)}{\partial u} \|f(x_p, u, t_q)\| + r(x_p, u, t_q) - \alpha w^h(x_p, t_q) \right] \geq 0 \quad (2.17)$$

then

$$w^h(x_p, t_q) \leq M_{S^h}^+ + M_r^+ \cdot T, \quad \forall (x_p, t_q) \in C^h \quad (2.18)$$

with

$$M_{S^h}^+ = \max_{(x_p, t_q) \in S^h} (w^h(x_p, t_q) \vee 0) \quad (2.19)$$

$$M_r^+ = \max_{\substack{(x_p, t_q) \in C^h \\ u \in U_{p,q}}} (r(x_p, u, t_q) \vee 0) \quad (2.20)$$

We show the lemma.

Let us define

$$M_{C_q} = \max_{\substack{(x_p, t_q) \\ q \leq q' \leq N_T}} w^h(x_p, t_q); \quad (2.21)$$

(2.18) will be proved after showing that

$$M_{C_q} \leq M_{S^h}^+ + M_r^+(T - t_q) \quad (2.22)$$

holds for any $q = 0, 1, \dots, N_T$. We will proceed inductively.

We know after (2.5) that (for $q = N_T$) $M_{C_{N_T}} \leq 0$; then

$$M_{S_h}^+ + M_r^+(T-t_{N_T}) = M_{S_h}^+ \geq 0 \geq M_{C_{N_T}}. \quad (2.23)$$

Now we will suppose that (2.22) holds for q and we will show that such supposition implies that it holds for $q-1$. Let be $(x_p, t_{q-1}) \in C^h$. From (2.17) used in its equivalent form (2.10), we have

$$\begin{aligned} w^h(x_p, t_{q-1}) \leq \min_{u \in U_{p, q-1}} & \frac{1}{1+\alpha\Delta} \left\{ \frac{\Delta}{\delta} \sum_j \lambda_j(x_p, t_{q-1}, u) w^h(x_j, t_q) + \right. \\ & + (1 - \frac{\Delta}{\delta}) \sum_j \hat{\lambda}_j(x_p, t_{q-1}, u) w^h(x_j, t_{q-1}) + \\ & \left. + r(x_p, u, t_{q-1}) \Delta \right\}. \end{aligned} \quad (2.24)$$

$$\text{If } \forall (x_p, t_{q-1}) \in C^h, w^h(x_p, t_{q-1}) \leq M_{S_h}^+ + M_r^+(T-q\delta) \quad (2.25)$$

it follows that, putting $q-1$ at the place of q in the second member, it is also $w^h(x_p, t_{q-1}) \leq M_{S_h}^+ + M_r^+(T-(q-1)\delta)$, that is to say (2.22) holds for $q-1$. If (2.25) does not hold, it exists (x_p^*, t_{q-1}^*) such that

$$w^h(x_p^*, t_{q-1}^*) = M_{C_{q-1}} > M_{S_h}^+ + M_r^+(T-q\delta) \quad (2.26)$$

or, in other words

$$w^h(x_p, t_{q-1}) \leq M_{C_{q-1}}, \quad \forall p = 0, N_x \quad (2.27)$$

On the other hand, as we have accepted that (2.22) holds for q :

$$w^h(x_p, t_q) \leq M_{S_h}^+ + M_r^+(T-q\delta); \quad (2.28)$$

then, using (2.27), (2.28) in (2.24)

$$M_{C_{q-1}} \leq \min_{u \in U_{p, q-1}} \frac{1}{1+\alpha\Delta} \left\{ \frac{\Delta}{\delta} (M_{S^h}^+ + M_r^+(T-q\delta)) + \left(1 - \frac{\Delta}{\delta}\right) M_{C_{q-1}} + M_r^+\Delta \right\} .$$

From here, as $\frac{1}{1+\alpha\Delta} < 1$, $\Delta \leq \delta$ we have

$$M_{C_{q-1}} \leq M_{S^h}^+ + M_r^+(T-(q-1)\delta) . \quad \square$$

2.3. Algorithms to compute \bar{w}^h

To compute \bar{w}^h we can use the following algorithms (3.1) and (3.2). These algorithms, as the algorithm (I.2.34) used in the stationary case, define increasing elements $w_p^h \in W^h$, having \bar{w}^h as limit.

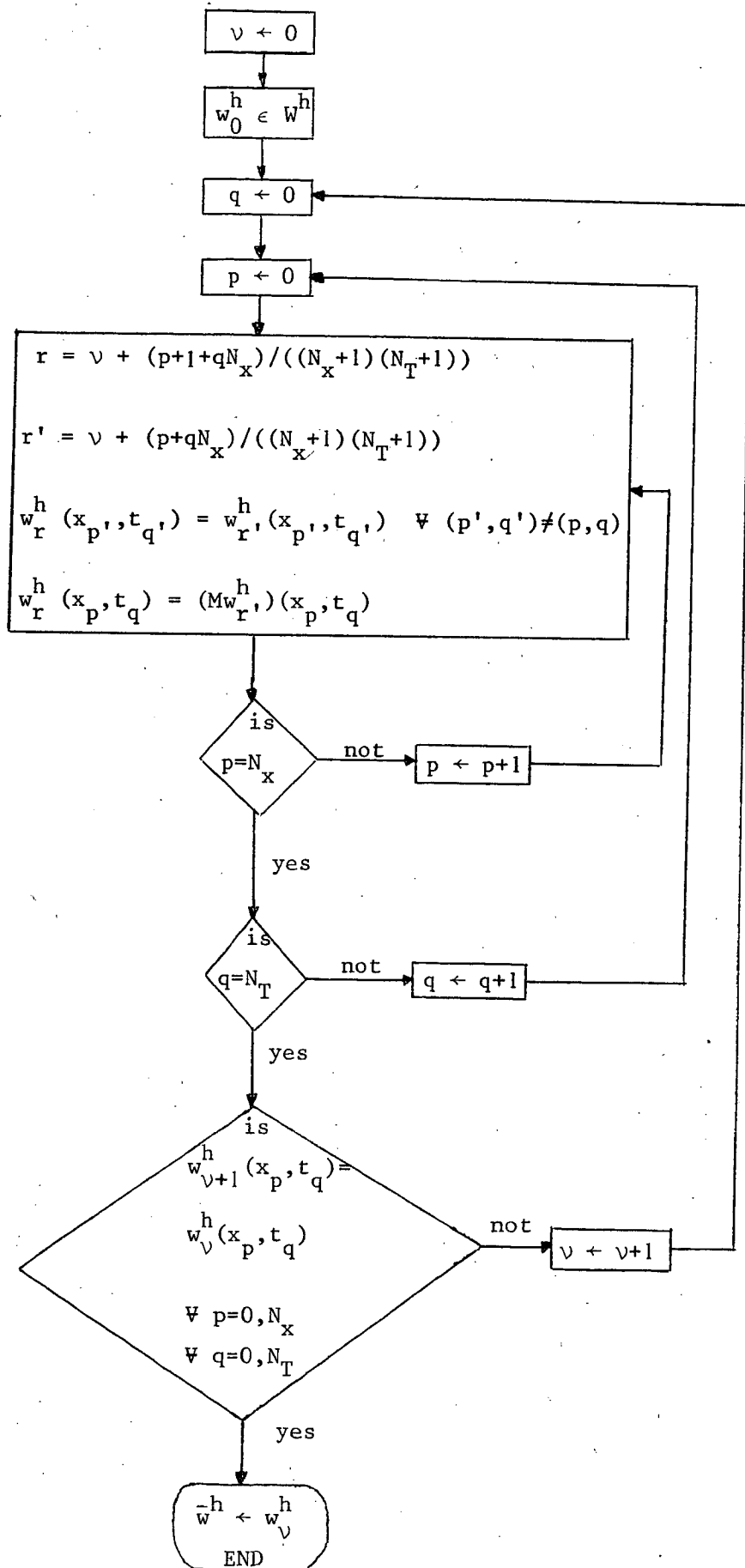

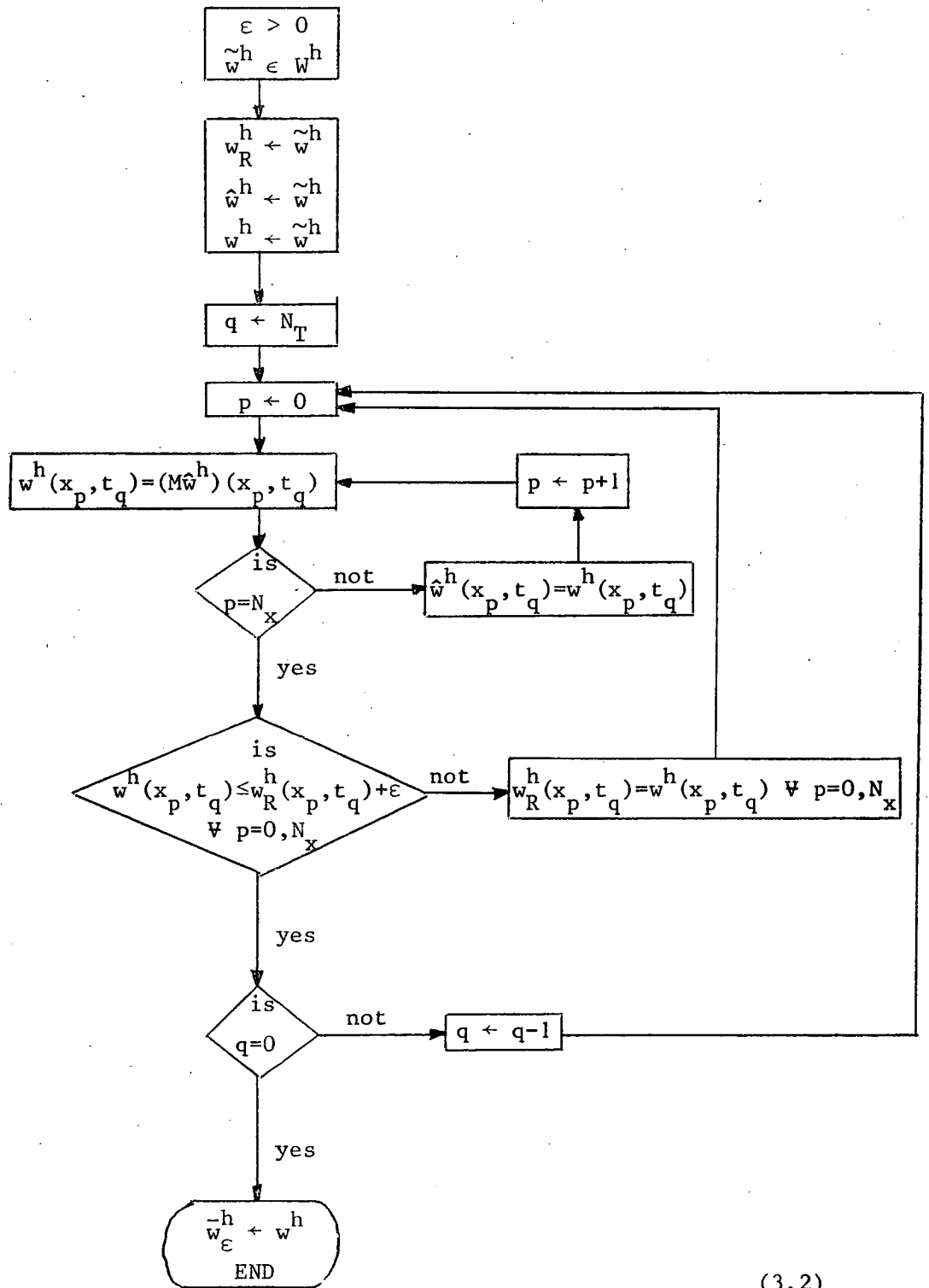

(3.2)

In fact, it is possible to show the following theorems :

THEOREM 3.1 :

The algorithm (3.1) stops after a finite number of steps in the element $w_{\nu}^h = \bar{w}^h$ or it gives a sequence $\{w_{\nu}^h\}$ convergent to \bar{w}^h , i.e.

$$\lim_{\nu \rightarrow \infty} w_{\nu}^h(x_p, t_q) = \bar{w}^h(x_p, t_q) \quad , \quad \forall p=0, N_x ; \forall q = 0, N_T .$$

THEOREM 3.2 :

The algorithm 3.2 stops after a finite number of iterations in the element \bar{w}_{ϵ}^h , having the following properties

a) $\bar{w}_{\epsilon}^h \in W^h \quad , \quad \forall \epsilon > 0$

b) $\epsilon \leq \epsilon' \rightarrow \bar{w}_{\epsilon}^h \geq \bar{w}_{\epsilon'}^h$

c) $\lim_{\epsilon \rightarrow 0} \bar{w}_{\epsilon}^h = \bar{w}^h .$

Remark : algorithm (3.2) is the consequence of improving algorithm (3.1) taking advantage of the particular structure of non-stationary problems (we use backward solutions).

2.4. The convergence of the approximate solutions

It is possible to show an equivalent theorem of Theorem I.3.2.

THEOREM 4.1 :

The approximate solutions \bar{w}^h converges uniformly to $V(x,t)$, i.e.

$$\lim_{||h|| \rightarrow 0} \max_{(x,t) \in Q^h} |\bar{w}^h(x,t) - V(x,t)| = 0 .$$

II.3. An application to the management of energy production

3.1. Modelisation of the problem (Short-run model)

The energy production system consists in two thermal power plants (P_1, P_2 being their level of production) and a dam (x_h : hydropower stock ; P_h : hydropower production). D is the demand of electricity and we denote with P_3 the production of an additional source to obtain, if it is necessary

$$D = P_1 + P_2 + P_h + P_3 \quad (3.1)$$

The cost of the operation is given by

$$J = \int_0^T (c_1 P_1(t) + c_2 P_2(t) + c_h(x_h(t)) P_h(t) + c_3 P_3(t)) dt + n_1 \bar{k}_1 + n_2 \bar{k}_2 \quad (3.2)$$

n_1, n_2 is the number of starts of centrals 1, 2 in the interval $[0, T]$; k_1, k_2 the costs of each start. We suppose c_1, c_2, c_3 constants and $c_h(x_h)$ is a shadow price obtained after a long-run optimization (about one year). In our problem we will consider $[0, T]$ one day or one week (cfr. [12], [14], [15]).

We will suppose that there are not delays between the start of a thermal central and the instants in which they begin to produce energy. The methodology to be used here can be easily modified to take into account these delays (cfr. [11], [12], [16]).

In this form the system will be model by its internal state : a discrete variable E (showing if the centrals 1 and 2 are working or not) and a continuous variable x_h which evolution equation is

$$\frac{dx_h}{dt} = A(t) - P_h(t) \quad 0 \leq x_h \leq x_{h,\max} \quad (3.3)$$

$A(t)$ is the input of water in the dam.

$$E = \begin{cases} 1 & \text{centrals 1 and 2 dot not work} \\ 2 & \text{central 1 works ; central 2 does not work} \\ 3 & \text{central 1 does not work ; central 2 works} \\ 4 & \text{central 1 and 2 work} \end{cases}$$

Our aim is to obtain the control strategy giving the minimum of J . This optimal policy consists in to define when centrals 1 and 2 must to work and with what level of production. We look for optimal feed-back policies taking with account the instantaneous state $(E(t), x_h(t))$ of the system.

3.2. Optimal feed-back policies

Let us consider as parameters the initial state x and the initial time t of the system and let us introduce the optimal cost functions $V_i(x, t)$, $i = 1, 4$, $(x, t) \in Q = [0, x_{h,\max}] \times [0, T]$,

$$V_i(x, t) = \inf_{P_1(\cdot), P_2(\cdot), P_h(\cdot)} J(x_h, i, t, P_1(\cdot), P_2(\cdot), P_h(\cdot)) \quad (3.4)$$

with $J(x_h, i, t, P_1(\cdot), P_2(\cdot), P_h(\cdot)) =$

$$\begin{aligned} & \int_t^T (c_1 P_1(s) + c_2 P_2(s) + c_h(x_h(s)) P_h(s) + c_3 P_3(s)) ds + \\ & + n_1 \bar{k}_1 + n_2 \bar{k}_2 \end{aligned} \quad (3.5)$$

cost related to the policy $P_1(\cdot), P_2(\cdot), P_h(\cdot)$ in the interval $[t, T]$ with the initial data $(E(t), x_h(t)) = (i, x_h)$.

From $V_i(x, t)$ it is possible to define the optimal feed-back policies (cfr. [2], [3], [9]). So, our problem is to compute $V_i(x, t)$. We recall for that the following :

3.3. Quasi-variational inequalities (QVI) associated to the control problem and characterization of V_i

It is possible to show (cfr. [5], [9]) that V_i are differentiable in a.e. $(x, t) \in Q$. Furthermore they verify (cfr. [2], [9], [12]) the system of Q.V.I. :

$$\begin{aligned} \frac{\partial V_i}{\partial t} + \min_{(P_1, P_2, P_3) \in \Gamma_i(x_h)} \left(\frac{\partial V_i}{\partial x_h} \cdot (A - P_h) + c_1 P_1 + c_2 P_2 + \right. \\ \left. + c_3 (D - P_1 - P_2 - P_h)^+ + c_h(x_h) P_h \right) \geq 0 \end{aligned} \quad (3.6)$$

$$V_i(x_h, t) \leq V_j(x_h, t) + k_j^i, \quad \forall j \neq i \quad (3.7)$$

$$V_i(x_h, T) = 0 \quad (3.8)$$

with $\Gamma_i(x_h)$ the set of admissible levels of production related to the state i and the stock x_h ; k_j^i the cost for passing from state i to state j .

REMARK In a.e. $(x, t) \in Q$, one, at least, of (3.6), (3.7) becomes an equality.

The following characterization of $V_i(x, t)$ will allow us to compute it using the method introduced in II.2 :

$V_i(x, t)$ is the maximum element of the set

$$W_i = \{w_i \in H^{1, \infty}(Q) / w_i \text{ verifies } (3.6), (3.7), (3.8)\} \quad (3.9)$$

$i = 1, 2, 3, 4$, i.e.

$$w_i(x, t) \leq V_i(x, t), \quad \forall (x, t) \in Q, \quad \forall w_i \in W_i, \quad i = 1, 2, 3, 4.$$

3.4. Discretization of (3.9) and the discrete problem.

Let us introduce in Q a triangulation Q^a and let us consider in it linear finite elements of vertices (x_p, t_q) . The set W is substituted by the approximate set W^a having as elements, linear finite elements $w^a = (w_i^a)$ satisfying suitable discretizations of (3.6), (3.7), (3.8) :

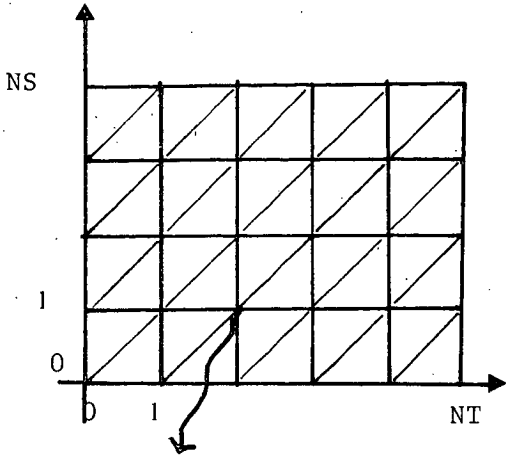

$$(x_p, t_q) \quad p=0, NS \quad q=0, NT$$

If $A - P_h \geq 0$:

$$\begin{aligned} & \frac{w_i^a(x_p, t_{q+1}) - w_i^a(x_p, t_q)}{t_{q+1} - t_q} + \frac{w_i^a(x_{p+1}, t_{q+1}) - w_i^a(x_p, t_{q+1})}{x_{p+1} - x_p} (A - P_h) + \\ & + c_1 P_1 + c_2 P_2 + c_h(x_p) P_h + c_3 (D - P_1 - P_2 - P_h)^+ \geq 0 \end{aligned} \quad (3.10)$$

$$\forall (P_1, P_2, P_h) \in \Gamma_i^a(x_p) ; \forall p = 0, \dots, NS-1, \forall q = 0, \dots, NT-1$$

If $A - P_h < 0$:

$$\begin{aligned} & \frac{w_i^a(x_p, t_{q+1}) - w_i^a(x_p, t_q)}{t_{q+1} - t_q} + \frac{w_i^a(x_{p-1}, t_q) - w_i^a(x_p, t_q)}{x_{p-1} - x_p} (A - P_h) + \\ & + c_1 P_1 + c_2 P_2 + c_h(x_p) P_h + c_3 (D - P_1 - P_2 - P_h)^+ \geq 0 \end{aligned} \quad (3.10')$$

$$\forall (P_1, P_2, P_h) \in \Gamma_i^a(x_p) ; \forall p = 1, \dots, NS \quad ; \quad \forall q = 0, \dots, NT-1$$

$$w_i^a(x_p, t_q) \leq w_j^a(x_p, t_q) + k_j^i, \quad \forall p = 0, NS; \forall q = 0, NT-1; \quad (3.11)$$

$$\forall i; \forall j \neq i;$$

$$w_i^a(x_p, t_{NT}) = 0 \quad \forall p = 0, NS, \quad \forall i = 1, 4 \quad (3.12)$$

We put the following discrete problem :

(P^a) : Find the maximum element \bar{w}^a of W^a .

After Theorem I.2.2. and Theorem II.2.1., we know that \bar{w}^a exists and it is unique. We can also introduce an algorithm with the properties remarked in II.2.3. In fact, after a suitable transformation of (3.10), (3.10') in relations of the following type

$$w_i^a(x_p, t_q) \leq \phi_i^a(w_i^a(x_p, t_{q+1}), w_i^a(x_{p-1}, t_q), w_i^a(x_{p+1}, t_{q+1}), x_p, t_q) \quad (3.13)$$

we define the

Algorithm

Step 0 : $\tilde{w}_i^a(x_p, t_q) = w_i^a(x_p, t_q) = 0, \quad \forall i = 1, 4, \quad \forall p = 0, NS, \quad \forall q = 0, NT$

Step 1 : $q = NT-1$

Step 2 : $p = 0$

Step 3 : $i = 1$

Step 4 : $w_i^a(x_p, t_q) = \min \{w_j^a(x_p, t_q) + k_j^i (j \neq i); \phi_i^a(w_i^a, \dots, x_p, t_q)\}$

Step 5 : if $i = 4$ go to 6 ; if not, $i = i+1$ and go to 4

Step 6 : if $\tilde{w}_i^a(x_p, t_q) = w_i^a(x_p, t_q), \quad \forall i = 1, 4,$ go to 7 ; if not do

$$\tilde{w}_i^a(x_p, t_q) = w_i^a(x_p, t_q), \quad \forall i = 1, 4 \text{ and go to 3}$$

Step 7 : if $p = NS$ go to 8 ; if not do $p = p+1$ and go to 3

Step 8 : if $q > 0,$ do $q = q - 1$ and go to 2 ; if not, do $w_i^a(x_p, t_q) = w_i^a(x_p, t_q), \quad \forall i = 1, 4, \quad \forall p = 0, NS; \quad \forall q = 0, NT$ and stop.

REMARK

The algorithm is very easy to program ; it uses only "local" information (i.e. to compute $w^a(x_p, t_q)$ it uses only $w^a(x_{p-1}, t_q)$, $w^a(x_p, t_{q-1})$, $w^a(x_{p+1}, t_{q+1})$). So it is possible to implement it in computers of small central memory.

We recall also that the algorithm converges in a finite number of iterations to \bar{w}^a and $\lim_{\|a\| \rightarrow 0} \max_{(x,t) \in Q} |\bar{w}_i^a(x,t) - V_i(x,t)| = 0$, with $\|a\|$ the norm of the triangulation Q^a .

3.5. Some remarks before numerical results

We will solve a simplified model with the datas used in [12] having origin is a real demand. The demand will has the following form :

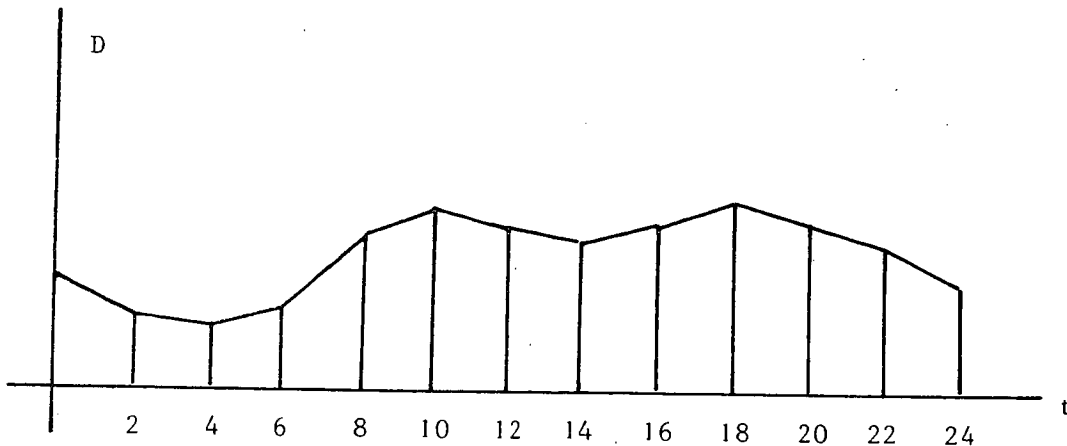

The hydraulic cost will be

$$c_h(x_h) = c_{h_1} + (c_{h_2} - c_{h_1}) x_h / x_{h,\max} \quad (3.14)$$

$$c_{h_1} = 0.1 ; c_{h_2} = 0.06 ; x_{h,\max} = 5000 \text{ MWh}$$

Other datas are :

$$P_1 \in [P_{1\min}, P_{1\max}] = [250, 500] \quad (\text{MW}) \quad (3.15)$$

$$P_2 \in [P_{2\min}, P_{2\max}] = [125, 250] \quad (\text{MW}) \quad (3.16)$$

$P_h \in [0, P_{hmax}(x_h)]$ with

$$P_{hmax} \begin{cases} = P_{h1}, \forall s.x_{hmax} \leq x_h \leq x_{hmax}, s = 0.3 \\ P_{h1} = 250 \text{ MW} \\ = \frac{x_h}{s.x_{hmax}} \cdot P_{h1}, \forall 0 \leq x_h \leq s.x_{hmax} \end{cases} \quad (3.17)$$

$$A = 0 \text{ MW} \quad (3.18)$$

Having \bar{w}_1^a , the following device will be used to obtain the approximate feed-back optimal policies :

- We switch in our policy (that is to say, we start or we stop the work of a thermal generator) in the regions where (3.11) becomes an equality. For example, if our system is in the state $(2, x_p, t_q)$ and $\bar{w}_2^a(x_p, t_q) = \bar{w}_4^a(x_p, t_q) + \bar{k}_2$ holds, we must pass to state 4 (starting with central 2). In this form we obtain tables of future states showing where and how we must switch.
- When (3.11) are strict inequalities, we must define the production level of thermopower centrals. For it we consider as optimal such level giving equalities in (3.10) or (3.10').
- Finally with the tables concerning future states and optimal production levels we obtain the optimal trajectories solving the differential equation (3.3).

3.6. Numerical results

The interval of time $[0, T]$ is taken of 8 days. We use $NT = 192$; so the length of the discretized time is 1 hour. We use $NS = 18$; as $X_{hmax} = 5000\text{MWh}$ we obtain 277 MWh for each step. We divide each interval of thermal power production in six values ($P_1 = 250, 300, 350, 400, 450, 500 \text{ MW}$; $P_2 = 125, 150, 175, 200, 225, 250 \text{ MW}$). The values of the cost to

start a power plant are $\bar{k}_1 = 0.5775 \times 10^5$, $\bar{k}_2 = 0.325 \times 10^5$.

In the algorithm the iterative part concerns steps 3 to 6. It converges in a finite number of iterations. An example is given in the following table (in which the values are divided by 10^5) :

	w	w	w	w
	1	2	3	4
0	0	0	0	0
1	.325	.325	.325	.325
2	.650	.55917	.650	.55917
3	.975	.55917	.71641	.55917
4	.98241	.55917	.71641	.55917
5	.98241	.55917	.71641	.55917

The program give as out put sub-optimal policies (future state E_f and production level to be generated) as fonctions of the state E_p , x_h of the system :

E_p	E_f	P_h	P_1	P_2	P_3	W
1	2	.00000D+01	.40000D+06	.00000D+01	.11670D+05	.91130D+06
2	2	.00000D+01	.40000D+06	.00000D+01	.11670D+05	.85355D+06
3	4	.00000D+01	.30000D+06	.12500D+06	.00000D+01	.90549D+06
4	4	.00000D+01	.30000D+06	.12500D+06	.00000D+01	.84774D+06

With these values we prepare the operation tables (as functions of (x_h, t)) that are shown in the following pages. We have choosen those refered to the day wednesday. In one table we give the future state ; in the other the power level to produce.

Example : If we are in the table $E_p = 1$ of future states and in the intersection of lines (x_h, t) we read $E_f = 4$ that means that at time t , if the stock of hydraulic energy is x_h , both centrals, 1, 2, must work. To know the production level we obtain, from the table $E_p = 1$ of power production the two values ; i.e. if we read 350 that means $P_1 = 350$, $P_2 = 125$.

125

If in the table of future states the place is empty we must continue with the same state E_p .

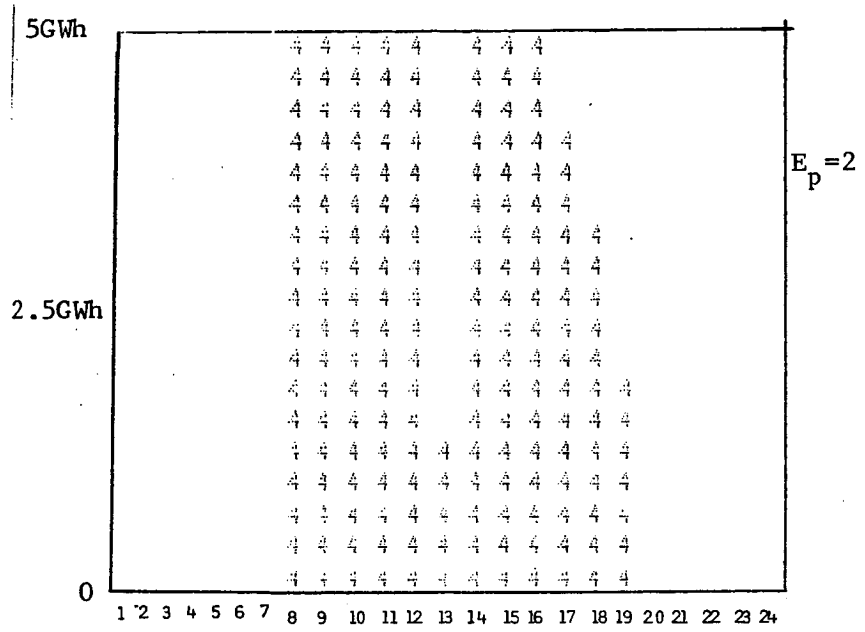

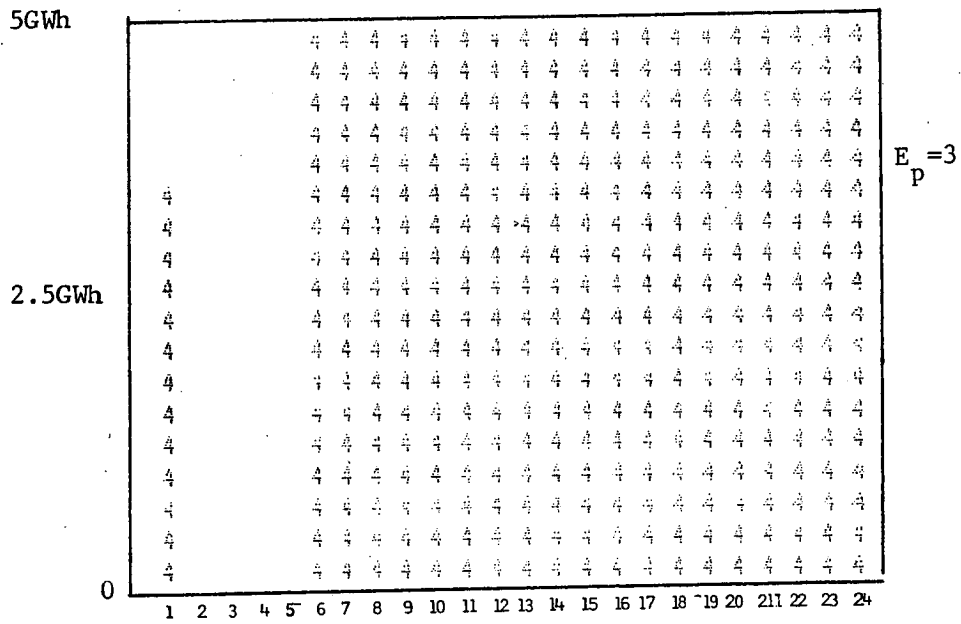

Simulation of one operation

We show in the following pages a sub-optimal evolution of the system ; it was obtained using the precedent tables with $E_p(o) = 2$, $X_h(o) = 5000$ MWh as initial conditions.

FIRST DAY - Monday

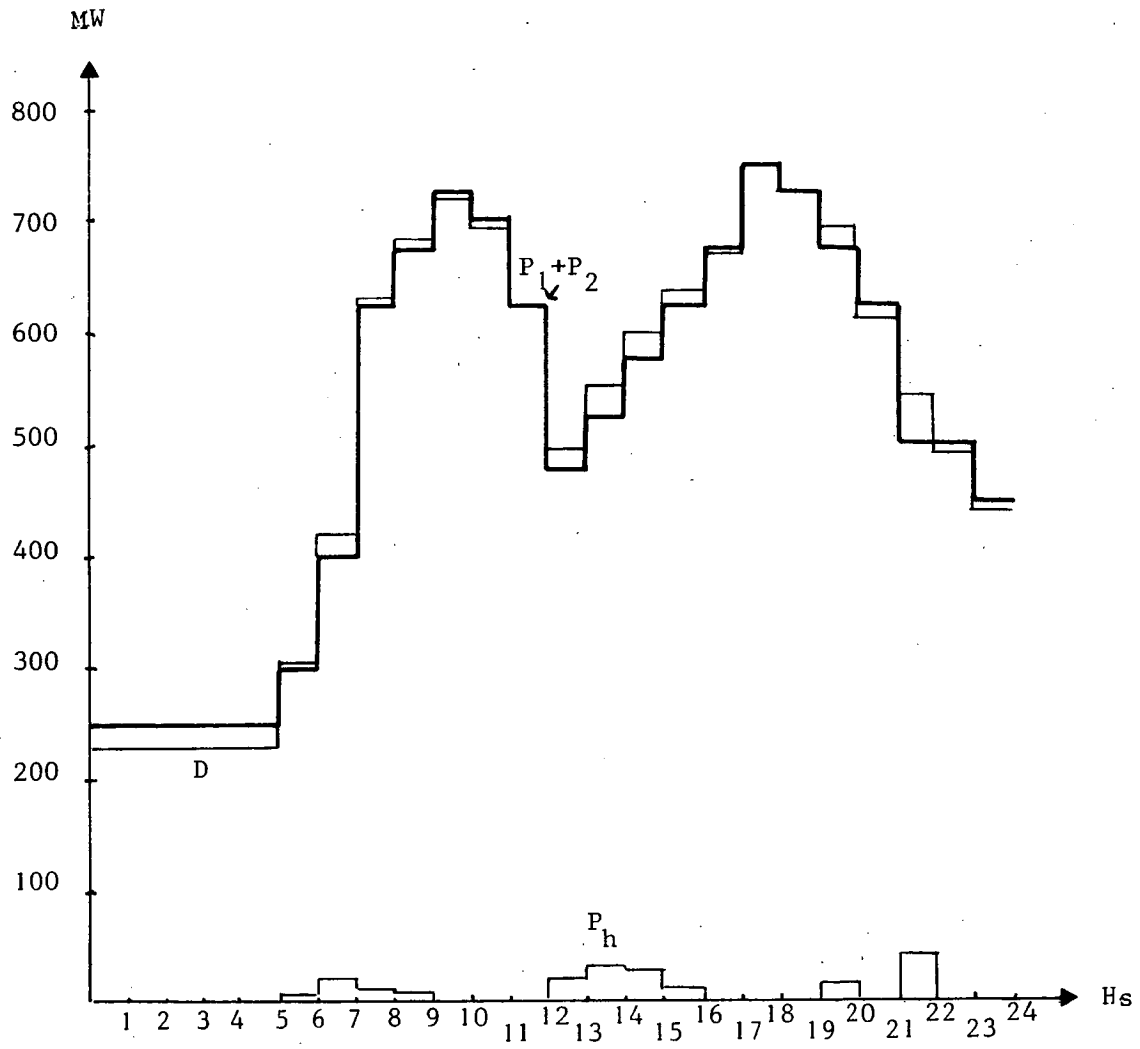

SECOND DAY - Tuesday

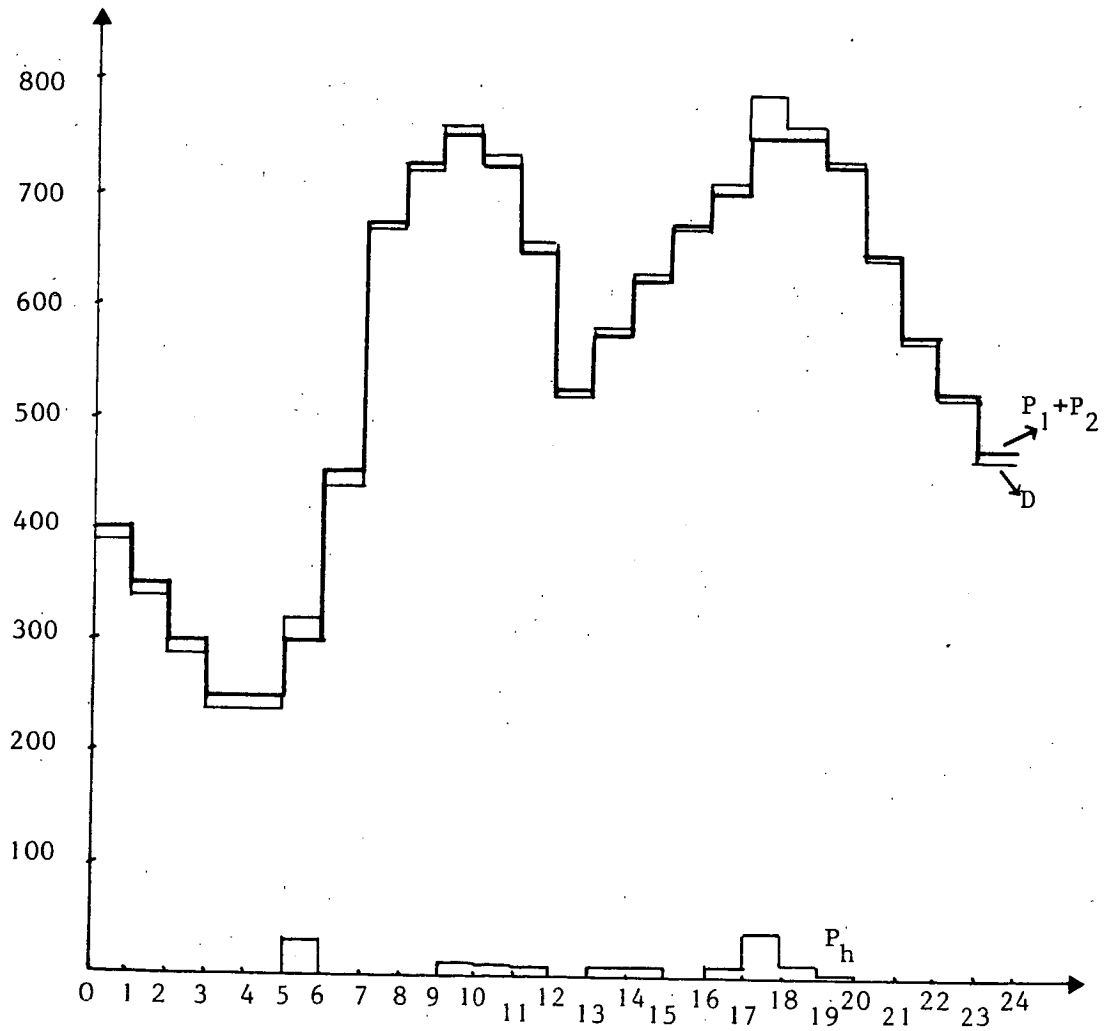

THIRD DAY - Wednesday

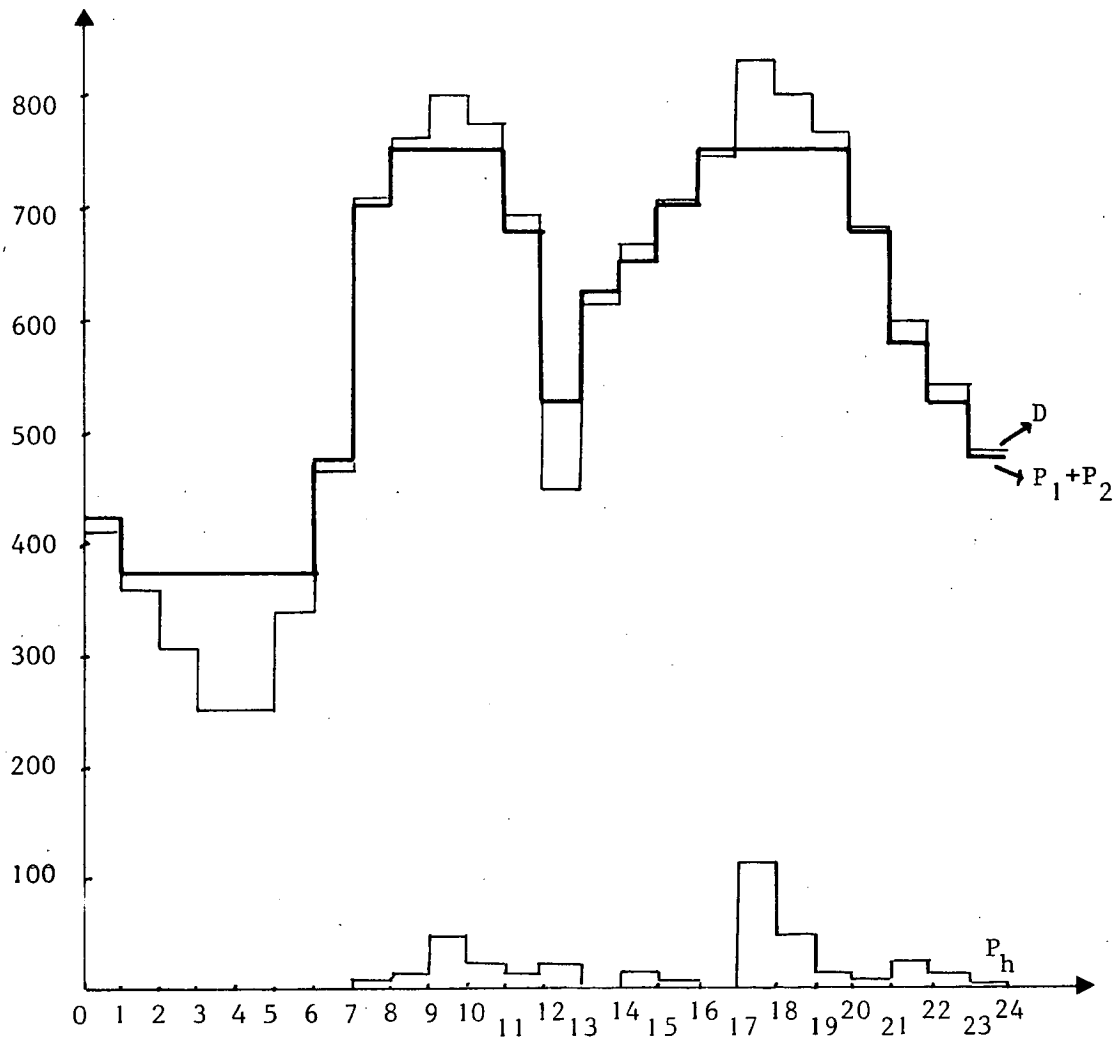

FOURTH DAY - Thursday

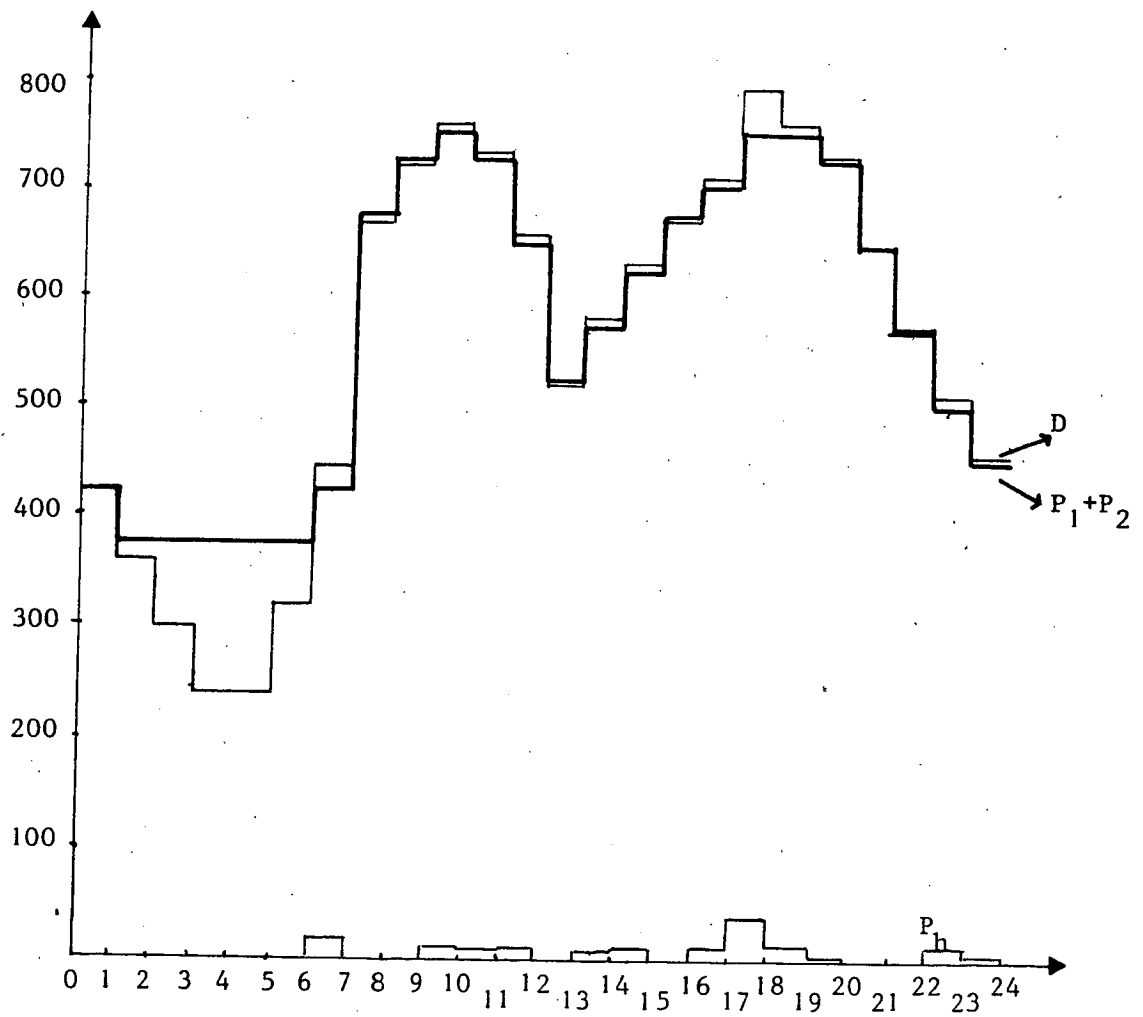

FIFTH DAY - Friday

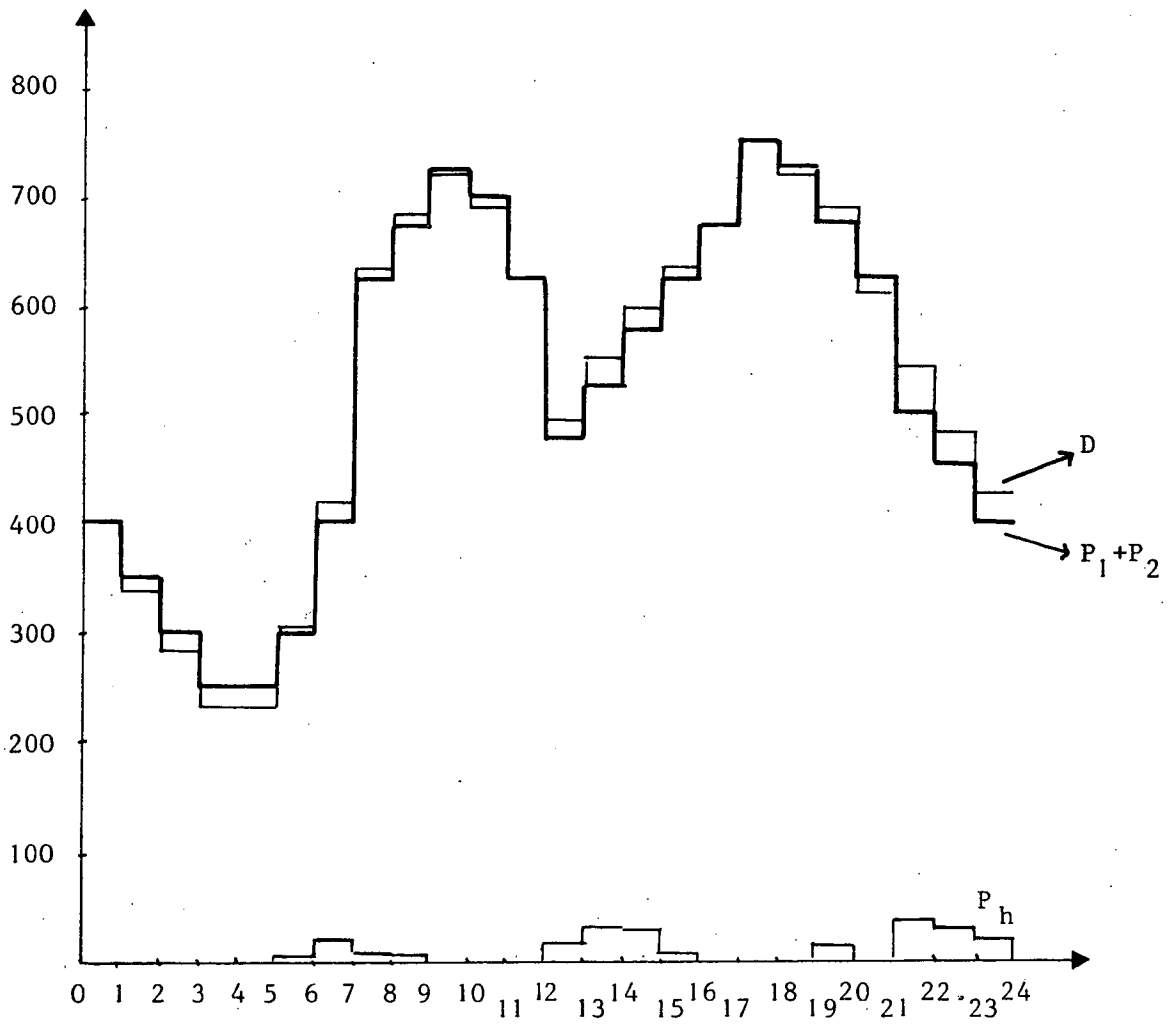

SIXTH DAY - Saturday

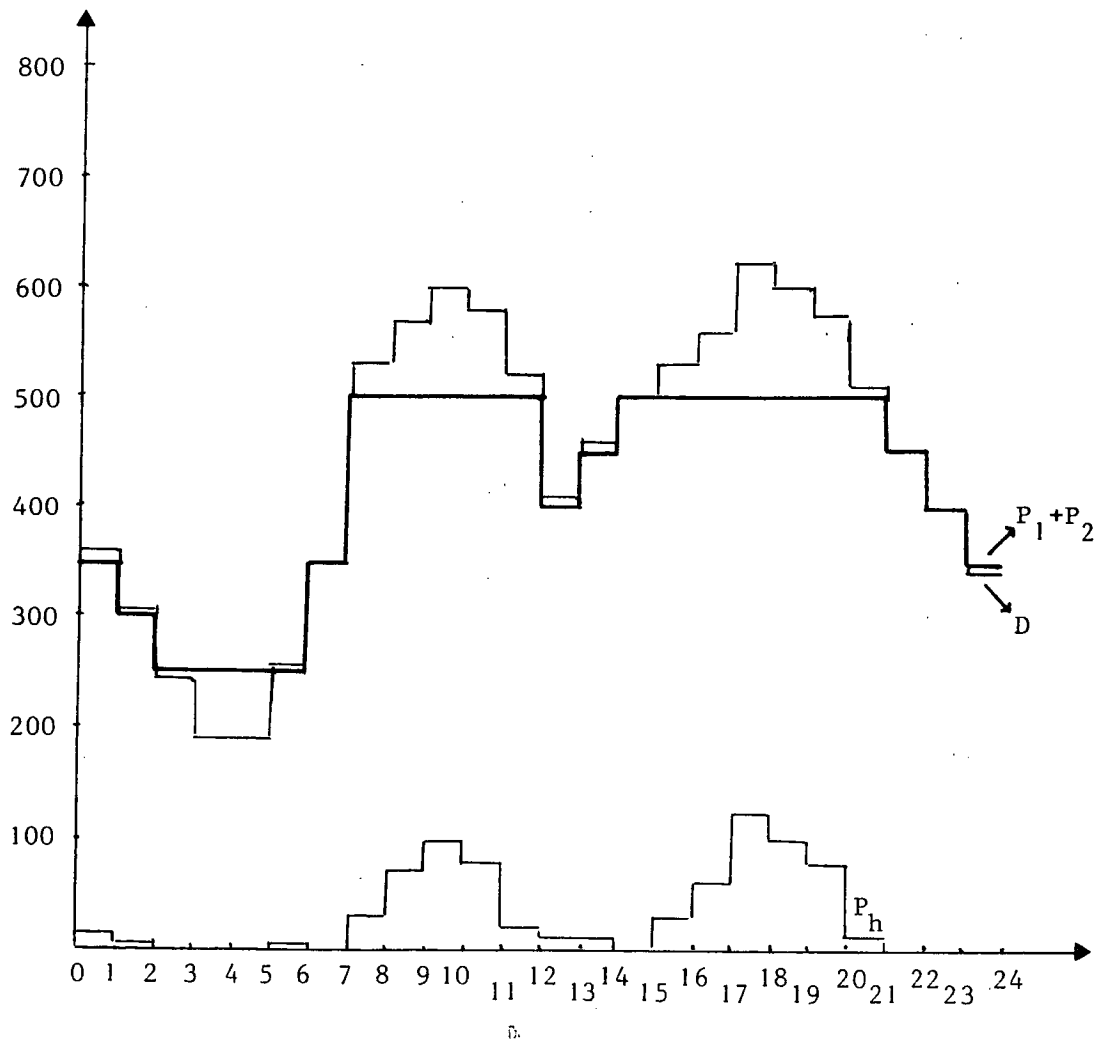

SEVENTH DAY - Sunday

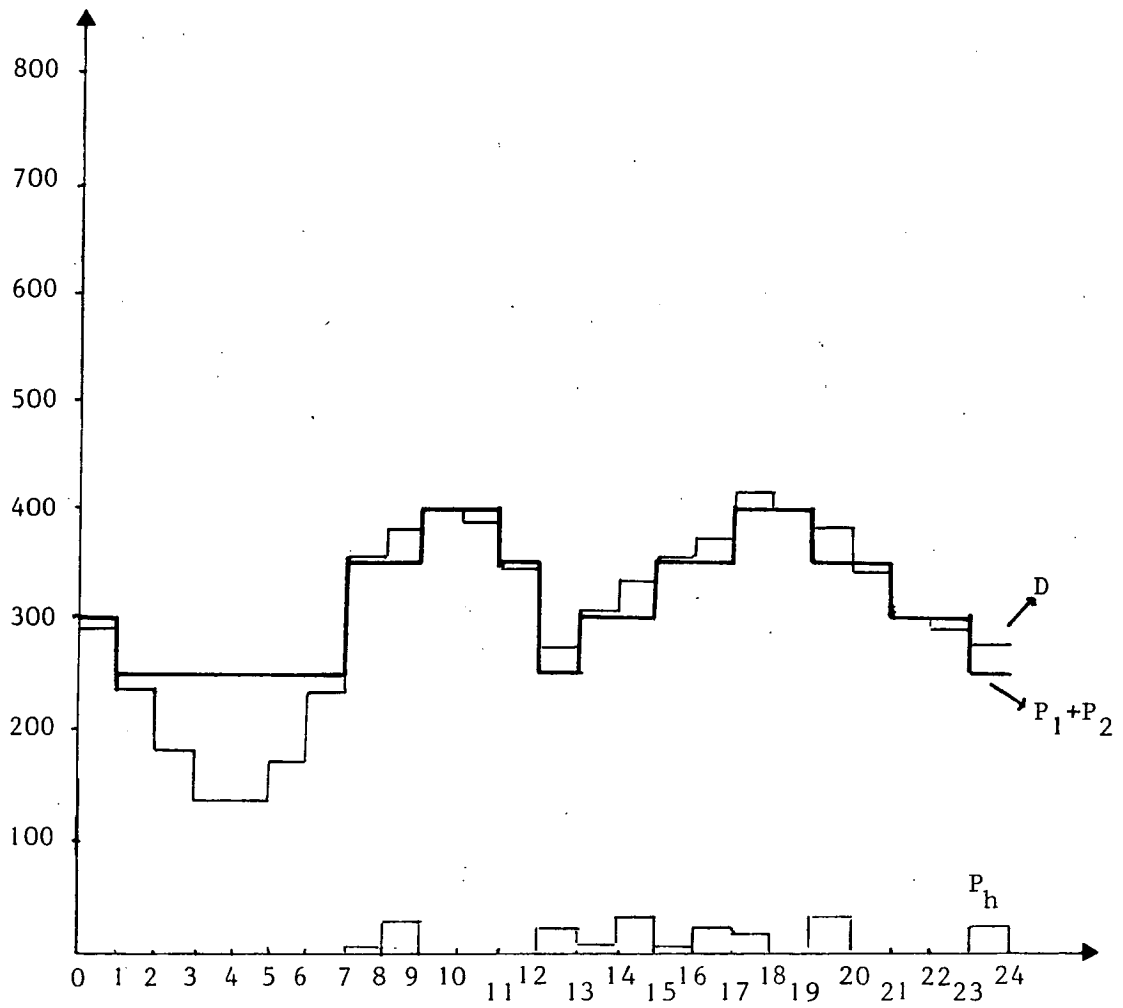

Time of computation and final remarks

The algorithm converges independently of the choice of $(w^h)_o \in W^h$ and of the order of numeration of the vertices. Nevertheless for each problem it is possible to analyze if some special choices give an improvement of the convergence (and of course, a reduction of the computation time).

In our problem the vertices were ordered in the sense of x increasing but in decreasing sense for the time.

On the other hand a choice for $(w^h)_o$ can always be the trivial choice $w_o^h \equiv - \left(\frac{M_\lambda}{\alpha} + M_\phi \right)$; we did, looking for better results, two choices :

the first : $(w_i^h)_o \equiv 0$

the second : $(\tilde{w}_i^h(x_p^h, t_q^h))_o = \min_{\substack{i=1,4 \\ p=0,NS}} \tilde{w}_i^h(x_p^h, t_{q+1}^h), \forall q=0, NT-1$

This last choice was possible because $\tilde{w}_i^h(x_p^h, t_{NT}^h) \equiv 0$ and functions $\tilde{w}_i^h(., t_{q+1}^h)$ can be computed, in our algorithm, after knowing $\tilde{w}_i^h(., t_q^h)$, $q' = q+2, \dots, NT$. The following table shows that for T (time of operation in hours of our electric system) increasing, the second choice is much better. The picture point out the (linear and parabolic) behaviour of the time of computation. We have used a PDP 11/23 (128K, operative system RT 11/XM). As a last information, using a minicomputer COMPUSYST 2000 (64 K, operative system CPM, central proc. ZIL06 - Z80) for $T = 24$ hours we need 380 sec.

T	$w_o^h \equiv 0$	$(\tilde{w}_i^h)_o$
	computing time in secondes	
24	154	221
48	365	472
72	645	713
96	1 013	953
192	3 469	1 943

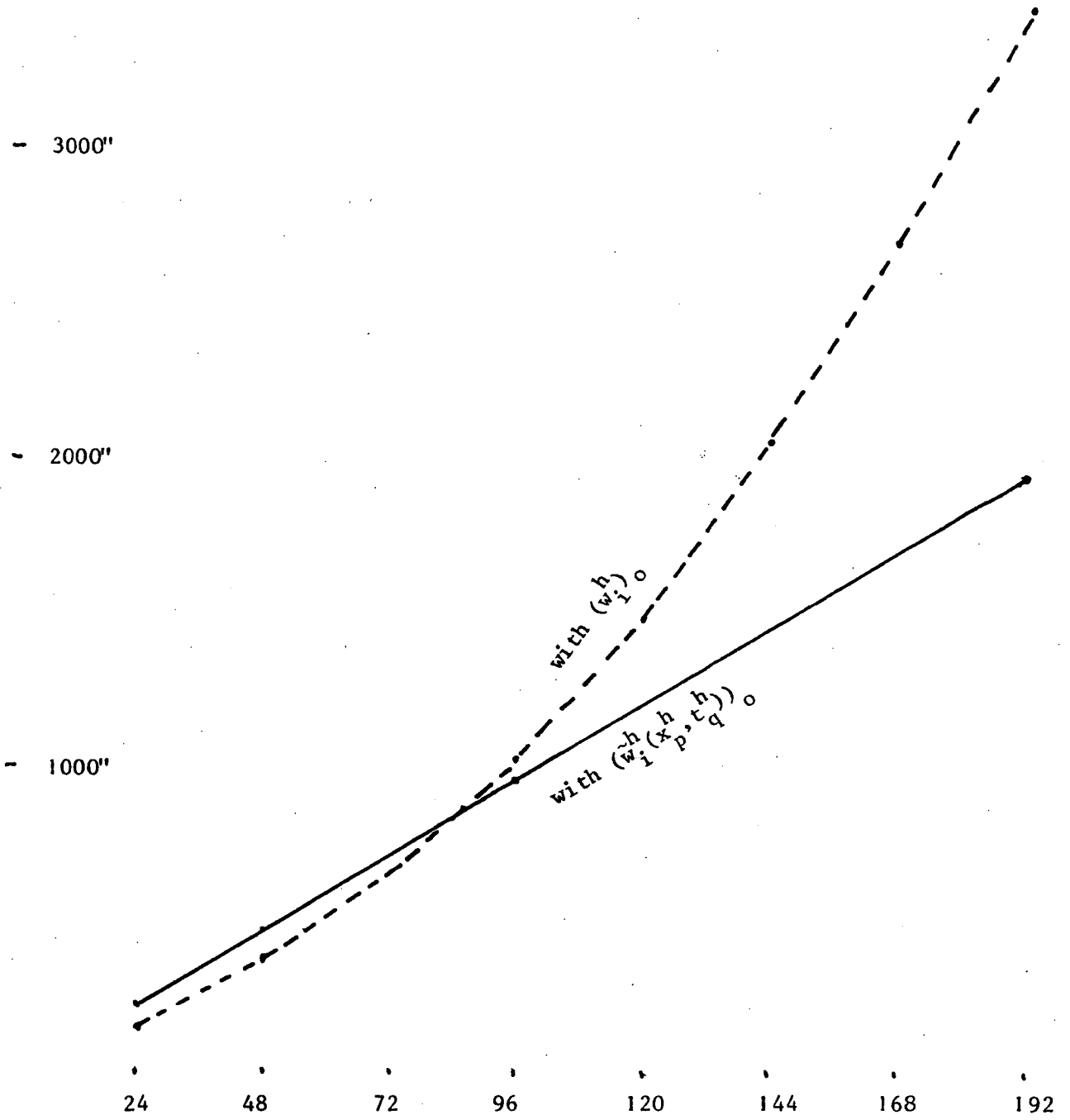

REFERENCIES

- 1 A. BENSOUSSAN - J.L. LIONS
Applications des inéquations variationnelles en contrôle stochastique.
Dunod, 1978.
- 2 A. BENSOUSSAN - J.L. LIONS
Contrôle impulsif et inéquations quasi-variationnelles.
A paraître.
- 3 W. FLEMING - R. RISHEL
Optimal deterministic and stochastic control.
Springer Verlag, 1975.
- 4 M.N. EL TAZI
Contraction et ordre partiel pour l'étude d'algorithmes synchrones
et asynchrones en analyse numérique.
Thèse d'Etat, Besançon, 1981.
- 5 A. FRIEDMAN
Differential games.
Wiley Interscience, 1971.
- 6 R. GLOWINSKI - J.L. LIONS - R. TREMOLIERES
Analyse numérique des inéquations variationnelles.
Dunod, 1976.
- 7 R. GONZALEZ
Sur l'existence d'une solution maximale de l'équation de Hamilton-
Jacobi.
C.R.A.S. Paris (1976), Serie A, 1287-1290.
- 8 R. GONZALEZ - E. ROFMAN
An algorithm to obtain the maximum solution of the Hamilton-Jacobi
equation.
Lectures Notes in Control and Information Sciences, Vol. 6, Springer-
Verlag, 1978.

- 9 R. GONZALEZ
 Sur la résolution de l'équation de Hamilton-Jacobi du contrôle déterministe.
 Thèse 3ème cycle, Université de Paris IX, 1980.
- 10 R. GONZALEZ - E. ROFMAN
 Iterative computation of the maximul solution of the Hamilton-Jacobi equation.
 V. Symposium of Op. Res., Verlag Anton Hain, Part I, Edited by R. Burkard, T. Ellinger.
- 11 R. GONZALEZ
 Optimal bang-bang control policies with restrictions of time between switchings.
 Mathematicae Notae, ano XXVII, pp. 111-137, 1979.
- 12 C. LEGUAY
 Application du contrôle stochastique à un problème de gestion optimale d'énergie.
 Thèse de Docteur-Ingénieur, Université de Paris IX, 1975.
- 13 P.L. LIONS - B. MERCIER
 Approximation numérique des équations de Hamilton-Jacobi-Bellman.
 RAIRO, Analyse Numérique, Vol. 14, n° 4, pp. 369-393, 1980.
- 14 J.P. QUADRAT - F. DELEBECQUE
 Contribution of stochastic control singular perturbation averaging and team theories to an example of large scale systems : management of hydropower production.
 IEEE. Trans. Aut. Control, Vol. 23, n° 2, pp. 209-222, 1978.
- 15 J.P. QUADRAT - F. DELEBECQUE - P. COLLETER - F. FALGARONE :
 Application du contrôle stochastique à la gestion des moyens de production d'énergie en Nouvelle Calédonie.
 Rapport Laboria, Rocquencourt.
- 16 M. ROBIN
 Contrôle impulsif des processus de Markov.
 Thèse d'Etat, Université de Paris IX, 1977.

