



**HAL**  
open science

## A new method of computing global elastic moduli for composite materials

D. Begis, A. Bestagno, G. Duvaut, A. Hassim, M. Nuc

► **To cite this version:**

D. Begis, A. Bestagno, G. Duvaut, A. Hassim, M. Nuc. A new method of computing global elastic moduli for composite materials. RR-0195, INRIA. 1983. inria-00076363

**HAL Id: inria-00076363**

**<https://inria.hal.science/inria-00076363>**

Submitted on 24 May 2006

**HAL** is a multi-disciplinary open access archive for the deposit and dissemination of scientific research documents, whether they are published or not. The documents may come from teaching and research institutions in France or abroad, or from public or private research centers.

L'archive ouverte pluridisciplinaire **HAL**, est destinée au dépôt et à la diffusion de documents scientifiques de niveau recherche, publiés ou non, émanant des établissements d'enseignement et de recherche français ou étrangers, des laboratoires publics ou privés.

# IRIA

CENTRE DE ROCQUENCOURT

Institut National  
de Recherche  
en Informatique  
et en Automatique

Domaine de Voluceau  
Rocquencourt  
BP 105  
78153 Le Chesnay Cedex  
France  
Tél. 954 90 20

## Rapports de Recherche

N° 195

### A NEW METHOD OF COMPUTING GLOBAL ELASTIC MODULI FOR COMPOSITE MATERIALS

D. BEGIS  
A. BESTAGNO  
G. DUVAUT  
A. HASSIM  
M. NUC

Février 1983

# A NEW METHOD OF COMPUTING GLOBAL ELASTIC MODULI FOR COMPOSITE MATERIAL

D. BEGIS \*

A. BESTAGNO \*\*\*

G. DUVAUT \*\*

A. HASSIM \*

M. NUC \*\*\*

## ABSTRACT

This paper describes a new method for computing the homogenized characteristics of composite materials. Several examples of composite materials are analysed by using the finite element code MODULEF. These computer results are favorably compared with existing experimental results (SNIAS - Marignane) and with those obtained by other methods (PUCK, TSAI). Moreover the accuracy of our results shows the transverse anisotropy due to the spatial arrangement of fibers.

## RESUME

On présente dans ce papier une méthode de calcul des caractéristiques homogénéisées d'un matériau composite. Plusieurs exemples de matériau composite sont étudiés en utilisant le code d'éléments finis MODULEF. Les résultats numériques sont globalement en concordance avec les résultats expérimentaux existants (SNIAS - Marignane) et avec ceux obtenus par d'autres méthodes (PUCK, TSAI). Cependant, la précision de nos résultats fait apparaître l'anisotropie transverse due à la répartition géométrique des fibres.

\* INRIA, Domaine de Voluceau, 78153 Le Chesnay Cedex.

\*\* INRIA and Université Pierre et Marie Curie, PARIS VI.

\*\*\* AEROSPATIALE, MARIGNANE.



## 1. INTRODUCTION

When investigating the effective behavior moduli of composite materials, there are a few possibilities of experimental characterization, but they do not lead to the entire anisotropy elastic matrix. Therefore authors (Willis, Hashin, Halpin, ...) have developed several theoretical methods to obtain global or effective constitutive elastic coefficients.

In this paper, we use the so called homogenization method. It consists of the following : it can be shown that when the dimensions of the period tend homothetically to zero, the fields of deformations and stresses of the composite tend to those corresponding to a homogeneous structure (generally anisotropic). The complete set of the corresponding homogenized moduli can be computed in term of the elastic moduli of the constituents and the parameters describing the geometrical layout of a single period. The homogenized theory is also useful if the interest is focused on local analysis, as for example in the field of stresses at the interface of the constituents cf [10].

After presenting the general method of homogenization, emphasizing the significance of the law of homogenized behavior as a relation between mean values, we apply it to two types of composite materials :

i) Material consisting of a unidirectional parallel fibers arranged periodically. The computing results for several distributions and shapes of fiber are compared with those obtained by PUCK, HALPIN-TSAI and with experimental observations.

ii) Material consisting of a very large number of monoclinic layers in which the fiber orientations are given.

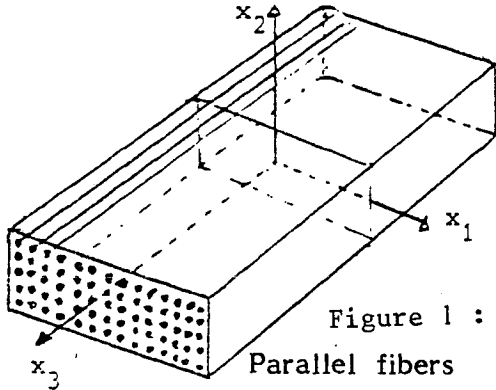

Figure 1 :

Parallel fibers

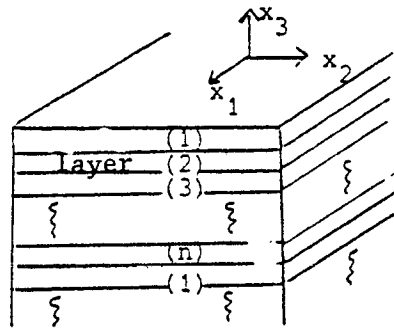

Figure 2 : Multiple layers

The numerical results are obtained by using the finite element code MODULEF and numerical data provided by SNIAS-MARIGNANE.

## 2. DESCRIPTION OF THE HOMOGENIZATION METHOD [1] [3] [4] [5] [12] [13]

### 2.1. Formulation of the problem

Let us consider an elastic body which occupies a region  $\Omega$  related to

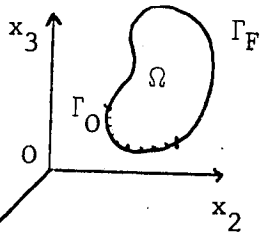

a system of orthonormal axes  $0x_1x_2x_3$ . This body is subjected to a system of voluminal forces  $\{f_i\}$  and surface force  $\{F_i\}$  on a portion  $\Gamma_F$  of boundary  $\partial\Omega$ .  $\Gamma_0$  is a clamped part of the boundary  $\partial\Omega$ .

The field of stresses at equilibrium satisfies the equilibrium equations

$$(1) \quad \frac{\partial \sigma_{ij}}{\partial x_j} + f_i = 0 \quad \text{in } \Omega$$

$$(2) \quad \sigma_{ij} n_j = F_i \quad \text{on } \Gamma_F.$$

Furthermore, the material is elastic with fine periodic structure, i.e. is covered by a set of identical periods of rectangular (fig. 3) or hexagonal (fig. 4) or more complicated shape such as the example given in figures 5 and 6

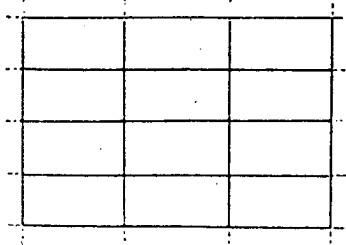

Fig. 3.

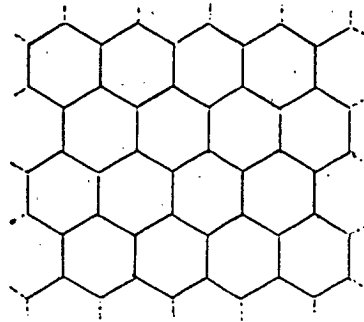

Fig. 4.

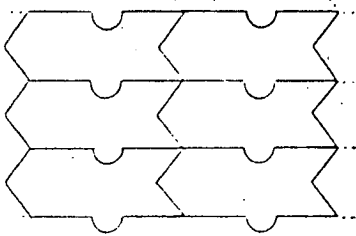

Fig. 5.

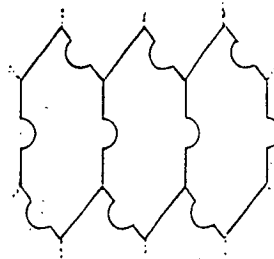

Fig. 6.

All the period forms must be such that opposing faces which correspond in a translation can be defined two by two.

In all cases we shall designate as  $Y$  a period characteristic of the material which has been enlarged by homothetics and fixed once for all. The elastic structure of the material is then fully known if it is given over a single period, eg. the enlarged period  $Y$  related to the orthonormal axis system  $Oy_1y_2y_3$ . Then let  $a_{ijkh}(y)$  be the coefficients of elasticity on  $Y$ , which generally alter very quickly with respect to  $y$ , but satisfy in all respects the symmetry relation

$$(3) a_{ijkh}(y) = a_{jikh}(y) = a_{khij}(y)$$

and positivity relation

$$(4) \exists \alpha_0 > 0 \text{ such that } a_{ijkh}(y) \tau_{ij} \tau_{kh} \geq \alpha_0 \tau_{ij} \tau_{ij}, \forall \tau_{ij} = \tau_{ji}$$

The functions  $y \rightarrow a_{ijkh}(y)$  defined on  $Y$  are extended by  $Y$ -periodicity to the entire space  $Oy_1y_2y_3$  assumed to be covered by contiguous periods identical to  $Y$ .

## 2.2. Homogenization method

The homogenization method consist in replacing the point wise constitutive relation

$$\sigma_{ij} = a_{ijkh} \varepsilon_{kh}$$

by a linear relation between some mean value of the stress tensor and some mean value of the strain tensor. In fact there are several ways of doing that. In the present case where the material is assumed periodic, we choose the mean values over the characteristic period  $Y$ . In all methods we solve an elasticity problem on a representative domain, which in the present case is the period  $Y$ . It means that we look for  $\{\sigma_{ij}\}$  and  $\{\varepsilon_{ij}(w)\}$  in  $Y$  such that

$$(5) \left\{ \begin{array}{l} \frac{\partial}{\partial y_j} \sigma_{ij} = 0 \\ \sigma_{ij} = a_{ijkh}(y) \varepsilon_{kh}(w), \varepsilon_{kh}(w) = \frac{1}{2} \left( \frac{\partial w_k}{\partial y_h} + \frac{\partial w_h}{\partial y_k} \right). \end{array} \right.$$

The various methods used differ in the boundary conditions. Here we recall two classical methods, which have been used by several authors, and then indicate the homogenization method :

i) First method : let  $E = \{E_{ij}\}$  be a constant symmetric matrix. We complete the set of relations (5) by the boundary conditions

$$(6) w_i = E_{ij} y_j \quad i = 1, 2, 3, \text{ on } \partial Y.$$

The problem (5) (6) has a unique solution which depends linearly on  $E$ , consequently the mean value of  $\{\sigma_{ij}\}$ , that we call  $\langle \sigma_{ij} \rangle$  depends linearly on  $E$ . It means that we have constant coefficients  $A_{ijkh}$ , such that

$$(7) \langle \sigma_{ij} \rangle = A_{ijkh} E_{kh}.$$

But we check easily that

$$\langle \varepsilon_{ij}(w) \rangle = E_{ij}$$

consequently (7) leads

$$(8) \langle \sigma_{ij} \rangle = A_{ijkh} \langle \varepsilon_{kh} \rangle.$$

Relation (8) can be considered as a global constitutive relation for the composite material.

ii) Second method : let  $\Sigma$  be a constant symmetric matrix. We complete the set of relations (5) by the boundary conditions

$$(9) \sigma_{ij} n_j = \Sigma_{ij} n_j, \quad i = 1, 2, 3 \text{ on } \partial Y$$

where  $\{n_j\}$  is the outer normal to  $\partial Y$ .

The problem (5) (9) has a unique solution as far as the stress and strain tensors are considered and the solution depends linearly on  $\Sigma$ . Consequently there exist constant coefficients  $B_{ijkh}$  such that :

$$\langle \varepsilon_{ij}(w) \rangle = B_{ijkh} \Sigma_{kh}$$

But we have also

$$\langle \sigma_{ij} \rangle = \Sigma_{ij}$$

which gives

$$(10) \langle \varepsilon_{ij} \rangle = B_{ijkh} \langle \sigma_{kh} \rangle.$$

Relation (10) is a global constitutive relation for the composite material. In general the relations (8) and (10) are not inverse one another.

iii) Homogenization method. we complete the relations (5) by

$$(11) \left\{ \begin{array}{l} \{\varepsilon_{ij}\} \text{ and } \{\sigma_{ij}\} \text{ are } Y\text{-periodic} \\ \langle \varepsilon_{ij} \rangle \text{ is prescribed say } \langle \varepsilon_{ij} \rangle = E_{ij} \text{ where } E = \{E_{ij}\} \text{ is a} \\ \text{constant symmetric matrix.} \end{array} \right.$$

Relations (5) (11) define a well posed problem, whose solution depends linearly on  $E$ ; consequently there exist constant coefficients  $q_{ijkh}$  such that

$$(12) \langle \sigma_{ij} \rangle = q_{ijkh} \langle \varepsilon_{kh} \rangle.$$

The global constitutive relation (12) is the homogenized constitutive relation. In general the matrix  $\{q_{ijkh}\}$  is not identical to  $\{A_{ijkh}\}$  and not inverse to  $\{B_{ijkh}\}$ . Relations between these matrices are studied in [5].

We can prove the following properties resulting from (3) (4),

$$q_{ijkh} = q_{jikh} = q_{khij}$$

$$\exists \alpha_1 > 0, \quad q_{ijkh} \tau_{kh} \tau_{ij} \geq \alpha_1 \tau_{ij} \tau_{ij}, \quad \forall \tau_{ij} = \tau_{ji}$$

Furthermore the homogenized relation (12) is the mathematical limit constitutive relation for the elasticity problem (1) (2) when the period tends to zero homothetically. This is proved in [4].



### 2.3. Computation of the homogenized coefficients $q_{ijkh}$

In the problem (5) (11), using the linearity of the solution with respect to  $E$ , we can make the following change of unknown

$$w_i = E_{ij} y_j + E_{pq} \chi_i^{pq}(y),$$

where the new unknown vectors  $\chi^{pq}(y)$  are solutions of :

$$(13) \left\{ \begin{array}{l} \chi^{pq} \text{ is } Y\text{-periodic} \\ \frac{\partial}{\partial y_j} a_{ijkh}(y) \varepsilon_{kh}(\chi^{pq}) = - \frac{\partial}{\partial y_j} a_{ijpq}(y) \text{ in } Y. \end{array} \right.$$

The homogenized coefficients are then given by

$$(14) q_{ijkh} = \frac{1}{\text{mes } Y} \int_Y [a_{ijkh}(y) - a_{ijpq}(y) \varepsilon_{kh}(\chi^{pq})] dy.$$

The last formula shows a first term which is only the mean value of  $a_{ijkh}(y)$  and a second term which is zero if  $\chi$  is zero.

## 3. APPLICATION TO AN ELASTIC MATERIAL REINFORCED BY FIBERS RUNNING IN THE SAME DIRECTION [1] [7]

### 3.1. Principle

The computations of the previous paragraph are applied to an elastic material formed from a multitude of resin-impregnated unidirectional fibers whose geometric distribution is periodic in a plane perpendicular to their direction  $x_3$ .

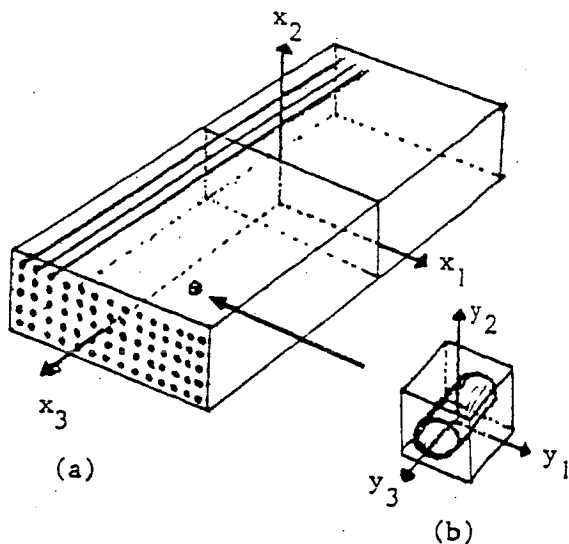

Fig. 7.

a) Structuration of fibers

b) Base period

Calculation of the homogenized coefficients  $q_{ijkl}$  calls for the resolution of (13). In the present case the coefficients  $a_{ijkl}(y)$  are independent of  $y_3$ ; the result is that the fields  $\chi^{ij}(y)$  are also independent of  $y_3$ ; in (13) the various indices give a zero contribution when they refer to  $\frac{\partial}{\partial y_3}$  making computation of  $\chi^{ij}(y)$  a bidimensional problem.

### 3.2. Numerical results

In all the cases studied, the homogenized material is orthotropic, in other words the law of behavior has numerous zero elements as shown in the table below :

$$(15) \quad \begin{Bmatrix} \sigma_{11} \\ \sigma_{22} \\ \sigma_{33} \\ \sigma_{23} \\ \sigma_{13} \\ \sigma_{12} \end{Bmatrix} = \begin{bmatrix} q_{1111} & q_{1122} & q_{1133} & 0 & 0 & 0 \\ & q_{2222} & q_{2233} & 0 & 0 & 0 \\ & & q_{3333} & 0 & 0 & 0 \\ & -\text{SYM-} & & 2q_{2323} & 0 & 0 \\ & & & & 2q_{1313} & 0 \\ & & & & & 2q_{1212} \end{bmatrix} \times \begin{Bmatrix} \varepsilon_{11} \\ \varepsilon_{22} \\ \varepsilon_{33} \\ \varepsilon_{23} \\ \varepsilon_{13} \\ \varepsilon_{12} \end{Bmatrix}$$

where  $\{\sigma_{ij}\}$  and  $\{\varepsilon_{ij}\}$  are stress and strain tensors.

The law (15) is inverted conventionally to be written : [6]

$$(16) \quad \begin{Bmatrix} \varepsilon_{11} \\ \varepsilon_{22} \\ \varepsilon_{33} \\ \varepsilon_{23} \\ \varepsilon_{13} \\ \varepsilon_{12} \end{Bmatrix} = \begin{bmatrix} \frac{1}{E_1} & -\frac{\nu_{12}}{E_1} & -\frac{\nu_{13}}{E_1} & 0 & 0 & 0 \\ & \frac{1}{E_2} & -\frac{\nu_{23}}{E_2} & 0 & 0 & 0 \\ & & \frac{1}{E_3} & 0 & 0 & 0 \\ & -\text{SYM-} & & \frac{1}{2G_{23}} & 0 & 0 \\ & & & & \frac{1}{2G_{13}} & 0 \\ & & & & & \frac{1}{2G_{12}} \end{bmatrix} \begin{Bmatrix} \sigma_{11} \\ \sigma_{22} \\ \sigma_{33} \\ \sigma_{23} \\ \sigma_{13} \\ \sigma_{12} \end{Bmatrix}$$

bringing out the following :

The Young moduli  $E_1, E_2, E_3$  in the directions of orthotropy

The Poisson coefficient  $\nu_{23}, \nu_{13}, \nu_{12}$ .

The shear moduli  $G_{23}, G_{13}, G_{12}$ .

The numerical results which follow have been obtained by using the MODULEF code [2]. They have been produced for numerous values of the ratio of impregnation and various forms of the cross section of the fibers, these choices having been made in collaboration with the engineers from SNIAS, Marignane.

We give here a part of the results obtained for impregnations of 36%, 50%, 65% resin and various forms of fiber, and also the curves showing the change in these coefficients with respect to the ratio of resin impregnation for fibers of circular section.

# ALIGNED CIRCULAR FIBER

## FIBER

$$\begin{aligned}
 E_1 &= 3.8 \cdot 10^5 \text{ MPa} & G_{23} &= 2.10^4 \text{ MPa} \\
 E_2 = E_3 &= .145 \cdot 10^5 & G_{12} = G_{13} &= 3.8 \cdot 10^4 \text{ MPa} \\
 \nu_{12} = \nu_{13} &= .22 & \nu_{23} &= .25
 \end{aligned}$$

## RESIN

$$\begin{aligned}
 E &= 3520 \text{ MPa} \\
 \nu &= .38
 \end{aligned}$$

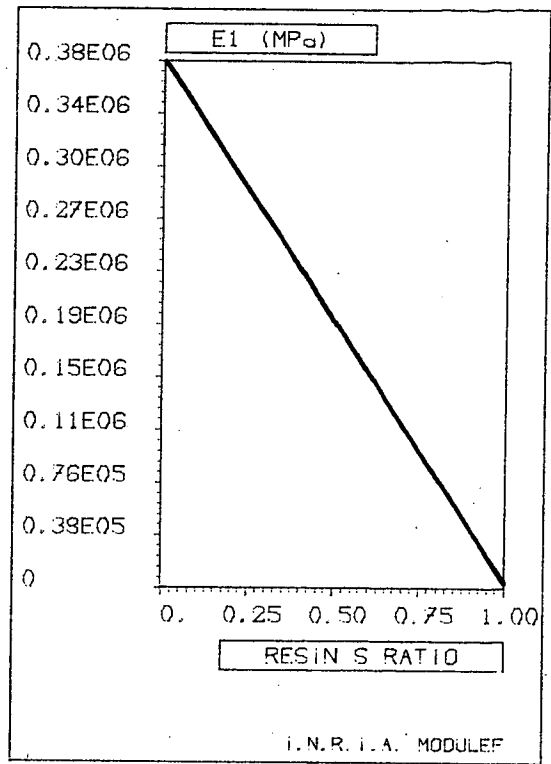
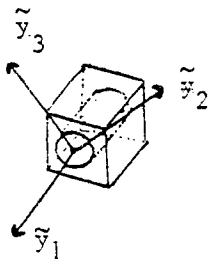

Fig. 8.

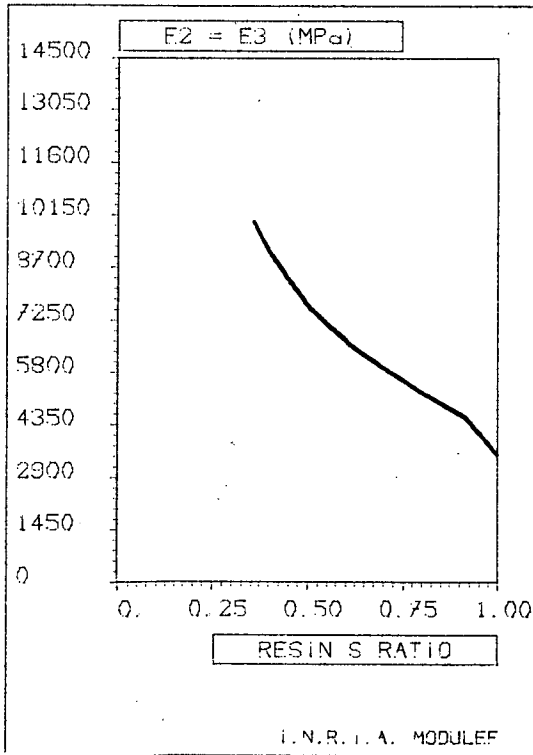

Fig. 9.

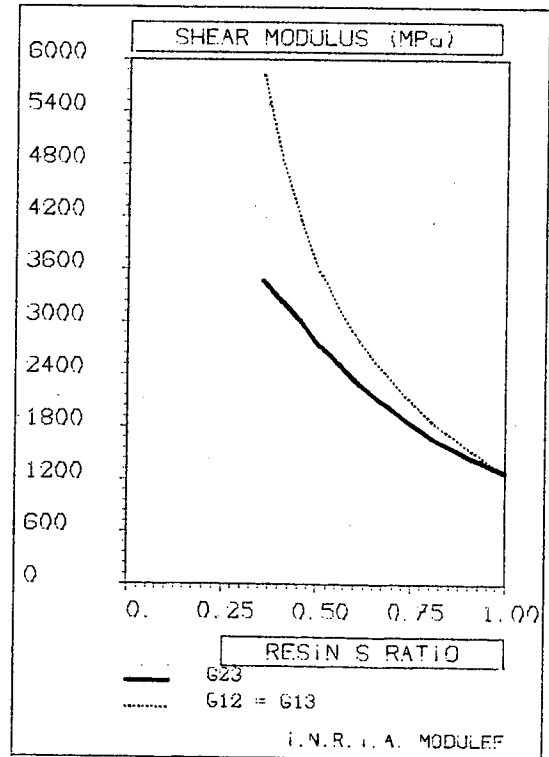

Fig. 10.

### 3.3. Anisotropy curves (fig. 11, 12, 13)

It is important to note that the homogenized media obtained are generally not transversally isotropic. This comment is clearly demonstrated if the Young modulus is calculated in a transverse direction with polar angle  $\theta$ . By applying the Young modulus on vector radius we obtain the curves given in Figures 11, 12, 13. For the material to be transversally isotropic, the curves plotted should be arcs of a circle centered at the origin.

Note :

The Young modulus in direction  $\theta$  is given by :

$$\frac{1}{E(\theta)} = \frac{1}{E_2} \cos^4 \theta + \frac{1}{E_3} \sin^4 \theta + \sin^2 \theta \cos^2 \theta \left( -\frac{2\nu_{23}}{E_2} + \frac{1}{G_{23}} \right)$$

This relation enabled the anisotropy curves in Figures 11, 12, 13 to be plotted.

RESIN IMPREGNATION RATIO BY VOLUME 36% (FIBERS // TO X1)

FIBER : E = 84000 MPa  $\nu = .22$  ; RESIN : E = 4000 MPa  $\nu = .34$

	E1	E2	E3	$\nu_{23}$	$\nu_{12}$	$\nu_{13}$	G23	G12	G13
(a)	55190	15400	15300	.42	.25	.25	7230	7307	6000
(b)	54930	15290	15140	.42	.25	.25	7200	7226	5939
(c)	54790	13390	13390	.48	.25	.25	8181	6304	6304

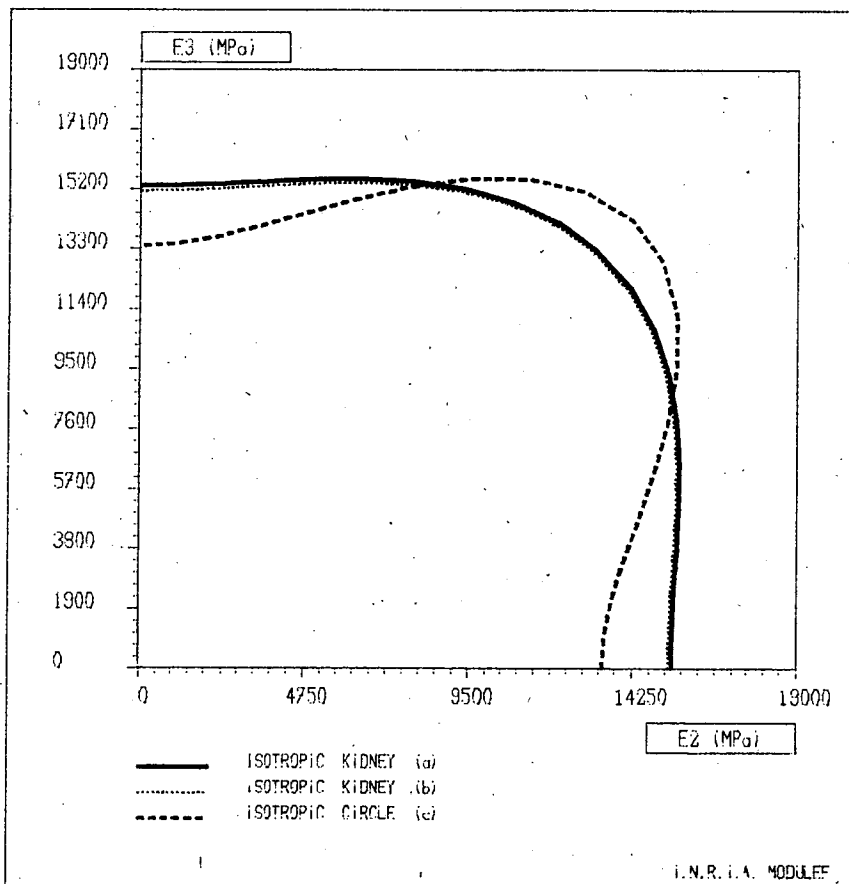

Fig. 11.

TRANSVERSE ANISOTROPY FOR 3 CROSS SECTIONS OF FIBER.

RESIN IMPREGNATION RATIO BY VOLUME 50% (FIBERS // TO X1).

FIBER

RESIN

$E1=380000$  MPa ;  $G23 = 20000$  MPa ;  $\nu 23 = .25$  ;  $E = 3520$  MPa

$E2= 14500$  MPa ;  $G13 = 38000$  MPa ;  $\nu 13 = .22$  ;

$E3=E2$  ;  $G12 = G13$  ;  $\nu 12 = \nu 13$  ;  $\nu = .38$

	E1	E2	E3	$\nu 23$	$\nu 12$	$\nu 13$	G23	G12	G13
(a)	192000	9730	9070	.33	.28	.30	2452	5597	3334
(b)	191500	8290	8100	.40	.29	.30	2623	4315	3347
(c)	191500	7620	7620	.44	.29	.29	2755	3662	3662

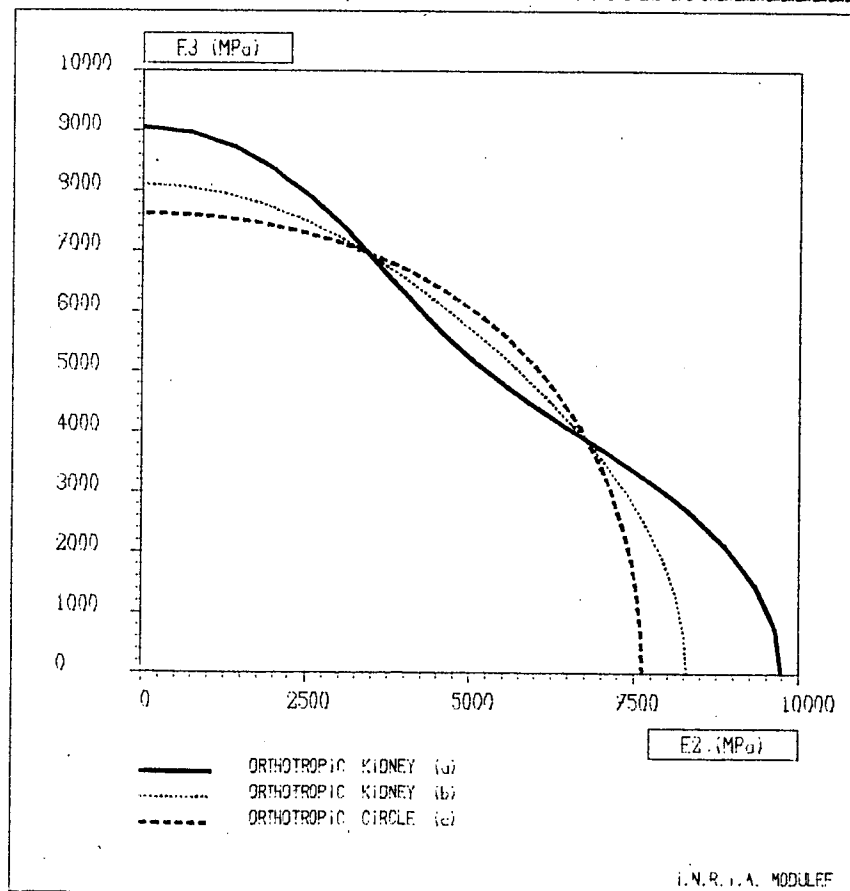

Fig. 12.

TRANSVERSE ANISOTROPY FOR 3 CROSS SECTIONS OF FIBER

RESIN IMPREGNATION RATIO BY VOLUME 65% (FIBERS // TO X1)

FIBER

RESIN

$E_1 = 380000 \text{ MPa}$  ;  $G_{23} = 20000 \text{ MPa}$  ;  $\nu_{23} = .25$  ;  $E = 3520 \text{ MPa}$

$E_2 = 14500 \text{ MPa}$  ;  $G_{13} = 38000 \text{ MPa}$  ;  $\nu_{13} = .22$  ;

$E_3 = E_2$  ;  $G_{12} = G_{13}$  ;  $\nu_{12} = .22$  ;  $\nu = .38$

	E1	E2	E3	$\nu_{23}$	$\nu_{12}$	$\nu_{13}$	$G_{23}$	$G_{12}$	$G_{13}$
(a)	135400	7950	7114	.42	.29	.34	1941	5037	2357
(b)	135000	6870	6580	.47	.30	.33	2035	3311	2331
(c)	133000	6210	6210	.50	.32	.32	2130	2526	2526

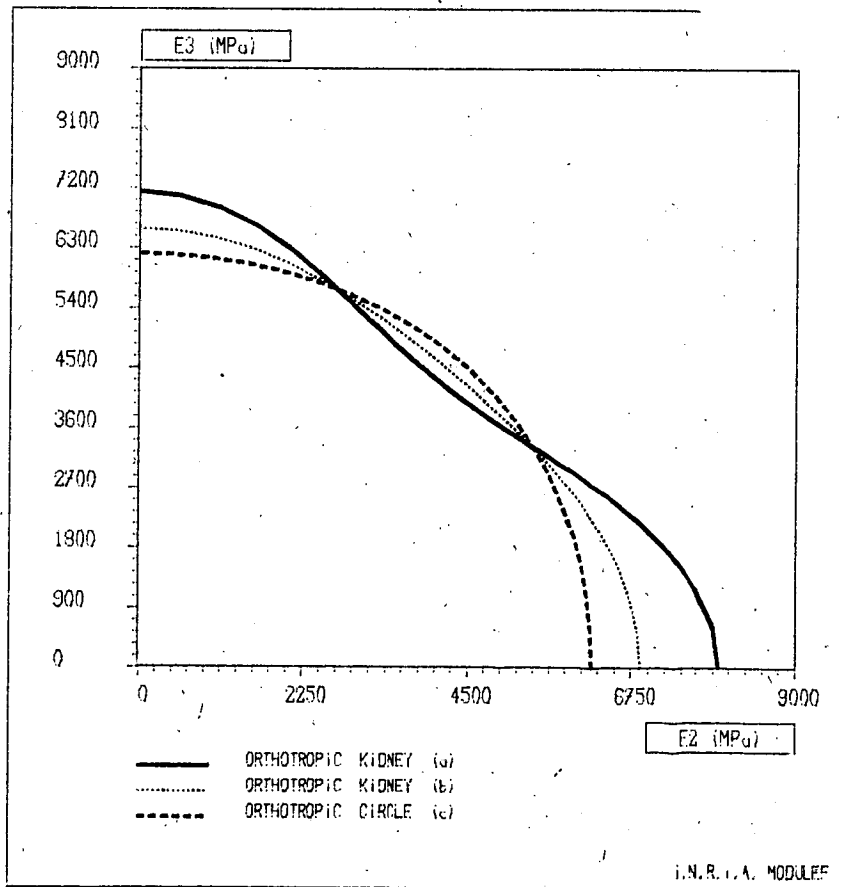

Fig. 13.

TRANSVERSE ANISOTROPY FOR 3 CROSS SECTIONS OF FIBER.



### 3.4. Stagger

If the fibers are staggered, i.e. if a period characterizing the material has the form shown in figure 14, we obtain diverse characteristics in accordance with the relative values of the sides or lengths of the rectangular cell.

i) if  $\ell = 1$  (square cell) : the characteristics of directions  $Oy_2$  and  $Oy_3$  are identical, and have the same Young modulus in particular.

ii) If  $\ell = \sqrt{3}$ , i.e. if the fibers are located at the apexes of an equilateral triangle (fig. 14) it can be shown that the material is transversally isotropic. This property is true for any saturation level of the resin.

iii) The bisecting directions  $O\tilde{y}_2$  and  $O\tilde{y}_3$  play the same roles irrespective of the values of  $\ell$  and the saturation. In particular, the Young moduli  $\tilde{E}_1$  and  $\tilde{E}_2$  in these directions are always equal.

iv) In figure 15 are plotted the Young and shear moduli corresponding to the various values of  $\ell$  varying from 1 to 2 and for the same resin saturation level by volume. For  $\ell = 1$ , the cell is square and naturally  $E_1 = E_2$ . We then find  $E_1 = E_2$  for  $\ell = \sqrt{3}$  since then the fibers are at the apexes of an equilateral triangle and the material is then transversally isotropic, which implies  $E_1 = E_2$ . In the same figure are plotted the values  $\tilde{E}_1 = \tilde{E}_2$  of the Young modulus in the bisector directions  $O\tilde{y}_1$  and  $O\tilde{y}_2$ .

For  $\ell = \sqrt{3}$  we find a triple point since naturally the transverse isotropy then implies

$$E_1 = E_2 = \tilde{E}_1 = \tilde{E}_2.$$

**CHARACTERISTICS**

FIBER : E = 84000 MPa  
 = .22

RESIN : E = 4000 MPa  
 = .34

RESIN RATIO 36%

FIBERS//Y1

REF.1 : 0 Y<sub>1</sub> Y<sub>2</sub> Y<sub>3</sub>

REF.2 : 0 Y<sub>1</sub>  $\tilde{Y}_2$   $\tilde{Y}_3$

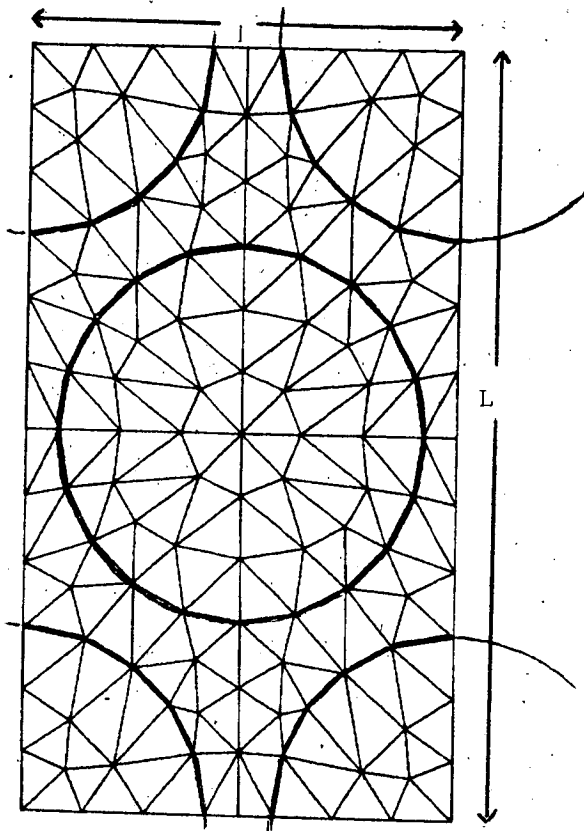

Fig. 14

EQUIDISTANT STAGGER (L=1.73)

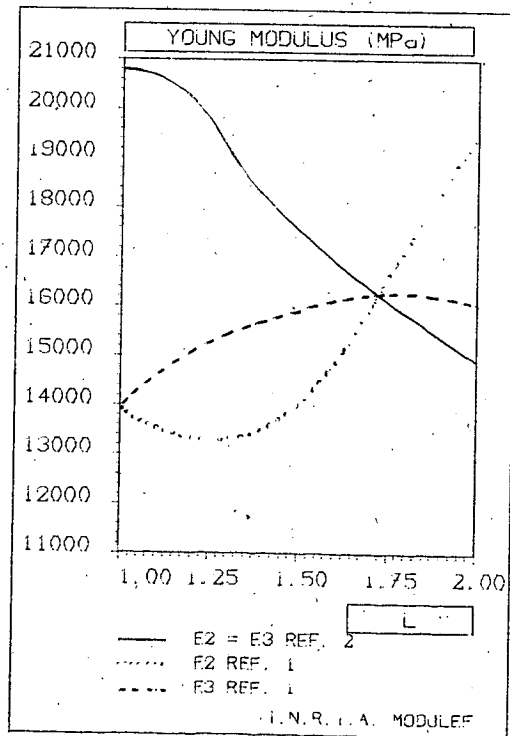
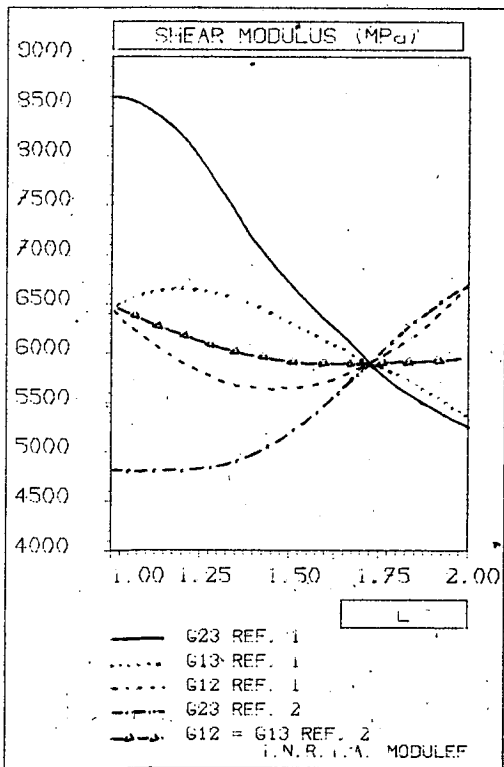

Fig. 15

VARIATION OF YOUNG AND SHEAR MODULI.

### 3.5. Comparison with experiments

The development of this previsional method is aimed at obtaining complete sets of characteristics for three-dimensional computations of composite structures through the finite elements method.

The possibilities of experimental characterization are indeed very reduced. Few tests are reliable, each one being specific to a characteristic, not permitting to reach them all. The results of measurements being very scattered in relation to production batches, mean values have to be used.

The extreme variety of resins give a very wide range of products to be used in production. Each fiber-resin pair can be associated within variable proportions. It is unthinkable to be able to experiment all configurations.

Each material is therefore characterized in an incomplete, dissimilar and inaccurate manner.

Tables presented hereafter explain application of the homogenization theory to the two materials : glass R - Resin Ciba 920 (36% - Resin in volume) and carbon CTS - Resin Ciba 920 (50 % resin in volume). We have considered several distributions and shapes of fiber.

Taking these values into account, average measured values were assigned to glass-resin composites while values obtained by transposition of tests results and proportion computation were assigned to carbon-resin composite. As a reminder, characteristics obtained with two bidimensional previsional methods = PUCK [11] and HALPIN-TSAI [14] were also given. For reasons indicated formerly, comparisons must be cautiously made.

Results obtained for glass-resin composite with staggered fibers layout at the apexes of an equilateral triangle (ensuring transverse isotropy) are nearest of measured values.

As far as carbon based composite is concerned, it is less clear but, in this case, the real shape of the fiber is not observed. On the other hand, when the shape is more accurate ("Kidney" shaped), the direction of the fiber does not vary and is therefore as little realistic. Of course, a configuration taking into consideration random direction will probably be nearer to the truth.

For the two considered materials, estimates based on the homogenization theory are nearer to those based on the widely used HALPIN-TSAI method.

The homogenization theory seems efficient to compute the mechanical characteristics of composite materials.

Validity of the results is evidently subjected to the assumptions made on shapes and lay-out of fibers. However, the undeniable advantage of this method aims at supplying complete and consistent sets of values, mutually coherent.

COMPARATIVE TABLE FOR CARBON CTS  
RESIN CIBA 920 (50% RESIN IN VOLUME) COMPOSITE

	Reference values	Homogenization theory			Other previsionsal methods	
		Aligned circular fibers	Staggered circular fibers	"Kidney"-shaped fibers (mean values)	PUCK	HALPIN-TSAI
$E_1$ (MPa)	120 000	119 299	119 293	119 290	119 260	119 260
$E_2$ (MPa)	6 000	6 284	6 035	8 000	11 620	5 620
$E_3$ (MPa)	6 000	6 284	6 035	7 950	11 620	5 620
$\gamma_{12}$	0.28	0.299	0.299	0.31	0.3	0.3
$\gamma_{13}$	0.28	0.299	0.299	0.29	0.3	0.3
$\gamma_{23}$	0.20	0.435	0.457	0.27	-	-
$G_{12}$ (MPa)	3 800	3 454	3 391	4 500	4 250	3 350
$G_{13}$ (MPa)	3 800	3 454	3 391	3 200	4 250	3 350
$G_{23}$ (MPa)	2 500	2 631	3 266	2 100	-	-

COMPARATIVE TABLE FOR GLASS R-RESIN  
CIBA 920 (36% RESIN IN VOLUME) COMPOSITE

	Measured values	Homogenization theory		Other previsionsal methods	
		Aligned circular fibers	Staggered circular fibers	PUCK	HALPIN-TSAI
$E_1$ (MPa)	55 000	55 226	55 215	54 450	54 450
$E_2$ (MPa)	17 000	20 275 ( $\tilde{E}_2 = 13496$ )	16 016	18 800	18 570
$E_3$ (MPa)	17 000	20 275 ( $\tilde{E}_3 = 13496$ )	16 016	18 800	18 570
$\gamma_{12}$	0.26	0.253	0.256	0.264	0.264
$\gamma_{13}$	0.26	0.253	0.256	0.264	0.264
$\gamma_{23}$	-	0.229 ( $\tilde{\gamma}_{23} = 0.487$ )	0.357	-	-
$G_{12}$ (MPa)	5 600	6 383	5 887	6 990	5 560
$G_{13}$ (MPa)	5 600	6 383	5 887	6 990	5 560
$G_{23}$ (MPa)	-	4 539 ( $\tilde{G}_{23} = 8250$ )	5 882	-	-

## 4. APPLICATION TO A PERIODIC STACK OF HOMOGENEOUS LAYERS

[4] [7]

### 4.1. Principle

We shall consider a periodic stack of a multitude of homogenized layers. Each layer is characterized by a direction of the fibers. In the stack these directions vary periodically whilst remaining orthogonal to axis  $0x_3$ .

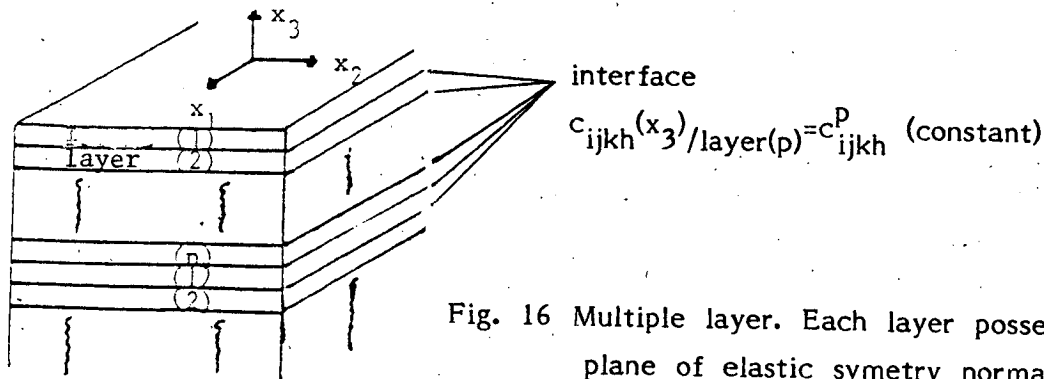

Fig. 16 Multiple layer. Each layer possesses a plane of elastic symmetry normal to the  $x_3$  axis (monoclinic symmetry).

In this situation the homogenization formulae are considerably simplified since the problem (13) is then reduced to a system of differential equations which may be solved explicitly. For the details, refer to D. Begis, G. Duvaut, A. Hassim [1] and to the references in this publication.

### 4.2. Numerical application

As an illustration we consider two cases :

- 1) a laminate consisting of 3 identical layers disposed periodically. The layers have equal thickness and their fibers orientations are respectively  $-60^\circ$ ,  $0^\circ$ , and  $60^\circ$  with respect to the  $x_1$  - axis. The homogenized material then presents a transverse isotropy which complies with the general results on isotropy cf [8].
- 2) a laminate consisting of 18 layers identical to the above and laid up at successive angles of  $10^\circ$  to each other. It is to be checked that the same result is obtained as in the previous case.

We give in the table presented hereafter the moduli of each layer and the moduli of the composite which are identical for the two cases (3 layers and 18 layers).

	Homogenized moduli of each layer	Homogenized moduli of composite
E1	120 000 MPa	45 128 MPa
E2	6 000 MPa	45 128 MPa
E3	6 000 MPa	6 198 MPa
$\nu_{23}$	0.20	0.188
$\nu_{13}$	0.28	0.188
$\nu_{12}$	0.28	0.30
G23	2 500 MPa	3 015 MPa
G13	3 800 MPa	3 015 MPa
G12	3 800 MPa	17 290 MPa

## Conclusion

We have presented several applications of the homogenization techniques for computing the coefficients of elasticity of composite materials. Other applications are in view with respect to fine analysis of the field of stresses using asymptotic expansions, the effect of defects in the composites [9] and more generally, damage to the materials of composite structure containing inclusions or precipitates.

Strictly speaking, these techniques apply only to absolutely periodic structures, but with the backing of statistical analyses it is possible to identify the fluctuations likely to be produced by periodicity defects. It is noted generally that strict periodicity reinforces the anisotropy of the computed homogenized material with respect to the industrial model.

## BIBLIOGRAPHY

- [1] D. BEGIS, G. DUVAUT, A. HASSIM  
Homogénéisation par éléments finis des modules de comportements élastiques de matériaux composites, Rapport de Recherche n° 101, INRIA.
- [2] D. BEGIS, A. PERRONNET  
Présentation du Club Modulef, INRIA, Mai 1981.
- [3] A. BENSOUSSAN, J.L. LIONS, G. PAPANICOLAOU  
Asymptotic analysis for periodic structures, NORTH HOLLAND Publishing Company, 1978.
- [4] G. DUVAUT  
Matériaux élastiques composites à structure périodique, Homogenisation. Theoretical and applied mechanics, W.T. KOITER, cd NORTH-HOLLAND publishing company, 1976.
- [5] G. DUVAUT  
Effective and homogenized coefficients, Symposium on functional analysis and differential equations. LISBOA, Portugal, March 29-April 2, 1982.
- [6] S. FLUGGE  
Encyclopedia of Physics. Mechanics of solids II, Springer Verlag, volume 2.
- [7] A. HASSIM  
Homogénéisation par éléments finis d'un matériau élastique renforcé par des fibres. Thèse de 3ème cycle (TOULOUSE 1980).
- [8] F. LENE, G. DUVAUT  
Résultats d'isotropie pour des milieux homogénéisés, CRAS Paris, Tome 293 pp 477-480 série 2 (octobre 1981)
- [9] F. LENE, D. LEGUILLON  
Etude de l'influence d'un glissement entre les constituants d'un matériau composite sur ses coefficients de comportement effectifs. Journal de Mécanique, vol. 20 n°2, 1981.
- [10] F. PISTRE  
Calcul des microcontraintes au sein d'un matériau composite.
- [11] A. PUCK  
Grundlagen der Spannungs und verformungs Analyse. Dipl. Ing. Kunststoffe. Bd 57. Heft 4 (1967).
- [12] E. SANCHEZ-PALENCIA  
Non-Homogeneous media and vibration theory. Lectures Notes in Physics 127, 1980.



[13] P. SUQUET

Une méthode duale en homogénéisation, CRAS Paris Tome 291 (A)  
pp 181-184, 1980.

[14] S.W. TSAI, J.C. HALPIN, N.J. PAGANO

Composite materials Workshop, Technomic Publishing Co. Inc.  
Connecticut (USA).

Imprimé en France

par

l'Institut National de Recherche en Informatique et en Automatique

