



**HAL**  
open science

## Detecting changes in signals and systems

Michèle Basseville

► **To cite this version:**

Michèle Basseville. Detecting changes in signals and systems. [Research Report] RR-0658, INRIA. 1987. inria-00075895

**HAL Id: inria-00075895**

**<https://inria.hal.science/inria-00075895>**

Submitted on 24 May 2006

**HAL** is a multi-disciplinary open access archive for the deposit and dissemination of scientific research documents, whether they are published or not. The documents may come from teaching and research institutions in France or abroad, or from public or private research centers.

L'archive ouverte pluridisciplinaire **HAL**, est destinée au dépôt et à la diffusion de documents scientifiques de niveau recherche, publiés ou non, émanant des établissements d'enseignement et de recherche français ou étrangers, des laboratoires publics ou privés.

**INRIA**

**UNITÉ DE RECHERCHE  
INRIA-RENNES**

Institut National  
de Recherche  
en Informatique  
et en Automatique

Domaine de Voluceau  
Rocquencourt  
BP 105  
78153 Le Chesnay Cedex  
France  
Tél. (1) 39 63 55 11

Rapports de Recherche

N° 658

**DETECTING CHANGES  
IN  
SIGNALS AND SYSTEMS**

**Michèle BASSEVILLE**

**Avril 1987**

Campus Universitaire de Beaulieu  
35042 - RENNES CÉDEX  
FRANCE  
Téléphone: 99 36 20 00  
Télex: UNIRISA 950 473 F  
Télécopie: 99 38 38 32

PUBLICATION INTERNE N° 353

MARS 1987

46 PAGES

### DETECTING CHANGES IN SIGNALS AND SYSTEMS - A SURVEY -

Michèle Basseville (IRISA/CNRS)  
Campus de Beaulieu  
35042 Rennes Cedex

**Abstract.**— The problems of detection, estimation, and diagnosis of changes in dynamical properties of signals or systems are addressed. An overview of design methods for on-line and off-line algorithms is presented, with particular emphasis on statistical methods for detection.

**Key-words :** Time-Varying signals and systems.; signals segmentation ; failure detection ; diagnosis.

(This work was supported by CNRS GRECO SARTA)

---

### DETECTION DE CHANGEMENTS DANS LES SIGNAUX ET SYSTEMES - UNE REVUE -

**Résumé.**— On examine les problèmes de détection, estimation et diagnostic de changements dans les propriétés dynamiques des signaux ou des systèmes, et on présente pour des algorithmes en-ligne ou hors-ligne, en privilégiant plus particulièrement les méthodes statistiques de détection.

(La version originale de ce papier a été présentée au 2ème IFAC Workshop "Adaptive Systems in Control and Signal Processing, Lund, Sweden, July 1-3 1986).

## Detecting changes in signals and systems -A survey-

Detecting changes in signals and systems -A survey-  
Michèle Basseville (IRISA/CNRS)  
Campus de Beaulieu  
35042 Rennes Cedex

**Abstract.-** The problems of detection, estimation, and diagnosis of changes in dynamical properties of signals or systems are addressed. An overview of design methods for on-line and off-line algorithms is presented, with particular emphasis on statistical methods for detection.

**Key words :** Time-varying signals and systems, signals segmentation, failure detection, diagnosis.

(This work was supported by CNRS GRECO SARTA)

The original version of this paper was presented at the 2nd IFAC workshop on Adaptive Systems in Control and Signal Processing, Lund, Sweden, July 1-3 1986.

### I. PROBLEMS STATEMENT AND APPLICATION EXAMPLES

#### 1. Introduction

The problem of detecting changes in dynamical properties of signals and systems has received a growing attention these last fifteen years, as can be seen from the survey papers (Willsky, 1976; Mironovski, 1980; Basseville, 1982; Kligene and Telksnys, 1983; Isermann, 1984) and the more methodological works (Himmelblau, 1978; Pau, 1981; Nikiforov, 1983; Basseville and Benveniste (Ed.), 1986). Actually, this problem arises in many areas of Automatic Control and Signal Processing, which may be classified as follows:

1. segmentation of signals and images for the purpose of recognition, and also for monitoring dynamical systems;
2. failure detection in controlled systems;
3. gains updating in adaptive algorithms, for tracking quick variations of the parameters.

Many applied fields have already been concerned: edge detection (Basseville and co-workers, 1981); continuous speech recognition (André-Obrecht, 1986); geophysical (Basseville and Benveniste, 1983a) and seismic (Nikiforov and Tikhonov, 1986b) signals segmentation; bio-medical signals processing (Gustavson and co-workers, 1978; Segen and Sanderson, 1980; Ishii and co-workers, 1980; Appel and Brandt, 1983; Corge and Puech, 1986); aeronautics (Deckert and co-workers, 1977; Kerr, 1985); chemical (Himmelblau, 1978) and nuclear (Desai and Ray, 1984) industries; vibration monitoring (Basseville and co-workers, 1985); incidents detection on freeways (Willsky and co-workers, 1980); leak detection for pipelines (Iserman, 1984); control of air condi-



## Detecting changes in signals and systems -A survey-

tioning systems (Usono and co-workers, 1985); econometry (Shaban, 1980).

The interested reader is referred to (Perriot-Mathonna, 1984) and to (Favier and Smolders, 1984) for two examples of use of change detection algorithms for solving a problem of type 3. Let us now investigate two typical problems of class 1 and one example of class 2.

### 1.1. Example 1: Segmentation of continuous speech signals

A possible approach to automatic recognition of continuous speech consists in using an automatic segmentation of the signal as the first processing step (André-Obrecht, 1986). Without using any phonetic information, this segmentation results in a decomposition of the signal into units which are then labelled and processed at the second step called acoustico-phonetic decoding. An example of such an automatic segmentation can be seen on Fig.1. The algorithm which is used will be discussed below. Let us just briefly mention that on-line detection of abrupt changes in the spectral characteristics of the signal ( $y_n$ ) is performed via the comparison between a long term model  $M_0$  identified in a growing window and a short term model  $M_1$  identified in a sliding window of fixed length. The models which are used are A.R. models excited by gaussian white noises, namely:

$$y_n = \sum_{i=1}^p a_i y_{n-i} + \varepsilon_n \quad (1)$$

where ( $\varepsilon_n$ ) has variance  $\sigma^2$ .

The distance measure between the two estimated models is Kullback's divergence between the conditional probability laws of the signal with respect to these models. The key-point which has to be kept in mind is that the vector parameter:

$$\theta = (a_1 \dots a_p \sigma)^T \quad (2)$$

is monitored on-line, using a sophisticated function of the innovations of the two models  $M_0$  and  $M_1$ .

### 1.2. Example 2: Vibration monitoring of structures under natural excitation

Monitoring changes in the vibrating characteristics of a complex structure, such as an offshore platform subject to the swell, results in fatigue analysis. The main difficulties of such a monitoring lie in the highly nonstationary behavior of the unknown excitation, and furthermore finite elements model updating is impracticable when only few measurements (from accelerometers) are available. A recent original

## Detecting changes in signals and systems -A survey-

solution consists in two steps (Basseville and co-workers, 1985).  
a on site identification of a modal signature, namely of the vibrating frequencies and modes of the structure which is described by:

$$MX + CX + KX = E \quad (3)$$

where M, C, K are the matrices of mass, damping and stiffness coefficients and E is the unknown excitation. This signature is obtained with the aid of a parametric identification method based on ARMA modelling;

b validation of this signature on subsequent records of signals. This test can monitor the structure globally, or focus the monitoring into particular subspaces and thus give information for diagnosis.

The key-point here is that we have to detect changes in the AR part of a vector ARMA process, with unknown and time-varying MA coefficients which have to be considered as nuisance parameters. The main feature of the solution is to transform this complex problem into the simpler problem of detecting a change in the mean value of a conveniently chosen random variable.

### 1.3. Example 3: Failure detection in air conditioning systems

Fault detection and diagnosis in the heating, ventilation and air conditioning (HVAC) system of a building is of crucial importance for reducing energy use. A possible solution to that problem has been recently proposed by Usoro and co-workers (1985). It consists in using a continuous-time nonlinear state space model for the air handler unit together with an extended Kalman filter for estimating its state. The various faults are detected by monitoring convenient functions of the innovations of this filter -sum of squares, likelihood functions,...- and they are possibly estimated and located using a preestablished classification of the values of these functions for different failure types.

As in the previous example, the main feature of this application is the transformation of the complex initial problem into the problem of monitoring convenient residuals.

The sophisticated algorithms used in the examples above and the numerous fields of application which we mentioned show that a significant amount of methodological tools and experimental results are available now. The purpose of this paper is the presentation of some key solutions to the underlying detection, estimation and diagnosis problems.

## 2. A twofold possible approach

In designing change detection/estimation algorithms, it may be useful to distinguish two types of tasks generalizing the philosophy developed in (Chow and Willsky, 1980):

i generation of "residuals" or change indicating signals, which are, for example, ideally close to zero when no change occurs, or, more ge-

## Detecting changes in signals and systems -A survey-

nerally, the mean value or the spectral properties of which change when the analyzed system is changing;

ii design of decision rules based upon these residuals.

Both deterministic and stochastic approaches have been used in the literature for solving these two tasks. In this paper, we will mainly concentrate on parametric statistical methods, especially for task ii. Our experience and conviction are that a useful and powerful approach for solving change detection problems consists in :

.first, transforming the possibly non stochastic initial problem into a stochastic change detection problem such as the problem precisely stated below. This step is the generalized task i mentioned above. A non standard example of such a problem transformation may be found in (Bouthemy, 1986);

.second, using sophisticated statistical tools for solving the resulting stochastic problem, namely task ii.

We insist upon the fact that, as will be seen below, there exists a general statistical approach for change detection, namely the likelihood ratio approach, which leads most of the time to very powerful algorithms. Whenever such a solution can be used, i.e. when there are no constraints on algorithm complexity and no nuisance parameters, this likelihood approach should be implemented directly on the initial system or signal without considering step i. The discussion about the detection of changes in spectral properties or eigenstructure will clarify this point. But we also emphasize that the solution of task i may be of key importance in complex systems for example, in order to reduce the size and/or simplify the structure of the model to be monitored, or in order to get rid of nuisance parameters. In section VIII will be found deterministic and stochastic solutions to this task.

### 3. Problems statement

According to the above discussion, from now on and until section VII included, we assume that our change detection problem has been transformed into the following stochastic problem. Let us consider a stochastic process  $(y_t)$ , with conditional distribution  $p_\theta(y_t | y_{t-1}, \dots, y_0)$ . Given a record  $(y_t)_{(0 \leq t \leq n)}$ , decide between the two hypotheses:

$$H_0 : \theta = \theta_0$$

$H_1$  : there exists an instant  $1 \leq r \leq n$  such that:

$$\begin{cases} \theta = \theta'_0 & \text{for } 0 \leq t \leq r-1 \\ \theta = \theta_1 & \text{for } r \leq t \leq n \end{cases} \quad (5)$$

## Detecting changes in signals and systems -A survey-

As will be seen in the subsequent sections, the case  $\theta'_0 = \theta_0$  will be often considered for on-line approaches.

If  $H_1$  is decided, further questions are to estimate the change time  $r$ , possibly to estimate  $\theta'_0$  and  $\theta_1$ , and in some cases to diagnose which type of change actually occurs in the process. Of course, the relative importance of these subsequent questions depends upon the applications. Both off-line ( $n$  fixed) and on-line ( $n$  growing) procedures can be designed for solving such types of problems. We only recall that an off-line point of view may be useful to design an algorithm which will be implemented on-line and we refer the reader to (Basseville and Benveniste, Ed., 1986, ch. 4) for a complete discussion. We also refer to (Benveniste and co-workers, 1986) for the connection between change detection and model validation.

Finally, as obvious in (5), we will consider only single change point alternatives. From off-line point of view, multiple changes may be found by global search; from on-line viewpoint, the changes are assumed to be detected one after the other.

### 4. Choice of criterions

The standard performance index for on-line change detection algorithms is the delay for detection, which has to be minimized for a fixed false alarm rate (Page, 1954; Shiryaev, 1963; Moustakides, 1986a). Lorden (1971) and Nikiforov (1983) use a slightly different definition of the delay. For off-line procedures, this question is more tricky, because change detection problems are multiple hypotheses testing problems for which there exists no optimum test, in the classical sense of test's power. Therefore asymptotic analyses have to be used, which may be useful also for designing tests, as we shall see later. Further discussions may be found in (Basseville and Benveniste (Ed.), 1986, ch.4).

Apart from the tradeoff between the mean time between false alarms and the delay for detection -both increasing when the sensitivity of the detector to high frequencies decreases-, there exists another tradeoff to be kept in mind which is closely related to the first one: efficiency versus complexity. Actually, when the designed monitoring system involves at each alarm a complex time consuming processing, false alarms are more dramatic than in the simpler case of over-segmentation in signal recognition. Furthermore, it has to be noticed that the complexity of a change detection system is not only of computational type but also of technological nature: some failure detection procedures explicitly use the redundancy in the information given by several identical sensors, and reducing such a complexity without degrading the performances of the detector may be of interest. Other comments on these questions may be found in (Willsky, 1976a) and in the discussion concerning open problems presented in the conclusion. Finally, models and samples sizes required by the designed change detection technique are of importance for application to real signals or systems.



## Detecting changes in signals and systems -A survey-

### 5. Organization of the paper

As we already mentioned, sections II to VII are mainly devoted to the design of parametric statistical solutions for task ii, while both deterministic and stochastic solutions to task i are reported in section VIII. More precisely, we first investigate in section II the simplest change detection problem -jump in the mean- for which we introduce the likelihood ratio and the cumulative sum tests. Section III is devoted to the extension of these tests to the detection of additive changes in linear systems. Then changes in spectral properties are considered in section IV, where the so-called two-models approach is presented together with exact and approximate likelihood ratio tests for that situation. In section V, the likelihood approach is presented in a general framework. The (statistical) local approach is described in section VI where cumulative sum type algorithms are built for solving problems of changes in spectral properties or eigenstructure with a lower complexity cost than likelihood tests. In section VII, we exhibit a counter-example for which none of the general solutions presented in section V and VI can be used, because of nuisance parameters. We give another general solution for designing change detection algorithms in such cases; it still uses the local approach but no longer the likelihood function.

Afterwards in section VIII we investigate the problem of the choice of the signals to be monitored in order to perform change detection and diagnosis. Both redundancy approaches and filtering methods are described, and we discuss the question of problem transformation we mentioned above in section I.2. Then in section IX we discuss the diagnosis problem, namely the problem of deciding which type of change actually occurred and where -some times called the failure isolation problem- for which we give three types of solutions.

Finally some open problems and conclusions are given in section X.

Before going more deeply into technical details, two remarks have to be done. First, as far as the design of decision rules is concerned, we intentionally leave out the voting strategies which are often used for highly physically redundant systems, and we refer the interested reader to (Willsky, 1976a), (Kerr, 1985), and to (Desai and Ray, 1984) for an extension to degrees of consistency among residuals and/or measurements. Second, most of the parametric statistical detection rules presented below are based upon the likelihood ratio, with or without bayesian framework. It is of key importance to keep in mind that, for this type of decision rules, the independence hypothesis, which is often implicitly used for writing the likelihood function as a product, is only justified when the "residuals" or change indicating signals which are managed are the innovations of a Kalman filter, but generally not for the instantaneous or temporal redundancy relations. This point will be further investigated in section VIII.

## II. DETECTING JUMPS IN THE MEAN

## Detecting changes in signals and systems -A survey-

We begin this serie of sections devoted to the design of statistical decision rules by investigating the simplest change detection problem, namely the problem of a change in the mean of independent identically distributed random variables. We introduce two basic tests- the likelihood ratio test and the Page-Hinkley stopping rule- and discuss their theoretical properties.

Let  $(\varepsilon_n)$  be a white noise sequence with variance  $\sigma^2$ , and let  $(y_n)$  be the sequence of observations (possibly the "residuals" of section VIII) such that:

$$y_n = \mu_n + \varepsilon_n$$

where :

$$\mu_n = \begin{cases} \mu_0 & \text{if } n \leq r-1 \\ \mu_1 & \text{if } n \geq r \end{cases} \quad (6)$$

The problem is to detect the change in the mean  $\mu_n$ , to estimate the change time  $r$  and possibly the mean values  $\mu_0$  and  $\mu_1$  before and after the jump. We first investigate the case where  $\mu_0$  and  $\mu_1$  are known, and then the case where only  $\mu_0$  is known- which is of interest in practice for on-line detection.

### 1. Known means before and after the jump

The detection problem consists in testing between the no change hypothesis:

$$H_0 : r > n$$

and the change hypothesis :

$$H_1 : r \leq n$$

The likelihood ratio between these two hypotheses is :

$$\prod_{k=r}^n \frac{p_1(y_k)}{p_0(y_k)} \quad (7)$$

where  $p_i$  is the gaussian probability density with mean  $\mu_i$  ( $i=0,1$ ). Its logarithm is thus:

Detecting changes in signals and systems -A survey-

$$\Lambda_n(r) = \frac{\mu_1 - \mu_0}{\sigma^2} \sum_{k=r}^n \left( y_k - \frac{\mu_0 + \mu_1}{2} \right) = \frac{1}{\sigma^2} S_r^n(\mu_0, \nu)$$

where

$$S_i^j(\mu, \nu) = \nu \sum_{k=i}^j \left( y_k - \mu - \frac{\nu}{2} \right) \quad (8)$$

and

$$\mu = \mu_1 - \mu_0$$

is the magnitude of the jump.

Replacing the unknown jump time  $r$  by its maximum likelihood estimate (MLE) under  $H_1$ , namely:

$$\hat{r}_n = \arg \max_{1 \leq r \leq n} \left[ \prod_{k=0}^{r-1} p_0(y_k) \prod_{k=r}^n p_1(y_k) \right] = \arg \max_{1 \leq r \leq n} S_r^n(\mu_0, \nu) \quad (9)$$

we get the following change detector :

$$g_n \stackrel{\Delta}{=} \Lambda_n(\hat{r}_n) = \max_r S_r^n(\mu_0, \nu) \underset{H_0}{\overset{H_1}{>}} \lambda \quad (10)$$

This detector may be described as follows: detect a jump in the mean the first time  $n$  at which:

$$g_n = S_1^n(\mu_0, \nu) - \min_{1 \leq k \leq n} S_1^k(\mu_0, \nu) > \lambda \quad (11)$$

This detector is called Page-Hinkley stopping-rule (Page, 1954) or cumulative sum algorithm. Its behavior is depicted on Fig.2. It may be used more generally for detecting any change between two known probability laws  $p_{\theta_0}$  and  $p_{\theta_1}$ . In this case, compute:

Detecting changes in signals and systems -A survey-

$$S_i^j (p_{\theta_0}, p_{\theta_1}) = \sum_{k=i}^j \text{Log} \frac{p_{\theta_1}(y_k)}{p_{\theta_0}(y_k)} \quad (12)$$

The theoretical properties of the test (11) have been investigated for a long time from both on-line and off-line points of view. The most significant works in that direction are (Shiryayev, 1963), (Lorden, 1971), (Hinkley, 1971), (Basseville, 1981), and recently (Moustakides, 1986a). This last result is the only non asymptotic one: the stopping-rule (11) minimizes the mean delay for detection for a fixed (and not going to zero) false alarm rate. Further discussions may be found in (Basseville and Benveniste (Ed.), 1986, ch.1).

Another optimal stopping rule was obtained by Bojdecki and Hosza (1984) for a different criterion still in the general case of two known probability laws. Finally, recent results obtained by Yashchin (1985) should improve performance evaluation for the above described cumulative sum algorithms.

2. Unknown jump magnitude

We now consider the more realistic case where the jump magnitude  $v$  is unknown. From an on-line point of view, we may assume that  $\mu_0$  is known, but not  $\mu_1$ . Two approaches may be used in such a case.

The first one consists in running two tests (11) in parallel, corresponding to an a priori chosen minimum jump magnitude  $v_n$  and to two possible directions (increase or decrease in the mean). The corresponding stopping rules are as follows: for a decrease:

$$\left\{ \begin{array}{l} T_0 = 0 \\ T_n = \sum_{k=1}^n \left( y_k - \mu_0 + \frac{v_n}{2} \right) \\ M_n = \max_{0 \leq k \leq n} T_k \\ \text{alarm when } M_n - T_n > \lambda \end{array} \right. \quad (13)$$

and for an increase:

Detecting changes in signals and systems -A survey-

$$\begin{cases} U_0 = 0 \\ U_n = \sum_{k=1}^n \left( y_k - \mu_0 - \frac{v_m}{2} \right) \\ m_n = \min_{0 \leq k \leq n} U_k \\ \text{alarm when } U_n - m_n > \lambda \end{cases} \quad (14)$$

The decision which is taken corresponds to the rule which stops first, and the estimate of the jump time  $r$  is the last maximum (resp. minimum) time before detection. This approach was used in (Basseville and co-workers, 1981) for line-by-line edge detection in digital pictures.

The second approach in case of unknown jump magnitude  $v$  consists in replacing it by its MLE. The likelihood ratio test is then:

$$\max_{1 \leq r \leq n} \max_v S_r^n(\mu_0, v) \underset{H_0}{\overset{H_1}{>}} \lambda \quad (15)$$

Because of (8), we have :

$$\hat{v}_n(r) \triangleq \arg \max_v S_r^n(\mu_0, v) = \frac{1}{n-r+1} \sum_{k=r}^n (y_k - \mu_0)$$

and thus the double maximization in (15) is actually only a single one.

We shall see in the next section that this property is still valid in a more general situation, and leads to an efficient change detection algorithm with reasonable computing cost.

Finally, let us mention that other algorithms -both on-line and off-line- for detecting changes in the mean are surveyed in (Basseville, 1982).

### III. ADDITIVE CHANGES IN LINEAR SYSTEMS

In this section we consider the problem of detecting additive changes

Detecting changes in signals and systems -A survey-

in linear dynamical systems described in state-space representation as follows:

$$\begin{cases} X_{n+1} = FX_n + GU_n + V_n \\ Y_n = HX_n + W_n \end{cases} \quad (16)$$

where  $(V_n)$  and  $(W_n)$  are two independent Gaussian white noises, and where the change may occur either on the state transition equation or on the observation equation.

1. Generalized likelihood ratio test

A rather old intuitive approach consists in monitoring the innovations  $(\varepsilon_n)_n$  of a Kalman filter for example (Mehra and Peschon, 1971). Actually, because of the linear property of the system and because of the additive effect of the change on the system, it may be easily shown (Willsky and Jones, 1976b) that the effect of the change on the innovation  $\varepsilon_n$  is also additive. Moreover, the gaussian characteristic of the state and observation noises in (16) ensures that the property of explicit solution in  $v$  for the likelihood ratio test (15) is still valid in the present general situation of additive changes in linear systems. These points were exploited by Willsky and Jones (1976b) who derived a recursive algorithm for the so-called generalized likelihood ratio (GLR) test (15) computed for the innovations  $\varepsilon_n$  of the Kalman filter designed under the no change hypothesis.

More precisely, because the distribution of these innovations is given by the conditional distribution of the observation with respect to its past values, the cumulative sum to be computed instead of (12) in the present case is:

$$S_i^j(p_{\theta_0}, p_{\theta_1}) = \sum_{k=i}^j \text{Log} \frac{p_{\theta_1}(Y_k | Y_{k-1}, \dots, Y_0)}{p_{\theta_0}(Y_k | Y_{k-1}, \dots, Y_0)} \quad (17)$$

where  $p_{\theta_1}$  reflects the change of "magnitude"  $v$  in (16). The GLR test is then:

$$\max_{1 \leq r \leq n} \max_{\theta_1} S_r^n(p_{\theta_0}, p_{\theta_1}) \underset{H_0}{\overset{H_1}{>}} \lambda \quad (18)$$

As mentioned above, the maximization over  $\theta_1$  (or  $v$ ) is explicit.

Detecting changes in signals and systems -A survey-

Moreover, the computation of  $S_r^k$  and  $\hat{v}_k$  are recursive. The only non recursive computation is the discrete maximization over the change time  $r$ . In order to limit the computing time, Willsky and Jones (1976b) decided to constrain the search in a window of fixed size  $M$ , namely to compute:

$$\max_{k-M+1 \leq r \leq k} S_r^k \left( \begin{matrix} p_{\theta_0}, p_{\theta_1} \\ \theta_0, \theta_1 \end{matrix} \right) \begin{matrix} H_1 \\ > \lambda \\ H_0 \end{matrix} \quad (19)$$

The key point is that (19) is not a finite horizon technique because (17) is computed with the aid of all the past observations.

One interesting feature of this algorithm is the ability of updating the Kalman filter after change detection, with the aid of the estimate of the jump magnitude.

Another interesting property concerns the diagnosis problem, and will be discussed in section IX. The theoretical properties of the GLR test will be reported in section V.

2. A modified algorithm

In practice, the main advantage of the GLR algorithm (19) is to give good estimates for the change time  $r$  and "magnitude"  $v$ , even if the change actually occurs in more than one step in time.

However, a true drawback lies in the coupling effect between the window size  $M$  and the threshold  $\lambda$  in (19) and in the possibly high sensitivity with respect to the choice of  $\lambda$ .

For these reasons, a modified algorithm was derived by Basseville and Benveniste (1983a) and applied to geophysical signals. The decision is based upon the MLE  $\hat{v}_k$  (and not on the likelihood ratio), and the resulting algorithm -filtering + detection + updating- works as a low-pass filter everywhere except at the change points.

An experimental comparison with the Page-Hinkley stopping-rule (13)-(14) is done in (Basseville and Benveniste, 1983a), and also with a "mixed" algorithm involving Hinkley's stopping-rule and Willsky's magnitude estimate.

Other ways of managing not necessarily additive changes in systems like (16) are reported in section IX.

IV. CHANGES IN SPECTRAL PROPERTIES OR EIGENSTRUCTURE

We now investigate the problem of changes in AR or ARMA models, or

Detecting changes in signals and systems -A survey-

equivalently in the state transition matrix F of model (16). In this section, we are mainly interested in the problem of segmentation of scalar signals, while the vector case will be mainly investigated in sections V to VII.

It may be of interest to keep in mind the following distinction between two types of situations:

i either the analyzed system or signal is known to have the same behaviour as an AR or ARMA process, and then the model is descriptive enough for its parameters behaviour being of interest;

ii or the model of the system or signal is not known, and the main issue is the detection of changes in its spectral characteristics; then the AR or ARMA model to be used is nothing but a tool for the detection of such changes. In this case, robustness properties of the detectors may be of key importance.

1. Generalized likelihood ratio test

In the present situation of detecting changes in (scalar) AR or ARMA models, the generalized likelihood ratio (GLR) test presented in the previous section may still be used. The log-likelihood is computed as in (17) using the conditional laws of the observations, and the parameter  $\theta$  defined in (2) for AR models. In an on-line framework where  $\theta'_0 = \theta_0$  in (5) and the law  $p_{\theta_0}$  is assumed to be known (possibly up to a convenient identification), the GLR test is exactly as in (18). But the maximization over  $\theta_1$  is no longer explicit, and moreover in the ARMA case the cumulative sum (17) is no longer linear in the parameters. Therefore the test (17)-(18) is quite time-consuming.

Assume now that  $\theta'_0 \neq \theta_0$  in (5) -which is generally the case in off-line approaches. In that situation, the log-likelihood ratio for a sample of size n is:

$$S_1^n \left( p_{\theta_0}; r, p_{\theta'_0}, p_{\theta_1} \right) = \sum_{k=1}^{r-1} \frac{p_{\theta'_0}(Y_k | \dots)}{p_{\theta_0}(Y_k | \dots)} + \sum_{k=r}^n \frac{p_{\theta_1}(Y_k | \dots)}{p_{\theta_0}(Y_k | \dots)} \quad (17')$$

If none of the parameters  $\theta_0, \theta'_0, \theta_1, r$  are known, the GLR test is as follows:



Detecting changes in signals and systems -A survey-

$$\max_{1 \leq r \leq n} \max_{\theta_0} \max_{\theta_0'} \max_{\theta_1} S_1^n \left( p_{\theta_0}; r, p_{\theta_0'}, p_{\theta_1} \right) \begin{matrix} H_1 \\ > \\ < \\ H_0 \end{matrix} \lambda \quad (18')$$

In other words, the unknown parameters are again replaced by their MLE. Further details for the AR case will be given below. A complete theoretical investigation of this test is done in (Deshayes and Picard, 1986) with the aid of convenient statistical asymptotic analyses and will be reported in the next section.

Nevertheless, several design issues may be extracted from the GLR methodology, as will be shown below for detecting changes in AR models.

2. The two-models approach for on-line change detection in AR models

Let us consider an AR process:

$$y_n = \sum_{i=1}^p a_i^{(n)} y_{n-i} + \varepsilon_n \quad (20)$$

where  $(\varepsilon_n)$  is a gaussian white noise with variance  $\sigma_n^2$ , and:

for  $1 \leq i \leq p$ :

$$a_i^{(n)} = \begin{cases} a_i^0 & \text{for } n \leq r - 1 \\ a_i^1 & \text{for } n \geq r \end{cases}$$

and

$$\sigma_n^2 = \begin{cases} \sigma_0^2 & \text{for } n \leq r - 1 \\ \sigma_1^2 & \text{for } n \geq r \end{cases} \quad (21)$$

Let us define:

Detecting changes in signals and systems -A survey-

$$\theta^j = (a_1^j, \dots, a_p^j, \sigma_j^2) \quad (j=0,1)$$

and

$$Y^{n-1} = (Y_{n-1}, \dots, Y_1)^T$$

The problem is to detect a change in  $\theta$  and to estimate the change time  $r$ .

2.1. Implementation of the GLR test

An on-line implementation of the algorithm (17)-(18) is depicted on figure 3 and may be described as follows. If the AR model  $M_0$  under the no change hypotheses (i.e. before the change) is not known, identify it with the aid of a recursive growing memory filter. On the other hand, for each possible change time  $r$ , use the data of the time window  $\{r, r+1, \dots, n-1, n\}$  for identifying the AR model  $M_1$  after change, and compute the log-likelihood ratio  $S_r^n$ . Then maximize over  $r$ . Other distance measures between the two models  $M_0$  and  $M_1$  will be reported below.

If the full GLR algorithm (17')-(18') is implemented on-line, three models  $M_0, M'_0, M_1$  have to be identified: for fixed  $r$ ,  $M_0$  and  $M'_0$  with growing memory filters using the data of the time windows  $\{1, \dots, n\}$  and  $\{1, \dots, r-1\}$  respectively;  $M_1$  using the time window  $\{r, r+1, \dots, n-1, n\}$ . Then the maximization over  $r$  has to be performed. Actually it may be easily shown that, for ARMA processes, the GLR test (17')-(18') is:

$$\max_{1 \leq r \leq n} u_n(r) > \lambda$$

where:

$$u_n(r) = n \text{Log } \hat{\sigma}_0^2 - \left[ (r-1) \text{Log } \hat{\sigma}'_0{}^2 + (n-r+1) \text{Log } \hat{\sigma}_1^2 \right] \quad (22)$$

in which  $\hat{\sigma}_0^2, \hat{\sigma}'_0{}^2, \hat{\sigma}_1^2$  are the variances of the innovations of the (estimated) models  $M_0, M'_0, M_1$  respectively.

A simplified and approximated implementation was proposed by Appel and Brandt (1983). The detection of the change is done first, using a fixed window length  $N = n-r+1$  for  $M_1$ , and the decision rule:

Detecting changes in signals and systems -A survey-

$$u_n(N) = n \text{Log } \hat{\sigma}_0^2 - \left[ (n-N) \text{Log } \hat{\sigma}_0^2 + N \text{Log } \hat{\sigma}_1^2 \right] \begin{matrix} H_1 \\ > \\ < \\ H_0 \end{matrix} \lambda \quad (23)$$

The estimation of the change time is done in a second step. The resulting algorithm is very close to GLR.

2.2 Other distance measures between the two models

By the same time, Basseville and Benveniste (1983b) also proposed to use the above mentioned two-model approach for change detection (figure 4): compute or distance between a long term or global AR model  $M_0$  and a short term or local AR model  $M_1$ . Several distance measures may be used (Gray and Markel, 1976). The euclidian distance:

$$\sum_{i=1}^p (a_i^1 - a_i^0)^2$$

is bad, because of no mathematical nor spectral theoretical meaning, but unfortunately still often used in practice. The relevant distance between the spectral densities:  $S_j(e^{i\omega})$  ( $j=0,1$ ) is :

$$\| \text{Log } S_1(e^{i\omega}) - \text{Log } S_0(e^{i\omega}) \|_{L^2}$$

which may be well approximated by the cepstral distance, namely the euclidian distance between the cepstral coefficients (Gray and Markel, 1976). Another distance was given in (22), which may be seen as Chernoff distance between the joint distributions of the observations. Finally, Basseville and Benveniste (1983b) proposed the use of Kullback divergence between the conditional distributions of the observations, namely:

$$w_n = \frac{1}{2} \left( \frac{\hat{\sigma}_0^2}{\hat{\sigma}_1^2} - 1 \right) + \left( 1 + \frac{\hat{\sigma}_0^2}{\hat{\sigma}_1^2} \right) \frac{(e_n^0)^2}{2\hat{\sigma}_0^2} - \frac{e_n^0 e_n^1}{\hat{\sigma}_1^2} \quad (24)$$

where

Detecting changes in signals and systems -A survey-

$$e_n^j = y_n - \sum_{i=1}^p \hat{a}_i^j y_{n-i} \quad (j=0,1)$$

are the innovations of the growing memory and sliding filters respectively.

Because the effect of a change in the AR model is reflected on  $W_n$  (24) by a change in the sign of its mean value, an accurate estimation of the change time may be obtained if we add the Page-Hinkley stopping rule (11) computed on the  $w_n$ .

The differences between the algorithms (22) of Appel and Brandt (1983) and (24) of Basseville and Benveniste (1983b) lie in the distance which is used between the two models  $M_0$  and  $M_1$  of the figure 4, and in the estimation of the change time. But they are very similar in their spirit and have been compared by André-Obrecht (1986) for the segmentation of continuous speech signals. An example may be seen on figure 5. We refer the reader to (Basseville and Benveniste (Ed.), 1986, ch.6) for further discussions and comparisons between the two above mentioned algorithms and also with the cepstral distance. For other uses of distance measures for segmentation, see (Ishii and co-workers, 1980).

2.3 Comments on this approach

Three key features have to be emphasized. First, this particular implementation of the two-models approach is more efficient than a previous one (Bodenstein and Praetorius, 1977) which is depicted on figure 6. It consists in the comparison of two local models  $M_0''$  and  $M_1$  identified inside two finite windows having the same length. Clearly the reference model  $M_0$  (before change) is far more precisely identified than  $M_0''$  and, if small forgetting ability is used, it will be slightly modified by the change, and thus the false alarm rate should be reduced.

Second, this two-models approach is more efficient than classical  $\chi^2$ -type tests on the innovations, as:

$$u_n = \sum_{k=1}^n \left[ \frac{(e_k^0)^2}{\hat{\sigma}_0^2} - 1 \right] \quad (25)$$

which was studied in (Segen and Sanderson, 1980) for example. This test is "blind", is in fact designed to detect a deviation with respect to the noise behavior -thus the range of changes that can be

## Detecting changes in signals and systems -A survey-

detected is larger with the former approach (24) than with the latter (25)- and may have a high variance before change. See (Basseville and Benveniste, 1983b) for further discussions.

Finally, no theoretical result concerning performance evaluation of the two-models approach is available by now, except in the case of exact implementation of the likelihood ratio test GLR which will be investigated in the next section.

A non-parametric treatment of this approach may be found in (Kedem and Slud, 1982) and will be commented in the last section.

## V. THE LIKELIHOOD APPROACH IN A GENERAL FRAMEWORK

As we already mentioned in section I, the likelihood ratio approach is a fairly general tool for change detection which may be used in general situations encountered in Automatic Control and Signal Processing, such as changes in multivariable AR or ARMA models and changes in the state transition matrix of a state space model.

This approach again consists in computing the log-likelihood ratio (17) based upon the conditional distribution of the observations (conditioned by their past values), and in running the GLR test (18) which generally involves a double maximization of high computational cost. For this reason, several different approximations have been designed, even in scalar case as described in the previous section. Another general tool for approximating the likelihood ratio will be presented in the next section. However, the GLR may at least be used as a benchmark for other algorithms, because its theoretical optimality has been completely investigated recently (Deshayes and Picard, 1986) from an off-line point of view.

Before giving the key result of this study, let us first briefly outline the main difficulty of the change detection problem.

Usually the criterion for performance evaluation of statistical tests between two hypotheses  $H_0$  and  $H_1$  -here no change and change respectively- is to maximize the power (or probability of good choice of  $H_1$ ) for a fixed level (or probability of false alarm or wrong choice of  $H_1$ ). When  $H_1$  is not reduced to a single distribution, the best property for a test is to be uniformly most powerful UMP (for each distribution belonging to  $H_1$ ). Unfortunately, because the parameters of interest in change detection problems -namely the change time and the change magnitude- are such that the Neyman-Pearson lemma (Lehmann, 1959) is not valid, change detection problems are multiple hypotheses testing problems for which no UMP test does exist. For this reason it is necessary to define an asymptotic framework in which UMP tests exist for change detection problems. Deshayes and Picard (1986) use the large deviations asymptotic analysis in which exponential errors probabilities (namely the logarithm of the two probabilities of

## Detecting changes in signals and systems -A survey-

wrong decision) are used. In this framework the GLR test is shown to be UMP. The asymptotic behaviour of the test is derived together with the asymptotic distribution of the change time and magnitude estimates.

### VI. THE STATISTICAL LOCAL APPROACH

In this section we describe another approach for overcoming the main drawback of the GLR test (18), namely its computing time cost due to the double maximization. This approach is known by Statisticians under the name of local approach and has been introduced in change detection problems by Nikiforov (1983, 1986a) for on-line detection of changes in spectral characteristics. The use of the local approach in conjunction with other functions than the likelihood one has been proposed in (Basseville and co-workers, 1985) and (Benveniste and co-workers, 1986) and will be described in the next section.

#### 1. Local approach for changes in spectral properties

The original idea of Nikiforov (1983, 1986a) consists in looking for small changes in AR (or ARMA) models and using a special type of Taylor's expansion of the log-likelihood function which is called Le Cam's asymptotic expansion (Roussas, 1972). In other words, instead of monitoring the observations process  $(y_n)$  or the innovation process, the local approach monitors:

$$z_n = \frac{d}{d\theta} \text{Log } p_\theta (y_n | y_{n-1}, \dots) |_{\theta = \theta_0} \quad (26)$$

The key theoretical point here (Deshayes and Picard, 1986) is that there exists a central limit theorem for  $z_n$ , the main consequence of which is as follows. Any change in  $\theta$  (2) is reflected in a change in the mean of  $z_n$  for which the Page-Hinkley stopping rule (11) or the GLR (15) of section II may be used.

Using two different kinds of a priori information about the changes to occur (changes along a known direction, changes outside an ellipsoid centered at the reference model  $\theta_0$ ), Nikiforov developed two algorithms based upon the detection rule (11), which he called cumulative sum algorithms (CSA).

More precisely, recall that the considered detection rule was defined with the aid of:

$$g_n = \max_{1 \leq k \leq n} S_k^n (\theta_0, v) \quad (27)$$

## Detecting changes in signals and systems -A survey-

In the first case of change along a known direction  $C$ , the parameter  $\theta$  evolves as:

$$\theta = \theta_0 + \eta C \quad (28)$$

and the corresponding cumulative sum to be used in (27) is:

$$S_k^n(\theta_0, C) = \sum_{i=k}^n z_i^T C \quad (29)$$

where  $z_k$  is defined in (26).

In the second case of change outside an ellipsoid for which:

$$(\theta - \theta_0)^T \mathcal{F}(\theta - \theta_0) > \eta \quad (30)$$

the corresponding function in (27) is:

$$S_k^n = \left( \sum_{i=k}^n z_i \right)^T \mathcal{F}^{-1} \left( \sum_{i=k}^n z_i \right) \quad (31)$$

We refer the reader to (Nikiforov, 1986a) for further details. Insist upon the fact that these cumulative sum algorithms may be designed for any change in a multivariable ARMA process. The application of this methodology to seismic signal processing is described in (Nikiforov and Tikhonov, 1986b).

### 2. A tool for performance evaluation of CSA

Another interesting part of the above mentioned work is the derivation of a convenient tool for performance evaluation of cumulative sum algorithms. This tool, known as the average run length, allows to compute both the false alarm rate and the delay for detection with the aid of a single function which is the expectation of the detection time under the convenient probability law. We refer to (Nikiforov, 1986a) for more details. With respect to the criterions we discussed in section I.4, the delay for detection which is evaluated is defined in the same manner as in (Lorden, 1971).

## VII. A COUNTER-EXAMPLE AND ANOTHER USE OF THE LOCAL APPROACH

Detecting changes in signals and systems -A survey-

In spite of the wide applicability and the good properties of the statistical change detection/estimation algorithms described -namely the likelihood ratio and the local approaches-, there exist situations where none of these two approaches can be used because of coupling effects in the likelihood function between the parameters to be monitored and unknown nuisance parameters.

The purpose of this section is the presentation of such a counter-example and of the corresponding solution which has been recently derived (Basseville and co-workers, 1985). This solution may be extended to more general situations as will be shown below: to any recursive parameter estimation algorithm may be associated a change detection and a model validation scheme (Benveniste and co-workers, 1986), using the local approach for a conveniently chosen statistics.

1. An example of change detection in presence of nuisance parameters

The example 2 of vibration monitoring of structures under natural excitation, which was described in I.1.2., may be easily stated as a problem of detecting changes in the AR part of a multivariable ARMA process having unknown and time-varying MA coefficients to be considered as nuisance parameters. Because the Fisher information matrix of an ARMA process is not block-diagonal with respect to the AR and MA parameters, neither the likelihood function nor its "Taylor"'s expansion (local approach) are of any help for solving this particular detection problem. The solution presented in (Basseville and co-workers, 1985) uses two basic tools. Let:

$$Y_n = \sum_{i=1}^p A_i Y_{n-i} + \sum_{j=0}^{p-1} B_j(n) E_{n-j} \quad (32)$$

be the considered ARMA process, where  $(E_n)$  is a standard gaussian white noise sequence. The first tool to be used is what we call the instrumental statistics:

$$U_n = \sum_{k=p+N-1}^n Z_k W_k^T \quad (33)$$

where

$$Z_k^T = \left( Y_{k-p}^T \dots Y_{k-p-N+1}^T \right)$$

is the vector of past observations and:

$$W_k = Y_k - A_1 Y_{k-1} - \dots - A_p Y_{k-p}$$

is the MA part.



Detecting changes in signals and systems -A survey-

The second tool to be used is the local approach described in section VI, however not connected to the likelihood function but to the above instrumental statistics  $U_n$  (33). In other words, we again look for small changes in the AR coefficients  $(A_i)$  of (32), and it turns out that, because of the nonstationary <sup>1 ≤ i ≤ p</sup> central limit theorem of (Moustakides and Benveniste, 1986b), these changes are reflected in changes in the mean of the instrumental statistics  $U_n$  which is furthermore asymptotically gaussian distributed with covariance matrix  $\Sigma_n$ . As we followed for that application an off-line model validation approach (validation of a "signature" on a new record of measurements), the convenient test for detecting a change in the mean of  $U_n$  is simply the  $\chi^2$  test:

$$U_n^T \Sigma_n^{-1} U_n \underset{H_0}{\overset{H_1}{>}} \lambda \quad (34)$$

As shown in (Basseville and co-workers, 1985), this test is very powerful in practice. Its theoretical properties are investigated in (Rougée and co-workers, 1985). We will see in section IX how it can be used for solving the diagnosis problem. Finally an on-line implementation is reported in (André-Obrecht, 1986) for another application.

2. Extended use of the local approach for change detection and model validation

The detection solution presented above may be extended to more general situations than ARMA models. Actually the key idea in the previous example was to use, for the detection problem, the same starting point as in the identification problem. It was known that the instrumental variable identification method for estimating the AR part of an ARMA process was theoretically (Benveniste and Fuchs, 1985) and experimentally (Prevosto and co-workers, 1983) robust with respect to the unknown and time-varying MA part. Thus the "instrumental statistics"  $U_n$  (33) was defined and theoretically studied for deriving the detector (34).

In the same manner, starting from any general recursive parameter identification algorithm:

$$\theta_n = \theta_{n-1} + \gamma_n H(\theta_{n-1}, X_n) \quad (35)$$

and applying the local approach to the statistics  $H(\theta_0, X_n)$  where  $\theta_0$  is a nominal model, it is possible to prove a central limit theorem which transforms the problem of detecting changes in the parameter vector  $\theta$

## Detecting changes in signals and systems -A survey-

into the problem of detecting changes in the mean value of an asymptotically gaussian distributed process which is a convenient cumulative sum of the function  $H$ . We refer to (Benveniste and co-workers, 1986) for more details.

We shall see in section IX how this general approach may be used for solving the diagnosis problem.

### VIII. GENERATING THE SIGNALS TO BE MONITORED

This section is devoted to the presentation of different types of algorithms for solving the task i described in I.2, namely the problem of generating the signals to be monitored in order to achieve change detection. For this purpose, both deterministic and stochastic algorithms may be used, and we distinguish two classes of methods which achieve the compression of information in different ways: redundancy and filtering operations. The generation of such "residuals" or "change indicating signals"  $\Delta$  may be generally summarized as in the diagram of figure 7 (Mironovski, 1980) where  $P$  is the studied process or system having inputs  $U$  and outputs  $Y$ , and where  $H$  and  $F$  will be defined below.

#### 1. Redundancy methods

These techniques, which are well known in the Automatic Control community, are basically deterministic. They exploit either the direct physical redundancy present in the system, or the analytical redundancy, i.e. the deterministic instantaneous or temporal relations between various measurements. If the degree of consistency is high enough, a diagnosis of the change can be obtained as will be shown below.

##### 1.1. Direct or physical redundancy

If several identical sensors measuring the same quantities are available, the differences between the two signals contained in each possible pair may of course reflect a failure. In the diagram of figure 7, for a duplicate system  $H$  is the second system, and the operator  $F(Y,Z)$  producing the "residual"  $\Delta$  is a simple difference. These "residuals" are generally processed with the aid of voting methods (Willsky, 1976a). But another possible processing consists in searching, given an error bound for each sensor, for subsets of measurements with different degrees of consistency. The most consistent subset is used for estimating the measured quantity, and the less consistent one -if it exists- for isolating the failure. This has been done in (Desai and Ray, 1984) for multidimensional measurements, for example speed and acceleration in a three-dimensional space. It has to be noticed that this method allows to process simultaneously real measurements and artificial measures resulting from the investigation of the analytical redundancy of the system. Furthermore it is possible to solve the problem of calibration between measurements from identical sensors having different biases

## Detecting changes in signals and systems -A survey-

for examples (Ray and Desai, 1983).

### 1.2. Indirect or analytical redundancy

Analytical redundancy is the set of all existing instantaneous or temporal relationships between the inputs of the actuators and the outputs of the sensors of the system which are identically zero when no change occurs. These techniques seem to have been developed independently in the United States (Deckert and co-workers, 1977; Chow and Willsky, 1980) and in Soviet Union (Mironovski, 1980). We present here some key-points when deriving redundancy relations in the two situations where the system is represented by a state space model -first deterministic and then noisy- or by a block-diagram connecting elements with known transfer functions.

#### *1.2.1. Deterministic case*

Consider a deterministic system described by:

$$\begin{cases} \dot{X} = AX + BU & X \in \mathbb{R}^n, U \in \mathbb{R}^r \\ Y = CX & Y \in \mathbb{R}^s \end{cases} \quad (36)$$

If the system has a natural redundancy, i.e. if there exists, independently of the value of the inputs  $U$ , an algebraic relationship  $M(Y)=G$  where  $G$  is a constant, then the diagram of figure 7 may be simplified: the block  $F$  is such that:  $F(Y)=M(Y)-G$ , and there is no block  $H$ . These algebraic invariants have been extensively studied in Soviet Union (Mironovski, 1980). When no such invariant exists, a so-called redundant variable is introduced in order to satisfy the following condition:

$$\Delta = F(Y, Z) = M(y_1, \dots, y_s) + z = 0 \quad (37)$$

where  $M$  is an instantaneous relation which may be linear in the  $y_i$ . Several methods are available for designing  $z$ , namely for designing the block  $H$ . If the goal is that:

$$\Delta = MY + z = 0$$

with  $M$  a constant row vector, be true when no change occurs, one solution consists in implementing the scalar first order equation:

$$\dot{z} = A_1 z + B_1 U$$

with  $A_1 = -MCA$  and  $B_1 = -MCB$ .

For an observable system, another solution consists in using as  $H$  a Luenberger observer designed for estimating the instantaneous linear combination of the states of the system:  $-MY = -MCX = LX$ . Recall that for a noisy system the best observer of  $X$ , in the mean square sense,

Detecting changes in signals and systems -A survey-

is the Kalman filter, which is of order  $n$  and thus is equivalent to a system duplication. Luenberger derived a method which allows to reduce the order to  $n-s$ , where  $s$  is the dimension of the observation  $Y$ . The order may be further reduced if  $LX$  is estimated and not  $X$ . If such an observer is described by the system:

$$\begin{cases} \dot{W} = FW + GU + HY \\ z = QW + RY \end{cases} \quad (38)$$

the problem is, for known  $A, B, C$ , to find matrices  $F, G, H, Q, R$  such that:

$$\lim_{t \rightarrow \infty} (z-LX) = 0 \quad (39)$$

A necessary and sufficient condition for solving this problem is that  $F$  should be stable and there exists  $T$  such that:  $TA-FT=HC$  and  $G=TB$  (Kailath, 1980). The order  $k$  of the minimum order observers of  $LX$  is such that:

$$k \leq v_0 - 1$$

where  $v_0$  is the observability index and satisfies:

$$\frac{n}{s} \leq v_0 \leq n - s + 1$$

In the more general case where  $L$  is no longer a row vector, the problem has not been solved yet. Applying this theory leads to fill the diagram of figure 7 with a Luenberger observer as  $H$  and the linear combination  $M$  as  $F$ . This results in the diagram of figure 8. For avoiding the degenerate solution of order 0 (which results from (39)), the observer is limited to the case where  $R=0$ , i.e.  $z=QW$ . Consider now the problem of designing a device as in the diagram of figure 8, but of minimum order  $k$ . It may be described by the equation:

$$p^k \Delta = p^k MY + p^{k-1} (\alpha_{k-1} Y + \beta_{k-1} U - \gamma_{k-1} z) + \dots + (\alpha_0 Y + \beta_0 U - \gamma_0 z) \quad (40)$$

Detecting changes in signals and systems -A survey-

where  $p^i$  is the  $i$ -th differential operator.

Substituting  $z = -MY$ ,  $Y=CX$ ,  $\dot{Y}=CAX+CBU, \dots$ , results in:

$$\Delta^{(k)} = \left( \sum_{i=0}^k (\alpha_i + \gamma_i M) CA^i \right) X + (\beta_{k-1} + MCB) U^{(k-1)} \\ + \dots + \left( \beta_0 + \sum_{i=1}^k (\gamma_i + \gamma_i M) CA^{i-1} B \right) U = 0$$

where  $\alpha_k = 0$  and  $\gamma_k = 1$ . This relation is satisfied for any input  $U$  if and only if:

$$(\alpha_0 + \gamma_0 M ; \alpha_1 + \gamma_1 M ; \dots ; \alpha_{k-1} + \gamma_{k-1} M ; M) \begin{pmatrix} C \\ CA \\ \cdot \\ \cdot \\ CA^k \end{pmatrix} = 0 \quad (41)$$

and for  $j$  from 0 to  $k-1$ :

$$\beta_j = \sum_{i=j+1}^k (\alpha_i + \gamma_i M) CA^{i-1-j} B$$

Mironovski (1979) has shown that the minimum order  $k$  of a device such in figure 8 is always between the smallest and the largest Kronecker invariant index, and that it is possible to choose  $M$  in order to reach these bounds in  $k$ . From (40) and (41), it can be seen that this approach leads to the concept of "parity check" studied by Chow and co-workers (1980,1986). They use an ARMA model (40) and look for the orthogonal space of the range of the observability matrix (41).

1.2.2. Extension to noisy systems

If the model (36) is perturbed by noises on the state  $X$  or the observation  $Y$ , the relation (37) no longer holds even when no change occurs. Therefore redundancy relations which are robust with respect to the noise have to be defined. One possible solution consists in searching for conditions similar to (41) but related to an extended

Detecting changes in signals and systems -A survey-

observability space taking noise into account (Chow and co-workers, 1986). Using the same approach, it is possible to take into account uncertainties on the parameters A,B,C. It is also possible to avoid such a modelling and to work directly with the empirical covariances of the observations (Pattipati and co-workers, 1984).

1.2.3. Systems defined with transfer functions

The use of redundant variables has been also studied for linear systems described by any block diagram connecting elements with known transfer functions  $W_1(p), \dots, W_n(p)$  (Mironovski, 1980). The simplest choice for the redundant variable  $z$  corresponds to:

$$z = \sum_{i=1}^n (\alpha_{0i} u_i + \beta_{0i} y_i) + W_{n+1}(p) \sum_{i=1}^n (\alpha_{1i} u_i + \beta_{1i} y_i) \quad (42)$$

It can be shown (Britov and Mironovski, 1972) that the transfer function  $W_{n+1}(p)$  satisfying (42) and (37) exists only if the  $n$  transfer functions describing the system have the following form:

$$W_i(p) = \frac{c_i + d_i W(p)}{a_i + b_i W(p)}$$

where  $W(p)$  is a transfer function, for example  $\frac{1}{p}$ . More generally, a redundancy relation  $z$  of the form:

$$z = \sum_{i=1}^n (\alpha_{0i} u_i + \beta_{0i} y_i) + W(p) \sum_{i=1}^n (\alpha_{1i} u_i + \beta_{1i} y_i) + \dots + W^m(p) \sum_{i=1}^n (\alpha_{mi} u_i + \beta_{mi} y_i)$$

can be obtained only if:

$$W_i(p) = \frac{a_{mi} W^m(p) + \dots + a_{1i} W(p) + a_{0i}}{b_{mi} W^m(p) + \dots + b_{1i} W(p) + b_{0i}} = \frac{A_i(W(p))}{B_i(W(p))}$$

and then the coefficients  $\alpha_{ij}$  and  $\beta_{ij}$  are given by:

## Detecting changes in signals and systems -A survey-

$$\begin{aligned}\alpha_{0i} &= -m_i a_{0i} ; \beta_{0i} = m_i (b_{0i} - 1) \\ \alpha_{ij} &= -m_i a_{ji} ; \beta_{ij} = m_i b_{ji}\end{aligned}$$

(Britov and Mironovski, 1972). Consequently, for any system defined with components having rational transfer functions, it is possible to design a detection device such in figure 8, of order equal to the largest order of the elements belonging to the system, and thus generally far lower than the system order.

### 2. Filtering methods

#### 2.1. Kalman filters and state observers

A rather old solution (Willsky, 1976a) to the change or failure detection problem consists in monitoring the innovations or prediction errors of some conveniently chosen estimation filter(s) or parameter identification algorithm(s) which fills the block H of the diagram of figure 7. This idea has been developed along two main axis. The first viewpoint led to design filters especially sensitive to the changes under study; this is precisely what was described above for the various observers. The other approach consists in using the optimal state estimate, namely the Kalman filter, designed according to the model of the system (or signal) in its normal operating mode. As will be shown in the next section, if diagnosis is desired in addition to detection, a possible solution consists in using a bank of Kalman filters designed according to all the available possible models of the system (or signal) under all the change hypotheses. The corresponding decision rules will be discussed in the next section. But, as far as the design of decision rules is concerned, we insist upon the fact that the Kalman filter is the only one which produces zero-mean and independent residuals -under the no-change hypothesis- when state and/or measurement noises are present. This is generally not the case for the instantaneous or temporal redundancy relations described above. Therefore the assumption of independence in statistical decision rules is valid only for the innovations of Kalman filters. For monitoring other types of "residuals", it may be of interest to use the algorithms for detecting changes in spectral characteristics presented in section IV.

#### 2.2. Generalization to extended or decentralized Kalman filters

The extension of the above approach to non-linear dynamical systems may be achieved with the use of extended Kalman filters (Himmelblau, 1978; Usoro and co-workers, 1985). On the other hand, in order to reduce the implementation cost of Kalman filters, and also to introduce protection against some subsystems failures, the use of decentralized filters is currently under investigation in the aeronautic domain (Kerr, 1985).

#### 2.3. Extension to other identification methods

The detection strategy which is commonly chosen in connection with filtering methods for change detection, consists in testing how much the sequence of innovations has deviated from the "white noise"

**Detecting changes in signals and systems -A survey-**

hypothesis. See (Mehra and Peschon, 1971) and (Willsky and co-workers, 1975) for example. The tests which are used are then classical tests for zero-mean, independence, unit variance,... But, in some practical problems, it may be useful and even necessary to monitor some more complex function of the innovations than the innovations themselves. This is the case in the example 2 of section I, and we described in section VII a systematic approach transforming a possibly complex change detection problem into the simple problem of change in the mean of a gaussian process with known covariance matrix.



## Detecting changes in signals and systems -A survey-

### IX. THE DIAGNOSIS PROBLEM

In this section, we investigate the diagnosis problem, namely the problem of estimating the origin of the change and possibly its location in the system. Two types of situations have to be distinguished, of unequal degree of difficulty.

#### i. diagnosis of changes on identifiable model sets

In this case, there is a one-to-one correspondence between the parameters used for detecting model changes and the parameters for which diagnosis is desired. For example, you monitor an AR or ARMA model, and you wish to know, when a change is detected, which poles actually moved.

#### ii. diagnosis of changes on non identifiable model sets

This situation is much more difficult to solve because the convenient parameterization for diagnosis is in terms of not identifiable parameters. An example of such a situation is described in (Basseville and co-workers, 1985) and (Moustakides, 1986c) (see example 2 of section I): it is desired to diagnose the changes in terms of the mechanical characteristics of the structure which are not identifiable partly because of a model reduction performed in practice for monitoring.

Up to our knowledge, three types of methods have been developed for answering such questions. The multiple model (MM) approach is probably the older one and has been investigated in several directions. The generalized likelihood ratio (GLR) methodology using several possible models is another solution. Finally the local approach of sections VI and VII may be used for solving the diagnosis problem even in the situation ii described above.

#### 1. The multiple model approach

The use of several possible models of the system under consideration is of common practice especially in Automatic Control for different purposes. An overview of such an approach for state estimation can be found in (Pattipati and Sandell, 1983). Adaptive identification is discussed in (Tugnait, 1982b), and the design of adaptive gains in recursive identification is reported in (Andersson, 1985). The use of the MM approach in change detection is reviewed in (Willsky, 1976a). Generally speaking, in MM environment change detection is based upon the monitoring of the a posteriori probabilities of the different models, and, in order to avoid the exponential growing of the size of the filters bank to be used, several suboptimal strategies have been proposed. See for example (Willsky and co-workers, 1975, 1980), (Tugnait, 1982a).

Of course, this methodology brings information for diagnosis: each model corresponds to a different change situation and the maximum a posteriori probability indicates what is the most likely change. This approach involves implicitly Bayesian techniques, for which an extensive study may be found in (Peterka, 1981).

## Detecting changes in signals and systems -A survey-

### 2. The GLR methodology

If you know a list of  $N$  possible (additive) failure directions  $f_j$  for the system (16), then activating in parallel  $N$  GLR tests corresponding to these directions leads to a diagnosis of the change, according to the largest of these tests.

### 3. Two uses of the local approach

The local approach presented in section VI may be used for solving the diagnosis problem in the following manner. If several possible directions of changes  $C_j$  are known in advance, running in parallel the corresponding cumulative sum algorithms (27)-(29) leads to diagnosis of the change.

A second possible use of the local approach for diagnosis is related to the example 2 of section I and reported in (Basseville and co-workers, 1985) and (Moustakides, 1986c). It consists in focussing the instrumental test (34) on some pre-specified subspaces of the parameter space using convenient jacobians. In the situation *ii* described above, the computation of the relevant jacobians is much more complicated, because of the necessary model reduction, but a solution does exist and provides satisfactory results for diagnosis in terms of the mechanical parameters  $M$  and  $K$  of equation (3).

This approach may be generalized in order to associate to any recursive parameter identification algorithm a procedure for diagnosing changes even in terms of non identifiable model sets. We refer to (Benveniste and co-workers, 1986) for further details.

## X. OPEN PROBLEMS AND CONCLUSIONS

We have described what we think to be the state of the art about change detection, estimation and diagnosis in signals and dynamical systems. We have mainly investigated parametric statistical approaches, especially for the design of convenient decision rules, with special attention to the general likelihood ratio methodology.

One important issue we have not addressed for change detection algorithms is the problem of robustness with respect to unmodelled phenomena. Some discussions about this point may be found in (Chow and co-workers, 1986) and (Basseville and Benveniste, 1983a-b) for example. One basic conclusion of these works is that it is possible to obtain accurate change detection and estimation using both a simplified model of the monitored signal or process and a convenient detector. For example, the two-models approach with AR models and Kullback's divergence (see IV.2.2.) leads to a sensible segmentation of continuous speech signals (André-Obrecht, 1986), even though it is well known that AR models are not convenient for modelling speech.

## Detecting changes in signals and systems -A survey-

A radical way of getting rid of this robustness problem consists in using non parametric techniques (Kassam, 1980). For example, Kedem and Slud (1982) use zero-crossings statistics in order to characterize the global and the local models of figure 3 as well as a distance measure between them. Dehayes and Picard (1986) report some theoretical results about off-line Kolmogorov-Smirnov's tests applied to the empirical cumulative spectral distribution function (integral of the periodogram). Finally, Darkhovskii (1985) gives a consistency result for an estimate of the change time based upon an extension of the Mann-Whitney's statistics.

Apart from this important robustness problem, the open problems are of three different types. First, as far as on-line signal segmentation is concerned, the two-models approach we described is not convenient when the segments to be found are short. Second, still in an on-line framework, other types of criteria than delay for detection should be optimized, especially for the problems of change or failure detection in controlled industrial processes: convenient criterions should include inspection and repairing costs for example. Finally, much remains to be done in the field of diagnosis, especially when the parametric models which are used for monitoring are of far lower dimension than the monitored system. The general solution proposed in (Benveniste and co-workers, 1986) should be experimented on different types of systems, and such solutions should be included in general preventive maintenance strategies.

### REFERENCES

- Andersson, P. (1985). Adaptive forgetting in recursive identification through multiple models. *Int. J<sup>st</sup> Cont.*, 42, 1175-1193.
- André-Obrecht, R. (1986). A new statistical approach for the automatic segmentation of continuous speech signals. *Research Report IRISA n°287/INRIA n°511*.
- Appel, U., A.V. Brandt (1983). Adaptive sequential segmentation of piecewise stationary time series. *Information sciences*, 29.
- Basseville, M., B. Espiau, J. Gasnier (1981). Edge detection using sequential methods for change in level - Part I: A sequential edge detection algorithm. *IEEE Trans. on A.S.S.P.*, 29, 16-31.
- Basseville, M. (1981). Edge detection using sequential methods for change in level - Part II: Sequential detection of change in mean. *IEEE Trans. on A.S.S.P.*, 29, 32-50.
- Basseville, M. (1982). Contribution à la détection séquentielle de ruptures de modèles statistiques. *Thèse d'Etat*, Univ. Rennes I, France (survey in English).

Detecting changes in signals and systems -A survey-

Basseville, M., A. Benveniste (1983a). Design and comparative study of some sequential jump detection algorithms for digital signals. *IEEE Trans. on A.S.S.P.*, 31, 521-534.

Basseville, M., A. Benveniste (1983b). Sequential detection of abrupt changes in spectral characteristics of digital signals. *IEEE Trans. on Inf. Th.*, 29, 709-724.

Basseville, M., A. Benveniste, G. Moustakides, A. Rougée (1985). Detection and diagnosis of changes in the eigenstructure of nonstationary multivariable systems. *Research report IRISA n°276/INRIA n°477*. to appear in *Automatica*.

Basseville, M., A. Benveniste (Ed.) (1986). *Detection of abrupt changes in signals and dynamical systems*, LNCIS n°77, Springer-Verlag, Berlin.

Benveniste, A., J.J. Fuchs (1985). Single sample modal identification of a nonstationary stochastic process. *IEEE Trans. on A.C.*, 30, 66-74.

Benveniste, A., M. Basseville, G. Moustakides (1986). The asymptotic local approach to change detection and model validation. *Research Report IRISA n°307/INRIA n°564*. to appear in *IEEE Trans. on Aut. Cont.* Presented at *C.D.C. 86.*, Athens, Greece.

Bodenstein, G., H.M. Praetorius (1977). Feature extraction from the encephalogram by adaptive segmentation. *Proc. IEEE*, 65, 642-652.

Bojdecki, T., J. Hosza (1984). On a generalized disorder problem. *Stoch. Proc. and their Appl.*, 18, 349-359.

Bouthemy, P. (1986). Determining displacement fields along contours from image sequences. *Proc. Graphics Interface '86/Vision Interface '86*.

Britov, G.S., L.A. Mironovski (1972). Diagnostics of linear systems of automatic regulation. *Tekh. Kibern.*, 1, 76-83.

Chow, E.Y., A.S. Willsky (1980). Issues in the development of a general design algorithm for reliable failure detection. *Proc. 19<sup>th</sup> C.D.C.*, Albuquerque, N.M.

Chow, E.Y., X.C. Lou, G.C. Verghese, A.S. Willsky (1986). Redundancy relations and robust failure detection. in Basseville and Benveniste (Ed.), ch.9, 275-294.

Corge, J., F. Puech (1986). Analyse du rythme cardiaque foetal par des méthodes de détection de rupture. *Proc. 7<sup>th</sup> INRIA Int. Conf. Analysis and optimization of systems*, Antibes, F. (in French).

Darkhovskii, B.S. (1985). On two estimation problems for times of change of the probabilistic characteristics of a random sequence. *Theory of Proba. and its Appl.*, 29, 478-487.

Detecting changes in signals and systems -A survey-

Deckert, J.C., M.N. Desai, J.J. Deyst, A.S. Willsky (1977) F-8 DFBW sensor failure identification using analytic redundancy. *IEEE Trans. on Aut. Cont.*, 22, 795-803.

Desai, M., A. Ray (1984). A fault detection and isolation methodology -Theory and application. *Proc. Am. Cont. Conf.*, San Diego, 262-270.

Deshayes, J., D. Picard (1986). Off-line statistical analysis of change-point models using non parametric and likelihood methods, in Basseville and Benveniste (Ed.), ch.5, 103-168.

Favier, G., A. Smolders (1984). Adaptive smoother-predictors for tracking maneuvering targets. *Proc. 23<sup>rd</sup> Conf. on Dec. and Contr.*, Las Vegas, NV, 831-836.

Gray, A.H., J.D. Markel (1976). Distance measures for Speech processing. *IEEE Trans. on A.S.S.P.*, 24, 380-391.

Gustavson, D.E., A.S. Willsky, J.Y. Wang, M.C. Lancaster, J.H. Triebwasser (1978a). ECG/VCG rhythm diagnosis using statistical signal analysis. Part I: Identification of persistent rhythms. *IEEE Trans. on Biomed. Eng.*, 25, 344-353.

Gustavson, D.E., A.S. Willsky, J.Y. Wang, M.C. Lancaster, J.H. Triebwasser (1978b). ECG/VCG rhythm diagnosis using statistical signal analysis. Part II: Identification of transient rhythms. *IEEE Trans. on Biomed. Eng.*, 25, 353-361.

Himmelblau, D.M. (1978). *Fault detection and diagnosis in chemical and petrochemical systems*, Elsevier, Amsterdam.

Hinkley, D.V. (1971). Inference about the change-point from cumulative sum tests. *Biometrika*, 58, 509-523.

Isermann, R. (1984). Process fault detection based on modeling and estimation methods -A survey. *Automatica*, 20, 387-404.

Ishii, N., H. Sugimoto, A. Iwata, N. Suzumura (1980). Computer classification of the EEG time-series by Kullback information measure. *Int. J<sup>l</sup> of Syst. Sc.*, 11, 677-688.

Kailath, T. (1980). *Linear systems*, Prentice Hall, Englewood Cliffs.

Kassam, S.A. (1980). A bibliography on non-parametric detection. *IEEE Trans. on Inf. Th.*, 26, 595-602.

Kedem, B., E. Slud (1982). Time series discrimination by higher order crossings. *Ann. of Statistics*, 10, 786-794.

Kerr, T.H. (1985). Decentralized filtering and redundancy management/failure detection for multisensor integrated navigation

Detecting changes in signals and systems -A survey-

systems. *Proc. Inst. of Navig. Conf.*, San Diego, CA.

Kligene, N.I., L.A. Tel'ksnis (1983). Methods of detecting instants of change of random process properties. *Automation and Remote Cont.*, 44, 1241-1283.

Lehmann, E.L. (1959). *Testing statistical hypotheses*. Wiley. New-York.

Lorden, G. (1971). Procedures for reacting to a change in distribution. *Ann. of Math. Stat.*, 42, 1897-1908.

Madiwale, A., B. Friedland (1983). Comparison of innovations-based analytical redundancy methods. *Proc. Am. Contr. Conf.*, San Francisco, CA, 940-945.

Mehra, R.K., J. Peschon (1971). An innovations approach to fault detection and diagnosis in dynamic systems. *Automatica*, 7, 637-640.

Mironovski, L.A. (1979). Functional diagnosis of linear dynamic systems. *Automation and Remote Cont.*, 40, 1122-1143.

Mironovski, L.A. (1980). Functional diagnosis of dynamic systems -A survey. *Automation and Remote Cont.*, 41, 1122-1143.

Mottl', V.V., I.B. Muchnik, V.G. Yakovlev (1983). Optimal segmentation of experimental curves. *Automation and Remote Cont.*, 44, 1035-1044.

Moustakides, G.M. (1986a). Optimal procedures for detecting changes in distributions. *Ann. of Statistics*, 14.

Moustakides, G.M., A. Benveniste (1986b). Detecting changes in the AR parameters of a nonstationary ARMA process. *Stochastics*, 16, 137-155.

Moustakides, G. (1986c). The problem of diagnosis with respect to physical parameters for changes in structures. *Research Report IRISA n°295*.

Nikiforov, I.V. (1983). *Sequential detection of abrupt changes in time series properties*. Nauka, Moscow (in Russian).

Nikiforov, I.V. (1986a). Sequential detection of changes in stochastic systems. in Basseville and Benveniste (Ed.), ch.7, 216-258.

Nikiforov, I.V., I.N. Tikhonov (1986b). Application of change detection theory to seismic signal processing. in Basseville and Benveniste (Ed.), ch.12, 355-373.

Page, E.S. (1954). Continuous inspection schemes. *Biometrika*, 41, 100-115.

Pattipati, K.R., N.R. Sandell Jr. (1983). A unified view of state estimation in switching environments. *Proc. Am. Contr. Conf.*, San Francisco, CA, 458-465.

Detecting changes in signals and systems -A survey-

Pattipati, K.R., A.S. Willsky, J.C. Deckert, J.S. Eterno, J.S. Weiss (1984). A design methodology for robust failure detection and isolation. *Proc. Am. Cont. Conf.*, San Diego, CA, 1755-1762.

Pau, L.F. (1981). *Failure diagnosis and performance monitoring*, Marcel Dekker, Inc., New-York.

Perriot-Mathonna, D. (1984). Recursive stochastic estimation of parameters subject to random jumps. *IEEE Trans. on Aut. Cont.*, 29, 962-969.

Peterka, V. (1981). Bayesian approach to system identification. in *Trends and Progress in System Identification*, ed. P. Eykhoff, Pergamon Press.

Prevosto, M., B. Barnouin, C. Hoen (1983). Frequency versus time domain identification of complex structures modal shapes under natural excitation. *Proc. 11<sup>th</sup> IFIP Conf. on System Modelling and Optimization*, Copenhagen, Denmark.

Ray, A., M. Desai (1983). Calibration and estimation in multiple redundant measurement systems. *Proc. Am. Cont. Conf.*, San Francisco, CA, 1212-1218.

Rougée, A., M. Basseville, A. Benveniste, G. Moustakides (1985). Optimum robust detection of changes in the AR part of a multivariable ARMA process. *Research Report IRISA n°277/INRIA n°478*.

Roussas, G.G. (1972). *Contiguity of probability measures; some applications in Statistics*, Cambridge Univ. Press.

Sanderson, A.C., J. Segen (1980). Hierarchical modeling of EEG signals. *IEEE Trans. on P.A.M.I.*, 2, 405-414.

Segen, J., A.C. Sanderson (1980). Detecting changes in a time-series. *IEEE Trans. on Inf. Th.*, 26, 249-255.

Shaban, S.A. (1980). Change-point problem and two-phase regression: an annotated bibliography. *Int. Stat. Review*, 48, 83-93.

Shiryayev, A.N. (1963). On optimum methods in quickest detection problems. *Theory Prob. Appl.*, 8, 22-46.

Shiryayev, A.N. (1978). *Optimal stopping rules*, Springer Verlag, New-York.

Tugnait, J.K. (1982a). Detection and estimation for abruptly changing systems. *Automatica*, 18, 607-615.

Tugnait, J.K. (1982b). Adaptive estimation and identification for discrete systems with Markov jump parameters. *IEEE Trans. on Aut.*

**Detecting changes in signals and systems -A survey-**

*Cont.*, 27, 1054-1064.

Usoro, P.B., I.C. Schick, S. Negahdaripour (1985). An innovation-based methodology for HVAC system fault detection. *Trans. of ASME*, 107, 284-289.

Willsky, A.S., J.J. Deyst, B.S. Crawford (1975). Two self-test methods applied to an inertial system problem. *J. Spacecr-Rockets*, 12, 434-437.

Willsky, A.S. (1976a). A survey of design methods for failure detection in dynamic systems. *Automatica*, 12, 601-611.

Willsky, A.S., H.L. Jones (1976b). A generalized likelihood ratio approach to the detection and estimation of jumps in linear systems. *IEEE Trans. on Aut. Cont.*, 21, 108-112.

Willsky, A.S., E.Y. Chow, S.B. Gershwin, C.S. Greene, P.K. Houpt, A.L. Kurkjan (1980). Dynamic model-based techniques for the detection of incidents on freeways. *IEEE Trans. on Aut. Cont.*, 25, 347-360.

Yashchin, E. (1985). On a unified approach to the analysis of two-sided cumulative sum control schemes with headstarts. *Adv. Appl. Prob.*, 17, 562-593.



**FIGURE CAPTION**

- Figure 1 : Segmentation of continuous speech signal
- Figure 2 : Scheme for the Page-Hinkley stopping rule
- Figure 3 : Scheme for the GLR test
- Figure 4 : Using two models, one "global" and one local
- Figure 5 : Comparing the two algorithms (22) - (a) - and (24) - (b) - on continuous speech signal
- Figure 6 : Using two local models
- Figure 7 : Diagram for residuals generation
- Figure 8 : Diagram for residuals generation with analytical redundancy

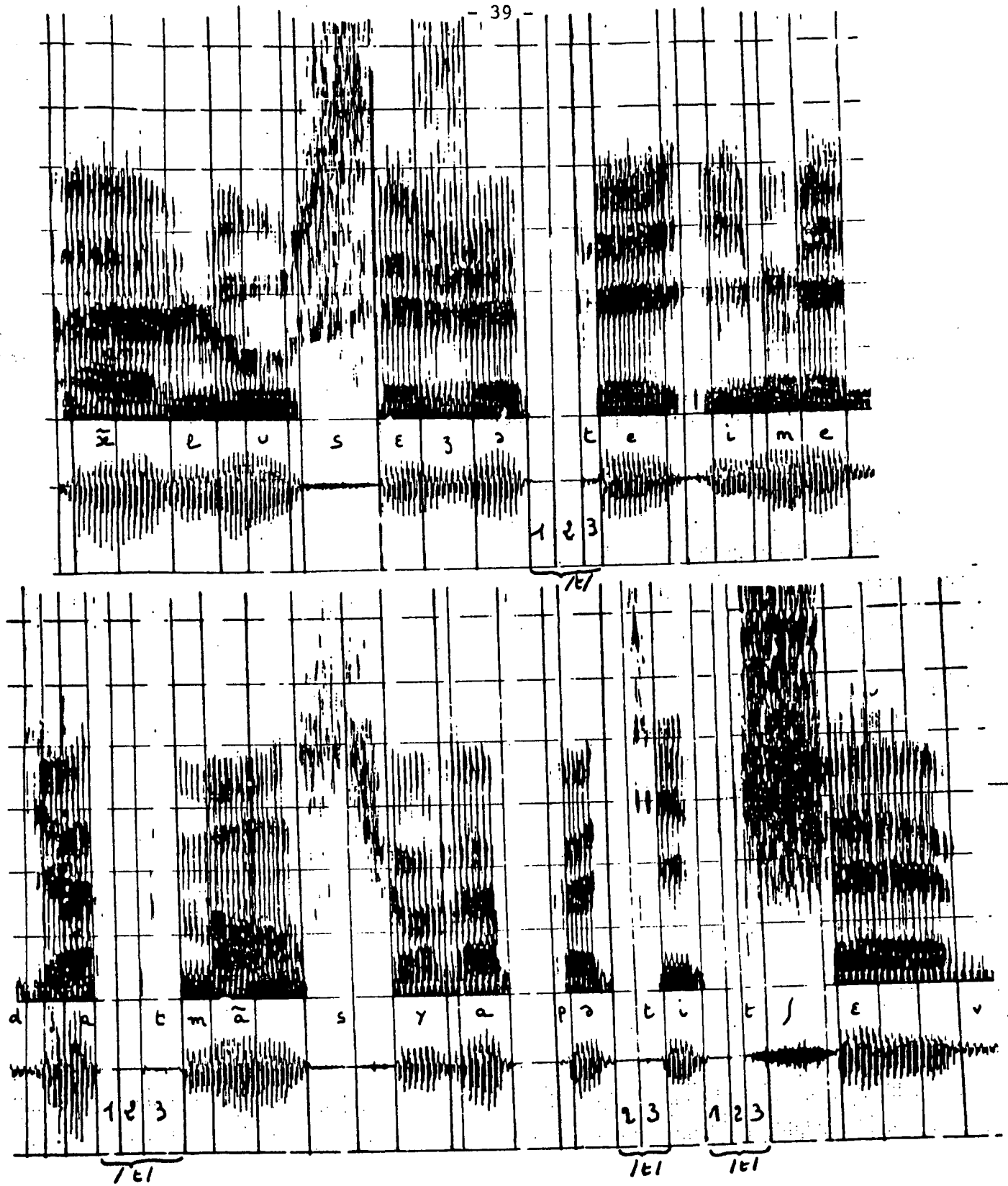

Figure n°1 : Segmentation of continuous speech signal .  
The vertical lines indicate the detected jumps.

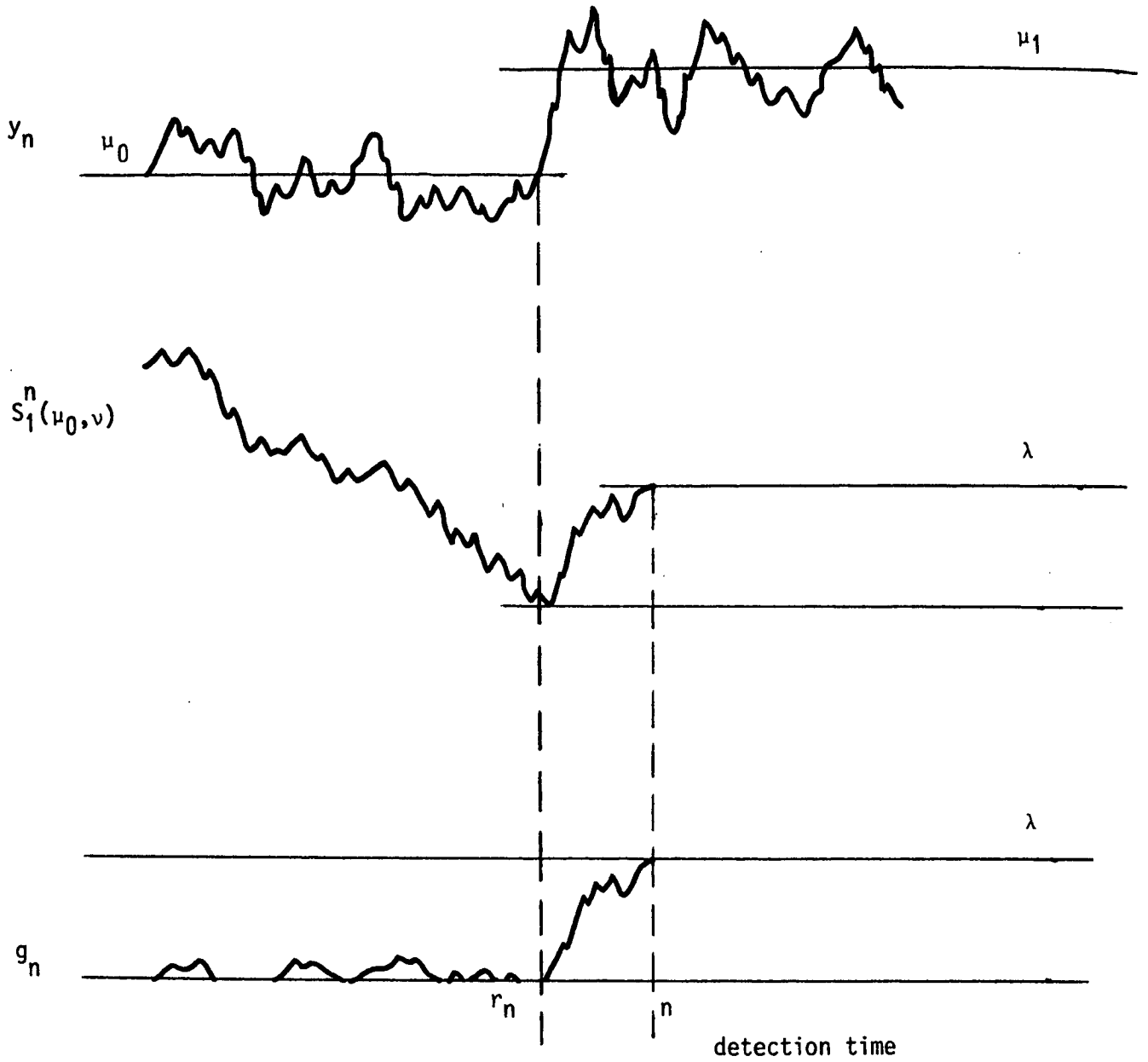

Figure n° 2 : Scheme for the Page-Hinkley stopping-rule.

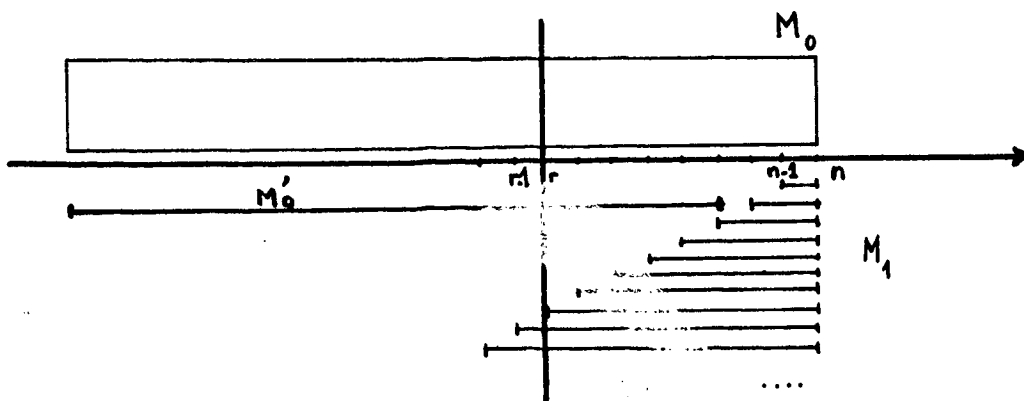

Figure n° 3 : Scheme for the GLR test.

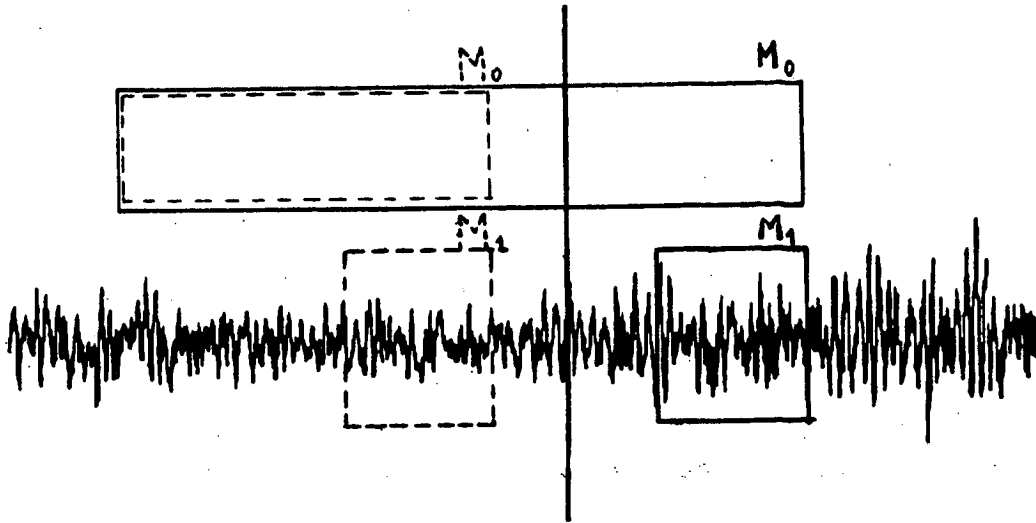
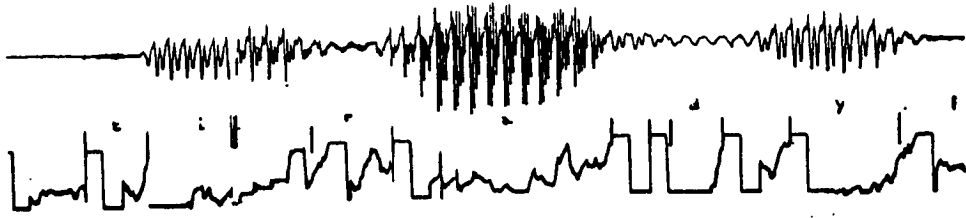
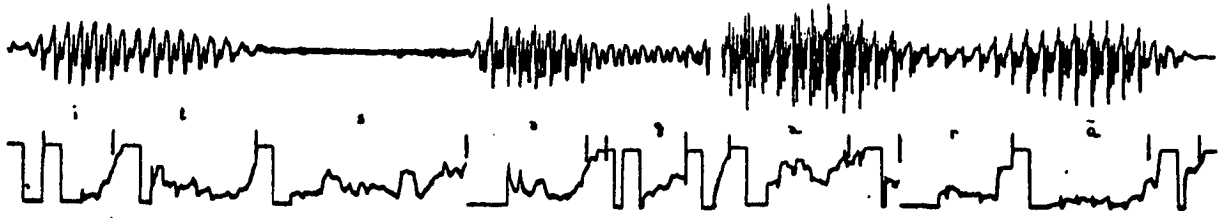

Figure n° 4 : Using two models, one "global" and one local.



Figure n° 6 : Using two local models.



(a)

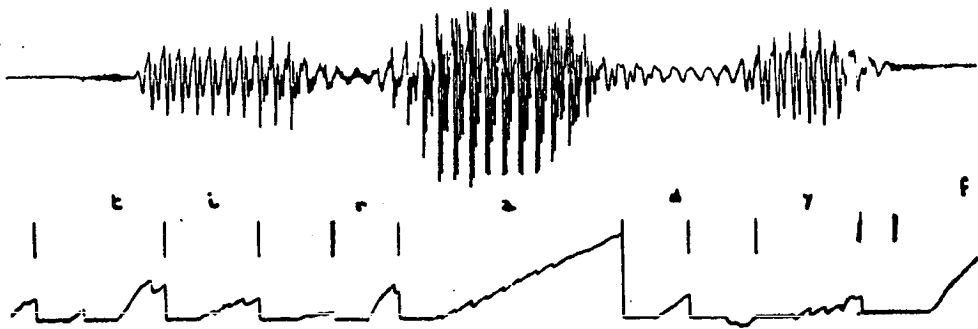
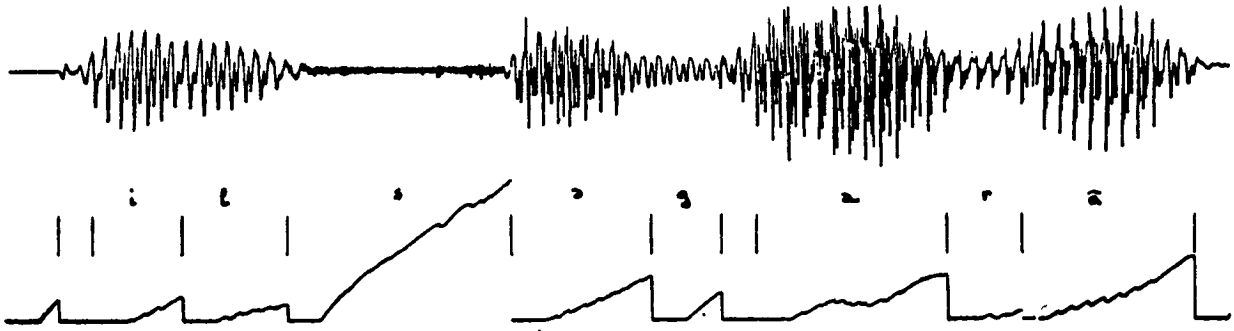

(b)

Figure n°5 : Comparing the two algorithms (22) -(a)- and (24) -(b)- .

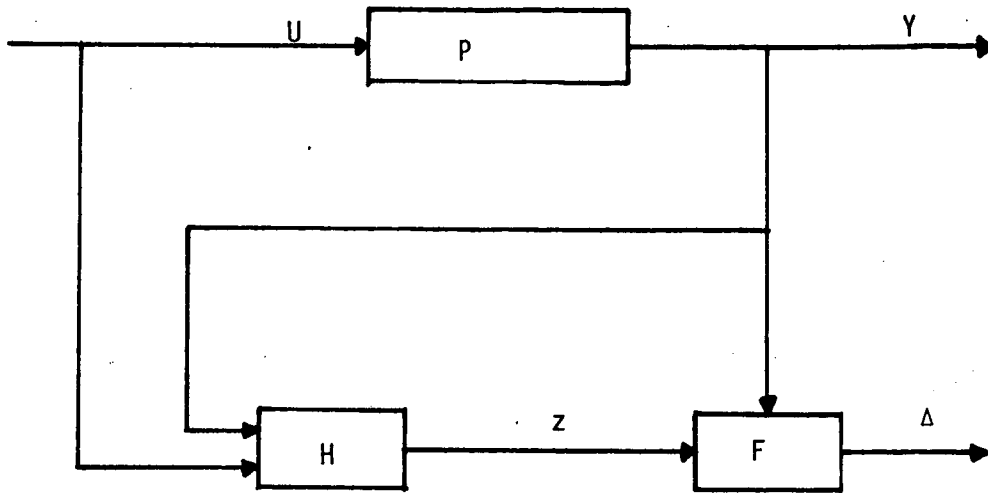

Figure n°7 : Diagram for residuals generation.

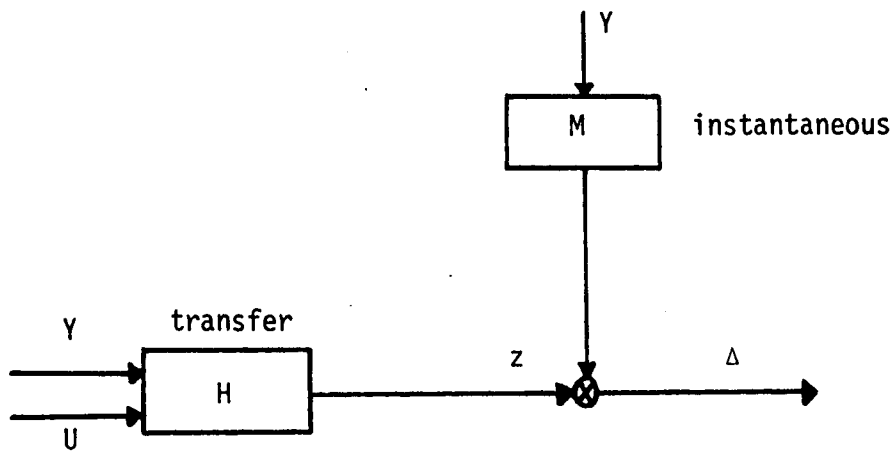

Figure n°8 : Diagram for residual generation with analytical redundancy.

