



HAL
open science

Improving basic narrowing techniques and commutation properties

Pierre Rety

► **To cite this version:**

Pierre Rety. Improving basic narrowing techniques and commutation properties. [Research Report] RR-0681, INRIA. 1987. inria-00075872

HAL Id: inria-00075872

<https://inria.hal.science/inria-00075872>

Submitted on 24 May 2006

HAL is a multi-disciplinary open access archive for the deposit and dissemination of scientific research documents, whether they are published or not. The documents may come from teaching and research institutions in France or abroad, or from public or private research centers.

L'archive ouverte pluridisciplinaire **HAL**, est destinée au dépôt et à la diffusion de documents scientifiques de niveau recherche, publiés ou non, émanant des établissements d'enseignement et de recherche français ou étrangers, des laboratoires publics ou privés.

INRIA

UNITE DE RECHERCHE
INRIA-LORRAINE

Institut National
de Recherche
en Informatique
et en Automatique

Domaine de Voluceau
Rocquencourt
B.P. 105
78153 Le Chesnay Cedex
France
Tel (1) 39 63 55 11

Rapports de Recherche

N° 681

IMPROVING BASIC NARROWING TECHNIQUES AND COMMUTATION PROPERTIES

Pierre RETY

JUIN 1987

**IMPROVING BASIC NARROWING TECHNIQUES
AND COMMUTATION PROPERTIES**

**AMELIORATION DE LA SURREDUCTION BASIQUE
ET PROPRIETES DE COMMUTATION**

PAR

PIERRE RETY



Résumé : Dans ce papier, nous proposons une méthode nouvelle et complète basée sur la surréduction pour résoudre des équations dans les théories équationnelles. Cette méthode est complète car elle donne toutes les solutions. C'est une combinaison de la surréduction basique et de la surréduction normalisée, qui n'est pas triviale car leur combinaison naïve n'est pas une méthode complète. Nous montrons qu'elle est plus efficace que les méthodes existantes dans un certain nombre de cas, et pour cela nous avons établi des résultats de commutation sur la surréduction. Notre méthode fournit un algorithme qui a été implanté comme une extension du logiciel REVE.

Abstract : In this paper, we propose a new and complete method based on narrowing for solving equations in equational theories. This method is complete in the sense that it gives all the solutions. It is a combination of basic narrowing, which is not obvious, because their naïve combination is not a complete method. We show that it is more efficient than the existing methods in many cases, and for that establish commutation properties on the narrowing. It provides an algorithm that has been implemented as an extension of the software REVE.

Improving basic narrowing techniques and commutation properties¹

Pierre Réty

Centre de Recherche en Informatique de Nancy
BP 239
54506 Vandoeuvre Les Nancy Cedex
France
E-mail: mcvax!inria!crin!rety

Abstract

In this paper, we propose a new and complete method based on narrowing for solving equations in equational theories. This method is complete in the sense that it gives all the solutions. It is a combination of basic narrowing and lazy narrowing, which is not obvious, because their naive combination is not a complete method. We show that it is more efficient than the existing methods in many cases, and for that establish commutation properties on the narrowing. It provides an algorithm that has been implemented as an extension of the software REVE.

Warning: The various narrowing relations used in this paper are summarized in the appendix.

1 Introduction

The narrowing is a general method to solve equations in equational theories, that was introduced by Slagle[20], and studied by Fay[1, 2] and Hullot[10, 9]. It needs a convergent set of rewrite rules equivalent to the considered equational theory, and returns a complete set of solutions (called unifiers), i.e. a basis of the set of all the solutions. But this method has drawbacks: it is inefficient and often does not terminate. Implementations are described in [19, 11]. The narrowing has some similarities with the linear resolution principle of the Prolog language, and is used in the logic programming language Eqlog[3] and by Smolka[21].

Let us describe what the narrowing is. Assume that we have a convergent set of rewrite rules. The narrowing of a term t consists of two passes. First one instantiates t so that it becomes reducible by a rule. Second one reduces it by this rule. The resulting term t_1 may be reducible into t_2 without any further instantiation. If so, t_2 is reduced, one redoes this transformation until one gets a irreducible term (called in normal form) t_n . The relation that transforms t into t_1 was called narrowing[9], and the transformation of t into t_n was called lazy narrowing[11]. If one considers all the narrowing derivations issued from t (the

¹ This research was supported by the GRECO of programmation.

narrowing tree), the intermediate terms t_1, t_2 are nodes from which edges are issued, while they do not appear in the tree using lazy narrowing. So, the narrowing tree contains the lazy narrowing tree.

In order to compute solutions of an equation $t = t'$ modulo a term rewriting system, one computes the narrowing derivations (lazy or not) issued from $t = t'$, $=$ being considered as a binary function symbol, and check at each node whether the corresponding equation has a syntactic solution. If the term rewriting system is confluent and noetherian, all the solutions are found by building the whole narrowing tree (which can be infinite).

In order to have a smaller tree, it is obviously better to use the lazy narrowing relation. Another idea[9] consists of using only narrowing at some occurrences called basic. This method is called basic narrowing, and gives another tree included into the narrowing tree.

Our idea is to mix the two previous relations, in order to further reduce the tree. The simplest way (we will say naive) is to consider their intersection. Unfortunately, the set of solutions that it provides is not always complete. Therefore, we had to build another relation in a non trivial way that preserves the completeness of the solution set. It uses at normalization time a new computation of the basic occurrences based on the residual notion[7], that we will call weakly basic.

This method gives a tree smaller than the one obtained with the lazy narrowing, and smaller than the one obtained with the basic narrowing if the term rewriting system is right-linear. It can be implemented and gives a unification method that is more efficient than the previous ones.

In section 2, we introduce the basic concepts and definitions, and recall the existing results. In section 3, we consider the naive combination of lazy and basic narrowings, and using an example, show that this method does not provide all the solutions. Therefore, we propose in section 4 a new combination that provides all the solutions. We compare it with the existing methods, in section 5 and for that, we establish commutation results about the narrowing relation. Details of implementation are described in section 6.

2 Definitions and existing results

In this section we introduce the concept of narrowing and recall that it provides a complete method for solving equation in a theory described by a confluent and noetherian term rewriting system. The following notations and properties are valid for the whole paper. They are consistent with [8, 12].

Let F be a set of symbols, X be a set of variables. A **term** is a partial application from N_+^* (The free monoid on N_+ whose elements are called **occurrences**) into FUX that respects the symbol arities and $T(F, X)$ is the set of terms on F and X . For each $t \in T(F, X)$, $D(t)$ is the set occurrences of t , $O(t)$ is the set of non variable occurrences and $V(t)$ is the set of variables that occurs in t . t is said **linear** if each variable of t occurs once in t .

An **equation** $s = t$ is a pair of terms, a **rewrite rule** $s \rightarrow t$ is a directed pair of terms. $t[u \leftarrow t']$ is the term obtained from t by changing the subterm of t at the occurrence u by t' . An **equational theory** A is a set of equations and one writes $=_A$ the smallest congruence induced by A . A **term rewriting system** R is a set of rewrite rules and \rightarrow is the rewriting relation derived from R and \rightarrow^* its transitive closure. A sequence of

rewriting steps is called a **derivation**. A term t is said **normalized** if it is not reducible by \rightarrow , and the term t' is a normal form of t if $t \rightarrow^* t'$ and t' is normalized, t' is denoted by $t \downarrow$. R is **confluent** if for any term t , $t \rightarrow^* t_1$ and $t \rightarrow^* t_2$ implies there exists a term t' such that $t_1 \rightarrow^* t'$ and $t_2 \rightarrow^* t'$. R is **noetherian** if the relation \rightarrow is noetherian. R is **interreduced** if for any rule $g \rightarrow d$ in R , d is normalized, and g is normalized with respect to $R - \{g \rightarrow d\}$. One says that R is **convergent** if it is confluent and noetherian, and **canonical** if it is also interreduced. R is **regular** if for all rule $g \rightarrow d$ in R , $V(d) = V(g)$. $=_R$ is the relation defined by $=_R = (\rightarrow^* \cup \leftarrow^*)$ where \leftarrow is the rewriting relation obtained by reversing the rules of R .

Substitutions σ are defined as endomorphisms on $T(F, X)$ that extend mappings from X to $T(F, X)$ with a finite domain $D(\sigma)$. A substitution σ is denoted by $\{(x_1 / t_1), \dots, (x_n / t_n)\}$.

We write \leq the subsumption quasi-ordering on $T(F, X)$ defined by: $t \leq t'$ iff $t' = \sigma(t)$ for a substitution σ (called a match from t to t'). Composition of substitutions σ and ρ is denoted by $\sigma \cdot \rho$.

Given an equational theory A , two terms t and t' are said to be A -**unifiable** [16, 6] iff there exists a substitution σ such that $\sigma(t) =_A \sigma(t')$. σ is also called an A -**solution** of the equation $t = t'$. Given a subset V of X , we define $\sigma \prec_A \sigma'[V]$ iff $\sigma' =_A \sigma \circ \sigma''$, $\sigma''[V]$ for some substitution σ'' (the notation $[V]$ means that the formula is valid for any variable in V). If $V = X$, V is omitted. Γ is a **complete set of A -unifiers** of t and t' away from W containing the set V of the variables of t and t' iff:

- for all $\sigma \in \Gamma$, $D(\sigma) \subseteq V$ and $I(\sigma) \cap W = \emptyset$ (The goal of this technical restriction is only to avoid conflict between variables)
- for all $\sigma \in \Gamma$, $\sigma(t) =_A \sigma(t')$
- for all unifiers σ' , there exists $\sigma \in \Gamma$ such that $\sigma \prec_A \sigma'[V]$.
In addition Γ is said to be **minimal** if it satisfies the further condition: for all σ and $\sigma' \in \Gamma$, $\sigma \prec_A \sigma'$ implies $\sigma = \sigma'$.

An A -unification algorithm is **complete** if it generates a complete set of A -unifiers. Note that this set may be infinite.

We now give a very general definition of the narrowing by introducing any fixed mapping \rightarrow such that $\rightarrow \subseteq \rightarrow^*$. One will say that a given derivation $s \rightarrow^* s'$ is **compatible** with \rightarrow iff $s \rightarrow s'$.

Definition: We say that t is **narrowable** to t' at the occurrence u , using the rule $g \rightarrow d$ and with the substitution σ iff

- $t|_u$ and g are unifiable by the most general unifier σ
- $t_1 = \sigma(t) [u \leftarrow \sigma(d)]$
- $t_1 \rightarrow t'$

We call this relation **narrowing** and note $t \rightarrow_{[u, g \rightarrow d, \sigma]} t'$. A sequence of narrowing steps is called a **narrowing derivation**.

This definition is generic because by choosing the mapping \rightarrow one obtains different narrowing relations, in particular the two followings:

- If \rightarrow is the identity then $t_1 = t'$. We have the relation called narrowing by Hullot[9], and that we will call **simply narrowing** or **S-narrowing** and we write $t \rightarrow_{[u, g \rightarrow d, \sigma]} t'$. A sequence of S-narrowing steps is called a **S-narrowing derivation**.
- If \rightarrow is the normalization mapping then t' is in normal form. We have the relation called narrowing by Fay[1], and recently lazy narrowing. We do not like this name because the rewriting steps are particular steps of narrowing, and then this narrowing relation is not so lazy. We propose to call it **normal narrowing** or **N-narrowing** and we denote it by $t \rightsquigarrow_{[u, g \rightarrow d, \sigma]} t'$. A sequence of N-narrowing steps is called a **N-narrowing derivation**.

With these notations we have:

$$\begin{aligned} [t \rightsquigarrow_{[u, g \rightarrow d, \sigma]} t'] &\Leftrightarrow [t \rightarrow_{[u, g \rightarrow d, \sigma]} t_1 \text{ and } t' = t_1 \downarrow] \\ &\quad \rightarrow \subseteq \rightsquigarrow \\ &\quad \rightarrow \subseteq \rightsquigarrow \end{aligned}$$

If σ is a match from g to t/u , the step $t \rightarrow t_1$ is in fact a step of rewriting.

In the following we suppose that any mapping \rightarrow is fixed, then a narrowing relation \rightarrow is fixed.

The narrowing relation provides a method to compute a complete set of unifiers of two terms modulo a convergent term rewriting system. The method consists in building all the possible narrowing derivations issued from $t_0 = t'_0$ and to collect the corresponding narrowing substitutions, until we obtain equations $t_n = t'_n$ such that t_n and t'_n are unifiable. The unification problem in the equational theory is then reduced to the narrowing together with the standard unification of terms.

In order to iterate the narrowing process on the two terms in parallel, $=$ is considered as a new operator of the equational theory, and the process starts with the term $t_0 = t'_0$. It is obvious that if $t_0 = t'_0 \rightarrow^* t$ then t is of the form $t_i = t'_i$.

The following result has been proved by Hullot[10] for the S-narrowing, by C. and H. Kirchner[13, 14] and Réty(et al)[18] for any narrowing relation.

Theorem: Let R be a convergent term rewriting system, t_0 and t'_0 be two terms. The set of substitutions σ such that

- there exists a narrowing derivation issued from $t_0 = t'_0$
 $t_0 = t'_0 \rightarrow_{[\sigma_1]} t_1 = t'_1 \rightarrow \dots \rightarrow_{[\sigma_n]} t_n = t'_n$ such that t_n and t'_n are unifiable by the most general unifier β and that $\beta \cdot \sigma_n \dots \sigma_1$ is normalized on $V(t_0 = t'_0)$
- $\sigma = \beta \cdot \sigma_n \dots \sigma_1$

is a complete set of R -unifiers of t_0 and t'_0 .

Basic S-narrowing was defined and studied by Hullot[10]. It consists of forbidding a reduction at an occurrence brought by the substitution in a previous step.

Definition[Hullot]: Given the derivation

$$t_0 \rightarrow_{[u_0, g_0 \rightarrow d_0, \sigma_0]} t_1 \rightarrow \dots \rightarrow_{[u_{n-1}, g_{n-1} \rightarrow d_{n-1}, \sigma_{n-1}]} t_n \quad (1)$$

and U_0, \dots, U_n sets of non variable occurrences of t_0, \dots, t_n respectively. One says that the derivation is based on U_0 iff for all i

$$u_i \in U_i$$

$$U_{i+1} = [U_i - \{v \in U_i / u_i \leq v\}] \cup \{u_i \cdot v / v \in O(d_i)\}$$

We write $U_{i+1} = B(U_i)$, $U_{i+1} = B(t_{i+1}, (1))$ or more simply $U_{i+1} = B(t_{i+1})$ if it is not ambiguous. One will say U_{i+1} is the base of t_{i+1} . The occurrences that belong to U_0, \dots, U_n are said basic.

If it is not ambiguous we will say more simply this derivation is **basic**, or this is a **basic derivation**. In the same way, we define the **basic S-narrowing derivations**.

Remark: B is increasing i.e. $U \subseteq U'$ implies $B(U) \subseteq B(U')$, and preserves the closure by prefix i.e. U is closed by prefix implies $B(U)$ is closed by prefix.

The basic method consists in building all the S-narrowing derivations issued from $t_0 = t'_0$ and based on $O(t_0 = t'_0)$.

Theorem[Hullot]: The previous theorem is still valid when we restrict to S-narrowing derivations based on $U_0 = O(t_0 = t'_0)$.

One of the interests of the basic S-narrowing is its termination property.

Termination property[Hullot]: If all the basic S-narrowing derivations issued from a right hand side of a rewrite rule terminate, then all basic S-narrowing derivation issued from any term terminates.

3 The naive basic narrowing

Actually, the "basic" concept is only used for the S-narrowing, and we search to extend it to all the narrowing relations (including the N-narrowing). Let us recall that a narrowing step is formed by a step of S-narrowing followed by steps of rewriting. The first idea that comes to mind is to define the basic occurrence sets along the rewriting steps as Hullot did, i.e. by using the mapping B . But this method miss some solutions.

Example 1: Consider the canonical term rewriting system R .

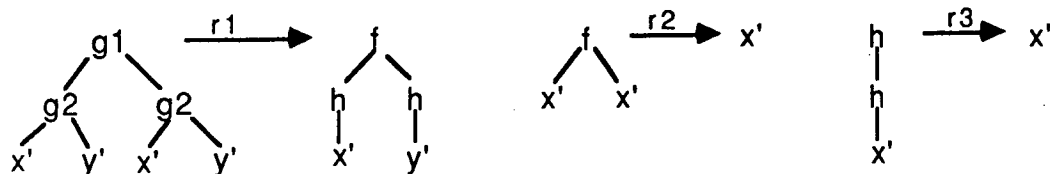

Let $t = g_1(g_2(y, y), z)$ and suppose one wants to solve modulo R the equation $t = 0$. The "%" symbol means that the corresponding occurrence is not basic. The tree of basic S-narrowing is formed by the branches (1) and (2):

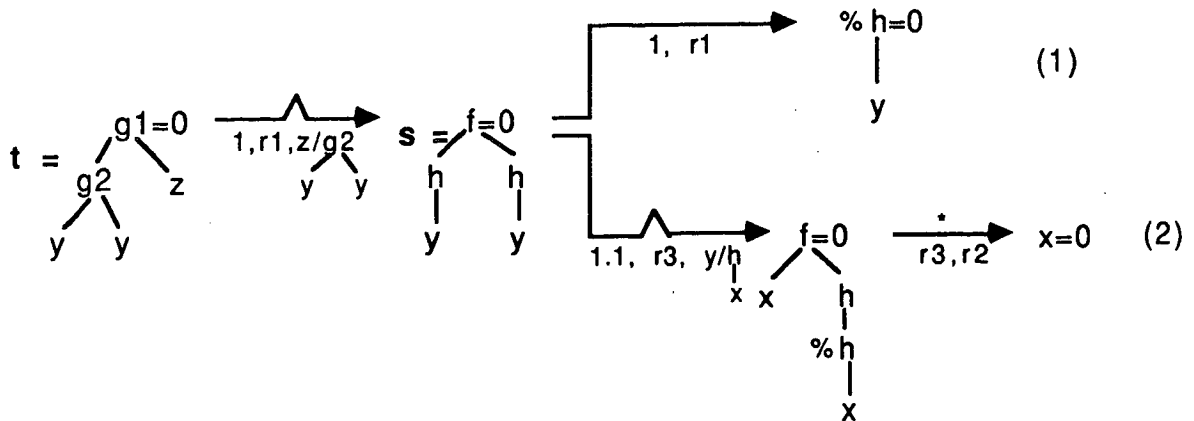

The branch (2) gives the substitution $\sigma = (y/h(0), z/g_2(h(0), h(0)))$ which is the unique solution.

The leaf of the branch (1) can not be narrowed at a basic occurrence, and since $h(y)$ and 0 are not unifiable this branch does not give a solution.

If one uses the naive basic N-narrowing, the term s disappears from the tree, and with it the branch (2). Therefore the solution will not be found by this method.

Nevertheless in order to find σ , our idea is to compute on a larger set of basic occurrences during the rewriting steps. This computing will be said weakly basic. Thus the term $h(y) = 0$ can be narrowed into $x = 0$ by the rule r_3 using the substitution $(y/h(x))$ which gives the solution σ .

Another difficulty is in the fact that the rewriting steps do not with respect to the basic occurrences. Using the N-narrowing, that means the term obtained by the S-narrowing step cannot be normalized by a basic rewriting as one can see in the following example:

Example 2: Let R be the canonical term rewriting system that contains the associativity rule: $R = \{f(x, f(y, z)) \rightarrow f(f(x, y), z)\}$ and we want to reduce by basic N-narrowing the term $f(f(y', x'), x')$. One possibility is:

$$f(f(y', x'), x') \xrightarrow{\{ \varepsilon, \sigma \}} t = f(f(\%f(y', f(y, z)), y), z)$$

$$\text{with } \sigma = (x'/f(y, z), x/f(y', f(y, z)))$$

The occurrence pointed out by $\%$ is the unique occurrence of t on which the rule can be applied. Since this occurrence is not basic it is not possible to normalize t by a basic derivation.

In the following, we will define a property on basic occurrence sets that will guarantee that basic normalization is possible.

4 The basic narrowing

4.1 Formal concepts

The aim of the following definition is to characterize the sets of basic occurrences that allow to find a solution. We will say that a set of occurrences U is sufficiently large on a term t if all the subterms that correspond to the non U -occurrences are normalized.

Definition: Let t be a term, U a set of occurrences of t , we say that U is **sufficiently large** on t iff:

$$u \in D(t) \text{ and } u \notin U \Rightarrow t/u \text{ is in normal form.}$$

Lemma 1: Let t_0 be a term, U_0 a set of occurrences of t_0 sufficiently large on t_0 . Then all the derivations issuing from t_0 and following a bottom-up strategy $t_0 \rightarrow t_1 \rightarrow \dots \rightarrow t_n$ are based on U_0 . If we denote by U_0, \dots, U_n the sets of basic occurrences then for all i , U_i is sufficiently large on t_i .

Proof: By induction on the size of the derivation.

If $n = 0$ the lemma obviously holds. If the property is true for i , U_i is sufficiently large on t_i , then the step $t_i \xrightarrow{[u, g \rightarrow d, \sigma]} t_{i+1}$ satisfies $u_i \in U_i$. Since the strategy is bottom-up, the match σ_i is normalized, and the non basic occurrences of t_{i+1} are normalized.

Corollary 1: If U_0 is sufficiently large on t_0 , there exists a derivation based on U_0 , leading to the normal form of t_0 and such that for any term t_i in this derivation, the set U_i of the basic occurrences of t_i is sufficiently large on t_i .

But, there exists basic derivations that do not preserve the sufficient largeness property of the occurrence sets. For instance, consider the rewriting system of the example 1, the term $t = f(h(h(x)), h(h(x)))$, and the occurrence set $U = \{\varepsilon, 1, 11, 2, 21\}$. U is sufficiently large on t , $t \xrightarrow{[\varepsilon, r_2]} t' = h(h(x))$ and $B(t') = \emptyset$. Since t' is not normalized, $B(t')$ is not sufficiently large on t' .

We must define a new notion of basic derivation, that always preserves the sufficient largeness property. For that, we introduce the antecedent notion that is (nearly) the dual of the residual notion of Huet and Levy[7]. It characterizes the fact that along a rewriting step, a subterm can be preserved.

Definition: Let $t \xrightarrow{[u, g \rightarrow d, \sigma]} t'$ be a step of rewriting and $v' \in D(t')$. We say that the occurrence v of t is an **antecedent** of v' iff

v' is not comparable to u and $v = v'$

or

there exists an occurrence p' of a variable x in d such that

$$v' = u \cdot p' \cdot w$$

$$v = u \cdot p \cdot w \text{ where } p \text{ is an occurrence of } x \text{ in } g.$$

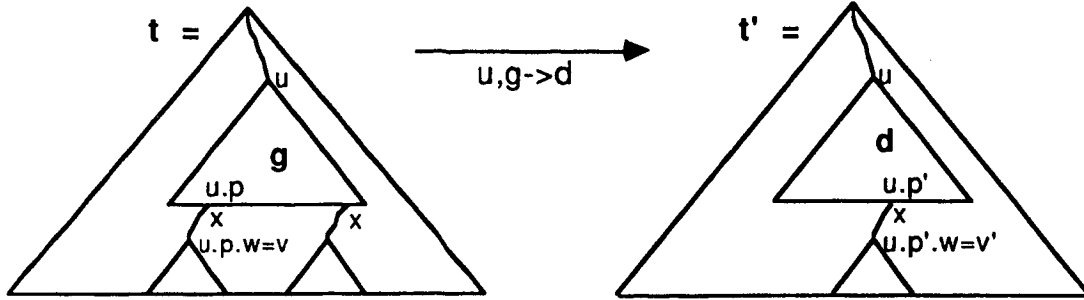

We extend this definition to a derivation by transitive closure of the rewriting relation. We say that v' is a **residual** of v iff v is an antecedent of v' .

Remarks: With the notations of the previous definition we have:

- $t'/v' = t/v$
- v' may have no antecedent if $v' = u.p'$ with $p' \in O(d)$ or if $v' < u$,
- v' may have several antecedents if g is not linear.

Definition: Given the derivation

$$t_0 \rightarrow [u_0, g_0 \rightarrow d_0] t_1 \rightarrow \dots \rightarrow [u_{n-1}, g_{n-1} \rightarrow d_{n-1}] t_n$$

and U_0, \dots, U_n sets of non variable occurrences of t_0, \dots, t_n respectively. We say that this derivation is **weakly based** on U_0 iff for all i

- $u_i \in U_i$
- $U_{i+1} = \left[U_i - \{v \in U_i / u_i \leq v\} \right] \cup \{u_i.v / v \in O(d_i)\} \cup \{v \in O(t_{i+1}) / v = u_i.w, w \notin O(d_i) \text{ and all antecedents of } v \text{ in } t_i \text{ are in } U_i\}$

We write $U_{i+1} \stackrel{\text{def}}{=} \text{WB}(U_i)$, $U_{i+1} = \text{WB}(t_{i+1}, (1))$ or more simply $U_{i+1} = \text{WB}(t_{i+1})$ if it is not ambiguous. One will say U_{i+1} is the base of t_{i+1} . The occurrences that belong to U_0, \dots, U_n are said **basic**. If it is not ambiguous we will say more simply this derivation is **weakly basic**, or this is a **weakly basic derivation**.

Remark: WB is increasing i.e. $U \subseteq U'$ implies $\text{WB}(U) \subseteq \text{WB}(U')$, and preserves the closure by prefix i.e. U is closed by prefix implies $\text{WB}(U)$ is closed by prefix.

This definition differs from Hullot's one by addition of the last line, i.e. the occurrences under d_i may belong to U_{i+1} . Therefore $B(U_i) \subseteq \text{WB}(U_i)$.

In practice the set U_0 is supposed to be closed by prefix, and since the weakly basic reduction preserves this property then all the U_i are closed by prefix. Therefore we can get a new and simpler definition of WB by writing:

- $U_{i+1} = \{v \in O(t_{i+1}) / \text{all the antecedents of } v \text{ in } t_i \text{ are in } U_i\}$

In the following we will use this definition.

The interest of the weakly basic derivations is pointed out in the following lemma, that squeezes out the fact that the notions of weakly basic derivation and sufficient large occurrence set are very linked.

Lemma 2: Let $t_0 \rightarrow^* t_n$ be a derivation, and U_0 be a set of occurrences of t_0 sufficiently large on t_0 . Then $t_0 \rightarrow^* t_n$ is weakly based on U_0 and the set U_n of basic occurrences of t_n is sufficiently large on t_n .

Proof: By induction on the length n of the derivation.

If $n = 0$ the lemma obviously holds. Assume $t_0 \rightarrow^* t_{n-1}$ is weakly basic on U_0 and the basic occurrence set U_{n-1} of t_{n-1} is sufficiently large on t_{n-1} . Thus the reduction occurrence of $t_{n-1} \rightarrow t_n$ must be in U_{n-1} . Let U_n be the basic occurrence set of t_n and $v_n \in D(t_n)$ such that $v_n \notin U_n$. From the definition, there exists at least an antecedent v_{n-1} of v_n in t_{n-1} that does not belong to U_{n-1} . Therefore $t_n/v_n = t_{n-1}/v_{n-1}$ which is normalized by hypothesis.

We can now define the basic narrowing with sufficient largeness as a step of basic S-narrowing such that the sufficient largeness property is preserved, followed by a derivation compatible with \rightarrow . The previous lemma ensures that this derivation is weakly basic, and that the method will be complete.

Definition: Let t_0 be a term, U_0 an occurrence set of t_0 , the step of narrowing $t_0 \rightsquigarrow t_n$ (which is equivalent to $t_0 \rightsquigarrow t_1 \rightarrow t_n$ i.e. $t_0 \rightsquigarrow t_1 \rightarrow \dots \rightarrow t_n$) is said **based on U_0 with sufficient largeness** or **SL-based on U_0** iff there are occurrence sets U_1, \dots, U_n such that:

- $t_0 \rightsquigarrow t_1$ is based on U_0 and $U_1 = B(U_0)$,
- U_1 is sufficiently large on t_1 ,
- For all $i \in \{1, \dots, n-1\}$, $U_{i+1} = WB(U_i)$.

We extend this definition to a narrowing derivation and we will say that a narrowing derivation is SL-based on U_0 . If the set U_0 is not specified we will say more simply this narrowing derivation is **SL-basic**, or this is a **SL-basic narrowing derivation**.

This definition prunes the narrowing tree because all the nodes that do not satisfy the sufficient largeness property are cut. In the same way of the narrowing definition, this definition is generic and define two particular cases: the **SL-basic S-narrowing** when \rightarrow is the identity, and the **SL-basic N-narrowing** when \rightarrow the normalization mapping.

The SL-basic S-narrowing and the basic S-narrowing (definition from Hullot) are not the same relations because of the sufficient largeness property. The SL-basic S-narrowing relation is included in the basic S-narrowing relation.

4.2 The proof of completeness

We use here a short and original proof method that was introduced by C.Kirchner[13] for equational narrowing.

We must first introduce technical definitions.

Definitions: Let

- $SU(t = t', R)$ be the set of the R -unifiers of t and t' (SU as set of unifiers),

- $BU(t=t', R, U)$ be the set of substitutions found by the considered narrowing method applied on the equation $t=t'$ and SL-based on U , using the term rewriting system R (BU as basic unifiers).
- $SU-N(t=t', R, U) = \{ \sigma \mid \sigma \text{ is a normalized } R\text{-unifier of } t \text{ and } t' \text{ and } U \text{ is sufficiently large on } \sigma(t=t') \}$.

Lemma 3: Let R be a convergent term rewriting system, t and t' two terms, and U a subset of $O(t=t')$. Then $SU-N(t=t', R, U) \subseteq BU(t=t', R, U)$.

Proof: By noetherian induction on \rightarrow . Let ρ be any element in $SU-N(t=t', R, U)$. If $\rho(t=t')$ is normalized then ρ is a syntactic unifier of t and t' , then it is an element of $BU(t=t', R, U)$. Otherwise, $\rho(t=t')$ is reducible, and since U is sufficiently large on $\rho(t=t')$, it is reducible into its normal form by a derivation based on U (corollary 1). Consider the first step of this derivation: $\rho(t=t') \rightarrow s_1 = s_1'$. From the correspondance lemma between rewriting and S-narrowing (Hullot[10]), there exists a term $t_1 = t_1'$ and a substitution μ such that:

$$t = t' \xrightarrow{[\sigma]} t_1 = t_1', \quad \mu(t_1 = t_1') = s_1 = s_1', \quad \rho = \mu \cdot \sigma$$

which is summarized by the following diagram:

$$\begin{array}{ccccc}
 \rho(t=t') & \longrightarrow & s_1 = s_1' & \xrightarrow{*} & \mu(t_n = t_n') \\
 \uparrow \rho & & \uparrow \mu & & \uparrow \mu \\
 t = t' & \xrightarrow{\sigma} & t_1 = t_1' & \xrightarrow{*} & t_n = t_n'
 \end{array}$$

From corollary 1, the set U_1 of basic occurrences of $s_1 = s_1'$ is sufficiently large on $s_1 = s_1'$, which is $\mu(t_1 = t_1')$. Let $t_n = t_n'$ be the term defined by $t_1 = t_1' \rightarrow t_n = t_n'$. We have $t_1 = t_1' \xrightarrow{*} t_n = t_n'$ and consider the instantiated derivation $\mu(t_1 = t_1') \rightarrow \mu(t_n = t_n')$. From lemma 2, it is weakly based on U_1 and the set U_n of basic occurrences of $\mu(t_n = t_n')$ is sufficiently large on $\mu(t_n = t_n')$.

μ is normalized, and is a R -unifier of t_1 and t_1' then of t_n and t_n' , U_n is sufficiently large on $\mu(t_n = t_n')$, then $\mu \in SU-N(t_n = t_n', R, U_n)$.

$\mu(t_n = t_n')$ is a strict son of $\rho(t=t')$ for the rewriting relation, so by induction hypothesis we deduce that $\mu \in BU(t_n = t_n', R, U_n)$. Since $\rho = \mu \cdot \sigma$, $\rho \in BU(t=t', R, U)$.

Corollary: $BU(t=t', R, O(t=t')) =_R SU(t=t', R)$.

Proof: $SU-N(t=t', R, O(t=t')) \subseteq BU(t=t', R, O(t=t'))$ from the previous lemma
 $\subseteq SU(t=t', R)$ by correctness of the narrowing
 $\subseteq_R SU-N(t=t', R, O(t=t'))$ by definition

Any SL-basic narrowing relation provides a complete method for unifying in a convergent term rewriting system.

Theorem: Let R be a convergent term rewriting system, t_0 and t_0' be two terms. The set of substitutions σ such that

- there exists a narrowing derivation issued from $t_0 = t_0'$ and SL-based on $O(t_0 = t_0')$:
 $t_0 = t_0' \xrightarrow{[\sigma_1]} t_1 = t_1' \xrightarrow{\dots} \xrightarrow{[\sigma_n]} t_n = t_n'$ such that t_n and t_n' are unifiable by the most general unifier β and that $\beta \cdot \sigma_n \dots \sigma_1$ is normalized on $V(t_0 = t_0')$
- $\sigma = \beta \cdot \sigma_n \dots \sigma_1$

is a complete set of R -unifiers of t_0 and t_0' .

Remark: This result still holds if the definition of basic S -narrowing is changed in left-to-right basic S -narrowing defined as in [5].

5 Commutation of the narrowing relation

In order to compare the various narrowing relations (next section), we must first study the commutation of the S -narrowing relation with the help of the antecedent notion.

Commutation results are established about the rewriting relation [7] by using the residual notion and about the S -narrowing relation by Herold [5] in the case where the commuted occurrences are not comparable. These results are not sufficient and we have established more general results by using the antecedent notion.

We first extend the antecedent definition on a S -narrowing step.

Definition: Let $t \xrightarrow{[u, g \rightarrow d, \sigma]} t'$ be a step of S -narrowing. Let v' be an occurrence of t' . We say that v is an **antecedent** of v' iff

- v is an antecedent of v' in the rewriting step $\sigma(t) \rightarrow_{[u, g \rightarrow d]} t'$
- $v \in D(t)$.

Definition: Given the S -narrowing derivation

$$t_0 \xrightarrow{[u_0, g_0 \rightarrow d_0, \sigma_0]} t_1 \xrightarrow{\dots} \xrightarrow{[u_{n-1}, g_{n-1} \rightarrow d_{n-1}, \sigma_{n-1}]} t_n \quad (1)$$

and $U_0 \subseteq O(t_0)$. We say that this S -narrowing derivation is **weakly based** on U_0 iff the corresponding derivation

$$\sigma_{n-1} \dots \sigma_0(t_0) \xrightarrow{[u_0, g_0 \rightarrow d_0]} \sigma_{n-1} \dots \sigma_1(t_1) \rightarrow \dots \rightarrow [u_{n-1}, g_{n-1} \rightarrow d_{n-1}] t_n \quad (2)$$

is weakly based on U_0 . For each i we define $WB(t_i, (2)) = WB(t_i, (1))$.

Suppose $s \xrightarrow{[p, g \rightarrow d, \sigma]} t \xrightarrow{[q, l \rightarrow r, \theta]} u$ (1). One would want commute the two steps by applying first the rule $l \rightarrow r$ and second $g \rightarrow d$. If the subterm t/q already existed in s i.e. q admits at least an antecedent in s , the idea consists for applying $l \rightarrow r$ in s at all the antecedents of q .

In the following examples p is the applying occurrence of the first rule and q those of the second rule.

Example 3: Let the rewriting rules r_1, r_2 and consider the two steps of S -narrowing:

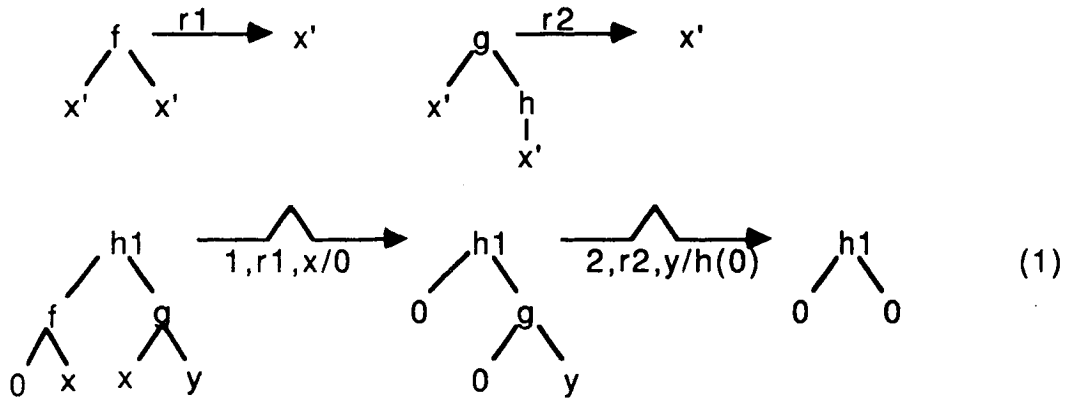

The applying occurrences p of r_1 and q of r_2 are not comparable. By first applying r_2 at q , and second r_1 at p one obtains:

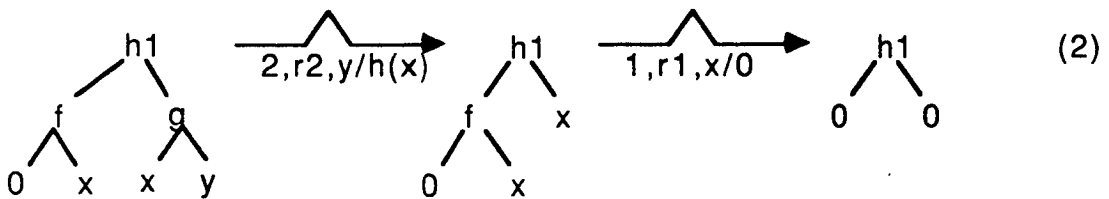

r_1 applied in (1) does not create the same substitution than r_1 applied in (2). The same does for r_2 . However, the substitution composition is the same in the two branches, that moreover lead to the same term.

Example 4: Let the rewriting rules r_1, r_2 and consider the two steps of S-narrowing:

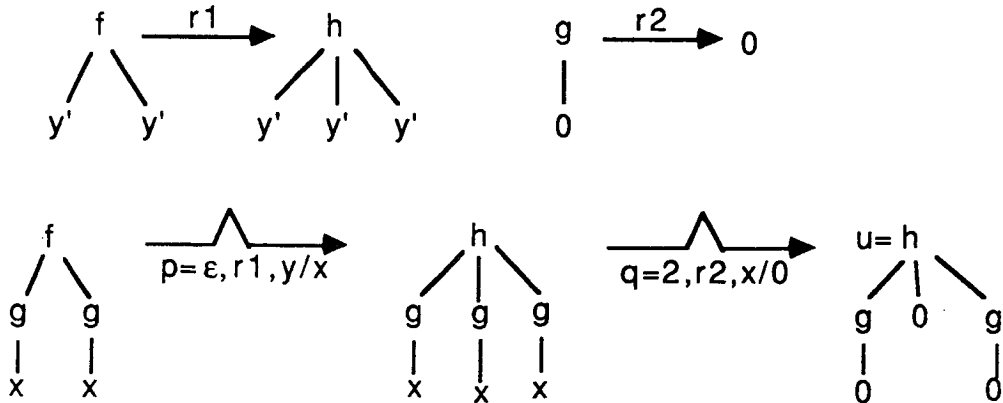

Here $q = 2$ and admits two antecedents $p_1 = 1$ and $p_2 = 2$. Then the two steps are commuted into three steps:

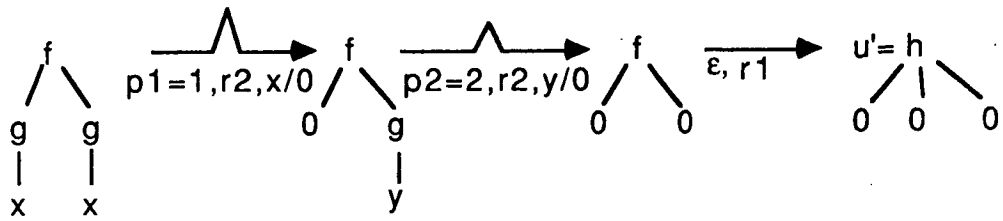

The leaded terms u and u' are not equal because p_1 and p_2 do not admit only as residual q but also $q_1 = 1$ and $q_2 = 3$. Thus $u \rightarrow_{[1, r_2]} \rightarrow_{[3, r_2]} u'$.

Example 5: Let the rewriting rules r_1, r_2 and consider the two steps of S-narrowing:

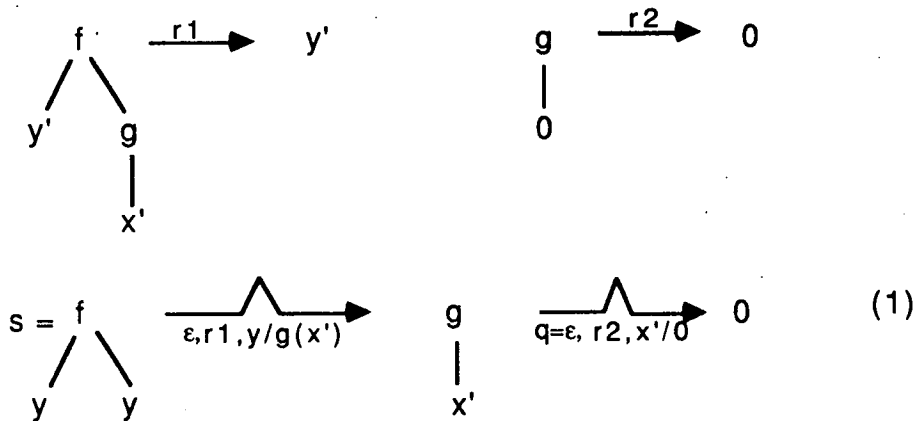

The antecedent of $q = \epsilon$ is $p_1 = 1$ which is a variable occurrence of s . Since one cannot S-narrow at a variable occurrence, the commutation is not possible.

Remark that the substitution composition of (1) ($y / g(0)$) is not normalized. We will show that if it is normalized the antecedents are non variable occurrences.

Example 6: Let the rewriting rules r_1, r_2 and consider the two steps of S-narrowing:

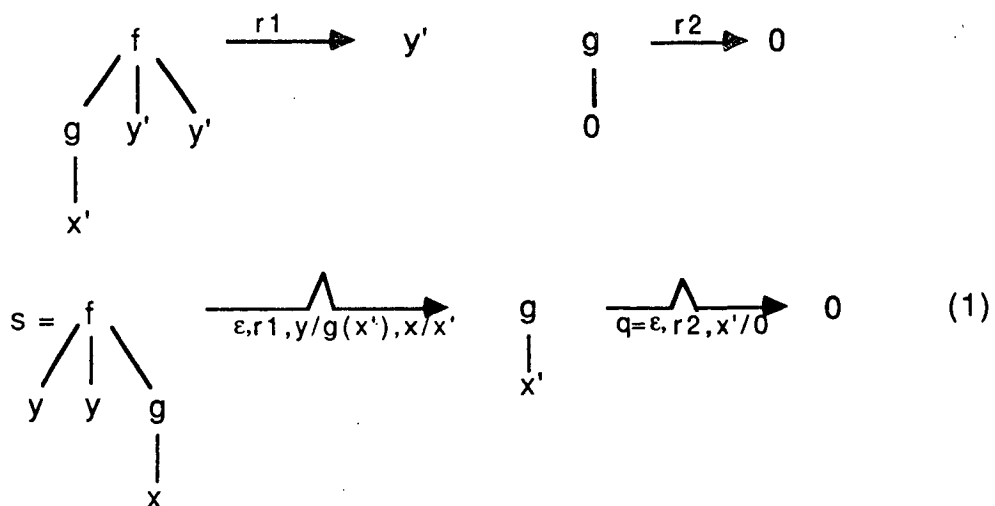

The antecedents of $q = \epsilon$ are $p_1 = 2$ which is a variable occurrence and $p_2 = 3$ which is a non variable occurrence. One can then begin a S-narrowing using r_2 at p_2 :

$$\begin{array}{ccc}
 s = & \begin{array}{c} f \\ / \quad | \quad \backslash \\ y \quad y \quad g \\ \quad \quad \quad | \\ \quad \quad \quad x \end{array} & \xrightarrow{p_2=3, r_2, x/0} & t' = & \begin{array}{c} f \\ / \quad | \quad \backslash \\ y \quad y \quad 0 \end{array} & (2)
 \end{array}$$

The other antecedent is still a variable occurrence in t' (which is not always the case) then the commutation cannot be terminated.

Then one requires that all the antecedents are non variable occurrences.

Example 7: Let the rewriting rules r_1, r_2 and consider the two steps of S-narrowing:

$$\begin{array}{ccc}
 \begin{array}{c} f \\ / \quad \backslash \\ y'' \quad y'' \end{array} \xrightarrow{r_1} y'' & & \begin{array}{c} g \\ / \quad \backslash \\ x'' \quad x'' \end{array} \xrightarrow{r_2} 0 \\
 \\
 s = & \begin{array}{c} f \\ / \quad \backslash \\ g \quad g \\ / \quad \backslash \quad / \quad \backslash \\ x \quad x' \quad y \quad y' \end{array} & \xrightarrow{p=\epsilon, r_1, y/x, y'/x'} & \begin{array}{c} g \\ / \quad \backslash \\ x \quad x' \end{array} & \xrightarrow{q=\epsilon, r_2, x'/x} & 0 & (1)
 \end{array}$$

The antecedents of $q = \epsilon$ are $p_1 = 1$ and $p_2 = 2$. The two steps are commuted into:

$$\begin{array}{ccc}
 s = & \begin{array}{c} f \\ / \quad \backslash \\ g \quad g \\ / \quad \backslash \quad / \quad \backslash \\ x \quad x' \quad y \quad y' \end{array} & \xrightarrow{p_1=1, r_2, x'/x} & \begin{array}{c} f \\ / \quad \backslash \\ 0 \quad g \\ \quad \quad / \quad \backslash \\ \quad \quad y \quad y' \end{array} & \xrightarrow{p_2=2, r_2, y'/y} & t'_2 = & \begin{array}{c} f \\ / \quad \backslash \\ 0 \quad 0 \end{array} & \xrightarrow{\epsilon, r_1} & 0 & (2)
 \end{array}$$

When one applies the rule r_1 the antecedents are made equal, i.e. they are unified. t'_2 is obtained from s by applying r_2 at the antecedents. However along r_2 the variable x'' disappears. Then unifying the antecedents in t'_2 instantiates less variables than unifying the antecedents in s . Therefore the composition substitution in (2) is strictly more general of those of (1).

In order to prove a general commutation result we need a preliminary lemma.

Definitions: We say that two substitutions σ and θ are unifiable iff there exists a substitution μ such that $\mu \cdot \sigma = \mu \cdot \theta$. The most general instance $\sigma * \theta = \mu \cdot \sigma = \mu \cdot \theta$ of σ and θ is sometimes called the merge of σ and θ . Note that the merge is commutative $\sigma * \theta = \theta * \sigma$.

The following lemma was established by Herold[4]. We get and prove this result by strictly specifying the technical conditions on the variables.

Lemma: Let s and t be terms unifiable by the most general unifier σ and θ be any substitution. In order to avoid conflicts of variable, one supposes $D(\sigma) \subseteq (V(s) \cup V(t))$, $D(\theta) \subseteq (V(s) \cup V(t))$, $D(\sigma) \cap I(\sigma) = \emptyset$, $D(\theta) \cap I(\theta) = \emptyset$, and $I(\sigma) \cap I(\theta) = \emptyset$. Then

- σ and θ are unifiable iff $\theta(s)$ and $\theta(t)$ are unifiable,
- if σ and θ are unifiable (or $\theta(s)$ and $\theta(t)$ are unifiable) then $\sigma \cdot \theta = \mu \cdot \theta$, where μ is the most general unifier of $\theta(s)$ and $\theta(t)$.

which is summarized by the following schema:

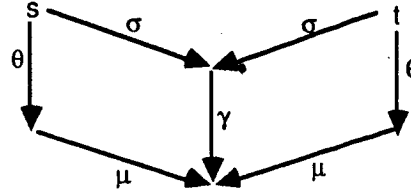

Interpretation of the schema: if $\theta(s)$ and $\theta(t)$ are unifiable by the most general unifier μ , then $\mu \cdot \theta(s) = \mu \cdot \theta(t)$ is an instance of $\sigma(s) = \sigma(t)$. There is a substitution γ such that $\gamma \cdot \sigma(s) = \mu \cdot \theta(s)$ and $\gamma \cdot \sigma(t) = \mu \cdot \theta(t)$. Then σ and θ are unifiable by $\gamma \cup \mu$ which is moreover the most general unifier.

Proof: a) Suppose σ and θ are unifiable. Let τ be a unifier, we have:

$$\tau \cdot \theta(s) = \tau \cdot \sigma(s) = \tau \cdot \sigma(t) = \tau \cdot \theta(t)$$

Therefore $\theta(s)$ and $\theta(t)$ are unifiable by τ .

b) Suppose $\theta(s)$ and $\theta(t)$ are unifiable by the most general unifier μ . $\mu \cdot \theta$ is a unifier of s and t then $\sigma \leq \mu \cdot \theta [V(s) \cup V(t)]$. There exists a substitution γ such that: $\gamma \cdot \sigma = \mu \cdot \theta [V(s) \cup V(t)]$.

We attempt to define a new substitution α that is the mixing of γ and μ . Let $x \in V(s) \cup V(t)$ a variable. We discuss four cases:

- $x \notin D(\sigma)$ and $x \notin D(\theta)$: then $\gamma(x) = \mu(x)$ and we define $\alpha(x) = \gamma(x)$.
- $x \in D(\sigma)$ and $x \notin D(\theta)$: then $\gamma \cdot \sigma(x) = \mu(x)$. We define $\alpha(x) = \mu(x)$. Since $x \in D(\sigma)$, then $V(\sigma(x)) \subseteq I(\sigma)$. Since $D(\sigma) \cap I(\sigma) = \emptyset$ then any variable $y \in V(\sigma(x))$ satisfies $y \neq x$. For a such variable we define $\alpha(y) = \gamma(y)$. Therefore $\alpha \cdot \sigma(x) = \alpha \cdot \theta(x)$.
- $x \notin D(\sigma)$ and $x \in D(\theta)$: then $\gamma(x) = \mu \cdot \theta(x)$. We define $\alpha(x) = \gamma(x)$. Since $x \in D(\theta)$, then $V(\theta(x)) \subseteq I(\theta)$. Since $D(\theta) \cap I(\theta) = \emptyset$ then any variable $y \in V(\theta(x))$ satisfies $y \neq x$. For a such variable we define $\alpha(y) = \mu(y)$. Therefore $\alpha \cdot \sigma(x) = \alpha \cdot \theta(x)$.
- $x \in D(\sigma) \cap D(\theta)$: We have $V(\sigma(x)) \subseteq I(\sigma)$, $V(\theta(x)) \subseteq I(\sigma)$. Since

$I(\sigma) \cap I(\theta) = \emptyset$, then for any variable $y \in V(\sigma(x))$ we define $\alpha(y) = \gamma(y)$ and for any variable $y \in V(\theta(x))$ we define $\alpha(y) = \mu(y)$. Therefore $\alpha \cdot \sigma(x) = \alpha \cdot \theta(x)$.

We have $\alpha \cdot \sigma = \gamma \cdot \sigma [V(s) \cup V(t)]$, $\alpha \cdot \theta = \mu \cdot \theta [V(s) \cup V(t)]$, then $\alpha \cdot \sigma = \alpha \cdot \theta [V(s) \cup V(t)]$. Since $D(\sigma), D(\theta), D(\alpha)$ are included in $V(s) \cup V(t)$ one can write $\alpha \cdot \sigma = \alpha \cdot \theta \cdot \sigma$ and θ are unifiable. let ρ be their most general unifier. We have $\rho \cdot \theta \leq \mu \cdot \theta [V(s) \cup V(t)]$, then $\rho \leq \mu [V(\theta(s)) \cup V(\theta(t))]$.

c) From a), $\theta(s)$ and $\theta(t)$ are unifiable by ρ . Since μ was their most general unifier then $\mu \leq \rho [V(\theta(s)) \cup V(\theta(t))]$. Thus $\rho = \mu$ and $\sigma \cdot \theta = \mu \cdot \theta$.

Notations: In order to simplify the notations, we denote the derivation $u \rightarrow_{*[q_1, l \rightarrow r]} u_1 \rightarrow \dots \rightarrow_{[q_n, l \rightarrow r]} u_n = u'$ by $u \rightarrow_{*[q_1, \dots, q_n, l \rightarrow r]} u'$.

Commutation property: Let R be any term rewriting system and

$$s \xrightarrow{[p, g \rightarrow d, \sigma]} t \xrightarrow{[q, l \rightarrow r, \theta]} u \quad (1)$$

be two steps of S-narrowing issued from s such that

- q admits at least an antecedent in s (we denote them by p_0, \dots, p_{m-1}),
- all antecedent p_i of q is a non variable occurrence of s , (C2)
- $V(r) = V(l)$ or g is linear (in this case $m=1$).

Then (1) can be commuted into:

$$s \xrightarrow{[p_0, l \rightarrow r, \theta_0]} t_1 \xrightarrow{\dots} \xrightarrow{[p_{m-1}, l \rightarrow r, \theta_{m-1}]} t_m \xrightarrow{[p, g \rightarrow d, \sigma']} u' \quad (2)$$

such that

- $\sigma' \cdot \theta_{m-1} \dots \theta_0 = \theta \cdot \sigma [V(s)]$
- $u \rightarrow_{*[q_1, \dots, q_n, l \rightarrow r]} u'$ where q_1, \dots, q_n are the brothers of q i.e. the residuals of p_0, \dots, p_{m-1} in t .

Let (1') be the S-narrowing derivation formed by (1) followed by $u \rightarrow u'$.

Moreover, if (1') is weakly based on $U \subseteq O(s)$ then (2) is weakly based on U and $WB(u'; (1')) = WB(u'; (2))$.

Remark: If d is linear or u is normalized then $u' = u$.

Remark: The condition (C2) is difficultly checkable. let us search a sufficient condition.

Suppose there exists an antecedent p_i such that $s/p_i = x$ where x is a variable. By definition of the antecedent $\sigma(s) / p_i = t/q$. Thus

$$\theta \cdot \sigma(x) = \theta \cdot \sigma(s/p_i) = \theta(t/q) \rightarrow_{[l \rightarrow r]} u/q$$

which proves $\theta \cdot \sigma$ is not normalized on $V(s)$. Therefore $\theta \cdot \sigma$ is normalized on $V(s)$ implies all antecedent p_i of q is a non variable occurrence of s . We can then change (C2) by:

- $\theta \cdot \sigma$ is normalized on $V(s)$. (C'2)

Proof: Since $t \xrightarrow{[q, l \rightarrow r, \theta]} u$ then $\theta(t/q) = \theta(l)$. Since p_0, \dots, p_{m-1} are the antecedents of q then $\sigma(s/p_0) = \dots = \sigma(s/p_{m-1}) = t/q$. Therefore

$$\theta \cdot \sigma(s/p_0) = \theta(l), \dots, \theta \cdot \sigma(s/p_{m-1}) = \theta(l)$$

Since one can always have $V(s) \cap V(l) = \emptyset$ then we can define $\gamma = \theta \cdot \sigma[V(s)]$ and $\gamma = \theta[V(l)]$. For all $i \in \{0, \dots, m-1\}$ the terms s/p_i and l are unifiable by γ , let ρ_i be the most general unifier.

Let us now prove by induction that for all $i \in \{1, \dots, m\}$ we have

- $s \xrightarrow{[p_0, l \rightarrow r, \theta_0]} t_1 \xrightarrow{\dots} \dots \xrightarrow{[p_{i-1}, l \rightarrow r, \theta_{i-1}]} t_i$
- $\rho_0, \dots, \rho_{i-1}, \sigma$ are unifiable and the merge satisfies $\rho_{i-1} * \dots * \rho_0 = \theta_{i-1} \dots \theta_0$ and $(\rho_{i-1} * \dots * \rho_0) * \sigma = \theta \cdot \sigma$.

By hypothesis $p_0 \in O(s)$, then by denoting $\theta_0 = \rho_0$ we get $s \xrightarrow{[p_0, l \rightarrow r, \theta_0]} t_1$. Since θ is the most general unifier of t/q and l , since $t/q = \sigma(s/p_0)$ and $l = \sigma(l)$ then θ is the most general unifier of $\sigma(s/p_0)$ and $\sigma(l)$. By applying the previous lemma on the terms s/p_0 , l and the substitutions ρ_0 , σ it results that ρ_0 and σ are unifiable and $\rho_0 * \sigma = \theta \cdot \sigma$ and the property holds for $i = 1$.

Assume the property for i . Since for any j we have $\rho_j \leq \gamma$ then there exists a substitution α_j such that $\alpha_j \cdot \rho_j = \gamma$. Then γ is an unifier of all the ρ_j and $\rho_{i-1} * \dots * \rho_0 \leq \gamma$. Since $\rho_i \leq \gamma$ then ρ_i and $\rho_{i-1} * \dots * \rho_0$ are unifiable. By applying the previous lemma on the terms s/p_i , l and the substitutions ρ_i , $\rho_{i-1} * \dots * \rho_0$, one gets $\rho_{i-1} * \dots * \rho_0(s/p_i)$ and $\rho_{i-1} * \dots * \rho_0(l)$ are unifiable and by denoting θ_i the most general unifier we get

$$\rho_i * \rho_{i-1} * \dots * \rho_0 = \theta_i \cdot (\rho_{i-1} * \dots * \rho_0)$$

By using the induction hypothesis we get:

$$\rho_i * \dots * \rho_0 = \theta_i \cdot (\rho_{i-1} * \dots * \rho_0) = \theta_i \dots \theta_0$$

Since θ is the most general unifier of t/q and l , since $t/q = \sigma(s/p_i)$ and $l = \sigma(l)$ then θ is the most general unifier of $\sigma(s/p_i)$ and $\sigma(l)$. By applying the previous lemma on the terms s/p_i , l and the substitutions ρ_i , σ it results that ρ_i and σ are unifiable and $\rho_i * \sigma = \theta \cdot \sigma$. Thus

$$\rho_i * \dots * \rho_0 * \sigma = (\rho_i * \sigma) * (\rho_{i-1} * \dots * \rho_0 * \sigma) = (\theta \cdot \sigma) * (\theta \cdot \sigma) = \theta \cdot \sigma$$

In order to avoid variable conflicts we suppose that the variables of $l \rightarrow r$ are renamed into new variables after each using of $l \rightarrow r$. Now one considers the term l so that for all $j \in \{0, \dots, i-1\}$, $D(\rho_j) \cap V(l) = \emptyset$. Then $\rho_{i-1} * \dots * \rho_0(l) = l$ and θ_i is the most general unifier of $\rho_{i-1} * \dots * \rho_0(s/p_i) = \theta_{i-1} \dots \theta_0(s/p_i)$ and l . Since p_0, \dots, p_i are antecedents of q there are not comparable and $t_i/p_i = \theta_{i-1} \dots \theta_0(s/p_i)$. Since $p_i \in O(s)$ then $t_i \xrightarrow{[p_i, l \rightarrow r, \theta_i]} t_{i+1}$ which proves the property for $i+1$.

By summarizing we have proved:

$$s \xrightarrow{[p_0, l \rightarrow r, \theta_0]} t_1 \xrightarrow{\dots} t_m \text{ and } (\theta_{m-1} \dots \theta_0) \circ \sigma = \theta \circ \sigma \quad (EQ).$$

Since $s \xrightarrow{[p, g \rightarrow d, \sigma]} t$ then s/p and g are unifiable by the most general unifier σ .

σ and $\theta_{m-1} \dots \theta_0$ being unifiable, from the previous lemma applied on the terms s/p , g and the substitutions σ , $\theta_{m-1} \dots \theta_0$ we get $\theta_{m-1} \dots \theta_0 (s/p)$ and $\theta_{m-1} \dots \theta_0 (g) = g$ are unifiable by the most general unifier σ'' such that $\sigma'' (\theta_{m-1} \dots \theta_0) = \sigma'' \circ \theta_{m-1} \dots \theta_0$.

From (EQ) one deduces $\sigma'' \circ \theta_{m-1} \dots \theta_0 = \theta \circ \sigma$.

From the antecedent definition, we can distinguish two cases.

First case: p and q are not comparable.

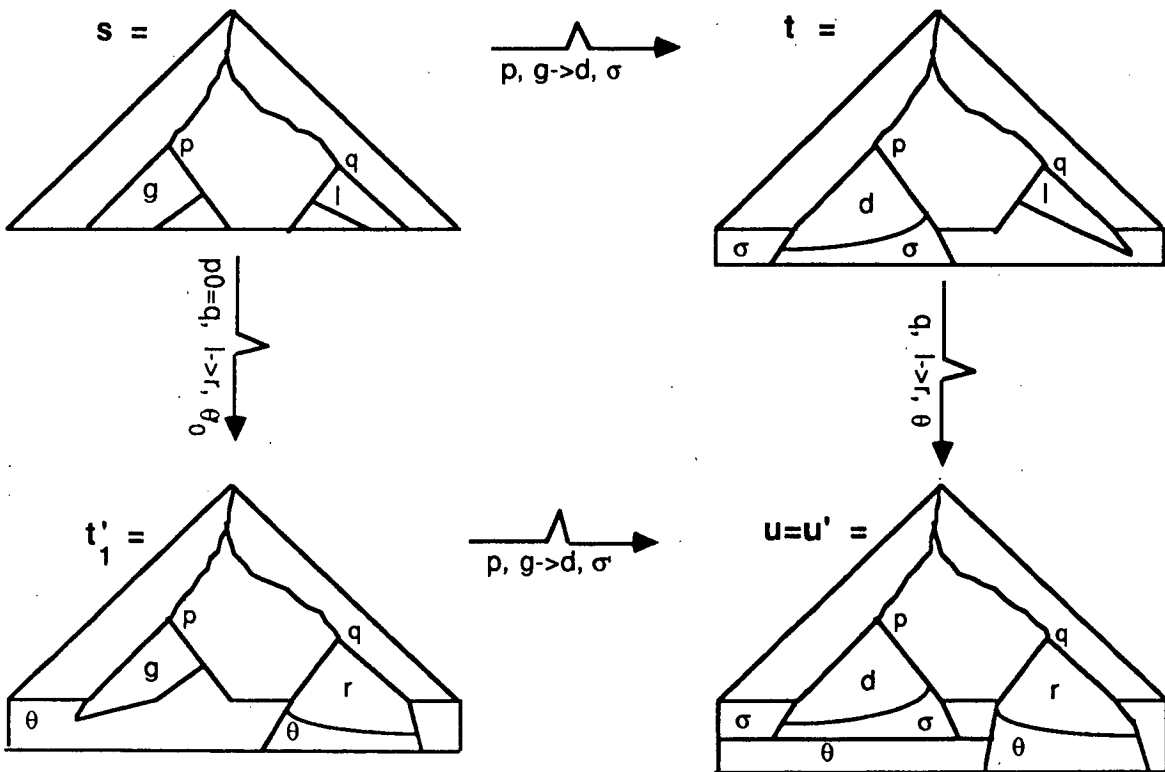

q has one antecedent $p_0 = q$, $m = 1$ and $t_1/p = \theta_0 (s/p)$. Let us write $\sigma' = \sigma''$. Then σ' is the most general unifier of t_1/p and g . Thus:

$$t_1 = \theta_0 (s) [p_0 \leftarrow \theta_0 (r)] \xrightarrow{[p, g \rightarrow d, \sigma']} u' = \sigma'' \circ \theta_0 (s) [q \leftarrow \sigma'' \circ \theta_0 (r)] [p \leftarrow \sigma'' (d)]$$

$\sigma'' (d) = \sigma'' \circ \theta_0 (d)$ because $D(\theta_0) \cap V(d) = \emptyset$. Since $\sigma'' \circ \theta_0 = \theta \circ \sigma$ then

$$u' = \theta \circ \sigma (s) [p \leftarrow \theta \circ \sigma (d)] [q \leftarrow \theta \circ \sigma (r)]$$

Since $\sigma (r) = r$ then $u' = u$.

Now assume (1) is weakly based on U . Then $p_0 = q \in U$ and $p \in U$ which shows that (2) is weakly based on U .

Let $w_2 \in D(u)$. It is obvious that w_0 is an antecedent of w_2 in s by the rewriting derivation corresponding to (1) iff w_0 is an antecedent of w_2 in s by the rewriting derivation corresponding to (2). Therefore $WB(u, (1)) = WB(u, (2))$.

Second case: otherwise $q = p \cdot v_0 \cdot w$ and $p_0 = p \cdot v_0 \cdot w, \dots, p_{m-1} = p \cdot v_{m-1} \cdot w$ where v_0 is the occurrence of a variable x in d and v_0, \dots, v_{m-1} are the occurrences of x in g .

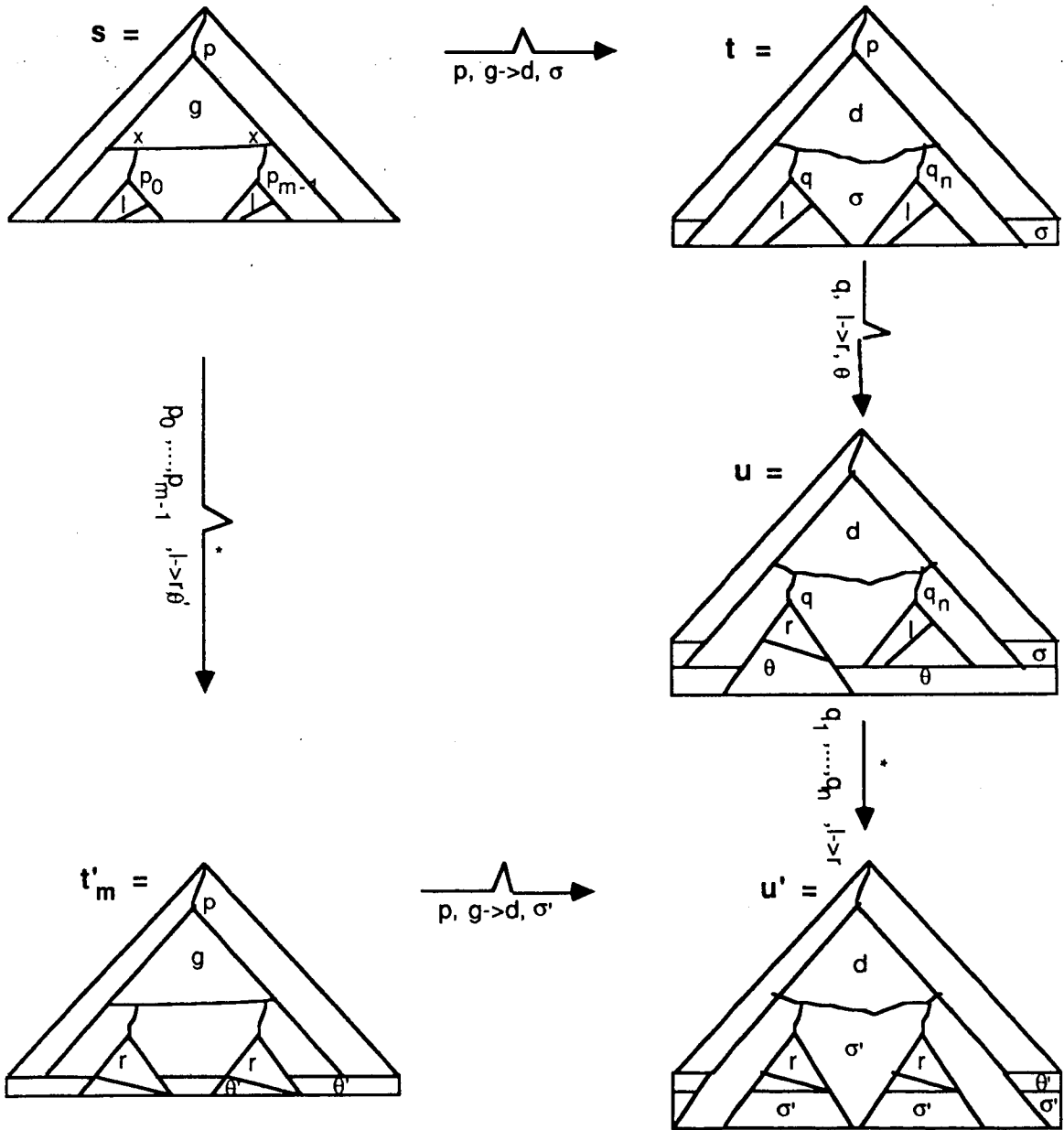

Let $ta = \theta_{m-1} \dots \theta_0(s)$ and $te = ta[p_0 \leftarrow e], \dots, [p_{m-1} \leftarrow e]$ where e is a new constant symbol. With this notations σ'' is the most general unifier of ta/p and g . Let us study how σ'' can be computed.

One first unifies te/p and g by the most general unifier γ_1 .

We have $\gamma_1(x)/w = a$. Now we must make equal the subterms $\gamma_1(ta/p_0), \dots, \gamma_1(ta/p_{m-1})$.

Let γ_2 be their most general unifier. Then $\gamma_2 \cdot \gamma_1(ta/p_0) = \dots = \gamma_2 \cdot \gamma_1(ta/p_{m-1})$.

Consider γ_3 defined by

$$\begin{aligned} \gamma_3(y) &= \gamma_2 \cdot \gamma_1 \quad \text{if } y \neq x \\ &= \gamma_2 \cdot \gamma_1(x) [w \leftarrow \gamma_2 \cdot \gamma_1(ta/p_0)] \quad \text{if } y = x \end{aligned}$$

We have

$$\begin{aligned} \gamma_3(ta) &= \gamma_3(te[p_0 \leftarrow ta/p_0] \dots [p_{m-1} \leftarrow ta/p_{m-1}]) \\ &= \gamma_2 \cdot \gamma_1(te) [p_0 \leftarrow \gamma_2 \cdot \gamma_1(ta/p_0)] \dots [p_{m-1} \leftarrow \gamma_2 \cdot \gamma_1(ta/p_{m-1})] \\ \gamma_3(g) &= \gamma_2 \cdot \gamma_1(g) [v_0 \cdot w \leftarrow \gamma_2 \cdot \gamma_1(ta/p_0)] \dots [v_{m-1} \cdot w \leftarrow \gamma_2 \cdot \gamma_1(ta/p_{m-1})] \\ &= \gamma_2 \cdot \gamma_1(te/p) [v_0 \cdot w \leftarrow \gamma_2 \cdot \gamma_1(ta/p_0)] \dots [v_{m-1} \cdot w \leftarrow \gamma_2 \cdot \gamma_1(ta/p_{m-1})] \end{aligned}$$

Then $\gamma_3(ta/p) = \gamma_3(g)$. γ_3 is an unifier of ta/p and g , and since it has been computed by necessarily steps then γ_3 is the most general unifier i.e. $\gamma_3 = \sigma''$.

Now let us compute a unifier of t'_m/p and g as previously.

Since $ta = \theta_{m-1} \dots \theta_0(s) \rightarrow_{\{p_0, \dots, p_{m-1}, l \rightarrow r\}} t'_m$ then

$ta = ta[p_0 \leftarrow \theta_{m-1} \dots \theta_0(l_0)] \dots [p_{m-1} \leftarrow \theta_{m-1} \dots \theta_0(l_{m-1})]$,

$t'_m = ta[p_0 \leftarrow \theta_{m-1} \dots \theta_0(r_0)] \dots [p_{m-1} \leftarrow \theta_{m-1} \dots \theta_0(r_{m-1})]$, where l_0, \dots, l_{m-1} are equal to l up to a variable remaining and r_0, \dots, r_{m-1} are the corresponding right hand sides.

Let $\gamma_1, \gamma_2, \gamma_3$ be the substitutions that correspond to $\gamma_1, \gamma_2, \gamma_3$ respectively, and $t'e$ the term that corresponds to te .

$t'e = te$ and then $\gamma_1 = \gamma_1$. If $V(r) = V(l)$ then $\gamma_2 = \gamma_2$. If g is linear then $m = 1$ and $\gamma_2 = \gamma_2 = \text{Identity}$.

Since $t'_m/p_0 = \theta_{m-1} \dots \theta_0(r_0)$ then γ_3 is defined by

$$\begin{aligned} \gamma_3(y) &= \gamma_2 \cdot \gamma_1(y) \quad \text{if } y \neq x \\ &= \gamma_2 \cdot \gamma_1(x) [w \leftarrow \gamma_2 \cdot \gamma_1 \cdot \theta_{m-1} \dots \theta_0(r_0)] \quad \text{if } y = x \end{aligned}$$

By definition of γ_2 we get

$$\gamma_2 \cdot \gamma_1 \cdot \theta_{m-1} \dots \theta_0(r_0) = \dots = \gamma_2 \cdot \gamma_1 \cdot \theta_{m-1} \dots \theta_0(r_{m-1})$$

Let $\sigma' = \gamma_3$. Since $\gamma_2 \cdot \gamma_1 = \gamma_2 \cdot \gamma_1$ then σ' is equal to:

$$\begin{aligned} \sigma'(y) &= \sigma''(y) \quad \text{if } y \neq x \\ &= \sigma''(x) [w \leftarrow \sigma'' \cdot \theta_{m-1} \dots \theta_0(r)] \quad \text{if } y = x \end{aligned}$$

One has $\sigma' \cdot \theta_{m-1} \dots \theta_0 = \theta \cdot \sigma [V(s) \cup V(r)]$ because $\sigma' = \sigma''$ except for the variable $x \in V(g)$. Since the computation of σ' is similar to those of γ_3 , it results that σ' is the most general unifier of t'_m/p and g .

Therefore $t'_m \rightarrow_{\{p, g \rightarrow d, \sigma'\}} u'$. The brothers of q are $q_1 = p \cdot v_1 \cdot w, \dots, q_n = p \cdot v_n \cdot w$ where v_0, v_1, \dots, v_n are the occurrences of x in d , and we have:

$$\begin{aligned} u' &= \sigma'(t'_m) [p \leftarrow \sigma'(d)] \\ &= \sigma'' \cdot \theta_{m-1} \dots \theta_0(s) [p \leftarrow \sigma''(d) [v_0 \cdot w \leftarrow \sigma'' \cdot \theta_{m-1} \dots \theta_0(r)]] \dots [v_n \cdot w \leftarrow \sigma'' \cdot \theta_{m-1} \dots \theta_0(r)] \end{aligned}$$

Since $\theta'_{m-1} \dots \theta'_0 (d) = d$ and $\sigma'' \cdot \theta'_{m-1} \dots \theta'_0 = \theta \cdot \sigma$ then

$$\begin{aligned} u' &= \theta \cdot \sigma (s) [p \leftarrow \theta \cdot \sigma (d) [v'_0 \cdot w \leftarrow \theta \cdot \sigma (r)] \dots [v'_n \cdot w \leftarrow \theta \cdot \sigma (r)]] \\ &= u [q_1 \leftarrow \theta (r)] \dots [q_n \leftarrow \theta (r)] \end{aligned}$$

Therefore $u \rightarrow^*_{[q_1, \dots, q_n, l \rightarrow r]} u'$.

Now assume (1') is weakly based on U . Then $p_0, \dots, p_{m-1} \in U$ and $p \in U$, which shows that (2) is weakly based on U .

Let $w_2 \in D(u')$, it is obvious that w_0 is an antecedent of w_2 in s by the rewriting derivation corresponding to (1') iff w_0 is an antecedent of w_2 in s by the rewriting derivation corresponding to (2). Therefore $WB(u'; (1')) = WB(u'; (2))$.

Now, we try to commute a step through a S-narrowing derivation.

Notations:

- a) In order to simplify the notations, we denote the S-narrowing derivation $s_1 \xrightarrow{[\nu_1, l \rightarrow r, \sigma_1]} s_2 \xrightarrow{\dots} s_n \xrightarrow{[\nu_n, l \rightarrow r, \sigma_n]} s_{n+1}$ by $s_1 \xrightarrow{[\nu_1, \dots, \nu_n, l \rightarrow r, \theta]} s_{n+1}$ with $\theta = \sigma_n \dots \sigma_1$.
- b) If (1) is a S-narrowing derivation that leads to t_n and (2) a S-narrowing derivation issued from t_n then one writes (1) + (2) the S-narrowing derivation formed by (1) followed by (2).
- c) If $t_0 \xrightarrow{[\nu_0, l \rightarrow r, \sigma_0]} t_n$ (1) is both based on $U_0 \subseteq O(t_0)$ and on $V_0 \subseteq O(t_0)$, one can consider two sets of basic occurrences in t_n according as the considered set of basic occurrences of t_0 is U_0 or V_0 . In order to distinguish them, one denotes them by $B(t_n, (1), U_0)$ and $B(t_n, (1), V_0)$.

Definition: Let $t_0 \xrightarrow{[\nu_0, g_0 \rightarrow d_0, \sigma_0]} t_1 \xrightarrow{\dots} t_n$ (1) be a S-narrowing derivation and $u_n \in D(t_n)$. One says that the antecedent $v_i \in D(t_i)$ of u_n is **terminal** in (1) iff $i = 0$ or v_i does not have antecedent in t_{i-1} .

Property of maximum commutation: Let R be a right linear term rewriting system and

$$t_0 \xrightarrow{[\nu_0, g_0 \rightarrow d_0, \sigma_0]} t_1 \xrightarrow{\dots} t_n \xrightarrow{[\nu_n, l \rightarrow r, \theta]} t_{n+1} \quad (1)$$

be a S-narrowing derivation and $t_n \xrightarrow{[\nu_n, l \rightarrow r, \theta]} s$ (2) be a step of S-narrowing issued from t_n . One assumes

- the substitution $\theta \cdot \sigma_{n-1} \dots \sigma_0$ is normalized on $V(t_0)$,
- $V(r) = V(l)$ or R is left linear.

Then there exists a S-narrowing derivation:

$$\begin{aligned} & (t_0 \xrightarrow{[\nu_0, l \rightarrow r, \theta_0]} t_1 \xrightarrow{\dots} t_n \xrightarrow{[\nu_n, l \rightarrow r, \theta_n]} s) \xrightarrow{[\nu_0, g_0 \rightarrow d_0, \sigma_0]} \dots \\ & \xrightarrow{[\nu_{n-1}, l \rightarrow r, \theta_{n-1}]} t_{n-1} \xrightarrow{[\nu_{n-1}, l \rightarrow r, \theta_{n-1}]} t_n \xrightarrow{[\nu_n, l \rightarrow r, \theta_n]} s' \end{aligned} \quad (3)$$

where for all $i \in \{0, \dots, n\}$, $v_{i,1}, \dots, v_{i,k_i} \in D(t_i)$ are the terminal antecedents of v_n and such that

- $s' = s$

$$\bullet \theta_n \cdot (\sigma_{n-1}' \cdot \theta_{n-1}) \dots (\sigma_0' \cdot \theta_0) = \theta \cdot \sigma_{n-1} \dots \sigma_0 [V(t_0)]$$

If (1)+(2) is weakly based on $U_0 \subseteq O(t_0)$ then (3) is weakly based on U_0 and $WB(s'; (3)) = WB(s, (1) + (2))$.

If moreover (1) is based on U_0 then (3) is based on U_0 .

(3) will be called the maximum commuted of (2) in (1).

Remark: The last step of (3) translates the fact that v_n may have no antecedent i.e v_n is a terminal antecedent of v_n . In this case the commutation is not possible and (3) = (1) + (2). If v_n has antecedents then the last step of (3) does not exist.

Proof: By induction on the length of (1).

If the length is null then v_n is terminal and the property holds.

Suppose the property is true for $n-1$. Consider the S -narrowing derivation issued from t_1 :

$$t_1 \xrightarrow{\sim} [u_1, g_1 \rightarrow d_1, \sigma_1] t_2 \xrightarrow{\sim} \dots \xrightarrow{\sim} [u_{n-1}, g_{n-1} \rightarrow d_{n-1}, \sigma_{n-1}] t_n \quad (1')$$

The maximum commuted of (2) in (1') is:

$$(t_1 \xrightarrow{\sim} * [v_{1,1}, \dots, v_{1,m_1}, l \rightarrow r, \alpha] t \xrightarrow{\sim} [u_1, g_1 \rightarrow d_1, \sigma_1] t_2 \xrightarrow{\sim} * \dots \xrightarrow{\sim} t_n \xrightarrow{\sim} * s') \quad (4)$$

with

- $s' = s$
- $\theta_n \cdot (\sigma_{n-1}' \cdot \theta_{n-1}) \dots (\sigma_2' \cdot \theta_2) \cdot (\sigma_1' \cdot \alpha) = \theta \cdot \sigma_{n-1} \dots \sigma_1 [V(t_1)]$

Assume (1)+(2) is weakly based on U_0 . Then (1') is weakly based on $U_1 = WB(t_1, (1))$ and $WB(s, (1') + (2)) = WB(s, (1) + (2))$. By induction hypothesis (4) is weakly based on U_1 and $WB(s'; (4)) = WB(s, (1') + (2)) = WB(s, (1) + (2))$.

Consider the beginning of (4):

$$t_0 \xrightarrow{\sim} [u_0, g_0 \rightarrow d_0, \sigma_0] t_1 \xrightarrow{\sim} * [v_{1,1}, \dots, v_{1,m_1}, l \rightarrow r, \alpha] t \quad (5)$$

(5) is weakly based on U_0 .

$v_{1,1}, \dots, v_{1,m_1}$ are the antecedents of v_n in t_1 . Consider one of them $v_{1,j}$. If $v_{1,j}$ has no antecedent in t_0 , $v_{1,j}$ is a terminal antecedent. Otherwise by applying commutation property one can commute $v_{1,j}$ with the steps $[v_{1,1}, \dots, v_{1,j-1}, l \rightarrow r]$ because $v_{1,j}$ is not comparable with $v_{1,1}, \dots, v_{1,j-1}$. Now one commutes it with the step $[u_0, g_0 \rightarrow d_0]$. The substitution composition of (5) is preserved on $V(t_1)$ and the new derivation is weakly based on U_0 and has the same sets of basic occurrences.

We do the above commutation for all the $v_{1,j}$ that have antecedents in t_0 , we obtain:

$$t_0 \xrightarrow{\sim} * [v_{0,1}, \dots, v_{0,k_0}, l \rightarrow r, \theta_0] t_1 \xrightarrow{\sim} [u_0, g_0 \rightarrow d_0, \sigma_0] t_1 \xrightarrow{\sim} * [v_{1,1}, \dots, v_{1,k_1}, l \rightarrow r, \theta_1] t \quad (6)$$

where $v_{1,1}, \dots, v_{1,k_1}$ are the terminal antecedents that have not been commuted, and with $\theta_1 \cdot \sigma_0' \cdot \theta_0 = \alpha \cdot \sigma_0 [V(t_0)]$. Then by extending α on $I(\sigma_0)$ one gets:

$$\begin{aligned} \theta_n \cdot (\sigma_{n-1}' \cdot \theta_{n-1}) \dots (\sigma_1' \cdot \theta_1) \cdot (\sigma_0' \cdot \theta_0) &= \theta_n \cdot (\sigma_{n-1}' \cdot \theta_{n-1}) \dots \sigma_1' \cdot (\alpha \cdot \sigma_0) [V(t_0)] \\ &= \theta \cdot \sigma_{n-1} \dots \sigma_0 [V(t_0)] \end{aligned}$$

which proves the first part of the property.

Suppose (1) is based on U_0 and let us show by induction on the length that (3) is based on U_0 . Suppose the i -first steps of (3) $t_0 \xrightarrow{\sim} *t_i$ are based on U_0 and consider $t_i \xrightarrow{\sim} *_{[v_{i,1}, \dots, v_{i,k_i}, l \rightarrow r, \theta_i]} t_{i+1}$. $v_{i,1}, \dots, v_{i,k_i}$ are terminal antecedents, then they have no antecedent. Thus each of them $v_{i,j}$ satisfies $v_{i,j} < u_{i-1}$ or $v_{i,j} = u_{i-1}$. w with $w \in O(d_{i-1})$. Since the basic occurrence sets are closed by prefix then $v_{i,j} \in B(t_i, (3))$. It results the derivation $t_i \xrightarrow{\sim} *_{[v_{i,1}, \dots, v_{i,k_i}, l \rightarrow r, \theta_i]} t_{i+1}$ is based on $B(t_i, (3))$. The difference between $B(t, (3))$ and $B(t, (1))$ appears only for occurrences greater than the non terminal antecedents of v_n in t . Then $u_i \in B(t, (3))$.

6 Comparison of the narrowing relations

6.1 SL-basic S-narrowing with basic S-narrowing

SL-basic S-narrowing is included in basic S-narrowing.

Example 8: Consider the canonical term rewriting system

$$R = \{r_1: f(g(x), y) \rightarrow y, r_2: h(g(x)) \rightarrow x, r_3: f_1(x, x) \rightarrow x\}$$

We want to solve modulo R the equation $f_1(0, f(x', h(x')))) = 0$. We compute all the S-narrowing derivations: ("% symbol means that the corresponding occurrence is not basic)

$$f_1(0, f(x', h(x'))) = 0 \xrightarrow{\sim}_{[1.2, r_1, x'/g(x), y/h(g(x))]} f_1(0, \% h(g(x))) = 0 \quad (1)$$

$$\xrightarrow{\sim}_{[1.2, r_2, l_d]} f_1(0, x) = 0 \xrightarrow{\sim}_{[1, r_3, x/0]} 0 = 0 \quad (2)$$

and

$$f_1(0, f(x', h(x'))) = 0 \xrightarrow{\sim}_{[1.2.2, r_2, x'/g(x)]} f_1(0, f(g(x), x)) = 0 \quad (3)$$

$$\xrightarrow{\sim}_{[1.2, r_1, l_d]} f_1(0, x) = 0 \xrightarrow{\sim}_{[1, r_3, x/0]} 0 = 0 \quad (4)$$

The two branches give the solution $x'/g(0)$. One of them is of course useless. By using basic S-narrowing there are only branches (1),(3)+(4); by using SL-basic S-narrowing there are only the branch (3)+(4) because the term $f_1(0, \% h(g(x)))$ contains a no basic subterm (pointed out by "%") that is not in normal form.

6.2 basic narrowing with basic S-narrowing, and commutation properties

In this paragraph, we consider basic narrowing rather than SL-basic narrowing because the sufficient largeness property does not interfere. It is difficult to compare basic narrowing with basic S-narrowing. Indeed, If we consider a basic narrowing derivation, we can transform it into a S-narrowing derivation by considering the rewriting steps as S-narrowing steps. But the rewriting steps use a weakly basic computation of the basic occurrences and then the resulting S-narrowing derivation would not be necessarily basic, but only weakly basic.

Let $t_0 \xrightarrow{\sim} *t_n$ this weakly basic S-narrowing derivation. Suppose the beginning $t_0 \xrightarrow{\sim} *t_i$ is basic, and $t_0 \xrightarrow{\sim} *t_{i+1}$ is not basic. Therefore in the step $t_i \xrightarrow{\sim}_{[u_i, g_i \rightarrow d_i, \sigma_i]} t_{i+1}$, u_i satisfies $u_i \in WB(t_i)$ and

$u_i \notin B(t_i)$. From the definitions there is a step $t_j \xrightarrow{\{u_j, g_j \rightarrow d_j, \sigma_j\}} t_{j+1}$ with $j < i$ that creates the difficulty, i.e. the antecedent v_j of u_j in t_j satisfies $v_j \in B(t_j)$ and its antecedent v_{j+1} in t_{j+1} is so that $v_{j+1} \notin B(t_{j+1})$.

In order to transform a weakly basic S-narrowing derivation into a basic S-narrowing derivation, the idea consists of applying the rule $g_j \rightarrow d_j$ not on t_i , but on t_j at the occurrence v_j , which belongs to $B(t_j)$. This leads to commute the step $t_i \xrightarrow{\quad} t_{i+1}$ with the S-narrowing derivation $t_j \xrightarrow{\quad} t_j$.

This lemma results from the commutation properties.

Lemma (correspondance between weakly basic and basic S-narrowing derivations): Let R be a right linear term rewriting system. One supposes moreover R is regular or left linear. Let $t_0 \xrightarrow{\quad} *_[\theta] t_n$ (1) be a S-narrowing derivation weakly based on $U_0 \subseteq O(t_0)$ and such that θ is normalized on $V(t_0)$.

Then there exists a S-narrowing derivation $t_0 \xrightarrow{\quad} *_[\theta'] t_n$ (2) using the same rules, based on U_0 and such that $\theta' = \theta[V(t_0)]$.

Moreover $WB(t_n, (1)) = WB(t_n, (2))$.

Proof: By induction on the length of the S-narrowing derivation. If (1) writes

$t_0 \xrightarrow{\quad} *_[\theta_{n-1}] t_{n-1} \xrightarrow{\quad} [_{\sigma_n}] t_n$ then by induction hypothesis there exists a S-narrowing derivation $t_0 \xrightarrow{\quad} *_[\theta'_{n-1}] t_{n-1}$ (3) using the same rules, based on U_0 and such that $\theta'_{n-1} = \theta_{n-1}[V(t_0)]$ and $WB(t_{n-1}, (3)) = WB(t_{n-1}, (1))$.

From the property of the maximum commutation, we get the maximum commuted of $t_{n-1} \xrightarrow{\quad} [_{\sigma_n}] t_n$ in (3) that is a S-narrowing derivation $t_0 \xrightarrow{\quad} *_[\theta'_n] t_n$ (2) using the same rules and such that $\theta'_n = \sigma_n \cdot \theta'_{n-1} = \sigma_n \cdot \theta_{n-1}[V(t_0)]$. Moreover (2) is based on U_0 and $WB(t_n, (2)) = WB(t_n, (1))$.

Theorem: Let R be a right-linear term rewriting system, t_0 be a term and U_0 an occurrence set of t_0 . One supposes moreover R is regular or left linear.

If the narrowing derivation $t_0 \xrightarrow{\quad} *_[\theta] t_n$ with θ normalized on $V(t_0)$ is based on U_0 , then there exists a S-narrowing derivation $t_0 \xrightarrow{\quad} *_[\theta] t_n$ using the same rules and based on U_0 .

Proof: The narrowing derivation contains steps of weakly basic rewriting and steps of basic S-narrowing. Since for occurrence sets U, U' , $U \subseteq U'$ implies $WB(U) \subseteq WB(U')$ and $B(U) \subseteq WB(U)$ then the narrowing derivation can be seen as a weakly basic S-narrowing derivation and one applies the previous property.

In some cases, the basic narrowing is included in the basic S-narrowing. It will then be more interesting to use the basic narrowing, and particularly the N-basic narrowing.

Example 9: Consider the example used for the naive basic narrowing (example 1):

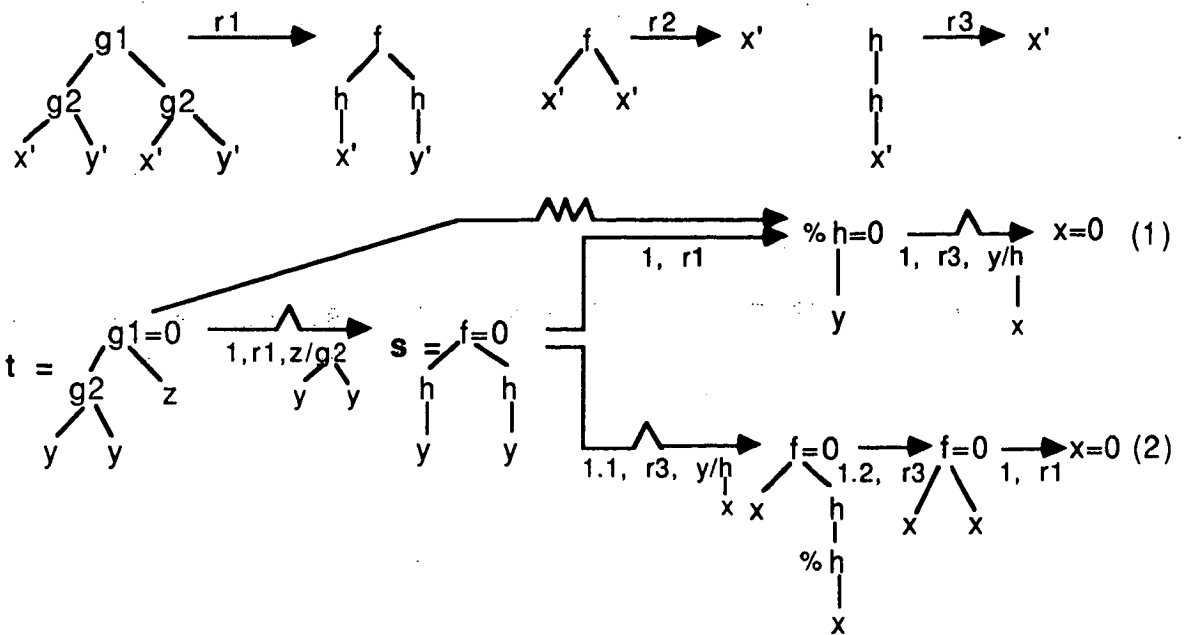

By using basic N-narrowing one obtains the branch (1). One can consider it as a S-narrowing derivation, but then the last step of (1) is not basic, it is only weakly basic. However, by commuting (1) into (2) one obtains an equivalent basic S-narrowing derivation.

The following example shows that the basic N-narrowing may be terminate while the basic S-narrowing doesn't.

Example 10: Let R be the canonical term rewriting system:

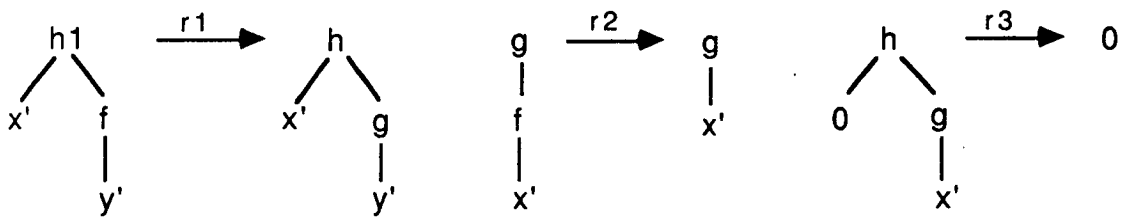

We want solve the equation $h_1(0, x) = 0$. By using basic S-narrowing we have

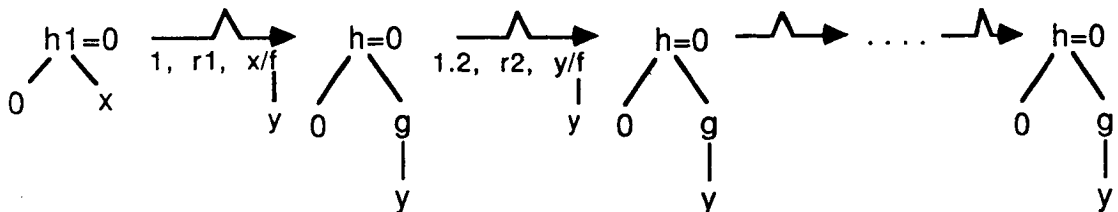

which does not terminate. By using basic N-narrowing the whole tree is reduced to:

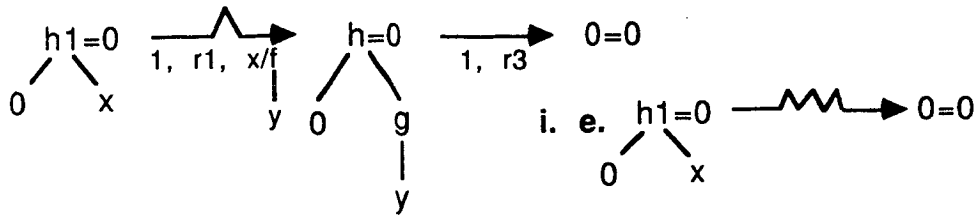

So, we can assure that $\{x / f(y)\}$ is a complete set of R -unifiers of the given equation, while the method using basic S -narrowing does not.

6.3 Comparison between SL-basic N-narrowing and SL-basic S-narrowing

Let R be a left and right linear term rewriting system. One supposes R is linear or for each rule $l \rightarrow r$, $V(r) = V(l)$. Let $t_0 \rightsquigarrow^* t_n$ be a SL-basic N-narrowing derivation. From the previous theorem, we can transform it into a basic S -narrowing derivation $t_0 \rightsquigarrow^* t_n$. But it is not ensured that the intermediate terms of this S -narrowing derivation satisfy the sufficient largeness property. Assume that a term t_i does not, then there is a non basic occurrence v_i such that t_i/v_i is reducible at top by $g \rightarrow d$ using the match θ . Since t_n is in normal form, the subterm t_i/v_i must disappear along the S -narrowing derivation. Then there exists a step $t_j \rightsquigarrow^{[u_j, g_j \rightarrow d_j, \sigma_j]} t_{j+1}$ such that the residual v_j of v_i in t_j (i.e. v_i is an antecedent of v_j) satisfies $v_j = u_j \cdot w$ where $w \in O(g_j)$.

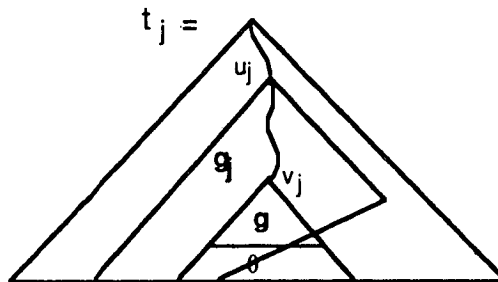

We have: $t_j/v_j = \sigma_{j-1} \dots \sigma_i(t_i/v_i) = \sigma_{j-1} \dots \sigma_i \cdot \theta(g)$ and $\sigma_j(t_j/u_j) = \sigma_j(g_j)$.

Then $\sigma_j \cdot \sigma_{j-1} \dots \sigma_i \cdot \theta(g) = \sigma_j(t_j/v_j) = \sigma_j(g_j/w)$. Thus g overlaps on g_j at the occurrence w . Therefore, if the term rewriting system has no critical pairs, the basic S -narrowing derivation given by the previous theorem satisfies the sufficient largeness property, i.e. is in fact a SL-basic S -narrowing derivation.

Property: Let R be a right linear term rewriting system. One supposes

- R is left linear or for each rule $l \rightarrow r$ of R , $V(r) = V(l)$,
- R has no critical pair.

Then if $t_0 \rightsquigarrow^* [\theta] t_n$ by a SL-basic N-narrowing derivation, then there exists a SL-basic S -narrowing derivation $t_0 \rightsquigarrow^* [\theta'] t_n$ such that $\theta' = \theta[V(t_0)]$.

7 Implementation

We have proved in the previous section that the SL-basic N-narrowing relation is the smallest narrowing relation in some cases. We have implemented it within an experimental version of the rewriting software REVE[15] as a modification of the procedure NARROWER[19]. In order to mark the basic occurrences, we have bound a boolean to each occurrence of term, that we call occurrence indicator. Let us describe the modifications that may be done in NARROWER. Actually which is done in NARROWER is not exactly which we describe because our implementation does not check the sufficient largeness property and considers that an occurrence is basic if the most left antecedent is basic.

Computation of the basic occurrence sets: let us consider a step of weakly basic reduction $t \rightarrow_{[u, g \rightarrow d, \sigma]} t'$ and let us show how the basic occurrences of t' are computed. We have $t' = t[u \leftarrow \sigma(d)]$. Let x be a variable of d that appears at occurrence v' . x appears n times in g at occurrences v_1, \dots, v_n . When the matching process builds the occurrence w of $\sigma(x)$, the occurrences $u \cdot v_1 \cdot w, \dots, u \cdot v_n \cdot w$ of t are examined, and the occurrence indicator of w in $\sigma(x)$ is set to the boolean product of those of $u \cdot v_1 \cdot w, \dots, u \cdot v_n \cdot w$. When g is linear this computation is not more costly than a basic computation.

Test of the sufficient largeness property: consider a basic S-narrowing step $t \rightarrow_{[u, g \rightarrow d, \sigma]} t'$. In order to check whether the basic occurrence set U' of t' is sufficiently large, before building t' we check that the substitution σ is normalized on $[V(t) \cup V(d)]$. If it is the case, we build $\sigma(t)$ for building t' , and verify that $\sigma(t)$ is normalized at all the non basic occurrences of t . Actually, we only test occurrences appearing below some depth, since we know that t is in normal form at the non basic occurrences. Otherwise, we normalize the subterms at the non basic occurrences of t' , which is further more expensive, therefore this test improves the efficiency.

Appendix: denomination of the various narrowings

A reduction is a sequence of rewriting steps, a normalization is a reduction that leads to the normal form.

narrowing relation	definition	denoted in the literature by:
simply narrowing or S-narrowing (denoted by \rightarrow)	more general instantiation and reduction by one rule	narrowing [9]
narrowing (denoted by \rightsquigarrow)	step of S-narrowing followed by a given reduction	
normal narrowing or N-narrowing (denoted by \rightsquigarrow)	step of S-narrowing followed by a normalization	narrowing [1, 2], lazy narrowing [17, 11]
weakly basic S-narrowing	S-narrowing with respect to occurrences obtained by a weakly basic computation	
basic S-narrowing	S-narrowing with respect to occurrences obtained by a basic computation	basic narrowing [9]
basic narrowing	step of basic S-narrowing followed by a given and weakly basic reduction	
basic N-narrowing	step of basic S-narrowing followed by a weakly basic normalization	
SL-basic S-narrowing	step of S-narrowing such that the leaded term satisfies the sufficient largeness property	
SL-basic narrowing	step of SL-basic S-narrowing followed by a given and weakly basic reduction	
SL-basic N-narrowing	step of SL-basic S-narrowing followed by a weakly basic normalization	

References

- [1] M. Fay: "First-Order Unification in an Equational Theory", *Proceedings of the 4th Workshop on Automated Deduction*, pp. 161-167, Austin, Texas, 1979.
- [2] M. Fay: "First-Order Unification in An Equational Theory", *Master Thesis, U. of California At Santa Cruz*, Tech. Report 78-5-002, May 1978.
- [3] J. Goguen and J. Meseguer: "EQLOG: Equality, types, and generic Modules for logic programming", in *Functional and Logic Programming*, D. DeGroot and G. Lindstrom, editors, Springer-Verlag, 1985.
- [4] A. Herold: "Some basic notions of first-order unification theory", *SEKI report SR-83-15*, 1983.
- [5] A. Herold: "Narrowing techniques applied to idempotent unification", *SEKI report SR-86-16*, August 1986.
- [6] G. Huet: "Résolution d'équations dans les langages d'ordre $1,2,\dots,\omega$ ", *Thèse d'état*, Université de Paris VII, 1976.
- [7] G. Huet and J.J. Levy: "Call by need Computations in Non-ambiguous Linear Term Rewriting Systems", *INRIA Laboria, report 359*, 1979.
- [8] G. Huet and D. Oppen: "Equations and Rewrite Rules: A Survey", in *Formal Language Theory: Perspectives and Open Problems*, ed. Book R, Academic Press, 1980.
- [9] J.M. Hullot: "Canonical Forms And Unification", *Proceedings of the Fifth Conference on Automated Deduction*, Lecture Notes in Computer Science, vol 87, pp. 318-334, Springer Verlag, Les Arcs, France, July 1980.
- [10] J.M. Hullot: "Compilation de Formes Canoniques dans les Théories Equationnelles", *Thèse de 3ème Cycle*, Université de Paris Sud, 1980.
- [11] A. Josephson and N. Dershowitz: "Efficient Implementation of Narrowing: the RITE way", in *Proceedings of the International Conference of Logic Programming*, Salk Lake City, 1986.
- [12] J-P. Jouannaud, C. Kirchner, H. Kirchner: "Incremental Construction of Unification Algorithms in Equational Theories", in *Proceedings of the International Conference On Automata, Languages and Programming*, Lecture Notes in Computer Science, vol. 154, pp. 361-373, Springer Verlag, Barcelona, 1983.
- [13] C. Kirchner: "Méthodes et outils de conception systématique d'algorithmes d'unification dans les théories équationnelles", *Thèse de doctorat d'Etat*, Université de Nancy I, 1985.
- [14] H. Kirchner: "Preuves par complétion dans les variétés d'algèbres", *Thèse de doctorat d'Etat*, Université de Nancy I, 1985.
- [15] P. Lescanne: "Computer experiments with the REVE term rewriting system generator", in *10th ACM Conf. on Principles of Programming Languages*, pp. 99-108, Austin Texas, January 1983.
- [16] G. Plotkin: "Building-in Equational Theories", in *Machine Intelligence*, vol. 7, pp. 73-90, 1972.

- [17] U.S. Reddy: "On the relationship between logic and functional languages", in *Logic Programming: Relations, Functions, and Equations*, D. DeGroot and G. Lindstrom, eds. Prentice Hall, Englewood Cliffs, NJ, 1985.
- [18] P. Réty, C. Kirchner, H. Kirchner, and P. Lescanne: "NARROWER: An algorithm for unification based on narrowing", *CRIN report 86-R-131*, 1986.
- [19] P. Réty, C. Kirchner, H. Kirchner, and P. Lescanne: "NARROWER: A new Algorithm for Unification and its application to Logic Programming", *Proc. 1rst Conf. on Rewriting Techniques and Applications*, Lecture Notes in Computer Science, vol. 202, pp. 141-157, Springer Verlag, Dijon France, 1985.
- [20] J.R. Slagle: "Automated theorem-proving for theories with simplifiers, commutativity and associativity", *J. of ACM*, vol 21, pp. 622-642, 1974.
- [21] G. Smolka: "Order-sorted Horn logic semantics and deduction", *Universitat Kaiserslautern*, Internal report, September 1986.

Imprimé en France

par

l'Institut National de Recherche en Informatique et en Automatique

