



**HAL**  
open science

## On active contour models

Laurent D. Cohen

► **To cite this version:**

| Laurent D. Cohen. On active contour models. RR-1075, INRIA. 1989. inria-00075484

**HAL Id: inria-00075484**

**<https://inria.hal.science/inria-00075484>**

Submitted on 24 May 2006

**HAL** is a multi-disciplinary open access archive for the deposit and dissemination of scientific research documents, whether they are published or not. The documents may come from teaching and research institutions in France or abroad, or from public or private research centers.

L'archive ouverte pluridisciplinaire **HAL**, est destinée au dépôt et à la diffusion de documents scientifiques de niveau recherche, publiés ou non, émanant des établissements d'enseignement et de recherche français ou étrangers, des laboratoires publics ou privés.

# INRIA

UNITÉ DE RECHERCHE  
INRIA-ROCCUENCOURT

Institut National  
de Recherche  
en Informatique  
et en Automatique

Domaine de Voluceau  
Rocquencourt  
BP 105  
78153 Le Chesnay Cedex  
France  
Tél (1) 39 63 55 11

## Rapports de Recherche

N° 1075

*Programme 6*  
*Robotique, Image et Vision*

### ON ACTIVE CONTOUR MODELS

**Laurent D. COHEN**

**Août 1989**



\* R R - 1 0 7 5 \*

# On Active Contour Models

Laurent D. COHEN

INRIA, Domaine de Voluceau, Rocquencourt

B.P. 105, 78153 Le Chesnay Cedex, France.

Email: [cohen@bora.inria.fr](mailto:cohen@bora.inria.fr)

Tel.1-39 63 53 66

## Abstract

The use of deformable models to extract features of interest in images has been introduced by Kass *et al*, known as snakes or energy-minimizing curves. We present a model of deformation which can solve some of the problems encountered with the original method. The external forces applied on the curve deriving from the image and pushing to the high gradient regions are modified to give more stable results.

The original "snake" model, when it is not submitted to any external force will find its equilibrium by vanishing either to a point or to a line according to the boundary conditions. Also a snake which is not close enough to contours will not be attracted. We define a new model of Active Contour which makes the curve  $v(s) = (x(s), y(s))$  behave well for these cases.

The equation we solve is :

$$\frac{\partial v}{\partial t} - \frac{\partial}{\partial s} \left( w_1 \frac{\partial v}{\partial s} \right) + \frac{\partial^2}{\partial s^2} \left( w_2 \frac{\partial^2 v}{\partial s^2} \right) = f_1(v) + f_2(v)$$

where  $f_1$  is derived from the image to attract the curve to edges, and  $f_2$  is an internal force which simulates a pressure force. The initial data  $v_0$  needs no more to be too much close to the solution to converge. The curve behaves like a balloon which is blown up. When it passes by edges, it is stopped if the contour is strong, or passes through if the contour is too weak.

We give examples of results of the new algorithm applied to medical images to extract a ventricle.

## A propos des Modèles de Contours Actifs

### Résumé

L'utilisation des modèles déformables pour extraire des caractéristiques dans les images a été introduite par Kass *et al*, sous le nom de "snakes" (serpents) ou courbes minimisantes. Nous présentons un modèle de déformation qui résoud certains des problèmes rencontrés avec la méthode originale. Les forces extérieures appliquées sur la courbe dérivant de l'image et poussant vers les régions de fort gradient sont modifiées pour donner des résultats plus stables.

le modèle original des "serpents", lorsqu'il n'est soumis à aucune force extérieure trouvera l'équilibre en se réduisant, soit à un point, soit à un segment de droite, suivant les conditions aux limites. Aussi, un "serpent" qui n'est pas suffisamment proche d'un contour ne sera pas attiré. On définit un nouveau modèle de contour actif tel que la courbe  $v(s) = (x(s), y(s))$  se comporte bien dans ces cas.

L'équation que l'on résoud est :

$$\frac{\partial v}{\partial t} - \frac{\partial}{\partial s} \left( w_1 \frac{\partial v}{\partial s} \right) + \frac{\partial^2}{\partial s^2} \left( w_2 \frac{\partial^2 v}{\partial s^2} \right) = f_1(v) + f_2(v)$$

où  $f_1$  dérive de l'image pour attirer la courbe vers les contours, et  $f_2$  est une force interne qui simule une force de pression. La donnée initiale  $v_0$  n'a plus besoin d'être trop proche de la solution pour converger. La courbe se comporte comme un ballon qui est gonflé. Lorsqu'elle passe par des points de contour, elle est arrêtée si le contour est solide, ou passe par dessus s'il est trop faible.

Nous donnons des exemples de résultats du nouvel algorithme appliqué à des images médicales pour extraire un ventricule .

## 1 Introduction

The use of deformable models to extract features of interest in images has been introduced by Kass *et al* [4], known as snakes or energy-minimizing curves.

We are looking for mathematical entities which describe the shapes of objects appearing in images. We suppose the objects we are looking for are smooth. So, the curve has to be at the same time a “nice” curve and localized at the interesting places.

We thus define a model of an elastic deformable object as in [4]. The model is put on the image by the action of “external forces” which move and deform it from its initial position to stick it for the best to the desired attributes in the image.

We are interested in the extraction of good edges. We draw a simple curve close to the intended contours and the action of the image forces will push the curve the rest of the way. The final position corresponds to the equilibrium reached at the minimum of its energy.

The external forces are derived from the image data or imposed as constraints. Internal forces define the physical properties of the object.

We present a model of deformation which can solve some of the problems encountered with the original method. The external forces applied on the curve deriving from the image and pushing to the high gradient regions are modified to give more stable results.

The original “snake” model, when it is not submitted to any external force will find its equilibrium by vanishing either to a point or to a line according to the boundary conditions. Also a snake which is not close enough to contours will not be attracted. We define a new model of Active Contour which makes the curve behave well in these cases.

The curve behaves like a balloon which is blown up. When it passes by edges, it is stopped if the contour is solid, or passes through if the contour is too weak.

After recalling in the next section the main ideas of “snakes” ([4]), the following section gives the new aspects of our method. Finally we give applications of this technique to feature extraction in medical images.

## 2 Energy Minimizing Curves

### 2.1 Active contour Model

Snakes are a special case of deformable models as presented in [7]. The contour model of deformation is a mapping :

$$\begin{aligned}\Omega &= [0, 1] \rightarrow \mathfrak{R}^2 \\ s &\mapsto v(s) = (x(s), y(s))\end{aligned}$$

We define a deformable model as a space of admissible deformations  $Ad$  and a functional  $E$  to minimize which represents an energy of the following form:

$$\begin{aligned}E &: Ad \rightarrow \mathfrak{R} \\ v &\mapsto E(v) = \int_{\Omega} w_1 |v'|^2 + w_2 |v''|^2 + P(v) ds\end{aligned}$$

where  $P$  is the potential associated to the external forces. In the following, the admissible deformations  $Ad$  is restricted by the boundary conditions  $v(0)$  and  $v(1)$  given. We can also use periodic curves or other types of boundary conditions. It is computed as a function of the image data according to the goal aimed. For example, to be attracted by edge points, the potential depends on the gradient of the image.

The mechanical properties of the model are defined by the functions  $w_j$ . Their choice determines the elasticity and rigidity of the model.

The energy can be written as the sum of three terms:

$$E = E_{int} + E_{image} + E_{ext}$$

$v$  is a minimum for  $E$  if it verifies the associated Euler equation:

$$-(w_1 v')' + (w_2 v'')'' + \nabla P = 0$$

$v(0)$  and  $v(1)$  being given.

In this formulation each term appears as a force applied to the curve. A solution can be seen either as realizing the equilibrium of forces of the equation or reaching the minimum of its energy.

Thus the curve is under control of three forces:

- $E_{int}$  represents internal forces which impose the regularity of the curve.  $w_1$  and  $w_2$  impose the elasticity and rigidity of the curve.
- $E_{image}$  pushes the curve to the significative lines which correspond to the desired attributes. It is defined by a potential of the shape

$$P(v) = -|\nabla I(v)|^2.$$

The curve is then attracted by the local minima of the potential, which means the local maxima of the gradient, that is contours.

- $E_{ext}$  imposes constraints defined by the user.

## 2.2 Numerical Resolution

We discretize the equation by finite differences. The equation:

$$-(w_1 v')' + (w_2 v'')'' = F(v),$$

where  $F$  is the sum of forces, becomes after finite differences in space (step  $h$ ):

$$\begin{aligned} & a_i(v_i - v_{i-1}) - a_{i+1}(v_{i+1} - v_i) + \\ & b_{i-1}(v_{i-2} - 2v_{i-1} + v_i) - 2b_i(v_{i-1} - 2v_i + v_{i+1}) + b_{i+1}(v_{i+2} - 2v_{i+1} + v_i) - \\ & (F_1(v_i), F_2(v_i)) = 0 \end{aligned}$$

where we defined  $v_i = v(ih)$ ;  $a_i = w_1(ih)$ ;  $b_i = w_2(ih)$ .

This can be written in matrix form :

$$Av = F$$

where  $A$  is pentadiagonal.

We find a solution of the static problem by solving the associated evolution equation

$$\frac{\partial v}{\partial t} - (w_1 v')' + (w_2 v'')'' = F(v)$$

$$v(0, s) = v_0(s)$$

$$v(t, 0) = v_0(0) \quad v(t, 1) = v_0(1)$$

which becomes after finite differences in time (step  $\tau$ ) and space (step  $h$ ):

$$v^t = (Id + \tau A)^{-1}(v^{t-1} + \tau F(v^{t-1}))$$

Thus, we obtain a linear system and we have to inverse a pentadiagonal symmetric positive matrix.

### 3 Details of our Model

Resolving the formulation described in the previous section leads to two difficulties for which we give solutions in this section. In both cases we give a new definition of the present forces focusing on the evolution equation formulation even though the forces no longer derive from a potential.

#### 3.1 Instability due to image forces

Let us examine the effect of the image force as defined in the previous section  $F = -\nabla P$ . The direction of  $F$  is the steepest descent for  $P$ , which is natural since we want to get a minimum of  $P$  and equilibrium is achieved at points where  $P$  is a minimum in the direction normal to the curve.

However, due to the discretization of the evolution problem, even though the initial guess can be close to an edge, instabilities can happen. The position at time  $t$ ,  $v^t$  is obtained after moving  $v^{t-1}$  along vector  $\tau F(v^{t-1})$  and then inverse the system, which can be seen as regularizing the curve. This leads to a few remarks :

- **Time discretization:** if  $\tau F(v^{t-1})$  is too large the point  $v^{t-1}$  can be moved too far across the wished minimum and never come back (see figure 1). So the curve can pass through the edge and then make large oscillations without reaching equilibrium.

If we choose  $\tau$  small enough so the move is never too large, for example never larger than a pixel size, then small  $F$  will not have effect on the curve and only very few high gradient points will attract the curve. So instead of acting on the time step, we modify the force by normalizing it, taking  $F = -k \frac{\nabla P}{\|\nabla P\|}$ , where  $k$  is of the order of the pixel. Now, it has the inverse effect that lower and larger forces have the same influence on the curve. This is not a difficulty since in any case the points on the curve find their equilibrium at local minima of the potential, that is edge points.



- **space discretization:** if the force  $F$  is known only on a discret grid, corresponding to the image, there can be a zero crossing without any zero in the grid. This means that in the best case a point will always oscillate between the neighbor pixels of the minimum (see figure 2). This problem is simply solved by linear interpolation of  $F$  at non integer positions.
- If an image of edges is available, for example if the image is given together with its Canny detected edge image, we would like the curve to be attracted by these already detected edges. For this we define attraction forces by simulating a potential defined by convolution of the binary edge image and a gaussian. This can be either used as the only image forces or together with a gradient image to enforce the detected edges.

Remark that even though the equation changed, the curve is still pushed to minimize the potential and the energy.

We give below examples of results applying this method first to a drawn line and then to medical images. In figure 3, we remark how the corners are smoothed due to the regularization effect. The corner on the left seems to be better but it is due to the discretization to superimpose the curve on the image, it is more precise in the horizontal-vertical corner than in the rotated one.

In figure 4, the above image is taken from a time sequence of ultrasound images during a cardiac cycle and the problem is to detect and follow the deformation of the valve. As told above, we used the Canny detector ([2]) implemented recursively by Deriche ([3]) to compute the image gradient. The other image is a slice from a 3D NMR image in the heart area. We want to extract the left ventricle. We use here the 3D edge detector ([5]) obtained by generalization of the 2D Canny-Deriche filter.

### 3.2 Localization of the initial guess. The balloon Model

To make the snake find its way, an initial guess of the contour has to be provided manually. This has many consequences on the evolution of the curve.

- If the curve is not close enough to a contour, it is not attracted by it (see figure 5).
- If the curve is not submitted to any forces, it shrinks on itself (see figure 6).

The finite difference formulation of the problem makes the curve behave like a set of masses linked by zero length strings. This means that if there is no image force ( $F = 0$ ), the curve shrinks on itself and vanishes to a point or a line depending on the boundary conditions. This happens if the initial curve or part of it is placed in a constant area.

Suppose we have an image of a black rectangle on a white background and a curve is placed inside the rectangle. Even though we have a perfect edge detection, the curve will vanish. If a point is close enough to an edge point, it is attracted and a neighborhood of this point comes to stick to the edge. If there are enough such points, eventually the rest of the curve follows the edge little by little. On the contrary, if the initial curve is surrounding the rectangle, even if it is far from the edges, its natural way is to shrink and by the way it sticks to the rectangle.

Let us also note that it often happens, due to noise, that an isolated point is a gradient maximum and it stops the curve when it passes by.

All these remarks suggest to add to the forces another one which will make the contour more dynamic. We now consider our curve as a balloon (in 2D) that we blow out. From an initial oriented curve we add to the previous forces a pressure force pushing outside as if we introduced air inside. The curve then expands and is stopped and attracted by edges as before. But if the edge is too weak, since there is a pressure force, the curve can pass through the edge if it is a singularity with regard to the rest of the curve being blown out. In case of the rectangle above, removing some edges and adding some "noise" to the gradient image, starting from a small curve, we obtain the whole rectangle (see figure 7). When passing by the noise dots in the rectangle the curve is stuck to the point. But since on its two sides the curve is expanding, the edge dot becomes a singular point of the curve and it is removed by the regularization effect after a few iterations.

## 4 Applications and future directions

In case we have an initial curve detected which is known as being interior to the object, our technique is particularly efficient. For example, we are looking for the boundary of a cavity in a Ultrasound image of the heart. An approximation of the cavity is given by a mathematical morphology method and we know that it is inside the real cavity. By taking the approached boundary as initial value for  $v$ , we expand it and it comes to stick more precisely to the cavity boundary ( see figure 8).

We give another application to the same problem as before in figure 4, but we now take a curve which is not close to the ventricle, neither in shape nor in position. We obtain the same final result (figure 9) as before but it takes more iterations.

The orientations of our research once this extraction is done is to follow the contour from one slice to the other, then having a set of contours, rebuild a 3D surface as in [1] where the curves were extracted by hand on each slice using an image of edges. The following step is to follow the deformation in time of this surface. It can be done either slice by slice or globally by generalizing this work to a 3D surface model which should be a real ballon since the active contour model is a particular case of deformable models as seen in [6]

We can add internal forces to control the deformation to follow the contours. This is the case if we know a physical model of the desired object (for example, to follow the deformation of a ventricle during a cycle), or to make the curve expand or collapse from the initial data using some knowledge of the deformation.

## 5 conclusion

We presented a model of deformation which can solve some of the problems encountered with the "snake" model of [4]. We modified the definition of external forces deriving from the gradient of the image to obtain more stable results. On the other hand, we introduced a pressure force which make the curve behave like balloon. This permits to give an initial guess of the curve which is not too much close to the result. We show promising results on NMR and ultrasound images. This method is currently tested

for many applications in medical imaging. Our main goal is to generalize this method to obtain surface edges in a 3D image.

## References

- [1] N. Ayache, J.D. Boissonnat, E. Brunet, L. Cohen, J.P. Chièze, B. Geiger, O. Monga, J.M. Rocchisani, and P. Sander. Building highly structured volume representations in 3d medical images. In *Computer Aided Radiology*, 1989. Berlin, West-Germany.
- [2] John Canny. A computational approach to edge detection. *IEEE Transactions on Pattern Analysis and Machine Intelligence*, PAMI-8(6):679–698, November 1986.
- [3] Rachid Deriche. Using canny’s criteria to derive a recursively implemented optimal edge detector. *International Journal of Computer Vision*, 167–187, 1987.
- [4] Michael Kass, Andrew Witkin, and Demetri Terzopoulos. Snakes: active contour models. In *Proceedings of the First International Conference on Computer Vision*, pages 259–268, London, June 1987.
- [5] O. Monga and R. Deriche. 3d edge detection using recursive filtering. application to scanner images. In *IEEE Computer Society Conference on Vision and Pattern Recognition*, San Diego, June 1989.
- [6] Demetri Terzopoulos. The computation of visible-surface representations. *IEEE Transactions on Pattern Analysis and Machine Intelligence*, PAMI-10(4):417–438, July 1988.
- [7] Demetri Terzopoulos. *On matching Deformable Models to Images*. Technical Report 60, Schlumberger Palo Alto Research, November 1986.

## 6 Figures

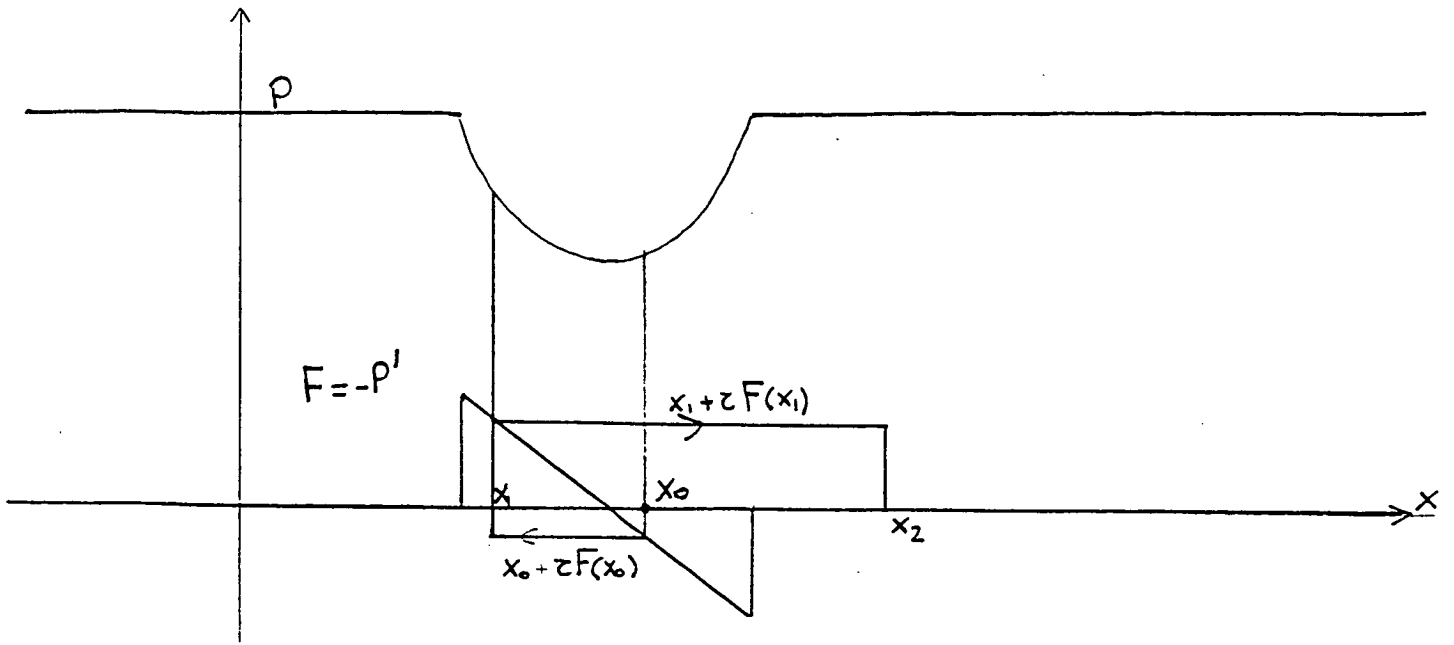

Figure 1: instability due to time discretization

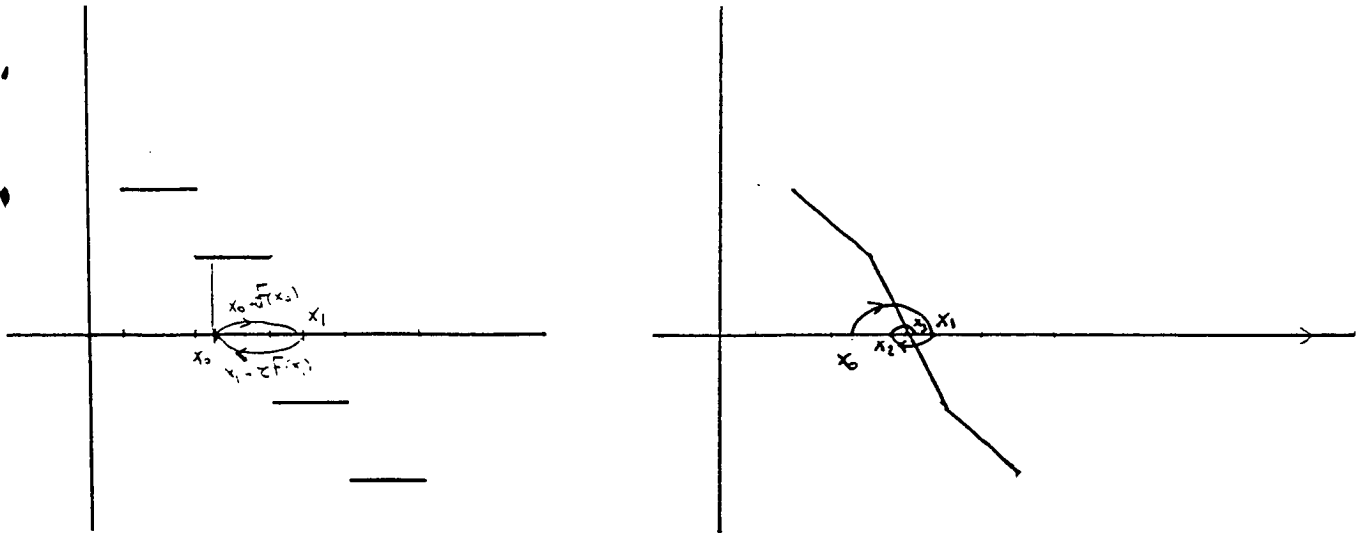

Figure 2: instability due to space discretization. On the left, with the discrete force there is no equilibrium point. On the right, after interpolation, there is convergence after oscillation.

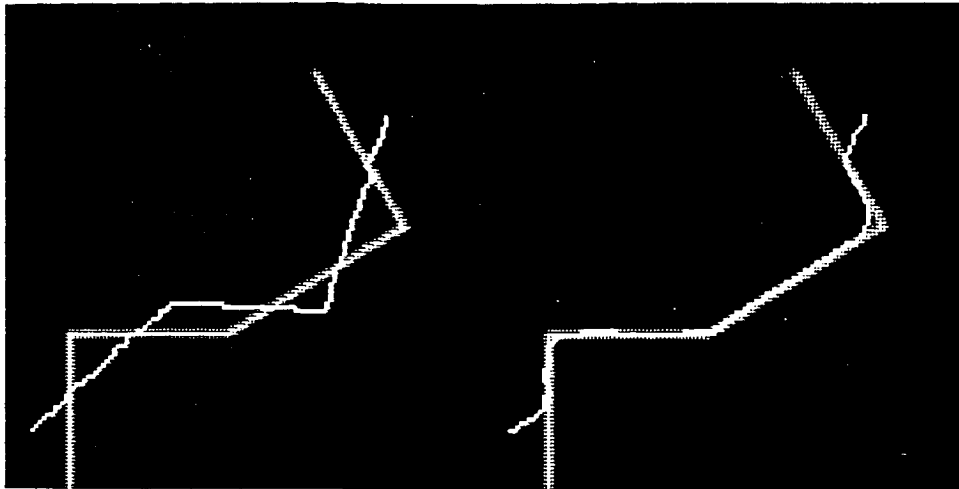

Figure 3: left: initial curve, right: result

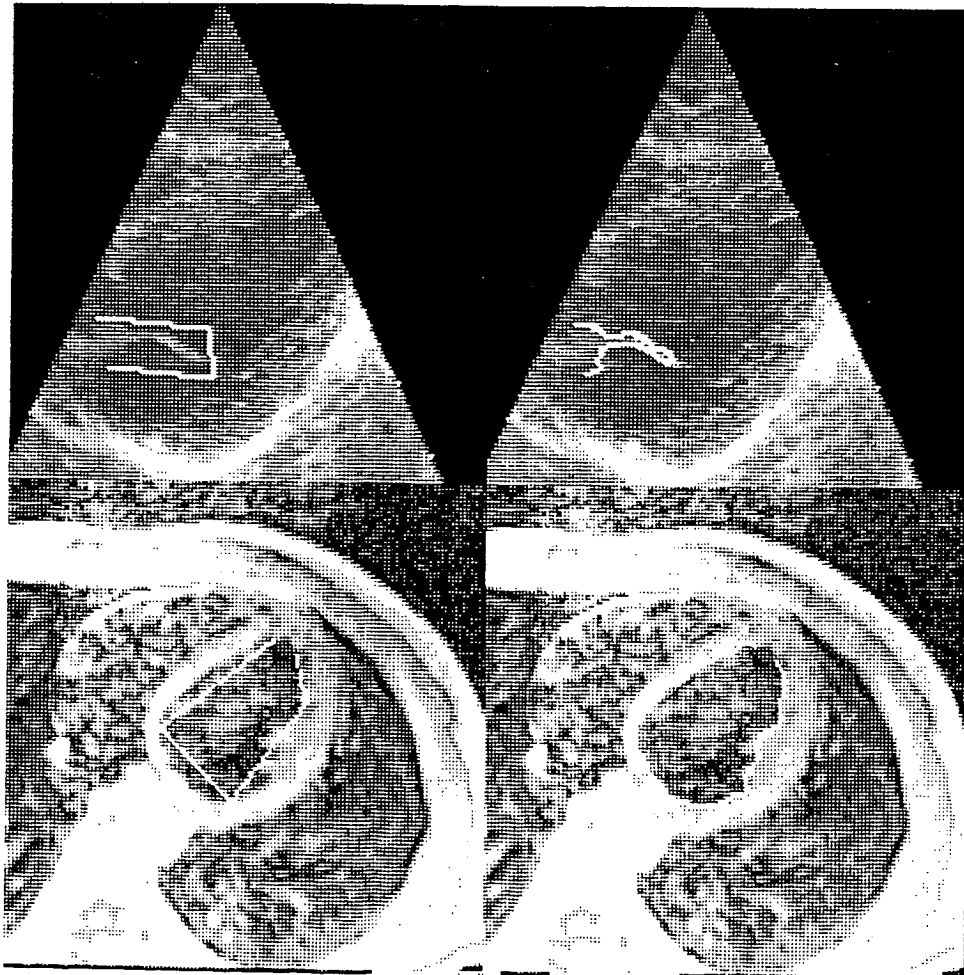

Figure 4: Above: Ultrasound image. left: initial curve, right: the valve is detected. Below: NMR image of the heart. left: initial curve, right: the ventricle is detected

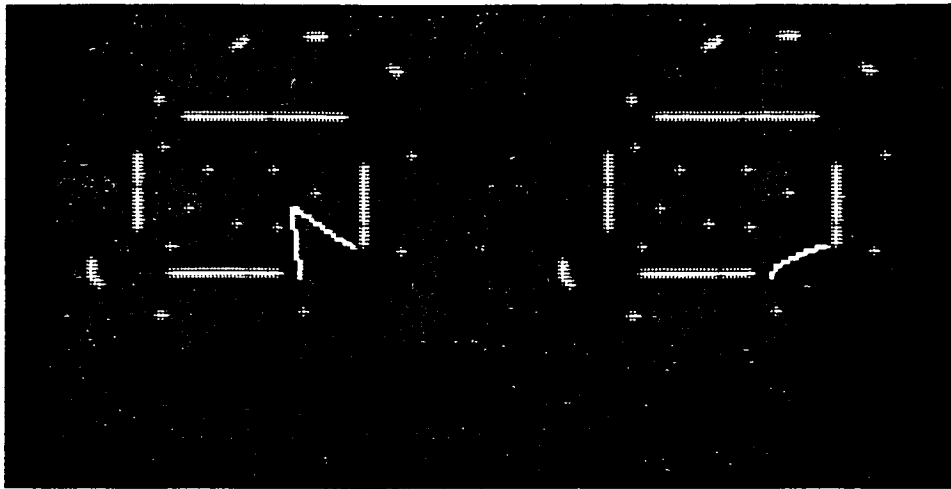

Figure 5: rectangle. left: initial curve, right: result is only due to regularization

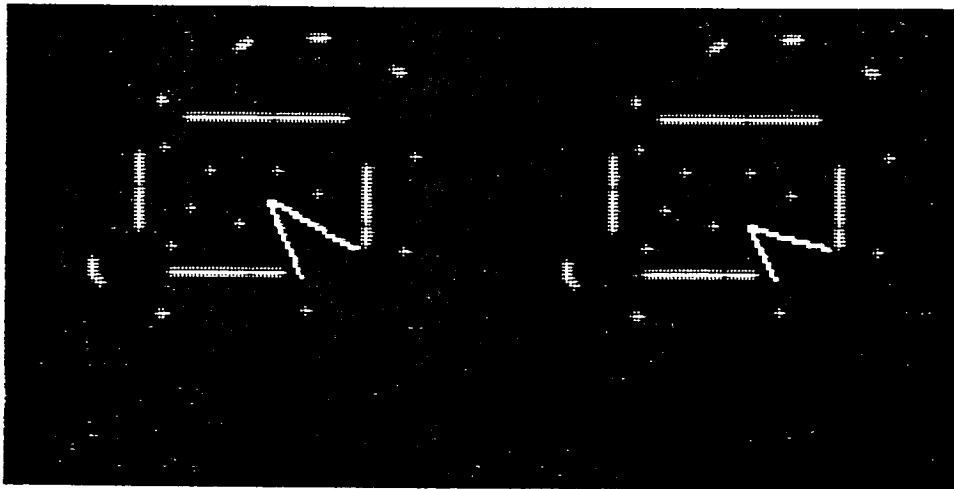

Figure 6: rectangle. left: initial curve, right: result is stopped at one edge point.

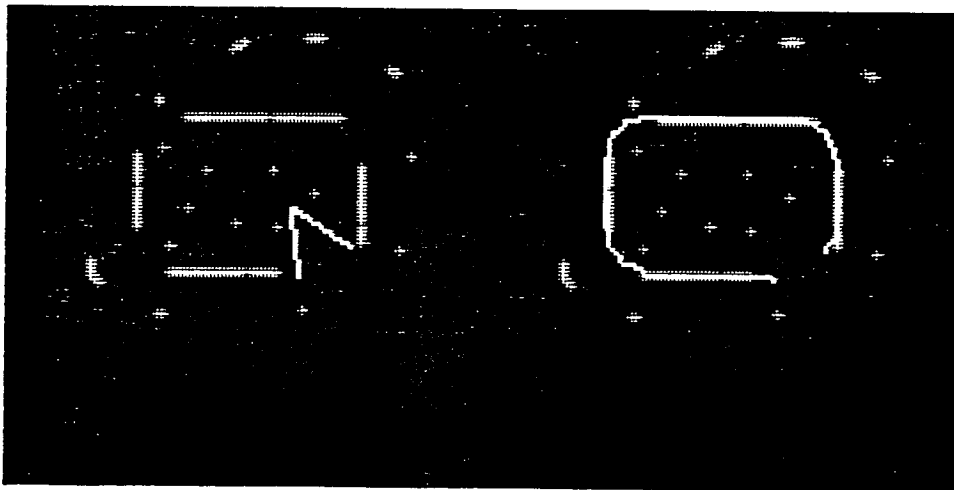

Figure 7: rectangle. left: initial curve, right: result after blowing the balloon

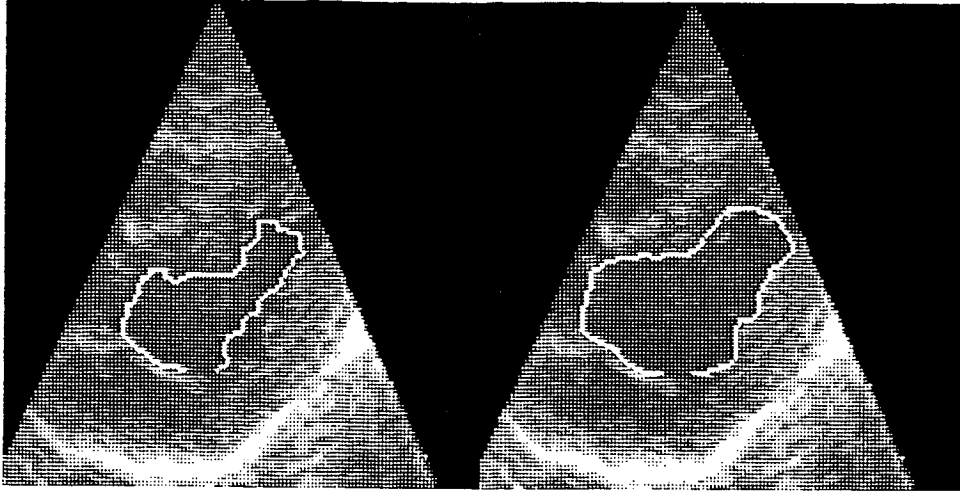

Figure 8: Ultrasound image. left: initial cavity, right: result

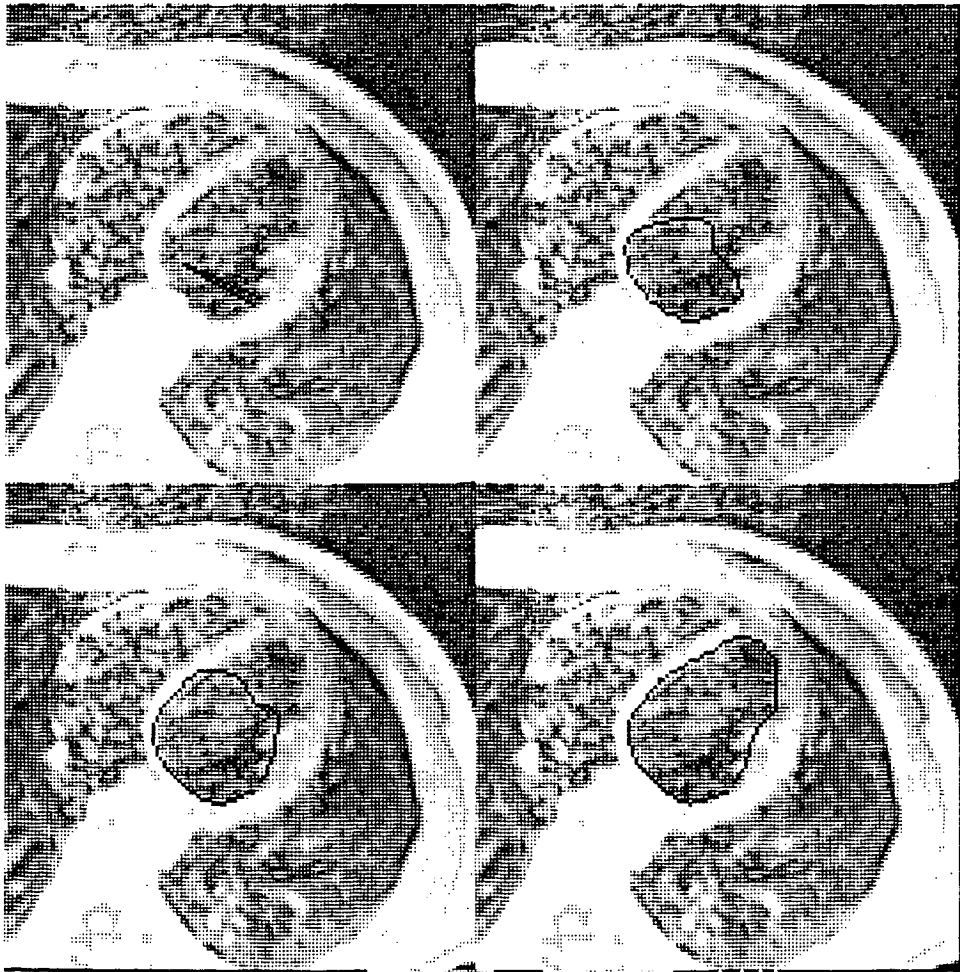

Figure 9: NMR image. Evolution of the balloon curve to detect the left ventricle



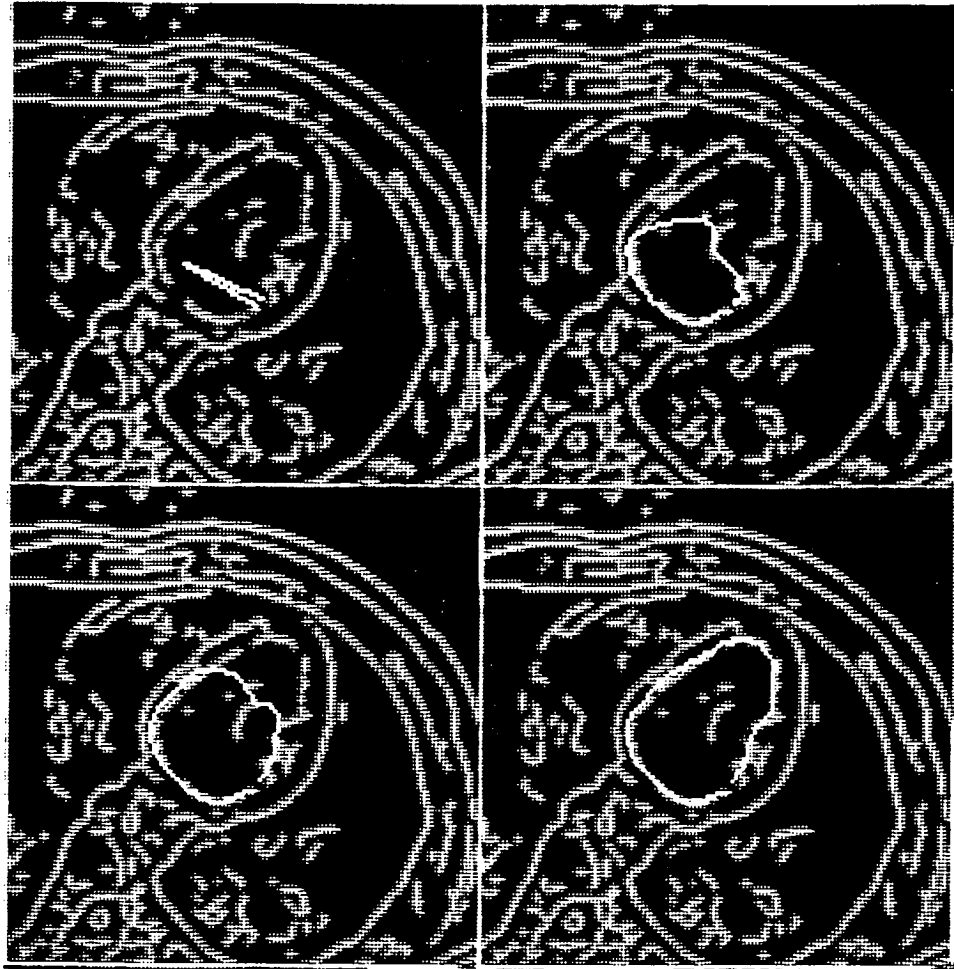

Figure 10: NMR image. Evolution of the balloon curve to detect the left ventricle superimposed on the potential image.

