



HAL
open science

Numerical study of an intrinsic component mode synthesis method

Frédéric Bourquin, Frédéric d’Hennezel

► **To cite this version:**

Frédéric Bourquin, Frédéric d’Hennezel. Numerical study of an intrinsic component mode synthesis method. [Research Report] RR-1329, INRIA. 1990. inria-00075231

HAL Id: inria-00075231

<https://inria.hal.science/inria-00075231>

Submitted on 24 May 2006

HAL is a multi-disciplinary open access archive for the deposit and dissemination of scientific research documents, whether they are published or not. The documents may come from teaching and research institutions in France or abroad, or from public or private research centers.

L’archive ouverte pluridisciplinaire **HAL**, est destinée au dépôt et à la diffusion de documents scientifiques de niveau recherche, publiés ou non, émanant des établissements d’enseignement et de recherche français ou étrangers, des laboratoires publics ou privés.

INRIA

UNITÉ DE RECHERCHE
INRIA-ROCQUENCOURT

Institut National
de Recherche
en Informatique
et en Automatique

Domaine de Voluceau
Rocquencourt
B.P.105
78153 Le Chesnay Cedex
France
Tél.: (1) 39 63 55 11

Rapports de Recherche

N° 1329

*Programme 7
Calcul Scientifique,
Logiciels Numériques et Ingénierie Assistée
par Ordinateur*

NUMERICAL STUDY OF AN INTRINSIC COMPONENT MODE SYNTHESIS METHOD

Frédéric BOURQUIN
Frédéric D'HENNEZEL

Novembre 1990



★ R R - 1 3 2 9 ★

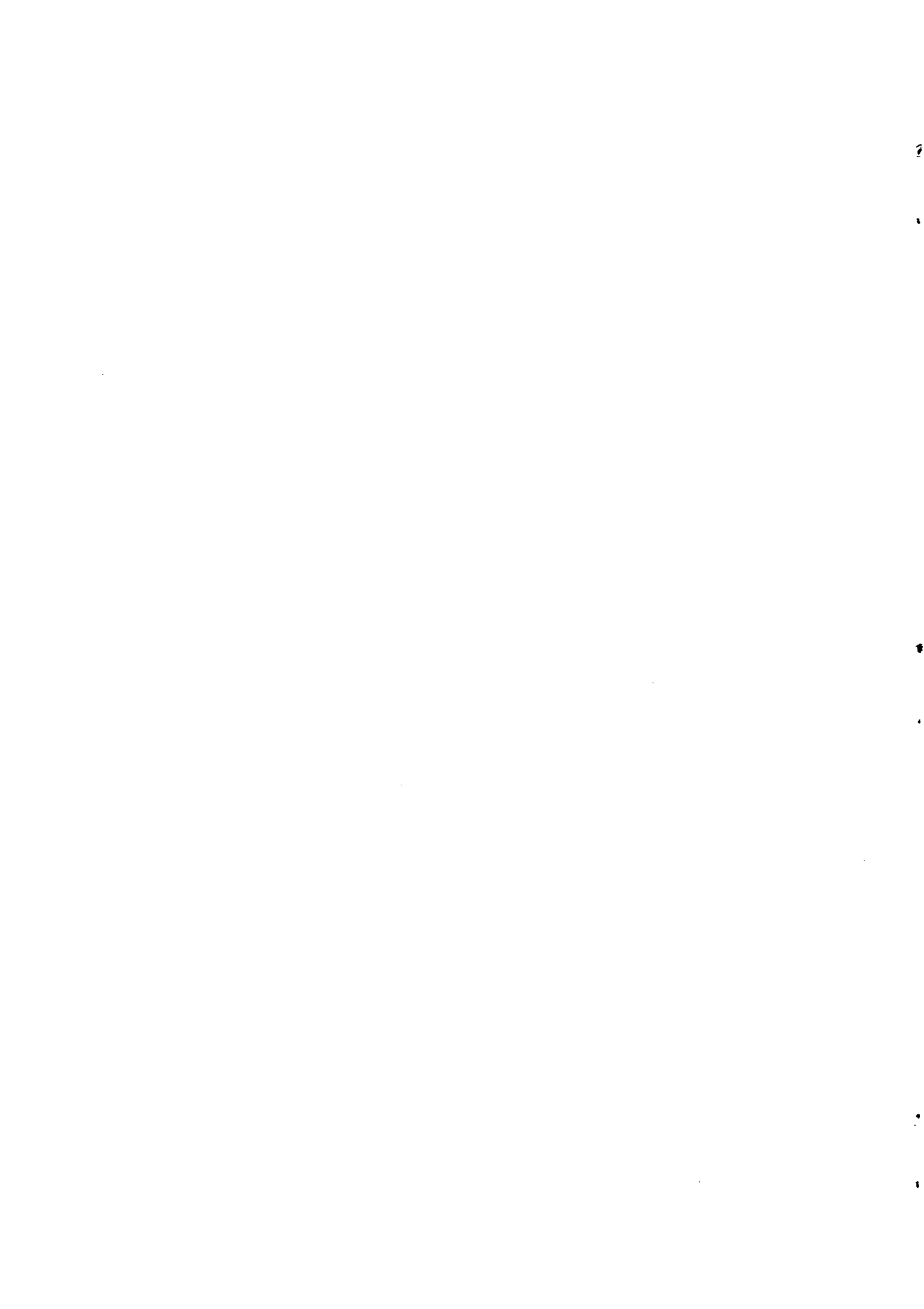

Numerical study of an intrinsic component mode synthesis method *

Frédéric Bourquin
Laboratoire Mixte LCPC/CNRS,
Laboratoire des Matériaux et Structures du Genie Civil,
Laboratoire Central des Ponts et Chaussées,
58 Bd Lefebvre, 75015 Paris, France.

Frédéric d'Hennezel
Institut National de Recherche en Informatique et Automatique,
Domaine de Voluceau, Rocquencourt,
B.P. 105, 78153 Le Chesnay Cedex, France.

October 24, 1990

*To appear in 1991 in Computer Methods in Applied Mechanics and Engineering

Numerical study of an intrinsic component mode synthesis method

Abstract.

Component mode synthesis belongs to the class of Galerkin methods and enables to compute the normal modes of linearly elastic structures that can be divided into several substructures whose lowest eigenfrequencies and corresponding normal modes are known. Energy transfer between substructures is achieved thanks to the introduction in the Ritz procedure of mode shapes defined on the whole structure and usually called “static modes” or “constraint modes”. A new fixed interface method is presented in a continuous framework: it is based on a non-conventional choice of constraint modes tied to the normal modes of the Poincaré-Steklov operator associated with the interface between the substructures. Error bounds are given in the case of three-dimensional elasticity. An efficient domain decomposition algorithm is presented in details as well as various tests.

Etude numérique d’une méthode intrinsèque de synthèse modale

Résumé.

La synthèse modale est une méthode de Galerkin qui permet de calculer les modes propres de structures élastiques qui peuvent être décomposées en plusieurs sous structures dont les fréquences propres et les modes propres associés sont connus. Le couplage entre les sous structures est pris en compte dans la procédure de Ritz par l’introduction de modes de vibration définis sur toute la structure et communément appelés “modes statiques” ou “modes contraints”. Une nouvelle méthode à interface fixe est présentée: elle est basée sur le choix d’un nouveau type de modes statiques, liés aux modes propres de l’opérateur de Poincaré-Steklov associé à l’interface entre les sous structures. Des estimations d’erreurs sont données dans le cadre de l’élasticité tridimensionnelle. Un algorithme de décomposition de domaine est décrit en détail et différents tests numériques sont présentés.

1 Introduction.

The dynamics of a structure behaving linearly and undergoing an arbitrary variable load is entirely determined by its free vibrations and its initial state thanks to the modal superposition principle. But the computation of the needed normal modes gives rise to a number of practical difficulties, especially if repeated analyses are required, or when the structure is made of a large number of components connected together, which may differ among themselves, as far as mechanical or geometrical properties are concerned. For example, space vehicles can be viewed as a set of interconnected substructures, like launchers, payloads and appendages that are usually much smaller and lighter than the main body. In the same way, off-shore oil extraction facilities, as well as satellites, are composed of trusses, plates... The same can be said about cars, ships or modern slender bridges, that in addition make an essential use of cables. Moreover, the mechanical description of such multi-structures by means of partial differential equations often leads to somewhat mathematically complicated models (see Aufranc [1990a,1990b], Bernadou & Fayolle & Léné [1988], Bourquin & Ciarlet [1989], Ciarlet [1990], Ciarlet & Le Dret & Nzenwa [1989], Le Dret [1989]...). Their often clear decomposition in much simpler components suggests to start to analyze the latter under static or dynamic load, and then to take into account in the analysis of the entire structure the behaviour of each component considered as isolated from the other ones. Component mode synthesis takes advantage of this idea, and therefore belongs to the wide class of domain decomposition techniques.

Component mode synthesis has become a very popular numerical tool in aerospace engineering in the last two decades because it usually meets high standards of computational efficiency and versatility. For example, it allows to perform cheap parametric studies such as structural optimization against vibrations, since geometrical or thermomechanical perturbations of one substructure do not affect the free vibrations of the other ones, thus it makes recomputations very easy. Versatility can also be illustrated by the possibility to include experimental tests performed on several of the substructures. Therefore, the technique fits in the framework of large aerospace projects for which industrial substructuring is naturally imposed by the multiplicity of contractors in charge of realizing the different parts of the whole structure.

Of course, dynamic substructuring is not restricted to the field of linear structural analysis, and various applications can be thought of, such as fluid-structure interaction (see Morand & Ohayon [1979], Valid & Ohayon [1974]), soil-structure interaction, music synthesis, optimization against buckling (see Valid [1982]).

From a purely numerical point of view, significant cost savings can be realized when remeshing is needed, since this task can be done locally, i.e. on each substructure separately. But substructuring may also lead to an impressive computer cost reduction at the stage where the global normal modes are computed, as well as to memory savings. Furthermore, the method obviously inherits "coarse grain" parallelizability and may recover increased attractiveness with current rapid development of parallel computer architectures.

There exists a lot of methods based on the idea sketched above. They essentially depend on the boundary conditions that are imposed on the interface to define the normal modes of each substructure, and on the way to couple the latter.

The first one, proposed by Hurty [1965], Craig & Bampton [1968], is based on “fixed interface modes”: the normal modes of the different substructures are considered as clamped on the interface. Dynamic coupling is achieved by taking into account static mode shapes of the whole structure undergoing no exterior load but matching prescribed values on the interface. For example, in a finite element setting, one can choose the mode shapes corresponding to successive unit displacement at the interface nodes, all other interface nodes being totally constraint. Moreover, this method, which is referred to as the “fixed interface method”, remains one of the most widely used in industrial environment, because it easily fits in existing finite element codes, and because of its accuracy.

Goldman[1969], Mac Neal[1971], Rubin[1975] and many others introduced the so-called “free interface method” and its numerous variants. They are all based on the use of local normal modes defined with a free edge boundary condition on the interface. Although this kind of modes are more prone to measurement than the fixed interface ones, the resulting methods suffer from a certain lack of accuracy or from implementation complexity due to the necessary introduction of residual mass or flexibility correction matrices.

Gladwell[1964], Jézéquel [1985] and Destuynder [1989] among others presented different methods, referred to as “branch mode synthesis” or “component mode substitution” methods, that work well especially when one of the substructures is much larger than the other ones. They quite often amount to seek for normal modes associated with boundary stiffness or mass distributions that are strongly related to the mechanics of the appendages.

In order to save computer time, Hale & Heirovitch [1980], and Wang & Chen [1990] proposed to use a set of (possibly orthogonal) easy to generate mode shapes of each substructure, which a priori do not coincide with normal modes.

Since this paper does not aim to review this subject, we refer to Craig [1985], Gibert [1988], Imbert [1979], Jézéquel [1985], Meirovitch [1980], Morand [1977] and Valid [1977] for detailed analyses on this topic.

Surprisingly, the convergence analysis of those methods by mathematical considerations has not received the attention it seems to deserve. In this direction, Jézéquel [1985] showed the convergence of any kind of component mode synthesis method in a totally abstract framework. Meirovitch [1980] stressed the property that component mode synthesis should converge just as any consistent Rayleigh-Ritz method does. But deriving a priori error bounds and sharp convergence rates requires to take into account very carefully the partial differential equation underlying the evolution of the structure. To our knowledge, the first ones are given in Bourquin [1990a], where fixed and free interface methods applied to second- and fourth-order self-adjoint differential operators on one-dimensional domains are considered.

The endeavour to generalize those results to higher-dimensional problems led the first author (see Bourquin [1989]) to introduce, *in a continuous setting*, a new component mode synthesis method that extends, once discretized, the classical Hurty [1965], Craig & Bampton [1968] one. It differs from the latter by the choice of the static modes. They are chosen as the eigenfunctions of the Poincaré-Steklov operator, which is well-known as a coupling operator in domain decomposition methods (see for example Agoshkov [1988]). For this reason, they will be called “coupling modes” in the

sequel. They coincide with the normal modes of the whole structure whose mass density would be lumped on the interface. Robust error bounds for this method are proved in details in Bourquin [1990b] for the heat equation on a domain partitioned in two subdomains and with arbitrary boundary conditions. The finite element discretization of the method is analyzed in Bourquin [1990c], and compared with the Hurty [1965], Craig & Bampton [1968] one. We refer to Bourquin [1990d] for an analysis of the method applied to second-order operators in the case of p substructures, where p may be large.

It should be emphasized that the computation of the coupling modes uses a Lanczos algorithm related to the Poincaré-Steklov operator, and is amenable to an efficient substructuring algorithm that relies on the ideas developed by Bourgat & Glowinski & Le Tallec [1987] (see also Bourgat et al. [1988]). In particular, the assembly and factorization of the global stiffness and mass matrices are never necessary.

One of the most striking features of the proposed strategy is that the definition and the number of component modes to take into account to get some given degree of accuracy *do not depend on the number of unknowns on the interface* in the practical computation. This property allows for example to treat large three-dimensional elasticity problems, where the number of unknowns on the interface is far from being negligible, whereas the classical fixed interface method cannot be used at a reasonable cost in that case (see Imbert [1979], and also Bourquin [1990c]).

From the mechanical point of view, an intrinsic representation of the interface displacements corresponding to low-frequency vibrations of the whole structure is provided thanks to the superposition of a few specific coupling modes shapes.

This paper is organized as follows: section 2 is devoted to the mathematical and mechanical setting of the problem we shall consider. The method is presented in a continuous framework for three-dimensional elasticity. New error bounds are given without proof. The finite element discretization is indicated in section 3. Then the algorithm is thoroughly presented in section 4. Finally, various numerical results regarding the above mechanical problems are discussed in section 5.

2 Presentation of the method.

Consider the problem of finding the normal modes (λ, u) of a piecewise isotropic homogeneous linearly elastic body of material occupying a domain Ω subdivided in two subregions Ω_1 and Ω_2 by a flat (or smooth) interface Γ , according to figure 1.

Let (λ^i, μ^i) and ρ^i denote respectively the Lamé constants and mass density of the material occupying the region Ω_i , $i = 1, 2$. Let \mathcal{A}^i denote the fourth-order elasticity tensor corresponding to the substructure Ω_i , i.e.

$$\mathcal{A}_{jklm}^i = \lambda^i \delta_{jk} \delta_{lm} + \mu^i (\delta_{jl} \delta_{km} + \delta_{jm} \delta_{kl}),$$

and define the tensor

$$\mathcal{A} = \sum_{i=1}^2 \chi(\Omega_i) \mathcal{A}^i,$$

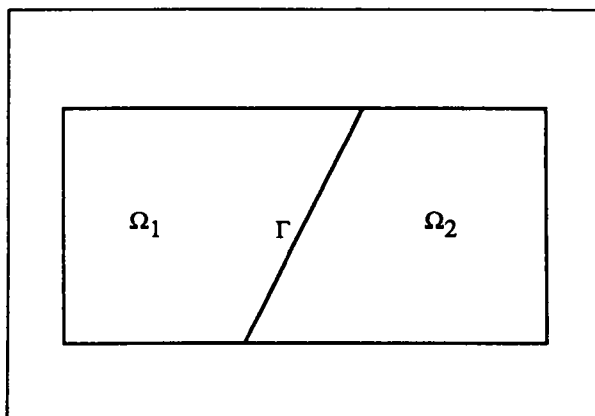

Figure 1: *Decomposition of Ω in Ω_1 and Ω_2 along Γ .*

where $\chi(B)$ denotes the characteristic function of the set B . In the same way, we set

$$\rho = \sum_{i=1}^2 \rho^i \chi(\Omega_i).$$

Furthermore, let V (respectively V_i^0 , $i = 1, 2$) denote the set of admissible displacements of the whole structure (respectively of the substructure Ω_i clamped along the interface Γ , $i = 1, 2$). Typically, $V = H_0^1(\Omega)$ for pure displacement problems, but this definition slightly changes for problems where a traction is imposed on part of the boundary.

In what follows, $e_{jk}(v) = \frac{1}{2}(\partial_j v_k + \partial_k v_j)$ stands for the linearized strain tensor associated with the displacement field $v = (v_1, v_2, v_3)$ defined at any point of the structure, and $\sigma(v)$ denotes the linearized stress tensor resulting from this displacement. We recall that Hooke's law leads to the constitutive equations

$$\sigma(v) = \mathcal{A} : e(v).$$

We seek for the solutions $(\lambda, u) \in \mathbb{R} \times V$ to the problem

$$(1) \quad \begin{cases} -\operatorname{div} \sigma(u) = \lambda \rho u & \text{in } \Omega, \\ u = 0 & \text{on } \partial\Omega, \end{cases}$$

where the pure displacement boundary condition is chosen in order to simplify the exposition and can be replaced by more realistic ones. Taking advantage of Korn's inequality and the theory of self-adjoint compact operators (see Taylor [1958]), problem (1) can be shown to admit a sequence $(\lambda_k, u_k)_{k=1}^{+\infty} \in \mathbb{R}^+ \times V$ of solutions arranged in such a way that the frequencies $\frac{1}{2\pi} \sqrt{\lambda_k}$ form an increasing sequence that tends to infinity with k . Only the first j_0 ones are of interest.

The fixed interface modes (λ^i, u^i) of the substructure Ω_i solve the equations

$$(2) \quad \begin{cases} -\operatorname{div}\sigma(u^i) = \lambda^i \rho^i u^i & \text{in } \Omega_i, \\ u^i = 0 & \text{on } \partial\Omega_i \supset \Gamma, \end{cases}$$

in addition to the constitutive equations. Thanks to the same classical argument as above, problem (2) admits a sequence $(\lambda_j^i, u_j^i)_{j=1}^{+\infty} \in \mathbb{R}^+ \times V_i$ of solutions arranged so that the eigenvalues λ_j^i form an increasing sequence.

Since a superposition of fixed interface modes cannot enable to reconstruct a mode shape that a priori does not vanish identically on the interface Γ , it is necessary to add some coupling modes in the final Ritz procedure.

To this end, let us introduce the space V_Γ of admissible interfacial displacements. For any such interfacial displacement v , we define $\tilde{v} \in V$ as the resulting mode shape when no exterior load is applied, that is the solution of the boundary value problem

$$(3) \quad \begin{cases} \operatorname{div}\sigma(\tilde{v}) = 0 & \text{in } \Omega_1 \text{ and } \Omega_2, \\ \tilde{v} = 0 & \text{on } \partial\Omega, \\ \tilde{v} = v & \text{on } \Gamma, \end{cases}$$

in addition to the constitutive equations.

Now the sum of the interfacial reactions of each substructure to this boundary displacement depends linearly on the latter, so that one can write

$$(4) \quad \sum_{i=1}^2 (\sigma(\tilde{u}_{/\Omega_i}) \cdot n_i)_{/\Gamma} = Tu,$$

where the linear operator T is by definition the Poincaré-Steklov operator associated with the interface Γ and the differential operator of three-dimensional elasticity. It inherits the elegant properties of (anti)compact self-adjoint operators, and thus admits a sequence of normal modes $(\lambda_{\Gamma l}, u_{\Gamma l})_{l=1}^{+\infty} \in \mathbb{R}^+ \times V_\Gamma$ that will be called “coupling modes”, and that satisfy

$$(5) \quad \begin{cases} Tu_{\Gamma l} = \lambda_{\Gamma l} u_{\Gamma l} \text{ on } \Gamma & , \quad \forall l \in \mathbb{N}, \\ 0 < \lambda_{\Gamma 1} \leq \lambda_{\Gamma 2} \leq \dots & , \quad \lim_{l \rightarrow +\infty} \lambda_{\Gamma l} = +\infty. \end{cases}$$

It follows from definitions (3), (4), and (5), that those modes satisfy in particular the variational equation

$$(6) \quad \int_{\Omega} \sigma(\tilde{u}_{\Gamma l}) : e(v) dx = \lambda_{\Gamma l} \int_{\Gamma} u_{\Gamma l} \cdot v d\Gamma \quad \forall v \in V.$$

This equation expresses the principle of virtual works applied to the elastic structure Ω that vibrates at the frequency $\frac{1}{2\pi} \sqrt{\lambda_{\Gamma l}}$, and whose mass density is totally concen-

trated on the interface Γ .

Remark. For the sake of clarity, we have adopted a classical formulation while introducing the different modes of interest. Of course, a variational (weak) formulation can be used in order to set the rigorous mathematical framework in which above definitions, especially (4), make sense. However, we shall not enter into the relevant mathematical details, which can be found elsewhere (see for example Bourquin[1990b]). \square

We now choose three numbers $N = (N_1, N_2, N_\Gamma)$ and define the space of trial displacements

$$(7) \quad V_N = \text{Span}\{\oplus((u_j^i)_{j=1}^{N_i})^2 \oplus (\tilde{u}_{\Gamma l})_{l=1}^{N_\Gamma}\},$$

which is composed of the linear superpositions of the N_i first fixed interface modes of each substructure Ω_i and of the N_Γ first coupling modes. Then, component mode synthesis consists in seeking for the successive critical points of the Rayleigh quotient

$$(8) \quad \mathcal{Q}(v^N) = \frac{\int_{\Omega} \sigma(v^N) : e(v^N) dx}{\int_{\Omega} v^N \cdot v^N \rho dx}$$

over the space V_N . Of course, the critical values and displacements (λ_k^N, u_k^N) solve the variational equation

$$\int_{\Omega} \sigma(u_k^N) : e(v^N) dx = \lambda_k^N \int_{\Omega} u_k^N \cdot v^N \rho dx \quad \forall v^N \in V_N.$$

The method is shown to yield exact results when all the fixed interface modes and coupling modes are taken into account, that is $\lambda_k^{+\infty} = \lambda_k$, $u_k^{+\infty} = u_k$ (with a suitable normalization). The question of deriving error bounds of the quantities $\lambda_k^N - \lambda_k$ and $\int_{\Omega} \sigma(u_k^N - u_k) : e(u_k^N - u_k) dx$ has been answered for the Laplace operator, but we now indicate how to extend the error estimates if further reasonable assumptions are made as explained below: consider the auxiliary source problem posed in each of the substructures

$$(9) \quad \begin{cases} -\text{div}\sigma(w^i) = f^i & \text{in } \Omega_i, \\ w^i = 0 & \text{on } \partial\Omega_i, \end{cases}$$

where f^i denotes any square integrable force field in Ω_i . According to Leguillon & Sanchez Palencia [1987], the displacement field w^i may exhibit in the vicinity of each edge and vertex of the substructure Ω_i a singularity of the type r^β , if r stands for the distance between the current point and the edge or vertex considered. In what follows, we only consider those of the latter that are part of, or adjacent to, the interface Γ .

Since the only singularities of w^i are of that type (see the general theory of Kondratiev [1967] as well as Dauge [1988] and Grisvard [1985]), there exists a maximal singularity corresponding to $\alpha = \min_{\text{edges, vertices}} (\beta) > 0$. Let us recall that a singularity of the type $r^{1/2}$ develops in a crack, in such a way that, in most cases of interest

for component mode synthesis, we have $\alpha > 1/2$. But in any case, the value of α depends on the geometry and Lamé constants of the substructures, that is on the domain decomposition and on the operator considered.

In this setting, the following convergence rates can be established, when the first order moments $\int_{\Omega} u_k \cdot u_k dx$ and $\int_{\Omega} u_k^N \cdot u_k^N dx$ are normalized:

$$(10) \quad \lambda_k^N - \lambda_k + \|u_k^N - u_k\|^2 \leq C(k) \left[\sum_{i=1}^2 \frac{\varepsilon_i(s, N_i)}{\lambda_{iN_i}^s} + \frac{\varepsilon_{\Gamma}(N_{\Gamma})}{\lambda_{\Gamma N_{\Gamma}}^{2\alpha}} \right],$$

and

$$(11) \quad \lambda_k^N - \lambda_k + \|u_k^N - u_k\|^2 \leq C(k) \left[\sum_{i=1}^2 \frac{\varepsilon_i(s, N_i)}{C_i N_i^{\frac{2s}{n}}} + \frac{\varepsilon_{\Gamma}(N_{\Gamma})}{C_{\Gamma} N_{\Gamma}^{\frac{2\alpha}{n-1}}} \right],$$

for every real number $s < 1.5$, where we have set

$$\|v\|^2 = \int_{\Omega} \sigma(v) : e(v) dx \quad \forall v \in V,$$

and where n stands for the dimension of the structure: here $n = 3$. The quantities $\varepsilon_i(s, N_i)$ and $\varepsilon_{\Gamma}(N_{\Gamma})$ go to zero when N_i or N_{Γ} tends to infinity. Notice that the information on the geometry of the domain decomposition is entirely contained in the parameter α , that is not directly related to the possible singularities of the solution u_k . Therefore, this error bound seems quite insensitive to the regularity of the latter.

The error bound (11) is a consequence of (10) and of a priori lower bounds regarding in a first place the eigenvalues λ_{ij} , and in a second place the eigenvalues $\lambda_{\Gamma l}$. The lower bounds of the first kind appeal to the classical Weyl formula but the other ones have to be proved (see Bourquin [1990b]).

For various reasons, the convergence rates (10) and (11) cannot be essentially bettered although they look rough if one thinks of spectral or finite element methods that converge at comparable speed, but require a lot of easy to generate basis functions. However, it will be shown numerically that *very few fixed interface and coupling modes need be computed* to yield a 1% accuracy regarding the five lowest computed global eigenfrequencies. This feature appears as a key point of the proposed component mode synthesis strategy, and expresses that the low-frequency global normal modes are very well represented by some low-frequency normal modes of the substructures and some normal modes of the coupling Poincaré-Steklov operator. In the same spirit, let us recall that modal superposition does also work very well when the external load varies smoothly in time.

The second ingredient that makes the method efficient is the domain decomposition method used to compute the coupling modes, as explained in §4.

Remarks.

(i) The case where a (possibly large) number p of substructures is chosen to partition the original structure can be addressed in the same way, except that establishing error bounds depending explicitly on the parameter p requires extra mathematical tricks (see Bourquin[1990d]). Anyway, the following error estimates can be derived under regularity assumptions regarding the domain decomposition, the details of which we shall not go into:

$$(12) \quad \lambda_k^N - \lambda_k + \|u_k^N - u_k\|^2 \leq C(k) \left[\left(\frac{1}{p}\right)^{\frac{2s}{n}} \sum_{i=1}^p \frac{\varepsilon_i(s, N_i)}{N_i^{\frac{2s}{n}}} + p^{\frac{1}{n(n-1)}} \frac{\varepsilon_\Gamma(N_\Gamma)}{N_\Gamma^{\frac{1}{n-1}}} \right],$$

where s , $\sum_{i=1}^p \varepsilon_i$, ε_Γ and C do not depend on the parameter p . Therefore, increasing the number of subdomains allows a priori to take into account in the space V_N the same total number of fixed interface modes, but more coupling modes, as will be shown in §5.

(ii) The error estimates (10), (11), and (12) hold in fact for a wide class of physical phenomena modeled by elliptic operators on n -dimensional domains.

(iii) The quantities ε_i and ε_Γ also depend on the Lamé constants and mass density of the material in a way that is thoroughly discussed in Bourquin [1990b]. In particular, it is proved that a rigid or light or small substructure will influence the evolution of the whole structure through its static behavior only, and possibly through its lowermost normal modes. \square

Let us now express the method in a finite element setting:

3 Finite element approximation.

In the sequel, h denotes a small parameter, and $(V^h)_{h>0}$ a family of finite-dimensional spaces such that $V^h \subset V$. We assume that $P^h v \rightarrow v$ if $h \rightarrow 0$, where P^h stands for the orthogonal projection mapping onto the space V^h with respect to the energy scalar product. For the sake of simplicity, we exclude non-conforming methods, and we do not worry about numerical integration, but those difficulties could be tackled also.

Thus, the global normal modes (λ_k^h, u_k^h) solve the variational equation

$$(13) \quad \int_{\Omega} \sigma(u_k^h) : e(v^h) dx = \lambda_k^h \int_{\Omega} u_k^h \cdot v^h dx \quad \forall v^h \in V^h.$$

Let V_i^h (V_i^{0h} resp.) denote the space of the restrictions to the subdomain Ω_i of the trial functions $v^h \in V^h$ (that vanish on the interface Γ resp.), let V_Γ^h denote the set of the traces on Γ of all the trial functions of the space V^h , and set $N_\Gamma^h = \dim V_\Gamma^h$. Then, the fixed interface modes $(\lambda_j^{i,h}, u_j^{i,h}) \in \mathbb{R}^+ \times V_h^{0i}$ solve the variational equation

$$(14) \quad \int_{\Omega_i} \sigma(u_j^{i,h}) : e(v^h) dx = \lambda_j^{i,h} \int_{\Omega_i} u_j^{i,h} \cdot v^h \rho dx \quad \forall v^h \in V_i^{0h}.$$

and

$$(22) \quad M = \begin{bmatrix} \begin{bmatrix} 1 & & & & \\ & \dots & & & 0 \\ & & 1 & & \\ & & & 1 & \\ 0 & & & & \dots \\ & & & & & 1 \end{bmatrix} & \begin{bmatrix} (u_j^{ih}, \tilde{u}_{\Gamma k}^{hh}) \\ \vdots \\ (\tilde{u}_{\Gamma l}^{hh}, u_j^{ih}) \end{bmatrix} \\ \begin{bmatrix} (\tilde{u}_{\Gamma l}^{hh}, u_j^{ih}) \\ \vdots \\ (\tilde{u}_{\Gamma l}^{hh}, \tilde{u}_{\Gamma k}^{hh}) \end{bmatrix} & \begin{bmatrix} \\ \vdots \\ \end{bmatrix} \end{bmatrix},$$

where $(u, v) = \int_{\Omega} v \cdot u dx$ is the scalar product on $L^2(\Omega)$. Note that the stiffness matrix is diagonal, whereas the mass matrix possesses off-diagonal terms.

For the sake of completeness, we recall the corresponding error bounds whose proof can be found in Bourquin [1990c]. Let $P_i^{0h} : V \rightarrow V_i^{0h}$ denote the orthogonal projection mapping with respect to the energy scalar product on Ω_i . Then the following inequality holds

$$(23) \quad \lambda_k^{N,h} - \lambda_k + \|u_k^{N,h} - u_k\|^2 \leq C(k) \left[\sum_{i=1}^2 \frac{\varepsilon_i(s, N_i)}{N_i^{\frac{2s}{n}}} + \frac{\varepsilon_{\Gamma}(N_{\Gamma})}{N_{\Gamma}^{\frac{2s}{n-1}}} \right] \\ + \sum_{i=1}^2 \sum_{j=1}^{N_i} C_{ij} \|(I - P_i^{0h})u_j^i\|^2 + \sum_{l=1}^{N_{\Gamma}} C_l \|(I - P^h)\tilde{u}_{\Gamma l}\|^2,$$

for some constants C_{ij} and C_l , with $s < 1.5$, and where the functions ε_i and ε_{Γ} are the same as in (11).

Notice that mode truncation error and discretization error add to one another and remain coupled. Therefore, the number of modes to take into account should suit the mesh size, and not exceed a specific value depending on the latter. Such a constraint has been observed by Dorr [1989] for a similar interdomain coupling technique. In this direction, let us recall that the error bound (23) can be enhanced, in the sense that both sources of error can be partly decoupled. Of course, loss of stability due to an excess number of component modes should not be worried about, since the accuracy of a Rayleigh-Ritz procedure does not decrease with respect to the number of trial functions.

4 Algorithms.

4.1 Global algorithm.

In the case where we consider a structure decomposed into p substructures, the algorithm of the component mode synthesis method consists basically of five parts:

(i) once the control parameters $N = (N_1, \dots, N_p, N_\Gamma)$ and h are set up, compute the fixed interface modes $(\lambda_j^{ih}, u_j^{ih})_{j=1}^{N_i}$ on each subdomain;

(ii) compute the coupling modes;

(iii) form the stiffness and mass matrices K and M defined as in (21) and (22), associated with the global problem and with our choice of basis functions computed in steps (i) and (ii);

(iv) solve the small-scale eigenvalue problem (20), of size $N = N_1 + N_2 + \dots + N_p + N_\Gamma$, which yields the global eigenvalues $\lambda_k^{N,h}$ and the associated eigenfunctions on the basis of fixed interface and coupling modes;

(v) restore the global solution everywhere in Ω .

Steps (i), (iii), (iv) and (v) appeal to standard finite element techniques.

Once the number of coupling modes to compute is given, the speed of the algorithm mainly depends on step (ii) which appeals to a Lanczos algorithm and makes an essential use of domain decomposition techniques that will be outlined.

4.2 The interface eigenvalue problem.

The coupling modes $(\lambda_{\Gamma l}^h, u_{\Gamma l}^h)_{l=1}^{N_\Gamma} \in \mathbb{R} \times V_\Gamma^h$ are the solutions associated with the lowest eigenvalues of the discretized problem (cf. §3):

$$(24) \quad \begin{cases} \text{find } (\lambda^h, u^h) \in \mathbb{R} \times V_\Gamma^h \text{ such that,} \\ b_h(u^h, v^h) = \lambda^h \int_\Gamma u^h \cdot v^h d\Gamma \quad \forall v^h \in V_\Gamma^h. \end{cases}$$

In the following we use the same notation for a function $v \in V_\Gamma^h$ and for the corresponding vector $v \in \mathbb{R}^{N_\Gamma^h}$ of its components in the canonical basis for a given finite element interpolation.

We also note B and C the linear operators over $\mathbb{R}^{N_\Gamma^h}$ such that for every u, v in V_Γ^h ,

$$(25) \quad \begin{aligned} v^T B u &= b_h(u, v) \\ &= \int_\Gamma (T_h u) \cdot v d\Gamma, \end{aligned}$$

and

$$(26) \quad v^T C u = \int_{\Gamma} u \cdot v \, d\Gamma.$$

Thus we can write (24) as the eigenvalue problem

$$(27) \quad \begin{cases} \text{find } (\lambda, u) \in \mathbb{R} \times V_{\Gamma}^h \text{ such that,} \\ B u = \lambda C u. \end{cases}$$

There exists several methods to solve equation (27) from the data of the matrices of B and C . The computation of the matrix of C is classical once the basis functions on the interface are defined. The latter are the traces over Γ of the basis functions defined on the whole domain Ω in the finite element discretization of the global problem.

The originality of the method comes from the matrix of B that we do not want to form directly, otherwise we would present a variant of the classical Hurty [1965], Craig & Bampton [1968] method indeed ! We assume that we can only compute the product Bu for a given $u \in V_{\Gamma}^h$. Let us see how it can be done.

From (25) and (16) we have, for every v in V_{Γ}^h :

$$\begin{aligned} v^T B u &= \int_{\Omega} \sigma(R^h u) : e(R^h v) \, dx \\ &= \int_{\Gamma} (T_h u) \cdot v \, d\Gamma, \end{aligned}$$

So, from the definition of the lifting operator R^h we have:

$$\begin{aligned} \gamma(w)^T B u &= \int_{\Omega} \sigma(R^h u) : e(w) \, dx \quad \forall w \in V^h, \\ &= \sum_{i=1}^p \int_{\Omega_i} \sigma(R^h u) : e(w) \, dx \quad \forall w \in V^h, \\ &= \sum_{i=1}^p (R^h u_i)^T K_i w_i \quad \forall w \in V^h, \end{aligned}$$

where the mapping γ is the trace operator on the interface Γ , v_i is the restriction of v to Ω_i , and K_i is the stiffness matrix over Ω_i .

This shows that for the computation of Bu one has to solve p independent Dirichlet problems to determine $R^h u_i$, $i = 1, \dots, p$, and to compute, on the nodes of the interface $\Gamma \cap \partial\Omega_i$, the products $(R^h u_i)^T K_i$.

Then it is possible to solve a linear system associated with the matrix of B thanks to a preconditioned conjugate gradient - P.C.G - method, like the one used in Bourgat & Glowinski & Le Tallec [1988] (cf §4.4). Then problem (27) will be solved thanks to a Lanczos method that we now explain.

Remark. It is clear that the cost of the computation of the matrix of B (that is necessary in a classical fixed interface method) directly depends on the number of interface unknowns N_Γ^h since the product Bu has to be done for all the ($u = e_1, e_2, \dots, e_{N_\Gamma^h}$) vectors of the canonical basis of $\mathbb{R}^{N_\Gamma^h}$. \square

4.3 The Lanczos method.

We will now identify the space of linear operators over $\mathbb{R}^{N_\Gamma^h}$ and the space of matrices $\mathbb{R}^{N_\Gamma^h} \times \mathbb{R}^{N_\Gamma^h}$ so that the following equations make sense.

As we explicitly know the matrix of C , we can consider its Cholesky decomposition:

$$C = LL^T.$$

Then, for $(\lambda, u) \in \mathbb{R} \times \mathbb{R}^{N_\Gamma^h}$ solution of (27), we have

$$Bu = \lambda Cu = \lambda LL^T u.$$

If we set

$$v = L^T u,$$

we have:

$$L^T B^{-1} L v = \frac{1}{\lambda} v$$

The problem (27) is then equivalent to find the N_Γ largest eigenvalues and associated eigenvectors of the linear operator:

$$A : \mathbb{R}^{N_\Gamma^h} \longrightarrow \mathbb{R}^{N_\Gamma^h}$$

with

$$A = L^T B^{-1} L.$$

We now recall the Lanczos method which is known to be efficient to compute few of the biggest eigenvalues of a given operator.

Initialization:

choose p_1 , an initial unit vector,

compute $q_2 = Ap_1 - \alpha_1 p_1$ with $\alpha_1 = \frac{p_1^T A p_1}{p_1^T p_1}$,

and $p_2 = \frac{1}{\nu_2} q_2$ with $\nu_2 = \|q_2\|$.

Step k:

compute

$$(28) \quad q_{k+1} = Ap_k - \alpha_k p_k - \beta_k p_{k-1},$$

with

$$\alpha_k = \frac{p_k^T A p_k}{p_k^T p_k} \text{ and } \beta_k = \frac{p_{k-1}^T A p_k}{p_{k-1}^T p_{k-1}}.$$

If $q_{k+1} = 0$ choose p_{k+1} a unit vector in $\{p_1, \dots, p_k\}^\perp$,

otherwise set

$$p_{k+1} = \frac{1}{\nu_{k+1}} q_{k+1}, \quad \nu_{k+1} = \|q_{k+1}\|.$$

From (28), after k steps we have:

$$(29) \quad A[p_1, \dots, p_k] = [p_1, \dots, p_k]T_k + [0, \dots, 0, q_{k+1}],$$

where,

$$T_k = \begin{pmatrix} \alpha_1 & \beta_2 & & & & \\ \nu_2 & \alpha_2 & \beta_3 & & & 0 \\ & \cdot & \cdot & \cdot & & \\ & & \cdot & \cdot & \cdot & \\ 0 & & & \nu_{k-1} & \alpha_{k-1} & \beta_k \\ & & & & \nu_k & \alpha_k \end{pmatrix}.$$

The coefficients α_k and β_k are chosen so that $\{p_1, \dots, p_k\}$ is an orthonormal sequence ; in fact the coefficients ν_k that normalize the vectors $\{p_1, \dots, p_k\}$ are equal to β_k :

$$\beta_k = p_{k-1}^T A p_k = (q_k + \alpha_{k-1} p_{k-1} + \beta_{k-1} p_{k-2})^T p_k = q_k^T p_k = \nu_k p_k^T p_k = \nu_k,$$

then the matrix T_k is symmetric.

The Lanczos iterations give rise to a subspace with an orthonormal basis $\{p_1, \dots, p_k\}$, in which the ‘‘Galerkin projection’’ of the linear operator A is a three-diagonal symmetric matrix T_k . Then one can compute at a low cost the eigenvalues and corresponding eigenvectors of T_k which approximate the eigenvalues and eigenvectors of A . In fact, numerical tests show that, if $k \geq 2 \times N_\Gamma + 4$, the N_Γ biggest eigenvalues of T_k coincide with the N_Γ biggest eigenvalues of A .

Unfortunately, if the algorithm is carried out as described, the last p_k may be far from being orthogonal to the previous ones. This occurs when there is a good deal of cancellation when computing q_{k+1} from $A p_k - \alpha_k p_k - \beta_k p_{k-1}$. In order to make sure to obtain the full set of eigenvalues and eigenvectors, it is necessary to ensure that the computed p_k are orthogonal to working accuracy. The conventional way of doing this reads as follows: after computing q_{k+1} via (28), this vector is reorthogonalized with respect to p_1, \dots, p_k . Golub & Underwood & Wilkinson [1972] propose to use the

orthogonality of the canonical basis e_1, e_2, \dots, e_k through an orthogonal transformation; at step k , they determine a transformation O_{k+1} such that $p_{k+1} = O_{k+1}e_{k+1}$.

Then, once $\{p_1, \dots, p_{k-1}\}$, H_1, \dots, H_k are determined, the iteration k becomes:
compute

$$q_{k+1} = Ap_k - \alpha_k p_k - \beta_k p_{k-1},$$

with

$$\alpha_k = p_k^T Ap_k \quad \beta_k = p_{k-1}^T Ap_k.$$

Form

$$\bar{q}_{k+1} = H_k \dots H_1 q_{k+1}.$$

Compute the Housholder matrix

$$H_{k+1} = I - 2u_{k+1}^T u_{k+1}$$

such that $H_{k+1}\bar{q}_{k+1}$ has its $N_\Gamma^h - (k+2)$ last components equal to zero. Then, set

$$p_{k+1} = H_1 \dots H_{k+1} e_{k+1}.$$

It is proved in Golub & Underwood & Wilkinson, [1972] that the p_k obtained in this way are orthogonal to working accuracy.

This variant also avoids to restart the algorithm if q_{k+1} is equal to zero before $k = N_\Gamma^h$.

Remarks.

(i) The number N_{it} of iterations necessary in the algorithm, $N_{it} \geq 2 \times N_\Gamma + 4$, remains small compared to the order of B which is equal to N_Γ^h . Indeed, as expected the number of coupling modes N_Γ we have to take into account is small (see numerical tests in §5).

(ii) For a two-dimensional problem, N_Γ^h increases like $1/h$ when the number of unknowns *in* each subdomain increases like $1/h^2$ ($1/h^2$ and $1/h^3$ respectively in three-dimensional problems). Then the storage of the k Housholder matrices used in the reorthogonalization process is almost free of charge.

(iii) In practice, more than 95% of the CPU time is spent by the C.G. procedure that solves the linear system associated with B at each iteration. This shows that the performance of the algorithm strongly depends on the preconditioner used in this C.G. procedure and not on the method used to get the orthogonality of the p_k . In fact, the preconditioner used here gives "good" results in the sense that the number of iterations of C.G. algorithm does not depend on the number N_Γ^h of unknowns on the interface Γ . In addition, it proves robust and adapts to any kind of domain decomposition. Nevertheless, other algorithms may run faster and could be used as well (see d'Hennezel [1990]). \square

4.4 The preconditioned conjugate gradient algorithm.

At each iteration of the Lanczos method, the most important step is to compute the product Ap_k in (28). Since $A = L^T B^{-1} L$, One has to solve:

$$(30) \quad \begin{cases} \text{find } x \in V_\Gamma^h \text{ such that:} \\ Bx = b \end{cases}$$

with $b = L^T p_k$.

Using an operator B_0 as preconditioner consists in rewriting problem (30) in the following way

$$B_0 Bx = B_0 b,$$

where B_0 is chosen such that the condition number of the operator $B_0 B$ is close to 1.

The motivation of Bourgat et al. [1988] is to give an efficient substructuring algorithm for static problems. In their approach, they reduce the global problem in a problem whose unknowns are located on the interface. The corresponding interface operator is nothing but the Poincaré-Steklov operator T_h associated with the bilinear form B . Then a static substructuring problem is solved with one resolution of (30) by a P.C.G. algorithm; the preconditioner B_0 is a sum of discrete Neumann lifting operators as explained below.

We recall that at each iteration of the P.C.G. algorithm the two main steps are the computations of Bx and $B_0 y$ for two given functions x et y in V_Γ^h (see for example Lascaux & Théodor [1987] for more details).

In section 4.2, we have shown how to compute Bx . Consider now y in V_Γ^h , the computation of $B_0 y$ is done as follows:

$$(31) \quad \begin{cases} \text{find } x_i \in V_i^h \ i = 1, \dots, p \text{ such that:} \\ \int_{\Omega_i} \sigma(x_i) : e(z_i) dx = \int_{\Gamma} (\alpha_i y) \cdot z_i d\Gamma \quad \forall z_i \in V_i^h \end{cases}$$

where the mappings

$$\alpha_i : V_\Gamma^h \longrightarrow V_i^h$$

are such that:

$$\sum_{i=1}^p \alpha_i = Id.$$

Then

$$B_0 y = \sum_{i=1}^p \alpha_i \gamma(x_i),$$

where γ is the trace operator on Γ .

Remarks.

(i) In the case where the interface Γ is composed of only “one” interface between two subdomains, one can simply choose $\alpha_i = \frac{1}{2}Id$.

(ii) In some cases, if no external Dirichlet boundary condition is imposed, the problems (31) cannot be solved. To avoid this difficulty, Bourgat et al. [1988] propose to “increase” the energy associated with $\int_{\Omega_i} \sigma(x_i) : e(z_i) dx$. This means that some positive terms are added to the diagonal of the corresponding matrix so that the latter becomes invertible.

(iii) The Neumann problems (31) are independent of each other. As we have seen in (§4.2), the computation of Bx can be done independently on each subdomain. This shows that the two main steps of the P.C.G. algorithm can be performed in parallel. \square

5 Numerical tests.

The two- and three-dimensional coding of the algorithm described in section 4 has been done in the finite element library MODULEF in a multi-element, multi-problem and multi-tasking framework.

In Bourquin [1990c], several numerical tests regarding the heat equation have been performed in special cases where the global normal modes and all component modes are explicitly computable. They confirmed the sharpness of the predicted convergence rates as well as the accuracy of the method with respect to the number of component modes that have to be taken into account. Here, we aim on the one hand to prove numerically robustness properties of the method with respect to the domain decomposition, the physical problem considered, and the discretization, and on the other hand to assess the efficiency of the algorithm that computes the low-frequency spectrum of the Poincaré-Steklov operator.

5.1 Test 1.

We first consider the case where the number of subdomains goes from $p = 4$ to 9 and 16; we study the convergence rate with respect to the number of coupling modes N_Γ and fixed interface modes N_1, \dots, N_p taken into account in the approximation of the global problem.

Let us consider the eigenvalue problem,

$$\begin{cases} -\Delta u = \lambda u & \text{in } \Omega, \\ u = 0 & \text{on } \partial\Omega, \end{cases}$$

where Ω is the unit square.

This problem has a sequence of analytical solutions $(\lambda_k, u_k)_{k=1}^{+\infty}$, with:

$$\begin{cases} \lambda_k = (k_1 + k_2)\pi^2, \\ u_k = \sin k_1\pi x \sin k_2\pi y, \end{cases} \quad (k_1, k_2) \in \mathbb{N}^2.$$

We define over Ω a finite element discretization of piecewise linear polynomial functions on a uniform triangulation. In order to neglect the discretization error in inequality (23), we solve the problem on a fine mesh composed of 14112 P1-Lagrange finite elements. The mesh is also chosen so that Ω can be partitioned in 4, 9 and 16 equal squares along its edges.

For this test, we fix $M = N_1 = \dots = N_p$, and we analyze the convergence of the method with respect to N_Γ , M , p . The following figures show the decay of the relative error on the computed eigenvalues $\lambda_k^{N_\Gamma, M, p}$ defined by:

$$err^k(N_\Gamma, M, p) = \frac{\lambda_k^{N_\Gamma, M, p} - \lambda_k}{\lambda_k},$$

for $k = 1$ (+), $k = 2$ (*) and $k = 5$ (o).

Figures 2 and 3 give the error for $p = 4$, figures 4 and 5 for $p = 9$, and figures 6 and 7 for $p = 16$.

Let us first notice that these plots show the numbers M and N_Γ one has to choose to get a given accuracy; indeed, inequality (12) says that the error with respect to M and N_Γ are not coupled and add to one another (as far as discretization error is neglected). This is one of the reasons why the error does not go under a limit value. Consider for instance figure 2; as M varies, N_Γ is fixed to 12 and thus remains finite. Note also that the relative error on the frequencies ν , with $\nu^2 = \frac{\lambda}{4\pi^2}$, is half the error given here on the eigenvalues.

p	4	9	16
N_Γ	8	16	31
M	10	7	6

Table 1.

Table 1 gives the number of fixed interface modes M and coupling modes N_Γ used to get a relative error on the first five eigenvalues under 1% (0.5% on the eigenfrequencies). We see that, as predicted by inequality (12), the number of fixed interface modes per subdomain tends to decrease and the number of coupling modes to increase when p goes from 4 to 16 to get a given accuracy. So it is clear that, as the number of subdomains becomes large, the step (ii) of the algorithm (computation of the coupling modes) is extremely time consuming. Indeed the number of Lanczos iterations is much larger for $p = 16$ than for $p = 4$ to get all the necessary coupling modes. Moreover, the number

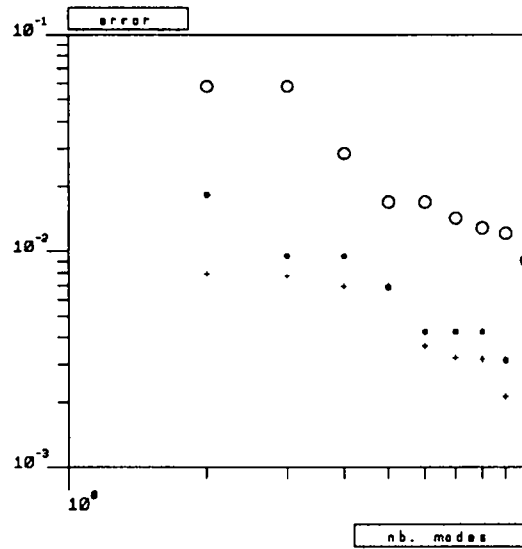

Figure 2: Error for the Laplace operator on four subdomains with $N_\Gamma = 12$ and M increasing.

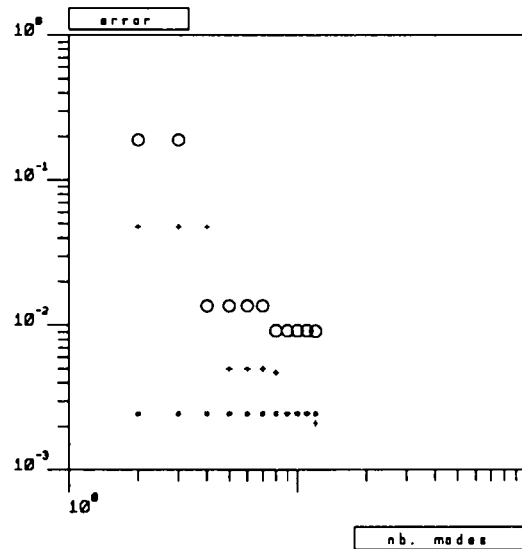

Figure 3: Error for the Laplace operator on four subdomains with $M = 12$ and N_Γ increasing.

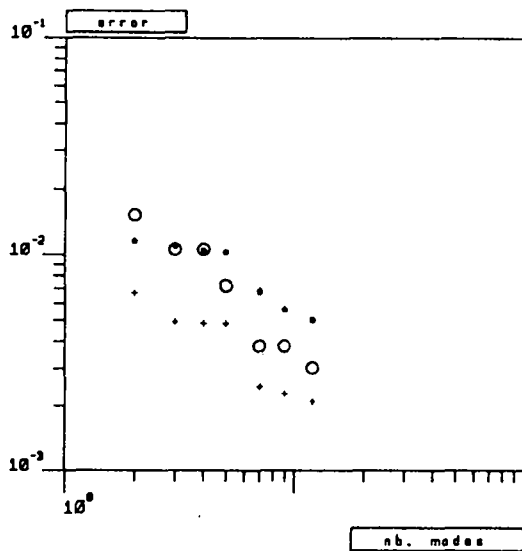

Figure 4: *Error for the Laplace operator on nine subdomains with $N_\Gamma = 16$ and M increasing.*

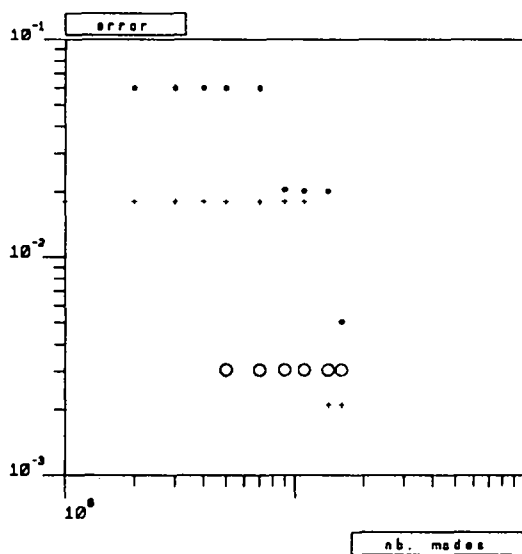

Figure 5: *Error for the Laplace operator on nine subdomains with $M = 12$ and N_Γ increasing.*

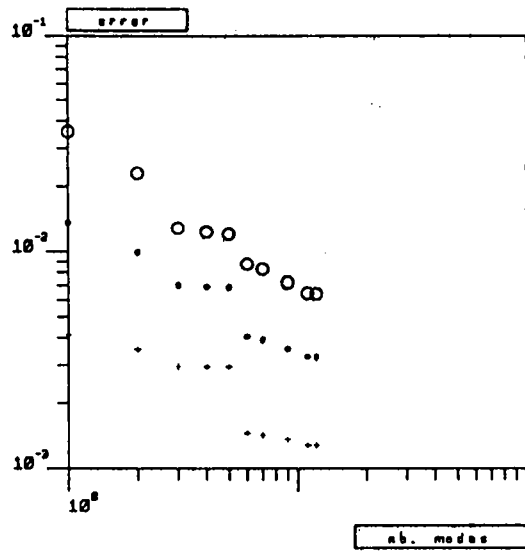

Figure 6: Error for the Laplace operator on sixteen subdomains with $N_\Gamma = 32$ and M increasing.

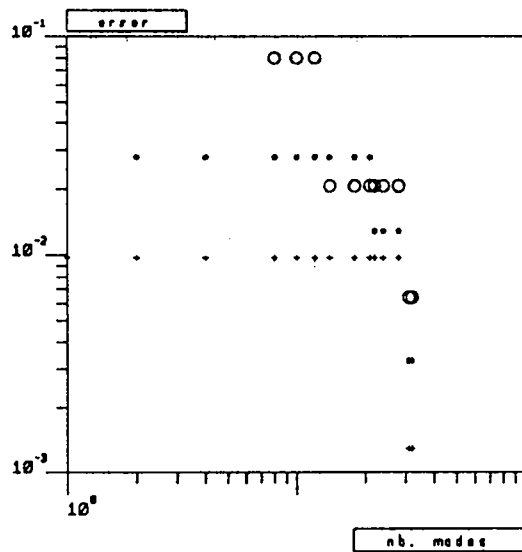

Figure 7: Error for the Laplace operator on sixteen subdomains with $M = 12$ and N_Γ increasing.

of P.C.G iterations to solve the interface operator at each iteration goes from 5 to 18 when p goes from 4 to 16.

Those results show in particular that simple decompositions as considered here, are, even in a parallel environment, not a so good strategy when the number of subdomains becomes large. The problem is the same for static substructuring problems using the Poincaré-Steklov operator to couple subdomains (see De Roeck & Le Tallec & Vidrascu [1990] and Bourgat et al. [1988]). We guess that our algorithm works similarly on identical problems.

Remark. It is noteworthy that high-frequency coupling mode shapes concentrate in the vicinity of the interface (figure 9), as if they would represent some sort of “short range interaction” between the substructures, whereas the low-frequency ones do not vanish identically anywhere in the structure (figure 8), and thus the latter seem to take care of the “long range interaction” between the substructures. A deeper insight into this phenomenon may be of interest. \square

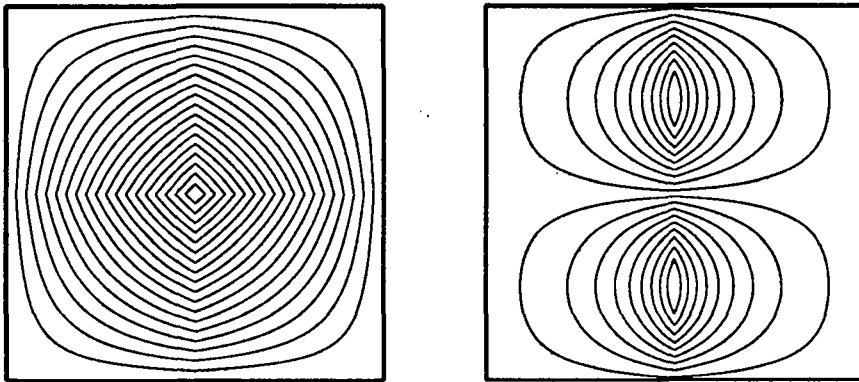

Figure 8: *The first (left) and second (right) coupling modes.*

The following tests will show the efficiency of the method on some different elliptic problems.

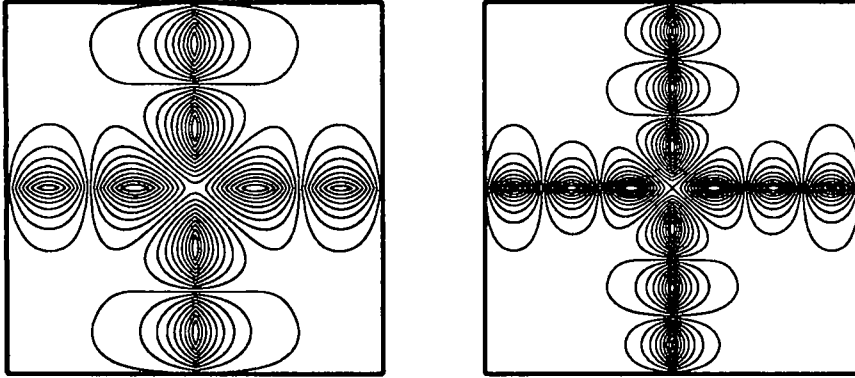

Figure 9: *The eighth (left) and twelfth (right) coupling modes.*

5.2 Test 2.

As an example of a nonsmooth problem we consider the following:

$$\begin{cases} -\Delta u = \lambda u & \text{in } \Omega, \\ u = 0 & \text{on } \partial\Omega, \end{cases}$$

where Ω is a L-shaped domain. Figure 10 shows how it is decomposed in two subdomains.

Here we shall see how the method behaves for different discretizations of the problem. Since we do not know analytical solutions for the global problem, we plot the component mode synthesis error given by:

$$\text{err}^k(N_1, N_2, N_\Gamma, h) = \frac{\lambda_k^{N,h} - \lambda_k^h}{\lambda_k^h},$$

where the solutions (λ_k^h, u_k^h) are computed thanks to a classical global method.

Consider first a regular uniform triangulation of Ω . On this mesh, we use piecewise linear functions on each triangle for the discretization of the problem. Figures 11, 12 and 13 give the error $\text{err}^k(N_1, N_2, N_\Gamma, h)$ for the eigenvalues $k = 1$ (+), $k = 2$ (*) and $k = 5$ (o).

The finite element approximation of the problem on this type of domain can be greatly improved by refinement techniques near the singularity thanks to the (h, p) -version of the finite element method, treated for example in Babuška & Dorr [1981]. We do not try here to reach an optimal approximation, but the following tests show that the number of modes is stable under local refinement: consider indeed a refined

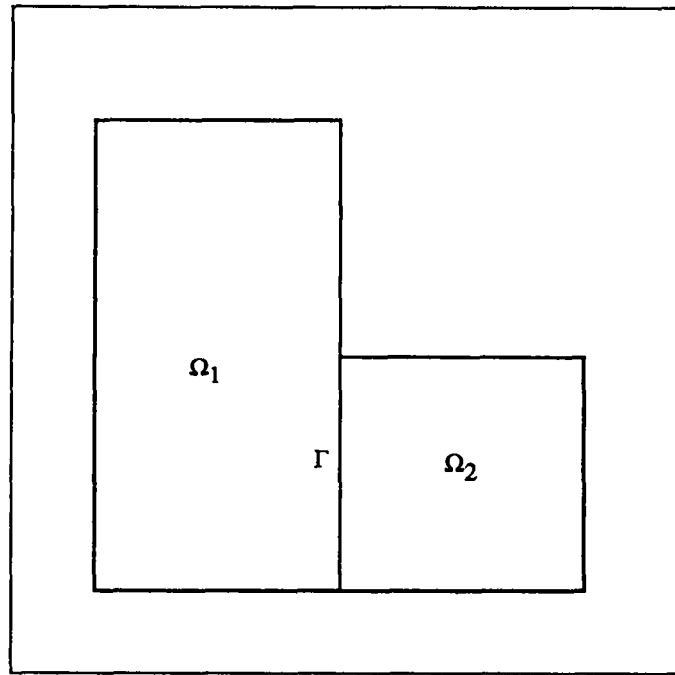

Figure 10: *The L-shaped domain and its decomposition.*

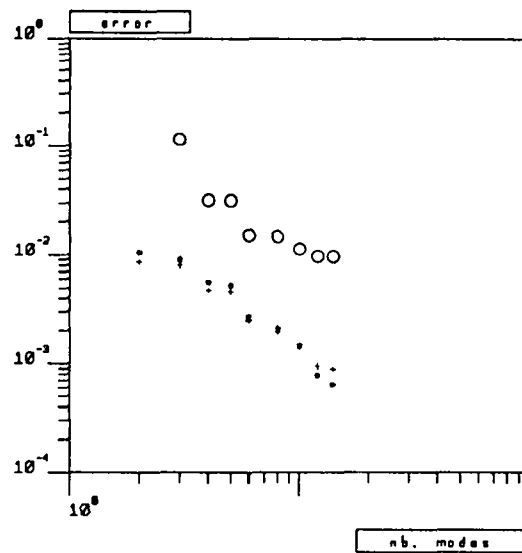

Figure 11: *Error for the Laplace operator on a L-shaped domain with regular mesh. $N_\Gamma = 7$, $N_2 = 14$ and N_1 increasing.*

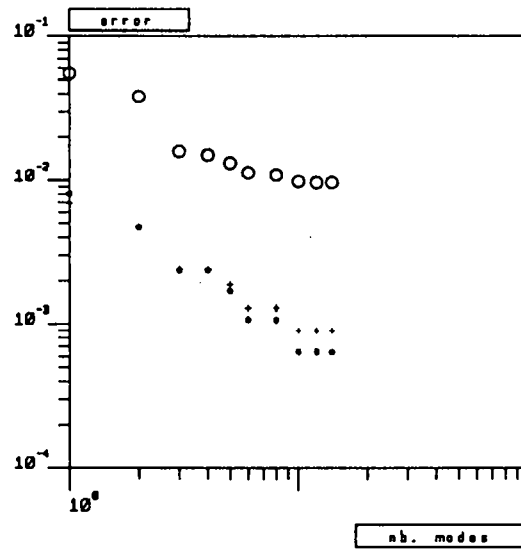

Figure 12: *Error for the Laplace operator on a L-shaped domain with regular mesh. $N_{\Gamma} = 7$, $N_1 = 14$ and N_2 increasing.*

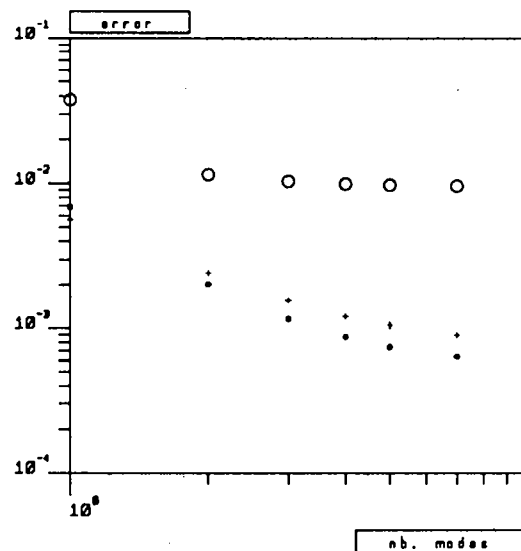

Figure 13: *Error for the Laplace operator on a L-shaped domain with regular mesh. $N_1 = 14$, $N_2 = 14$ and N_{Γ} increasing.*

unstructured triangulation with “small” elements around the reentrant corner. The problem is approximated by piecewise polynomial functions of degree two on each element (P2-Lagrange). Figure 14 gives here again the error $err^k(N_1, N_2, N_\Gamma, h)$ for eigenvalues $k = 1$ (+), $k = 2$ (*) and $k = 5$ (o) with $N_1 = N_2 = 14$.

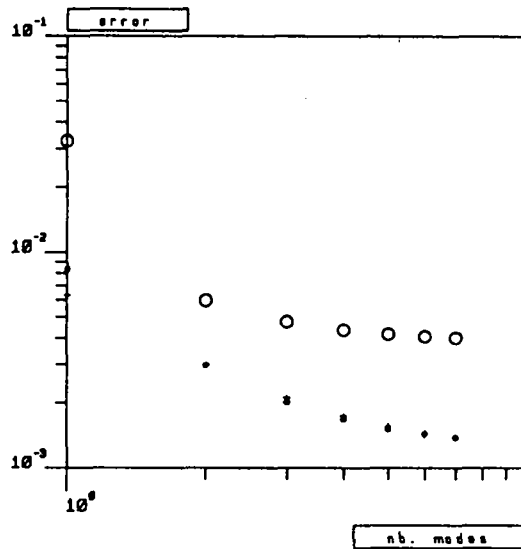

Figure 14: Error for the Laplace operator on a L -shaped domain with refined mesh. $N_1 = 14$, $N_2 = 14$ and N_Γ increasing.

As expected, we get similar results as before with a discretization of the interface which is different. A difference in the approximation of the fifth eigenvalue can be noticed. This can be explained by the fact that we have a good approximation of the fixed interface modes and coupling modes of “high energy” with polynomial discretization.

It is noteworthy that component mode synthesis more or less captures the singularity of the global normal modes, thanks to the coupling modes only. As a matter of fact, fixed interface modes are smooth up to the boundary. However, the computed singularity depends on the geometry of the domain decomposition and therefore cannot represent exactly the singularity of the global modes.

It is interesting to compare the number of fixed interface modes to take into account in each subdomain. Since subdomain 1 is larger than subdomain 2, the corresponding fixed interface eigenvalues are smaller on subdomain 1 than on subdomain 2. Then the decay of the error regarding the corresponding modes tends to confirm the error bounds (10) that holds for the Laplace operator also.

5.3 Test 3.

Here the method is applied to a problem of flexural vibrations of a Kirchhoff-Love plate clamped on one side. The decomposition in two subdomains is done as on figure 15, such that subdomain 2 is nowhere clamped.

The reader may be surprised not to find in this paper the relevant mechanical setting nor the formulation of our component mode synthesis method either. The careful analysis of plate-like problems will be developed elsewhere. Nevertheless, the method works also in this case. The following tests are given for the sake of completeness and show its versatility.

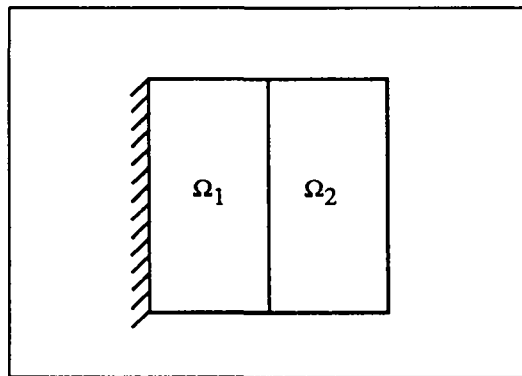

Figure 15: *The clamped plate and its decomposition.*

On a regular uniform triangulation we use a conforming finite element of low degree called reduced-HCT element (see Ciarlet [1978]), with an order of convergence in $O(h)$ in energy norm.

As in test 2, we give the relative error $err^k(N_1, N_2, N_\Gamma, h)$ for eigenpairs $k = 1 (+)$, $k = 2 (*)$, and $k = 5 (o)$, where the eigenpairs (λ_k^h, u_k^h) are computed with a classical global method. Figures 16, 17 and 18 give the error decay when N_1, N_2 and N_Γ increase.

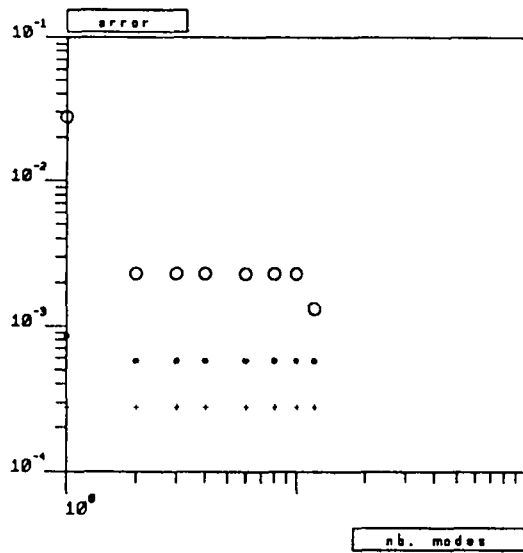

Figure 16: *Error for Kirchhoff-Love plate. $N_\Gamma = 10$, $N_2 = 12$ and N_1 increasing.*

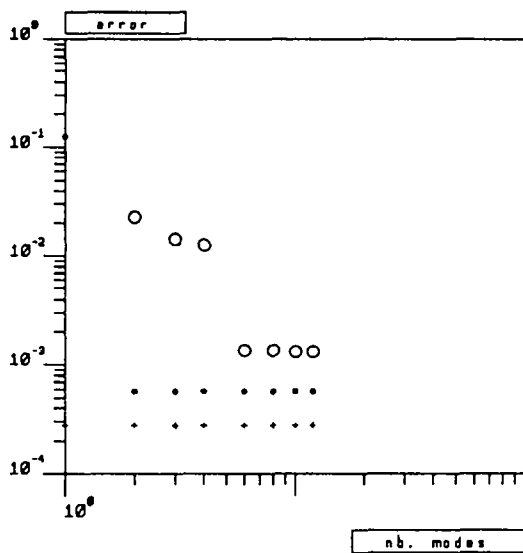

Figure 17: *Error for Kirchhoff-Love plate. $N_\Gamma = 10$, $N_1 = 12$ and N_2 increasing.*

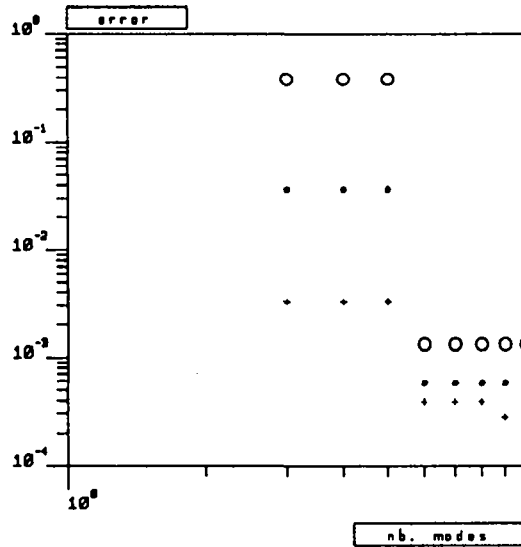

Figure 18: *Error for Kirchhoff-Love plate. $N_1 = 12$, $N_2 = 12$ and N_Γ increasing.*

5.4 Test 4.

We finally consider a problem in three-dimensional linearized elasticity: a square-shaped beam of section 1 and length 4 is clamped at one end (see figure 19). It can be decomposed in four unit cubes with only one having external clamping boundary condition. The problem is discretized with piecewise linear functions over a uniform mesh composed with tetrahedra (P1-Lagrange).

We have 648 degrees of freedom per subdomain and 324 degrees of freedom on the interface. Table 2 gives here again the error between the eigenvalues computed by a global method and by modal synthesis with:

$$N_1 = N_2 = N_3 = N_4 = 3, \quad N_\Gamma = 5.$$

k	1	2	3
err^k	$3.46 \cdot 10^{-3}$	$3.62 \cdot 10^{-3}$	$8.02 \cdot 10^{-3}$

Table 2.

The figures 20 and 21, display respectively the first and third global normal mode shapes computed with the global finite element method and the first and third coupling mode shapes. If we compare those figures, it is difficult to see any difference. This illustrates the fact that our choice of coupling modes gives a good representation of

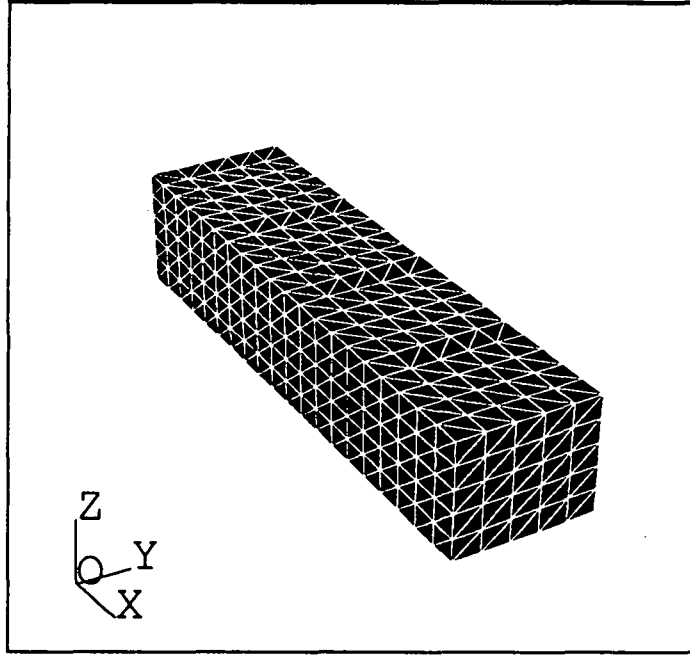

Figure 19: *The square-shaped beam and its mesh.*

the global solution.

Remark. Based on our experience, it is worthy to note that mass lumping modifies the spectrum of the Poincaré-Steklov operator, but leaves the *component mode synthesis solutions* $(\lambda_k^{N,h}, u_k^{N,h})$ *unchanged*. For this test, the matrix C (§4.3) is taken equal to identity. This insensitivity makes the method easier to implement in existing finite element codes. \square

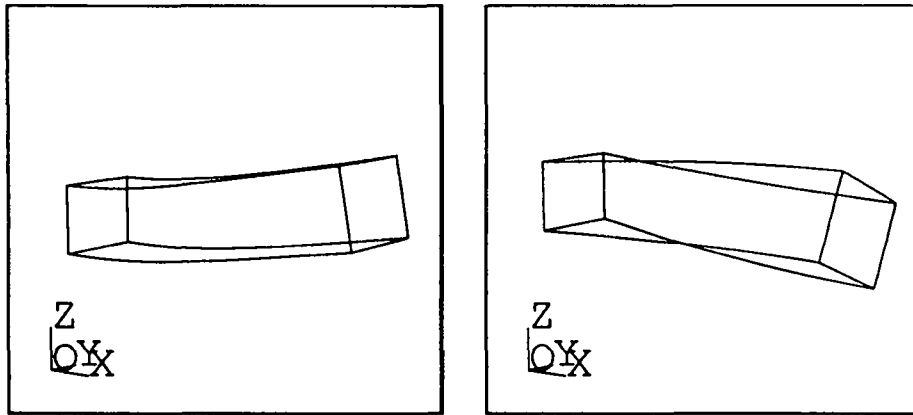

Figure 20: *The first (left) and third (right) normal modes for a three-dimensional elastic beam by a global method.*

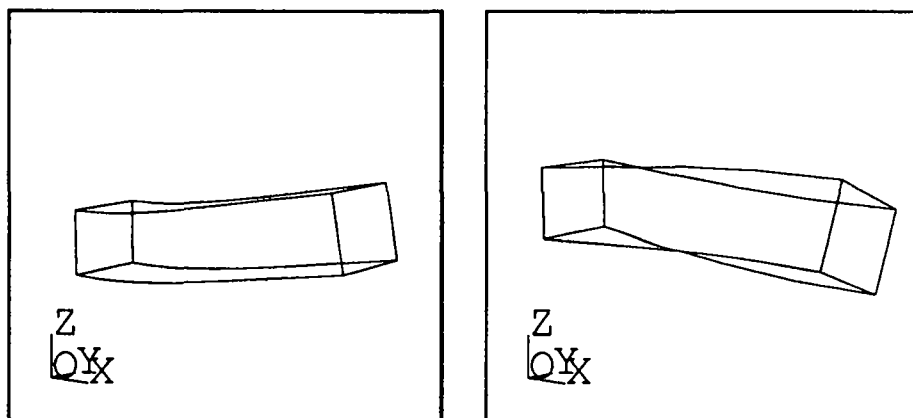

Figure 21: *The first (left) and third (right) coupling modes for a three-dimensional elastic beam.*

6 Concluding remarks.

This paper reports on a new fixed interface component mode synthesis that has been presented both in a continuous and in a discretized framework. A non-conventional intrinsic choice of constraint (coupling) modes is proposed, and leads to a robust and accurate substructuring strategy. Let us now comment on specific aspects of this method.

(i) When a very coarse mesh is used in the vicinity of the interface, that is when the latter is represented by a small number of degrees of freedom, the classical fixed interface method should be preferred. However, as soon as reasonably large three-dimensional finite element problems are considered, forming the stiffness matrix of Hurty's method may become impossible (see §4.2). In our algorithm, the number of iteration steps is not sensitive to the discretization; CPU time and storage requirement only depend on the number of unknowns *in* each subdomain. This makes the method of great interest for large three-dimensional problems having a lot of unknowns on the interface.

(ii) Let us emphasize that the method presented here does not depend on the choice of the algorithm that solves for the coupling modes. The Lanczos procedure is not the only one possible, and although we think that it is the most suitable one here, subspace iterations could be thought of as well. In the same way, the algorithm that inverts the interfacial stiffness matrix (§4.4) may be replaced by a more efficient one. The algorithm proposed by Bramble & Pasciak & Schatz [1986], or Bjorstad & Widlund [1986] may work faster but cannot be used in every case. On the other hand, d'Hennezel [1990] has recently proposed a new efficient preconditioner that works for a lot of realistic decompositions. The current development of such domain decomposition algorithms for source problems warrants the potential efficiency of our component mode synthesis method in the near future.

(iii) Let us recall that the most time consuming step of industrial scientific computing is by far geometry and mesh generation. Since linear static analysis is usually performed before modal analysis, using the "static" (fine) mesh for the latter clearly leads to a great increase of engineering efficiency, even if this static mesh is a priori much too refined for modal analysis. But this demand can be fulfilled only thanks to a method yielding reasonably accurate results sufficiently fast; this capability is provided by the proposed strategy.

(iv) Based on our experience, the mass matrix C of the interface Γ needs not be computed. Various simple strategies of mass lumping have been tested. We do not know how to decide where to distribute the mass along the interface. A similar question has been raised by Destuynder [1989]. For implementation purposes, we thus recommend the simplest discretization independent strategy, that is to choose the identity matrix.

(v) The idea of using the Poincaré-Steklov operator as a tool for generating basis functions in view of a Ritz procedure can be traced back in El-Raheb & Wagner [1981,eq16], but their practical computation seems to appeal to the knowledge of the

interfacial stiffness matrix, that we do not want to compute, and the numerical analysis of the operator is not addressed.

(vi) Finally, the question of whether our choice of coupling modes is optimal or not has received a positive answer from a purely numerical point of view. As a matter of fact, one could think of saving computer efforts by computing a rough approximation of those modes, either by performing a coarse resolution of the Poincaré-Steklov operator, or by decreasing the dimension of the Krylov subspace in the Lanczos procedure. Unfortunately, in both cases *the accuracy of the final result of component mode synthesis deteriorates for a given number of coupling modes*. Therefore, those modes have to be computed very carefully and seem to represent quite well a major part of the global dynamic behaviour.

REFERENCES

- AGOSHKOV, V.I. [1988]: Poincaré-Steklov's operators and domain decomposition methods in finite dimensional spaces, in *Proceedings of the first international symposium on decomposition methods for partial differential equations* (R. GLOWINSKI, G.H. GOLUB, J.PERIAUX, eds), Paris, SIAM editor, Philadelphia 1988.
- AUFRANC, M. [1990a]: Junctions between three-dimensional and two-dimensional non-linearly elastic structures, to appear in *Asymptotic Analysis*.
- AUFRANC, M. [1990b]: Sur quelques problèmes de jonctions dans les multistructures élastiques, *Thèse de l'Université Pierre et Marie Curie, Paris*.
- BABUŠKA, I.; DORR, M.R. [1981]: Error estimates for the combined h and p version of the finite element method, *Numer. Math.*, **37**, pp. 515-545.
- BERNADOU,; M. FAYOLLE, S.; LENE, F. [1988]: Numerical analysis of junctions between plates, INRIA report Nb 865, july 1988.
- BJORSTAD, P.E.; WIDLUND, O.B. [1986]: Iterative methods for the solution of elliptic problems on regions partitioned into substructures., *SIAM J. Numer. Ana.*, **23**, pp. 1097-1120.
- BOURGAT, J.F.; GLOWINSKI, R.; LE TALLEC, P. [1988]: Formulation variationnelle et algorithme de décomposition de domaines pour les problèmes elliptiques, *C.R. Acad. Sci. Paris, Sér. I*, **306**, pp. 569-572.
- BOURGAT, J.F.; GLOWINSKI, R.; LE TALLEC, P.; VIDRASCU, M. [1988]: Variational formulation and algorithm for trace operator in domain decomposition calculations, INRIA report 804, mars 1988.
- BOURQUIN, F. [1989]: Synthèse modale d'opérateurs elliptiques du second ordre, *C.R. Acad. Sci., Paris, Sér. I*, **309**, pp. 919-922.
- BOURQUIN, F. [1990a]: Analysis and comparison of several component mode synthesis methods on one-dimensional domains, to appear in *Numer. Math.*.
- BOURQUIN, F. [1990b]: Domain decomposition and eigenvalues of second order operators: convergence analysis. to appear in *J. Math. Pures Appl.*.
- BOURQUIN, F. [1990c]: Component mode synthesis and eigenvalues of second order operators: discretization and algorithm, submitted to *RAIRO Modélisation Math. Numer. Ana.*.
- BOURQUIN, F. [1990d]: Doctoral dissertation, in preparation.

- BOURQUIN, F.; CIARLET, P.G. [1989]: Modeling and justification of eigenvalue problems for junctions between elastic structures, *J. Functional Anal.*, **87**, pp. 392-427.
- BRAMBLE, J.H.; PASCIAK, J.E.; SCHATZ, A.H. [1986]: An iterative method for elliptic problems on regions partitioned into substructures, *Math. Comp.*, **46**, pp.361-369.
- CIARLET, P.G. [1978]: *The Finite Element Method for Elliptic Problems*, North-Holland, Amsterdam New-York, 1978.
- CIARLET, P.G. [1990]: *Plates and Junctions in Elastic Multi-Structures: an asymptotic analysis*, Collection RMA, Masson, Paris, 1990.
- CIARLET, P.G.; LE DRET, H.; NZENGWA, R. [1989]: Junctions between three-dimensional and two-dimensional linearly elastic structures, *J. Math. Pures Appl.*, **68**, pp. 261-296.
- CRAIG, R.; BAMPTON, M.C.C. [1968]: Coupling of substructures for dynamic analysis, *A.I.A.A. Journal*, **6**, pp. 1313-1321.
- CRAIG, R.R. JR. [1985]: A review of time domain and frequency domain component mode synthesis methods, joint ASCE/ASME mechanics conference, Albuquerque, New Mexico, June 24-26, A.M.D. vol.67, 1985.
- DAUGE, M. [1988]: *Elliptic Boundary Value Problems on Corner Domains*, Lecture notes in mathematics, 1341, Springer, 1988.
- DESTUYNDER, PH. [1989]: Remarks on dynamic substructuring, *Eur. J. Mech. A/Solids*, **8**, 201-218.
- DOOR, M.R. [1989]: On the discretization of interdomain coupling in elliptic boundary value problems, in *Domain decomposition methods*, (T. Chang, R. Glowinski, J. Periaux, O. Widlund eds), SIAM, proceedings of the second international symposium on domain decomposition methods, Los Angeles, California, jan 1988.
- EL-RAHEB, M.; WAGNER, P. [1981]: Vibration of a liquid with free surface in a spinning spherical tank, *Journal of Sound and Vibration*, **76** , pp. 83-93.
- GLADWELL, B.M.L. [1964]: Branch mode analysis of vibrating systems, *Journal of Sound and Vibration*, **1**, pp.41-59.
- GOLDMAN, R.L. [1969]: Vibration analysis of dynamic partitioning, *AIAA Journal*, **7**, pp. 1152-1154.
- GOLUB, G.H.; UNDERWOOD, R.; WILKINSON, J.H. [1972]: The Lanczos algorithm for the symmetric $Au = \lambda Bu$ problem; STAN CS 72-270, March 1972, Computer Science Department, Stanford University.
- GIBERT, R.J. [1988]: *Vibrations des structures, Interactions avec les fluides, Sources d'excitations aléatoires*, cours de l'école d'été d'analyse numérique CEA INRIA EDF, 1986, collection de la Direction des Etudes et Recherches d' Electricité de France, Eyrolles, 1988.

- GRISVARD, P. [1985]: *Elliptic Problems in Non-Smooth Domains*, Pitman, London, 1985.
- GRISVARD, P. [1989]: Singularités en élasticité, *Arch. Rational Mech. Anal.*, **107**, pp. 157-180.
- D'HENNEZEL, F. [1990]: Opérateur d'interface non symétrique pour les méthodes de décomposition de domaine, in preparation.
- HALE, A.L.; MEIROVITCH, L. [1980]: A general substructure synthesis method for the dynamic simulation of complex structures, *Journal of Sound and Vibration*, **69**, pp. 309-326.
- HURTY, W.C. [1965]: Dynamic analysis of structural systems using component modes, *AIAA Journal*, **4**, pp. 678-685.
- IMBERT, J.F. [1979]: *Calcul des structures par éléments finis*, Cépadués, 1979.
- JEZEQUEL, L. [1985]: Synthèse modale: théorie et extensions, *thèse d'état, Université Claude Bernard, Lyon*.
- KONDRATIEV, V.A. [1967]: Boundary problems for elliptic equations in domains with conical or angular points, *Trans. Moscow Math. Soc.*, **16**, pp. 227-313.
- LASCAUX, P.; THEODOR, R. [1989]: *Analyse Numérique Matricielle Appliquée à l'Art de l'Ingénieur*, Masson, Paris, 1986.
- LE DRET, H. [1987]: Modélisation d'une plaque pliée, *Computational Mechanics*, **5**, pp. 401-416.
- LEGUILLON, D.; SANCHEZ PALENCIA, E. [1987]: *Computation of singular solutions in elliptic problems and elasticity*, collection RMA, Masson, Paris, 1987.
- MAC NEAL, R.H. [1971]: A hybrid method of component mode synthesis, *Computers and Structures*, **1**, pp. 581-560.
- MEIROVITCH, L. [1980]: *Computational Methods in Structural Dynamics*, Sijthoff & Noordhoof, 1980.
- MORAND, H. [1977]: Méthodes de détermination approchée des modes propres de vibration en calcul des structures; sous-structuration dynamique. ONERA R.T. n 2 — 3238 RY OOR, 1977.
- MORAND, H.; OHAYON, R. [1979]: Substructure variational analysis of the vibrations of coupled fluid-structure systems. Finite element results, *Int. J. Numer. Methods Engrg.*, **14**, pp. 741-755.
- DE ROECK, Y.H.; LE TALLEC, P.; VIDRASCU, M. [1988]: Domain decomposition methods for large linearly elliptic three-dimensional problems, INRIA report 1182, mars 1990.
- RUBIN, S. [1975]: Improved component mode representation for structural dynamic analysis, *AIAA Journal*, **13**, pp. 995-1006.

- TAYLOR, A.E. [1958]: *Introduction to Functional analysis*, Wiley, New-York, 1958.
- VALID, R. [1977]: *La Mécanique des Milieux Continus et le Calcul des Structures*, Collection de la Direction des Etudes et Recherches d'Electricité de France, Eyrolles, 1977.
- VALID, R. [1982]: Une méthode de calcul des structures au flambage par sous structuration et synthèse modale, *C.R. Acad. Sci. Paris, Sér. II*, **294**, pp. 299-302.
- VALID, R.; OHAYON, R. [1974]: Influence du ballottement dans les réservoirs des bouts d'ailes sur les modes propres de vibration d'un avion, *La Recherche Aéronautique*, 1974-5, pp. 319-325.
- WANG, H.R.; CHEN, H.R. [1990]: A substructure modal synthesis method with high computational efficiency, *Comput. Meth. Applied Mech. Engrg.*, **79**, pp. 203-217.

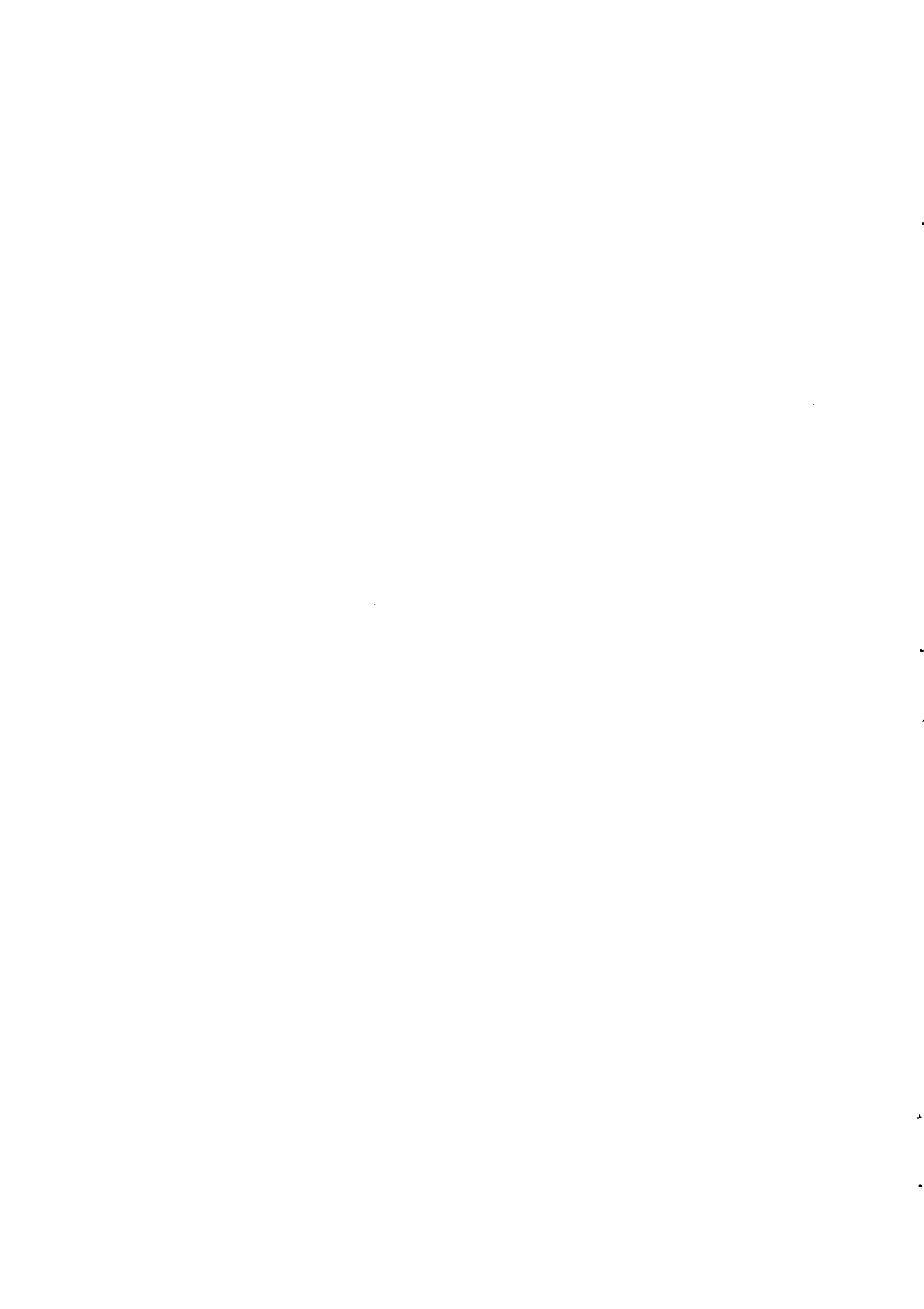

ISSN 0249 - 6399