



HAL
open science

A Characterisation of independence for competing Markov chains with applications to stochastic Petri nets

Richard J. Boucherie

► **To cite this version:**

Richard J. Boucherie. A Characterisation of independence for competing Markov chains with applications to stochastic Petri nets. [Research Report] RR-1880, INRIA. 1993. inria-00074793

HAL Id: inria-00074793

<https://inria.hal.science/inria-00074793>

Submitted on 24 May 2006

HAL is a multi-disciplinary open access archive for the deposit and dissemination of scientific research documents, whether they are published or not. The documents may come from teaching and research institutions in France or abroad, or from public or private research centers.

L'archive ouverte pluridisciplinaire **HAL**, est destinée au dépôt et à la diffusion de documents scientifiques de niveau recherche, publiés ou non, émanant des établissements d'enseignement et de recherche français ou étrangers, des laboratoires publics ou privés.



UNITÉ DE RECHERCHE
INRIA-SOPHIA ANTIPOLIS

Institut National
de Recherche
en Informatique
et en Automatique

2004 route des Lucioles
B.P. 93
06902 Sophia-Antipolis
France

Rapports de Recherche

N°1880

Programme 1

*Architectures parallèles, Bases de données,
Réseaux et Systèmes distribués*

A CHARACTERISATION OF INDEPENDENCE FOR COMPETING MARKOV CHAINS WITH APPLICATIONS TO STOCHASTIC PETRI NETS

Richard J. BOUCHERIE

A characterisation of independence for competing Markov chains with applications to stochastic Petri nets*

Richard J. Boucherie[†]
INRIA Centre Sophia Antipolis,
B.P. 93, 06902 Sophia Antipolis Cedex, France

Abstract

This paper shows that recently obtained product form results for stochastic Petri nets can immediately be obtained as a special case of a simple exclusion mechanism for the product process of a collection of Markov chains.

Keywords: Petri nets, product form, resource sharing, competing processes.

*Supported by the European Grant BRA-QMIPS of CEC DG XIII.

[†]ERCIM fellow at INRIA from September 1st, 1992 to May 31st, 1993. ERCIM stands for European Research Consortium for Informatics and Mathematics and comprises 9 institutes: CWI (The Netherlands), CNR (Italy), FORTH (Greece), GMD (Germany), INRIA (France), INESC (Portugal), RAL (UK), SICS (Sweden), SINTEF DELAB (Norway).

Une caractérisation d'indépendance pour les chaînes de Markov avec compétition et applications aux réseaux de Petri stochastiques

Richard J. Boucherie

INRIA Centre Sophia Antipolis,
B.P. 93, 06902 Sophia Antipolis Cedex, France

Résumé

Cet article montre que les formes produits récemment trouvées pour les réseaux de Petri stochastiques peuvent être établies comme cas spécial d'un simple processus d'exclusion pour le processus produit d'une collection de chaînes de Markov.

1 Introduction

In the literature on queueing networks in equilibrium product form distributions play a vital role, and many product form queueing networks have been discovered. For example Jackson networks (Jackson [5]), and their generalisation to BCMP-networks (Baskett *et al.* [1]) play a fundamental role in the queueing network literature. In contrast, for stochastic Petri nets product form results seem to be less common. An immediate explanation of the discrepancy between queueing networks and Petri nets is that resource sharing and competition over resources cannot be modelled by queueing networks. It are these properties of stochastic Petri nets that destroy product form equilibrium distributions. An interesting exception are the Petri nets described in Lazar and Robertazzi [9]. In this reference conditions are given under which a Petri net has a product form equilibrium distribution. These conditions basically come down to independence conditions on ‘firing sequences’ in subnets of the Petri net. As a consequence, also if competition over resources occurs, these authors obtain a product form distribution. It must be noted here, that the results obtained in Lazar and Robertazzi [9] are valid for Petri nets containing linear firing sequences only, and that in each place of the Petri net at most one token is allowed (safe Petri net).

A second approach to obtain product forms for stochastic Petri nets is given in Henderson and Taylor [4]. In this reference the product form results obtained for batch routing queueing networks obtained in Henderson and Taylor [3] are extended to Petri nets. It is shown that for fairly general state dependent firing probabilities the equilibrium distribution of a stochastic Petri net has a product form if the output bag (the tokens released by a transition) is an input bag (the tokens needed to fire a transition) for some other transition. This is a condition similar to local balance for queueing networks, but does not immediately characterize independence of subnets.

Donatelli and Sereno [2] discuss the relation between the product form results obtained by Lazar and Robertazzi [9] and Henderson and Taylor [4]. Since Lazar and Robertazzi [9] do not consider state dependent firing rates only state independent firing rates are discussed. As is shown by Donatelli and Sereno [2], the results of Lazar and Robertazzi [9] can be translated into a net level characterization if so-called T -invariants (Murata [13], p. 568) are used to describe the firing sequences used in Lazar and Robertazzi [9]. It is shown that a stochastic Petri net has a product form equilibrium distribution (where the product form represents a product of terms, one for each place of the Petri net) if each minimal T -invariant is closed, that is each output bag is also an input bag. This immediately establishes the equivalence between the conditions used in Lazar and Robertazzi [9] and Henderson and Taylor [4]. Note, however, that the product form results obtained in these two references are not of the same type. In Henderson and Taylor [4] sufficient conditions are given for a product form equilibrium distribution of the form found for queueing networks, whereas in Lazar and Robertazzi [9] a first step is made in the characterization of independence between Petri nets that compete over resources. Therefore, although the product forms and the underlying conditions in these references are similar, the ideas to obtain the product form results are different.

The present paper aims to generalize the results obtained Lazar and Robertazzi [9] to Petri nets consisting of arbitrary subnets if an ‘independence condition’ similar to the condition given in Lazar and Robertazzi [9] and Donatelli and Sereno [2] is satisfied. Emphasis will not be on equilibrium distributions that are a product of terms, one for each place, but on equilibrium distributions that are a product of terms, one for each subnet, as this characterizes independence of the subnets. As a consequence, general state-dependent service and routing is included. Independence of the places as characterized by the product forms obtained in Lazar and Robertazzi [9] and Donatelli and Sereno [2] may be obtained as an additional result for special choices of the subnets. As is shown in several examples, the results obtained here generalise the results obtained in Lazar and Robertazzi [9] to include Petri nets with multiple tokens in places, and non-linear firing sequences.

The framework used in this paper is that of a collection of Markov chains. For this collection the product process is introduced: let S_k , q_k , $k = 1, \dots, K$, be the state spaces resp. transition rates of the Markov chains in the collection, then $S = S_1 \times \dots \times S_K$ is the state space of the product process, and the transition rates of the product process in dimension k are given by q_k . It is assumed in this framework that in each transition of the product process the state in one dimension changes only, that is in each transition of the product process one of the underlying Markov chains changes its state only. Competition over resources can then be modelled as exclusion of a part of the state space S , say the product process cannot enter $A \subset S$. The independence condition guaranteeing product form roughly states that *if the product process is in state $\bar{n} = (\bar{n}_1, \dots, \bar{n}_k, \dots, \bar{n}_K)$, where $\bar{n}_i \in S_i$, and $\bar{n}' \in A$, where $\bar{n}' = \bar{n}$ except for component \bar{n}_k (i.e. $\bar{n}'_k \neq \bar{n}_k$, $\bar{n}_i = \bar{n}'_i$, $i \neq k$) then Markov chain k cannot change its state.* Under this condition the product process has a product form equilibrium distribution at $S \setminus A$ given by

$$\pi(\bar{n}) = B \prod_{k=1}^K \pi_k(\bar{n}_k),$$

where π_k is the equilibrium distribution of Markov chain k at state space S_k , and B is a normalising constant determined by the exact form of A .

Section 2 describes the model, and Section 3 gives several examples of exclusion/competition mechanisms that can be modelled in the framework of this paper.

2 Model

Consider a collection of K stable, regular, continuous-time Markov chains, labelled $k = 1, \dots, K$, at finite or countable state spaces S_k , $k = 1, \dots, K$. Let $\bar{n}_k \in S_k$ and denote the transition rates of Markov chain k by $q_k = (q_k(\bar{n}_k, \bar{n}'_k), \bar{n}_k, \bar{n}'_k \in S_k)$. Assume that each Markov chain is irreducible at S_k and possesses a unique equilibrium distribution $\pi_k = (\pi_k(\bar{n}_k), \bar{n}_k \in S_k)$ at S_k , $k = 1, \dots, K$, that is π_k is the unique solution to the global balance equations for Markov chain k at S_k :

$$\sum_{\bar{n}'_k \in S_k} \{\pi_k(\bar{n}_k)q_k(\bar{n}_k, \bar{n}'_k) - \pi_k(\bar{n}'_k)q_k(\bar{n}'_k, \bar{n}_k)\} = 0, \quad \bar{n}_k \in S_k.$$

We will now impose pair-wise relations on the Markov chains which allow us to model various types of competition and to formally introduce resources.

Definition 2.1 (Competition) Let I be an index set. For each k , let A_{ki} , $i \in I$, be a set of mutually exclusive sets such that $\emptyset \neq A_{ki} \subset S_k$, and $\cup_{i \in I} A_{ki} = S_k$, $k = 1, \dots, K$. Markov chain k uses resource i , if the Markov chain is in a state $\bar{n}_k \in A_{ki}$. Markov chain k_1 and k_2 compete over resource i if $\{\bar{n}_{k_1}, \bar{n}_{k_2} : \bar{n}_{k_1} \in A_{k_1 i}, \bar{n}_{k_2} \in A_{k_2 i}\} = \emptyset$. Let $C_{ki} \subset \{1, \dots, K\}$ be the Markov chains that compete over resource i with Markov chain k .

Definition 2.2 (Product process) The Markov chain at state space

$$S = \prod_{k=1}^K S_k, \quad (1)$$

with transition rates

$$q(\bar{n}, \bar{n}') = \sum_{k=1}^K q_k(\bar{n}_k, \bar{n}'_k) \prod_{r=1, r \neq k}^K c_r(\bar{n}_r) \mathbf{1}(\bar{n}_r = \bar{n}'_r) \mathbf{1}(\text{if } i : \bar{n}_r \in A_{ri} \text{ then } k \notin C_{ri}),$$

where $\bar{n} = (\bar{n}_1, \dots, \bar{n}_K)$, $\bar{n}' = (\bar{n}'_1, \dots, \bar{n}'_K)$, is called the product process of the collection of Markov chains $1, \dots, K$ competing over resources I .

Remark 2.3 (Transition rates) The transition rates of the product process are such that in each transition exactly one \bar{n}_k can change. This is further illustrated in the example below. The coefficients $c_r(\bar{n}_r)$, $r = 1, \dots, K$, are added for mathematical generality. They will not appear in the equilibrium distribution of the product process, and can be seen as an additional competition mechanism. These coefficients will not be further illustrated in the paper.

Remark 2.4 (Trivial case) Observe that for $I = \{1\}$ we have $A_{k1} = S_k$. In this case the Markov chains are independent. This can immediately be seen from the definition since either $\{\bar{n}_{k_1}, \bar{n}_{k_2} : \bar{n}_{k_1} \in A_{k_1 1}, \bar{n}_{k_2} \in A_{k_2 1}\} = \emptyset$ for some pair (k_1, k_2) or $\{\bar{n}_{k_1}, \bar{n}_{k_2} : \bar{n}_{k_1} \in A_{k_1 1}, \bar{n}_{k_2} \in A_{k_2 1}\} \neq \emptyset$ for all (k_1, k_2) . In the first case $S = \emptyset$, and the product process is not defined; in the second case all Markov chains operate without influence of the others. \square

Example 2.5 (Two processes) To help intuition, consider the product process for a collection of 2 Markov chains. In this case, let $I = \{1, 2\}$, $S_1 = A_{11} \cup A_{12}$, $S_2 = A_{21} \cup A_{22}$, and assume that the Markov chains compete over resource 2, that is a state $\bar{n} = (\bar{n}_1, \bar{n}_2)$, where $\bar{n}_1 \in A_{12}$, $\bar{n}_2 \in A_{22}$ cannot occur. The product process has state space

$$S = S_1 \times S_2,$$

and transition rates

$$q(\bar{n}, \bar{n}') = q_1(\bar{n}_1, \bar{n}'_1) \mathbf{1}(\bar{n}_2 = \bar{n}'_2 \in A_{21}) + q_2(\bar{n}_2, \bar{n}'_2) \mathbf{1}(\bar{n}_1 = \bar{n}'_1 \in A_{11}).$$

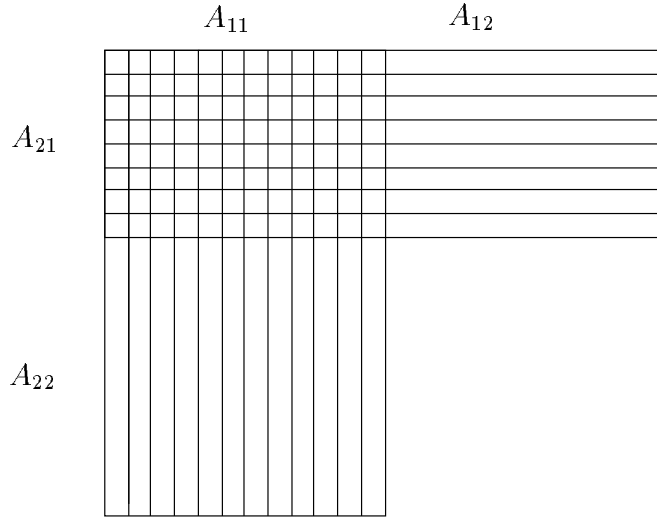

Figure 1: State space for two competing Markov chains

Observe that these transition rates imply that in each transition only one process can change its state, and that process 1 is stopped when process 2 is using resource 2, and vice versa. This is indicated in Figure 1, where the lines indicate the direction in which transitions can occur. An important consequence of this stopping mechanism is that the product process cannot enter the region $A_{12} \times A_{22}$ of the state space. Therefore, in the definition of the product process (1) can be replaced by $S = S_1 \times S_2 \setminus A_{12} \times A_{22}$, or in general

$$S = \prod_{k=1}^K S_k \setminus \prod_{k=1}^K \prod_{i \in I} \prod_{j \in C_{ki}} A_{ki} \times A_{ji}. \quad (2)$$

□

The following theorem gives the equilibrium distribution of the product process. Note that this equilibrium distribution is defined on S as given in (2). At the other states of S as defined in (1) we obtain from the exclusion mechanism in the transition rates that $\pi(\bar{n}) = 0$.

Theorem 2.6 (Product-form distribution) *The product process of the collection of Markov chains $1, \dots, K$ competing over resources I has equilibrium distribution π at S as defined in (2) given by*

$$\pi(\bar{n}) = B \prod_{k=1}^K \pi_k(\bar{n}_k), \quad \bar{n} \in S,$$

where B is a normalising constant, determined by the exact form of S .

Proof It is sufficient to show that π satisfies the global balance equations at S . Insertion of π into global balance gives:

$$\sum_{\bar{n}' \in S} \{\pi(\bar{n})q(\bar{n}, \bar{n}') - \pi(\bar{n}')q(\bar{n}', \bar{n})\}$$

$$\begin{aligned}
&= \sum_{\bar{n}'} \left\{ \pi(\bar{n}) \sum_{k=1}^K q_k(\bar{n}_k, \bar{n}'_k) \prod_{r=1, r \neq k}^K c_r(\bar{n}_r) \mathbf{1}(\bar{n}_r = \bar{n}'_r) \mathbf{1}(\text{if } i : \bar{n}_r \in A_{ri} \text{ then } k \notin C_{ri}) \right. \\
&\quad \left. - \pi(\bar{n}') \sum_{k=1}^K q_k(\bar{n}'_k, \bar{n}_k) \prod_{r=1, r \neq k}^K c_r(\bar{n}'_r) \mathbf{1}(\bar{n}'_r = \bar{n}_r) \mathbf{1}(\text{if } i : \bar{n}'_r \in A_{ri} \text{ then } k \notin C_{ri}) \right\} \\
&= \sum_{k=1}^K \sum_{\bar{n}'_k \in S_k} \{ \pi_k(\bar{n}) q_k(\bar{n}_k, \bar{n}'_k) - \pi_k(\bar{n}'_k) q_k(\bar{n}'_k, \bar{n}_k) \} \\
&\quad \times B \prod_{r=1, r \neq k}^K c_r(\bar{n}_r) \pi_r(\bar{n}_r) \mathbf{1}(\text{if } i : \bar{n}'_r \in A_{ri} \text{ then } k \notin C_{ri}) \\
&= 0,
\end{aligned}$$

where the last equality is obtained from global balance for each Markov chain separately. \square

The explanation of the above result is that for all $\bar{n} \in S$ for fixed value of \bar{n}_r , $r \neq k$, process k is either allowed to operate as if it was independent of the other processes (in this case $\mathbf{1}(\text{if } i : \bar{n}'_r \in A_{ri} \text{ then } k \notin C_{ri}) = 1$), or process k is completely stopped (in this case $\mathbf{1}(\text{if } i : \bar{n}'_r \in A_{ri} \text{ then } k \notin C_{ri}) = 0$). In both cases process k satisfies its global balance equations, since this is true when process k operates on its own ($\mathbf{1}(\cdot) = 1$), and it is trivially true if process k is stopped. As a consequence, the exclusion principle incorporated in the transition rates of the product process basically comes down to a redefinition of the product process such that the Markov chains in the collection operate as if they are independent.

Example 2.7 (Two processes, continued) The equilibrium distribution of the Markov chain at state space indicated in Figure 1 is

$$\pi(\bar{n}) = B \pi(\bar{n}_1, \bar{n}_2) = B \pi_1(\bar{n}_1) \pi_2(\bar{n}_2), \quad \bar{n} \in S.$$

This can immediately be verified by insertion into global balance:

$$\begin{aligned}
&\sum_{\bar{n}' \in S} \{ \pi(\bar{n}) q(\bar{n}, \bar{n}') - \pi(\bar{n}') q(\bar{n}', \bar{n}) \} \\
&= \sum_{\bar{n}'_1 \in S_1} \{ \pi_1(\bar{n}_1) q_1(\bar{n}_1, \bar{n}'_1) - \pi_1(\bar{n}'_1) q_1(\bar{n}'_1, \bar{n}_1) \} \pi_2(\bar{n}_2) \quad \text{if } \bar{n} \in A_{12} \times A_{21} \\
&= \sum_{\bar{n}'_2 \in S_2} \{ \pi_2(\bar{n}_2) q_2(\bar{n}_2, \bar{n}'_2) - \pi_2(\bar{n}'_2) q_2(\bar{n}'_2, \bar{n}_2) \} \pi_1(\bar{n}_1) \quad \text{if } \bar{n} \in A_{11} \times A_{22} \\
&= \sum_{\bar{n}'_1 \in S_1} \{ \pi_1(\bar{n}_1) q_1(\bar{n}_1, \bar{n}'_1) - \pi_1(\bar{n}'_1) q_1(\bar{n}'_1, \bar{n}_1) \} \pi_2(\bar{n}_2) \\
&\quad + \sum_{\bar{n}'_2 \in S_2} \{ \pi_2(\bar{n}_2) q_2(\bar{n}_2, \bar{n}'_2) - \pi_2(\bar{n}'_2) q_2(\bar{n}'_2, \bar{n}_2) \} \pi_1(\bar{n}_1) \quad \text{if } \bar{n} \in A_{11} \times A_{21}.
\end{aligned}$$

In each case global balance is satisfied since the processes in the collection satisfy global balance at their respective state spaces. \square

If Markov chain k satisfies local balance with respect to some subset of transitions the result of Theorem 2.6 can be strengthened to incorporate this form of local balance. To this end, assume that the transition rates for Markov chain k can be separated into R_k parts, labelled $r = 1, \dots, R_k$. For $\bar{n}_k, \bar{n}'_k \in S_k$, define transition rates $q_k^{(r)}(\bar{n}_k, \bar{n}'_k)$, $r = 1, \dots, R_k$ such that

$$q_k(\bar{n}_k, \bar{n}'_k) = \sum_{r=1}^{R_k} q_k^{(r)}(\bar{n}_k, \bar{n}'_k). \quad (3)$$

We say that Markov chain k is locally balanced with respect to the separation (3) if the equilibrium distribution π_k satisfies

$$\sum_{\bar{n}'_k \in S_k} \left\{ \pi_k(\bar{n}_k) q_k^{(r)}(\bar{n}_k, \bar{n}'_k) - \pi_k(\bar{n}'_k) q_k^{(r)}(\bar{n}'_k, \bar{n}_k) \right\} = 0, \quad r = 1, \dots, R_k.$$

Observe that this reduces to standard local balance if we consider Jackson networks (Jackson [5]).

Observe that the process with transition rates $q_k^{(r)}$ is a Markov chain on its own. This Markov chain will be labelled (k, r) . In contrast with the setting of Theorem 2.6, we now have several Markov chains operating on the same state space. We do not require, however, that each of these Markov chains uses the whole state space (cf. Example 3.3). Analogous to Definition 2.1 we can now introduce competition over the resources I between the thus obtained collection consisting of $R_1 + \dots + R_K$ Markov chains. This competition will be such that Markov chains on the same state space (e.g. chain $q_k^{(r_1)}$ and $q_k^{(r_2)}$) cannot compete over resources. This is natural, since such a competition would imply that Markov chain k competes with itself over resources. Therefore it is sufficient to introduce competition between Markov chains on different state spaces. Analogous to Definition 2.1, for each (k, r) , let $A_{(k,r),i}$ be mutually exclusive sets such that $A_{(k,r),i} \subset S_k$, and such that $\cup_{i \in I} A_{(k,r),i} \subset S_k$ (observe that Markov chain (k, r) is not required to use the whole state space S_k), and $\cup_{r=1}^{R_k} \cup_{i \in I} A_{(k,r),i} = S_k$. Furthermore, let $C_{(k,r),i} \subset \{(k', r') : k = 1, \dots, K, r = 1, \dots, R_k\}$ be the Markov chains that compete with Markov chain (k, r) over resource i , that is, if $(k', r') \in C_{(k,r),i}$ then $\{\bar{n}_k \in A_{(k,r),i}, \bar{n}_{k'} \in A_{(k',r'),i}\} = \emptyset$. The following theorem is a generalisation of Theorem 2.6 to incorporate local balance. Note that the assumption of local balance is more restrictive than the assumption of global balance in Theorem 2.6, but that the exclusion mechanism is more general.

Theorem 2.8 (Product process with local balance) *Assume that each Markov chain in the collection $k = 1, \dots, K$ satisfies local balance with respect to the separation (3). The Markov chain at state space*

$$S = \prod_{k=1}^K S_k \setminus \prod_{k=1}^K \prod_{i=1}^I \prod_{r=1}^{R_k} \prod_{(j,s) \in C_{(k,r),i}} A_{(k,r),i} \times A_{(j,s),i},$$

with transition rates

$$q(\bar{n}, \bar{n}') = \sum_{k=1}^K \sum_{p=1}^{R_k} q_k^{(p)}(\bar{n}_k, \bar{n}'_k) \prod_{s=1, s \neq k}^K c_s(\bar{n}_s) \mathbf{1}(\bar{n}_s = \bar{n}'_s) \prod_{r=1}^{R_s} \mathbf{1}(\bar{n}_s \in A_{(s,r),i} \text{ then } (k,p) \notin C_{(s,r),i}),$$

has an equilibrium distribution π at S given by

$$\pi(\bar{n}) = B \prod_{k=1}^K \pi_k(\bar{n}_k),$$

where B is a normalising constant.

Proof Similar to the proof of Theorem 2.6, it is sufficient to show that π satisfies global balance at S . Insertion of π into global balance gives

$$\begin{aligned} & \sum_{\bar{n}' \in S} \{ \pi(\bar{n})q(\bar{n}, \bar{n}') - \pi(\bar{n}')q(\bar{n}', \bar{n}) \} \\ &= \sum_{\bar{n}'} \left\{ \pi(\bar{n}) \sum_{k=1}^K \sum_{p=1}^{R_k} q_k^{(p)}(\bar{n}_k, \bar{n}'_k) \prod_{s=1, s \neq k}^K c_s(\bar{n}_s) \mathbf{1}(\bar{n}_s = \bar{n}'_s) \prod_{r=1}^{R_s} \mathbf{1}(\bar{n}_s \in A_{(s,r),i} \text{ then } (k,p) \notin C_{(s,r),i}) \right. \\ & \quad \left. - \pi(\bar{n}') \sum_{k=1}^K \sum_{p=1}^{R_k} q_k^{(p)}(\bar{n}'_k, \bar{n}_k) \prod_{s=1, s \neq k}^K c_s(\bar{n}'_s) \mathbf{1}(\bar{n}'_s = \bar{n}_s) \prod_{r=1}^{R_s} \mathbf{1}(\bar{n}'_s \in A_{(s,r),i} \text{ then } (k,p) \notin C_{(s,r),i}) \right\} \\ &= \sum_{k=1}^K \sum_{p=1}^{R_k} \left\{ \pi_k(\bar{n}_k) q_k^{(p)}(\bar{n}'_k, \bar{n}_k) - \pi_k(\bar{n}'_k) q_k^{(p)}(\bar{n}_k, \bar{n}'_k) \right\} \\ & \quad \times B \prod_{s=1, s \neq k}^K c_s(\bar{n}_s) \pi_s(\bar{n}_s) \mathbf{1}(\bar{n}_s = \bar{n}'_s) \prod_{r=1}^{R_s} \mathbf{1}(\bar{n}_s \in A_{(s,r),i} \text{ then } (k,p) \notin C_{(s,r),i}) \\ &= 0, \end{aligned}$$

where the last equality is obtained from local balance with respect to the separation (3) for each Markov chain separately. \square

Observe that the proof above is very similar to the proof of Theorem 2.6. In fact, Theorem 2.8 and its proof can immediately be obtained from Theorem 2.6 by the substitution $k \rightarrow (k, p)$, $r \rightarrow (s, r)$ in Theorem 2.6. This is a standard observation when the relation between global balance and local balance is discussed. Furthermore, note that Theorem 2.6 is a special case of Theorem 2.8, since we may set $R_k = 1$ for all k . Theorem 2.6 is added here because it illustrates the ideas behind the exclusion mechanism better than Theorem 2.8.

3 Examples

This section discusses several examples of situations in which competition over resources occurs that can be modelled in the framework of Section 2. Emphasis will be on examples of stochastic Petri nets with a product form equilibrium distribution. Example 3.1 presents the dining philosophers problem, a classical example often used to illustrate resource sharing. Example 3.2 presents a model for database locking that cannot be modelled as a stochastic Petri net. Example 3.3 gives the product form results obtained by Lazar and Robertazzi [9]. Finally, Example 3.4 presents some generalisations of product form results for Petri nets.

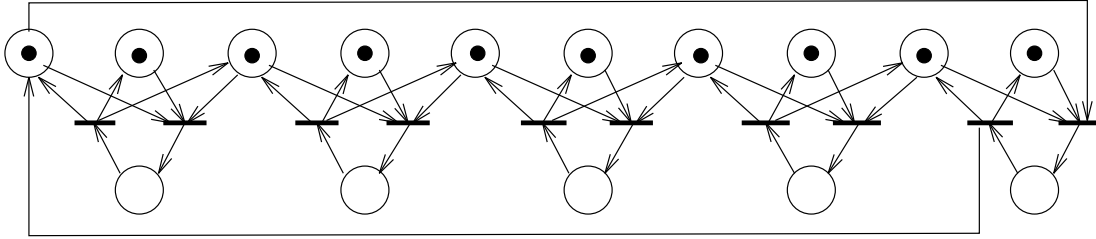

Figure 2: Petri net for the dining philosophers problem with 5 philosophers

3.1 The dining philosophers problem

The dining philosophers problem, according to the literature due to E.W. Dijkstra, is introduced as a model for resource sharing in computers. In the basic model it contains K philosophers who alternatively think and eat. The philosophers are seated around a round table, and on the right-hand side of each philosopher is one chopstick. To eat, a philosopher needs two chopsticks. As a consequence, once a philosopher is eating his two neighbours cannot be eating at the same time.

The dining philosophers problem has often appeared in Petri net form (see Figure 2, where the Petri net is depicted for the case of 5 philosophers), for example in Peterson [14], chapter 3.4.6 a deterministic version is modelled, and in Zenie [17] a stochastic version is introduced. Furthermore, the problem is analysed in Lazar and Robertazzi [9], Wang and Robertazzi [15], where it is shown that the equilibrium distribution describing the number of eating philosophers has a product form. This result is also established in Ycart [16], where the dining philosophers process is modelled as a nearest particle system.

The dining philosophers problem with exponential thinking and eating times can immediately be incorporated in the framework of Section 2. To this end, introduce Markov chain k for philosopher k , $k = 1, \dots, K$. Let $S_k = \{0, 1\}$, where 0 represents that the philosopher is thinking and 1 that the philosopher is eating. Let $A_{k0} = \{0\}$, and $A_{k1} = \{1\}$. Since a philosopher always needs both the chopstick on his right-hand side and left-hand side to eat we have that Markov chains i and $i + 1$ ($K + 1 = 1$) compete over resource 1. (Note that in Section 2 we have identified a part of the state space with a resource. The identification of chopsticks with resources is mathematically more difficult.) Let λ_k , resp. μ_k be the rates of the exponential thinking resp. eating times for philosopher k , then the state space of the Markov chain representing the dining philosophers problem is

$$S = \{\bar{n} = (n_1, \dots, n_K) | n_i \in \{0, 1\}, n_i + n_{i+1} \leq 1\},$$

and the transition rates are for $\bar{n}, \bar{n}' \in S$

$$q(\bar{n}, \bar{n}') = \begin{cases} \mu_k, & \text{if } \bar{n}' = \bar{n} - e_k, \\ \lambda_k \mathbf{1}(n_{k-1} = n_{k+1} = 0), & \text{if } \bar{n}' = \bar{n} + e_k. \end{cases}$$

The equilibrium distribution is (also cf. Lazar and Robertazzi [9], Ycart [16])

$$\pi(\bar{n}) = B \prod_{k=1}^K \left(\frac{\lambda_k}{\mu_k} \right)^{n_k}, \quad \bar{n} \in S,$$

as can immediately be obtained from Theorem 2.6.

3.2 Concurrent processing and database locking

This section discusses the model for concurrency and database locking that is introduced by Mitra and Weinberger [12] and Mitra [11], and is also discussed in Kelly [7].

Consider a database that consists of N items. Transactions are associated with lists of items in the database that are needed for processing. These lists are partitioned into two sets, with the items in the leading part requiring exclusive locks, and items in the trailing set requiring non-exclusive locks. To clarify the picture, a transaction will exclusively lock an item for a write operation, in this case no other transaction can simultaneously use this item and non-exclusively lock an item for a read operation, in which case also other transactions can use this item for a read operation. To avoid complications, we assume that all transactions exclusively lock at least one item. Requests for transaction processing arrive exogeneously to the database. On arrival of a request the database lock manager decides to either grant or refuse the locks required on the following basis. Let W_d and R_d be the lists of exclusively locked and non-exclusively locked items respectively in the database at the time of arrival. Let W_a and R_a be the lists of items required by the arriving request to be exclusively locked and non-exclusively locked. The locks are granted if

$$(W_a \cap W_d) \cup (W_a \cap R_d) \cup (R_a \cap W_d) = \emptyset,$$

and denied otherwise. If the locks are denied then the request for processing the transaction is blocked and cleared, and discarded. If the locks are granted, then the transaction is accepted for processing and the locks are not released until the entire processing of the transaction is complete.

There are K types of transactions, labelled $k = 1, \dots, K$. Assume that a transaction of type k requires items $j_k \subset \{1, \dots, N\}$ and $p_k \subset \{1, \dots, N\}$ to be exclusively and non-exclusively locked. If transactions of type k arrive at Poisson rate λ_k , and are served at exponential rate μ_k , then the database lock protocol described above can be modelled in the framework of Section 2. To this end, introduce Markov chain k for the transactions of type k . Since an item can be used only once the state space of Markov chain k is $S_k = \{0, 1\}$, where 0 represents that there is no transaction of type k present, and 1 that there is 1 transaction of type k present. Let $A_{k0} = \{0\}$, and $A_{k1} = \{1\}$. The Markov chains compete over the items in the database. To model this competition in the framework of Section 2, for Markov chain k , define for each $k' \neq k$, the following set $F_{kk'} = (W_k \cap W_{k'}) \cup (W_k \cap R_{k'}) \cup (R_k \cap W_{k'}) \subset \{1, \dots, N\}$. If $F_{kk'} \neq \emptyset$ then Markov chain k and k' compete over resource 1. The state space of the product process can immediately be deduced from this competition mechanism. The transition rates of the product process are, with $\bar{n} = (n_1, \dots, n_K)$, and $n_k = 1$ if a transaction of type k is present

$$q(\bar{n}, \bar{n}') = \begin{cases} \mu_k, & \text{if } \bar{n}' = \bar{n} - e_k, n_k = 1, \\ \lambda_k, & \text{if } \bar{n}' = \bar{n} + e_k, n_k = 0, \text{ and } \cup_{\{k' \neq k: n_{k'}=1\}} F_{kk'} = \emptyset, \end{cases}$$

and according to Theorem 2.6 the equilibrium distribution is

$$\pi(\bar{n}) = B \prod_{k=1}^K \left(\frac{\lambda_k}{\mu_k} \right)^{n_k}.$$

Note that the database locking mechanism described above can immediately be generalised to the following situation. Assume that transactions of different type interfere as before. However, instead of the interference between transactions of the same type described above now assume that transactions of the same type do not necessarily interfere, that is a number of transactions of type k can simultaneously use items of the database, for example as a consequence of a specific order in which the items of the database are used by these transactions. Let S_k be the state space of the Markov chain describing transactions of type k , and define $A_{k0} = \{0\}$, and $A_{k1} = S_k \setminus \{0\}$. Then Markov chain k and k' compete over resource 1 if $F_{kk'} \neq \emptyset$. Let π_k be the equilibrium distribution of Markov chain k in isolation, then

$$\pi(\bar{n}) = B \prod_{k=1}^K \pi_k(n_k),$$

where n_k represents the state of Markov chain k .

Furthermore, observe that the exclusion mechanism can immediately be extended to allow several levels of exclusive/non-exclusive locks. As is apparent from the above discussion, this only changes the form of the state space.

In addition, note that a model for resource sharing in a communications environment is discussed in Kaufman [6]. In the model discussed in this reference arriving customers compete over K resources. Customers of type k arrive at Poisson rate λ_k and require b_k units of the resource. Customers are accepted if the required units of resource are available, and rejected otherwise. This model can be seen as a special case of the model discussed above, since the distinction between resources is not incorporated in Kaufman [6].

Finally, note that both the results of this example and the results of the previous example (dining philosophers problem) can immediately be obtained from Kelly [8]. This is immediate since the Markov chains in isolation discussed in these examples are reversible. As a consequence, the product process is reversible, and the exclusion/concurrency mechanism comes down to the restriction of the state space to a particular set for a reversible process.

3.3 Task sequences in a Petri net

Consider the ‘dual processor dual memory system’ as described in Marsan *et al.* [10] (in this reference it represents the architecture of TOMP in the case of only two processors). It basically consists of two processors, P_1 and P_2 , corresponding private buses, PB_1 and PB_2 , memories, M_1 and M_2 , local memory busses, LB_1 and LB_2 , and a global memory bus GB . P_1 (P_2) may attempt transfers to M_1 (M_2) through the local memory bus LB_1 (LB_2). Alternatively, P_1 (P_2) may attempt transfers to M_2 (M_1) through the global memory bus GB , and the local memory bus LB_2 (LB_1).

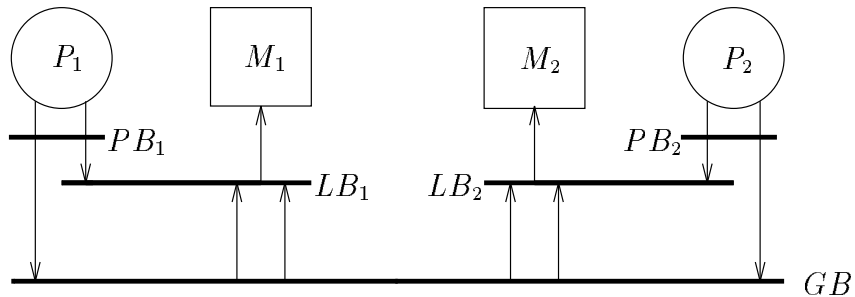

Figure 3: Dual processor dual memory system

Conflicts arise since only one processor at a time may utilise a bus. The original Petri net model of this system is due to Marsan *et al.* [10]. In Lazar and Robertazzi [9] it is shown that the corresponding Petri net in which P_1 attempts to write on M_2 only when P_2 is not using GB and LB_2 and vice versa has a product form equilibrium distribution for the distribution representing the stage at which a task sequence has arrived. In this context, a task sequence is a number of successive operations starting with an active processor, and ending with an active processor. The explanation of this product form result given in Lazar and Robertazzi [9] is that the transition lattice can be embedded on a toroidal manifold.

Theorem 2.8 gives a simple explanation of this product form result. The introduction of additional (dotted) arcs corresponds to the exclusion mechanism introduced in Section 2. As a consequence of the additional dotted arcs a task sequence can either operate as if it was independent of the rest, or is completely stopped. To see this, consider the Petri net corresponding to the model of Figure 3. This Petri net is depicted in Figure 4, where the dotted arcs are introduced in Lazar and Robertazzi [9] to obtain a product form distribution. The interpretation of the dotted arcs is that a transition can fire only if the indicated bus token (LB_1 , LB_2 , or GB) is available and the bus token is immediately returned after firing of the transition. In the description of Section 2, the Petri net corresponds to two Markov chains, chain k for P_k , who compete over 0, LB_1 , GB , and LB_2 , where 0 is introduced for the part of the state space at which the processors do not compete over any of the buses LB_1 , GB , and LB_2 . Let the states for the Markov chains be as indicated in Figure 4, i.e. Markov chain 1 is in state 0 if the token is at “ P_1 active”, etc.. If we consider Markov chain 1 in isolation, that is LB_1 , GB , and LB_2 are always available for Markov chain 1, we obtain that we can separate the transition rates in a part $q_1^{(1)}$ describing the behaviour at states $\{0, 1, 2, 3\}$ (Task 1), and a part $q_1^{(2)}$ describing the behaviour at states $\{0, -1, -2\}$ (Task 3), such that Markov chain 1 is locally balanced with respect to this separation. This can easily be seen when we consider the global balance equations for Markov chain 1. We obtain a similar separation for Markov chain 2. Now define the following subsets of the state spaces (see Figure 5):

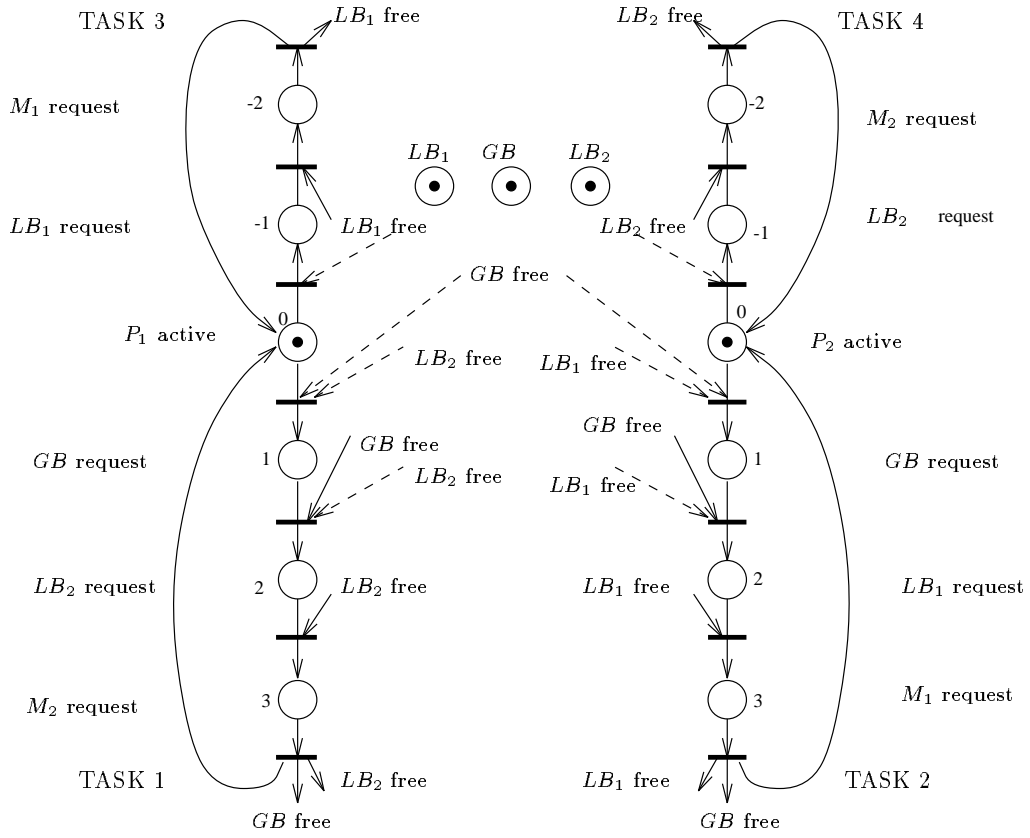

Figure 4: Petri net for the dual processor dual memory system

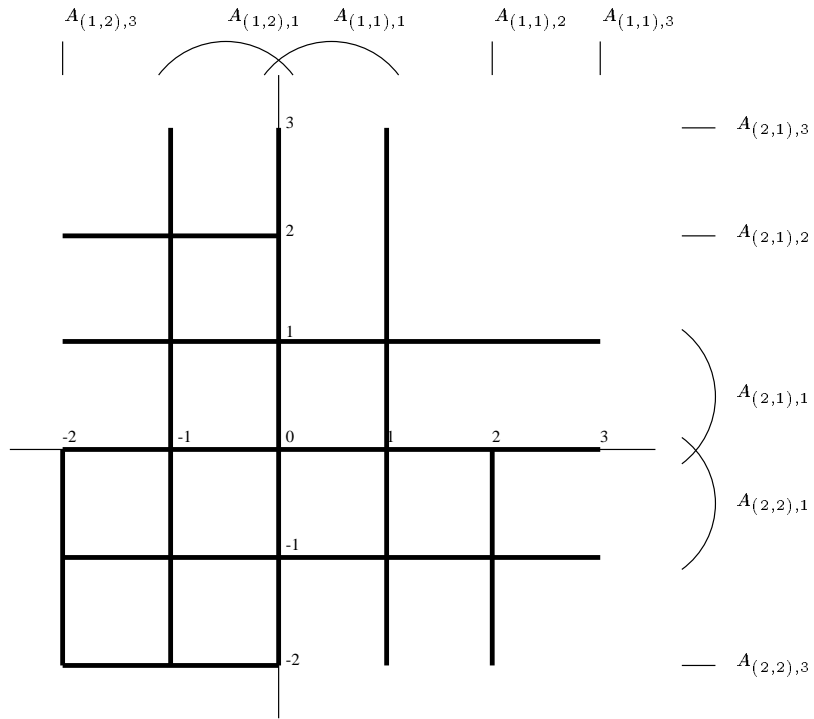

Figure 5: State space and transitions for the dual processor dual memory system

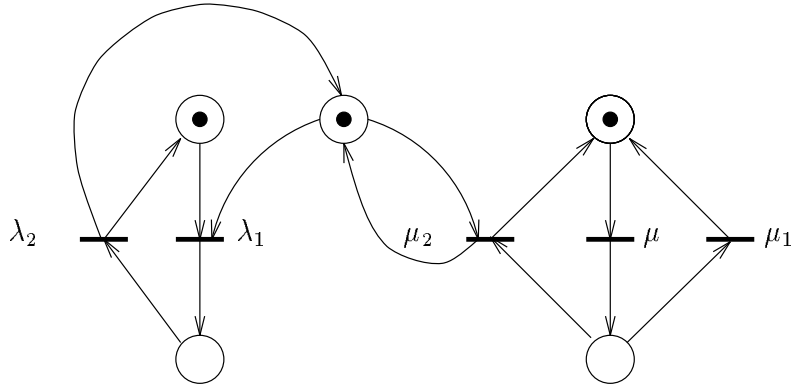

Figure 6: Petri net with partial exclusion

$$\begin{array}{lll}
A_{(1,1),1} = \{0, 1\}, & A_{(2,1),1} = \{0, 1\}, & \text{use resource } 0, \\
A_{(1,1),2} = \{2\}, & A_{(2,1),2} = \{2\}, & \text{use resource } GB, \\
A_{(1,1),3} = \{3\}, & A_{(2,1),3} = \{3\}, & \text{use resource } GB, LB_2, \text{ resp. } GB, LB_1, \\
A_{(1,2),1} = \{0, -1\}, & A_{(2,2),1} = \{0, -1\}, & \text{use resource } 0, \\
A_{(1,2),3} = \{-2\}, & A_{(2,2),3} = \{-2\}, & \text{use resource } LB_1, \text{ resp. } LB_2.
\end{array}$$

Observe that Markov chain (1,1) competes with Markov chain (2,1) over GB , Markov chain (1,1) competes with Markov chain (2,2) over LB_2 , Markov chain (1,2) competes with Markov chain (2,1) over LB_1 , and Markov chains (1,2) and (2,2) do not compete over any resources. From Theorem 2.8 we now obtain that the Markov chain describing the modified dual processor dual memory system has a product form equilibrium distribution at state space indicated in Figure 5. The generalisation from Theorem 2.6 to Theorem 2.8 lies in the fact that for example the state $A_{(1,2),3} \times A_{(2,2),3}$ is contained in the state space.

3.4 Petri nets: more general examples

The previous example initiated the model of Section 2. In this section we give some additional examples of Petri nets with product form distribution. These Petri nets will have a more general structure, and cannot be incorporated in the framework of Lazar and Robertazzi [9]. In contrast, these Petri nets are designed to fit the assumptions, that is these Petri nets are not based on actual systems. Furthermore, the Petri nets are taken as simple as possible to illustrate the exclusion/competition mechanisms. In particular, we consider Petri nets consisting of 2 subnets only, and for simplicity in Examples 3.4.1 and 3.4.2 subnet 1 will be a linear chain.

3.4.1 Partial exclusion

Consider the Petri net depicted in Figure 6. Let the transition rates be as indicated. The left Petri net is net 1, the right Petri net is net 2. The state space of the Markov chain for both nets is $\{0,1\}$, and the Markov chains are in state 0 if the token is at the place indicated in Figure 6. The Markov chains corresponding to

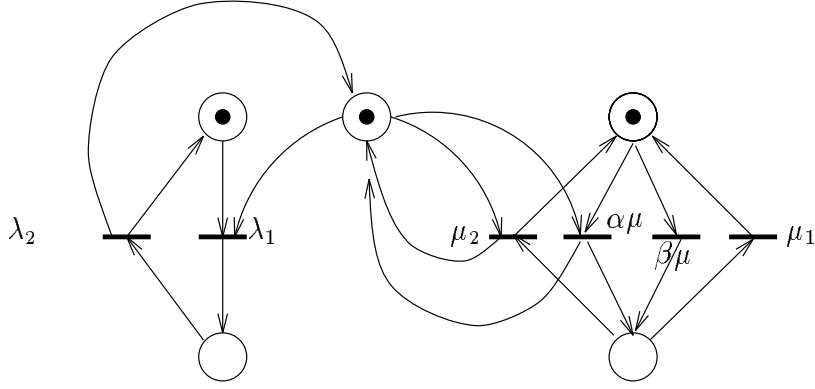

Figure 7: Petri net with partial exclusion: product form modification

the Petri nets of Figure 6 do not compete over any resources since all states in $S = S_1 \times S_2 = \{(0, 0), (1, 0), (0, 1), (1, 1)\}$ are admissible. The equilibrium distribution of the product process is rather complex:

$$\begin{aligned} \pi(0, 0)/B &= (\mu_1 + \mu_2)(\lambda_2 + \mu_1 + \mu) + \lambda_1\mu_1 \\ \pi(1, 0)/B &= \frac{\lambda_1}{\lambda_2} \{(\mu_1 + \mu_2)(\mu_1 + \lambda_2) + \mu_1\lambda_1 + \mu\mu_1\} \\ \pi(0, 1)/B &= \mu \{\mu + \mu_1 + \lambda_1 + \lambda_2\} \\ \pi(1, 1)/B &= \frac{\lambda_1}{\lambda_2} \mu \{\mu + \mu_1 + \mu_2 + \lambda_1 + \lambda_2\}. \end{aligned}$$

Observe that these probabilities vaguely resemble a product form structure. This is reflected in the terms $\frac{\lambda_1}{\lambda_2}$ and μ appearing when $n_1 = 1$, $n_2 = 1$ respectively.

To obtain a true product form the Petri net is modified to the Petri net given in Figure 7. The transition with rate μ is separated into two transitions with rate $\alpha\mu$, and $\beta\mu$. If $\alpha = \mu_1/(\mu_1 + \mu_2)$, and $\beta = \mu_2/(\mu_1 + \mu_2)$ the total rate is unchanged and in isolation the behaviour of Petri net 2 would be unchanged. To model the Petri net of Figure 7 in the formalism of Section 2, define Markov chain 21 as the Markov chain at S_2 for the process with rates $\alpha\mu$, μ_2 and Markov chain 22 as the Markov chain at S_2 for the process with rates $\beta\mu$, μ_1 . Then Markov chain 1 competes with Markov chain 21 over resource 1, and Markov chain 1 does not compete with Markov chain 22 over any resources. It can easily be seen that Markov chain 2 satisfies local balance with respect to the separation in chain 21 and 22. Therefore, from Theorem 2.8 we now obtain that the Markov chain describing the Petri net of Figure 7 has a product form equilibrium distribution at $S = \{(0, 0), (1, 0), (0, 1), (1, 1)\}$ given by

$$\pi(\bar{n}) = \pi_1(n_1)\pi_2(n_2),$$

where

$$\pi_1(n_1) = B_1 \left(\frac{\lambda_1}{\lambda_2} \right)^{n_1}, \quad \pi_2(n_2) = B_2 \left(\frac{\mu}{\mu_1 + \mu_2} \right)^{n_2}.$$

Observe that the Markov chains are statistically independent since also the normalising constant separates.

Note that this example discusses an extremely simple stochastic Petri net that can also be solved explicitly without the formalism of Section 2 (even the model of Figure 6), but that it can immediately be generalised to more complicated situations, which in general will not be easy to solve without some theoretical tools.

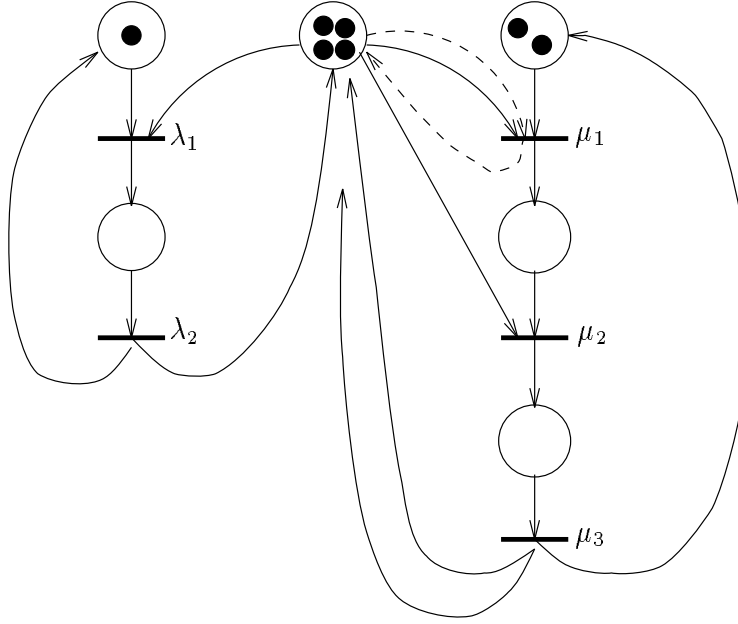

Figure 8: Resources with multiple tokens

3.4.2 Resources with multiple tokens

Consider the Petri net depicted in Figure 8. In the resource position 4 tokens are present, Petri net 1 is a simple cycle, whereas Petri net 2 is a cycle with 2 tokens present. Note that for a complete cycle of both tokens of Petri net 2 all 4 tokens in the resource position are needed. Therefore competition between the Petri nets occurs.

Let the transition rates be as indicated in Figure 8. The Markov chain for Petri net 1 in isolation has equilibrium distribution

$$\pi_1(n_1) = B_1 \left(\frac{\lambda_1}{\lambda_2} \right)^{n_1}, \quad n_1 \in S_1 = \{0, 1\}.$$

The Markov chain for Petri net 2 in isolation has equilibrium distribution

$$\pi_2(\bar{n}_2) = \pi_2((a_1, a_2, a_3)) = B_2 \left(\frac{1}{\mu_1} \right)^{a_1} \left(\frac{1}{\mu_2} \right)^{a_2} \left(\frac{1}{\mu_3} \right)^{a_3},$$

at $S_2 = \{(a_1, a_2, a_3) | a_1 + a_2 + a_3 = 2, a_i \in \{0, 1, 2\}, i = 1, 2, 3\}$, where a_i represents the number of tokens at position i . Observe that Markov chain 2 satisfies local balance with respect to the separation

$$\begin{aligned} q_2^{(1)}(\bar{n}_2, \bar{n}'_2) &= q_2(\bar{n}_2, \bar{n}'_2), & \text{if } \bar{n}_2, \bar{n}'_2 \in \{(2, 0, 0), (1, 1, 0), (1, 0, 1)\}, \\ q_2^{(2)}(\bar{n}_2, \bar{n}'_2) &= q_2(\bar{n}_2, \bar{n}'_2), & \text{if } \bar{n}_2, \bar{n}'_2 \in \{(0, 2, 0), (0, 1, 1), (1, 1, 0)\}, \\ q_2^{(3)}(\bar{n}_2, \bar{n}'_2) &= q_2(\bar{n}_2, \bar{n}'_2), & \text{if } \bar{n}_2, \bar{n}'_2 \in \{(0, 0, 2), (1, 0, 1), (0, 1, 1)\}. \end{aligned}$$

Markov chain $2i$ corresponds to a cycle of one token when the other token remains at place i .

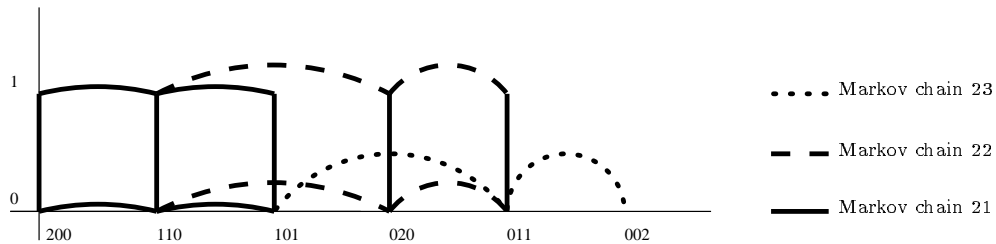

Figure 9: State space and transitions for the product process

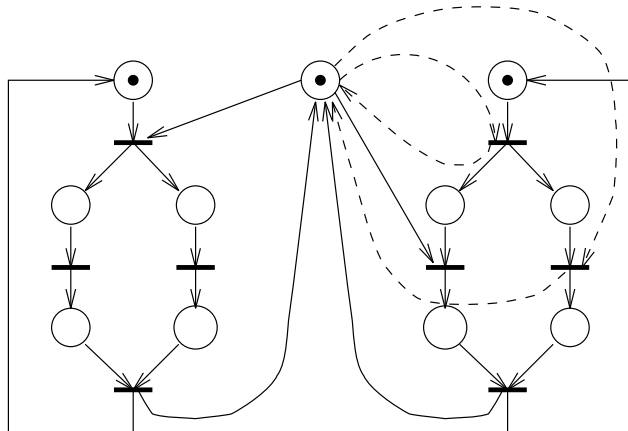

Figure 10: Petri nets with branching

The product process for the competing Markov chains cannot reach state $\bar{n} = (n_1, \bar{n}_2) = (1, (0, 0, 2))$. Therefore, the state space is as depicted in Figure 9. For the product process to have a product form equilibrium distribution the dotted arc is added in Figure 8. This guarantees that only the transitions indicated in Figure 9 remain possible for the product process. Observe that Markov chain 1 competes only with Markov chain 23. Therefore, from Theorem 2.8 we obtain that the product process has a product form equilibrium distribution at $S = S_1 \times S_2 \setminus \{(1, (0, 0, 2))\}$ given by

$$\pi(\bar{n}) = B\pi_1(n_1)\pi_2(\bar{n}_2).$$

3.4.3 Branching

The previous examples all describe Petri nets in which each subnet is a state machine. Observe that this is not required for the general results of Section 2. As a simple illustration, consider the Petri net depicted in Figure 10. The Petri net consists of 2 identical subnets that share one token. Observe that the token is used at different positions in the Petri nets (solid arcs) to illustrate the exclusion mechanism when branching is involved. In Petri net 2 the dotted arcs are added to obtain a product form equilibrium distribution. Note that dotted arcs need to be added only in Petri net 2.

Let π_1, π_2 be the equilibrium distribution of the Markov chain for Petri net 1, 2 resp., then the product process at state space S , that can immediately be determined

from the exclusion mechanism, has equilibrium distribution

$$\pi(\bar{n}) = B\pi_1(\bar{n}_1)\pi_2(\bar{n}_2),$$

as can immediately be seen from Theorem 2.6.

Acknowledgements The author would like to thank F. Baccelli for posing the problem and for many stimulating discussions which helped improving the final form of the results presented here.

References

- [1] Baskett, F., Chandy, K.M., Muntz, R.R., and Palacios, F.G. (1975) Open, closed and mixed networks of queues with different classes of customers, *Journal of the ACM*, **22**, 248-260.
- [2] Donatelli, S. and Sereno, M. (1992) On the product form solution for stochastic Petri nets, *Proceedings of the 13th international conference on Application and theory of Petri nets, Sheffield, UK, 1992*, 154-172.
- [3] Henderson, W. and Taylor, P.G. (1990) Open networks of queues with batch arrivals and batch services, *Queueing Systems*, **6**, 71-88.
- [4] Henderson, W. and Taylor, P.G. (1991) Embedded processes in stochastic Petri nets, *IEEE Transactions on Software Engineering*, **17**, 108-116.
- [5] Jackson, J.R. (1959) Networks of waiting lines, *Operations Research*, **5**, 518-521.
- [6] Kaufman, J.S. (1981) Blocking in a shared resource environment, *IEEE Transactions on Communications*, **29**, 1474-1481.
- [7] Kelly, F.P. (1985) Stochastic models of computer communication systems, *Journal of the Royal Statistical Society B*,
- [8] Kelly, F.P. (1979) *Reversibility and stochastic networks*, Wiley.
- [9] Lazar, A.A. and Robertazzi, T.G. (1991) Markovian Petri net protocols with product form solution, *Performance Evaluation*, **12**, 67-77.
- [10] Marsan, M.A., Balbo, G., Conte, G., and Gregoretti, F. (1983) Modeling bus contention and memory interference in a multiprocessor system, *IEEE Transactions on Computers*, **32**, 60-72.
- [11] Mitra, B. (1985) Probabilistic models and asymptotic results for concurrent processing with exclusive and non-exclusive locks, *SIAM Journal of Computation*, **14**, 1030-1051.
- [12] Mitra, B. and Weinberger, P.J. (1984) Probabilistic models of database locking: solutions, computational algorithms, and asymptotics, *Journal of the ACM*, **31**, 855-878.

- [13] Murata, T. (1989) Petri nets: properties, analysis and applications, *Proceedings of the IEEE*, **77**, 541-580.
- [14] Peterson, J.L. (1981) *Petri net theory and the modeling of systems*, Prentice-Hall, Englewood Cliffs.
- [15] Wang, I.Y. and Robertazzi, T.G. (1990) Service stage Petri net models with product form, *Queueing Systems*, **7**, 355-374.
- [16] Ycart, B. (1991) The philosophers' process: an ergodic reversible nearest particle system, Research Report, Laboratoire de mathématique appliquées, Université de Pau et de pays de l'Adour.
- [17] Zenie, A. (1985) Colored stochastic Petri nets, *International workshop on timed Petri nets*, Torino, Italy (IEEE Comp. Soc. Press, Silversprings, MD, 1986, pp. 262-271)