



HAL
open science

A multiclass network with non-linear, non-convex, non-monotonic stability conditions

Vincent Dumas

► **To cite this version:**

Vincent Dumas. A multiclass network with non-linear, non-convex, non-monotonic stability conditions. [Research Report] RR-2487, INRIA. 1995. inria-00074188

HAL Id: inria-00074188

<https://inria.hal.science/inria-00074188>

Submitted on 24 May 2006

HAL is a multi-disciplinary open access archive for the deposit and dissemination of scientific research documents, whether they are published or not. The documents may come from teaching and research institutions in France or abroad, or from public or private research centers.

L'archive ouverte pluridisciplinaire **HAL**, est destinée au dépôt et à la diffusion de documents scientifiques de niveau recherche, publiés ou non, émanant des établissements d'enseignement et de recherche français ou étrangers, des laboratoires publics ou privés.



INSTITUT NATIONAL DE RECHERCHE EN INFORMATIQUE ET EN AUTOMATIQUE

*A multiclass network with
non-linear, non-convex,
non-monotonic stability conditions*

Vincent DUMAS

N° 2487
Janvier 1995

PROGRAMME 2

*R*apport
de recherche

Les rapports de recherche de l'INRIA
sont disponibles en format postscript sous
ftp.inria.fr (192.93.2.54)

si vous n'avez pas d'accès ftp
la forme papier peut être commandée par mail :
e-mail : dif.gesdif@inria.fr
(n'oubliez pas de mentionner votre adresse postale).

par courrier :
Centre de Diffusion
INRIA
BP 105 - 78153 Le Chesnay Cedex (FRANCE)

INRIA research reports
are available in postscript format
ftp.inria.fr (192.93.2.54)

if you haven't access by ftp
we recommend ordering them by e-mail :
e-mail : dif.gesdif@inria.fr
(don't forget to mention your postal address).

by mail :
Centre de Diffusion
INRIA
BP 105 - 78153 Le Chesnay Cedex (FRANCE)

A MULTICLASS NETWORK WITH NON-LINEAR, NON-CONVEX, NON-MONOTONIC STABILITY CONDITIONS.

Vincent Dumas²

January 1995

Abstract.

We consider a stochastic queueing network with fixed routes and class priorities. The vector of class sizes forms a homogeneous Markov process with countable state space \mathbb{Z}_+^6 . Its conditions of ergodicity, which are identified with the conditions of stability of the network, depend on the vector ρ whose components are the traffic intensities of the different classes. In order to determine the exact stability conditions, we resort to the tools of Malyshev and Menshikov's theory of random walks in \mathbb{Z}_+^N with space homogeneity and bounded jumps (see [9]). We exhibit diverging paths of the associated dynamical system, whose conditions of existence yield the conditions of transience of our network. Then, for our proofs of ergodicity and transience, we find simple, Lyapunov functions that satisfy the criteria given in [9].

The stability conditions thus determined have especially unusual characteristics : they have a quadratic part, the stability domain is not convex, and we may find vectors $\rho < \rho'$ such that the network corresponding to ρ' is ergodic, and that corresponding to ρ is transient (see Theorem 1.1 and section 8).

²INRIA, domaine de Voluceau, B.P. 105, 78153 Le Chesnay Cedex, France. Vincent.Dumas@inria.fr

ÉTUDE D'UN RÉSEAU MULTICLASSE AUX CONDITIONS DE STABILITÉ NON LINÉAIRES, NON CONVEXES ET NON MONOTONES.

Vincent Dumas¹

Janvier 1995

Résumé.

On considère un réseau de files d'attente stochastique à routes fixes avec priorités entre les différentes classes de clients. Le vecteur donnant le nombre de clients de chaque classe forme un processus de Markov homogène à valeurs dans \mathbb{Z}_+^6 . Ses conditions d'ergodicité, assimilées aux conditions de stabilité du réseau, dépendent du vecteur ρ des intensités de trafic des différentes classes. Pour déterminer les conditions exactes de stabilité, on a recours à la théorie développée par Malyshev et Menshikov (cf. [9]) pour les marches aléatoires à sauts bornés et homogénéité spatiale dans \mathbb{Z}_+^N . Les trajectoires divergentes du système dynamique associé, une fois identifiées, permettront de repérer les zones d'instabilité du réseau. Les preuves exactes d'ergodicité et de transience seront obtenues par la construction de fonctions de Lyapunov simples vérifiant les critères énoncés par Malyshev et Menshikov dans [9].

Le domaine de stabilité ainsi identifié présente des caractéristiques inhabituelles : la frontière a une portion quadratique, le domaine n'est pas convexe, et on peut trouver des vecteurs $\rho < \rho'$ tels que le réseau correspondant à ρ' est stable et celui correspondant à ρ est instable (cf. Theorem 1.1 et section 8).

¹INRIA, domaine de Voluceau, B.P. 105, 78153 Le Chesnay Cedex, France. Vincent.Dumas@inria.fr

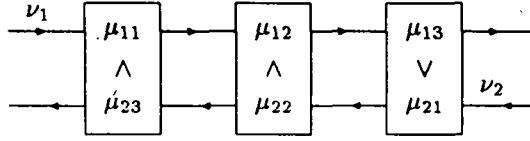

Figure 1 : Network under study.

1 Introduction : a multiclass network with priorities.

This paper is devoted to the stability analysis of a stochastic, multiclass network with fixed customer routes and preemptive resume priorities among classes.

Our network is composed of $K = 3$ single-server stations (or queues) and $I = 2$ customer *types*. Each type corresponds to a deterministic route visiting three stations. Type i customers at the s^{th} stage of their route will be called *class* (i, s) customers; their station will be denoted $k_{i,s}$, and then type i customers enter the network at station $k_{i,1}$ and leave it after station $k_{i,3}$. We have:

$$(k_{11}, k_{12}, k_{13}) = (1, 2, 3), \quad (k_{21}, k_{22}, k_{23}) = (3, 2, 1).$$

It is assumed that type i customers enter the network according to a Poisson process of rate ν_i , and that class (i, s) customers require independent, exponentially distributed services of parameter $\mu_{i,s}$. Different arrival processes and service sequences are independent.

At last, the service discipline is based on class priorities: at each queue k , there are two classes, which form the set $\Lambda_k = \{(i, s)/k_{i,s} = k\}$, and one class has preemptive resume priority over the other one, whereas inside each class customers are served in their order of arrival. The priorities are :

$$(2, 3) > (1, 1), \quad (2, 2) > (1, 2), \quad (1, 3) > (2, 1),$$

where the notation $(i, s) > (j, r)$ means that $k_{i,s} = k_{j,r}$ and class (i, s) has priority over class (j, r) .

This network is pictured in Figure 1.

Let $\mathcal{C} = \{(i, s), 1 \leq i \leq 2, 1 \leq s \leq 3\}$ be the set of all the classes. We will denote by $Q_t(i, s)$ (resp. $Q_t(k)$) the number of customers in class (i, s) , $i = 1, 2$, $s = 1, 2, 3$ (resp. the number of customers in queue k , $k = 1, 2, 3$), at time $t \geq 0$. Consider the process $(Q_t)_{t \geq 0}$ defined by:

$$Q_t = (Q_t(i, s))_{(i,s) \in \mathcal{C}}.$$

It is easy to check that this is a homogeneous Markov process with countable state space $\mathbb{Z}_+^{|\mathcal{C}|}$, where $|\mathcal{C}| = 6$ is the cardinality of \mathcal{C} . As usual we identify the *stability* (resp. the *instability*) of the network with the ergodicity (resp. the transience) of Q_t .

We will denote by:

$$\rho_{i,s} \triangleq \frac{\nu_i}{\mu_{i,s}},$$

the *traffic intensity* for class (i, s) , and:

$$\rho_k \triangleq \sum_{(i,s) \in \Lambda_k} \rho_{i,s},$$

the *traffic intensity* for queue k . The vector ρ of traffic intensities is: $\rho = (\rho_{is})_{(i,s) \in \mathcal{C}}$.

It is well-known that necessary conditions of stability of such networks are that the traffic intensities for all queues be smaller than one ; these are the *usual conditions*. Since Rybko and Stolyar [8], and then Botvitch and Zamyatin [1], made the complete stability analysis of a special multiclass network with priorities, we know that these conditions are in general not sufficient. In fact, in multiclass networks with priorities, Q_t is in general not irreducible in $\mathbb{Z}_+^{|\mathcal{C}|}$, and we will easily prove that this induces an additional, necessary condition of stability. This additional condition was sufficient to stabilize the network presented by Rybko and Stolyar (see [1]), but this is not true for our network.

In order to get the exact stability conditions of such a multiclass network, there are two possible (and analogous) approaches : the associated fluid limit model introduced by Dai (see [3]) or the dynamical system associated to random walks in \mathbb{Z}_+^N and defined by Malyshev (see [9]). Generalizing the ergodicity criterion introduced by Rybko and Stolyar in [8], Dai proved that the network is stable if the fluid model empties in finite time. We just got acquainted with a remarkable paper of Meyn [7] where the author defines a notion of instability of the fluid model which implies the transience of the original network. However, the fluid approach is still unable to distinguish between true fluid limits and false solutions of the fluid equations, which creates artificial difficulties especially to check the instability of the fluid model. Hence we preferred applying the corresponding criteria of ergodicity and transience proved by Malyshev and Menshikov in [9] for random walks in \mathbb{Z}_+^N , which provide a finer understanding of the transient behaviour of Q_t via the notion of *induced chains*.

This approach will allow us to prove the following theorem, which describes the domain of stability of our network.

Theorem 1.1

Consider the functions:

$$\begin{cases} F_1(\rho) = (\rho_{11} + \rho_{23} - 1) \vee (\rho_{12} + \rho_{22} - 1) \vee (\rho_{13} + \rho_{21} - 1) \vee (\rho_{13} + \rho_{22} - 1) \\ F_2(\rho) = (\rho_{13} + \rho_{23} - 1)(1 - \rho_{12} - \rho_{22}) - (\rho_{12} + \rho_{23} - 1)(1 - \rho_{13} - \rho_{21}) \\ F_3(\rho) = (\rho_{13} + \rho_{23} - 1) \wedge [(\rho_{13} - \rho_{12}) \vee F_2(\rho)] \end{cases}$$

and set: $F(\rho) = F_1(\rho) \vee F_3(\rho)$. Then if $F(\rho) < 0$, the network is stable, and if $F(\rho) > 0$, the network is unstable.

Function F_1 expresses the usual conditions and the additional one due to the non-irreducibility of Q_t . A three-dimensional projection of the stability domain, which will be studied in section 8, will clearly show that:

- the quadratic condition introduced through function F_2 is meaningful;
- the stability domain $\mathcal{D} = \{\rho / F(\rho) < 0\}$ is not convex;
- there is no monotonicity with respect to the partial ordering

$$\rho < \rho' \Leftrightarrow \forall (i, s) \in \mathcal{C} : \rho_{is} < \rho'_{is}.$$

More precisely, one can find two vectors $\rho < \rho'$, with ρ corresponding to an unstable network and ρ' corresponding to a stable network.

These characteristics are especially unusual. The complexity of the stability conditions seems to leave little hope to find a direct approach to the stability conditions of this kind of multiclass networks.

The paper is organized as follows. In section 2, we introduce some essential processes: the *potential loads* associated to the classes, which at first allow us to give a simple proof that $F_1(\rho) < 0$ if the network

is stable and the network is unstable if $F_1(\rho) > 0$. In section 3, we expose in our special setting the notions of induced chains and stationary drifts and the criteria of ergodicity and transience presented in [9]. In section 4, we show how to compute the stationary drifts via the fluid equations. In section 5, we exhibit diverging paths of the associated dynamical system, whose conditions of existence are: $F_1(\rho) \leq 0$ and $F_3(\rho) > 0$, and thus yield the conditions of transience of our network. In section 6 (resp. in section 7), we use the criteria of [9] to prove Propositions 6.1 and 6.3 (resp. Propositions 7.2, 7.3 and 7.4) which give the conditions of transience (resp. the conditions of ergodicity) of the network, completing the proof of Theorem 1.1. The proofs of all these propositions are very similar, but they involve different, technical arguments, and then all of them have been completely written. In section 8 we present (and picture) a three-dimensional projection of the stability domain. The paper is closed by a short conclusion.

We will repeatedly use the following notations : $x \wedge y$ for $\min(x, y)$, $x \vee y$ for $\max(x, y)$, x^+ for $x \vee 0$; when two stochastic processes $f = (f_t)_{t \geq 0}$ and $g = (g_t)_{t \geq 0}$ satisfy :

$$\frac{f_t - g_t}{t} \rightarrow 0 \quad \text{almost surely when } t \rightarrow +\infty,$$

we will denote it by: $f \sim g$.

2 Structural, necessary conditions of stability.

In this section, we are going to prove that $F_1(\rho) < 0$ (resp. $F_1(\rho) > 0$) is a necessary condition of stability (resp. a sufficient condition of instability): this is an easy result that does not require a deep insight into the behaviour of our model.

Some auxiliary processes will be especially useful to us all: to each class (i, s) is associated a process $W(i, s) = (W_t(i, s))_{t \geq 0}$, which is the cumulated service time that will be required at stage s by *all* type i customers present at time t in the network, and which we will call the *potential load of class (i, s)* ; this is a random function of Q_t , but by the law of large numbers we get that :

$$W(i, s) \sim \frac{\sum_{r=1}^s Q(i, r)}{\mu_{is}}.$$

We will also consider $W_t(k)$ (the *potential load of queue k*), which is defined by:

$$W_t(k) = \sum_{(i,s) \in \Lambda_k} W_t(i, s).$$

There is a natural decomposition of $W_t(i, s)$ as:

$$W_t(i, s) = \Omega_t(i, s) - B_t(i, s),$$

where $\Omega_t(i, s)$ is the cumulated load brought for class (i, s) up to time t (each type i customer entering the network brings his future service time at stage s), and $B_t(i, s)$ is the load processed (or equivalently the time spent) by server k_i , for class (i, s) up to time t ($\Omega_t(k)$ and $B_t(k)$ are derived in the obvious way). We have:

$$\begin{cases} \frac{\Omega_t(i, s)}{t} \rightarrow \rho_{is} & \text{almost surely when } t \rightarrow +\infty, \\ B_t(i, s) = \int_0^t \mathbb{I}_{\{Q_u(i, s) > 0, Q_u(j, r) = 0 \text{ if } (j, r) > (i, s)\}} du. \end{cases}$$

At first, the processes $W(i, s)$ allow us to prove the following, well-known result very easily:

Lemma 2.1

If $(Q_t)_{t \geq 0}$ is ergodic, then

$$\forall k \in \{1, \dots, K\}, \quad \rho_k < 1.$$

If

$$\exists k \in \{1, \dots, K\} / \rho_k > 1,$$

then $(Q_t)_{t \geq 0}$ is transient.

Proof :

If $(Q_t)_{t \geq 0}$ is ergodic, then $\frac{Q_t}{t} \rightarrow 0$ when $t \rightarrow +\infty$ in probability, and in consequence:

$$\forall k \in \{1, \dots, K\} : \quad \frac{W_t(k)}{t} \rightarrow 0 \quad \text{when } t \rightarrow +\infty \text{ in probability, or equivalently:}$$

$$\frac{B_t(k)}{t} \rightarrow \rho_k \quad \text{when } t \rightarrow +\infty \text{ in probability.}$$

But on the other hand:

$$\frac{B_t(k)}{t} = \frac{\int_0^t \mathbf{1}_{\{Q_u(k) > 0\}} du}{t} \rightarrow \pi[Q(k) > 0] < 1,$$

where π is the limit distribution (which must satisfy : $\pi[Q = 0] > 0$). Conversely, if for some k we have: $\rho_k > 1$, since $B_t(k) \leq t$, $\forall t$, then almost surely:

$$\liminf_{t \rightarrow +\infty} \frac{W_t(k)}{t} \geq \rho_k - 1 > 0,$$

which implies the transience. □

The above result is obviously valid for a much more general family of queueing networks. The conditions:

$$\forall k \in \{1, \dots, K\}, \quad \rho_k < 1,$$

are the *usual conditions* of stability. For our network they write :

$$\begin{cases} \rho_{11} + \rho_{23} < 1 \\ \rho_{12} + \rho_{22} < 1 \\ \rho_{13} + \rho_{21} < 1 \end{cases}$$

However, there is a simple reason why these conditions are not sufficient stability conditions for our network, and this reason is that the state process Q_t is not irreducible in $\mathbb{Z}_+^{|\mathcal{C}|}$. Let us explain this point.

At first, notice that state 0 (which corresponds to an empty network) may obviously be reached from any other state, and then the essential states are those that can be accessed from state 0. In order to describe the set of essential states, let us introduce the notion of face in $\mathbb{R}_+^{|\mathcal{C}|}$, which will be crucial for further analysis.

Let Λ be a subset of \mathcal{C} ; the *face* F_Λ is the subset of $\mathbb{R}_+^{|\mathcal{C}|}$ defined by:

$$(x \in F_\Lambda) \iff (x_{is} > 0 \text{ if } (i, s) \in \Lambda, \quad x_{is} = 0 \text{ if } (i, s) \notin \Lambda).$$

This notion is related to the theory of random walks in $\mathbb{Z}_+^{|\mathcal{C}|}$ which was developed by Malyshev and Menshikov [9], and to which we will refer later. Notice that the union of all the faces is a partition of $\mathbb{R}_+^{|\mathcal{C}|}$. When there is no ambiguity, Λ will also be called a face and F_Λ will simply be denoted by Λ .

We are going to prove the following lemma :

Lemma 2.2

The set of essential states (and then also the set of unessential states) is a union of faces (intersected with $\mathbb{Z}_+^{|\mathcal{C}|}$), and if F_Λ is an essential face, then so is any face $F_{\Lambda'}$ with $\Lambda' \subset \Lambda$. More precisely, the unessential faces are the faces F_Λ with $\{(1, 3), (2, 2)\} \subset \Lambda$ (which is equivalent to say that the essential states are the states $Q \in \mathbb{Z}_+^{|\mathcal{C}|}$ satisfying : $Q(1, 3) = 0$ or $Q(2, 2) = 0$). In consequence, there is an additional, necessary condition of ergodicity, which is :

$$\rho_{13} + \rho_{22} < 1,$$

and the network is transient if $\rho_{13} + \rho_{22} > 1$. At last, the usual conditions ensure that the set of essential states will be reached from any state in integrable time.

Proof :

A state of the network is a set of customers positioned in different classes in the network. A state is essential iff it can be reached from state 0, or equivalently iff these customers may be brought step by step (from an empty network) to their final positions and in some order that is compatible with the priorities (which means that a customer may not be moved forward as long as there is a customer with higher priority in his queue). It is then obvious that if a given state is essential, then any other state deduced from the first one by suppressing one or several customers will also be essential. In consequence, if some face F_Λ possesses an essential state, then the state e_Λ where there is exactly one customer by class in Λ is also essential, and so is any state $e_{\Lambda'}$ with $\Lambda' \subset \Lambda$. Inversely, if e_Λ is essential, it is easy to check that all the states in F_Λ are essential : you just have to keep the customers with the same final positions grouped and to move the different classes in the same order as for e_Λ .

Thus we proved that the essential states form a union of faces and that $F_{\Lambda'}$ is essential if F_Λ is essential and $\Lambda' \subset \Lambda$. Moreover, a face Λ is essential iff the state e_Λ can be reached from state 0. Now it is easy to check that $e_{\{(1,3),(2,2)\}}$ (that is the state with one customer in (1, 3) and one customer in (2, 2)) cannot be reached from state 0, because whichever customer is positioned first, his priority will block the other one one stage before his final position. Then all the faces F_Λ with $\{(1, 3), (2, 2)\} \subset \Lambda$ are unessential. We let the reader check empirically that any state e_Λ with $\{(1, 3), (2, 2)\} \not\subset \Lambda$ can be reached from state 0 (customers (1, 1) or (2, 1) may be forgotten because they can always be positioned after all the others).

We define:

$$\rho_0 \triangleq \rho_{13} + \rho_{22},$$

the *traffic intensity* of face $\{(1, 3), (2, 2)\}$. For all $t \geq 0$, if we start the network from an essential state, we have:

$$B_t(0) \triangleq B_t(1, 3) + B_t(2, 2) \leq \int_0^t \mathbf{1}_{\{Q_u(0) > 0\}} du,$$

where $Q_u(0) \triangleq Q_u(1, 3) + Q_u(2, 2)$. The necessary condition of ergodicity: $\rho_0 < 1$, and the sufficient condition of transience : $\rho_0 > 1$, are then obtained as in Lemma 2.1.

At last, it is easy to check that the condition $\rho_k < 1$ for some $k = 1, 2, 3$, ensures that from any initial state queue k will empty in integrable time. It is then obvious that $\rho_2 < 1$ or $\rho_3 < 1$ are sufficient conditions to reach the set of essential states in integrable time. \square

Remark 2.3

In fact, one can prove that in any multiclass network with fixed customer routes and class priorities where there is no class (i, s) such that $(i, s + 1) > (i, s)$, the set of essential states will be a union of faces, and

any subface of an essential face will be essential. Moreover, to any unessential face Λ is associated an additional, necessary condition of ergodicity, which is :

$$\rho_\Lambda \triangleq \sum_{(i,s) \in \Lambda} \rho_{is} < |\Lambda| - 1,$$

and the network is transient if $\rho_\Lambda > |\Lambda| - 1$. One can check that the unstable networks analyzed by Lu and Kumar [5], Rybko and Stolyar [8], Botvitch and Zamyatin [1] or Dai and Weiss [4] fall into this instability pattern.

Notice that $F_1(\rho) = \max_{0 \leq k \leq 3} (\rho_k - 1)$. Hence we proved that if the network is stable, then $F_1(\rho) < 0$, and if $F_1(\rho) > 0$, then the network is unstable. However, the condition $F_1(\rho) < 0$ is still not sufficient to stabilize our network. In order to prove Theorem 1.1, we will have to exploit more deeply the structure of our markovian state process. The background will be that of Malyshev and Menshikov's work about random walks in \mathbb{Z}_+^N (see [9]). It is presented in the following section.

3 Induced chains and stationary drifts.

Let $A = (a_{xy})_{x,y \in \mathbb{Z}_+^{|\mathcal{C}|}}$ denote the matrix of transition intensities of $(Q_t)_{t \geq 0}$. It is easy to check that the following conditions are satisfied:

Boundedness of jumps: there exists a constant d such that $a_{xy} = 0$ if $\|x - y\| > d$.

Space homogeneity: there exists a function $a(\Lambda, u)$, $\Lambda \subset \mathcal{C}$, $u \in \mathbb{Z}^{|\mathcal{C}|}$, such that: $a_{xy} = a(\Lambda, y - x)$, if $x \in F_\Lambda$.

The mean jump from x will be denoted by $M(x)$ and is defined by:

$$M(x) = \sum_{y \in \mathbb{Z}_+^{|\mathcal{C}|}} a_{xy}(y - x).$$

The space homogeneity implies that $M(x)$ depends only on the face that x belongs to. The mean jump from face Λ will then be denoted by $M(\Lambda)$; it is equal to:

$$M(\Lambda) = \sum_{u \in \mathbb{Z}^{|\mathcal{C}|}} a(\Lambda, u)u.$$

The key to study this kind of random walks is the notion of induced chain. It is very intuitive in our particular setting. Consider a face $\Lambda \subset \mathcal{C}$, $\Lambda \neq \emptyset$, and assume that the components of Q_0 that belong to Λ are initially infinite. Then, these components will of course remain infinite, and the space homogeneity implies that the other components will behave as a separate random walk $(Q_t^\Lambda)_{t \geq 0}$ which is the *Markov process induced by Λ* .

Let us consider the example of face $\Lambda = \{(2, 1), (2, 3)\}$. In Figure 2, the saturated classes $(2, 1)$ and $(2, 3)$ are simply marked with a bullet. The induced process $Q_t^\Lambda = (Q_t^\Lambda(i, s))_{(i,s) \notin \{(2,1), (2,3)\}}$ represents a (sub-)network with the following characteristics:

- customers $(1, 1)$ arrive at rate ν_1 (from outside the network) and are served at rate 0 (they are blocked in queue 1);

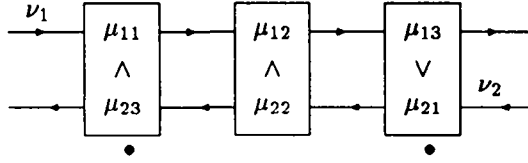

Figure 2 : Face $\{(2, 1), (2, 3)\}$.

- customers (1, 2) arrive at rate 0 (class (1, 2) is not fed), are served at rate $\mu_{12} \mathbf{1}_{\{Q(2,2)=0\}}$, and then become class (1, 3) customers ;
- customers (1, 3) arrive at rate $\mu_{12} \mathbf{1}_{\{Q(1,2)>0, Q(2,2)=0\}}$, are served at rate μ_{13} , and then leave the network ;
- customers (2, 2) arrive at rate $\mu_{21} \mathbf{1}_{\{Q(1,3)=0\}}$ (from outside the network), are served at rate μ_{22} , and then leave the network.

For any face Λ , the induced process Q^Λ satisfies the space homogeneity and the boundedness of jumps. We will denote $M^\Lambda(\Lambda')$ the mean jump of Q^Λ from face $\Lambda' \subset \mathcal{C} \setminus \Lambda$; notice that it is the (normal) projection of $M(\Lambda \cup \Lambda')$ on $\mathbb{R}^{|\mathcal{C} \setminus \Lambda|}$.

We say that face Λ is ergodic or transient if the corresponding induced process is. By convention, we say that $\Lambda = \mathcal{C}$ is ergodic. Now assume that face Λ is ergodic, and denote by π^Λ its stationary distribution, and $\pi^\Lambda(\Lambda')$ the stationary probability to be in a face $\Lambda' \subset \mathcal{C} \setminus \Lambda$. The *stationary drift* $v(\Lambda) \in \mathbb{R}_+^{|\mathcal{C}|}$ on face Λ is defined by:

$$v(\Lambda) = \sum_{\Lambda' \subset \mathcal{C} \setminus \Lambda} \pi^\Lambda(\Lambda') M(\Lambda \cup \Lambda').$$

Notice that for $(i, s) \notin \Lambda$, we have $v_{is}(\Lambda) = 0$, because $M_{is}(\Lambda \cup \Lambda') = M_{is}^\Lambda(\Lambda')$, and then $v_{is}(\Lambda)$ is the stationary mean jump on component (i, s) of the induced process, that is 0. By a natural convention, for $\Lambda = \mathcal{C}$ we set $v(\Lambda) = M(\Lambda)$.

The idea is that when the components in Λ are initially very high with respect to the other components, then until one of the components in Λ comes back to 0 (which takes a long time since the jumps are bounded), the other components will behave as $(Q_t^\Lambda)_{t \geq 0}$, and then will converge to the stationary distribution π^Λ ; in consequence, the “long term” (that is until a class in Λ empties) drift of the components in Λ will be given by $v(\Lambda)$.

Notice that for $\Lambda \subset \mathcal{C}$ and $\Lambda' \subset \mathcal{C} \setminus \Lambda$, we might define $v^\Lambda(\Lambda')$ the stationary drift of Q^Λ on face Λ' . Since obviously: $(Q^\Lambda)^{\Lambda'} = Q^{\Lambda \cup \Lambda'}$, then $v^\Lambda(\Lambda')$ is the (normal) projection of $v(\Lambda \cup \Lambda')$ on $\mathbb{R}^{|\mathcal{C} \setminus \Lambda|}$. In view of this remark, here is a simple criteria of transience of a face in terms of an *outgoing face*.

Lemma 3.1

Let two faces $\Lambda \subset \Lambda'$ be given. If Λ' is ergodic and $v_{is}(\Lambda') > 0$ for all $(i, s) \in \Lambda' \setminus \Lambda$, then Λ is transient, and Λ' is called an *outgoing face* of Λ .

Proof :

The complete proof was given by Malyshev in [6]. In view of our above remark, we have

$$(v_{is}(\Lambda'))_{(i,s) \in C \setminus \Lambda} = v^\Lambda(\Lambda' \setminus \Lambda).$$

Then in fact we just have to prove that Q_t is transient when there is an ergodic face Λ such that $v_{is}(\Lambda) > 0$ for all $(i, s) \in \Lambda$. This is the consequence of a simple ergodic theorem ; for initially high values of the components $(i, s) \in \Lambda$ with respect to the components $(i, s) \notin \Lambda$, we have with positive probability:

$$\frac{Q_t}{t} \rightarrow v(\Lambda) \quad \text{when } t \rightarrow +\infty.$$

□

Remark 3.2

The name "outgoing face" must be understood in terms of the dynamical system induced by the stationary drifts (see Malyshev [6]); we will later say some words about this notion when we will present the instability cycles of our network. During the analysis of this network, we will have to cope with situations where the conditions of Lemma 3.1 will not strictly be met. We will have an ergodic face $\Lambda' \supset \Lambda$ such that $v_{is}(\Lambda') > 0$ for all $(i, s) \in \Lambda' \setminus \Lambda$ but some $(i_0, s_0) \in \Lambda' \setminus \Lambda$ such that $v_{i_0 s_0}(\Lambda') = 0$. However, in the special cases that we will meet, it will be obvious that for initially high values of the components $(i, s) \in \Lambda' \setminus \Lambda$ with respect to the components $(i, s) \notin \Lambda'$, the component (i_0, s_0) of Q_t^Λ will not return to 0 in integrable time (it will behave as a null recurrent Markov process). In that case, Λ is not ergodic, and we will still say that Λ' is an outgoing face of Λ .

Now let us present the two fundamental criteria obtained by Malyshev and Menshikov (Theorem 2.1 of [9]). The notation df denotes the derivative of a differentiable function f .

Theorem 3.3

- If there exists a Lipschitz (and then almost everywhere differentiable) function

$$f : \mathbb{R}_+^{|\mathcal{C}|} \rightarrow \mathbb{R}_+$$

such that for some $\epsilon > 0$:

$$\forall \Lambda \subset \mathcal{C}, \Lambda \text{ ergodic}, \forall q \in F_\Lambda : \quad df(q, v(\Lambda)) \leq -\epsilon,$$

then the Markov process $(Q_t)_{t \geq 0}$ is ergodic.

- If there exists a Lipschitz (and then almost everywhere differentiable) function

$$f : \mathbb{R}_+^{|\mathcal{C}|} \rightarrow \mathbb{R}$$

such that for some $\epsilon > 0$:

$$\forall \Lambda \subset \mathcal{C}, \Lambda \text{ ergodic}, \forall q \in F_\Lambda : \quad df(q, v(\Lambda)) \geq \epsilon,$$

then the Markov process $(Q_t)_{t \geq 0}$ is transient.

Remark 3.4

These criteria were actually proven for discrete time Markov chains. However, there is a classic way of coping with this problem; it consists in introducing the discrete time random walk $(\tilde{Q}_n)_{n \in \mathbb{N}}$ whose transition matrix is

$$\tilde{A} = I + \epsilon A,$$

where I denotes the identity matrix and ϵ satisfies:

$$0 < \epsilon \leq \min_x \frac{1}{\sum_y a_{xy}}.$$

For $\Lambda \in \mathcal{C}$, if Q_t^Λ admits A^Λ as transition matrix, then $\tilde{A}^\Lambda = I + \epsilon A^\Lambda$ will be the transition matrix of \tilde{Q}_t^Λ ; in consequence, \tilde{Q}_t^Λ is ergodic if and only if Q_t^Λ is ergodic, and then their stationary distributions $\tilde{\pi}^\Lambda$ and π^Λ are equal; moreover one easily checks that:

$$\tilde{v}(\Lambda) = \epsilon v(\Lambda).$$

All these relations justify the passage from discrete time to continuous time.

In the following section, we will explain how to calculate the stationary drifts as solutions of some limit equations.

4 Stationary flows and limit equations.

At first we must introduce a few new notations.

For a given type of customers $i = 1, 2$, we will denote by $N_t(i)$ the number of type i arrivals into the network up to time t . By convention, we set: $N_0(i) = 0$, which means that $N_t(i)$ does not include the customers already present in the network at time 0; then it is simply the counting function of a Poisson process of parameter ν_i .

For a given class $(i, s) \in \mathcal{C}$, $D_t(i, s)$ is the number of departures from class (i, s) up to time t (with the convention: $D_0(i, s) = 0$).

By laws of large numbers, we get that almost surely for any type i :

$$\frac{N_t(i)}{t} \rightarrow \nu_i \quad \text{when } t \rightarrow +\infty,$$

and almost surely for any class (i, s) :

$$\frac{B_t(i, s)}{t} - \frac{1}{\mu_{is}} \frac{D_t(i, s)}{t} \rightarrow 0 \quad \text{when } t \rightarrow +\infty.$$

Now take an ergodic face Λ , and consider the induced process Q_t^Λ jointly with the infinite components in Λ . If Q_t^Λ is ergodic, then there is a limit distribution π^Λ and limit probabilities $\pi^\Lambda(\Lambda')$ to be in a face $\Lambda' \in \mathcal{C} \setminus \Lambda$, or rather (if we consider all the components in \mathcal{C}) limit probabilities $\pi^\Lambda(\Lambda')$ to be in a face $\Lambda' \supset \Lambda$. In consequence, for any class $(i, s) \in \mathcal{C}$, we have almost surely:

$$\frac{B_t(i, s)}{t} = \frac{1}{t} \int_0^t \mathbf{1}_{\{Q_u(i, s) > 0, Q_u(j, r) = 0 \text{ if } (j, r) > (i, s)\}} du \rightarrow \sum_{\Lambda' \in \mathcal{L}_{i, s}} \pi^\Lambda(\Lambda'),$$

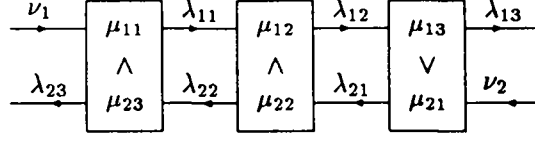

Figure 3 : Network 1 with its flow vector.

where $\mathcal{L}_{i,s}$ is the set of all the faces that satisfy:

$$\Lambda' \supset \Lambda, \quad \Lambda' \ni (i, s), \quad \Lambda' \cap \{(j, r) / (j, r) > (i, s)\} = \emptyset.$$

Set:

$$\lambda_{i,s}(\Lambda) = \mu_{i,s} \sum_{\Lambda' \in \mathcal{L}_{i,s}} \pi^{\Lambda}(\Lambda').$$

Then almost surely for any class (i, s) :

$$\frac{D_t(i, s)}{t} \rightarrow \lambda_{i,s}(\Lambda) \quad \text{when } t \rightarrow +\infty.$$

It is easy to check that for any class (i, s) :

$$v_{i,s}(\Lambda) = \lambda_{i,s-1}(\Lambda) - \lambda_{i,s}(\Lambda), \quad \text{with the convention: } \lambda_{i0}(\Lambda) = \nu_i. \quad (1)$$

You just have to notice that the (i, s) component of $M(\Lambda)$ may be written:

$$M_{i,s}(\Lambda) = \mu_{i,s-1}(\Lambda) - \mu_{i,s}(\Lambda)$$

with $\mu_{i0}(\Lambda) = \nu_i$, and for $s \geq 1$:

$$\mu_{i,s}(\Lambda) = \begin{cases} \mu_{i,s} & \text{if } (i, s) \in \Lambda \text{ and } (j, r) \notin \Lambda \text{ for } (j, r) > (i, s) \\ 0 & \text{otherwise} \end{cases}$$

The relation (1) is the limit version of the following relation:

$$Q_t(i, s) = Q_0(i, s) + D_t(i, s-1) - D_t(i, s), \quad \text{with the convention } D_t(i, 0) = N_t(i).$$

Then for $(i, s) \in \Lambda$, $v_{i,s}(\Lambda)$ may be interpreted as the limit, average "drift" of $Q_t(i, s)$ when all the classes in Λ (initially) possess an infinite number of customers.

The vector $\lambda(\Lambda) = (\lambda_{i,s}(\Lambda))_{(i,s) \in \mathcal{C}}$ will be called the *stationary flow* on face Λ . Figure 3 pictures the flows through our network on an unspecified, ergodic face (from now on, the stationary flow will simply be denoted by λ). It will be simpler (but obviously equivalent) to compute the stationary flow than the stationary drift. There are indeed some *limit equations* that must be satisfied by such flow vectors.

Lemma 4.1

Consider a queue $k = 1, 2, 3$ with $\Lambda_k = \{(i_1, s_1), (i_2, s_2)\}$ and $(i_1, s_1) > (i_2, s_2)$ (see Figure 4). Suppose that $\Lambda \subset \mathcal{C}$ is an ergodic face, and let λ be the stationary flow on Λ .

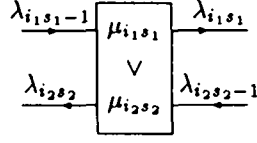

Figure 4 : Single queue with two classes.

Rule 1. If $(i_1, s_1) \in \Lambda$, then:

$$\lambda_{i_1 s_1} = \mu_{i_1 s_1}, \quad \text{and:} \quad \lambda_{i_2 s_2} = 0.$$

Rule 2. If $(i_1, s_1) \in \Lambda$ and $(i_2, s_2) \notin \Lambda$, then we must have $\lambda_{i_2 s_2 - 1} = \lambda_{i_2 s_2} = 0$.

Rule 3. If $(i_1, s_1) \notin \Lambda$, then $\lambda_{i_1 s_1} = \lambda_{i_1 s_1 - 1}$, but we must have: $\frac{\lambda_{i_1 s_1 - 1}}{\mu_{i_1 s_1}} \leq 1$, or $\lambda_{i_1 s_1 - 1} \leq \mu_{i_1 s_1}$.

Rule 4. If $(i_1, s_1) \notin \Lambda$ and $(i_2, s_2) \in \Lambda$, then:

$$\lambda_{i_2 s_2} = \mu_{i_2 s_2} \left(1 - \frac{\lambda_{i_1 s_1 - 1}}{\mu_{i_1 s_1}}\right).$$

Rule 5. If $(i_1, s_1) \notin \Lambda$ and $(i_2, s_2) \notin \Lambda$, then $\lambda_{i_2 s_2} = \lambda_{i_2 s_2 - 1}$, but we must have:

$$\frac{\lambda_{i_1 s_1 - 1}}{\mu_{i_1 s_1}} + \frac{\lambda_{i_2 s_2 - 1}}{\mu_{i_2 s_2}} \leq 1.$$

Proof :

At first, as we already noticed, if $(i, s) \notin \Lambda$ we must have $v_{i,s}(\Lambda) = 0$, or $\lambda_{i,s}(\Lambda) = \lambda_{i,s-1}(\Lambda)$, which in fact comes directly from

$$\frac{Q_t^\Lambda(i, s)}{t} \rightarrow 0.$$

Now fix a class $(i, s) \in \mathcal{C}$.

Assume that $\Lambda \cap \{(j, r)/(j, r) \geq (i, s)\} \neq \emptyset$, and then take initially $Q_0(j, r) = +\infty$ for $(j, r) \in \Lambda$, $(j, r) \geq (i, s)$. Then the server of queue $k_{i,s}$ will never be idle, and moreover its activity will be monopolized by the classes $(j, r) \geq (i, s)$ (due to the priority in the queue). Then at any time $t > 0$ we will have:

$$\sum_{(j,r) \geq (i,s)} B_t(j, r) = t,$$

which implies that:

$$\sum_{(j,r) \geq (i,s)} \frac{\lambda_{j,r}(\Lambda)}{\mu_{j,r}} = 1.$$

If on the contrary $\Lambda \cap \{(j, r)/(j, r) \geq (i, s)\} = \emptyset$, then we must have:

$$\frac{\sum_{(j,r) \geq (i,s)} Q_t^\Lambda(j, r)}{t} \rightarrow 0$$

by ergodicity of Q_t^Λ . Since the classes $(j, r) \geq (i, s)$ are served in priority, one can check that this will happen iff the limit, average service demand at the queue does not exceed the capacity of the server (which is equal to one); or equivalently iff

$$\sum_{(j,r) \geq (i,s)} \frac{\lambda_{jr-1}(\Lambda)}{\mu_{jr}} \leq 1.$$

All the rules enounced in the above lemma may be deduced from these three fundamental results. \square

Lemma 4.1 leads us to make the following definition: a vector $\lambda \in \mathbb{R}_+^{|\mathcal{C}|}$ is an *admissible flow* on face Λ if it satisfies all the conditions enounced in Lemma 4.1, regardless of the ergodicity of Λ .

Remark 4.2

- Notice that we always have: $\lambda_{is} \leq \mu_{is}$.
- Any admissible vector λ in $\mathbb{R}_+^{|\mathcal{C}|}$ must satisfy a system of $|\mathcal{C}|$ affine equations (plus additional constraints) which will usually have a unique solution except for special values of the parameters ν_i , $i = 1, 2$, and μ_{is} , $(i, s) \in \mathcal{C}$. Then in general, each face admits at most one admissible drift or flow. But non-ergodic (and even transient) faces may admit admissible flows.

In order to test a candidate function f for Theorem 3.3, we will then proceed as follows: for any face Λ , either there is no admissible flow and then Λ is not ergodic; or Λ admits an obvious (or not) outgoing face, and then it is transient; or there is an admissible flow, and there is no evidence that Λ is not ergodic: then for the corresponding drift v , either $df(q, v)$ has the desired sign for all $q \in \Lambda$, and we can pass to another face; or it has the wrong sign, and we must try another Lyapunov function. Of course we do not pretend that this procedure exhausts all the possibilities; in particular, there are many transient faces that have no outgoing face. However, this procedure will be sufficient to treat all the cases that we will have to face. Moreover, we will see that it is usually not necessary to make the complete calculation of the admissible flow to estimate the derivative of f .

At last, notice that we will use the notation \dot{f} for the derivative of f along the admissible flow.

5 Dynamical system and instability cycles.

For a general introduction to the dynamical system associated to the stationary drifts $v(\Lambda)$, see Malyshev [6]. Here we just rewrite the very first lines of his work. It is assumed that all the stationary drifts $v(\Lambda)$ satisfy :

$$v_{is}(\Lambda) \neq 0 \quad \text{if } (i, s) \in \Lambda.$$

A path Q of the dynamical system is a continuous mapping from some interval $[0, T]$ ($T \leq +\infty$) in $\mathbb{R}_+^{|\mathcal{C}|}$ such that:

- (i) Q_t belongs to the union of ergodic faces almost everywhere;
- (ii) If $Q_t \in F_\Lambda$ for some $t \geq 0$ and some ergodic face Λ , then $\frac{dQ}{dt} = v(\Lambda)$.

Notice that there may be several (if not infinitely many) ways to go out of Λ if Λ is a non-ergodic face (this phenomena is called *scattering*). The simplest way to go out of a non-ergodic face Λ is to follow the drift $v(\Lambda')$ of an outgoing face Λ' of Λ (if there is one).

Roughly speaking, the idea is that the original Markov process is transient if the dynamical system admits some diverging path. In some special cases, it is possible to prove that the stochastic model asymptotically follows a diverging path with positive probability, which accounts for transience. In this section, we will simply exhibit some diverging paths of the dynamical system associated to our network. Our intention is:

- to give the intuition of the modes of instability of the network;
- to show how the conditions of stability may be found out.

In section 6, we will indeed prove that the diverging paths correspond to zones of transience (with respect to the vector of traffic intensities), and in section 7 we will prove that the network is stable outside these zones. For this we will use the criteria of Theorem 3.3. The only results of the current section that will later be exploited are the identification of some ergodic (or non-ergodic) faces and the calculation of their stationary drifts; these results are located at the beginning of the proofs of Propositions 5.1 and 5.2.

We will work under the condition $F_1(\rho) \leq 0$, which is equivalent to the following set of conditions :

Extended, usual conditions :

$$\rho_{11} + \rho_{23} \leq 1 \quad (2)$$

$$\rho_{12} + \rho_{22} \leq 1 \quad (3)$$

$$\rho_{13} + \rho_{21} \leq 1 \quad (4)$$

Extended, additional condition :

$$\rho_{13} + \rho_{22} \leq 1 \quad (5)$$

since the network is already known to be transient if one of these conditions is not satisfied.

We are now going to present different diverging paths corresponding to different values of the parameters (that is the traffic intensities). All have the same form: they start at time $t = 0$ from face $\{(1, 1)\}$, which is transient ; then they consecutively run through several ergodic faces (the first one being an outgoing face of $\{(1, 1)\}$) and finally reach face $\{(2, 1)\}$, which is transient ; then they consecutively run through several ergodic faces (the first one being an outgoing face of $\{(2, 1)\}$) and finally reach face $\{(1, 1)\}$ again ; this pattern is then repeated infinitely often. We call this kind of path a "cycle" ; these cycles are diverging because when the path comes back to face $\{(1, 1)\}$ (at some time that we will denote T), we have :

$$Q_T(1, 1) = \theta Q_0(1, 1) \quad \text{for some constant } \theta > 1.$$

It is then easy to check that the whole path satisfies :

$$\forall t \geq 0 : Q_{T+t} = \theta Q_{\frac{t}{\theta}}, \quad \text{or :}$$

$$\forall n \in \mathbb{N}, \forall t \in [0, \theta^{n+1}T] : Q_{T+\theta T+\dots+\theta^n T+t} = \theta^{n+1} Q_{\frac{t}{\theta^{n+1}}}.$$

Three different intermediate paths from face $\{(1, 1)\}$ to face $\{(2, 1)\}$ (resp. two different paths from face $\{(2, 1)\}$ to face $\{(1, 1)\}$), which will be denoted as paths (1.1), (1.2), (1.3) (resp. as paths (2.1) and (2.2)), will be involved in our different cycles. Figures 5 to 9 picture the sequences of ergodic faces

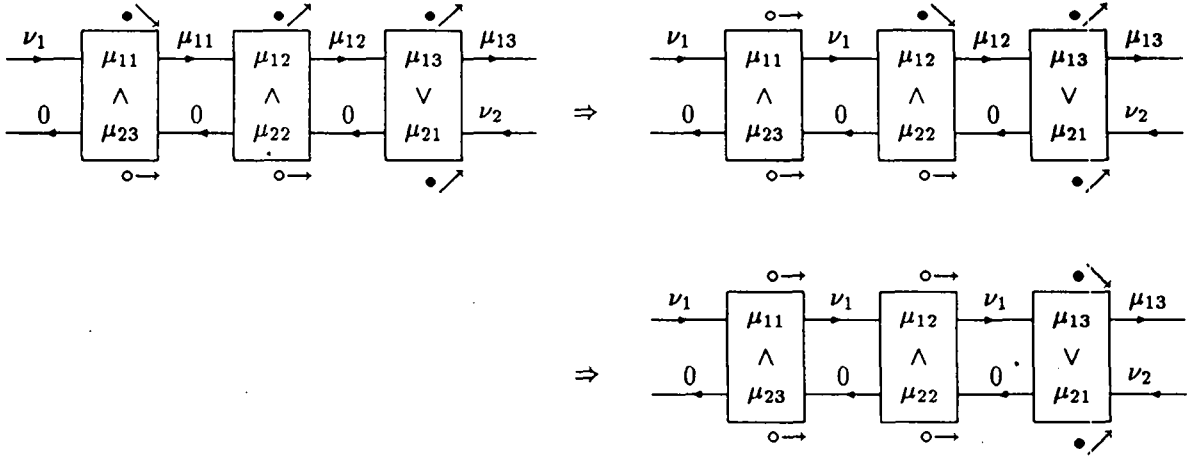

Figure 5 : From $\{(1, 1)\}$ to $\{(2, 1)\}$: path (1.1).

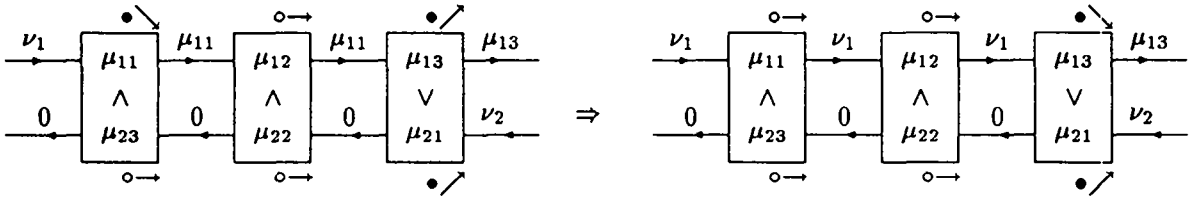

Figure 6 : From $\{(1, 1)\}$ to $\{(2, 1)\}$: path (1.2).

corresponding to these different paths. For an ergodic face Λ , the notation: \bullet/\nearrow (resp. \bullet/\searrow) next to a class (i, s) means that $(i, s) \in \Lambda$ and $v_{i,s}(\Lambda) > 0$ (resp. $v_{i,s}(\Lambda) < 0$); the notation $\circ \rightarrow$ means that $(i, s) \notin \Lambda$ and then $v_{i,s}(\Lambda) = 0$. The exact flows are also written in these pictures (except for path (1.3), because the formulas for λ_{11} , λ_{12} and λ_{21} are a bit complex).

It is easy to check that when these faces are actually ergodic and their drifts have the signs pictured on the figures, they actually provide paths from $\{(1, 1)\}$ to $\{(2, 1)\}$ or from $\{(2, 1)\}$ to $\{(1, 1)\}$. We are now going to present the conditions under which diverging cycles may be built from these intermediate paths.

Proposition 5.1

Assume that the following, supplementary conditions are satisfied:

$$\rho_{13} + \rho_{23} > 1 \tag{6}$$

$$\rho_{12} < \rho_{13} \tag{7}$$

Then $\mu_{11} \wedge \mu_{12} > \mu_{13}$ and $\mu_{21} \wedge \mu_{22} > \mu_{23}$; moreover, the paths (1.1) (if $\mu_{11} > \mu_{12}$) or (1.2) (if $\mu_{11} \leq \mu_{12}$) and (2.1) (if $\mu_{21} > \mu_{22}$) or (2.2) (if $\mu_{21} \leq \mu_{22}$) form a diverging cycle.

Proof :

Condition (6), compared with conditions (2), (4) and (5), yields $\rho_{13} > \rho_{11}$, $\rho_{23} > \rho_{21}$ and $\rho_{23} > \rho_{22}$,

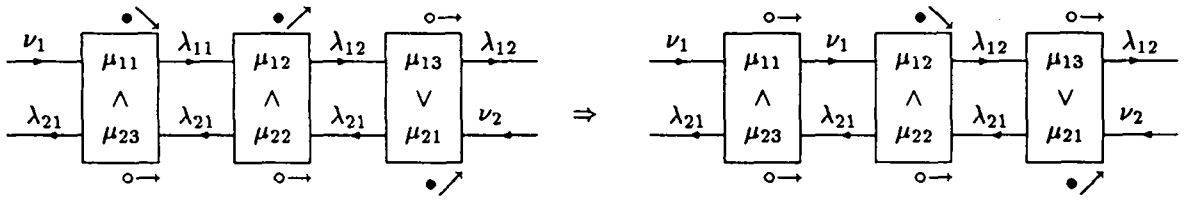

Figure 7 : From $\{(1, 1)\}$ to $\{(2, 1)\}$: path (1.3).

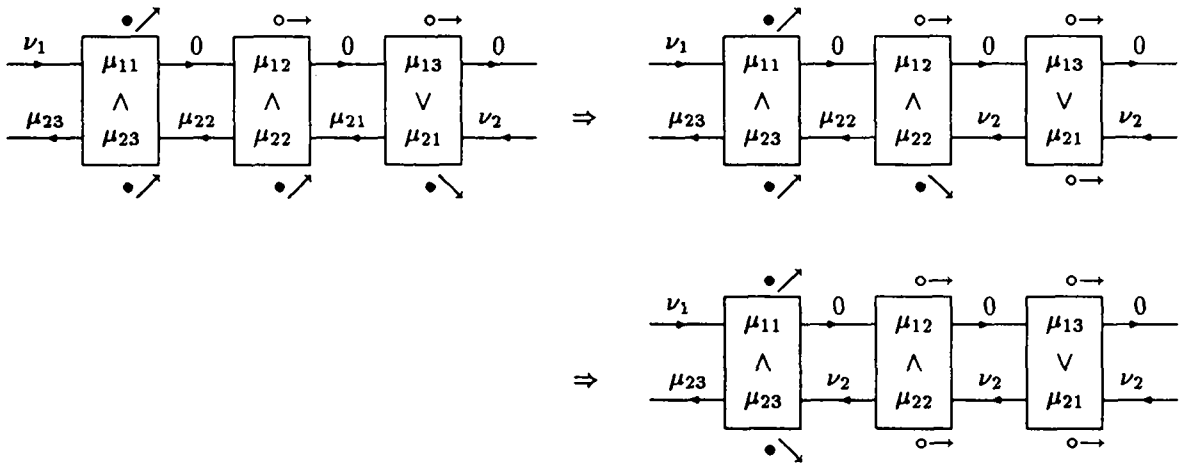

Figure 8 : From $\{(2, 1)\}$ to $\{(1, 1)\}$: path (2.1).

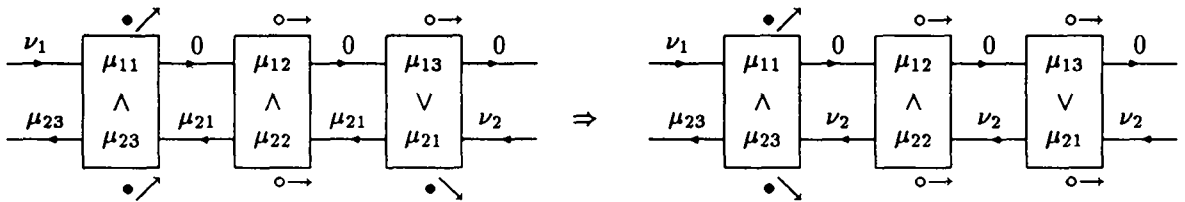

Figure 9 : From $\{(2, 1)\}$ to $\{(1, 1)\}$: path (2.2).

which in view of condition (7) is equivalent to:

$$\mu_{11} \wedge \mu_{12} > \mu_{13}, \text{ and: } \mu_{21} \wedge \mu_{22} > \mu_{23}.$$

It is easy to check that the faces of paths (1.1) and (2.1) are ergodic in any case, and that the first face of path (1.2) (resp. the first face of path (2.2)) is ergodic iff $\mu_{11} < \mu_{12}$ (resp. iff $\mu_{21} < \mu_{22}$): the induced Markov process always has some components that empty in integrable time, while the other components form a stable queue or a stable tandem. The flows are also easy to compute: the corresponding drifts are signed as pictured in the different figures (under condition $\mu_{11} > \mu_{12}$ for the first face of path (1.1), under condition $\mu_{21} > \mu_{22}$ for the first face of path (2.1)).

In the limit case $\mu_{11} = \mu_{12}$ (resp. $\mu_{21} = \mu_{22}$), we have $v_{12}(\Lambda) = 0$ (resp. $v_{22}(\Lambda) = 0$) on the first face $\Lambda = \{(1, 1), (1, 2), (1, 3), (2, 1)\}$ of path (1.1) (resp. on the first face $\Lambda = \{(2, 1), (2, 2), (2, 3), (1, 1)\}$ of path (2.1)). It is not difficult to check that any subspace of Λ including class (1, 1) (resp. including class (2, 1)) admits Λ as an outgoing face in the sense of remark 3.2, and then is non-ergodic. Notice also that this kind of limit case was not taken into account in the definition of the dynamical system; it is clear that by following the drift $v(\Lambda)$ from $\{(1, 1)\}$ (resp. from $\{(2, 1)\}$), the dynamical system will in fact run through face $\{(1, 1), (1, 3), (2, 1)\}$ (resp. $\{(2, 1), (2, 3), (1, 1)\}$), even if here this face is not ergodic (in fact it could be proven to be null recurrent), and then our diverging cycle will in fact follow path (1.2) (resp. path (2.2)).

The condition under which these cycles are diverging might be obtained by an explicit calculation of $Q_T(1, 1)$ with respect to $Q_0(1, 1)$ (T is the length of the first cycle). A simpler way to get it consists in considering the following function which will later be useful to prove the transience of the network in this case:

$$f(Q) = \frac{Q(1, 1) + Q(1, 2) + Q(1, 3)}{\mu_{13}} + \frac{Q(2, 1) + Q(2, 2) + Q(2, 3)}{\mu_{23}} \\ \sim W(1, 3) + W(2, 3).$$

We obviously have:

$$\dot{f} = \rho_{13} + \rho_{23} - \frac{\lambda_{13}}{\mu_{13}} - \frac{\lambda_{23}}{\mu_{23}},$$

and it is easy to check that on any face which our cycles run through we have:

$$\frac{\lambda_{13}}{\mu_{13}} + \frac{\lambda_{23}}{\mu_{23}} = 1,$$

or equivalently:

$$\dot{f} = \rho_{13} + \rho_{23} - 1.$$

Then under condition (6), our cycles are actually diverging. □

The following proposition describes a second type of diverging cycles.

Proposition 5.2

Assume that the following, supplementary conditions are satisfied:

$$\rho_{13} + \rho_{23} > 1 \tag{6}$$

$$\rho_{12} \geq \rho_{13} \tag{8}$$

$$(\rho_{12} + \rho_{23} - 1)(1 - \rho_{13} - \rho_{21}) < (\rho_{13} + \rho_{23} - 1)(1 - \rho_{12} - \rho_{22}). \tag{9}$$

Then $\mu_{11} > \mu_{13} \geq \mu_{12}$ and $\mu_{22} > \mu_{21} > \mu_{23}$. Moreover, the paths (1.3) and (2.2) form a diverging cycle.

Proof :

Condition (8) is equivalent to $\mu_{12} \leq \mu_{13}$. When confronted to conditions (6) and (9), it yields $\rho_{21} > \rho_{22}$, or $\mu_{21} < \mu_{22}$. The other conditions are obtained as for the cycles of the first type.

The ergodicity of the faces of path (2.2) has already been checked. Let us analyze the Markov processes induced by the two faces of path (1.3) ; we assume that $\mu_{12} < \mu_{13}$. At first notice that the components (1, 3) and (2, 2) form a sub-Markov process of the induced process, whose essential states are the vectors $q = (q_{13}, q_{22}) \in \mathbb{Z}_+^2$ such that $q_{13}q_{22} = 0$. If $q_{13} > 0$ and $q_{22} = 0$, the mean jump is $(\mu_{12} - \mu_{13}, 0)$, with $\mu_{12} - \mu_{13} < 0$. If $q_{13} = 0$ and $q_{22} > 0$, the mean jump is $(0, \mu_{21} - \mu_{22})$, with $\mu_{21} - \mu_{22} < 0$. This subprocess is then ergodic. The stationary flows λ_{12} and λ_{21} are common to both faces. They satisfy (cf. Lemma 4.1):

$$\begin{cases} \lambda_{12} = \mu_{12} \left(1 - \frac{\lambda_{21}}{\mu_{22}}\right) \\ \lambda_{21} = \mu_{21} \left(1 - \frac{\lambda_{12}}{\mu_{13}}\right). \end{cases}$$

We get that:

$$\begin{cases} \frac{\lambda_{12}}{\nu_1} = \frac{\rho_{21} - \rho_{22}}{\rho_{12}\rho_{21} - \rho_{13}\rho_{22}} \\ \frac{\lambda_{21}}{\nu_2} = \frac{\rho_{12} - \rho_{13}}{\rho_{12}\rho_{21} - \rho_{13}\rho_{22}} \end{cases}$$

We will later prove that condition (9) is equivalent to :

$$\frac{\lambda_{21}}{\nu_2} < \frac{\rho_{12} + \rho_{23} - 1}{\rho_{22}(\rho_{12} + \rho_{23} - 1) + \rho_{12}(\rho_{23} - \rho_{22})}, \quad (10)$$

and we let the reader check that

$$\frac{\rho_{12} + \rho_{23} - 1}{\rho_{22}(\rho_{12} + \rho_{23} - 1) + \rho_{12}(\rho_{23} - \rho_{22})} \leq 1 \Leftrightarrow \rho_{12} + \rho_{22} \leq 1,$$

which is condition (3). Then we get that :

$$\lambda_{21} < \nu_2. \quad (11)$$

In consequence, queue 1 will be fed by two arrival processes of rates ν_1 and $\lambda_{21} < \nu_2$, and then, in view of condition (2), the Markov processes induced by the faces of path (1.3) are ergodic (a complete proof could be given in terms of the criterion of Theorem 3.3).

The stationary flows on these faces are then easy to compute (see Figure 7). On the first face of path (1.3), we have by Lemma 4.1 :

$$\begin{aligned} \lambda_{11} &= \mu_{11} \left(1 - \frac{\lambda_{21}}{\mu_{23}}\right) \\ &> \nu_1 \quad \text{by conditions (2) and (11)}. \end{aligned}$$

Since this face is supposed to be the outgoing face of $\{(1, 1)\}$, we must check that $\lambda_{11} > \lambda_{12}$. In view of the expressions of λ_{11} and λ_{12} with respect to λ_{21} , we get that:

$$\lambda_{11} > \lambda_{12} \Leftrightarrow \lambda_{21} < \frac{\rho_{12} - \rho_{11}}{\rho_{12}\rho_{23} - \rho_{11}\rho_{22}}.$$

Thus in view of relation (10), we just have to check that :

$$\frac{\rho_{12} + \rho_{23} - 1}{\rho_{22}(\rho_{12} + \rho_{23} - 1) + \rho_{12}(\rho_{23} - \rho_{22})} \leq \frac{\rho_{12} - \rho_{11}}{\rho_{12}\rho_{23} - \rho_{11}\rho_{22}}.$$

This is equivalent to

$$\rho_{11} + \rho_{23} \leq 1,$$

which is condition (2). In consequence, we actually have $\lambda_{11} > \lambda_{12}$.

In the limit case $\mu_{12} = \mu_{13}$, the faces of path (1.3) could be proven to be null recurrent ; they admit the corresponding faces of path (1.1) as outgoing faces in the sense of remark 3.2 (on these faces we have $\nu_{13}(\Lambda) = 0$) ; notice that the admissible flows on these null recurrent faces of path (1.3) are equal to the flows on their corresponding outgoing faces of path (1.1).

Let us now make the explicit calculation of $Q_T(1, 1)$ with respect to $Q_0(1, 1)$ after one cycle. Thus we start from face $\{(1, 1)\}$ with $Q_0(1, 1) = q > 0$. Let T_1 denote the time when the path reaches face $\{(2, 1)\}$. For $0 \leq t \leq T_1$, we have:

$$\begin{cases} \frac{d(Q(1, 1) + Q(1, 2) + Q(1, 3))}{dt} = \nu_1 - \lambda_{12}, \\ \frac{dQ(2, 1)}{dt} = \nu_2 - \lambda_{21} \end{cases}$$

(with λ_{12} and λ_{21} already calculated), and then:

$$\begin{cases} T_1 = \frac{q}{\lambda_{12} - \nu_1}, \\ Q_{T_1}(2, 1) = (\nu_2 - \lambda_{21})T_1 = \frac{\nu_2 - \lambda_{21}}{\lambda_{12} - \nu_1} q. \end{cases}$$

Let now T_2 denote the time when the path comes back to face $\{(1, 1)\}$. For $T_1 \leq t \leq T_2$, we have:

$$\begin{cases} \frac{d(Q(2, 1) + Q(2, 2) + Q(2, 3))}{dt} = \nu_2 - \mu_{23}, \\ \frac{dQ(1, 1)}{dt} = \nu_1, \end{cases}$$

and then:

$$\begin{cases} T_2 - T_1 = \frac{Q_{T_1}(2, 1)}{\mu_{23} - \nu_2} = \frac{\nu_2 - \lambda_{21}}{(\lambda_{12} - \nu_1)(\mu_{23} - \nu_2)} q, \\ Q_{T_2}(1, 1) = \nu_1(T_2 - T_1) = \frac{\nu_1(\nu_2 - \lambda_{21})}{(\lambda_{12} - \nu_1)(\mu_{23} - \nu_2)} q = \frac{\rho_{23}(1 - \frac{\lambda_{21}}{\nu_2})}{(1 - \rho_{23})(\frac{\lambda_{12}}{\nu_1} - 1)} q \end{cases}$$

Thus the path is diverging iff

$$\frac{\rho_{23}(1 - \frac{\lambda_{21}}{\nu_2})}{(1 - \rho_{23})(\frac{\lambda_{12}}{\nu_1} - 1)} > 1.$$

Let us express this condition in terms of λ_{21} :

$$\begin{aligned} \rho_{23}(1 - \frac{\lambda_{21}}{\nu_2}) > (1 - \rho_{23})(\frac{\lambda_{12}}{\nu_1} - 1) &\Leftrightarrow \rho_{23}(1 - \frac{\lambda_{21}}{\nu_2}) > (1 - \rho_{23}) \left(\frac{1 - \rho_{22} \frac{\lambda_{21}}{\nu_2}}{\rho_{12}} - 1 \right) \\ &\Leftrightarrow \frac{\lambda_{21}}{\nu_2} < \frac{\rho_{12} + \rho_{23} - 1}{\rho_{22}(\rho_{12} + \rho_{23} - 1) + \rho_{12}(\rho_{23} - \rho_{22})} \end{aligned}$$

which is condition (10).

More explicitly :

$$\begin{aligned} \frac{\lambda_{21}}{\nu_2} &< \frac{\rho_{12} + \rho_{23} - 1}{\rho_{22}(\rho_{12} + \rho_{23} - 1) + \rho_{12}(\rho_{23} - \rho_{22})} \\ &\Leftrightarrow \frac{\rho_{12} - \rho_{13}}{\rho_{12}\rho_{21} - \rho_{22}\rho_{13}} < \frac{\rho_{12} + \rho_{23} - 1}{\rho_{22}(\rho_{12} + \rho_{23} - 1) + \rho_{12}(\rho_{23} - \rho_{22})} \\ &\stackrel{[\dots]}{\Leftrightarrow} (\rho_{12} + \rho_{23} - 1)(1 - \rho_{13} - \rho_{21}) < (\rho_{13} + \rho_{23} - 1)(1 - \rho_{12} + \rho_{22}), \end{aligned}$$

which is condition (9) of the proposition. The proof is now complete. \square

Notice that these diverging paths correspond to the condition: $F_1(\rho) \leq 0$, $F_3(\rho) > 0$. By use of the transience criterion of Theorem 3.3, we are now going to prove that the network is transient under this condition. The ergodicity criterion of the same theorem will later allow us to prove that the network is stable if $F_3(\rho) < 0$ and $F_1(\rho) < 0$.

6 Instability conditions.

We keep on working under conditions (2), (3), (4) and (5). In this section, we are going to give the proofs of transience of our network in the zones delimited in the previous section. For this we will apply the criterion of transience in Theorem 3.3. Our Lyapunov functions will be based on functions $\mathbf{W}(i, s)$, $(i, s) \in \mathcal{C}$.

Proposition 6.1

If the following conditions are satisfied :

$$\rho_{22} < \rho_{23} \tag{12}$$

$$\rho_{13} + \rho_{23} > 1 \tag{6}$$

$$\rho_{12} < \rho_{13} \tag{7}$$

then the network is unstable (transient).

Remark 6.2

Condition (12), which in fact arises as a consequence of conditions (5) and (6), was added because it plays a specific role in the stability conditions that we will analyze in the next section.

Proof :

Let us recall that the above conditions imply that : $\mu_{11} \wedge \mu_{12} > \mu_{13}$ and $\mu_{21} \wedge \mu_{22} > \mu_{23}$.

Consider the following functions:

$$\begin{cases} f_1(Q) = [Q(1, 2) \wedge Q(2, 1) - \alpha Q(1, 3)]^+ \\ f_2(Q) = [Q(1, 2) + Q(1, 3)] \wedge [Q(2, 2) + Q(2, 3)] \\ f_3(Q) = \frac{Q(1, 1) + Q(1, 2) + Q(1, 3)}{\mu_{13}} + \frac{Q(2, 1) + Q(2, 2) + Q(2, 3)}{\mu_{23}} \sim \mathbf{W}(1, 3) + \mathbf{W}(2, 3) \end{cases}$$

and:

$$f(Q) = -\gamma(\beta f_1(q) + f_2(q)) + f_3(Q),$$

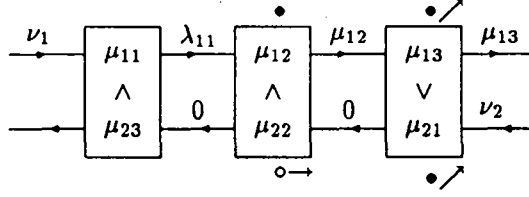

Figure 10 : $\{(1, 2), (1, 3), (2, 1)\} \subset \Lambda$.

where α, β and γ are “sufficiently large”, positive constants.

We already checked that $f_3 = \rho_{13} + \rho_{23} - 1 > 0$ along the corresponding cycle. Our idea is that from any initial state the dynamical system eventually joins this diverging path. Functions f_1 and f_2 are arbitrary means to translate this idea in terms of Lyapunov functions. We have indeed : $f_1(Q) = f_2(Q) = 0$ on any face of the cycle, and we will prove that:

- for sufficiently large values of α , on any part of an ergodic face where $f_1 > 0$, we have $\dot{f}_1 \leq 0$, and either $\dot{f}_1 \leq -\epsilon_1$ for some positive constant ϵ_1 , or $\dot{f}_1 = 0$ and $f_3 = \rho_{13} + \rho_{23} - 1 > 0$;
- on any ergodic face where $f_1 = 0$ and $f_2 > 0$, we have $\dot{f}_1 = 0$ (which is obvious in view of the above assertion) and $\dot{f}_2 \leq 0$, and either $\dot{f}_2 \leq -\epsilon_2$ for some positive constant ϵ_2 , or $\dot{f}_2 = 0$ and $\dot{f}_3 = \rho_{13} + \rho_{23} - 1 > 0$;
- on any ergodic face where $f_1 = f_2 = 0$ and $f_3 > 0$, we have $\dot{f}_1 = \dot{f}_2 = 0$ (which is obvious) and $\dot{f}_3 = \rho_{13} + \rho_{23} - 1 > 0$.

It will then be obvious that for sufficiently large values of α, β and γ , there exists a constant $\epsilon > 0$ such that on any ergodic face, we have $\dot{f} \geq \epsilon$. Since f is obviously Lipschitz, transience will follow from Theorem 3.3.

Case $f_1 > 0$:

At first consider an ergodic face where $f_1 > 0$, and then $\{(1, 2), (2, 1)\} \subset \Lambda$. We have :

$$\dot{f}_1 \leq (\lambda_{11} - \lambda_{12}) \vee (\nu_2 - \lambda_{21}) - \alpha(\lambda_{12} - \lambda_{13}).$$

- If $(1, 3) \in \Lambda$, then $(2, 2) \notin \Lambda$ (otherwise the face would be unessential), and then we have: $\lambda_{13} = \mu_{13}$, $\lambda_{22} = \lambda_{21} = 0$, and $\lambda_{12} = \mu_{12}$ (see Figure 10). In consequence: $\lambda_{12} - \lambda_{13} = \mu_{12} - \mu_{13} > 0$, and then $\dot{f}_1 < 0$ for sufficiently high values of α .
- If $(1, 3) \notin \Lambda$, we must have $(2, 2) \in \Lambda$, because otherwise there would be an outgoing face on the model of Figure 10. We thus have $\lambda_{22} = \mu_{22} > \mu_{23}$, and then we must have $(2, 3) \in \Lambda$ and $(1, 1) \in \Lambda$; that is:

$$\Lambda = \{(1, 1), (1, 2), (2, 1), (2, 2), (2, 3)\}$$

(see Figure 11). In consequence, we have $\lambda_{23} = \mu_{23}$ and $\lambda_{11} = 0$; $\lambda_{12} = 0$; $\lambda_{13} = 0$ and $\lambda_{21} = \mu_{21}$. So we get that: $\dot{f}_1 \leq 0 \vee (\nu_2 - \mu_{21}) = 0$, and $\dot{f}_3 = \rho_{13} + \rho_{23} - 1 > 0$, which was the expected result.

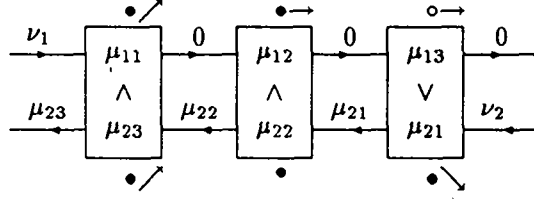

Figure 11 : Face $\{(1, 1), (1, 2), (2, 1), (2, 2), (2, 3)\}$.

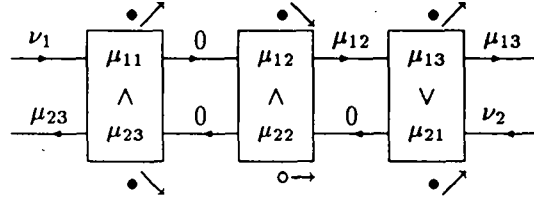

Figure 12 : Face $\{(1, 1), (1, 2), (1, 3), (2, 1), (2, 3)\}$.

Case $f_1 = 0, f_2 > 0$:

Now assume that $f_2 > 0$, which means that $\{(1, 2), (1, 3)\} \cap \Lambda \neq \emptyset$, and $\{(2, 2), (2, 3)\} \cap \Lambda \neq \emptyset$ (or $(2, 3) \in \Lambda$ as we already noticed). Then $\lambda_{23} = \mu_{23}$ and $\lambda_{11} = 0$, and

$$f_2 \leq (\lambda_{11} - \lambda_{13}) \vee (\lambda_{21} - \lambda_{23}) = (-\lambda_{13}) \vee (\lambda_{21} - \mu_{23}).$$

- If $(1, 3) \in \Lambda$, then $\lambda_{13} = \mu_{13}$ and $\lambda_{21} = 0$, and we get that:

$$f_2 \leq (-\mu_{13}) \vee (-\mu_{23}) < 0.$$

- Then assume that $(1, 3) \notin \Lambda$, $(1, 2) \in \Lambda$ and still $(2, 3) \in \Lambda$. If $f_1 = 0$, we cannot have $(2, 1) \in \Lambda$. Moreover, we must have $(2, 2) \in \Lambda$, otherwise $\{(1, 1), (1, 2), (1, 3), (2, 1), (2, 3)\}$ would be an outgoing face (see Figure 12). Then obviously $\Lambda = \{(1, 1), (1, 2), (2, 2), (2, 3)\}$ and: $\lambda_{21} = \nu_2$ and $\lambda_{13} = \lambda_{12} = 0$ (see Figure 13). In consequence:

$$f_2 \leq 0 \vee (\nu_2 - \mu_{23}) = 0,$$

but in any case we have $f_3 = \rho_{13} + \rho_{23} - 1 > 0$.

Thus we proved that on ergodic face where $f_1 = 0$ and $f_2 > 0$, we have $f_2 \leq -\epsilon_2$ for some positive constant ϵ_2 , or $f_2 = 0$ but $f_3 = \rho_{13} + \rho_{23} - 1 > 0$.

Case $f_1 = f_2 = 0, f_3 > 0$:

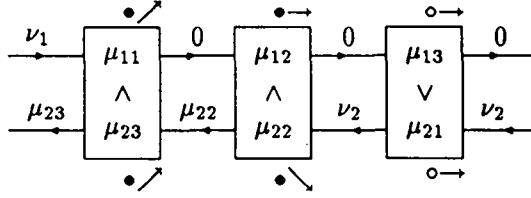

Figure 13 : Face $\{(1, 1), (1, 2), (2, 2), (2, 3)\}$.

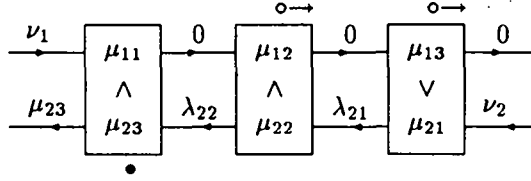

Figure 14 : $\Lambda \cap \{(1, 2), (1, 3)\} = \emptyset$ and $\Lambda \cap \{(2, 2), (2, 3)\} \neq \emptyset$.

At last, consider an ergodic face where $f_2 = 0$, that is :

$$\{(1, 2), (1, 3)\} \cap \Lambda = \emptyset, \quad \text{or:} \quad \{(2, 2), (2, 3)\} \cap \Lambda = \emptyset.$$

- If $\Lambda \cap \{(1, 2), (1, 3), (2, 2), (2, 3)\} = \emptyset$, then $\Lambda \subset \{(1, 1), (2, 1)\}$. If $(1, 1) \in \Lambda$ (resp. $(2, 1) \in \Lambda$), faces $\{(1, 1), (1, 2), (1, 3), (2, 1)\}$ or $\{(1, 1), (1, 3), (2, 1)\}$ (resp. faces $\{(2, 1), (2, 2), (2, 3), (1, 1)\}$ or $\{(2, 1), (2, 3), (1, 1)\}$) are outgoing faces of Λ according that $\mu_{11} > \mu_{12}$ or $\mu_{11} \leq \mu_{12}$ (resp. $\mu_{21} > \mu_{22}$ or $\mu_{21} \leq \mu_{22}$), as was proved in the previous section (see Figures 5, 6, 8 and 9).
- Then assume that either $\Lambda \cap \{(1, 2), (1, 3)\} = \emptyset$ and $\Lambda \cap \{(2, 2), (2, 3)\} \neq \emptyset$, or $\Lambda \cap \{(1, 2), (1, 3)\} \neq \emptyset$ and $\Lambda \cap \{(2, 2), (2, 3)\} = \emptyset$.
 - If $\Lambda \cap \{(1, 2), (1, 3)\} = \emptyset$ and $\Lambda \cap \{(2, 2), (2, 3)\} \neq \emptyset$, then we must have $(2, 3) \in \Lambda$ (see Figure 14). Since $(2, 3) \in \Lambda$, we have $\lambda_{23} = \mu_{23}$ and $\lambda_{13} = \lambda_{12} = \lambda_{11} = 0$, and consequently: $f_3 = \rho_{13} + \rho_{23} - 1 > 0$.
 - If on the contrary $\{(2, 2), (2, 3)\} \cap \Lambda = \emptyset$ and $\{(1, 2), (1, 3)\} \cap \Lambda \neq \emptyset$, then we must have $(1, 3) \in \Lambda$, because if $(1, 3) \notin \Lambda$ and $(1, 2) \in \Lambda$, faces $\{(1, 2), (1, 3), (2, 1)\}$ or $\{(1, 1), (1, 2), (1, 3), (2, 1)\}$ are outgoing faces of Λ (see Figure 15). In consequence, we have $\lambda_{13} = \mu_{13}$ and $\lambda_{23} = \lambda_{22} = \lambda_{21} = 0$, and $f_3 = \rho_{13} + \rho_{23} - 1 > 0$.

Thus we proved that on any ergodic face where $f_2 = 0$ and $f_3 > 0$, we have $f_3 = \rho_{13} + \rho_{23} - 1 > 0$. The proof is then complete. \square

The following proposition corresponds to second-type cycles.

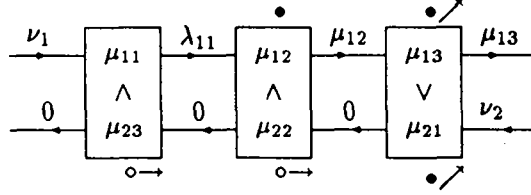

Figure 15 : $\Lambda \cap \{(2, 2), (2, 3)\} = \emptyset$ and $(1, 2) \in \Lambda$.

Proposition 6.3

If the following conditions are satisfied :

$$\rho_{22} < \rho_{23} \tag{12}$$

$$\rho_{13} + \rho_{23} > 1 \tag{6}$$

$$\rho_{12} \geq \rho_{13} \tag{8}$$

$$(\rho_{12} + \rho_{23} - 1)(1 - \rho_{13} - \rho_{21}) < (\rho_{13} + \rho_{23} - 1)(1 - \rho_{12} - \rho_{22}) \tag{9}$$

then the network is unstable (transient).

Proof :

We recall that the above conditions imply that $\mu_{11} > \mu_{13} \geq \mu_{12}$ and $\mu_{22} > \mu_{21} > \mu_{23}$.

The following functions will allow us to prove the transience of our network:

$$\begin{cases} f_1(Q) = Q(2, 2) \\ f_2(Q) = [Q(1, 2) + Q(1, 3)] \wedge [Q(2, 2) + Q(2, 3)] \\ f_3(Q) = \rho_{13} \frac{Q(2, 1) + Q(2, 2) + Q(2, 3)}{\mu_{23}} + (1 - \rho_{23} + \delta) \frac{Q(1, 1) + Q(1, 2) + Q(1, 3)}{\mu_{13}} \\ \sim \rho_{13} W(2, 3) + (1 - \rho_{23} + \delta) W(1, 3) \end{cases}$$

and:

$$f(Q) = -\beta(\alpha f_1(Q) + f_2(Q)) + f_3(Q),$$

where α and β are “sufficiently large”, positive constants, and δ is a “sufficiently small”, positive constant.

We could have checked that for sufficiently small, positive δ , there exists a constant $\epsilon_3 > 0$ such that $f_3 \geq \epsilon_3$ along the second-type cycles. Again functions f_1 and f_2 are arbitrary means to express the idea that the dynamical system eventually joins such a cycle. We have indeed $f_1 = f_2 = 0$ on any face of the cycle, and we will prove that:

- on any ergodic face where $f_1 > 0$, we have $\dot{f}_1 \leq -\epsilon_1$ for some constant $\epsilon_1 > 0$;
- on any ergodic face where $f_1 = 0$ and $f_2 > 0$, we have $\dot{f}_1 = 0$ (obviously) and $\dot{f}_2 \leq -\epsilon_2$ for some constant $\epsilon_2 > 0$;
- for sufficiently small δ , on any ergodic face where $f_1 = f_2 = 0$ and $f_3 > 0$, we have $\dot{f}_1 = \dot{f}_2 = 0$ (obvious) and $\dot{f}_3 \geq \epsilon_3 > 0$.

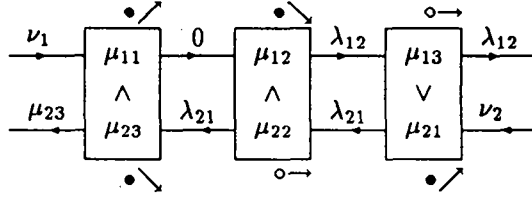

Figure 16 : Face $\{(1, 1), (1, 2), (2, 1), (2, 3)\}$.

It will then be obvious that for sufficiently large values of α and β , there exists a constant $\epsilon > 0$ such that on any ergodic face, we have $\dot{f} \geq \epsilon$.

Case $f_1 > 0$:

So consider a face Λ where $f_1 > 0$, that is $(2, 2) \in \Lambda$. Then we have:

$$\dot{f}_1 = \lambda_{21} - \lambda_{22} = \lambda_{21} - \mu_{22} \leq \mu_{21} - \mu_{22} < 0,$$

which was to be proved.

Case $f_1 = 0, f_2 > 0$:

Now assume that $f_2 > 0$ and $f_1 = 0$, that is $\Lambda \cap \{(1, 2), (1, 3)\} \neq \emptyset$, $(2, 2) \notin \Lambda$ and $(2, 3) \in \Lambda$. We have $\lambda_{23} = \mu_{23}$ and $\lambda_{11} = 0$ (and then $(1, 1) \in \Lambda$), and then

$$\dot{f}_2 \leq (\lambda_{11} - \lambda_{13}) \vee (\lambda_{21} - \lambda_{23}) = (-\lambda_{13}) \vee (\lambda_{21} - \mu_{23}).$$

- If $(1, 3) \in \Lambda$, then $\lambda_{13} = \mu_{13}$ and $\lambda_{21} = 0$, and thus:

$$\dot{f}_2 \leq (-\mu_{13}) \vee (-\mu_{23}) < 0.$$

- If $(1, 3) \notin \Lambda$, $(1, 2) \in \Lambda$, we must be on faces $\{(1, 1), (1, 2), (2, 3)\}$ or $\{(1, 1), (1, 2), (2, 1), (2, 3)\}$; but the analysis of path (1.3) in the previous section proves that the latter is an outgoing face of the former (see Figure 16) ; moreover, we have $\lambda_{21} < \nu_2$ and $\lambda_{13} = \lambda_{12} = \mu_{12}(1 - \frac{\lambda_{21}}{\mu_{22}}) > \nu_1$ (by condition (3)), and then:

$$\dot{f}_2 \leq (-\nu_1) \vee (\nu_2 - \mu_{23}) < 0.$$

Thus we proved that on any ergodic face where $f_2 > 0$ and $f_1 = 0$, we have $\dot{f}_2 \leq -\epsilon_2$ for some constant $\epsilon_2 > 0$.

Case $f_1 = f_2 = 0, f_3 > 0$:

At last consider an ergodic face Λ where $f_1 = 0$ and $f_2 = 0$, that is $(2, 2) \notin \Lambda$ and $\{(1, 2), (1, 3)\} \cap \Lambda = \emptyset$ or $(2, 3) \notin \Lambda$. We have:

$$\begin{aligned} \dot{f}_3 &= \rho_{13}\rho_{23}(1 - \frac{\lambda_{23}}{\nu_2}) + (1 - \rho_{23} + \delta)\rho_{13}(1 - \frac{\lambda_{13}}{\nu_1}) \\ &= \rho_{13}[(1 + \delta) - \rho_{23}\frac{\lambda_{23}}{\nu_2} - (1 - \rho_{23} + \delta)\frac{\lambda_{13}}{\nu_1}]. \end{aligned}$$

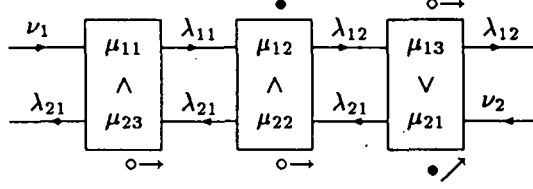

Figure 17 : Face $\{(1, 1), (1, 2), (2, 1)\}$ or $\{(1, 2), (2, 1)\}$.

- At first, consider the case when $\{(1, 2), (1, 3)\} \cap \Lambda = \emptyset$ (and then $\lambda_{13} = \lambda_{12} = \lambda_{11}$), and $(2, 3) \in \Lambda$. In consequence, $\lambda_{23} = \mu_{23}$ and $\lambda_{11} = 0$, and then $\lambda_{13} = 0$. So we get that:

$$f_3 = \rho_{13}[(1 + \delta) - 1 - 0] = \rho_{13}\delta > 0.$$

- Now suppose that $\{(1, 2), (1, 3)\} \cap \Lambda \neq \emptyset$ and $\{(2, 2), (2, 3)\} \cap \Lambda = \emptyset$ (and then $\lambda_{23} = \lambda_{22} = \lambda_{21}$).
 - If $(1, 3) \in \Lambda$, we get that: $\lambda_{13} = \mu_{13}$, $\lambda_{21} = 0$, and then $\lambda_{23} = 0$. In consequence:

$$f_3 = \rho_{13}[(1 + \delta) - 0 - \frac{1 - \rho_{23} + \delta}{\rho_{13}}] = (\rho_{13} + \rho_{23} - 1) - \delta(1 - \rho_{13}),$$

which is positive for sufficiently small values of δ .

- If $(1, 3) \notin \Lambda$, then $(1, 2) \in \Lambda$, and even $(2, 1) \in \Lambda$ because otherwise faces $\{(1, 1), (1, 2), (2, 1)\}$ or $\{(1, 2), (2, 1)\}$ would be outgoing faces of the current face (see the analysis of path (1.3)). So Λ is one of these two faces (see Figure 17).

We already got (see the proof of Proposition 5.2):

$$\begin{cases} \lambda_{12} = \frac{\rho_{21} - \rho_{22}}{\rho_{12}\rho_{21} - \rho_{13}\rho_{22}} \nu_1 \\ \lambda_{21} = \frac{\rho_{12} - \rho_{13}}{\rho_{12}\rho_{21} - \rho_{13}\rho_{22}} \nu_2 \end{cases}$$

In consequence :

$$\begin{aligned} f_3 > 0 &\Leftrightarrow (1 + \delta) - \rho_{23} \frac{\rho_{12} - \rho_{13}}{\rho_{12}\rho_{21} - \rho_{13}\rho_{22}} - (1 - \rho_{23} + \delta) \frac{\rho_{21} - \rho_{22}}{\rho_{12}\rho_{21} - \rho_{13}\rho_{22}} > 0 \\ &\Leftrightarrow (1 + \delta)(\rho_{12}\rho_{21} - \rho_{13}\rho_{22}) > \rho_{23}(\rho_{12} - \rho_{13}) + (1 - \rho_{23} + \delta)(\rho_{21} - \rho_{22}) \\ &\Leftrightarrow (\rho_{12} + \rho_{23} - 1)(1 - \rho_{13} - \rho_{21}) < (\rho_{13} + \rho_{23} - 1)(1 - \rho_{12} - \rho_{22}) \\ &\quad - \delta[\rho_{21}(1 - \rho_{12}) - \rho_{22}(1 - \rho_{13})] \end{aligned}$$

which is valid under condition (9) for sufficiently small values of δ .

- At last assume that $\Lambda \cap \{(1, 2), (1, 3), (2, 2), (2, 3)\} = \emptyset$. Then either $\{(1, 1), (2, 1), (2, 3)\}$ or $\{(1, 1), (1, 2), (2, 1)\}$ is an outgoing face of Λ (see Figure 18) in view of the analysis of second-type cycles, and then Λ is transient.

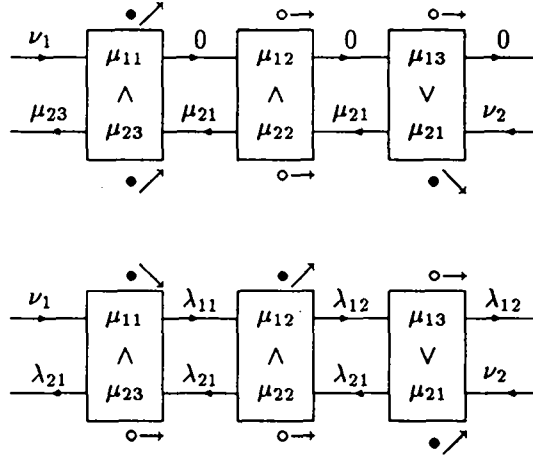

Figure 18 : Faces $\{(1, 1), (2, 1), (2, 3)\}$ and $\{(1, 1), (1, 2), (2, 1)\}$.

Remark 6.4

For $\Lambda = \{(1, 1)\}$, there may be an admissible drift v with $v_{11} < 0$ (and of course $v_{i,s} = 0$ if $(i, s) \neq (1, 1)$), and then $f_3 < 0$ on the path of drift v . It is then crucial to make the remark about the non-ergodicity of Λ .

So we proved that for some constant $\epsilon_3 > 0$, we have $f_3 \geq \epsilon_3 > 0$ on any ergodic face where $f_1 = f_2 = 0$.

The proof is now complete. □

Thus we proved that the network is unstable if $F_1(\rho) \leq 0$ and $F_3(\rho) > 0$. Since we already knew that it was unstable if $F_1(\rho) > 0$, we actually proved that $F(\rho) > 0$ implies the transience of the model. The next section is devoted to the proof that the network is stable when $F(\rho) < 0$.

7 Stability conditions.

We will assume that the following, necessary conditions of stability are satisfied (see Section 2):

Usual conditions :

$$\rho_{11} + \rho_{23} < 1 \tag{13}$$

$$\rho_{12} + \rho_{22} < 1 \tag{14}$$

$$\rho_{13} + \rho_{21} < 1 \tag{15}$$

Additional condition. :

$$\rho_{13} + \rho_{22} < 1. \tag{16}$$

At first, we will prove a technical lemma that will be useful for our calculations.

Lemma 7.1

Assume that x_0 and y_0 are some non-negative solutions of the system:

$$\begin{cases} r_{11}x + r_{22}y = 1 \\ r_{21}y + r_{12}x = 1 \end{cases}$$

where the constants r_{ij} satisfy:

$$\begin{cases} r_{11} + r_{22} < 1 \\ r_{12} + r_{21} < 1 \\ r_{12} + r_{22} < 1 \end{cases}$$

Then we have:

$$r_{12}(1 - x_0) + r_{22}(1 - y_0) < 0.$$

Proof :

If $r_{11}r_{21} - r_{12}r_{22} = 0$, then the two equations must be equivalent, and then $r_{11} = r_{12}$ and $r_{21} = r_{22}$. In consequence:

$$\begin{aligned} r_{12}x + r_{22}y &= 1, \quad \text{and then:} \\ r_{12}(1 - x_0) + r_{22}(1 - y_0) &= r_{12} + r_{22} - 1 < 0. \end{aligned}$$

If $r_{11}r_{21} - r_{12}r_{22} \neq 0$, the system has a single solution:

$$\begin{cases} x = \frac{r_{21} - r_{22}}{r_{11}r_{21} - r_{12}r_{22}} \\ y = \frac{r_{11} - r_{12}}{r_{11}r_{21} - r_{12}r_{22}} \end{cases}$$

Let $\epsilon = 1$ if $r_{11}r_{21} - r_{12}r_{22} > 0$, $\epsilon = -1$ if $r_{11}r_{21} - r_{12}r_{22} < 0$. Since $x \geq 0$ and $y \geq 0$, we must have $\epsilon(r_{11} - r_{12}) \geq 0$ and $\epsilon(r_{21} - r_{22}) \geq 0$, and:

$$\epsilon(r_{11} - r_{12}) + \epsilon(r_{21} - r_{22}) > 0.$$

In consequence:

$$\begin{aligned} r_{12}(1 - x_0) + r_{22}(1 - y_0) &< 0 \\ \Leftrightarrow r_{12} + r_{22} - \frac{r_{21} - r_{22}}{r_{11}r_{21} - r_{12}r_{22}}r_{12} - \frac{r_{11} - r_{12}}{r_{11}r_{21} - r_{12}r_{22}}r_{22} &< 0 \\ \Leftrightarrow \epsilon(r_{21} - r_{22})r_{12} + \epsilon(r_{11} - r_{12})r_{22} - \epsilon(r_{12} + r_{22})(r_{11}r_{21} - r_{12}r_{22}) &> 0 \\ \Leftrightarrow \epsilon(r_{21} - r_{22})r_{12}(1 - r_{22} - r_{11}) + \epsilon(r_{11} - r_{12})r_{22}(1 - r_{12} - r_{21}) &> 0 \end{aligned}$$

which is valid under the assumptions of the lemma. □

We will now explore the stability domain, which will be divided into three different parts. The following proposition deals with the first part.

Proposition 7.2

If the following conditions are satisfied:

$$\rho_{22} < \rho_{23} \tag{12}$$

$$\rho_{13} + \rho_{23} \geq 1 \tag{17}$$

$$\rho_{12} > \rho_{13} \tag{18}$$

$$(\rho_{12} + \rho_{23} - 1)(1 - \rho_{13} - \rho_{21}) > (\rho_{13} + \rho_{23} - 1)(1 - \rho_{12} - \rho_{22}) \tag{19}$$

then the network is stable (ergodic).

Proof :

Notice that conditions (15) and (17) on one hand, condition (12) on the other hand, imply that

$$\mu_{21} \wedge \mu_{22} > \mu_{23}.$$

We define:

$$\begin{cases} f_1(Q) = Q(1, 3) \\ f_2(Q) = \rho_{13} \frac{Q(2, 1) + Q(2, 2) + Q(2, 3)}{\mu_{23}} + (1 - \rho_{23} - \delta) \frac{Q(1, 1) + Q(1, 2) + Q(1, 3)}{\mu_{13}} \\ \sim \rho_{13} W(2, 3) + (1 - \rho_{23} - \delta) W(1, 3) \end{cases}$$

and:

$$f(Q) = \alpha f_1(Q) + f_2(Q),$$

for some positive constants α and δ , δ "sufficiently small" (in particular $\delta < 1 - \rho_{23}$) and α "sufficiently large".

Case $f_1 > 0$:

Condition (18) ensures that if $f_1 > 0$ (or: $(1, 3) \in \Lambda$), then

$$\dot{f}_1 = \lambda_{12} - \mu_{13} \leq \mu_{12} - \mu_{13} < 0,$$

and so for sufficiently large α , $\dot{f} < 0$ if $f_1 > 0$.

Case $f_1 = 0, f_2 > 0$:

Consider now an ergodic face Λ where $f_1 = 0$ (or: $(1, 3) \notin \Lambda$) and $f_2 > 0$. We have:

$$\begin{aligned} \dot{f} = \dot{f}_2 &= \rho_{13} \rho_{23} \left(1 - \frac{\lambda_{23}}{\nu_2}\right) + (1 - \rho_{23} - \delta) \rho_{13} \left(1 - \frac{\lambda_{12}}{\nu_1}\right) \\ &= \rho_{13} \left[(1 - \delta) - \frac{\lambda_{23}}{\mu_{23}} - (1 - \rho_{23} - \delta) \frac{\lambda_{12}}{\nu_1} \right]. \end{aligned}$$

- If $(2, 3) \in \Lambda$, then $\lambda_{23} = \mu_{23}$ and $\dot{f} \leq -\rho_{13} \delta < 0$.
- If $(2, 3) \notin \Lambda$, then $(2, 2) \notin \Lambda$ since $\mu_{22} > \mu_{23}$ (condition (12)); in consequence, we have $\Lambda \cap \{(1, 3), (2, 2), (2, 3)\} = \emptyset$ and

$$\dot{f} = \rho_{13} \left[(1 - \delta) - \frac{\lambda_{21}}{\mu_{23}} - (1 - \rho_{23} - \delta) \frac{\lambda_{12}}{\nu_1} \right]$$

(see Figure 19).

- If $(2, 1) \notin \Lambda$, then

$$\lambda_{21} = \lambda_{20} = \nu_2, \quad \dot{f} = \rho_{13} (1 - \rho_{23} - \delta) \left(1 - \frac{\lambda_{12}}{\nu_1}\right),$$

and $\Lambda \subset \{(1, 1), (1, 2)\}$. But either $(1, 2) \in \Lambda$ and $\lambda_{12} = \mu_{12} (1 - \rho_{22}) > \nu_1$ (by condition (14)), or $\Lambda = \{(1, 1)\}$ and $\lambda_{12} = \lambda_{11} = \mu_{11} (1 - \rho_{23}) > \nu_1$ (by condition (13)), and in both cases $\dot{f} < 0$.

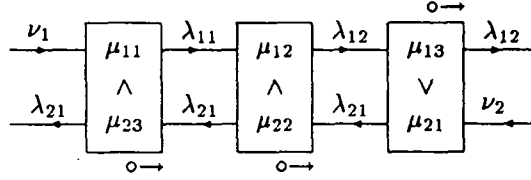

Figure 19 : $\Lambda \cap \{(1, 3), (2, 2), (2, 3)\} = \emptyset$.

- If $(2, 1) \in \Lambda$ and $(1, 2) \notin \Lambda$, Λ is not ergodic: since $\mu_{21} \wedge \mu_{22} > \mu_{23}$, it admits face $\{(2, 1), (2, 2), (2, 3), (1, 1)\}$ or face $\{(2, 1), (2, 3), (1, 1)\}$ as an outgoing face according that $\mu_{21} \geq \mu_{22}$ or $\mu_{21} \leq \mu_{22}$ (see the analysis of paths (2.1) and (2.2) in section 5).
- Then assume that $(2, 1) \in \Lambda$ and $(1, 2) \in \Lambda$. If $\mu_{21} > \mu_{22}$, then again Λ is not ergodic (this time it admits $\{(1, 1), (1, 2), (2, 1), (2, 2), (2, 3)\}$ as an outgoing face, see Figure 11), and thus we proved that $f < 0$ on all the ergodic faces.

If $(2, 1) \in \Lambda$, $(1, 2) \in \Lambda$, and $\mu_{21} \leq \mu_{22}$, we know that:

$$\begin{cases} \lambda_{12} = \frac{\rho_{21} - \rho_{22}}{\rho_{12}\rho_{21} - \rho_{13}\rho_{22}} \nu_1 \\ \lambda_{21} = \frac{\rho_{12} - \rho_{13}}{\rho_{12}\rho_{21} - \rho_{13}\rho_{22}} \nu_2 \end{cases}$$

In consequence, we get that:

$$f < 0 \Leftrightarrow (\rho_{12} + \rho_{23} - 1)(1 - \rho_{13} - \rho_{21}) > (\rho_{13} + \rho_{23} - 1)(1 - \rho_{12} - \rho_{22}) + \delta[\rho_{21}(1 - \rho_{12}) - \rho_{22}(1 - \rho_{13})]$$

(we already made the calculation in the proof of Proposition 6.3), which is valid under condition (19) for sufficiently small values of δ .

Thus we proved that $f < 0$ on all the ergodic faces: since f is obviously Lipschitz, Theorem 3.3 allows us to conclude that the network is ergodic. \square

Let us now explore the second part of the stability domain.

Proposition 7.3

If the following conditions are satisfied:

$$\rho_{22} < \rho_{23} \tag{12}$$

$$\rho_{13} + \rho_{23} < 1 \tag{13}$$

then the network is stable (ergodic).

Proof :

Notice that condition (13) is stronger than condition (16) under condition (12).

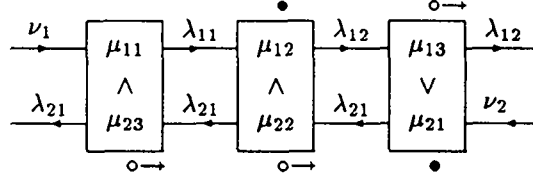

Figure 20 : $\Lambda = \{(1, 1), (1, 2), (2, 1)\}$ or $\Lambda = \{(1, 2), (2, 1)\}$.

We set:

$$f(Q) = \frac{Q(1, 1) + Q(1, 2) + Q(1, 3)}{\mu_{13}} + \frac{Q(2, 1) + Q(2, 2) + Q(2, 3)}{\mu_{23}} \sim W(1, 3) + W(2, 3).$$

The arguments to prove that $\dot{f} < 0$ everywhere are the same as those already encountered. Notice that :

$$\dot{f} = \rho_{13}\left(1 - \frac{\lambda_{13}}{\nu_1}\right) + \rho_{23}\left(1 - \frac{\lambda_{23}}{\nu_2}\right).$$

- If $(1, 3) \in \Lambda$ or $(2, 3) \in \Lambda$, then $\lambda_{13} = \mu_{13}$ or $\lambda_{23} = \mu_{23}$ and:

$$\dot{f} \leq \rho_{13} + \rho_{23} - 1 < 0.$$

- We now assume that $(1, 3) \notin \Lambda$ and $(2, 3) \notin \Lambda$, and then again $(2, 2) \notin \Lambda$ in view of condition (12) (otherwise there is no admissible flow); see Figure 19 to visualize these characteristics.

- If $(1, 2) \notin \Lambda$, then $\Lambda \subset \{(1, 1), (2, 1)\}$, and :

$$\dot{f} = \rho_{13}\left(1 - \frac{\lambda_{11}}{\nu_1}\right) + \rho_{23}\left(1 - \frac{\lambda_{21}}{\nu_2}\right).$$

If $\Lambda = \{(1, 1), (2, 1)\}$, we may apply the result of Lemma 7.1 with $x_0 = \lambda_{11}/\nu_1$, $y_0 = \lambda_{21}/\nu_2$, $r_{11} = \rho_{11}$, $r_{12} = \rho_{13}$, $r_{21} = \rho_{21}$, and $r_{22} = \rho_{23}$; the hypothesis of this lemma are indeed satisfied in view of Lemma 4.1, condition (13), and the usual conditions (13) and (14). In consequence, we get that $\dot{f} < 0$. If $\Lambda = \{(1, 1)\}$ or $\Lambda = \{(2, 1)\}$, the result is even more immediate in view of the usual conditions.

- So we assume that $(1, 2) \in \Lambda$.

- * If $(2, 1) \notin \Lambda$, then

$$\lambda_{23} = \lambda_{22} = \lambda_{21} = \nu_2 \quad \text{and: } \lambda_{13} = \lambda_{12} = \mu_{12}\left(1 - \frac{\nu_2}{\mu_{22}}\right) > \nu_1 \quad (\text{by (14)}),$$

which means that $\dot{f} < 0$.

- * At last, assume that $(2, 1) \in \Lambda$ (see Figure 20), which means that $\Lambda = \{(1, 1), (1, 2), (2, 1)\}$ or $\Lambda = \{(1, 2), (2, 1)\}$.

This time, $x_0 = \lambda_{12}/\nu_1$ and $y_0 = \lambda_{21}/\nu_2$ must be non-negative solutions of the following system:

$$\begin{cases} \rho_{12}x + \rho_{22}y = 1 \\ \rho_{13}x + \rho_{21}y = 1 \end{cases}$$

If $\rho_{12}\rho_{21} - \rho_{22}\rho_{13} = 0$, the two equations must be equivalent and then: $\rho_{12} = \rho_{13}$ and $\rho_{21} = \rho_{22}$, and:

$$\rho_{13}\frac{\lambda_{12}}{\nu_1} + \rho_{23}\frac{\lambda_{21}}{\nu_2} \stackrel{\text{by(12)}}{\geq} \rho_{13}\frac{\lambda_{12}}{\nu_1} + \rho_{22}\frac{\lambda_{21}}{\nu_2} = 1,$$

which implies that:

$$\dot{f} \leq \rho_{13} + \rho_{23} - 1 < 0 \quad \text{by (13)}.$$

Now assume that $\rho_{12}\rho_{21} - \rho_{22}\rho_{13} \neq 0$. Let $\epsilon = 1$ if $\rho_{12}\rho_{21} - \rho_{13}\rho_{22} > 0$, $\epsilon = -1$ if $\rho_{12}\rho_{21} - \rho_{13}\rho_{22} < 0$. In view of the above equations, we have $\epsilon(\rho_{12} - \rho_{13}) \geq 0$ and $\epsilon(\rho_{21} - \rho_{22}) \geq 0$. Moreover, by solving the above system (see the proof of Lemma 7.1), we get:

$$\dot{f} = \rho_{13} + \rho_{23} - \frac{\rho_{21} - \rho_{22}}{\rho_{12}\rho_{21} - \rho_{13}\rho_{22}}\rho_{13} - \frac{\rho_{12} - \rho_{13}}{\rho_{12}\rho_{21} - \rho_{13}\rho_{22}}\rho_{23},$$

which may be considered as a linear function of ρ_{23} . By (12) and (13), we have $\rho_{23} \in]\rho_{22}, 1 - \rho_{13}[$. But for $\rho_{23} = \rho_{22}$, we get $\dot{f} < 0$ as a direct consequence of lemma 7.1, since $\rho_{13} + \rho_{22} < 1$ (condition (16)). So we just have to prove that $\dot{f} \leq 0$ for $\rho_{23} = 1 - \rho_{13}$. This amounts to:

$$\begin{aligned} \dot{f} \leq 0 &\iff \rho_{13} + (1 - \rho_{13}) - \frac{\rho_{21} - \rho_{22}}{\rho_{12}\rho_{21} - \rho_{13}\rho_{22}}\rho_{13} - \frac{\rho_{12} - \rho_{13}}{\rho_{12}\rho_{21} - \rho_{13}\rho_{22}}(1 - \rho_{13}) \leq 0 \\ &\iff \epsilon(\rho_{21} - \rho_{22})\rho_{13} + \epsilon(\rho_{12} - \rho_{13})(1 - \rho_{13}) - \epsilon(\rho_{12}\rho_{21} - \rho_{13}\rho_{22}) \geq 0 \\ &\iff \epsilon(\rho_{12} - \rho_{13})(1 - \rho_{13} - \rho_{21}) \geq 0, \end{aligned}$$

which is valid under the usual condition (15).

All the conditions of Theorem 3.3 have thus been checked, and in consequence we may conclude that the network is stable. \square

The third and last part of the stability domain is presented in the following proposition.

Proposition 7.4

If the following condition is satisfied:

$$\rho_{22} \geq \rho_{23} \tag{14}$$

then the network is stable (ergodic).

Proof :

Consider the following functions :

$$\begin{cases} f_1(Q) = Q(2, 3), \\ f_2(Q) = \frac{Q(1, 1) + Q(1, 2) + Q(1, 3)}{\mu_{13}} + \frac{Q(2, 1) + Q(2, 2)}{\mu_{22}} \sim W(1, 3) + W(2, 2), \end{cases}$$

and:

$$f(Q) = \alpha f_1(Q) + f_2(Q) \quad \text{for some positive constant } \alpha.$$

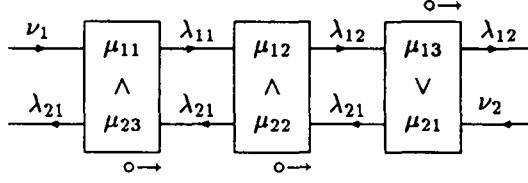

Figure 21 : $\Lambda \cap \{(2, 3), (1, 3), (2, 2)\} = \emptyset$.

Case $f_1 > 0$:

Consider an ergodic face Λ where $f_1(Q) = Q(2, 3) > 0$ (that is $(2, 3) \in \Lambda$). Then, in view of Lemma 4.1:

$$\dot{f}_1 = \lambda_{22} - \mu_{23} \leq \mu_{22} - \mu_{23} \leq 0,$$

and $\dot{f}_1 = 0$ iff $\lambda_{22} = \mu_{22} = \mu_{23}$, which implies that:

$$\dot{f}_2 = \rho_{13} + \rho_{22} - \frac{\lambda_{13}}{\mu_{13}} - \frac{\lambda_{22}}{\mu_{22}} \leq \rho_{13} + \rho_{22} - 1 < 0.$$

Thus if $f_1 > 0$ we have $\dot{f} < 0$ for any sufficiently large α .

Case $f_1 = 0, f_2 > 0$:

Now we just have to prove that $\dot{f}_2 < 0$ on any (ergodic) face Λ such that $f_2 > 0$, or $(2, 3) \notin \Lambda$.

- If $(1, 3) \in \Lambda$ (resp. $(2, 2) \in \Lambda$), then $\lambda_{13} = \mu_{13}$ (resp. $\lambda_{22} = \mu_{22}$), and :

$$\dot{f}_2 \leq \rho_{13} + \rho_{22} - 1 < 0.$$

- So assume that $\{(1, 3), (2, 2), (2, 3)\} \cap \Lambda = \emptyset$ (see Figure 21).

We have now :

$$\dot{f}_2 = \rho_{13} \left(1 - \frac{\lambda_{12}}{\nu_1}\right) + \rho_{22} \left(1 - \frac{\lambda_{21}}{\nu_2}\right).$$

- If $(2, 1) \notin \Lambda$, then $\lambda_{21} = \nu_2$ and we already checked that in this situation $\lambda_{12} > \nu_1$ due to the usual conditions; in consequence: $\dot{f}_2 < 0$.
- If $(2, 1) \in \Lambda$ and $\Lambda \cap \{(1, 1), (1, 2)\} = \emptyset$, then $\lambda_{12} = \lambda_{11} = \nu_1$ and $\lambda_{21} > \nu_2$ by the same argument, and so $\dot{f}_2 < 0$.
- Now assume that $(2, 1) \in \Lambda$ and $(1, 2) \in \Lambda$. This time we may apply Lemma 7.1 with $x_0 = \lambda_{12}/\nu_1$, $y_0 = \lambda_{21}/\nu_2$, $r_{11} = \rho_{12}$, $r_{12} = \rho_{12}$, $r_{13} = \rho_{13}$, $r_{21} = \rho_{21}$ and $r_{22} = \rho_{22}$, which directly yields that $\dot{f}_2 < 0$.

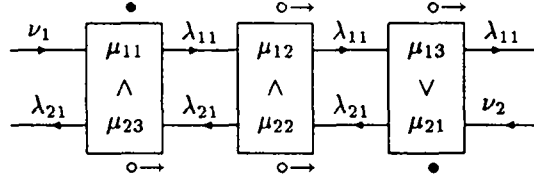

Figure 22 : $\Lambda = \{(1, 1), (2, 1)\}$.

– So only one case remains, which is $\Lambda = \{(1, 1), (2, 1)\}$ (see Figure 22). We set $x_0 = \lambda_{11}/\nu_1$, $y_0 = \lambda_{21}/\nu_2$. In view of Lemma 4.1, x_0 and y_0 are non-negative solutions of the following system:

$$\begin{cases} \rho_{11}x_0 + \rho_{23}y_0 = 1 \\ \rho_{13}x_0 + \rho_{21}y_0 = 1 \end{cases}$$

If $\rho_{11}\rho_{21} - \rho_{13}\rho_{23} = 0$, then the two equations must be equivalent, which implies that $\rho_{11} = \rho_{13}$ and $\rho_{21} = \rho_{23}$. In consequence:

$$\rho_{13}x_0 + \rho_{22}y_0 \stackrel{\text{by (14)}}{\geq} \rho_{13}x_0 + \rho_{23}y_0 = 1, \quad \text{and then:}$$

$$\dot{f}_2 \leq \rho_{13} + \rho_{22} - 1 < 0.$$

If $\rho_{11}\rho_{21} - \rho_{13}\rho_{23} \neq 0$, let $\epsilon = 1$ if $\rho_{11}\rho_{21} - \rho_{13}\rho_{23} > 0$, $\epsilon = -1$ if $\rho_{11}\rho_{21} - \rho_{13}\rho_{23} < 0$. In view of the above equations, we have $\epsilon(\rho_{11} - \rho_{13}) \geq 0$ and $\epsilon(\rho_{21} - \rho_{23}) \geq 0$. Moreover, by solving the system we get:

$$\dot{f}_2 = \rho_{13} + \rho_{22} - \frac{\rho_{21} - \rho_{23}}{\rho_{11}\rho_{21} - \rho_{13}\rho_{23}}\rho_{13} - \frac{\rho_{11} - \rho_{13}}{\rho_{11}\rho_{21} - \rho_{13}\rho_{23}}\rho_{22},$$

which may be considered as a linear function of ρ_{22} . By (14) and (16), we have $\rho_{22} \in [\rho_{23}, 1 - \rho_{13}]$. But for $\rho_{22} = \rho_{23}$, $\dot{f}_2 < 0$ in view of Lemma 7.1 (since $\rho_{13} + \rho_{23} \leq \rho_{13} + \rho_{22} < 1$). So we just have to prove that $\dot{f}_2 \leq 0$ for $\rho_{22} = 1 - \rho_{13}$.

In this case, we get that:

$$\begin{aligned} \dot{f}_2 \leq 0 &\iff \rho_{13} + (1 - \rho_{13}) - \frac{\rho_{21} - \rho_{23}}{\rho_{11}\rho_{21} - \rho_{13}\rho_{23}}\rho_{13} - \frac{\rho_{11} - \rho_{13}}{\rho_{11}\rho_{21} - \rho_{13}\rho_{23}}(1 - \rho_{13}) \leq 0 \\ &\iff \epsilon(\rho_{21} - \rho_{23})\rho_{13} + \epsilon(\rho_{11} - \rho_{13})(1 - \rho_{13}) - \epsilon(\rho_{11}\rho_{21} - \rho_{13}\rho_{23}) \geq 0 \\ &\iff \epsilon(\rho_{11} - \rho_{13})(1 - \rho_{13} - \rho_{21}) \geq 0, \end{aligned}$$

which is valid under the usual condition (15).

Thus we proved that there exists a positive constant ϵ such that on any ergodic face, $\dot{f} \leq -\epsilon < 0$. The network is then stable (by Theorem 3.3). \square

8 Three-dimensional projection of the stability domain.

In order to visualize the stability domain, let us consider its projection on the following, three-dimensional subspace of \mathbb{R}^6 :

$$\rho_{11} = \rho_{22}, \quad \rho_{12} = \rho_{23}, \quad \rho_{13} = \rho_{21}.$$

The three variables above will be denoted respectively x , y and z . Then the usual conditions and the additional one write:

$$x + y < 1, \quad x + z < 1, \quad z < \frac{1}{2},$$

which delimits a simplex in \mathbb{R}_+^3 . We let the reader check that the projection of the stability domain is this simplex amputated of the following part:

$$\begin{cases} x < \frac{1}{2}, & \frac{1}{2} < y < 1 - x, & 1 - y < z < \frac{1}{2} \\ (2y - 1)(1 - 2z) \leq (y + z - 1)(1 - x - y) \end{cases}$$

It is more convenient to make the following change of variables:

$$X = x - \frac{1}{2}, \quad Y = y - \frac{1}{2}, \quad Z = z - \frac{1}{2}.$$

Then the simplex becomes:

$$X + Y < 0, \quad X + Z < 0, \quad Z < 0$$

(with the implicit constraint: $(X, Y, Z) \geq (-1/2, -1/2, -1/2)$), and it is amputated of :

$$\begin{cases} X < 0, & 0 < Y < -X, & -Y < Z < 0 \\ 4YZ \geq (Y + Z)(X + Y) \end{cases}$$

In this form we see that the stability domain is the intersection of a cone of vertex $(0, 0, 0)$ with the cone $(X, Y, Z) \geq (-1/2, -1/2, -1/2)$, or (in terms of (x, y, z)) the intersection of a cone of vertex $(1/2, 1/2, 1/2)$ with the orthant $(x, y, z) \geq (0, 0, 0)$ (see Figure 23 to have a global view of the stability domain).

The form of the cut at $x = 0$ of the stability domain is then representative of the cuts at $x = x_0$ for $x_0 \in [0, 1/2]$. It is the zone delimited by full lines in Figure 24. There it is obvious that the previously announced properties are true:

- the quadratic condition is meaningful;
- the stability domain is not convex;
- we can choose (y_0, z_0) in the stability domain so close of the upper-right corner (which is $(1, 1/2)$ in the cut $x = 0$) that almost all the instability points (y, z) with $z < 1/2$ satisfy: $(y, z) < (y_0, z_0)$.

9 Conclusion.

By a repeated use of the potential loads, we gave simple proofs of the usual conditions and the additional condition of stability, and then we formed simple Lyapunov functions that satisfied the criteria of Malyshv and Menshikov. We took care of determining connected stability and instability domains, and only the frontier between these two domains was not explored. For the moment, there is no practical tool to

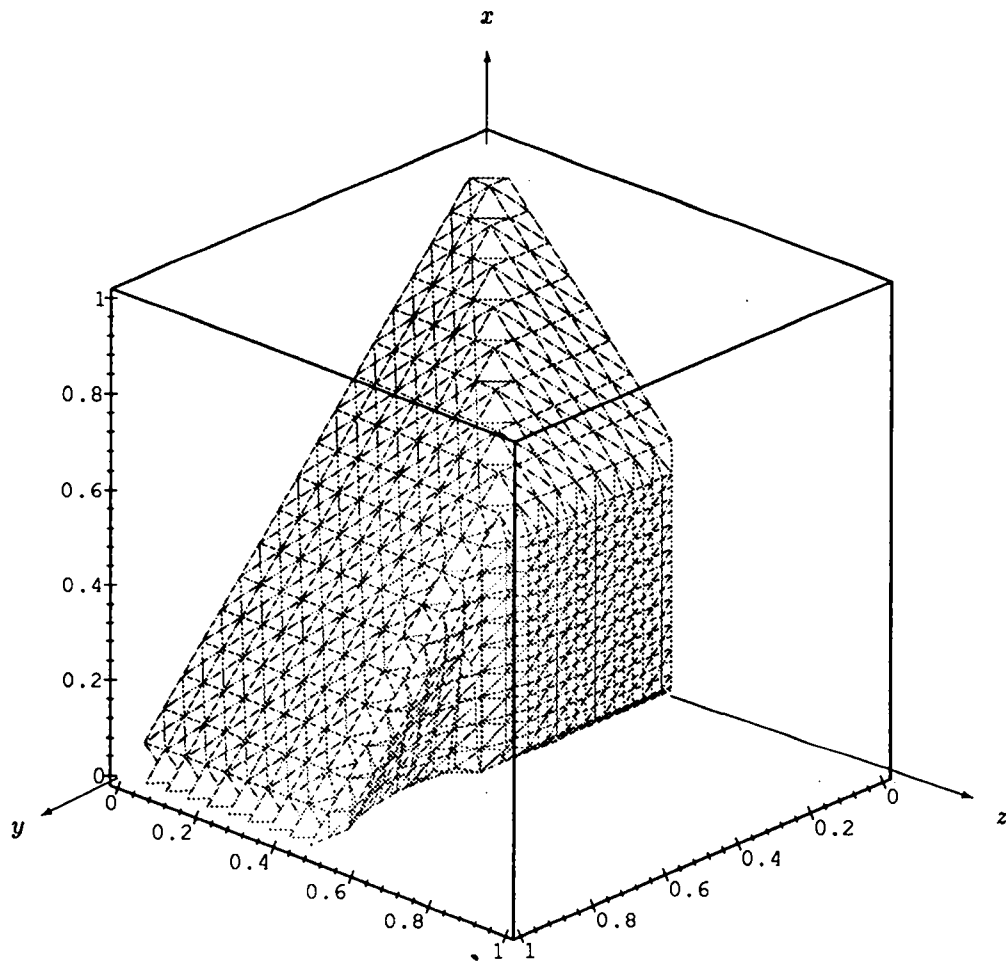

Figure 23 : Three-dimensional projection of the stability domain.

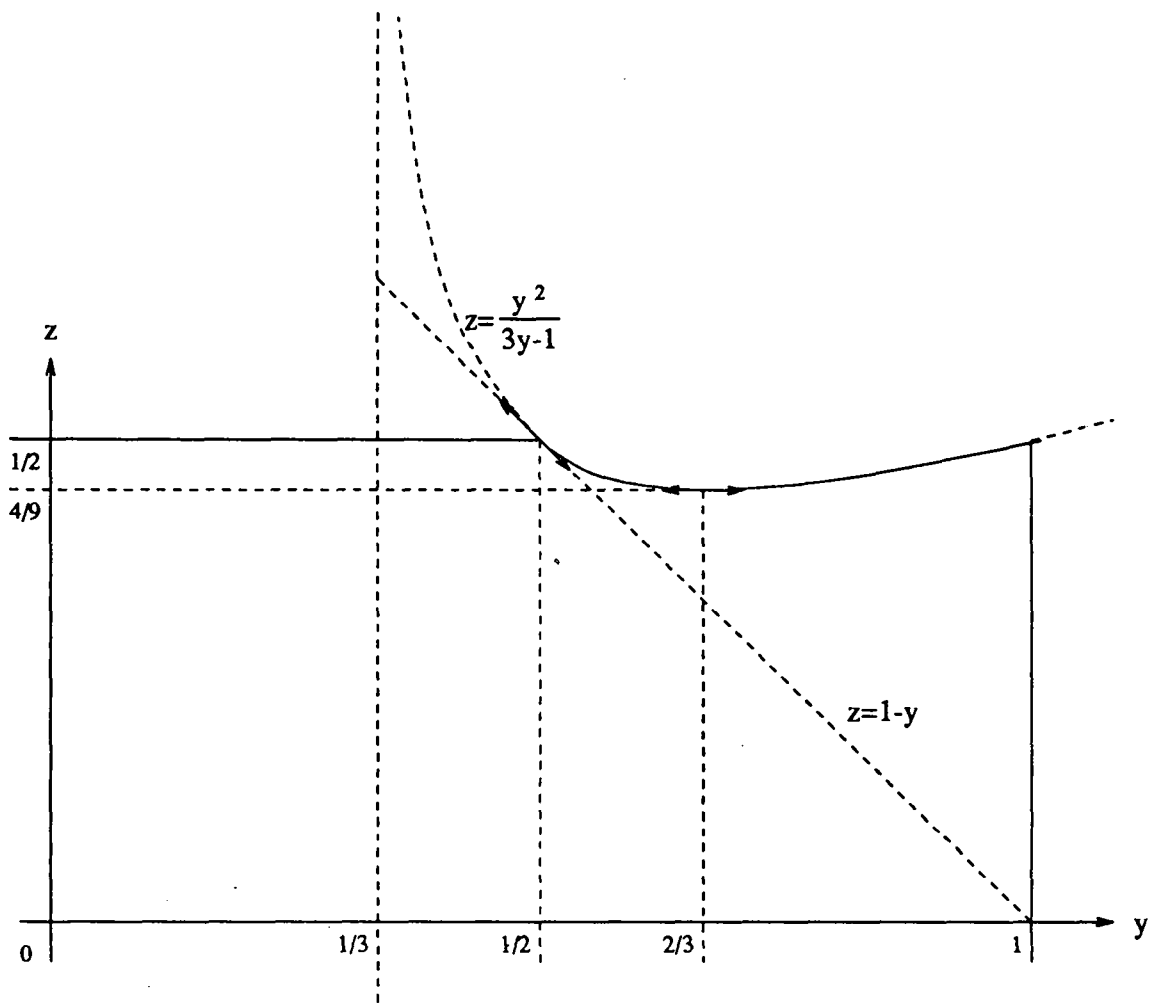

Figure 24 : Cut of the three-dimensional stability domain at $x = 0$.

determine which part of the frontier corresponds to a zone of ergodicity, null recurrence or transience of the model.

We made simulations of our network for traffic intensities around the quadratic part of the frontier. On the unstable side, it seems that the model asymptotically follows the corresponding, diverging path of the dynamical system with probability one ; on the stable side, the queue lengths keep "bounded" as expected.

We emphasize the original form of the stability domain: to the best of our knowledge, the few models whose stability was completely analyzed (regardless those which are stable under the usual conditions) exhibited linear, convex and monotonic conditions on ρ (the vector of traffic intensities). Very little is known about general properties of the stability domain. In fact, it is not even obvious that the conditions of stability could always be expressed only in terms of the traffic intensities, and not in terms of all the primitive parameters ν_i and μ_i . However, trivially sufficient conditions of stability (for example the sum of all the traffic intensities being smaller than one) show that any network is stable when ρ is sufficiently close to zero. In [2], Chen proved a monotone property for the stability of *fluid* networks, but stability was defined with respect to *all* the work-conserving discipline. At least, a plausible conjecture would be that for any given discipline, the monotonic property is true along half-lines starting from $\rho = 0$ (which is easy to check for our model). It would imply that the domains of stability or instability are connected subsets of $\mathbb{R}_+^{|\mathcal{C}|}$.

At last, notice that one of the mains reasons why our model was tractable is that each zone of instability corresponds to a unique way to go to infinity (from any initial state, the dynamical system eventually joins the same type of diverging path), but it would have been much more difficult to apply the criterion of transience if there had been several modes of instability with separate attraction sets. This enlightens the need for a "local" criterion of transience in terms of a "locally attractive" or (in terms of dynamical systems) a "stable" diverging path.

References

- [1] BOTVITCH, D., AND ZAMYATIN, A. Ergodicity of conservative communication networks. Rapport de recherche 1772, INRIA, Domaine de Voluceau, Rocquencourt B.P. 105 78153 Le Chesnay Cedex France, October 1992.
- [2] CHEN, H. Fluid approximations and stability of multiclass queueing networks I: work-conserving disciplines. Preprint, 1993.
- [3] DAI, J. On the positive Harris recurrence for multiclass queueing networks: a unified approach via fluid limit models. Preprint, 1993.
- [4] DAI, J., AND WEISS, G. Stability and instability of fluid models for certain re-entrant lines. Preprint, February 1994.
- [5] LU, S., AND KUMAR, P. Distributed scheduling based on due dates and buffer priorities. *IEEE Transactions on Automatic Control* 36, 12 (December 1991), 1406-1416.
- [6] MALYSHEV, V. Networks and dynamical systems. Rapport de recherche 1468, INRIA, May 1991.
- [7] MEYN, S. Transience of multiclass queueing networks via fluid limit models. Submitted, November 1994.

- [8] RYBKO, A., AND STOLYAR, A. Ergodicity of stochastic processes describing the operation of open queueing networks. *Problemy Peredachi Informatsii* 28, 3 (July-September 1992), 3-26.
- [9] V.A.MALYSHEV, AND M.V.MENSHIKOV. Ergodicity, continuity, and analyticity of countable Markov chains. *Trans. Moskow Math. Soc.* 1 (1981), 1-47.



Unité de recherche INRIA Rocquencourt
Domaine de Voluceau - Rocquencourt - B.P. 105 - 78153 Le Chesnay Cedex (France)
Unité de recherche INRIA Lorraine - Technopôle de Nancy-Brabois - Campus scientifique
615, rue du Jardin Botanique - B.P. 101 - 54602 Villers lès Nancy Cedex (France)
Unité de recherche INRIA Rennes - IRISA, Campus universitaire de Beaulieu 35042 Rennes Cedex (France)
Unité de recherche INRIA Rhône-Alpes 46, avenue Félix Viallet - 38031 Grenoble Cedex 1 (France)
Unité de recherche INRIA Sophia Antipolis - 2004, route des Lucioles - B.P. 93 - 06902 Sophia Antipolis Cedex (France)

Éditeur
INRIA - Domaine de Voluceau - Rocquencourt - B.P. 105 - 78153 Le Chesnay Cedex (France)

ISSN 0249 - 6399



★ R R - 2 4 8 7 ★