



HAL
open science

On the Computation and Control of the Mass Center of Articulated Chains

Bernard Espiau, Ronan Boulic

► **To cite this version:**

Bernard Espiau, Ronan Boulic. On the Computation and Control of the Mass Center of Articulated Chains. RR-3479, INRIA. 1998. inria-00073210

HAL Id: inria-00073210

<https://inria.hal.science/inria-00073210>

Submitted on 24 May 2006

HAL is a multi-disciplinary open access archive for the deposit and dissemination of scientific research documents, whether they are published or not. The documents may come from teaching and research institutions in France or abroad, or from public or private research centers.

L'archive ouverte pluridisciplinaire **HAL**, est destinée au dépôt et à la diffusion de documents scientifiques de niveau recherche, publiés ou non, émanant des établissements d'enseignement et de recherche français ou étrangers, des laboratoires publics ou privés.

*On the Computation and Control of the Mass
Center of Articulated Chains*

Bernard Espiau, Ronan Boulic

N° 3479

Août 1998

————— THÈME 4 —————



*Rapport
de recherche*

On the Computation and Control of the Mass Center of Articulated Chains

Bernard Espiau, Ronan Boulic*

Thème 4 — Simulation et optimisation
de systèmes complexes
Projet BIP

Rapport de recherche n° 3479 — Août 1998 — 35 pages

Abstract: The control of the center of mass of a robot is a relevant problem in case of biped walking machines. Besides, studying the motion and the stabilization of the center of mass of a human is an important research topic in the area of biomechanics. Finally, the two areas are involved when we want to synthesize certain classes of realistic motions in computer animation. In this paper, we address some of the modelling and control problems which arise when considering the CoM of an articulated chain. In a first part, we show that the position of the CoM of a general tree-structure kinematic chain can always be represented by the end-point position of an equivalent serial open kinematic chain, the geometric parameters of which depend on the mass properties of the original structure. We then use this result in a second part, in which we describe a way of specifying tasks involving the motion of the CoM. We also propose in the paper a general approach of the associated control problem and of its implementation and give an example of application to computer animation.

Key-words: Center of Mass, Kinematics, Biped robots, Computer animation

(Résumé : tsvp)

* Senior Scientist, Swiss Federal Institute of Technology, EPFL, DI-LIG, CH 1015 Lausanne, Switzerland; e-mail: Ronan.Boulic@epfl.ch; Web: <http://ligwww.epfl.ch/boulic.html>

Sur le calcul du centre de masse des chaînes articulées et sa commande

Résumé : La commande du centre de masse d'un robot marcheur est un problème important, celui-ci n'étant en relation avec le sol qu'à travers des contraintes unilatérales. Par ailleurs, l'étude du mouvement du centre de masse du bipède humain est un sujet cher aux biomécaniciens. Les deux aspects se rejoignent lorsque l'on souhaite synthétiser des déplacements ou des postures réalistes pour un modèle humain en animation par ordinateur. Dans cet article, nous considérons certains des problèmes qui se posent lorsque l'on souhaite étudier le centre de masse d'une chaîne articulée rigide quelconque. Dans une première étape, nous montrons que le centre de masse de n'importe quelle chaîne arborescente peut être représenté par le point terminal d'une chaîne série, dont les paramètres géométriques dépendent des répartitions massiques de la chaîne originale, et dont les variables articulaires sont liées aux variables d'origine par des relations simples. Dans une seconde partie, nous indiquons comment spécifier une tâche impliquant la position du centre de masse et proposons un schéma général de commande dans ce but. Enfin, nous illustrons l'approche proposée à travers un exemple d'animation en infographie.

Mots-clé : Mécanique, Cinématique, Robotique, Centre de masse, Bipédie, Animation

1 Introduction

Controlling the center of mass of a robot is usually not a major concern in the robotics community. Indeed, for classical robot manipulators, static stability is ensured since they are fixed to the ground (see an exception in [1]) and that the gravity effects on the joint torques are generally compensated for, either actively or using passive mechanical devices. In case of wheeled or statically stable legged robots, the mass center should be kept over the support area; in practice this problem is often addressed more as a safety issue considered at a planning level than as a control objective.

However, when considering machines which are statically unstable, such as a biped robot, the position of the center of mass (referred to as CoM in the following) becomes an important variable.¹ Studying CoM is also an important issue in the areas of biomechanics which are concerned with posture and gait analysis ([2, 9, 13, 17]). For example, estimating the CoM from measurements of the ZMP (i.e of the center of pressure) only, is a typical problem in studying the human performance ([11, 12]). Finally, it is worth mentioning that in the domain of graphical animation, the CoM has been recently considered as a parameter the effect of which is determinant when synthesizing postures ([4, 5, 6]).

In almost all cases, we face the problem of finding and controlling, generally through a feedback loop, the 3D coordinates of the CoM of a tree-structure kinematic chain with several joints (a few tens for a human-like skeleton). A frequently encountered problem in that case is the frequent occurrence of singularities, often due to the reaching of the boundaries of the CoM workspace. While searching for a way of cleverly addressing this question, we have found (see a preliminary presentation in [15]) that *the position of the CoM of a general tree-structure kinematic chain can always be represented by the end-point position of an equivalent serial open kinematic chain, the geometric parameters of which depends on the mass properties of the original structure*. These geometric parameters are fixed and do not change with the configuration of the original chain. Moreover, the joint variables of this equivalent structure are simple functions of the original joint values. This result holds for simple chains as well as for tree-structured ones, the equivalent system being always a serial chain with the same number of joints as the overall number of dofs of the original chain.

Surprisingly, we did not find such a result given under this form in the literature. To our knowledge, the closest approach is reported in Vafa and Dubowsky's paper ([21]), in which a concept of virtual manipulator is presented for application to space manipulators. By reverting their definitions of end point and base, we can find very similar results, although the case of tree structures is not addressed in its generality in the cited paper. We will see that we can give a general algorithm for this last case.

The interest of the approach we propose is to allow, once the needed transformation is performed (and it can be done automatically), to inherit, for studying and controlling the CoM of any articulated structure, all what is known and done for controlling the end point

¹Let us incidentally recall that the well known ZMP (Zero Moment Point) reduces to the coordinates of the ground projection of the CoM when the system is motionless. Monitoring or controlling the ZMP are fundamental concerns for biped dynamic stability (cf [3, 10])

of a serial manipulator: algorithms for direct kinematics, Jacobian computation, gravity compensation at the joints, methods for workspace analysis, singularity determination etc...

In this paper, we present the details of this result and the related proofs. In Section 2, we consider serial chains. In Section 3, the case of tree-structure kinematic chains is addressed, Section 4 presents miscellaneous issues, the next Section is concerned with control aspects, and Section 6 shows an application of the approach to computer animation.

Note that the original chain will be denoted as C and the equivalent one as C' in all the following.

2 Case of Serial Kinematic Chains

2.1 A Very Simple Example

Let us consider the simple planar chain C depicted in figure 1. The links have unit length, the equal point masses m are located in the middle point of each link. The coordinates of the mass center, (x_C, y_C) , of this system in the shown reference frame are:

$$\begin{cases} x_C = \frac{1}{6}(5 \cos(q_1) + 3 \cos(q_1 + q_2) + \cos(q_1 + q_2 + q_3)) \\ y_C = \frac{1}{6}(5 \sin(q_1) + 3 \sin(q_1 + q_2) + \sin(q_1 + q_2 + q_3)) \end{cases} \quad (1)$$

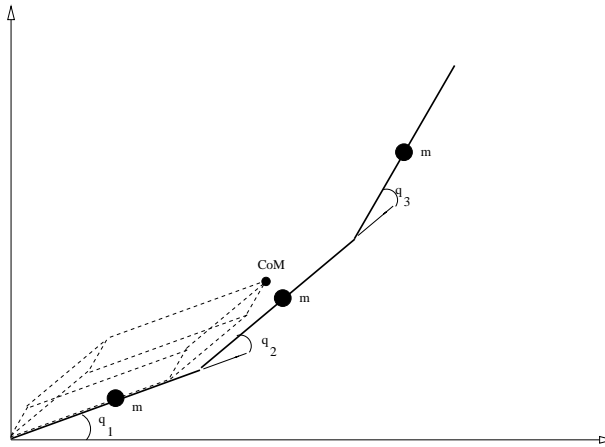

Figure 1: A planar 3 dof chain

Notice that the point (x_C, y_C) also corresponds to the endpoint coordinates of a 3 dof planar arm C' having the same joint coordinates as the original arm, and with link lengths, $5/6$, $1/2$, and $1/6$, respectively. In fact, this is only one of the six possible solutions, summarized in the Table of figure 2. In the table, l_i denotes the link lengths and q'_i are the joint variables of the chains. All these "equivalent" arms are drawn in dotted line on the figure. This result can now be generalized as shown in the next section.

l_1	l_2	l_3	q'_1	q'_2	q'_3
5/6	1/2	1/6	q_1	q_2	q_3
5/6	1/6	1/2	q_1	$q_2 + q_3$	$-q_3$
1/2	5/6	1/6	$q_1 + q_2$	$-q_2$	$q_2 + q_3$
1/2	1/6	5/6	$q_1 + q_2$	q_3	$-q_2 - q_3$
1/6	1/2	5/6	$q_1 + q_2 + q_3$	$-q_3$	$-q_2$
1/6	5/6	1/2	$q_1 + q_2 + q_3$	$-q_2 - q_3$	q_2

Figure 2: Six equivalent chains

2.2 Case of General Serial Kinematic Chains

We consider a kinematic chain, C , with the following assumptions and notation:

- the chain has n rigid links L_i , each having a frame F_i attached to it. The reference frame is F_0 ;
- the joint between link L_{i-1} and link L_i has 1 d.o.f., either prismatic or revolute, with joint variable denoted as q_i ;
- the 4×4 homogeneous transformation matrix between frames F_{i-1} and F_i is denoted as

$$D_{i-1,i} = \begin{pmatrix} R_{i-1,i} & t_{i-1,i} \\ 0 & 1 \end{pmatrix} \quad (2)$$

where $t_{i-1,i}$ is a short notation for $[t_{i-1,i}]_{i-1}$ (i.e. expressed in frame F_{i-1}).

- we can use the Denavit-Hartenberg parameters, as depicted in figure 3. Therefore:

$$D_{j-1,j} = \begin{pmatrix} \cos(\theta_j) & -\sin(\theta_j) & 0 & d_j \\ \cos(\alpha_j) \sin(\theta_j) & \cos(\alpha_j) \cos(\theta_j) & -\sin(\alpha_j) & -r_j \sin(\alpha_j) \\ \sin(\alpha_j) \sin(\theta_j) & \sin(\alpha_j) \cos(\theta_j) & \cos(\alpha_j) & r_j \cos(\alpha_j) \\ 0 & 0 & 0 & 1 \end{pmatrix} \quad (3)$$

with $q_j = \text{either } \theta_j^2 \text{ or } r_j$.

- every link has mass m_i and the homogeneous coordinates of the mass center of link L_i in frame F_i are denoted as

$$A_i = \begin{pmatrix} a_i \\ 1 \end{pmatrix} ; \text{ with } A_0 = \begin{pmatrix} 0 \\ 0 \\ 0 \\ 1 \end{pmatrix} \quad (4)$$

²For planar chains we could also use absolute angles (i.e. with respect to the gravity direction), leading therefore to results without angular combination for equivalent chains in the non-serial case. The use of joint coordinates remains preferable for 3D general chains, and this is why we will use it in the paper.

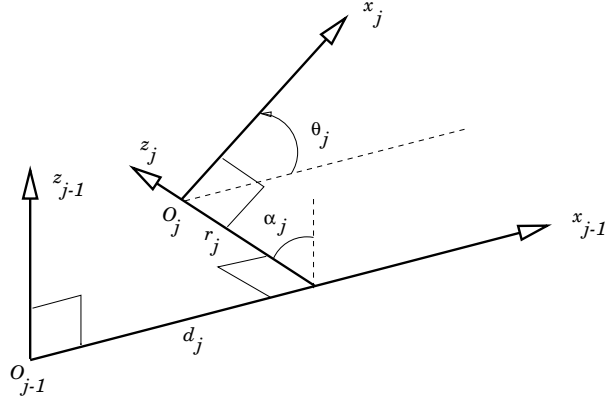

Figure 3: Denavit-Hartenberg Parameters

- the total mass of the arm is $m = \sum_{i=1}^n m_i$ and we denote $\mu_i = m_i/m$

The homogeneous coordinates of the arm mass center in F_0 can therefore be written:

$$[M_c]_0 = \begin{pmatrix} x_c^1 \\ x_c^2 \\ x_c^3 \\ 1 \end{pmatrix} = \sum_{i=1}^n \mu_i D_{0i} A_i \quad (5)$$

Let us now consider another serial chain, C' , with n links L'_i , with associated frames F'_i and transformation matrices $D'_{i-1,i}$. The homogeneous coordinates of its end point in the last frame are denoted as A'_n . We have then the following result.

Proposition P1

The equality

$$\sum_{i=1}^n \mu_i D_{0i} A_i = D'_{0n} A'_n \quad (6)$$

where

$$\begin{cases} R'_{i,i+1} = R_{i,i+1} \\ t'_{i,i+1} = \mu_i a_i + (\sum_{j=i+1}^n \mu_j) t_{i,i+1} \end{cases} \quad (7)$$

for $i = 0 \dots n - 1$ and with $a'_n = \mu_n a_n$,
holds for all values of the joint coordinates.

In other words, the homogeneous coordinates of the mass center of the chain C are the same as the endpoint coordinates of a serial chain C' with geometric parameters depending on the masses and the link CoM locations. When the manipulator has only rotational

joints, the joint values are the same for both arms. Let us emphasize that the solution given in the proposition is the only one, among the $n!$ possible solutions, which guarantees this last property.

Proof

Let us suppose that the Proposition P1 is true for n and verify it for $n + 1$. We have therefore to check that with

$$\begin{cases} R''_{0,n+1} = R_{0,n+1} \\ t''_{i,i+1} = \mu_i a_i + (\sum_{j=i+1}^{n+1} \mu_j) t_{i,i+1}, \quad i = 0 \dots n \\ a''_{n+1} = \mu_{n+1} a_{n+1} \end{cases} \quad (8)$$

we have:

$$\sum_{i=1}^n \mu_i D_{0i} A_i + \mu_{n+1} D_{0,n+1} A_{n+1} = D''_{0,n+1} A''_{n+1} \quad (9)$$

Using (6), the LHS of (9), denoted as l , can be written as

$$l = D'_{0n} A'_n + \mu_{n+1} D_{0n} D_{n,n+1} A_{n+1} \quad (10)$$

and, by using the first line (rotation part) of (7),

$$l = \mu_n R_{0n} a_n + t'_{0n} + \mu_{n+1} R_{0n} R_{n,n+1} a_{n+1} + \mu_{n+1} R_{0n} t_{n,n+1} + \mu_{n+1} t_{0n} \quad (11)$$

We therefore have to check that l satisfies as well

$$l = R''_{0,n+1} a''_{n+1} + t''_{0,n+1} \quad (12)$$

By using the lines 1 and 3 of (8) in (11) and (12), we have finally to verify that

$$t''_{0,n+1} = \mu_n R_{0n} a'_n + \mu_{n+1} t_{0n} + \mu_{n+1} R_{0n} t_{n,n+1} + t'_{0n} \quad (13)$$

Since $[t'_{0n}]_0 = \sum_{i=1}^n [t'_{i-1,i}]_0$ and $[t'_{i-1,i}]_0 = R_{0,i-1} [t'_{i-1,i}]_{i-1} = R_{0,i-1} t'_{i-1,i}$, (13) can be written:

$$t''_{0,n+1} = t'_{01} + R_{01} t'_{12} + \dots + R_{0,n-1} t'_{n-1,n} + \mu_n R_{0n} a_n + \mu_{n+1} t_{0n} + \mu_{n+1} R_{0n} t_{n,n+1} \quad (14)$$

Since

$$t_{0n} = t_{01} + R_{01} t_{12} + \dots + R_{0,n-1} t_{n-1,n}, \quad (15)$$

(14) becomes

$$t''_{0,n+1} = \sum_{i=1}^n R_{0,i-1} (\mu_{n+1} t_{i-1,i} + t'_{i-1,i}) + R_{0n} (\mu_n a_n + \mu_{n+1} t_{n,n+1}) \quad (16)$$

Using the second line (translation part) of (7), we have in (16):

$$\mu_{n+1}t_{i-1,i} + t'_{i-1,i} = \mu_{i-1}a_{i-1} + \left(\sum_{j=i}^n \mu_j \right) t_{i-1,i} + \mu_{n+1}t_{i-1,i} \quad (17)$$

Therefore, the equality is verified by setting in (16)

$$t''_{i,i+1} = \mu_i a_i + \left(\sum_{j=i+1}^{n+1} \mu_j \right) t_{i,i+1}, \quad i = 0 \dots n \quad (18)$$

which proves that the proposition is true for $n + 1$.

3 Tree Structures

For simplicity, we consider, in the following, the case where all joints are revolutes. However, the approach applies for a general structure (mixed revolute/prismatic or purely prismatic) as well.

3.1 A Very Simple Example

Let us consider the simple system depicted in Figure 4. The coordinates of its mass center in the shown reference frame are:

$$\begin{cases} x_M = \frac{l}{m_1 + m_2} (m_1 \cos(q_1) + m_2 \cos(q_2)) \\ y_M = \frac{l}{m_1 + m_2} (m_1 \sin(q_1) + m_2 \sin(q_2)) \end{cases} \quad (19)$$

They also correspond to the coordinates of the endpoint of a 2 dof serial arm, with link lengths $l'_i = lm_i/(m_1 + m_2)$, $i = 1, 2$, and joint coordinates given by: $q'_1 = q_1$; $q'_2 = q_2 - q_1$. This “equivalent” arm and the second possible solution are drawn in dotted lines on the figure. This result can also be generalized as shown in the next sections.

3.2 Case of a Star-form Open Chain

Let us consider the general system of Figure 5.

We have p independent simple chains. Each chain j has n_j joints, with $\sum_{j=1}^p n_j = n$. We can therefore apply Proposition P1 and get from equation (6) the equivalence:

$$[M_c^j]_0 = \sum_{i=1}^{n_j} \mu_i^j D_{0i}^j A_i^j = D'_{0,n_j}{}^j A'_{n_j}{}^j \quad \forall j = 1 \dots p \quad (20)$$

the superscript j being relative to the chain number and with, from (7):

$$D'_{0,n_j}{}^j = \begin{pmatrix} R_{0,n_j}{}^j & t'_{0,n_j}{}^j \\ 0 & 1 \end{pmatrix} \quad (21)$$

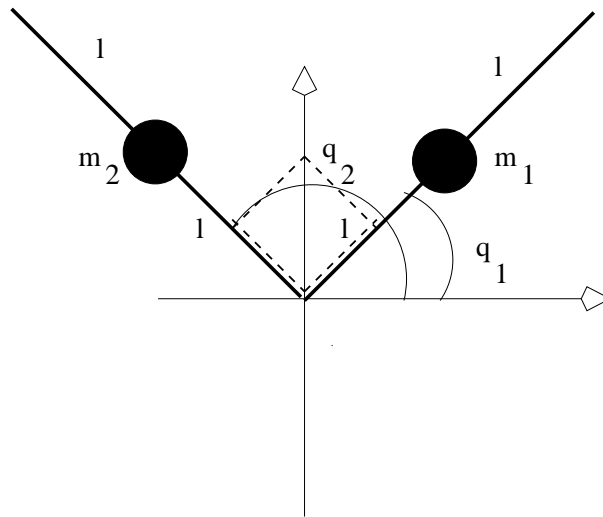

Figure 4: A 2 dof tree-structure kinematic chain

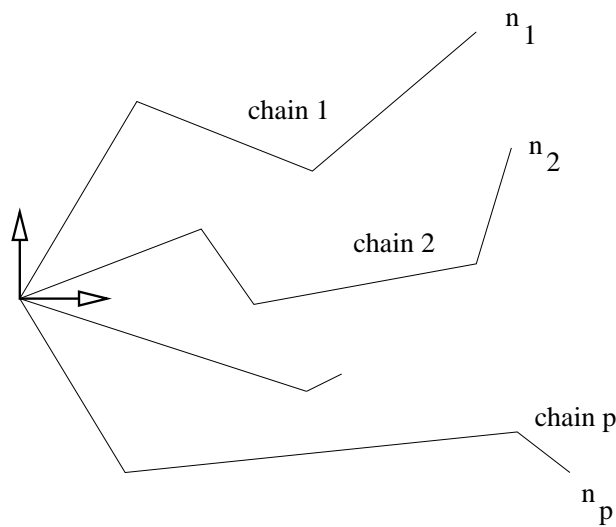

Figure 5: A general star-form chain

The total mass of each chain is denoted as M_j and we set $\nu_j = M_j / (\sum_{i=1}^p M_i)$. Since the homogeneous coordinates of the overall mass center are given by

$$[M_c]_0 = \frac{1}{\sum_{i=1}^p M_i} \sum_{j=1}^p M_j [M_c^j]_0 \tag{22}$$

we are led to searching for the equivalence:

$$\sum_{j=1}^p \nu_j D'_{0,n_j} A'_{n_j}{}^j = \bar{D}_{0n} \bar{A}_n \quad (23)$$

By expanding

$$\bar{D}_{0n} \bar{A}_n = \sum_{i=0}^{n-1} \bar{R}_{0i} \bar{t}_{i,i+1} + \bar{R}_{0n} \bar{a}_n \quad (24)$$

and

$$\nu_j D'_{0,n_j} A'_{n_j}{}^j = R_{0,n_j}^j \nu_j a'^j + R_{0,n_j-1}^j \nu_j t'^j{}_{n_j-1,n_j} + \dots + R_{0,1}^j \nu_j t'^j{}_{12} + \nu_j t'^j{}_{01} \quad \forall j = 1 \dots p \quad (25)$$

and identifying the $n + 1$ terms of (24) with the $n + p$ terms of (25), it is straightforward, although tedious, to obtain

Proposition P2

Let us denote

$$\beta_{j-1} = \sum_{i=1}^{j-1} n_i \quad ; \quad \alpha_{jk} = \beta_{j-1} + k \quad (26)$$

A solution of (23) is then given by the following equations:

1- FOR $j = 2 \dots p$:

$$\forall k = 1 \dots n_j - 1 : \begin{cases} \bar{R}_{\alpha_{jk}, \alpha_{jk}+1} = R_{k,k+1}^j \\ \bar{t}_{\alpha_{jk}+1, \alpha_{jk}+2} = \nu_j t'^j{}_{k+1, k+2} \end{cases} \quad (27)$$

and

$$\bar{R}_{\beta_{j-1}, \beta_{j-1}+1} = (R_{0,n_j-1}^{j-1})^{-1} R_{01}^j \quad (28)$$

$$\bar{t}_{\beta_{j-1}+1, \beta_{j-1}+2} = \nu_j t'^j{}_{12} \quad (29)$$

$$\bar{t}_{\beta_j, \beta_j+1} = \nu_j a'^j \quad (30)$$

2- COMPLEMENTARY EXPRESSIONS:

$$\bar{t}_{01} = \sum_{j=1}^p \nu_j t'^j{}_{01} \quad (31)$$

$$\forall l = 0 \dots n_1 - 1 : \begin{cases} \bar{R}_{l, l+1} = R_{l, l+1}^1 \\ \bar{t}_{l+1, l+2} = \nu_1 t'^1{}_{l+1, l+2} \end{cases} \quad (32)$$

$$\bar{t}_{n_1, n_1+1} = \nu_1 a'^1 \quad (33)$$

$$\bar{t}_{n,n+1} \equiv \bar{A}_n \tag{34}$$

It should be emphasized that the results depend on the order in which the independent chains are considered.

Let us illustrate the approach with the simple example of Figure 6. The two chains have identical structure: 2 equal links of length $2l$, equal point masses m located at the middle point of the links. Applying the above results starting from the upper chain gives for the equivalent chain C' the values reported on the table.

l_1	l_2	l_3	l_4	\bar{q}_1	\bar{q}_2	\bar{q}_3	\bar{q}_4
$3l/4$	$l/4$	$3l/4$	$l/4$	q_1^1	q_2^1	$q_1^2 - q_1^1 - q_2^1$	q_2^2

Beginning with the lower chain gives a symmetric result. Both are drawn in dotted lines on the figure.

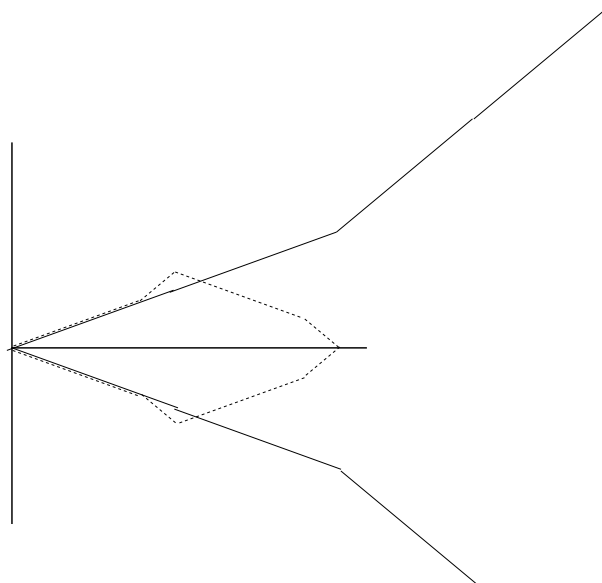

Figure 6: A 4-links star-form chain

3.3 Case of a General Tree-form Chain

We are now ready to solve the problem of general tree-form structures such as the one shown in Fig 7. The idea is to consider such a chain as a star-form one by defining p virtual branches starting from the same origin, with the following constraints:

- when a link is common to several branches, its mass is zero, except for one of the branches;
- all the Denavit-Hartenberg parameters of a common link have the same values for all the branches owing this link.

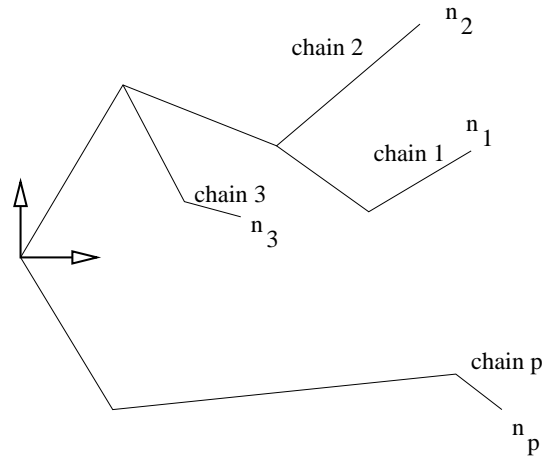

Figure 7: A general tree-form chain

We can then apply the approach of section 3.2, with some slight modifications. Since the derivation of explicit general formulae in that case would lead to cumbersome expressions, with many supplementary indices corresponding to the nodes of the structure, we prefer to give the computation algorithm only. It is presented in the appendix.

As an illustration of the approach, figure 8 gives an equivalent chain for a plane biped robot with human-like geometry and masses. The system has 7 links including the two feet and therefore 6 joints move during the swing phase. Because the influence of the swinging foot on the COG is very weak, the corresponding link of the equivalent chain is so small that its extremities do not appear separately on the figure. Nevertheless the computed equivalent chain has well 6 joints.

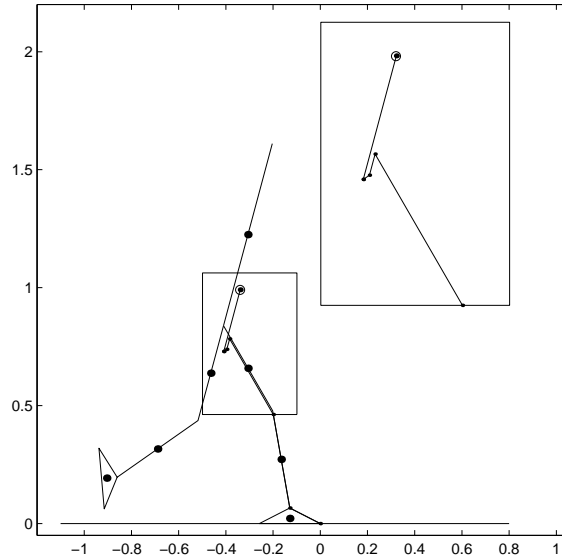

Figure 8: Equivalent chain for a planar biped

4 Miscellaneous

4.1 Velocity and Jacobian Computation

A classical method for computing the Jacobian matrix associated with the terminal link of an articulated chain consists in computing the contribution of the successive links to the end velocity by holding all joints fixed but one (see [19, 20], for example). We can of course simply apply this method to the equivalent chain C' in order to obtain the velocity of the CoM; however, we may also benefit from an interesting physical interpretation of the computation by directly differentiating the CoM expression using the concept of *augmented body* ([7]), as explained now.

We first define some complementary notation for the points and vectors used in the mass center Jacobian derivation. The reader is referred to figure 9 as an illustration of the method through the example of a 3 dof planar chain. For the clarity of the demonstration, all the vectors are expressed in the frame F_0 ; The explicit indication of the expression frame will be given only when needed. For each joint we set that :

- the translation vector t_{0j} is defined as $t_{0j} = [t_{j-1,j}]_0$ for $q_j = 0$
- the unit vector f_j is defined as $f_j = z_j$ if q_j is a rotation dof, otherwise $f_j = 0$
- the unit vector h_j is defined as $h_j = z_j$ if q_j is a translation dof, otherwise $h_j = 0$

So in the general case, we have :

$$[t_{j-1,j}]_0 = t_{0j} + q_j h_j \quad (35)$$

The vector ω_j defines the instantaneous rotation of link L_j relatively to link L_{j-1} . Therefore:

$$\omega_j = \dot{q}_j f_j \quad (36)$$

For any $\alpha \in [0, n]$, $\beta \in [1, n]$, the point $A_{\alpha\beta}$ is the mass center of link L_β (located in frame F_α). We have :

$$A_{\alpha\beta} = \sum_{k=\alpha+1}^{\beta} (t_{0k} + q_k h_k) + [A_\beta]_0 \quad (37)$$

$$A_{\beta\beta} = [A_\beta]_0 \quad (38)$$

The point M_{aj} (located in frame F_j) is the partial center of mass of the set of links $\{L_k\}_{k=j,n}$. This set of links is further called the augmented body associated with joint j ; its mass is denoted as $m_{aj} = \sum_{k=j}^n m_k$. Figure 9a shows these points for a three links chain with equal mass segments. We have:

$$M_{aj} = \frac{1}{m_{aj}} \left(\sum_{k=j}^n m_k A_{jk} \right) \quad (39)$$

The homogeneous coordinates of the arm mass center are given by:

$$[M_c]_0 = \frac{1}{m} \sum_{i=1}^n (m_i A_{0i}) = \frac{1}{m} \sum_{i=1}^n m_i \left(\sum_{k=1}^i (t_{0k} + q_k h_k) + [A_i]_0 \right) \quad (40)$$

We now differentiate equation (40) with respect to time in order to relate the instantaneous velocity of the mass center to the joint instantaneous variations. We further denote v_{Ma_i} as the velocity of the partial center of mass Ma_i due to joint j , v_{M_i} as the velocity of the mass center due to joint j , and v_M the total mass center velocity. We have therefore :

$$v_M = \frac{1}{m} \sum_{i=1}^n m_i \left(\sum_{k=1}^i \left(\frac{d}{dt} t_{0k} + \dot{q}_k h_k + q_k \frac{d}{dt} h_k \right) + \frac{d}{dt} [A_i]_0 \right) \quad (41)$$

The time derivative of a vector u (constant in frame F_k) with respect to frame F_0 is given by

$$\frac{d}{dt} u = \sum_{j=1}^k (\omega_j \times u) = \sum_{j=1}^k (\dot{q}_j f_j \times u) \quad (42)$$

When replacing in equation (41) we obtain:

$$v_M = \frac{1}{m} \sum_{i=1}^n m_i \left(\sum_{k=2}^i \left(\sum_{j=1}^{k-1} (\dot{q}_j f_j \times [t_{k-1,k}]_0) \right) + \sum_{k=1}^i (\dot{q}_k h_k) + \sum_{j=1}^i (\dot{q}_j f_j \times [A_i]_0) \right) \quad (43)$$

$$v_M = \frac{1}{m} \sum_{i=1}^n m_i \left(\sum_{j=1}^i \dot{q}_j f_j \times A_{ji} + \sum_{k=1}^i (\dot{q}_k h_k) \right) \quad (44)$$

$$v_M = \frac{1}{m} \sum_{j=1}^n \dot{q}_j f_j \times \left(\sum_{i=j}^n m_i A_{ji} \right) + \frac{1}{m} \sum_{j=1}^n \dot{q}_j h_j \sum_{i=j}^n m_i \quad (45)$$

$$v_M = \sum_{j=1}^n \dot{q}_j \frac{m_{aj}}{m} (f_j \times M_{aj} + h_j) \quad (46)$$

that we can also write in the compact jacobian form:

$$v_M = J_M \dot{q} \quad (47)$$

where q is the vector gathering all joint coordinates (this notation will also be used in the following). The contribution of the rotation dofs from the simple chain appear on figures 9b and 9c (here h is the null vector for all the dofs). First the partial contribution of the dofs results from the cross product ($f_j \times M_{aj}$) applied to the mass centers of the augmented bodies (fig. 9b). This contribution is weighted by the factor $\frac{m_{aj}}{m}$ to reflect the proportion of the total mass carried by the joint j (fig. 9c). The Jacobian matrix J_M , developed in the expression (46) is called the *Kinetic Jacobian*, since it gathers the kinematic and mass distribution information of the articulated structure.

The augmented body concept is central to the previous development. It encompasses any open loop structure including tree ones in a transparent way with the same definition of an instantaneous rigid body gathering the set of links carried by a joint.

When the articulated structure is in single support, one should be aware that the choice of the supporting link strongly determines the construction of the augmented bodies. Thus, the influence a joint has on the mass center position might be relevant for only a certain range of posture; for example in the case of weight transfer from one foot to the other one in a biped structure, the supporting link should be the one physically supporting the bigger fraction of the body weight. The partial mass centers are shown on another planar kinematic chain with more degrees of freedom (figure 10). The final contribution representing the Jacobian are also drawn. In this example (and also in figure 11), the thickness of the chain reflects the mass distribution. This flower-shaped chain can be easily brought to a posture in static equilibrium by ensuring that the mass center projects over its base.

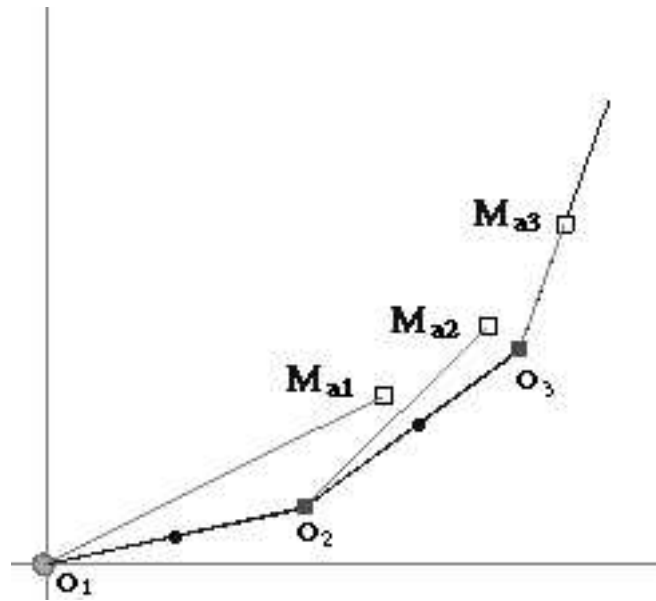

(a) partial centers of mass

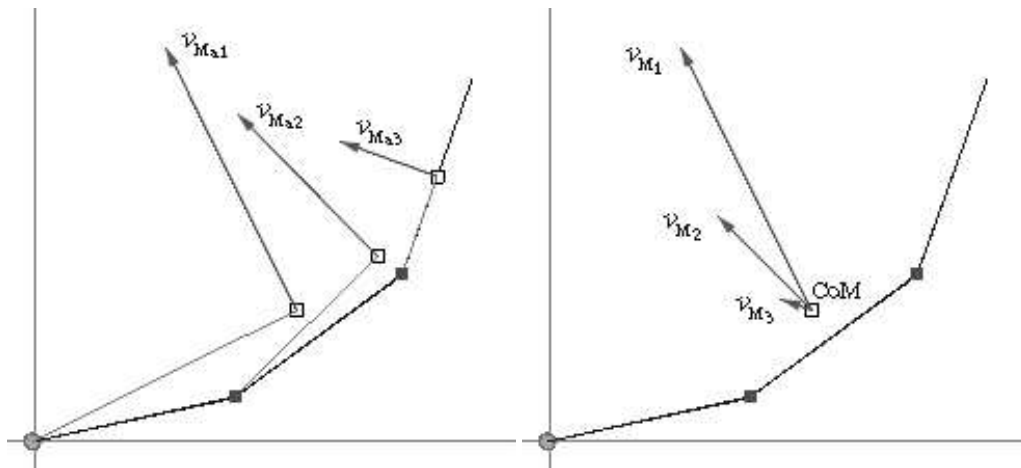

(b) partial instantaneous velocities

(c) final instantaneous velocities

Figure 9: Building the center of mass jacobian for a simple three dof chain with equal segment mass

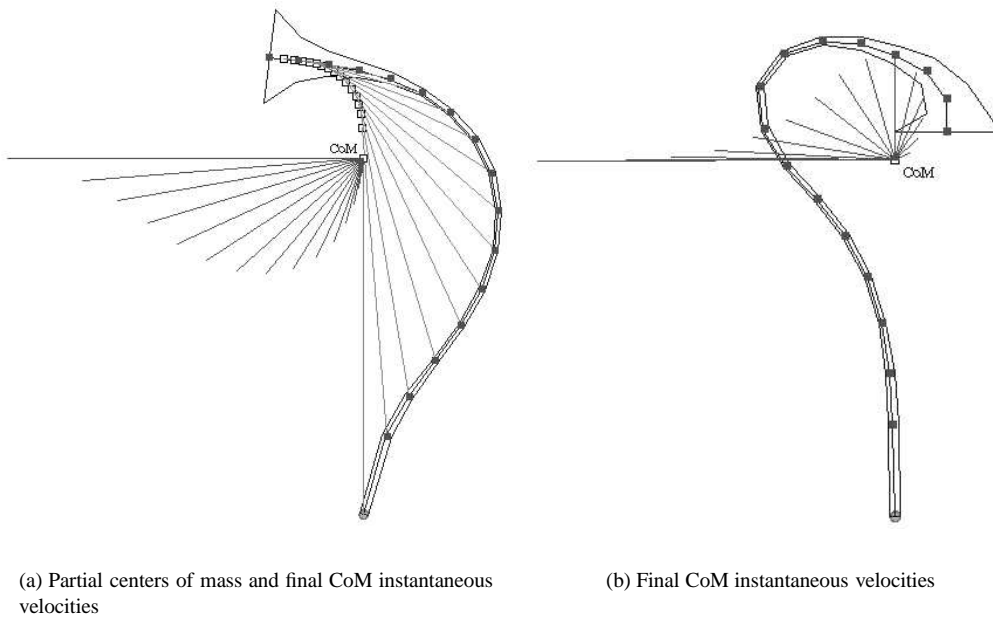

Figure 10: Two examples of a balanced posture design for a flower shaped chain

4.2 Computation of Joint Torques due to Gravity

We show in this section that the equivalent chain C' provides easily with the expression of joint torques due to gravity in C . The potential energy of C is:

$$E_p = \sum_{i=1}^n m_i g z_c^i(q) \quad (48)$$

where z_c^i is the altitude of the mass center of link i , with respect to a common horizontal reference. It is also related to the altitude of the global mass center of C , x_c^3 (cf notation defined in (40)) through:

$$E_p = M g x_c^3(q) \quad (49)$$

Knowing that x_c^3 is also the vertical coordinate of the endpoint of C' , $x'^3(q')$, the joint torques due to gravity of C are immediately obtained from the Jacobian of C' :

$$G(q) = \frac{\partial E_p}{\partial q} = M g \frac{\partial x'^3}{\partial q} = M g J_3^T(q') \frac{\partial q'}{\partial q} \quad (50)$$

where J_3 is the third line of the jacobian matrix. In the case of pure serial chains, $G(q)$ can reduce to $M g J_3^T(q)$.

4.3 Dynamical Non-equivalence

The result we proposed in this paper is an equivalence of kinematical nature. A question which arises now is: given this first equivalence, does there exist a chance of finding a further *dynamical* equivalence? The answer is unfortunately negative, as briefly shown below.

Such a dynamical equivalence between chains C and C' would require that the mechanical energy be identical in the two cases for all values of the state (q, \dot{q}) (we have taken $q' \equiv q$ for simplification). This should be true in particular for the potential energy. We have again, for C :

$$E_p = M g x_c^3(q) = M g x'^3(q) \quad (51)$$

and, for C' :

$$E_p' = M g x_p'^3(q) \quad (52)$$

Equality therefore requires $x_c^3 = x'^3 \forall q$. This means that the mass center of C' is located at its endpoint. This occurs only when C' has a single non-zero point mass, located in its endpoint. This obviously forbids any further specification of mass/inertia properties for C' which would be required for assigning a given kinetic energy to C' .

4.4 Closed Chains

To some extent, we can consider that a closed kinematic chain, like a biped robot in a double support phase, can be modelled as a tree-structure one to which are added algebraic constraints of the form

$$h(q) = 0 \quad (53)$$

This expression holds for bilateral constraints, while for unilateral ones we have $h(q) \geq 0$ instead. The constraints $h(q) = 0$ define a submanifold in the n -dimensional configuration space of the chain.

Therefore, if we have a closed chain $\{C; h(q) = 0\}$, the equivalent one in our usual sense is $\{C'; h(q) = 0\}$. If now C' requires a change of coordinates $q' = f(q)$ such that f is a diffeomorphism in the whole configuration space, the equivalent chain is $\{C'; h'(q') = 0\}$ where $h' = h \circ f^{-1}$.

Basically, there is therefore no particular problem induced by algebraic equality constraints in the approach we propose. However, possible easy physical interpretation of constraints for C may disappear for C' . This is for example the case when constraints express that some given points are motionless in a euclidean reference frame, like when a foot lands in the beginning of a double support phase. To illustrate this fact, let us take the example of the chain of figure 1 and impose to this chain the constraint that its end point stays at the origin. Then, it is easy to see that the endpoint of the constrained equivalent chain belongs to the circle $(O, 1/3)$, no particular point of C' being motionless.

5 Guidelines for Motion Control of the CoM

5.1 Background

5.1.1 Constrained Dynamics.

One of the most frequent cases where the approach proposed here can be used is the one of biped postural control. This task is related to static stability and the case of double support should therefore be considered. This is why we will derive the equations which will be later used in the control in taking into account the existence of constraints. Let

$$M(q)\ddot{q} + N(q, \dot{q}) = B\Gamma \quad (54)$$

be the basic dynamic equation of the considered tree-structured open chain. In (54), M is the kinetics energy matrix, N gathers centrifugal, Coriolis, gravity and joint friction terms and Γ is the array of joint actuator torques. B is a constant matrix, and the dimension of q is n .

Let us now complete (54) with the constraints equation (53). We set $\dim(h) = p < n$, with $n - p = n_1$, and we further assume that

- the constraints are compatible, i.e. the solution of (53) is not an empty set.
- the constraints are independent, i.e

$$\text{rank} \left(C = \frac{\partial h}{\partial q} \right) = p \quad (55)$$

The constrained dynamic equation can now be written as

$$M(q)\ddot{q} + N(q, \dot{q}) = B\Gamma - C^T(q)\lambda \quad (56)$$

where λ is the p -dimensional array of Lagrange multipliers associated with the constraints. Differentiating twice the equation (53) gives

$$C\ddot{q} + s(q, \dot{q}) = 0 \quad (57)$$

The equation (56) can also be written as

$$\ddot{q} = M^{-1}B\Gamma - M^{-1}N - M^{-1}C^T\lambda \quad (58)$$

Using this result in (57) gives:

$$\lambda = (CM^{-1}C^T)^{-1}(CM^{-1}(B\Gamma - N) + s) \quad (59)$$

Replacing in (56) leads to:

$$\ddot{q} = PM^{-1}(B\Gamma - N) - C^\dagger s \quad (60)$$

where

$$C^\dagger = M^{-1}C^T(CM^{-1}C^T)^{-1} \quad (61)$$

and with the notation

$$P = I_n - C^\dagger C \quad (62)$$

P , $n \times n$, is a projection operator onto the null space of C with respect to the kinetics metrics M (this means that we have $P^T M P = M P$ instead of $P^T P = P$ as involved by the euclidean metrics). Its rank is $n - p = n_1$. Multiplying equation (60) by P and using the properties: $P^2 = P$ and $P C^\dagger = 0$ gives finally the equations of the constrained dynamics:

$$P(\ddot{q} - M^{-1}(B\Gamma - N)) = 0 ; h(q) = 0 \quad (63)$$

Remark

Owing to the definition of P (62,61), we have the property: $P M^{-1} = M^{-1} P^T$. An equivalent expression for (63) is therefore $\{P^T(M\ddot{q} - B\Gamma + N) = 0 ; h(q) = 0\}$.

The LHS of equation (63) is of dimension n . Nevertheless, the rank of P is n_1 . We can therefore replace (63) by a set of n_1 equations in the following way: (63) means that

the projection is orthogonal to NS , the null space of C . Therefore, the projected vector is orthogonal to any set of basis vectors of NS . Let us partition C as

$$C = (C_1 \ C_2) \quad (64)$$

where C_1 is $p \times p$, assumed to be nonsingular. We can therefore choose as a basis of NS the columns of the $n_1 \times n$ matrix:

$$R = \begin{pmatrix} -C_1^{-1}C_2 \\ I_{n_1} \end{pmatrix}^T \quad (65)$$

(It can be easily verified that $CR^T = 0$). Finally, the n equations describing the constrained dynamics can be defined as the set:

$$\begin{cases} R(M\ddot{q} - B\Gamma + N) = 0 \\ h(q) = 0 \end{cases} \quad (66)$$

5.1.2 Output Dynamics and Decoupling Control.

We present here a control approach which is based on the explicit use of the models of the dynamics and of the constraints. Of course other methods can be used, but the one presented here is the easiest to explain, although not always the simplest to implement.

If we do not consider degenerate cases, the number of degrees of freedom left available for moving the system (66) is n_1 . Let us assume that the constraints are intrinsically satisfied by the system, i.e. that there is no need to have a control aimed at realizing them. We can therefore specify our control goal as the regulation at zero of a desired output function of dimension n_1 , $e(q, t)$ (see [14] for more details). We will see later how the control of the CoM can be considered from that point of view. Denoting the jacobian matrix of e as J , assumed to be of full rank, the second derivative of e can be written as:

$$\ddot{e} = J(q)\ddot{q} + f(q, \dot{q}, t) \quad (67)$$

Combining (67) with (57) gives

$$\ddot{q} = K \begin{pmatrix} s \\ \ddot{e} - f \end{pmatrix} \quad (68)$$

where

$$K = \begin{pmatrix} C \\ J \end{pmatrix}^{-1} \quad (69)$$

For K to be nonsingular, the independency of e and h is required. This is true if, as aforementioned, the control objective is not concerned with the management of the constraints. Let us now partition K as

$$K = (K_1 \ K_2) \quad (70)$$

where K_1 is $n \times p$ and K_2 is $n \times n_1$, both assumed to be of full rank. Using (70) and (68) in (66) finally leads to the dynamics equation in the output space:

$$M'(q)\ddot{e} + f'(q, \dot{q}, t) = u \quad (71)$$

where

$$M' = RMK_2, \quad (72)$$

assumed to be nonsingular,

$$f' = RM(K_1s - K_2f) + RN \quad (73)$$

and

$$u = RB\Gamma \quad (74)$$

Now, a decoupling and feedback linearizing control is given by

$$u = M'(q)(-K_p e - K_v(J\dot{q} + \frac{\partial e}{\partial t})) + f'(q, \dot{q}, t) \quad (75)$$

where K_p and K_v are diagonal positive matrices. This ideal control ensures a linear second-order decoupled behavior for e . Given u , it remains to compute the actuator torques, Γ , the dimension of which can be greater than n_1 . This can be done by selecting, for example, the torques which minimize some energy-based criterion, or the ones which ensure that constraints (which are in fact unilateral in the case of walking robots ([16])) will not be violated: no sliding, no foot lifting, etc...

5.2 Tasks Based on the Position of the Center of Mass

5.2.1 General Task Specification

Let us now come back to our central concern, the CoM. A first possible objective can be to assign all or some of its coordinates to follow a time-indexed trajectory. This can be for example the case when specifying the gait of a biped robot. But, more frequently, the control of the CoM will be viewed as a way of ensuring the static stability of a system while performing a user-oriented task. We will therefore consider this case in the following. If we have in mind the example of a system in which constraints are unilateral, like a biped robot, we will furthermore assume that friction effects are strong enough to ensure that sliding is avoided in any case.

We assume that $n_1 > 3$, which implies that the control of the CoM cannot be the unique objective to realize. We also consider that we are concerned with static aspects only: this means that inertial accelerations can be neglected and that controlling the CoM instead of the ZMP is enough for avoiding any tipping of the system³. This assumption restricts in fact the class of considered motions to very slow ones and we can therefore really speak of *postural control*.

In that case the task specification can be expressed in the following way: to generate a slow desired motion, defined either in the euclidean space or in the joint space, while

³In [12], it is shown that if the CoM of a human oscillates with a frequency lower than about .2 Hz, the ratio of amplitude oscillation between the center of pressure -i.e the ZMP - and the ground projection of the CoM is close to 1; furthermore, there is never any phase shift.

ensuring the stability of the system. In reference to the developments above, this consists in defining a n_1 -dimensional objective function, $e(q, t)$ aimed at representing the two aspects. Obviously, the stability is a major concern and we will consider that this task has in general the highest degree of priority. Let us therefore set $(\tilde{x}_c^1, \tilde{x}_c^2)$ as the target position in F_0 of the horizontal components of the CoM coordinates. It can be defined as the “center” of the convex hull skeleton of the contact points with the ground. We then define:

$$e_1(q) = \begin{pmatrix} x_c^1(q) - \tilde{x}_c^1 \\ x_c^2(q) - \tilde{x}_c^2 \end{pmatrix} \quad (76)$$

Now, the other part of the task, the postural control itself, can be defined under the form of a m -dimensional function, $e_2(q, t)$, to be regulated to zero, with $n_1 - 2 \leq m \leq n_1$. Let us now express the priority given to e_1 by defining the constrained optimization problem: to minimize $1/2 e_2^T e_2$ under the constraint $e_1 = 0$, at each (q, t) . Then, following [14], the function e solving this problem is:

$$e(q, t) = R(q) J_3^T(q, t) e_3(q, t) \quad (77)$$

with

$$e_3(q, t) = J_1^\dagger e_1(q) + \alpha_1 (I_{n_1} - J_1^\dagger J_1) J_2^T(q, t) e_2(q, t) \quad (78)$$

where $J_i = \frac{\partial e_i}{\partial q}$; $i = 1, 2, 3$ and α_1 is a positive scalar. The matrix $(I_{n_1} - J_1^\dagger J_1)$, with $J_1^\dagger = J_1^T (J_1 J_1^T)^{-1}$, is an orthogonal projection operator onto the null space of J_1 . The matrix R , taken from (65) allows to take into account the constraint (53): in fact, eq. (77) is obtained by solving a second constrained minimization problem: to minimize $1/2 e_3^T e_3$ under the constraint (53), at each (q, t) . Note that the two problems could also be gathered in a single one by considering simultaneously the virtual constraint $e_1 = 0$ (the goal error value) and the physical one $h = 0$ (always satisfied) into an extended constraint vector to be satisfied while minimizing $1/2 e_2^T e_2$.

It should be emphasized that, if the desired posture is not compatible with a stabilization of the projected CoM location, this way of specifying the task will prevent the goal posture from being achieved. In the same way, if the target CoM position is not compatible with the satisfaction of the constraints, it cannot be reached.

There are many ways of defining the posture part of the task. If the goal involves only a few degrees of freedom of the system, the task can be itself expressed as a constrained minimization problem. For example, if the objective is to move the hand (of euclidean coordinates $x_H(q)$ in F_0) to catch an object of coordinates x_O , we can define e_2 under the form:

$$e_2(q, t) = J_4^\dagger e_4(q) + \alpha_2 (I_m - J_4^\dagger J_4) \nabla u \quad (79)$$

where $e_4(q) = x_H(q) - x^*(t)$ and $u(q)$ being a scalar function to minimize; $x^*(t)$ is the desired hand trajectory, from its initial position to x_O .

A generic form for u is $u(q) = 1/2(q - q^*)^T W(q - q^*)$. Classical choices for q^* are:

- $q^* = q_0$, where q_0 is the set of initial joint values, if we want to modify the global posture the less possible.
- $q_i^* = 1/2(q_i^{min} + q_i^{max})$, where q_i^{min} and q_i^{max} are the joint limits, and W a diagonal weighting matrix with $W(i, i) = (q_i^{min} - q_i^{max})^{-2}$.

Other ways of expressing the task to achieve in the same framework of constrained optimization through projection exist. For example, in [7], a hierarchical approach involving the effect of the moments induced by all the links on the joints is proposed; in [18], a new formulation for coping with several priority levels is proposed and applied to human figure motions. In both cases, the resulting postures present a high degree of realism.

5.2.2 Enlarging the Safe Domain for CoM Control.

When the support area is large with respect to the amplitude of the desired motions, assigning the CoM projection to stay strictly at a goal position may appear as an unnecessarily strong constraint. Let us therefore define a “safe area” around $(\tilde{x}_c^1, \tilde{x}_c^2)$ as the interior part of an ellipsis of radius ρ . We can then express a function to minimize as:

$$\phi = 1/2 (e_2^T e_2 + \alpha V^\tau) \quad (80)$$

where

$$V = \frac{e_1^T W e_1}{\rho^2}, \quad (81)$$

e_1 having been defined in (76), α being a positive scalar and W being the s.d.p. weighting matrix defining the small and large axes of the ellipsis. The function e_3 of (77) can then be written:

$$e_3 = \nabla \phi = J_2^T e_2 + \frac{\alpha \tau}{\rho^2} V^{\tau-1} J_1^T W e_1 \quad (82)$$

Note that, in order to have the value of the penalty term of (82) very small inside the ellipsis and very large as soon as we leave it, τ should be large enough.

5.3 Implementation Issues

The basis of the control implementation is equation (75), with a general form of e given by (77) and, either (78) or (82). It is clear that an explicit and complete computation of all the terms involved in these equations in real time is out of reach. This is due to the existence of highly nonlinear terms, some of them having to be differentiated twice. Fortunately, under some weak and realistic assumptions, it is possible to drastically simplify the control expressions without affecting the performances significantly. The underlying analysis is extensively developed in [14](ch. 5 and 6) and we refer the reader to this book for all the related theoretical concerns. We will only give here the practical issues to be considered in the particular case of CoM motion control. Let us therefore express now the control as

$$u = \hat{M}'(q)(-K_p \hat{e} - K_v(\hat{J}\dot{q} + \frac{\partial \hat{e}}{\partial t})) + \hat{f}'(q, \dot{q}, t) \quad (83)$$

where the “hats” indicate that approximated expressions are used instead of the full theoretical ones.

We basically assume that we are concerned with *slow* motions only. This means that \dot{q} and \ddot{q} are small (assumptions A1-1 and A1-2). We also consider that we stay away from singular regions of the involved tasks, i.e that J_i , $i = 1, 2$ are matrices of full rank (assumption A2). More generally, we assume that the first and second derivatives of e_i , $i = 1, 2$ are bounded in some sense (assumption A3). Finally (assumption A4), we will assume that we start not far from the system solution, and that we lie close to this solution (i.e. the errors e_i stay small). We are now ready to achieve the following simplifications.

5.3.1 Effect of A1.

Owing to A1-1, Coriolis, centrifugal and viscous friction terms can be neglected in the dynamics. Therefore, the term N in (54) can be reduced to the gravity one, $G(q)$ which can be automatically computed with the method proposed in this paper, through (50). Terms $s(q, \dot{q})$ in (57) and $f(q, \dot{q})$ in (67) include quadratic forms in velocity. We can therefore set s to zero and f (cf [14] p175) reduces to $2 \frac{\partial^2 e}{\partial q \partial t} \dot{q} + \frac{\partial^2 e}{\partial t^2}$. The first term can generally be neglected. Finally, \hat{f}' in (83) reduces from (73) to

$$\hat{f}' = RM^{-1}G(q) - RK_1 \frac{\partial^2 e}{\partial t^2} \quad (84)$$

where the reference task acceleration $\frac{\partial^2 e}{\partial t^2}$ can often be also neglected.

Finally, assumption A1-2 implies that the purely inertial effects are relatively small in the overall dynamics. A simplified model \hat{M} can therefore be used for the kinetics energy matrix $M(q)$ defined in (54). A requirement is nevertheless that this model be s.d.p., like M is.

5.3.2 Effect of A2, A3 and A4.

We have to compute \hat{e} , $\hat{J} = \frac{\partial \hat{e}}{\partial q}$ and $\frac{\partial \hat{e}}{\partial t}$. Let us firstly recall that e_1 and J_1 are easily obtained using the equivalence method proposed in this paper. Now, let us first consider equations (77,78). It can be shown in [14], ch. 4, that, under some technical assumptions, if α_1 is not too large, then J_3 is a positive matrix. A stability result given in the same reference, ch. 6, then suggests to choose $\hat{J}_3 = I_n$ as a model of J_3 in (77).

Now, it is easy to show that

$$\frac{\partial(J_i^T e_i)}{\partial q} = \begin{pmatrix} e_i^T \omega_1^i \\ \cdot \\ \cdot \\ e_i^T \omega_n^i \end{pmatrix} + J_i^T J_i \quad (85)$$

where ω_j^i is the derivative of the j th column of J_i . Owing to A4, we can often neglect the first term of the RHS in (85) and write

$$\frac{\partial(J_i^T e_i)}{\partial q} \approx J_i^T J_i \quad (86)$$

This means that, finally, we can use in the control the expression

$$\frac{\hat{\partial} e}{\partial q} = R \hat{J}_3^T \hat{J}_3 = R(q) \quad (87)$$

Let us end this paragraph in considering the case of task (82). Owing to (85), its jacobian is

$$J_3 = \frac{\partial e_3}{\partial q} = \begin{pmatrix} e_2^T \omega_1^2 \\ \cdot \\ e_2^T \omega_n^2 \end{pmatrix} + J_2^T J_2 + H(q) \quad (88)$$

with

$$H(q) = \frac{\alpha\tau(\tau-1)}{\rho^4} V^{\tau-2} J_1^T W e_1 e_1^T W J_1 + \frac{\alpha\tau}{\rho^2} V^{\tau-1} J_1^T W e_1 \frac{\partial(J_1^T W e_1)}{\partial q} \quad (89)$$

which can be written

$$H(q) = \frac{\alpha\tau}{\rho^4} V^{\tau-2} [(\tau-1) J_1^T W e_1 e_1^T W J_1 + (e_1^T W e_1) \frac{\partial(J_1^T W e_1)}{\partial q}] \quad (90)$$

If τ is large enough, the second term of the RHS of (90) can be neglected. Finally, using A4, (88) leads to:

$$\frac{\hat{\partial} e_3}{\partial q} = J_2^T J_2 + \frac{\alpha\tau(\tau-1)}{\rho^4} V^{\tau-2} J_1^T W e_1 e_1^T W J_1 \quad (91)$$

This matrix is a s.d.p. one when e_1 is close to zero. The task (77) can therefore be replaced by $e = R e_3$.

6 An Example of Application to Computer Animation

6.1 Introduction

The computer animation of complex articulated structures for highly realistic production still relies on extremely simple techniques. Their purpose is mainly to provide the designer with the largest possible freedom (cf [8]). It results that the most largely used animation technique is still posture interpolation: key postures are specified, either interactively at the joint level, or through other tools based on inverse kinematics. However, the balance of a complex figure, which can be an important element in the realism of a posture and of

the resulting animation, is particularly difficult to enforce with these approaches. For these reasons, we have proposed a way of controlling the position of the mass center in view of satisfying the two following constraints: to allow interactive control from the computer animation artist and to provide him with very intuitive control variables. The chosen framework is the inverse kinematics adapted to the specificity of the mass center location, i.e. by taking into account the mass distribution of the articulated structure, as explained at the beginning of section 4. Such an approach can be proved to be very efficient even with highly redundant structures (e.g. a simplified human skeleton including thirty to forty dofs). Besides it can be combined with end effector control by using appropriate projection operators as shown in Section 5, thus retaining the user-friendliness of the animator interface.

6.2 Combined End Effector and Mass Center Kinematic Control

Let us first note that, since we are addressing postural control in computer animation, the use of full dynamics and feedback control, as presented in section 5, is irrelevant. The control here simply consists in inverting a relation like eq. (47), while using projection operators, like in eq. (78). In [18] two kinematic control architecture of this kind are extensively compared with respect to singularities, tracking errors and performance issues. We recall here the simplest one where the end effector control (with the pseudo-inverse of the end effector kinematic jacobian J_e) is given a lower priority than the mass center control:

$$\dot{q} = J_M^+ v_M + (I - J_M^+ J_M) (J_e^+ v_e) \quad (92)$$

One can also revert the priority depending on the posture design specification, and obtain:

$$\dot{q}_j = J_e^+ v_e + (I - J_e^+ J_e) (J_M^+ v_M) \quad (93)$$

Figures 11 and 12 show a case study with a bird shaped chain (identified from a radiograph of the living animal). The dofs in the thick part of the chain have no or little mobility; their purpose is to approximate the mass distribution. In figure 11 the bird is shown in its rest posture ; it defines the vertical goal line for the mass center. Three gray spots have to be reached by the beak end effector. In figure 12 the left side images are obtained without mass center position control, i.e. by only using the first term of the RHS of eq. 93.

One can notice the resulting deviation of the mass center from the vertical line which indicates an imbalanced posture. One extreme case is the reaching of a point located on the bird body that brings the articulated structure in an intricate posture. The right side images are obtained by applying expression (93); in this context the center of mass tries, and succeeds, to reach the vertical line with a lower priority than the beak control. The combined approach allows a great flexibility because the end user can set the type of priority and experiment interactively even with more degrees of freedom .

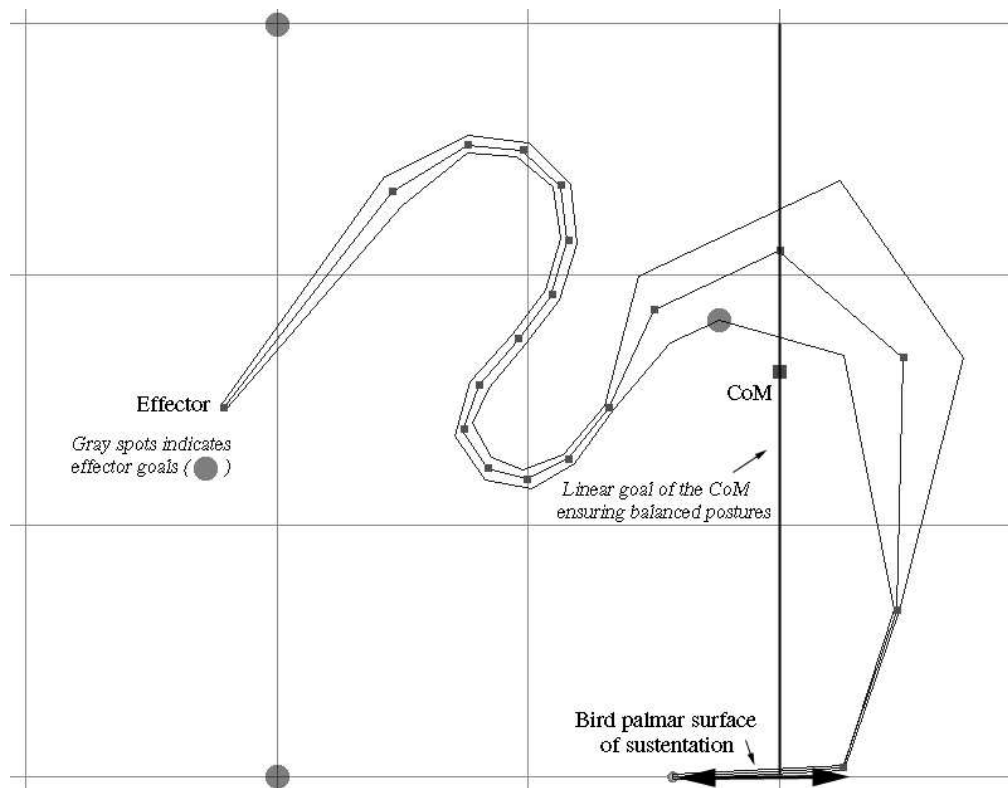

Figure 11: test case of cascaded control with the simplified skeleton of a Malard bird

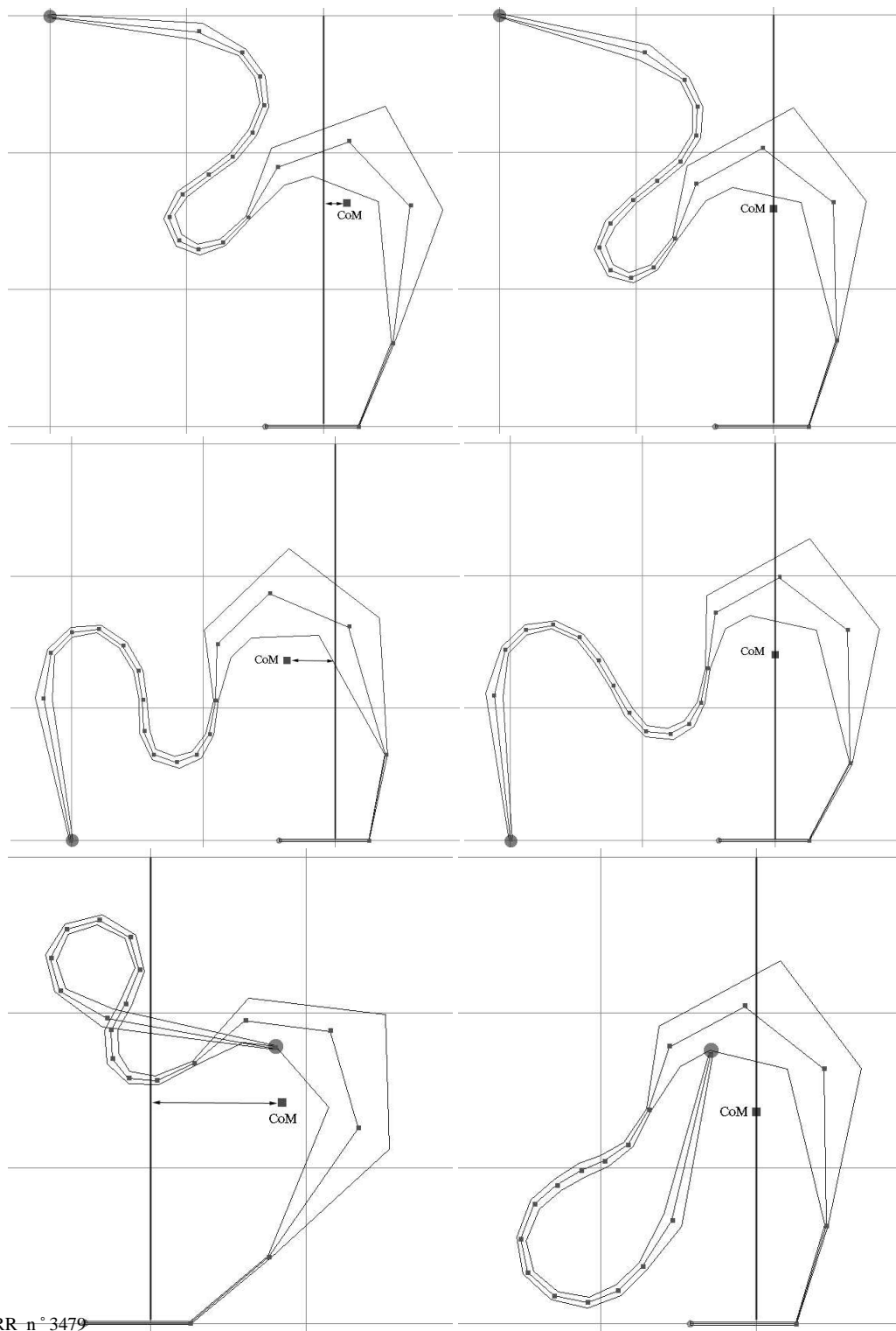

Figure 12: Inverse Kinematics control of the beak effector without (left) and with CoM position control projected on the associated Null space (right)

7 Conclusion

In this paper, we have exhibited a property of equivalence between the position of the CoM of any open articulated chain and the position of the end effector of a simple serial one. We have also given the related algorithms for the case of tree-like structures. In a second step, we have described a way of specifying tasks involving the motion of the CoM, and we have proposed a general approach of the associated control problem and of its implementation. We have also presented an application to postural control in computer animation.

Although this work was illustrated by some examples, it remains now to realize further experimentations on a real biped robot. This would allow to select the most pertinent tasks, either primary or secondary, to be used in usual applications. A last thing which should be interesting would be to capture human postural motions while standing and to try to better understand what are the criteria used by humans in CoM stabilization. In all cases, the use of the proposed modelling method is straightforward.

References

- [1] A. Torige, J. Sugimoto, M. Joguchi, N. Ishizawa, "Development of a Gravity Position Controlled Manipulator Using a Redundant Degree of Freedom", *IEAC Symp. on Robot Control*, Capri, Italy, Sept 19-21 1994, pp 441-446
- [2] Thirunarayan, M A; Kerrigan, D C; Rabuffetti, M; Croce, U D; Saini, M. "Comparison of three methods for estimating vertical displacement of center of mass during level walking in patients" *Gait and Posture*, vol. 4 no 4, 1996, pp 306-314
- [3] Li, Q; Takanishi, A; Kato, I. "Learning Control of Compensative Trunk Motion for Biped Walking Robot Based on ZMP stability Criterion", *IEEE/RSJ Int. Symp. on Intelligent Robot and Systems*, Japan, July 7-10 1992, pp 597-603
- [4] Phillips, C. B; Badler, N. I. "Interactive Behaviors for Bipedal Articulated Figures" *Computer Graphics*, Vol 25-4, July 1991
- [5] Boulic, R. ; Mas R. ; Thalmann, D. "Interactive Identification of the Center of Mass Reachable Space for an Articulated Manipulator" *1997 Int. Conf. on Advanced Robotics*, July 7-9, 1997, Monterey, California, U.S.A.
- [6] Boulic R. ; Mas R.; Thalmann, D. "Complex Character Positioning Based on a Compatible Flow Model of Multiple Supports", *IEEE Transactions on Visualization and Computer Graphics*, IEEE TVCG July-September 1997
- [7] Boulic R.; Mas R. ; Thalmann, D. "A Robust Approach for the Control of the Center of Mass with Inverse Kinetics", *Journal of Computer and Graphics*, vol 20-5, Elsevier, Sept-Oct. 1996

-
- [8] Boulic R., Huang Z., Thalmann, D. "A Comparison of Design Strategies for 3D Human Motions" in *Human Comfort and Security of Information Systems ; Advanced Interface for the Information Society*, Varghese and S. Pfleger (Eds), Research Report ESPRIT, ISBN 3-540-62067-2, Springer Verlag Heidelberg, 1997
- [9] Hesse, S; Schauer, M; Jahnke, M T. "Standing-up in healthy subjects: Symmetry of weight distribution and lateral displacement of the centre of mass as related to limb dominance" , *Gait and Posture*, vol. 4 no 4, 1996, pp 287-292
- [10] Shih, C.L.. "Analysis of the Dynamics of a Biped Robot with Seven Degrees of Freedom", *IEEE Int. Conf. on Robotics and Automation*, Minneapolis, USA, April 22-28 1996, pp 3008-3013
- [11] Caron, O; Faure, B; Brenière, Y. "Estimating the centre of gravity of the body on the basis of the centre of pressure in standing posture", *Journal of Biomechanics*, Vol 30, 11-12, pp1169-1171, 1997
- [12] Brenière, Y. "Why We Walk the Way We Do", *Journal of Motor Behavior*, 1996, Vol. 28, No 4, pp 291-298
- [13] Gorce, P; Vanel, O; Ribreau, C. "Equilibrium study of a human robot", *IEEE Int. Conf. on Systems, Man and Cybernetics*, oct 22-25 1995, Vancouver
- [14] Samson, C; Le Borgne, M; Espiau, B. "Robot Control: the Task Function Approach", *Oxford University Press*, 1990
- [15] Espiau, B; El Ali, B. "On the mass center of articulated chains", *6th International Symposium on Advances in Robot Kinematics*, Strobl, Austria, Kluwer, July 1998
- [16] Génot, F; Brogliato, B; Brach, R; Thuilot, B. "On LCPs and tangential impacts in rigid body mechanics with unilateral constraints and dry friction", *IFAC Symposium on Robot Control (SYROCO'97)*, Sept 3-5 1997, Nantes, France, pp 187-196
- [17] Karcnik, T; Kralj, A. "Kinematic Stability in Quadrupedal Locomotion", *6th International Symposium on Advances in Robot Kinematics*, Strobl, Austria, Kluwer, July 1998, pp 543-550
- [18] Baerlocher, P; Boulic, R. "Task Priority Formulations for the Kinematic Control of Highly Redundant Articulated Structures", *IROS'98*, Victoria, Canada, Oct. 13-17, 1998
- [19] Spong, M; Vidyasagar, M. "Robot Dynamics and Control", *Wiley*, 1989
- [20] Lallemand, J.P; Zeghloul, S. "Robotique, aspects fondamentaux", *Masson*, Paris 1994
- [21] Vafa, Z.; Dubowsky, S. "The Kinematics and Dynamics of Space Manipulators: The Virtual Manipulator Approach", *Int. J. of Robotics Research*, Vol 9 no 4, August 1990

A An Algorithm for General Tree-form Chains

1- Attach a number, from $j = 1$ to p , to every terminal link of chain C in the following order: assign no 1 to the longest chain starting from the root. Then, progress in numbering using this rule: do not number a chain as long as if, starting from its terminal leaf, it joins at a node other than the root a strictly longer chain which has not been already numbered.

2- Beginning from $j = 1$, and starting from the end point of each branch, travel up to the origin for constituting simple chains. For that, give a label to each encountered link. When encountering a previously labelled branch (for example the branch l , while going through the chain j at link k_j), set:

$$m_1^j = \dots = m_{k_j}^j = 0 \quad (94)$$

and

$$D_{01}^j = D_{01}^l ; D_{12}^j = D_{12}^l ; \dots ; D_{k_j-1, k_j}^j = D_{k_j-1, k_j}^l \quad (95)$$

which means

$$R_{i, i+1}^l = R_{i, i+1}^j ; t_{i, i+1}^l = t_{i, i+1}^j ; \forall i = 0 \dots k_j - 1 \quad (96)$$

With a correct and natural numbering, we can ensure that $l = j + 1$. We therefore assume in the following that common links have consecutive increasing numbers.

3- Compute, as before, the p equivalent chains, along:

$$\sum_{i=1}^{n_j} \mu_i^j D_{0i}^j A_i^j = D_{0, n_j}^j A_{n_j}^j \quad \forall j = 1 \dots p \quad (97)$$

taking into account (94), but not (95) at this stage. Each chain has a total mass M_j .

We are therefore led back to searching for the equivalence:

$$\sum_{j=1}^p \nu_j D_{0, n_j}^j A_{n_j}^j = \bar{D}_{0n} \bar{A}_n = \bar{R}_{0n} \bar{a}_n + \bar{R}_{0, n-1} \bar{t}_{n-1, n} + \dots + \bar{R}_{01} \bar{t}_{12} + \bar{t}_{01} \quad (98)$$

with ν_j defined as in section 3.2 and n the total number of actual joints, which is now *smaller* than $\sum_{j=1}^p n_j$. Recall that we have (equation (25)):

$$\nu_j D_{0, n_j}^j A_{n_j}^j = R_{0, n_j}^j \nu_j a^{1j} + R_{0, n_j-1}^j \nu_j t^{1j}_{n_j-1, n_j} + \dots + R_{0, 1}^j \nu_j t^{1j}_{12} + \nu_j t^{1j}_{01} \quad \forall j = 1 \dots p \quad (99)$$

4- The LHS of (98) can also be written as

$$\sum_{j=1}^p r^{jT} v^j, \quad (100)$$

where

$$r^{jT} = \left(I_3 \ R_{01}^j \ \cdots \ R_{0n_j}^j \right) \quad (101)$$

and

$$v^{jT} = \nu_j \left(t_{01}^{j1} \ t_{12}^{j2} \ \cdots \ t_{n_j-1, n_j}^{jn_j} \ a^{j1} \right) \quad (102)$$

From the lines r^{jT} , $j = 1 \cdots p$, form a matrix/table like the example shown below.

I_3	R_{01}^1	R_{02}^1	$R_{0n_1}^1$	-	-
I_3	R_{01}^2	R_{02}^2	R_{03}^1	$R_{0n_2}^2$	-
I_3	R_{01}^3	$R_{0n_3}^3$	-	-	-
...
I_3	R_{01}^p	R_{02}^p	$R_{0n_p}^p$	-	-

5- Use equations (96) to factorize the terms having equal rotation matrices. Eq. (96) and the numbering assumption imply that for some values of j :

$$R_{0, i+1}^{j+1} = R_{0, i+1}^j ; \quad \forall i = 0 \cdots k_j - 1 \quad (103)$$

Now, starting from $j = 1$ and for all j :

- When the equalities occur, replace in the table the subcolumns $\begin{pmatrix} R_{0, i+1}^j \\ R_{0, i+1}^{j+1} \end{pmatrix}$ by $\begin{pmatrix} R_{0, i+1}^j \\ - \end{pmatrix}$ for $i = 0 \cdots k_j - 1$
- Simultaneously, replace the entries $v^j(i)$ of v^j (which was $\nu_j t_{i+1, i+2}^{j1}$) by $\nu_j t_{i+1, i+2}^{jj} + \nu_{j+1} t_{i+1, i+2}^{(j+1)1}$, and $v^{j+1}(i)$ by zero, for $i = 0 \cdots k_j - 1$.
- When needed, use the trivial transitivity property

$$R_{0, i+1}^{j+1} = R_{0, i+1}^j ; \quad R_{0, i+1}^{j+2} = R_{0, i+1}^{j+1} \Rightarrow R_{0, i+1}^{j+2} = R_{0, i+1}^j \quad (104)$$

to skip the empty entries ("-") in the table.

Let us come back to the example of the table above and suppose, as in figure 7.:

$k_2 = 2$; $k_3 = 1$; $k_4 = \cdots = k_p = 0$.

The transformed table is then:

while the v^j s are replaced by the w^j s:

$$w^{1T} = \left(\sum_{j=1}^p \nu_j t_{01}^{jj} , \nu_1 t_{12}^{11} + \nu_2 t_{12}^{22} + \nu_3 t_{12}^{33} , \nu_1 t_{23}^{11} + \nu_2 t_{23}^{22} , \nu_1 t_{34}^{11} , \cdots , \nu_1 t_{n_1-1, n_1}^{11} , \nu_1 a_1' \right) \quad (105)$$

I_3	R_{01}^1	R_{02}^1	$R_{0n_1}^1$	-	-
-	-	-	R_{03}^2	$R_{0n_2}^2$	-
-	-	R_{02}^3	...	$R_{0n_3}^3$	-	-	-
...
-	R_{01}^p	R_{02}^p	$R_{0n_p}^p$	-	-

$$w^{2T} = (0, 0, 0, \nu_2 t_{34}^{t_2}, \dots, \nu_2 t_{n_2-1, n_2}^{t_2}, \nu_2 a_2') \quad (106)$$

$$w^{3T} = (0, 0, \nu_3 t_{23}^{t_3}, \dots, \nu_3 t_{n_3-1, n_3}^{t_3}, \nu_3 a_3') \quad (107)$$

$$w^{pT} = (0, \nu_p t_{12}^{t_p}, \dots, \nu_p t_{n_p-1, n_p}^{t_p}, \nu_p a_p') \quad (108)$$

6- The sum (100) can now be written $\sum_{j=1}^p s_j^T w^j$. Each line s_j has n'_j nonzero terms (non including the I_3 in the first line), with $\sum_{j=1}^p n'_j = n$ and $n'_1 = n_1$. We can therefore identify the terms of equation (98) line by line, as done in the case of the star-form chain.

We have therefore:

$$\bar{t}_{01} = \sum_{j=1}^p \nu_j t_{01}^{t_j} \quad (109)$$

and, for $j = 1$,

$$\bar{R}_{0i} = R_{0i}^1, \bar{t}_{i, i+1} = w^1(i+1), i = 1 \dots n'_1 \quad (110)$$

Therefore

$$\bar{R}_{i-1, i} = R_{i-1, i}^1, i = 1 \dots n'_1 \quad (111)$$

This gives in our example:

$$\bar{R}_{01} = R_{01}^1, \bar{t}_{12} = \nu_1 t_{12}^{t_1} + \nu_2 t_{12}^{t_2} + \nu_3 t_{12}^{t_3} \quad (112)$$

$$\bar{R}_{02} = R_{02}^1, \bar{t}_{23} = \nu_1 t_{23}^{t_1} + \nu_2 t_{23}^{t_2} \quad (113)$$

up to

$$\bar{R}_{0n'_1} = R_{0n'_1}^1, \bar{t}_{n'_1, n'_1+1} = \nu_1 a_1' \quad (114)$$

Then, for line 2, always in the example:

$$\bar{R}_{0n'_1+1} = R_{03}^2, \bar{t}_{n'_1+1, n'_1+2} = \nu_2 t_{34}^{t_2} \quad (115)$$

That is to say:

$$\bar{R}_{n'_1, n'_1+1} = (R_{0n'_1}^1)^{-1} R_{03}^2 \quad (116)$$

Then,

$$\bar{R}_{0n'_1+2} = R_{04}^2, \bar{t}_{n'_1+2, n'_1+3} = \nu_2 t_{45}^{t_2} \quad (117)$$

which leads to

$$\bar{R}_{n'_1+1, n'_1+2} = (\bar{R}_{0n'_1+1})^{-1} R_{04}^2 = R_{34}^2 \quad (118)$$

continuing to

$$\bar{R}_{n'_1+n'_2-1, n'_1+n'_2} = R_{n'_2-1, n'_2}^2, \quad \bar{t}_{n'_1+n'_2, n'_1+n'_2+1} = \nu_2 a'_2 \quad (119)$$

And so on up to $j = p$.



Unit ´e de recherche INRIA Lorraine, Technople de Nancy-Brabois, Campus scientifique,
615 rue du Jardin Botanique, BP 101, 54600 VILLERS LÈS NANCY
Unit ´e de recherche INRIA Rennes, Irisa, Campus universitaire de Beaulieu, 35042 RENNES Cedex
Unit ´e de recherche INRIA Rhne-Alpes, 655, avenue de l'Europe, 38330 MONTBONNOT ST MARTIN
Unit ´e de recherche INRIA Rocquencourt, Domaine de Voluceau, Rocquencourt, BP 105, 78153 LE CHESNAY Cedex
Unit ´e de recherche INRIA Sophia-Antipolis, 2004 route des Lucioles, BP 93, 06902 SOPHIA-ANTIPOLIS Cedex

diteur
INRIA, Domaine de Voluceau, Rocquencourt, BP 105, 78153 LE CHESNAY Cedex (France)
<http://www.inria.fr>
ISSN 0249-6399