



**HAL**  
open science

## An Efficient Simulation Model for Wireless LANs Applied to the IEEE 802.11 Standard

Paul Mühlethaler, Najid Abdellah

► **To cite this version:**

Paul Mühlethaler, Najid Abdellah. An Efficient Simulation Model for Wireless LANs Applied to the IEEE 802.11 Standard. [Research Report] RR-4182, INRIA. 2001. inria-00072441

**HAL Id: inria-00072441**

**<https://inria.hal.science/inria-00072441>**

Submitted on 24 May 2006

**HAL** is a multi-disciplinary open access archive for the deposit and dissemination of scientific research documents, whether they are published or not. The documents may come from teaching and research institutions in France or abroad, or from public or private research centers.

L'archive ouverte pluridisciplinaire **HAL**, est destinée au dépôt et à la diffusion de documents scientifiques de niveau recherche, publiés ou non, émanant des établissements d'enseignement et de recherche français ou étrangers, des laboratoires publics ou privés.

*An efficient simulation model for wireless LANs  
applied to the IEEE 802.11 standard*

Paul Mühlethaler , Abdellah Najid

**No 4182**

Avril 2001

————— THÈME 1 —————



*Rapport  
de recherche*



## An efficient simulation model for wireless LANs applied to the IEEE 802.11 standard

Paul Mühlethaler , Abdellah Najid

Thème 1 — Réseaux et systèmes  
Projet HIPERCOM

Rapport de recherche n° 4182 — Avril 2001 — 25 pages

**Abstract:** In this research report, we propose a simple simulation model for wireless LANs. In wireless LANs, in contrast to wired LANs, different transmission results can be observed by network nodes. This phenomenon is the result of radio propagation laws where the signal decay is far greater than on cables. This leads to new and interesting modeling and simulation problems. In this article we propose a simple but general physical model to take into account radio propagation. We then apply this model to the study of the IEEE 802.11 standard. We show how IEEE 802.11 can be efficiently modeled and simulated. This allows us to offer a detailed study of the standard. We give performance evaluations of the IEEE 802.11 DS standard with a transmission rate of 1, 2, 5.5 or 11 Mbit/s which take into account the exact protocol overhead. We also study special behaviour such as broadcast transmission, performance with hidden nodes, spatial reuse.

**Key-words:** Wireless Local Area Network, IEEE 802.11 standard, Ethernet, performance evaluation, hidden nodes, spatial reuse.

*(Résumé : tsvp)*

## Un modèle de simulation efficace pour réseau local sans fil appliqué à la norme IEEE 802.11

**Résumé :** Dans ce rapport de recherche, nous proposons un modèle de simulation simple pour réseau local sans fil. Dans les réseaux locaux sans fil, contrairement aux réseaux locaux filaires, des résultats de transmission différents peuvent être vus par les noeuds du réseaux. Ce phénomène est le résultat des lois de la propagation radio où la décroissance du signal est bien plus importante que sur un câble. Ceci conduit à des problèmes de modélisation et de simulation nouveaux et intéressants. Dans cet article nous proposons un modèle physique simple mais général pour prendre en compte la propagation radio. Nous appliquons ensuite ce modèle à l'étude de la norme IEEE 802.11. Nous montrons comment le standard IEEE 802.11 peut être modélisé et simulé. Cela nous permet d'offrir une étude détaillée du standard. Nous donnons des évaluations de performance du standard IEEE 802.11 DS avec un débit de transmission de 1, 2, 5.5 ou 11 Mbits/s et qui prennent en compte "l'overhead" exact du protocole. Nous donnons aussi une étude spéciale du comportement de la transmission en diffusion et des performances avec des noeuds cachés.

**Mots-clé :** Réseaux locaux sans fil, standard IEEE 802.11, Ethernet, évaluation de performance, noeuds cachés, réutilisation spatiale.

## 1 Introduction

Simulations for LANs were extensively presented in numerous papers in the 80s with the emergence of widely accepted standards such as Ethernet [4] or Token Ring [5]. The late 90s saw the emergence of a lot of standardization work for wireless LANs e.g. IEEE 802.11 [2], HiPERLAN [1], bluetooth, etc. This opened up new business opportunities as at the same time, wireless LANs raised new technical problems. At the medium access level, the main difference between LANs and wireless LANs lies in the fact that in LANs one usually has an atomic view of an event. This is not the same in wireless LANs due to the propagation effect. This leads to a few known behaviours such as hidden nodes, capture effect or spatial reuse. See figure 1.

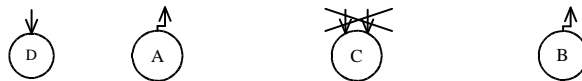

Figure 1: Nodes A and B are simultaneously transmitting a packet. Node C is not able to decode either packet sent by A or B while node D receives correctly the packet sent by node A.

The first effect is usually considered negative for the network performance whereas the last two are usually presented in positive way. However all these phenomena are due to the same reason which is the high propagation decay of radio signals. In this paper, we give a simple but general model to take into account these effects and the behaviour of CSMA (Carrier Sense Multiple Access) techniques. Then, we show how the access scheme of the IEEE 802.11 can be modeled both precisely but also simply and efficiently. In fact it is planned to use this model to simulate ad-hoc networks and therefore the MAC and physical layer must be efficiently implemented in order to simulate complex scenarios over a reasonable duration. This paper is organized as follows; the next section describes the model of the physical layer. Section 3 first recalls the IEEE 802.11 access technique and then describes the model used to simulate this access protocol. Section 4 presents simulation results.

This section begins by a detailed analysis of the IEEE 802.11 standard. Then the section gives performance evaluations of the IEEE 802.11 DS standard with a datarate of 1, 2, 5.5, 11 Mbit/s. We also study special behaviour such as broadcast transmission, performance with hidden nodes, spatial reuse.

## 2 Model for the physical layer

### 2.1 Linearity and propagation law

The main assumption of this paper is that we have a linear superposition of signals sent by potential transmitters. This model naturally leads to introducing a transmission matrix  $cs_{i,j}$  which gives the strength of the signal sent by node  $j$  to node  $i$ . The signal strength  $Pow(i)$  received by node  $i$  is therefore

$$Pow(i) = \sum_{j=1}^n a_j cs_{i,j}$$

where  $a_j = 1$  if node  $j$  is transmitting or  $a_j = 0$  otherwise.

Simple propagation laws of radio signals usually have the following expression

$$cs_{i,j} = \frac{P_j}{r_{i,j}^\alpha}$$

where

- $P_j$  denotes the power sent by node  $j$
- $r_{ij}$  denotes the distance between node  $i$  and node  $j$
- $\alpha$  denotes the signal decay, usually  $2 \leq \alpha \leq 4$ .

Of course this is an approximate model. However it should be noted that the only important assumption is the linearity of the model. We can actually use this linear model with all existing propagation models or pre-computed figures. All we will need is the transmission matrix  $cs_{i,j}$ .

## 2.2 Carrier sensing and reception

We now need to introduce the carrier sensing parameter. This parameter is a threshold above which the channel is assumed to be busy. In a CSMA protocol this threshold makes it possible to decide whether the channel is idle or busy. We will call this parameter the *carriersenselevel*.

In the previous section, we introduced the physical transmission model. Actually we need extra conditions to ensure the correct receptions of packets.

We will assume that a packet sent by node  $i$  to node  $j$  in the transmission interval  $[t_b, t_e]$  is correctly received by node  $j$  if

- $\forall t \in [t_b, t_e] \quad cs_{i,j}(t) \geq datalevel$
- $\forall t \in [t_b, t_e] \quad \frac{cs_{i,j}(t)}{\sum_{k \neq j} a_k(t) cs_{i,k}(t)} \geq capturelevel$

We have introduced two parameters : the "*datalevel*" and the "*capturelevel*". The "*datalevel*" corresponds to the signal strength necessary to successfully transmit a signal. The "*capturelevel*" corresponds to the minimum of value of a signal to noise ratio to successfully decode a transmission.

Actually, we will add an extra condition. We will assume that a correct reception can only start when a node receives a signal strength less than the carrier-sense level. This assumption implies that a correct transmission can not start during a bad transmission. But conversely it is possible that a correct transmission starts and is corrupted by a new starting collision. If the second transmission starts significantly later than the first transmission then one usually calls this collision a late collision. In the case of correct operation of the carrier sensing, this can only occur with hidden node.

## 3 Model for the Medium Access Layer

### 3.1 The IEEE 802.11 MAC scheme

#### 3.1.1 A CSMA technique

In this part, we will not address the centralized access mode called CF ( Centralized coordination Function) of the IEEE 802.11 standard. We will only



deal with the distributed access scheme which, in the standard, is called the DCF (Distributed Coordination Function). This scheme is primarily based on a CSMA (Carrier Sense Multiple Access) scheme. The main principle of this access technique is a preventive listening of the channel to be sure that no other transmission is on the way before transmitting its packet. If the sensing of the channel indicates an ongoing transmission then the node waiting to start its transmission draws a random back-off delay. At the end of the outgoing transmission this back-off will be decremented whenever the channel is free (no carrier sensed). The node starts its transmission when its back-off delay reaches 0. This mechanism is presented in figure 2. Nodes B and C receive a new packet to transmit while node A is transmitting. Node C draws the smallest back-off delay. The backoff delay of node C is decremented after the end of the transmission of node A. When the backoff delay of C expires, node C starts transmitting. After the end of C's transmission, B carries on decrementing its remaining back-off delay. When this back-off delay reaches 0, B starts transmitting. This scheme has often been called CSMA/CA where CA stands for Collision Avoidance. In fact, this terminology is quite approximate. It can be noticed however that this back-off strategy differs from the Ethernet strategy where the events on the channel are not taken into account to decrement the back-off delay; of the course when the channel is still busy at the end of the backoff time the transmission attempt is made at the end of the carrier (1 persistence). Experts in medium access technique will identify a "tree" algorithm in the IEEE 802.11 CSMA/CA scheme. Indeed this protocol can be implemented with a collision counter and this counter is decremented on idle slots as is done for a "tree" or "stack" algorithm [6].

### **3.1.2 The MAC acknowledgement**

With radio signals, it is not possible to directly detect collisions in a radio network. Indeed, it is not possible to listen to alien transmission while actually transmitting. Packet collisions must therefore be detected by another means. The IEEE 802.11 standard uses an acknowledgement for a point to point packet, broadcast packets are not acknowledged. This acknowledgement packet is sent by the receiver just after reception of the packet. The interframe between a packet and its acknowledgement (SIFS short interframe spacing) is

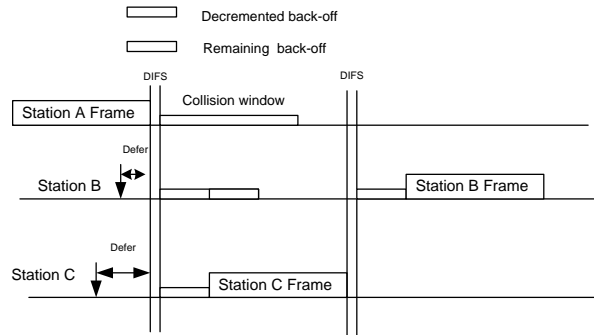

Figure 2: The IEEE 802.11 backoff mechanism

shorter than between the end of a transmission and a packet (DIFS distributed interframe spacing). Therefore, the transmission of the acknowledgement will precede any other transmission attempt. Figure 3 shows how the acknowledgement works in the IEEE 802.11 standard.

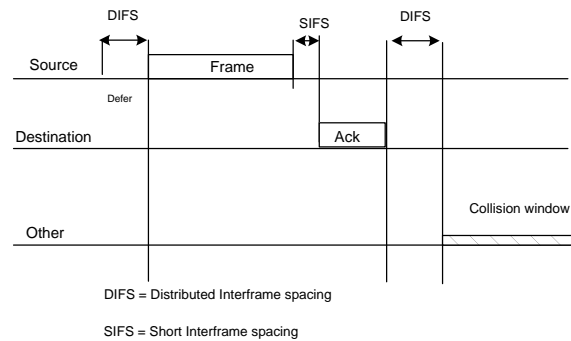

Figure 3: The IEEE 802.11 acknowledgement mechanism

### 3.1.3 The RTS/CTS and the NAV

In the previous subsection we have shown that it is impossible to directly detect collisions in wireless LANs. Therefore when a collision occurs, the whole packet duration is lost. This reduces performances both in terms of achievable

throughput and in delays. The RTS/CTS can cope with this problem. In this scheme, an RTS packet (Request To Send) is addressed by the source to the destination which, if the RTS has been well received responds with a CTS packet (Clear To Send). If the source receives correctly the CTS packet, it will then transmit its packet to the destination. It is clear that effect of a collision is reduced with this mechanism since for a collision only the RTS/CTS time is used. Moreover the RTS/CTS also has a very interesting effect on hidden nodes. This effect is obtained via the extra NAV (Network Allocation Vector) mechanism. Indeed the RTS and CTS packets hold the forthcoming transmission duration in the NAV field, see figure 4. The RTS is therefore indicating to the source neighbors the duration of the transmission. This is of course interesting but in most cases this indication is indirectly available to the source's neighbors via the carrier sense. More interesting is certainly the effect of the CTS. All the destination's neighbors will then be aware of the forthcoming transmission duration. Some of them may be out of carrier sense reach from the source node ; these nodes are potentially hidden nodes. Their possible transmissions are controlled by the NAV in the CTS, see figure 4.

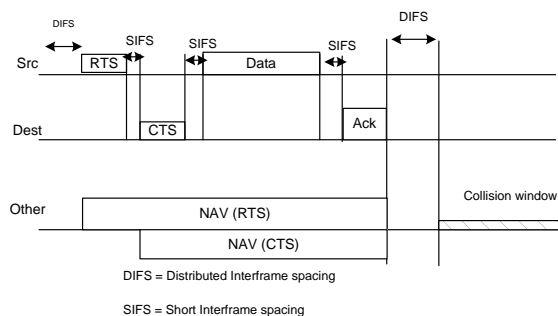

Figure 4: RTS- CTS scheme and Network Allocation Vector

## 3.2 An optimized IEEE 802.11 MAC model

### 3.2.1 Generalities

In the following we will describe an optimized model for the IEEE 802.11 MAC scheme. This optimization will try to maximize the speed of the simulation and

will sometimes lead to a slight simplification or approximation in the modeling. Of course, the speed of a simulation is proportional to the number of events generated in a simulation. Therefore, in the following the number of simulation events used will be of prime importance. We will try, as far as possible, to minimize this figure, which sometimes leads to slight approximations. All these approximations will be justified and discussed.

### 3.2.2 Simulation of collision

In a CSMA system the a collision can occur in the two following situations:

- two transmissions start approximately at the same time thus the transmission of the other node has not yet been sensed due to propagation delay and to electronic detection delays<sup>1</sup>, this situation is usually called a collision.
- two nodes are hidden from each other and so carrier sensing does not operate between these nodes, a collision can occur at any time during the life time of the packet. This situation is usually called “hidden node collision” or “late” collision.

Actually simulating collision is not difficult since the simulator will rule the transmission according to the carrier sense indication exactly as in a real network. However, the simulation of the collision generally uses a usual technique often called the “collision window” technique. To take into account propagation and electronic detection delay we will need to distinguish the starting transmission time at the source and the time when the reception starts in receivers. This will require creating two different events: one event at the transmitter and one event within all the potential receivers to indicate the start of effective reception of the transmission. This latter event is called the “start of carrier”. The time interval between these two events is often called the collision window, see figure 8. Indeed, it is in this window that starting an alien transmission will create a collision.

Of course a possible optimization could be not to send the event “start of carrier” to distant nodes, as this event has no effect on distant nodes. But

---

<sup>1</sup>In networks of few hundred meters of average size, the electronic detection delays lead to the predominant factor

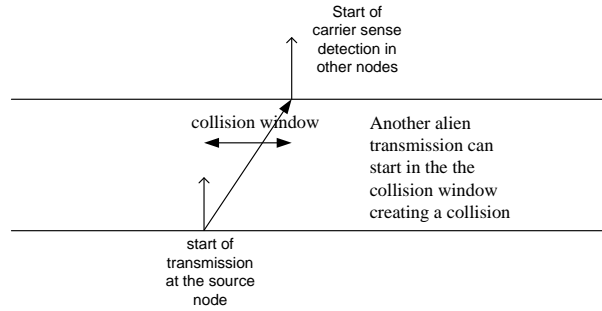

Figure 5: Collision window.

implementing this optimization is not easy especially in a network with mobile nodes. Therefore this optimization will not be used in the model presented.

### 3.2.3 Simulation of the back-off

We have already seen that the IEEE 802.11 back-off is slightly peculiar. Indeed, it requires that during this backoff period the nodes constantly monitor the channel to sense the carrier activity. In the standard the backoff is a multiple number of slots (actually called collision slots). A direct monitoring of the channel leads to scheduling an event for every collision slot. Of course, this approach is not efficient since it leads to the creation of a lot of unnecessary events. This can be avoided if we are able to destroy events. In this case all nodes will schedule its “end of backoff” event. When the closest “end of backoff” comes to be treated, the carrier sense reception by the the nodes currently in backoff leads these nodes to stop their back-off decrementation and to register their remaining backoff duration. The carrier sense returning to idle allows these nodes to reschedule their end of backoff event with the remaining backoff duration. (See figure 6). This simulation technique allows an exact description of the backoff scheme while it significantly reduces the number of simulation events.

### 3.2.4 Simulation of the acknowledgement

A transmission without acknowledgement requires two events:

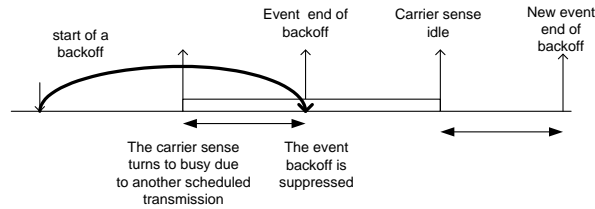

Figure 6: Simulation of the CSMA/CA backoff.

- the end of a backoff when the node starts transmitting,
- the end of a transmission.

A transmission with acknowledgement requires four events:

- start of the transmission at the end of a backoff,
- end of a transmission,
- start of the acknowledgement transmission,
- end of the acknowledgement transmission.

Therefore, roughly speaking, the acknowledgement doubles the required number of events for a transmission. There is a means to simulate the acknowledgement with only two events as shown in figure 7. The frame duration is increased by the acknowledgement duration. Here, there is of course a slight approximation since the carrier activity is slightly different, however this effect is very limited since the acknowledgement duration is small. There is another effect in the possible collision of the acknowledgement packet. But for the same reason this event is very unlikely and is necessarily created by a hidden node. On the other hand the simulation model will take into account a collision on the destination during the acknowledgement. This collision will also be produced by a hidden node. The real scheme and the simulation model will therefore show very similar performances.

There is another important “trick” that is worth mentioning concerning the simulation of the acknowledgement. With the proposed model we do not have the “real acknowledgement” to detect collision. We therefore need to “visit”

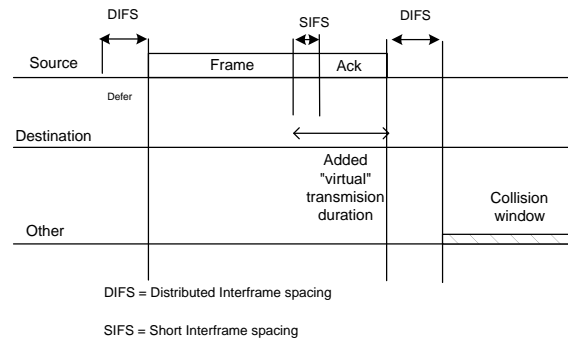

Figure 7: Simulation model for the acknowledgement.

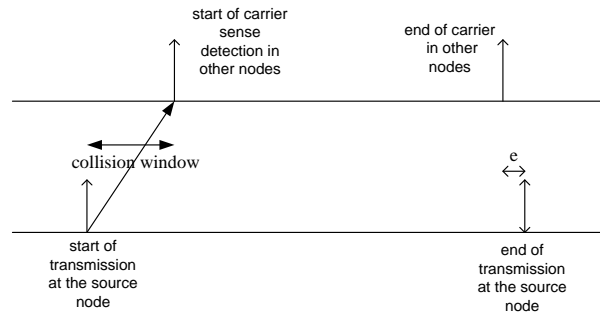

Figure 8: Collision detection in the simulation

the reception node just before ending the transmission to check whether the transmission is a success or a collision. That is why, in the simulation model, we have scheduled the end of the transmission  $e$  bits before the end of the transmission ;  $e$  must be small and we have taken  $e = 1$ , see 8

### 3.2.5 Simulation of the RTS/CTS

In the RTS/CTS scheme we have the following events:

- start of the RTS transmission at the end of a backoff,
- end of RTS transmission,

- start of the CTS transmission,
- end of the CTS transmission
- start of the frame transmission,
- end of transmission,
- start of the transmission of the acknowledgement,
- end of the transmission of the acknowledgement.

Thus a complete transmission process costs eight events. Actually as seen in the previous subsection it is possible to ignore the two events related to the transmission of the acknowledgement. There remain six events for the complete transmission process and we can reduce this number to three.

Let us consider the following events:

- start of the RTS transmission,
- end of the RTS transmission, depending on the correct reception of the RTS by the destination, this event is or is not followed by the “full” transmission of the frame (CTS + frame + Ack),
- the end of the transmission (only applicable if a transmission has started!).

The model is described in figure 9. When there is no collision on the RTS, the CTS, the transmission of the frame and the acknowledgement are concatenated. If there is a collision for the RTS the transmission is stopped. In the simulation code at the end of the RTS transmission, we must visit the destination to see if the RTS has been correctly received. If so, we must inform the neighbors of the receiver of the forthcoming transmission duration to simulate the NAV effect. We can see that the main difference between the real IEEE 802.11 operation and the proposed simulation model lies in the fact the CTS transmission is, in the simulation model, supposed to be transmitted by the source whereas in reality it is transmitted by the destination. Thus, in principle, the simulation model does take into account the collision on the CTS. But with correct operation this situation is not possible or very unlikely.



A potential collider on the CTS must be within reach of the sender. But in such a case the RTS should have been received by this collider and the collider should be informed of the forthcoming transmission activity.

We can implement this model by using the event “end of RTS”. We have to visit first the destination to check if the RTS has been correctly received. If so, the transmission is continued if not; the transmission is stopped. We have to visit the event “end of RTS” at the source to apply the transmission decision. Therefore it is sensible to schedule the end of the RTS 1 bit earlier at the destination node than at the source node.

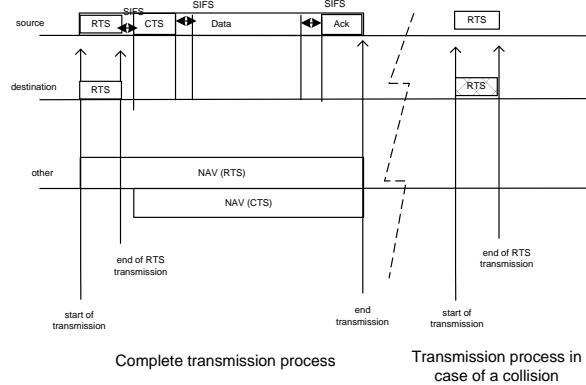

Figure 9: Simulation model for the acknowledgement.

### 3.2.6 Reception engine

The reception engine uses a three-state automaton. These three states are:

- “idle”, there is no carrier detected
- “carrier” , a carrier is detected but a comprehensive packet can not be decoded,
- “reception” a comprehensive packet is received.

The transitions between these states are simple and can only occur at the beginning of a transmission ; this helps to avoid unnecessary events.

### 3.2.7 The OPNET simulation tool

The OPNET simulation tool is one of the most widespread tools. This tool provides the following services:

- a scheduler,
- an easy way to code state automaton,
- a very powerful graphic interface to present simulation results.

OPNET also contains a lot of codes dedicated to simulating radio links, access protocols and various protocol layers. We have tried to use these codes but they resulted in simulations which were long in duration. Since the speed of our simulation was of prime importance to us, we decided not to use any of these facilities.

## 4 Simulation results

### 4.1 IEEE 802.11 figures

In figure 10, we show the structure of an IEEE 802.11DS packet at the physical layer. The physical layer encapsulation has a duration of  $192\mu s$ . In table 1 we give the duration of various IEEE 802.11 attributes. These durations allow us to compute the overhead which, in duration, slightly depends on the bandwidth due to the 34 octets of the MAC overhead. The IEEE 802.11 DS overheads are given in table 2. The following simulation results will take these overheads into account. The offered load will therefore be the payload i.e. the load of useful data. We will be able to offer a precise performance evaluation of the IEEE 802.11 DS standard.

IEEE attribute	Duration in $\mu s$
DIFS	50
slot time	20
SIFS	10
Phy overhead	192
MAC overhead	34 octets
Acknowledgement	304 at 1 Mbps

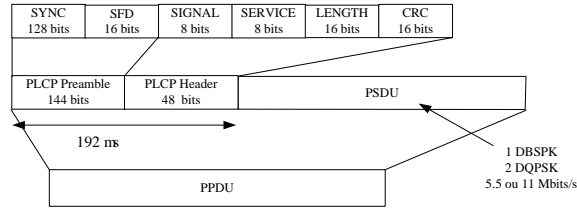

Figure 10: Structure of a IEEE 802.11 packet

Table 1: Main IEEE 802.11 figures

Air rate	Duration in $\mu s$
1 Mbps	778
2 Mbps	642
5.5 Mbps	555
11 Mbps	530

Table 2: IEEE 802.11 overheads

## 4.2 IEEE 802.11 performance analysis with various traffic scenarios

### 4.2.1 Simple scenarios

All the nodes are within range. We suppose that we have 2,5,10,15 or 20 nodes with various data rates: 1Mbps, 2 Mbps, 5.5 Mbps and 11 Mbps. We generate a traffic with large packets :12000 bits and we test the network with a load ranging from 10% to 100% of the channel capacity by steps of 10%. We do not use the RTS/CTS option. The result of this simulation allows us to find out the maximum channel capacity of the IEEE 802.11 standard. The results are given in figures 11,12,13. As expected, we can see that the channel throughput decreases as the number of nodes increases. That is a general result of the CSMA scheme. We can also see that the normalized channel throughput decreases as data transmission rate increases. This phenomenon can be explained by the fixed overhead in the frame and also because the normalized size of collision window by the frame transmission duration increases, (see the analytical model provided below).

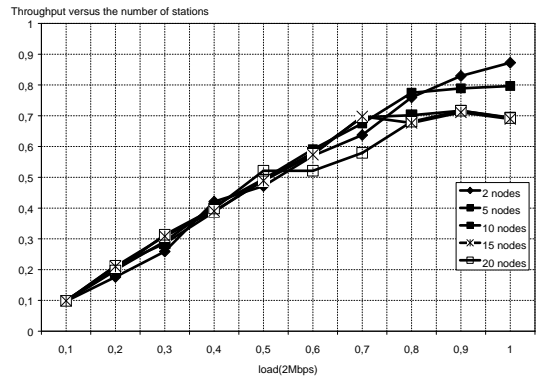

Figure 11: Results of IEEE 802.11 DS at 2 Mbits/s.

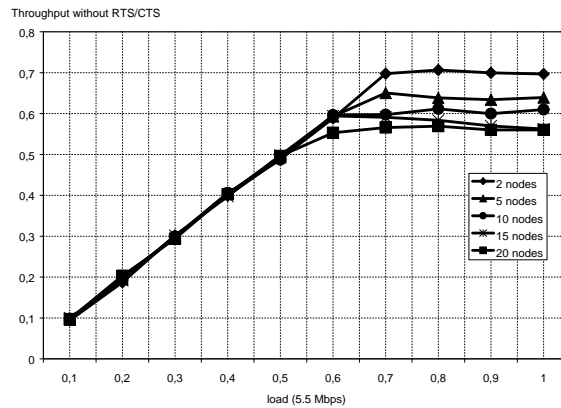

Figure 12: Results of IEEE 802.11 at 5.5 Mbits/s.

To investigate the effect of the RTS/CTS option on the achievable throughput the same simulations as those above were carried out with this option. Figure 14, gives the simulation results at 1 Mbits/s with 20 nodes with and without RTS/CTS. We then investigate at 11 Mbits/s with and without RTS/CTS, the results are given in figure15.

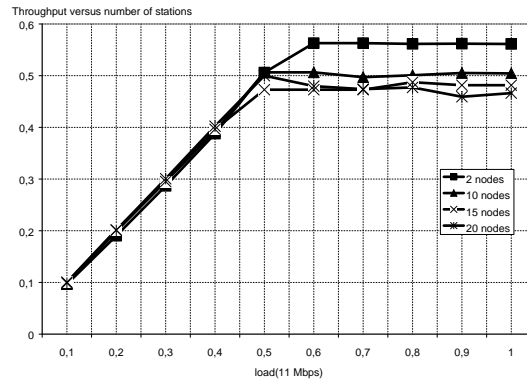

Figure 13: Results of IEEE 802.11 at 11 Mbits/s.

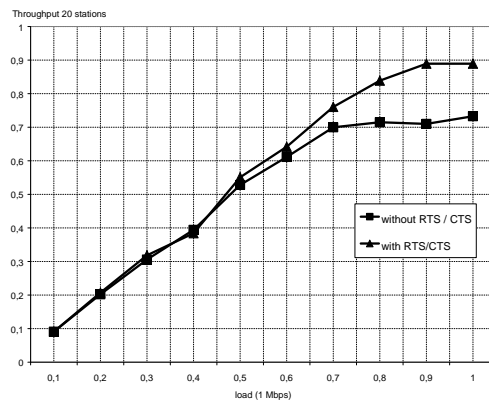

Figure 14: Results of IEEE 802.11 with the RTS/CTS and 20 stations at 1 Mbits/s.

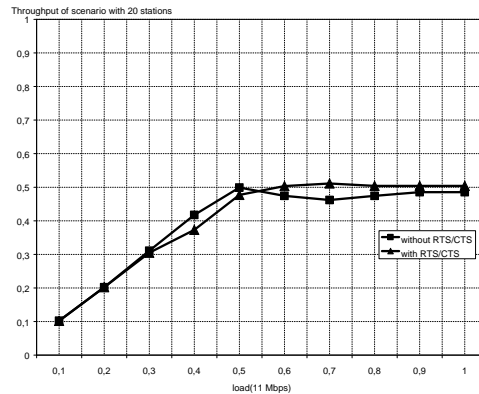

Figure 15: Results of IEEE 802.11 with the RTS/CTS and 20 stations and at 11 Mbit/s.

#### 4.2.2 Scenarios with broadcast

We next focus on the broadcast issue. We have studied the scenario where all the nodes send a broadcast traffic and we investigated the success rate. We present the results with 10 stations sending broadcast packets of 2000 bits. The simulation results show that the collision rate is more than 10% for a load greater than 50% of the channel capacity. This bad performance for broadcast traffic is an issue for the IEEE 802.11 standard.

We also studied the scenario where all the nodes send a broadcast traffic and we investigate the collision rate. We present the results with 10 stations sending broadcast packets of 2000 bits. The simulations show that the collision rate for the broadcast traffic can be quite high. Actually in all of the scenarios mentioned above we experienced collision rates greater than 15

#### 4.2.3 Scenario with hidden nodes

We investigate the utilization of RTS/CTS in the case of hidden nodes. In the following scenario four stations are placed at the corner of a square 40 m x 40

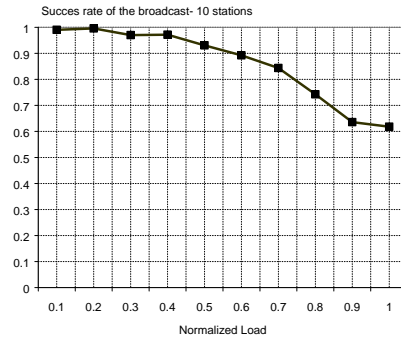

Figure 16: Percentage of received broadcast with 10 stations sending 2kbits packets

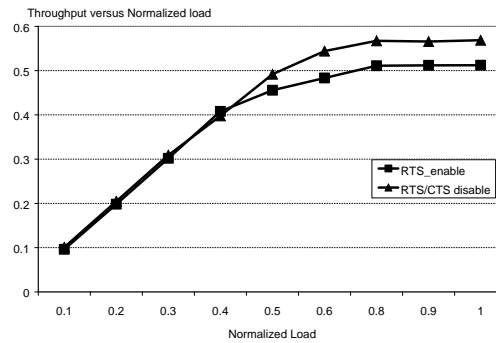

Figure 17: Channel throughput with 4 stations with hidden nodes at 2 Mbits/s

m. Two nodes, node 1 and 2, are not within carrier sense reach; for instance there is a steel obstacle between the two nodes. Therefore node 1 and 2 are hidden from each other and can create hidden collisions. The transmission rate of this scenario is 2 Mbits/s. The simulation results show that at high load the RTS/CTS scheme can save around 10 % of the channel capacity. We could expect this result since the NAV mechanism can save bandwidth.

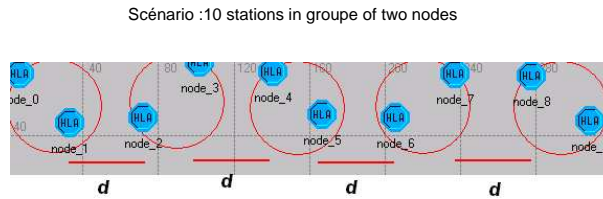

Figure 18: Scenario of spatial reuse with ten stations in 5 groups of 2 nodes

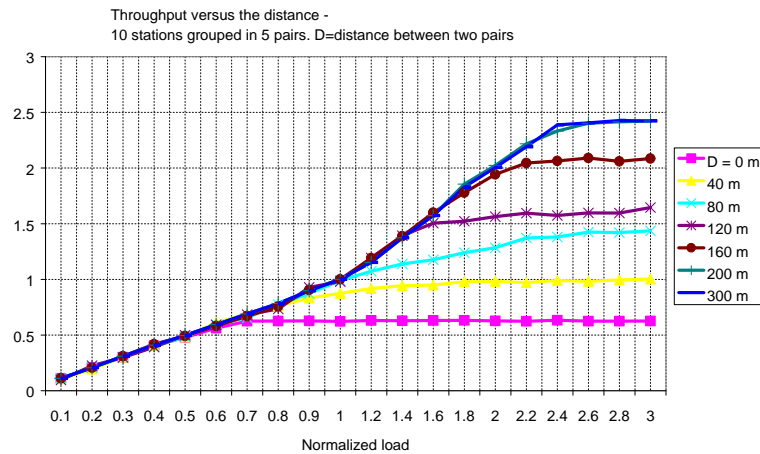

Figure 19: Channel throughput with ten stations in 5 groups of 2 nodes versus the distance between the group of nodes

#### 4.2.4 Scenarios with spatial reuse

In the following sections, we will study scenarios involving spatial reuse. The scenarios proposed uses 10 stations which are divided into 5 groups of two stations. This scenario configuration is shown in figure 18. The 5 groups of two stations are separated by a distance of  $D$  meters. We study the total throughput of the network versus the distance  $D$  and we use the RTS/CTS. The simulation results are given in figure 19. Of course as  $D$  increases the total throughput increases since the 5 groups tend to be more independent. The results given in figure 19 are coherent with the results in figure 15. As a matter of fact when the 5 groups are independent we find a throughput five time greater than the throughput of a single group.



### 4.3 Comparison of simulation results with a simple analytical model

In this part our aim is to compare the results of a simple analytical model with the simulation results. We use a classical model of CSMA which can be found in [7]. The assumptions of this model are the following:

- the packet has a duration of 1,
- $\beta$  is the duration of the collision window,
- $\lambda$  is the Poisson arrival rate,
- the number of stations in backoff is  $n$ ,
- $q_r$  is the retransmission probability.

With these assumptions it is possible to study the variation in the number of waiting stations. Let us denote by  $D_n$  the drift of this number of waiting stations.  $D_n$  can be computed as the difference between the expectation of arriving stations in backoff minus the expectation of a successful transmission. It can be shown that

$$D_n = \lambda(\beta + 1 + e^{-g(n)}) - g(n)e^{-g(n)}$$

where

$$g(n) = \lambda\beta + q_r n.$$

The protocol is stable if the drift is negative, in which case we have:

$$\lambda < \frac{g(n)e^{-g(n)}}{\beta + 1 + e^{-g(n)}}$$

It can be easily derived that maximum channel efficiency is obtained with  $g(n) = \sqrt{2\beta}$ . The obtained value of the channel efficiency is then:

$$g(n) = \frac{1}{1 + \sqrt{2\beta}}.$$

To use this simple model we have now to compute the value of  $\beta$  corresponding to our simulated scenarios.  $\beta$  measures the value of the collision window given that the transmission duration is 1. Therefore at 11Mbps/s with a collision slot of 20 $\mu$ s with a packet length of 12000 bits and taking into account the propagation delay,

$$\beta = \frac{20}{530 + \frac{12000}{11}} = 0.01233$$

We can build table 3 which gives the maximum channel efficiency versus the data rate.

Air rate	$\frac{1}{1+\sqrt{2\beta}}$
1 Mbps	0.968
2 Mbps	0.927
5.5 Mbps	0.892
11 Mbps	0.864

Table 3: maximum channel capacity

Table 4 shows the results of computing the overhead factor for 12000 bits packets *i.e.* the fixed overhead due to the IEEE 802.11 overhead.

Air rate	overhead factor
1 Mbps	0.939
2 Mbps	0.903
5.5 Mbps	0.797
11 Mbps	0.673

Table 4: transmission overhead

In a simple approximation the channel throughput that we have measured is equal to the product of the maximum channel efficiency by the overhead factor. We obtain the following results given in table 5.

Air rate	maximum normalized throughput
1 Mbps	0.91
2 Mbps	0.84
5.5 Mbps	0.710
11 Mbps	0.581

Table 5: Maximum normalized throughput

## 5 Conclusion

In this paper we have proposed a simple simulation model for wireless LANs. At the physical layer, the only important assumption is the linearity of the model; however it can accept all kinds of propagation model with decaying, fading, interference...ets. At the MAC layer we have proposed a simple model for the CSMA/CA scheme including the acknowledgement and the RTS/CTS (if activated). This model is optimized to provide a fast simulation tool of the IEEE 802.11 MAC. We have proposed the simulation results of various scenarios using the exact IEEE 802.11 overhead. Thus we have given a detailed performance analysis of the IEEE 802.11 protocol with various data rates. We have most particularly studied the maximum channel throughput, the performance of the protocol for broadcast traffic, the effect of the RTS/CTS, channel reuse. In future work, we will use this model to evaluate routing protocols. We also plan to use this simulation model to evaluate various QoS proposals for the IEEE 802.11 standard.

## References

- [1] ETSI STC-RES 10 Committee, *HIPERLAN functional specifications*, draft standard ETS 300-652, 1995
- [2] IEEE 802.11 standard. Wireless LAN Medium Access Control (MAC) and Physical Layer (PHY) specifications. June 1997.
- [3] ANSI/IEEE Std 802.3, 2000 Edition] Information technology–Local and metropolitan area networks–Part 3: Carrier sense multiple access with collision detection (CSMA/CD) access method and physical layer specifications
- [4] Metcalf, R. M., Boggs, D. R. 1976. Ethernet: Distributed Packet Switching for Local Computer Networks. Comm ACN. 395-404.
- [5] 8802-5: 1998 (ISO/IEC) [ANSI/IEEE 802.5, 1998 Edition] Information technology–Telecommunications and information exchange between systems–Local and metropolitan area networks–Specific requirements–Part 5: Token ring access method and physical layer specifications

- [6] P. Mathys, P. Flajolet, “ $Q$ -ary collision resolution algorithms in random-access systems with or blocked channel access,” in *IEEE Trans. on Information Theory*, vol IT-31, pp 217-243, 1985.
- [7] Data Networks. Dimitri Bertsekas and Robert Gallager. Prentice Hall 1988.



---

Unit e de recherche INRIA Lorraine, Technop le de Nancy-Brabois, Campus scientifique,  
615 rue du Jardin Botanique, BP 101, 54600 VILLERS L ES NANCY  
Unit e de recherche INRIA Rennes, Irisa, Campus universitaire de Beaulieu, 35042 RENNES Cedex  
Unit e de recherche INRIA Rh ne-Alpes, 655, avenue de l'Europe, 38330 MONTBONNOT ST MARTIN  
Unit e de recherche INRIA Rocquencourt, Domaine de Voluceau, Rocquencourt, BP 105, 78153 LE CHESNAY Cedex  
Unit e de recherche INRIA Sophia-Antipolis, 2004 route des Lucioles, BP 93, 06902 SOPHIA-ANTIPOLIS Cedex

---

 diteur  
INRIA, Domaine de Voluceau, Rocquencourt, BP 105, 78153 LE CHESNAY Cedex (France)  
<http://www.inria.fr>  
ISSN 0249-6399