



**HAL**  
open science

# Ananas : A New Adhoc Network Architectural Scheme

Guillaume Chelius, Eric Fleury

► **To cite this version:**

Guillaume Chelius, Eric Fleury. Ananas : A New Adhoc Network Architectural Scheme. [Research Report] RR-4354, INRIA. 2002. inria-00072234

**HAL Id: inria-00072234**

**<https://inria.hal.science/inria-00072234>**

Submitted on 23 May 2006

**HAL** is a multi-disciplinary open access archive for the deposit and dissemination of scientific research documents, whether they are published or not. The documents may come from teaching and research institutions in France or abroad, or from public or private research centers.

L'archive ouverte pluridisciplinaire **HAL**, est destinée au dépôt et à la diffusion de documents scientifiques de niveau recherche, publiés ou non, émanant des établissements d'enseignement et de recherche français ou étrangers, des laboratoires publics ou privés.

# *Ananas : A New Adhoc Network Architectural Scheme*

Guillaume Chelius — Éric Fleury

**N° 4354**

January 2002

THÈME 1



*Rapport  
de recherche*



## Ananas : A New Adhoc Network Architectural Scheme

Guillaume Chelius\* , Éric Fleury†

Thème 1 — Réseaux et systèmes  
Projet ARES

Rapport de recherche n° 4354 — January 2002 — 22 pages

**Abstract:** In this paper, we present a new architecture for adhoc networks : Ananas. Based on the combined use of a classical adhoc routing protocol and virtual adhoc interfaces, Ananas allows a complete support for the IP protocol over adhoc networks, including auto-configuration mechanisms such as the IPv6 one or DHCP. It also provides Internet connectivity and compatibility with Internet services and protocols such as multicast. Finally Ananas addresses problems of scalability and adhoc network partitioning.

**Key-words:** adhoc networks, network architecture, auto-configuration, routing, communication networks

\* gchelius@telecom.insa-lyon.fr

† Eric.Fleury@inria.fr

## **Ananas : Un nouveau schéma architectural pour réseaux adhoc**

**Résumé :** Nous présentons une nouvelle architecture pour réseaux adhoc : Ananas. Reposant sur l'utilisation combinée d'un algorithme de routage adhoc classique et d'interfaces virtuelles, Ananas offre un support complet du protocole IP sur réseaux adhoc, comprenant les mécanismes d'auto-configuration comme le protocole DHCP ou ceux d'IPv6. Il fournit également une interconnexion avec l'Internet et une compatibilité avec les services et protocoles de l'Internet comme le multicast. Enfin, Ananas résout les problèmes de scalabilité et de partition réseau.

**Mots-clés :** réseaux adhoc, architecture réseau, auto-configuration, routage, réseaux de communication

## 1 Introduction

An adhoc network consists in a set of mobile platforms which own wireless communication devices. In such a raw network, it is not possible to perform advanced networking. Even basic communication schemes are not supported: for example, it is not possible to communicate with nodes out of range. There is an obvious need for infrastructures. Since the adhoc network is characterized by the absence of a wired or wireless but fixed backbone, these infrastructures have to be integrated in the mobiles. For infrastructures to be efficient, nodes must cooperate and thus have to organize themselves according to an architecture. What we call architecture is a set of rules and mechanisms that allow implantation of services and enable networking. Examples of services are multi-hop routing, multicast and broadcast capabilities, full IP support, auto-configuration or Internet connectivity.

In this paper, we present a new architecture for adhoc networks: Ananas. Based on the combined use of a classical adhoc routing protocol and virtual adhoc interfaces, Ananas allows a complete support for the IP protocol over adhoc networks, including auto-configuration mechanisms such as the IPv6 one or DHCP. It also provides Internet connectivity and compatibility with Internet services and protocols such as multicast. Finally Ananas addresses problems of scalability and adhoc network partitioning.

The remainder of this paper is organized as follows. Section 2 reviews the different salient characteristics that an adhoc network must offer. In this section, we revisit the main features listed in MANet (*Mobile Adhoc Networks* [2]) and put forward arguments in order to justify a fine grain level approach which requires a departure from the actual MANet implementation philosophy. Our proposed architecture that meets all listed requirements is presented in section 3. In section 4 several advanced features are presented like sub-networking support and auto-configuration. Two representative adhoc routing protocols (*Ad Hoc On-Demand Distance Vector* - AODV - as a reactive specimen and *Optimized Link State Routing Protocol* - OLSR - for the proactive one) are discussed and a first performance study is proposed. Finally, conclusion and perspectives are presented in section 5.

## 2 Requests for an adhoc architecture

The fundamental service in an adhoc environment is to allow communication between all mobiles of the network, that is, to able a peer-to-peer mobile routing capability in a purely wireless domain as stated in [2]. One node must be able to reach any other node. Since some nodes may be out of range or since some nodes may not share the same medium (uncompatible wireless devices), it is necessary to define complex routing mechanisms that allow multi-hop routing. Inside a given adhoc network, routing mechanisms must be implemented in order to guarantee the intranet connectivity. These mechanisms must ensure unicast, broadcast/multicast and anycast routing capabilities.

### 2.1 Intranet connectivity

The routing paradigm is the main factor driving the design of all networks. The routing function problem in adhoc network may appear as a crucial point and it has been extensively studied this last

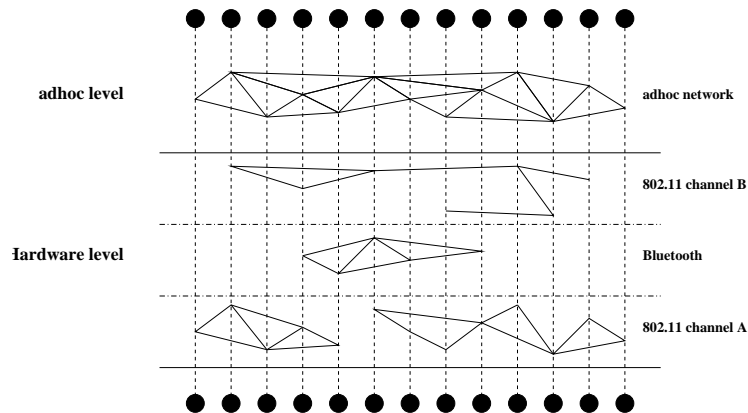

Figure 1: An adhoc network consisting in three physical networks

couple of years. As mentioned in [8], routing in a pure adhoc network raises two main challenges. First of all, traditional solutions proposed in the classical Internet world or in cellular phone networks try to quickly propagate topology changes. All these solutions are based on the assumption that the network is quite stable. This assumption does not necessarily holds for adhoc networks. The second class of assumptions made by classical solutions in the Internet world is that they can rely on some distributed databases maintained by the operators either in the network node or in specialized management nodes. Once again, in mobile adhoc network this point of view is not feasible any more.

Thus, specific routing algorithms must be derived for adhoc network and several researches are done both on proactive and reactive approaches. It is important to notice that, as stated in [2], a MANet node using wireless technologies A and B (e.g. 802.11 and Bluetooth) can communicate with any other node possessing an interface with technology A or B. This means that the unicast routing algorithm must operate on a multigraph composed of several physical graph and that an adhoc node is the union of all its interfaces involved in the adhoc network. The unicast routing must offer a global connectivity over all the interfaces.

The second important service that must be supported by an adhoc network is the broadcast facility. As in other network, a node may need to send a message to all other nodes. This facility also named flooding is used in almost all unicast routing algorithms [7, 10] developed for MANet networks and must be supported in a very efficient way at the adhoc level. An adhoc network can also provide multicast or anycast extensions. This two last services are mandatory in any IPv6 implementation. Of course, multicast may be implemented in a trivial way by flooding the network but it is not really scalable nor bandwidth efficient! The research challenges for providing multicast are even greater in adhoc network as compared to the Internet mainly due to the intrinsic adhoc characteristics: lack of infrastructure, high dynamic nature of wireless nodes and their unexpected mobility. A multicast service should allow group members to join or leave whenever they need and

should not impose any specific assumption on node mobility. It should also provide the management part inherent to a multicast session: multicast address group allocation and session advertisement.

## 2.2 Complete support for TCP/IP

Once the connectivity is provided, the second services that must offer an adhoc network is the TCP/IP one. Indeed, TCP/IP is a de facto standard and the whole Internet rely on these protocols. All applications are developed over this stack. Every node must be able to behave as if it belongs to a standard IP network, that is in "an interoperable inter-networking capability over a heterogeneous networking infrastructure". Moreover, a partial support or compatibility with IP is also an unsatisfying approach. Base on this trivial remarks, we must focus on the consequences that it implies.

First, IP defines a set of addressing as well as address-related routing rules. For example, it defines the notion of IP networks and IP sub-networks. Routing and accessibility directives are associated to these notions. IP also proposes broadcast notions and rules. For example, a packet directed to the address 255.255.255.255 is received by all nodes connected to the local link of the source and is not supposed to be forwarded. Numerous protocols and applications rely on IP standards. If we desire a complete compatibility with existing networking environments, the adhoc architecture must be fully compatible with IP.

Secondly, several auto-configuration mechanisms are proposed in association to IP. In IPv4, the DHCP protocol allows an host to retrieve its IP address from a server. In IPv6, a node is able to automatically discover its IP addresses and its routers. If these services are powerful ones in wired networks, their importance is even greater in adhoc networks which are, by definition, spontaneous.

## 2.3 Internet Connectivity

Even if it is only envisioned that MANets will act as "stub" networks, which means that all traffic treated by adhoc nodes is either sourced or sinked within the range of the adhoc network, it is important to offer a global connectivity. This means for example that if auto-configuration is supported inside an adhoc network (as mentioned in the previous section), a mobile IP node must be able to move to an adhoc network, perform the mobile IP care of address and continue all its session as it moved to a classical wired network.

The notion of global connectivity is more general than the care of address feature present in IP mobility. Offering a global connectivity to the Internet is providing a service continuum. This means for example that an adhoc node must be able to receive its favorite net-radio multicasted from a server which is not localized within the adhoc network. As stated above, the multicast protocol used inside the MANet will be specific and the global connectivity service will perform the gateway operations with PIM/CBT/YAM...

## 2.4 Other features

We may want to be able to switch from one physical radio interface to another for power consumption reason for example, without having to deal with any IP mechanism. It means that micro-mobility support can be implemented inside an adhoc node without changing IP addresses or IP routes.



An other very important feature is the easiness of implementation. Turning a node (PC, PDA...) into an adhoc node should not require any kernel modification nor any driver modification.

Last but not least, the scalability requirement may be an important factor. One can imagine than an adhoc network may support tens to hundreds of mobile nodes but must also be scalable to a higher factor if this kind of networks becomes really pervasive [6].

## 2.5 The MANet approach

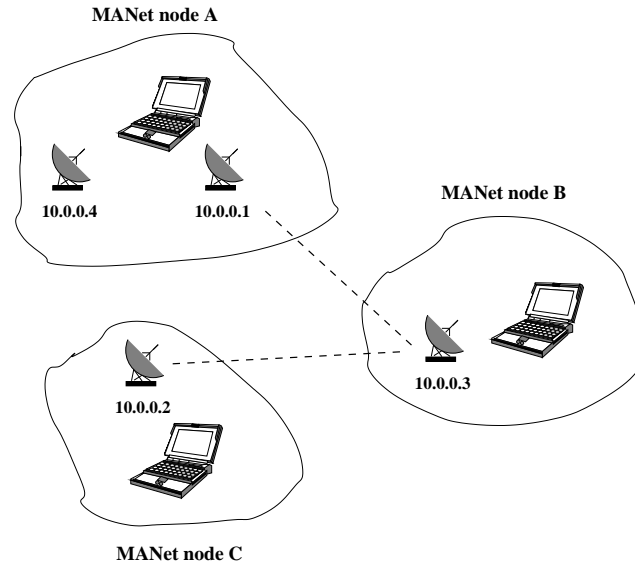

Figure 2: A MANet network consisting in three nodes

The MANet group of the IETF -*Internet Engineering Task Force* - proposes an architecture in which the base element is the MANet node: “a MANet node principally consists of a router, which may be physically attached to multiple IP hosts (or IP-addressable devices), which has potentially \*multiple\* wireless interfaces—each interface using a \*different\* wireless technology”. Packets travel from nodes to nodes using the IP-level routing mechanism based on IP addresses of MANet node interfaces. A simple example is given in figure 2. The IP route between node *A* and node *C* is  $node\_A : 10.0.0.1 \rightarrow 10.0.0.3 \rightarrow 10.0.0.2 : node\_C$ .

Addressing all the challenges listed in MANet [2] and highlighted in the previous sections may require a departure from solutions available in the literature. Indeed, the actual philosophy is to design/implement all MANet routing protocols, and more especially unicast ones at the IP level. Yet, it yields to inconsistencies with IP. It results sometimes in endless discussions on the broadcast semantic in adhoc networks or whether an adhoc network may or not support sub-networking. The

MANet mailing list archive gives evidence of all these non really IP supported features in actual adhoc routing protocols.

### 3 Our proposal: Ananas

Based on the preceding remarks, it seems important to provide a more fine grain layering that includes an adhoc level as compared to the pure IP layering. We can locate it at level 2.5, *i.e.*, between the level 2 (MAC) and level 3 (IP). Basically, broadcasting a packet to reach all adhoc nodes has nothing to do with the IP header and the famous TTL field must not be modified while the packet travels inside the range of the adhoc network. In the contrary, locating the adhoc level at layer 2 [1] also have several flaws. It makes the handle of multiple interfaces very difficult and hardly enables support for micro-mobility.

#### 3.1 Inter-node architecture

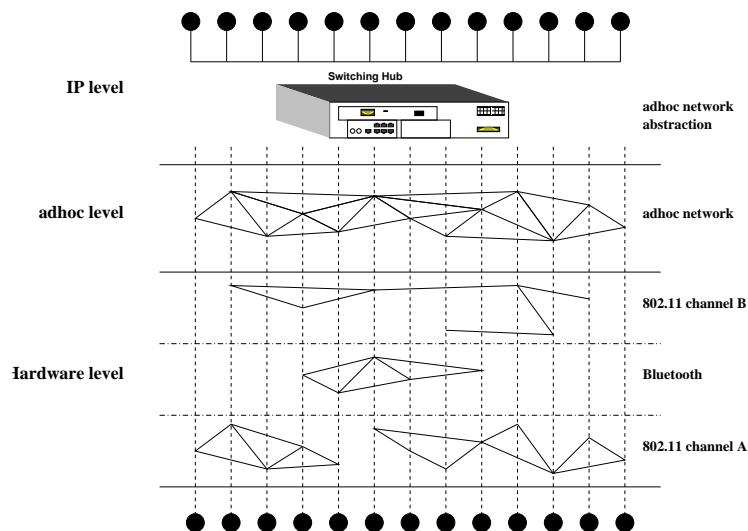

Figure 3: The different abstractions in an adhoc network

We propose an architecture breaking up an adhoc network into three levels of abstraction: the hardware level, the adhoc level and the IP level. If the first one relies on a physical reality, interface communication compatibility, the two others are views of mind. The base element of the first level is the wireless interface whereas for the two others, it is the adhoc node. Our definition of an adhoc node follows the one proposed by MANet in [2].

### 3.1.1 Hardware level

The hardware level is the set of the different hardware networks. A hardware network is the gathering of all interfaces that are physically able to communicate with each other. At this level, the notion of communication ability is related to wireless device compatibility and not to effective communication possibility. Two interfaces belong to the same hardware network if, for example, they both are 802.11 devices emitting on the same channel. Figure 3 shows a configuration where the hardware level is built up with three different hardware networks. The first one is the reunion of 802.11 interfaces emitting on channel *A*, the second one is defined by the Bluetooth technology and the third one works on 802.11 channel *B*. In a hardware network, Hardware addresses (e.g. MAC) identify interfaces. No routing mechanism is implanted and one hop transmission is the only communication scheme available. For packet transmission, interfaces are addressed using hardware addresses.

### 3.1.2 Adhoc level

The adhoc level defines the adhoc network. An adhoc network is the combination of all hardware networks. At this level, the base element is no more the interface but the adhoc node. We do not make distinction between interfaces but only see nodes with a single interface, the adhoc interface connected to the adhoc network. A unique adhoc device is abstracted from all wireless devices. Figure 3 shows the adhoc level resulting from the previous hardware level. It is composed of all nodes owning an interface present in one of the hardware networks. The connectivity graph is the merging of the three hardware connectivity graphs.

In an adhoc network, an element is named using a unique node identifier, also called an adhoc address. Multi-hop communication is available. One node may send packets to a node distant from several hops. Packets are commuted from adhoc nodes to adhoc nodes depending on adhoc addresses of destinations. Broadcast and multicast mechanisms are also available. While commuted, a packet may transit through any underlying hardware network and join the destination by any of its hardware interface. The followed path is determined by the commutation or also called routing protocol. This routing protocol is independent of the architecture.

### 3.1.3 IP level

The IP level is the world as it is seen by level 3 protocols in the OSI model. As we are most interested by IP, we name it the IP level. At this level, an adhoc network is seen as an Ethernet bus: the IP abstracted network. More precisely, it is considered like a switched Ethernet link as illustrated in figure 3. An adhoc node of the adhoc level is looked upon as a single and classical Ethernet interface: the virtual adhoc interface. In other terms, a node with several physical devices only owns one interface from the IP view. Nodes are identified by IP addresses and classical IP communication is performed. IP packets are emitted and received through virtual adhoc interfaces and transit in the IP abstracted network. All the commutation work performed at the adhoc level is transparent to IP.

This architecture allows a complete compatibility with IP. For example, 255.255.255.255 packets reach all nodes of the adhoc network without being IP routed. Auto-configuration becomes straight-

forward. Performing DHCP is possible since adhoc nodes are reachable even if not IP configured. As the commutation is performed at the adhoc level, no IP address is needed to communicate with other adhoc nodes. With IPv6, auto-configuration mechanisms take place as they do on Ethernet links. More globally, all the IP world behaves as it does with an Ethernet link. This architecture also enables the use of other level 3 protocols on top of the adhoc network.

## 3.2 Intra-node architecture

As seen in the previous section, the inter-node architecture is based on the notion of a virtual adhoc interface. The role of a virtual adhoc interface, or simply virtual interface, is to hide the different physical devices and hardware networks; it provides the illusion of a single virtual network. At the adhoc level, this virtual network is a wireless multi-hop network; at the IP level, it is a switched Ethernet link.

### 3.2.1 The virtual interface

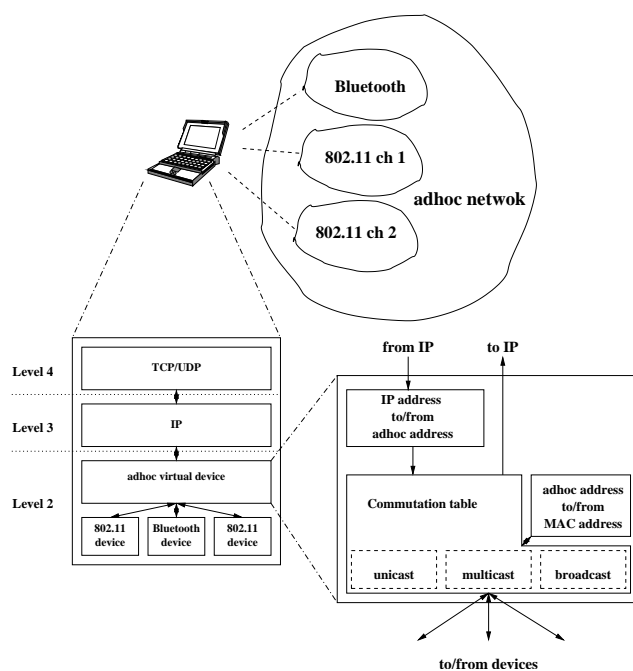

Figure 4: The virtual interface

For upper layers, the virtual interface acts as a classical interface. For example, it is declared as an Internet device to the IP layer. IP outputs packets directed to adhoc nodes through the virtual

interface. For the under layer, *i.e.* the link layer, the virtual interface acts as an upper layer protocol. Upon reception of a packet that has transited through the adhoc network, the packet is given to the virtual interface. This particular architecture is interesting since it does not require any modifications neither in device drivers nor in the TCP/IP stack.

A virtual interface may or may not handle all network devices of a host. The set of handled devices is variable and may be modified during run-time. It may be configured automatically according to a particular policy. For example, the virtual interface may by default handle all wireless interfaces. It may also be configured directly by the user which chooses to add or to remove physical devices from the virtual interface. A host may also have several virtual interfaces as we will see in section 4.1.2.

### 3.2.2 Naming adhoc interfaces

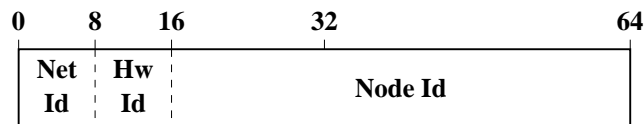

Figure 5: Structure of an adhoc address

Hardware type	Hardware type value
802.11	1
Bluetooth	2

Table 1: Values of the hardware identifier field

Our approach raises a particular issue related to node identification. To transmit packets from one adhoc node to another, virtual interfaces need to be addressed. Introducing a logical network and logical interfaces require the introduction of a corresponding logical naming process. Virtual interfaces are addressed using adhoc addresses. The structure of an adhoc address is given in figure 5. It has three fields: the net identifier field, `Net Id`, the hardware identifier field, `Hw Id`, and the node identifier field, `Node Id`.

The net identifier tells which adhoc network the interface is connected to. The default value is 0. This value has approximately the same semantic as the link local prefix `00fe : 0000` in the IPv6 addressing scheme. It means that no particular network is defined or that the interface is not yet configured. We will see in section 4.1.1 how and why this field can take other values. Basically, the net identifier is used to restrict the set of nodes one may exchange data with. It allows the creation of distinct adhoc networks in the same way it exists distinct IP networks.

The two other fields are filled using one of the physical devices connected to the adhoc network. For each virtual interface, one of its hardware device is picked. The hardware field is filled with the hardware type value of the chosen device. The node identifier is filled with the hardware address

of the chosen device; for example, the MAC address of an Ethernet device or the BD\_ADDR of a Bluetooth device. Examples of hardware type values are given in table 1. The association of these two fields must ensure the uniqueness of the adhoc address. The 48-bits size of the hardware field is a suggestion but may be increased to allow the integration of devices with larger hardware addresses. We could also use the EUI-64 format. Since 802.11 or Bluetooth devices only require 48 bits, we chose this last size.

### 3.3 Intelligent Commutation

<b>Destination adhoc Address</b>		
<b>Source adhoc Address</b>		
<b>Hop Count</b>	<b>Protocol ID</b>	<b>Group Sequence / None</b>

Figure 6: Header of the virtual interface

The role of the virtual interface is to commute packets between different devices and upper layers protocols. Upon reception of a packet, the interface decides whether it has to emit the packet, through which interface and to which nodes, and whether it has to forward it to upper layers. We name this process *intelligent commutation*. It can be seen as a routing operation but since the routing term commonly references IP routing, we prefer the commutation term.

#### 3.3.1 Commutation support

Destination adhoc address	Next hop adhoc address	Next hop interface address
00 : 01 : 00 : 02 : 2D : 27 : 43 : F6	00 : 01 : 00 : 02 : 2D : 27 : 43 : A0	00 : 02 : 2D : 27 : 43 : A0 00 : 02 : 2D : 27 : 43 : A0
00 : 02 : 00 : D5 : 90 : AF : 2A : 0D	00 : 02 : 00 : D5 : 90 : AF : 2A : 0D	10 : D0 : 59 : 65 : D0 : 0D 10 : D0 : 59 : 65 : D0 : 0D

Table 2: A commutation table

A virtual interface owns a commutation table. This table is managed by a routing protocol such as the ones studied in the MANet group. Examples are OLSR [7], AODV [10], TBRPF [9] (*Topology Broadcast Based on Reverse-Path Forwarding*), DSR [5] (*Dynamic Source Routing*). The routing protocol is independent of the global architecture. Any MANet protocol may potentially be used.

Its role is to compute or discover routes and to configure commutation tables in adhoc interfaces. Very few work is required to adapt a MANet routing algorithm to our architecture. Basically, node identifiers have to be changed from IP to adhoc addresses. Some protocol control packets must also be modified to integrate address translation information. As an example, we present in section 4.2 the modifications applied to OLSR and AODV to combine them to our architecture.

An example of commutation table is proposed in table 2. As we can see, commutation rules are defined using adhoc addresses. Since the destination adhoc address does not figure in the link layer header, it has to be added in the frame. Some other data have also to be recorded in the packet; an adhoc hop counter for example. These elements are grouped into the virtual interface header. This header is placed in all packets transiting through the adhoc network, between the link layer header and the upper protocol header, generally the IP header. Its structure is given in figure 6. The two first fields are source and destination adhoc addresses. Third field is a hop number and the fourth a protocol identifier. The fifth field is a packet sequence number only used for broadcast and multicast communications. The hop counter is used to limit the range a packet may go. Every time a packet is forwarded by an adhoc node, its hop number is decreased. When reaching 0, the packet is dropped.

### 3.3.2 Address translation

Address translation mechanisms are required for the commutation to be effective. As a virtual interface internally receives an IP packet, it has to translate an IP address into an adhoc address. To fulfill this task, every virtual interface owns an IP-to-adhoc address translation table. Filling this table is a mechanism deeply bound to the one of creating adhoc routes. To explain how, let us consider a reactive routing algorithm. When node A tries to communicate with node B for which it has no route, a route discovery process is started. In our architecture as in the MANet one, the route request looks like *“I’m looking for a route to the node with IP address  $IP_B$ ”*. Our route resply slightly differs from the MANet one. Instead of simply creating the route, it also provides information about adhoc and IP addresses of the destination node. The answer looks like *“Here is a route for node with adhoc address  $AH_B$  and IP address  $IP_B$ ”*. Similar modifications are made in the case of proactive protocols. We will see in section 4.2 how OLSR and AODV are modified to provide address translation.

An adhoc node also requires the correspondence between adhoc addresses and hardware addresses but only for a subset of the adhoc network, its neighbors. This correspondence is extracted from control packets of the adhoc routing protocol. The process is similar to the *Automatic Address Resolution* [9] option of the TBRPF routing protocol. It can be extended to all MANet protocols by considering not only Hello control packets but all control packets (e.g. Hello packets for OLSR, Route Request packets for AODV and DSR).

### 3.3.3 Multi-protocol support

As we have already said, our architecture allows the use of different network protocols over the adhoc network. For all of them, the network is seen as an Ethernet link. Choosing which protocol the packet is intended for is made by setting the protocol value in the protocol field of the adhoc header. A demultiplexing step in the virtual interface directs the packet toward the correct protocol. A more powerful characteristic of our architecture is to allow an host to use a device simultaneously

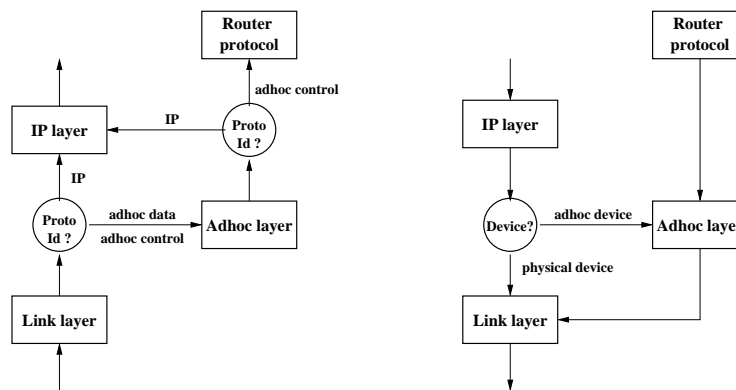

Figure 7: Multiplexing and demultiplexing process in an adhoc node

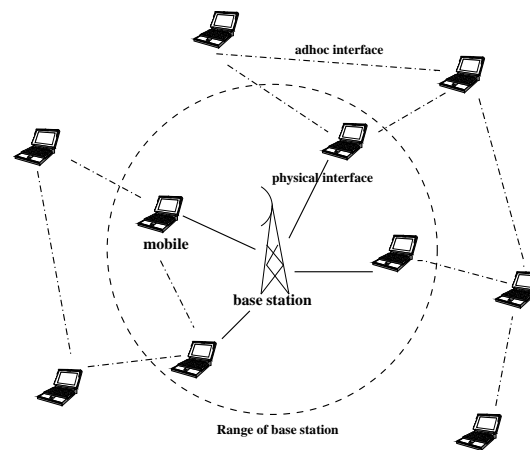

Figure 8: An hybrid wireless network

in adhoc and in classical modes. Suppose a physical device handled by a virtual adhoc interface is also configured as an Internet device. From the IP view, the mobile hosts two distinct interfaces. IP networking is performed over these two interfaces without interference. Figure 7 shows the multiplexing and demultiplexing operations performed. When a packet is received from the network, the prototype field of the link layer header indicates whether the packet has to be considered as an adhoc packet or whether it is a classical packet. In the first case, the packet is given to the virtual interface, in the second case it is given to IP. When IP outputs a packet, it chooses to use the physical device or the virtual adhoc interface. This mechanism still works with other than IP network protocol; in particular ARP.



There are many cases for which this kind of configuration is interesting. Examples are wireless terminal networks where the access point does not support an adhoc mode though mobiles may support it. This is the case of UMTS [4] networks. Communication between the access point and in-range mobiles is performed using the wireless devices of mobiles in a classical way. Communication between mobiles take place on the adhoc network using virtual adhoc interfaces. Communication between the access point and an out-of-range mobile is performed using the adhoc network from the mobile to a chosen *in-range of the access point* node and using the physical interface from this last node to the access point. Finding a mobile in range of the access point may be done proactively, with a router advertisement mechanism, or reactively, with a route discovery mechanism. Such a configuration is proposed in figure 8.

## 4 Advanced features and examples

If we confront Ananas to the set of services detailed in section 2, results are completely satisfying. Ananas is an architecture that allows a complete support for IPv4 and IPv6, including auto-configuration mechanisms. It also provides a complete connectivity with the Internet, in regards to routing but also multicast and other services mechanisms. Two points remain: scalability and micro-mobility. The second point is easily handled. Since adhoc nodes are addressed regardless of physical devices they host, the commutation process may prefer one physical medium or one hardware network, may change routes or may apply a quality of services policy for route selection depending for example on the power consumption of devices. All changes that may occur in the adhoc commutation process do not introduce any modifications at the IP level. Scalability is harder to achieve. One approach is to use hybrid routing protocols like *Zone Routing Protocol* [3] which define clusters in an adhoc network. We propose an alternate approach based on the notion of *sub-adhoc-networks*. It may also be used in conjunction with hybrid routing protocols.

### 4.1 Sub-adhoc-networking

There are several situations for which there is a need to split an adhoc network into several sub-networks - sub-adhoc-networks - that do not interfere with each other. The first one is scalability. Adhoc networks may become huge enough such that routing protocols or services protocols are no more appropriated. Flooding delay may become too long or commutation tables may explode due to the huge number of entries. The second reason is to restrict communication. Imagine that every cities of a country host its own adhoc network. A policy may be to limit the adhoc commutation process to a single city and to perform IP routing between cities. But in practice, adhoc networks of different cities may be connected if, for example, there is a high traffic of adhoc cars on a highway between two cities. In this case, there is a need for mechanisms that keep the resulting network splitted into city sub-networks.

Source net identifier	Destination net identifier	Policy
0	0	accept
$x$	0	accept
$x$	$x$	accept
$x$	$y$	reject
0	$y$	accept

Table 3: Adhoc nodes communication policy

#### 4.1.1 Ad-hoc network partition

The net identifier field of an adhoc address allows the definition of communication policies between adhoc nodes. This field identifies the adhoc network a node belongs to. Basically, two mobiles that do not belong to the same network are not allowed to communicate with each other. More precisely, the policy is given in table 3. As already said in section 3.2.2, the default value is 0. This value is taken by networks that are not partitioned. This value is also taken by a node that belongs to an adhoc partitioned network but which has not been configured yet. A packet which source has an network identifier of 0 is always handled by a node. Likewise, a node with a net identifier of 0 always handle an incoming packet. Finally, a node never handles a packet from a source owning a different network identifier. Of course, it may be useful to weaken these rules. In the case of control packets of routing protocols for example: we may want to know which neighbors we have in an adjacent sub-network and therefore consider Hello packets from this sub-network. A systematic exception to the policy defined in table 3 is the `sub-adhoc-network advertisement` packet acceptance policy. This packet is studied in the next section.

#### 4.1.2 Auto-configuration

A net identifier may be configured manually. It is set to the default value or to the one of the local `sub-adhoc-network` the node belongs to. It may also be configured automatically and evolve depending on the geographical position of the mobile. This auto-configuration mechanism is quite similar to a router advertisement protocol and is illustrated in figure 9. Some mobiles declare themselves as `sub-adhoc-network` leaders. They periodically flood the adhoc network with particular control packets: `sub-adhoc-network advertisement` packets. These packets contain a network identifier chosen by the `sub-adhoc-network` leader. When an unconfigured mobile receives such a packet, it changes its adhoc address by setting its network identifier value to the received one. This way, the mobile joins the sub-network created by the source of the packet. The membership to a `sub-adhoc-network` is temporary and refreshed upon reception of advertisement packets. If no packet is received during a delay equal to a fixed time out, the network identifier of the virtual interface is restored to the default value.

The size of an automatically generated `sub-adhoc-network` is limited by the `adhoc hop` value of the corresponding `sub-adhoc-network advertisement` packets. This value defines a

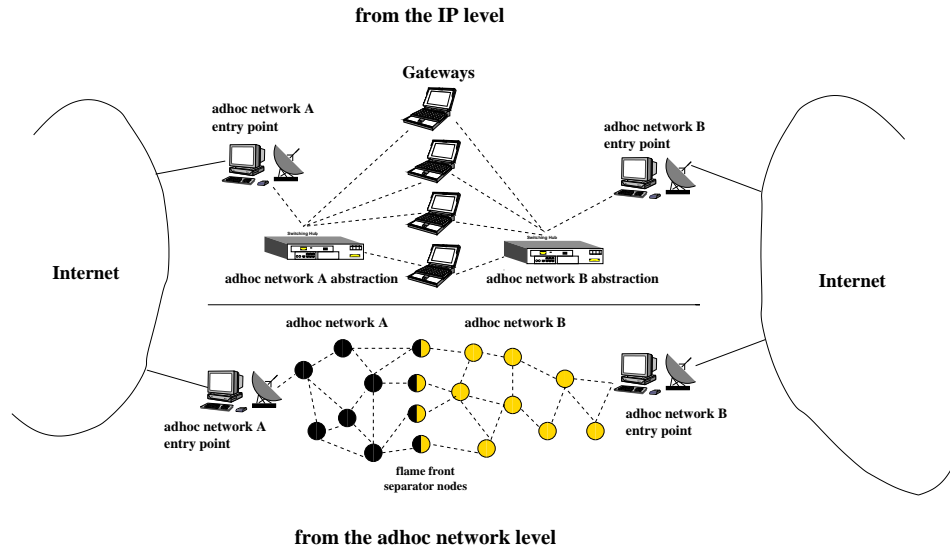

Figure 9: Auto-generation of two sub-adhoc-networks

maximal radius around the leader of the sub-network. A second limiting factor is due to overlapping of these extrapolated discs. There is a high probability for nodes to receive several `sub-adhoc-network advertisement` packets coming from different leaders. To avoid overlapping of sub-adhoc-networks, a flame-front mechanism is used. When a configured mobile, a mobile which already belongs to a sub-network, receives a *sub-adhoc-network advertisement* packet which does not correspond to its network identifier, it handles the packet but does not forward it. Instead, it *duplicates* its virtual interface and configures it with the newly received network identifier. The duplication process is simple and similar to the process of aliasing an Internet interface. The duplicated virtual interface is in all point similar to the first one, handling the same physical devices, except for the adhoc address which differs in the network identifier field. This mechanism is illustrated in figure 9. If a node with several adhoc devices stops receiving `sub-adhoc-network advertisement` packets for one of its sub-networks, the correspondent virtual interface is not reseted but destroyed. The flame-front is not always a line as illustrated on the picture. Indeed, race conditions may lead to a front of thickness 2. It is not a problem since connectivity is still achieved using the correct virtual interface.

#### 4.1.3 Interaction with IP

As illustrated in figure 9, different adhoc networks are regarded by IP as different Ethernet links. Since an adhoc interface may only belong to one adhoc network, coherence between adhoc networks and IP representations is achieved. Routing between several adhoc networks is an IP routing task and mobility between adhoc networks is ensured by Mobile IP [11]. Switching from an adhoc

network to another induces the re-initialization of the adhoc virtual interface. Since IP considers that the node has moved from one link to another, the interface is also IP reconfigured, including the attribution of a new IP address. Keeping connectivity with the old adhoc network is the result of IP routing between the old and the new adhoc networks. Keeping the old IP address active is performed by Mobile IP. Moving from one adhoc network to another is similar to the notion of *handover* in wireless telephony. This change is not sudden but includes an intermission during which the adhoc node belongs to both adhoc networks. Duplicating the virtual interface allows the setup of a soft handover. During this intermission, a node may be addressed on both adhoc networks and, hopefully, may setup the mobile IP protocol without loss of connectivity.

IP routing between adhoc networks may be achieved using wired routes. It may also be performed using adhoc bridges. These bridges are established by adhoc nodes that belong to several adhoc networks, and as a consequence, own several adhoc virtual interfaces. In such a node, all virtual interfaces are considered by IP. Consequently, the node may act as an IP router between the corresponding adhoc networks. To install the inter-adhoc network routes in all adhoc nodes, a router advertisement mechanism is used. IP routers declare themselves in the adhoc network, precising which networks they have a route for. A simple election mechanism may be used to avoid multiple router declarations for a same network.

## 4.2 Examples of use

As already precised, the Ananas architecture is not bounded to a particular adhoc routing protocol. All protocols proposed by MANet may be adapted to run in coordination with Ananas. Instead of accessing the network using the IP stack, they directly access the virtual interface. Other required modifications concern three points. The first one is to replace IP addresses by adhoc addresses when identifying nodes. The second is to add the Automatic Address Resolution mechanism. The third consists in filling the translation table between IP and adhoc addresses. In this section, we describe how OLSR and AODV may be used as routing protocols in Ananas. We also give some performance considerations about Ananas.

### 4.2.1 Use with OLSR

As we can see in figure 10(a), some fields have been omitted in the new version of the Hello packet. They are `Interface address` fields. With Ananas, these fields are useless. The other modifications of the Hello packet deal with address formats. These last modifications have also been performed in `Topology Change` packets but, for this packet, the major change is the addition of a field. It contains the IP address of the packet source. This field enables all adhoc nodes to extract the correspondence between the adhoc address of the source and its IP address.

Introducing an Automatic Address Resolution in OLSR is really simple. Every time a node receives a Hello packet, it extracts the source hardware address from the link layer header and the source adhoc address from the virtual interface header. The correspondence is immediate.

If an adhoc node owns several IP addresses it wants to use, it may declare them to all adhoc nodes using `Multiple Interface Declaration - MID` - packets. OLSR usually uses this packet to declare several interfaces. Since Ananas nodes only have one virtual interface per adhoc

<b>Reserved</b>		<b>#interfaces</b>
<b>Link type</b>	<b>Interface #</b>	<b>Link Message Size</b>
<b>Neighbor adhoc Address</b>		
...		
<b>Link type</b>	<b>Interface #</b>	<b>Link Message Size</b>
<b>Neighbor adhoc Address</b>		
...		

(a) : Hello

<b>MSSN</b>	<b>Reserved</b>
<b>Source IP Address</b>	
<b>Multipoint Relay Selector adhoc Address</b>	
<b>Multipoint Relay Selector adhoc Address</b>	
...	

(b) : Topology Change

<b>IP address</b>
<b>IP address</b>
...

(c) : Multiple Interface Declaration

Figure 10: Format of OLSR control packets when used with Ananas

networks, we may use MID packets to declare multiple IP addresses. Modifications are given in figure 10(c).

#### 4.2.2 Use with AODV

As for OLSR, AODV control packet formats have been changed. `Route Request` and `Route Reply` packets have been modified to integrate the request source and destination adhoc addresses in addition to their IP ones. The new formats are given in figure 11. The addition of the new fields enables the propagation of the adhoc-IP address translation along the created routes.

`Hello` packets are not mandatory in AODV. Thus, it is not possible to rely on these packets in the setup of an `Automatic Address Resolution`. Instead we consider all control packets, including `Route Request` and `Route Reply` packets. From these packets, we extract adhoc and hardware addresses the same way we do with OLSR. It is interesting to notice that all of our neighbors do not necessarily emit control packets. We may not have the address translation for all of

Type			Reserved	Hop Count
<b>Flooding ID</b>				
<b>Destination IP Address</b>				
<b>Destination Sequence Number</b>				
<b>Source IP Address</b>				
<b>Source adhoc Address</b>				
<b>Source Sequence Number</b>				

(a) : Route Request

Type			Reserved	Prefix	Hop Count
<b>Destination IP Address</b>					
<b>Destination adhoc Address</b>					
<b>Destination Sequence Number</b>					
<b>Source IP Address</b>					
<b>Source adhoc Address</b>					
<b>Lifetime</b>					

(a) : Route Reply

Figure 11: Format of AODV control packets when used with Ananas

our neighbors. Anyway, we only need this translation for neighbors that belong, as a destination or as a relay, to a route we own. For being part of such a route, these nodes have forwarded or answered a `Route Request` in the past. We do know about their address correspondence.

### 4.2.3 Performance issues

Using Ananas has a cost. The Ananas header introduces an overhead of 160 bits in all packets transiting in the adhoc network, reducing the performance the network may achieve. Anyway, this overhead is not significant. First, it does not much reduce the volume of data a packet may includes. 160 bits is less than 0.8% of a 802.11 link transfer unit (TU: 2312 bytes). Second, this overhead does not much lower the useful bandwidth of the medium. It only takes 14us to transfer 160 bits over a link with a 11Mbits/s throughput. In the 802.11 technology, this delay is less than 8 times the delay to wait before accessing the medium (DIFS= 128us). Figure 12 presents some theoretical bandwidth ratios. The medium is a 802.11 link with 11Mbits/s throughput. The x-axis is the size of data in the exchanged packets. The y-axis is the ratio between the effective bandwidths with and without Ananas. The two plots correspond to a classical `RTS-CTS-Data-ACK` transfer scheme and a `Data-ACK` one. In the worst case, the overhead is very low, only 7% loss of the effective bandwidth.

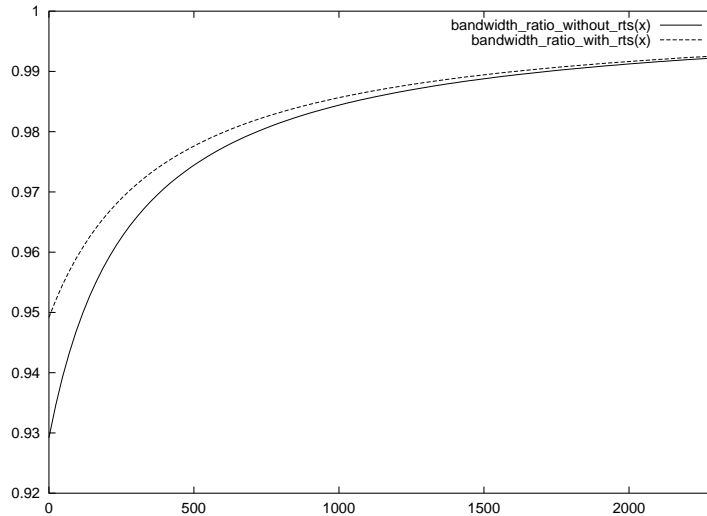

Figure 12: Effective bandwidth ratios

Ananas introduces a second overhead when used with some routing protocols. We can see figure 11 that modified AODV packets are larger than classical ones. The overhead is 64 bits in the case of `Route Request` packets and 128 bits for `Route Reply` packets. Here again, the overhead is not significant and must be relativized. If the AODV payload is larger with Ananas, the packet transiting in the network is not necessarily bigger. Since AODV performs on top of the virtual interface, there is no IP nor UDP header in control packets, leading to a lower overhead. The case of OLSR is slightly different. Indeed, new control packets may be smaller or larger depending on the number of neighbors for example. This is due to the fact that adhoc addresses are larger than IPv4 ones. Yet, they are smaller than IPv6 ones. If Ananas may introduce overhead in an IPv4 version of OLSR, it does not with IPv6. It even reduces the volume of control packets in this last case.

If in one hand Ananas means overhead, in the other hand it means fewer control packets. For example, Ananas makes no use of ARP and does not exchange ARP packets. Even routing protocols may exchange less packets. For example, a host with multiple interfaces do not need to flood the network with `Multiple Interface Declaration` packets. Some protocols even become useless. Since Ananas allows classical auto-configuration schemes, there is no need for new adhoc auto-configuration protocols. Same phenomena with Internet connectivity. As a result, Ananas improves the performance of the adhoc network, lowering its load. This aspect is not negligible since in adhoc networks, the cost of accessing the medium - sending an empty packet - is important in comparison to the cost of transferring data - link throughput.

## 5 Conclusion

In this paper we have presented a new architecture<sup>1</sup> for mobile adhoc network fulfilling all the requirements highlighted in the general MANet overview [2]. We justify our architecture by several arguments that covers intranet connectivity, a complete support for TCP/IP and an Internet connectivity. The result of this work is an architecture that can be completely integrated in the Internet. Ananas defines an adhoc network by introducing three levels of abstraction: the hardware level, the adhoc level and the IP level. Based on this architecture, actual adhoc routing protocols can be implemented and advanced feature like sub-networking or auto-configuration can be offered. We thus provide an unification of architecture between Internet and adhoc networks. Moreover, the overhead introduced is really low. Ananas even lowers the number of packets transiting across the network.

As stated before, several possible extensions for this work are open to investigation. The first one concerns the implementation of the first version of our architecture under linux and windows. Main open researches concern the unification of services over this unified architecture. We strongly need services continuity. Indeed, it is the only way to effectively integrate adhoc networks in the Internet. It is also necessary for performance considerations. This service continuity includes Multicast, QoS, SLP...

A second domain of extension concerns issues other than routing and has received much less attention so far. Since we can dynamically modify the network topology by creating, destroying and/or merging sub-adhoc-networks, there is an open door for many optimization problems. How to create the most efficient topologies: to lower interferences between areas, to lower the sub-network loads? There are also direct applications with the Bluetooth technology or with frequency hopping that we are currently evaluating. More generally, purely distributed algorithm dedicated to adhoc networks represent a promising research field.

## References

- [1] Lunar. <http://www.docs.uu.se/selnet/lunar/>.
- [2] S. Corson and J. Macker. Mobile ad hoc networking (MANET): Routing protocol performance issues and evaluation considerations. IETF RFC 2501, January 1999.
- [3] Z. Haas and M. Pearlman. Providing ad-hoc connectivity with the reconfigurable wireless networks. In *Proceedings of the ACM SIGCOMM '98*, September 1998.
- [4] H. Holma and A. Toskala, editors. *WCDMA for UMTS*. Wiley, 2001.
- [5] Y. Hu, J. Jetcheva, D. Johnson, and D. Maltz. The dynamic source routing protocol for mobile ad hoc networks (DSR). Internet Draft (work in progress), November 2001.
- [6] J.-P. Hubaux, Th. Gross, J.-Y. Le Boudec, and M. Vetterly. Towards self-organized mobile ad hoc networks : the terminode project. *IEEE Communications Magazine - Special Issue on Telecommunications Networking at the Start of the 21st Century*, January 2001.

---

<sup>1</sup>Sources available at <http://citi.insa-lyon.fr/download/>



- [7] P. Jacquet, P. Muhlethaler, A. Qayyum, A. Laouiti, L. Viennot, and T. Clausen. Optimized link state routing protocol. Internet Draft (work in progress), October 2001.
- [8] D. Maltz, J. Broch, J. Jetcheva, and D. Johnson. The effect of on-demand behavior in routing protocols for multi-hop wireless networks. *IEEE JSAC*, August 1999.
- [9] R. Ogier, F. Templin, B. Bellur, and M. Lewis. Topology broadcast based on reverse-path forwarding (tbrpf). Internet Draft (work in progress), November 2001.
- [10] C. Perkins, E. Royer, and S. Das. Ad hoc on-demand distance vector (AODV) routing. Internet Draft (work in progress), November 2001.
- [11] J. Solomon. *Mobile IP*. Prentice Hall, 1998.



---

Unité de recherche INRIA Rhône-Alpes

655, avenue de l'Europe - 38330 Montbonnot-St-Martin (France)

Unité de recherche INRIA Lorraine : LORIA, Technopôle de Nancy-Brabois - Campus scientifique

615, rue du Jardin Botanique - BP 101 - 54602 Villers-lès-Nancy Cedex (France)

Unité de recherche INRIA Rennes : IRISA, Campus universitaire de Beaulieu - 35042 Rennes Cedex (France)

Unité de recherche INRIA Rocquencourt : Domaine de Voluceau - Rocquencourt - BP 105 - 78153 Le Chesnay Cedex (France)

Unité de recherche INRIA Sophia Antipolis : 2004, route des Lucioles - BP 93 - 06902 Sophia Antipolis Cedex (France)

---

Éditeur

INRIA - Domaine de Voluceau - Rocquencourt, BP 105 - 78153 Le Chesnay Cedex (France)

<http://www.inria.fr>

ISSN 0249-6399