



HAL
open science

AEDCF: Enhanced Service Differentiation for IEEE 802.11 Wireless Ad-Hoc Networks

Lamia Romdhani, Qiang Ni, Thierry Turletti

► **To cite this version:**

Lamia Romdhani, Qiang Ni, Thierry Turletti. AEDCF: Enhanced Service Differentiation for IEEE 802.11 Wireless Ad-Hoc Networks. [Research Report] RR-4544, INRIA. 2002. inria-00072044

HAL Id: inria-00072044

<https://inria.hal.science/inria-00072044v1>

Submitted on 23 May 2006

HAL is a multi-disciplinary open access archive for the deposit and dissemination of scientific research documents, whether they are published or not. The documents may come from teaching and research institutions in France or abroad, or from public or private research centers.

L'archive ouverte pluridisciplinaire **HAL**, est destinée au dépôt et à la diffusion de documents scientifiques de niveau recherche, publiés ou non, émanant des établissements d'enseignement et de recherche français ou étrangers, des laboratoires publics ou privés.



INSTITUT NATIONAL DE RECHERCHE EN INFORMATIQUE ET EN AUTOMATIQUE

***AEDCF: Enhanced Service Differentiation for IEEE
802.11 Wireless Ad-Hoc Networks***

Lamia Romdhani, Qiang Ni, and Thierry Turetli

N° 4544

September 2002

THÈME 1



*R*apport
de recherche

AEDCF: Enhanced Service Differentiation for IEEE 802.11 Wireless Ad-Hoc Networks

Lamia Romdhani, Qiang Ni, and Thierry Turletti

Thème 1 — Réseaux et systèmes
Projet Planète

Rapport de recherche n° 4544 — September 2002 — 22 pages

Abstract: This report proposes an adaptive service differentiation scheme for QoS enhancement in IEEE 802.11 wireless ad hoc networks. Our approach, called Adaptive Enhanced Distributed Coordination Function (AEDCF), is derived from the new EDCF introduced in the upcoming IEEE 802.11e standard. One of the main problems of EDCF is the static reset of the Contention Window (CW) which decreases significantly the throughput performance and increases the collision rate specially at high load conditions. Our scheme aims to share the transmission channel efficiently while providing different priorities to access the wireless medium. Relative priorities are provisioned by adjusting the size of the Contention Window (CW) of each traffic class taking into account both applications requirements and network conditions.

We have implemented AEDCF in the NS-2 network simulator. Several simulation scenarios have been used to evaluate its performance and to determine the optimal value of certain parameters. We analyse through simulations the efficiency of the slow and adaptive decrease of the CW after each successful transmission and compare it with the classic scheme proposed in the standard. Results show that AEDCF outperforms the basic EDCF, especially at high load conditions. Indeed, our scheme increases the medium utilization ratio and reduces for more than 50% the collision rate. While achieving delay differentiation, low jitter is also maintained, and the overall goodput obtained is up to 25% higher than EDCF. Moreover, the complexity of AEDCF remains similar to the EDCF scheme, enabling the design of cheap implementations.

Key-words: Wireless LAN, IEEE 802.11 standard, Ad-Hoc networks, Quality of Services, Services Differentiation.

AEDCF: Support de Différentiation de Service pour réseaux Ad-Hoc sans fils IEEE 802.11

Résumé : Ce rapport décrit un mécanisme de différenciation de service pour améliorer le support d'applications multimedia dans les réseaux Ad-Hoc sans fils IEEE 802.11. Notre approche s'inspire du mécanisme EDCF (*Enhanced Distributed Coordination Function*) récemment proposé dans le standard IEEE 802.11e, afin d'introduire de la qualité de service dans les réseaux sans fils. Un des principaux inconvénients de EDCF est l'algorithme utilisé pour ajuster la fenêtre de contention qui est peu efficace lorsque le réseau est chargé. Nous proposons un nouveau mécanisme appelé AEDCF (*Adaptive EDCF*) qui prend en compte les besoins de l'application ainsi que la charge du réseau pour ajuster la fenêtre de contention. Celui ci permet d'obtenir une différenciation de service efficace et de réduire la latence et la gigue des packets audio/video.

Nous avons mis en oeuvre notre mécanisme dans le simulateur NS. Des simulations avec différents scénarios ont été effectuées afin d'évaluer ses performances et d'optimiser la valeur de certains paramètres de configuration. Les résultats des simulations montrent que AEDCF permet d'accroître le taux d'utilisation du médium et de réduire le taux de collision de plus de 50%. Le débit total obtenu est 25% plus élevé que celui obtenu avec EDCF tout en garantissant une différenciation de service entre les différentes classes. De plus, la complexité de AEDCF demeure semblable à celle de EDCF, autorisant ainsi des implementations à faible coût.

Mots-clés : Norme IEEE 802.11, Réseaux Ad-Hoc Sans Fil, Différenciation de Service, Qualité de service.

Acronymes

ACK	Acknowledgment
AEDCF	Adaptive Enhanced Distributed Coordination Function
AIFS	Arbitration Inter-frame Space
AP	Access Point
BSS	Base Service Set (i.e., one or more AP and a set of wireless end stations)
CW	Contention Window
CSDMA/CA	Carrier-Sense Multiple Access / Collision Avoidance
DCF	Distributed Coordination Function
DFS	Distributed Fair Scheduling
DIFS	Distributed IFS
EDCF	Enhanced DCF
HCF	Hybrid Coordination Function
IEEE	Institute of Electrical and Electronics Engineers
IFS	Inter Frame Spacing
PCF	Point Coordination Function
PIFS	Priority IFS
SIFS	Short IFS
QoS	Quality of Service
TCP	Transmission Control Protocol
WLAN	Wireless LAN

Contents

1	Introduction	5
2	Overview of DCF and PCF 802.11 MAC functions	5
2.1	Distributed Coordination Function (DCF)	6
2.2	Point Coordination Function (PCF)	6
3	Related works	7
3.1	Overview of QoS enhancement schemes proposed for IEEE 802.11	7
3.2	New features of IEEE 802.11e	8
4	The Adaptive EDCAF (AEDCAF) scheme	9
4.1	Scheme description	10
4.1.1	Setting CW after each successful transmission	10
4.1.2	Setting CW after each collision	11
4.2	Complexity of AEDCAF	11
5	Simulation Methodology and Results	11
5.1	Impact of the update period T_{update}	11
5.2	Impact of the smoothing factor α	13
5.3	Impact of the traffic load	14
6	Conclusion	20

List of Figures

1	IFS relationships of IEEE 802.11	7
2	IFS relationships of IEEE 802.11e	9
3	Queue-based EDCAF vs. basic DCF	9
4	Simulation Topology	12
5	Impact of the update period on average delay	13
6	Impact of the update period on the overall goodput	13
7	Impact of the smoothing factor on average delay	14
8	Impact of the smoothing factor on goodput	14
9	Audio average delay	16
10	Gain of goodput	16
11	Medium utilization	16
12	Collision rate	17
13	Gain on goodput of each TC compared with EDCAF	17
14	The audio class delay variation	18
15	AEDCAF latency distributions for each TC	19
16	AEDCAF and EDCAF latency distributions of audio traffic	19
17	AEDCAF and EDCAF latency distributions of video traffic	20
18	AEDCAF and EDCAF latency distributions of background traffic	20

List of Tables

1	MAC parameters for the three TCs.	12
2	IEEE 802.11a PHY/MAC parameters used in simulation	12
3	Correspondence between number of stations and load rate	15

1 Introduction

The IEEE 802.11 Wireless Local Area Network (WLAN) specification [1] defines two different ways to configure a wireless network: ad-hoc mode and infrastructure mode. In infrastructure mode an Access Point (AP) is needed to connect wireless stations to a Distribution System (DS). Ad-hoc networks are wireless networks created in a spontaneous manner: they do not use an access coordinator. In this report we focus on ad-hoc networks since ad-hoc distributed random access control are often preferred to centrally coordinated access control [10, 12]. Indeed, the infrastructure mode requires nodes to exchange a high amount of information in order to maintain a coherent global state. Moreover, the coordinator has the responsibility of keeping track of the state information for each node in the WLAN. In the distributed approach this overhead can be removed. Note that, in an infrastructure network, if a node loses connection with the coordinator, then it can not transmit any packets. On the other hand, with a distributed protocol, if a node loses connection with some nodes, it may still be able to maintain some connectivity.

The IEEE 802.11 standard is the most widely deployed WLAN standard today. Its MAC layer includes a set of protocols which are responsible for maintaining order in the use of a shared medium. Due to the high difference between transmitted and received power levels, traditional random channel access mechanisms used in wired networks as CSMA/CD are not applicable in wireless networks. To deal with this problem, the CSMA/CA (Carrier Sense Multiple Access with Collision Avoidance) protocol is used in WLAN. Distributed Coordination Function (DCF) is the basic medium access mechanism of 802.11 for both ad-hoc and infrastructure modes, which uses the CSMA/CA protocol. It can only support best-effort services, without any Quality of Service (QoS) guarantees.

QoS support is critical for wireless home networking, video on demand, audio on demand and real-time Voice over IP applications. Time-bounded applications such as audio and video conference typically require a minimal bandwidth, bounded delay and low jitter, but can tolerate some losses. Many medium access schemes have been proposed for IEEE 802.11 WLAN to provide QoS enhancements for real-time audio and video traffics. These mechanisms involve the basic DCF and assign the stations or the flows with different MAC parameters in order to access the medium using some priorities. Despite the obtained improvements, they do not provide bounded delays and efficient medium utilization at high load due to the high collision rate. Moreover, in these schemes the low priority stations suffer from starvation [5]. In many cases, a relative differentiation is more suitable. The main problem is there is no optimal MAC parameters that give the best performance in all the channel conditions. In this paper, we propose to take into account both network conditions and application requirements in order to reduce the collision rate and to increase the medium utilization. We propose a new mechanism that can improve the performance under different load rate, and provide real-time support in ad-hoc networks.

The remainder of this report is organized as follows. In Section 2, we present the basic 802.11 MAC functions. In Section 3, we outline the most important distributed medium access schemes that are proposed to improve QoS in IEEE 802.11 WLAN, specially we present the basic EDCA scheme and we analyze its limitations. In Section 4, we describe AEDCF in detail. Simulations and performance evaluation of AEDCF are detailed in Section 5. Section 6 concludes this report and outlines future works.

2 Overview of DCF and PCF 802.11 MAC functions

The MAC protocol for IEEE 802.11 incorporates two access methods: Distributed Coordination Function (DCF) and Point Coordination Function (PCF). DCF is based on the CSMA/CA protocol; it shall be implemented in all stations for use within both ad-hoc and infrastructure network configurations. PCF is optional.

2.1 Distributed Coordination Function (DCF)

DCF is the basic medium access mechanism of the 802.11. In this mode, a station must sense the medium before sending a packet. If the medium is found idle for a time interval greater than a Distributed Inter Frame Space (DIFS) then it can transmit a packet. Otherwise, the transmission is deferred and a backoff process is started. More specifically, the station computes a random value in the range of 0 and the so-called Contention Window (CW). A backoff time interval is computed using the following random value:

$$T_{backoff} = Rand(0, CW) * T_{slot}, \quad (1)$$

where T_{slot} is the time slot selected by the physical layer [1]. This backoff interval is then used to initialize the backoff timer. This timer is decreased only when the medium is idle. It is frozen when another station is detected as transmitting. When the medium has been detected idle for a period greater than DIFS, the backoff timer is periodically decremented by one for every time slot the medium remains idle. As soon as the backoff timer expires, the station will access the medium. A collision occurs when two or more stations start transmission in the same time slot. ACK packets are used to notify the sending station that the transmitted frame has been successfully received. If no acknowledgment is received, the station assumes that the transmission has failed and schedules a retransmission by re-entering the backoff process. To reduce the probability of collisions, after each unsuccessful transmission attempt the CW is doubled until a predefined maximum value (CW_{max}) is reached. Therefore, the backoff time can be computed as follows:

$$T_{backoff} = Rand(0, 2^{i+1} * CW) * T_{slot}, \quad (2)$$

where i (initially equal to 1) stands for the transmission attempt number. After a successful frame transmission, the CW is reset to its initial value, CW_{min} . If the station has frames queued for transmission, it executes a new backoff process.

Not all packet types have the same priority. For example, ACK packets have higher priority than data packets. This is done by assigning to each packet type a different IFS after the channel turns idle, during which a packet cannot be transmitted. Three IFSs are used: Short IFS (SIFS), DIFS and Priority IFS (PIFS), where SIFS is shorter than PIFS and PIFS is shorter than DIFS as shown in Figure 1. As a result, if an ACK (assigned with SIFS) and a new data packet (assigned with DIFS) are waiting simultaneously for the channel to become idle, the ACK will be transmitted before the new data packet. PIFS is used by the AP to poll stations in polling list.

2.2 Point Coordination Function (PCF)

The optional Point Coordination Function mechanism is implemented on top of the basic medium access protocol (DCF). This mode uses a centralized polling approach which requires the presence of an Access Point (base station) that acts as a Point Coordinator (PC).

When PCF is used, the time is divided into two super-frames consisting of a Contention Period (CP) used by DCF and a Contention Free Period (CFP) used by PCF. The CFP starts with a beacon frame sent by the base station using the basic DCF access mechanism. During this period, the AP uses a Round Robin scheduling algorithm to poll stations. Stations that have been polled have to respond to the poll packets. If there is no pending transmission, the response is a null frame with no payload. To ensure that no DCF stations are able to interrupt this mode of operation, PCF uses PIFS which is shorter than DIFS. If the CFP terminates before all stations have been polled, the remaining stations will be polled first in the following CFP.

According to the definition of QoS mentioned in Section 1, DCF can only support best-effort services, without any QoS guarantees. However, in DCF all the stations in a Basic Service Set (BSS) or all the flows from the same station compete the resources and channel with the same priority. There

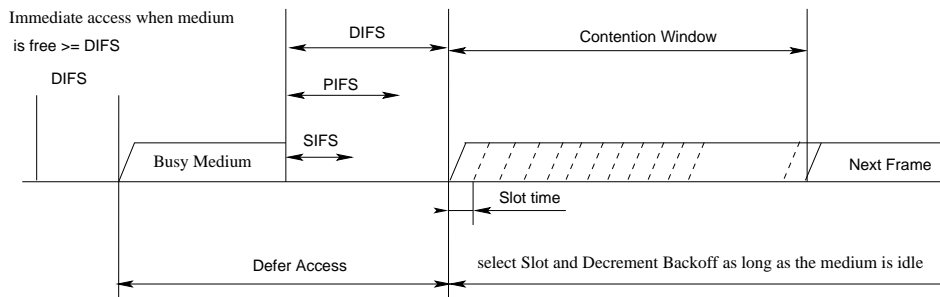

Figure 1: IFS relationships of IEEE 802.11

is no differentiation mechanism to guarantee packet delay and jitter to stations or flows supporting time-bounded multimedia services. Moreover, the performance evaluation results in [7, 8] show that DCF suffers from significant throughput degradation and high delay at high load conditions. These degradations are caused by the increasing time used for channel access negotiation.

3 Related works

Many medium access schemes have been proposed for IEEE 802.11 WLAN to provide some QoS enhancements for real-time audio and video traffics. Some of them mainly focus on the station-based DCF enhancement schemes [4, 9, 11, 12]. Other recent works focus on queue-based enhancement schemes [2, 3, 6]. In this section, we outline pros/cons of each of these mechanisms. Then, we present in detail the new features of the IEEE 802.11e standard [3].

3.1 Overview of QoS enhancement schemes proposed for IEEE 802.11

To introduce priorities in IEEE 802.11 using DCF, three techniques have been proposed in [4]. Each scheme uses different parameters to provide service differentiation:

(a) Backoff increase function: Each priority level has a different backoff increment function. Experiments show that this scheme performs well with UDP but not with TCP because ACKs affect the differentiation mechanism.

(b) Different DIFS: This scheme ensures that no high priority station has queued frames when station of low priority starts transmission. The main issue of this scheme is that low priority traffic suffers as long as high priority frames are queued. Moreover, TCP ACKs also reduce the effects of service differentiation since all ACKs have the same priorities.

(c) Different Maximum Frame Length: This mechanism is used to increase both transmission reliability and differentiation, and works well for TCP and UDP flows. However, in a noisy environment, long packets are more likely to be corrupted than short ones, which decreases the efficiency of this scheme.

In [9], an algorithm is proposed to provide service differentiation using two parameters of IEEE 802.11, the backoff interval and the IFS (used after each data transmission). This scheme proposes four levels of priority which ensure that high priority classes have a short waiting time when accessing the medium. Indeed, when a collision occurs, high priority stations are more likely to access the medium than a low priority ones. However, when there is not any high priority stations that want to transmit packets, the low priority ones still use a long backoff time.

[10] proposes a Distributed Fair Scheduling (DFS) scheme, which utilizes the ideas of fair queuing in the wireless domain. A distributed algorithm for rate-based service differentiation is described. This

mechanism solves the problem of throughput fairness between different flows of traffic. However, the paper does not present an analysis of the delay differentiation.

Based on DCF, a fully distributed service quality estimation, radio monitoring, and admission control approach are proposed in [12] to support service differentiation. A Virtual MAC (VMAC) algorithm monitors the radio channel and estimates locally achievable service levels. The VMAC estimates MAC level statistics related to service quality such as delay, jitter, packet collision, and packet loss. A Virtual Source (VS) algorithm utilizes the VMAC to estimate application-level service quality. The VS allows application parameters to be tuned in response to dynamic channel conditions based on virtual delay curves. To provide service differentiation, they also introduce backoff timer differentiation, such as $CW_{min}^{high-pri} < CW_{min}^{low-pri}$, $CW_{max}^{high-pri} < CW_{max}^{low-pri}$. Results show that when these distributed virtual algorithms are applied to the admission control of the radio channel, then, a globally stable state can be maintained without the need for complex centralized radio resource management.

A distributed solution for the support of real-time sources over IEEE 802.11, called *Blackburst*, is discussed in [11]. This scheme modifies the MAC to send short transmissions in order to gain priority for real-time service. It is shown that this approach is able to support bounded delays. The main drawback of this scheme is that it requires constant intervals for high priority traffic, otherwise the performance degrades very much. Moreover, this scheme is optimized to meet the service requirements of isochronous traffic sources, which is a significant limitation for variable data rate applications.

3.2 New features of IEEE 802.11e

The IEEE 802.11 working group is currently working on the support of QoS in a new standard, called IEEE 802.11e [2, 3]. A new access method called Hybrid Coordination Function (HCF) is introduced. It is a queue-based service differentiation that uses both DCF and PCF enhancements. HCF describes some enhanced QoS-specific functions, called contention-based HCF channel access and polling-based HCF access channel. These two functions are used respectively during both CP and CFP for transfers with QoS. Enhanced DCF (EDCF) is the contention-based HCF channel access. The goal of this scheme is to enhance DCF access mechanism of IEEE 802.11 and to provide a distributed access approach that can support service differentiation. The proposed scheme provides capability for up to eight types of traffic classes. It assigns a short CW to high priority classes in order to ensure that in most cases, high-priority classes will be able to transmit before the low-priority ones. More specifically, the CW_{min} parameter is set differently for different priority classes, yielding high priority classes with small CW_{min} .

For further differentiation, 802.11e proposes the use of different IFS set according to traffic classes. Instead of DIFS, an Arbitration IFS (AIFS) is used. The AIFS for a given class should be a DIFS plus some (possibly zero) time slots. Classes with the smallest AIFS will have the highest priority as shown in Figure 2. Each Traffic Category (TC) within the station behaves like a virtual station: it contends for access to the medium and independently starts its backoff time after detecting if the medium as idle for at least AIFS.

To decrease delay, jitter, and achieve higher medium utilization, packet bursting is proposed in this standard. So, once a station has gained access to the medium, it can be allowed to send more than one frame without contending for the medium again. After getting access to the channel, the station is allowed to send as many frames it wishes as long as the total access time does not exceed a certain limit (TxOpLimit) and no collision occurs.

Per priority differentiation used by EDCF ensures better services to high priority class while offering a minimum service for low priority traffic. Although this mechanism improves the quality of service of real-time traffic, the performance obtained are not optimal since EDCF parameters cannot be adapted to the network conditions. In fact, since each TC is implemented as a virtual station, the collision rate

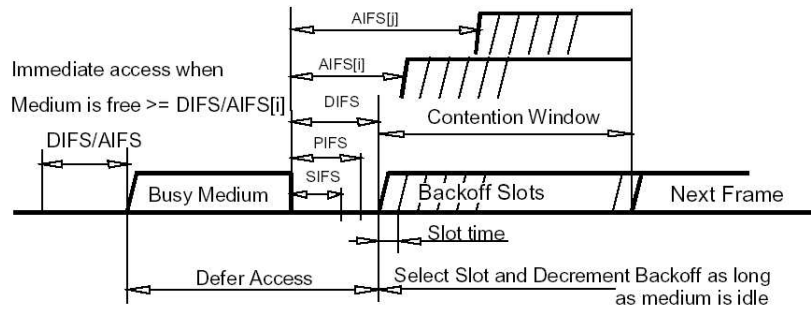

Figure 2: IFS relationships of IEEE 802.11e

increases very fast when the contentions to access the medium are high, which significantly affects the goodput, the latency and thus, decreases the performance of delay-bounded applications [5].

Figure 3 compares the 802.11e architecture that supports queue-based differentiation with the original one queue based DCF access mechanism.

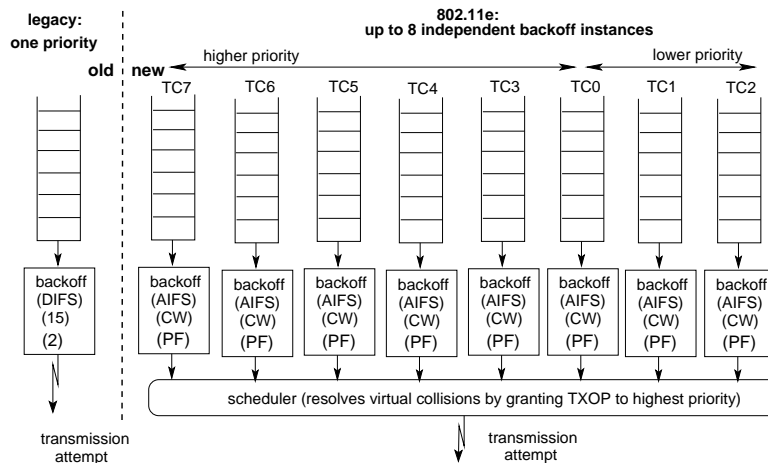

Figure 3: Queue-based EDCF vs. basic DCF

When two or more TCP senders share the same receiver, they all receive TCP-ACKs with the same priority (limited to the same receiver priority). This tends to reduce the service differentiation. Furthermore, if the shared receiver is slow, the observed relative priority will also be reduced. This motivates the use of queue-based differentiation where a shared node handles simultaneously several flows with different priorities. To improve the performance under different load rates and to increase the service differentiation in EDCF-based networks, we propose a new scheme called Adaptive EDCF (AEDCF). This scheme, described in details in the next section, extends the basic EDCF by making it more adaptive taking into account network conditions.

4 The Adaptive EDCF (AEDCF) scheme

Let n the number of active stations, and i the priority class. The flows sent by each station may belong to different classes of service with various priority levels. In each station and for each class i , the following parameters are defined:

- $CW[i]$: the current contention window,

- $CW_{min}[i]$: the minimum contention window, and
- $CW_{max}[i]$: the maximum contention window.

Note that i varies from 0 (the highest priority class) to 7 (the lowest priority class).

4.1 Scheme description

In order to efficiently support time-bounded multimedia applications, we use a dynamic procedure to change the contention window value after each successful transmission and after each collision. We believe that this adaptation will increase the total goodput of the traffic which becomes limited when using the basic EDCA, mainly for high traffic load.

4.1.1 Setting CW after each successful transmission

After each successful transmission, the EDCA mechanism resets the contention window of the corresponding class i to $CW_{min}[i]$ regardless the network conditions. Motivated by the fact that when a collision occurs, a new one is likely to occur in the near future, we propose to update the contention window more slowly (not reset to $CW_{min}[i]$) after successful transmission to avoid bursty collisions. The simplest scheme to update $CW[i]$ is to decrease it by a multiplicative factor such as $0.5 * CW_{old}$. We denote this approach the Slow Decrease (SD) scheme in the remainder of this paper. However, a static factor cannot be optimal in all network conditions. In our scheme, we propose that every class updates its CW parameter in an adaptive way taking into account the estimated collision rate f_{curr}^j in each station. Indeed, the collision rate can give an indication about contentions in a distributed network. The estimated collision rate f_{curr}^j is calculated using the number of collisions and the total number of packets sent during a constant period (i.e. a fixed number of slot times) as follows:

$$f_{curr}^j = \frac{E(collisions_j[p])}{E(data_sent_j[p])}, \quad (3)$$

where $E(collisions_j[p])$ is the number of collisions of station p which occurred at step j , and $E(data_sent_j[p])$ is the total number of packets that station p has sent during the same period j . Note that the above ratio f_{curr}^j is always in the range of $[0, 1]$.

To minimize the bias against transient collisions, we use an estimator of Exponentially Weighted Moving Average (EWMA) to smoothen the estimated values. Let f_{avg}^j be the average collision rate at step j . The average collision rate is computed dynamically in each period T_{update} expressed in time-slots. This period called **update period** should not be too long in order to get good estimation and should not be too short in order to limit the complexity. For each update period, f_{avg}^j is computed according to the following iterative relationship:

$$f_{avg}^j = (1 - \alpha) * f_{curr}^j + \alpha * f_{avg}^{j-1} \quad (4)$$

where j refers to the j^{th} update period and f_{curr}^j stands for the instantaneous collision rate, α is the *weight* (also called the *smoothing factor*) and determines the memory size used in the averaging process.

To ensure that the priority relationship between different classes is still fulfilled when a class updates its CW , each class should use different factor according to its priority level (we denote this factor by Multiplier Factor or MF). Keeping in mind that the factor used to reset the CW should not exceed the previous CW , we limit the maximum value of MF to 0.8. We have fixed this limit according to a large number of simulations done with different scenarios. In AEDCA, the MF of class i is defined as follows:

$$MF[i] = \min((1 + (i * 2)) * f_{avg}^j, 0.8). \quad (5)$$

This formula allows the highest priority class to reset the CW parameter with the smallest MF value (i.e., priority level 0, see TC7 in Figure 3).

After each successful transmission of packet of class i , $CW[i]$ is then updated as follows:

$$CW_{new}[i] = \max(CW_{min}[i], CW_{old}[i] * MF[i]). \quad (6)$$

Equation 6 guarantees that $CW[i]$ is always greater than or equal to $CW_{min}[i]$, so the priority access to the wireless medium is always maintained.

4.1.2 Setting CW after each collision

In the current version of EDCF[3], after each unsuccessful transmission of packet of class i , the $CW_{new}[i]$ is then doubled, while remaining less than the maximum contention window $CW_{max}[i]$:

$$CW_{new}[i] = \min(CW_{max}[i], 2 * CW_{old}[i]). \quad (7)$$

We propose to change this mechanism and differentiate between classes using different factors to increase their CW s: In AEDCF, after each unsuccessful transmission of packet of class i , the new CW of this class is increased with a Persistence Factor $PF[i]$. More precisely, the PF parameter is set differently for different priority classes, yielding high priority classes with small PF :

$$CW_{new}[i] = \min(CW_{max}[i], CW_{old}[i] * PF[i]). \quad (8)$$

This mechanism offers to high priority traffic a higher probability to generate smaller CW value than for low priority traffic. By this way, we can reduce the probability of a new collision and consequently decrease delay.

4.2 Complexity of AEDCF

The complexity of AEDCF is similar to the complexity of EDCF, only a few more resources are required. Some registers are necessary to buffer the parameters defined above: f_{avg}^{j-1} , T_{update} , $MF[i]$ and α . The f_{avg}^j and $MF[i]$ parameters defined in Equations 4 and 5, are updated only at the beginning of each new update period T_{update} . The calculation of $MF[i]$ requires one addition, two multiplications and one comparison for each active class. Then, two multiplications and two additions are required to compute f_{avg}^j and one more division to obtain f_{curr}^j (which is defined in Equation 3 for all the active TCs).

One comparison and one multiplication are used to compute $MF[i]$ and to decide how to reset the $CW[i]$ (see Equation 6). Finally, during the update period, two counters are needed to increment collisions and data sent, one comparison and one multiplication are introduced in Equation 6 to calculate the $CW_{new}[i]$ and to decide which value will be used to reset the CW .

5 Simulation Methodology and Results

We have implemented the AEDCF scheme in the ns-2 simulator; our ns source codes are available in [13]. In this section, we investigate and analyze the performance of AEDCF under several scenarios.

5.1 Impact of the update period T_{update}

As mentioned in Section 4.1, the AEDCF adapts the contention window values according to the estimated collision rate each T_{update} time slots. We evaluate in this section, the impact of the update period on the performance of AEDCF. For this purpose, we use the topology shown in Figure 4, which consists of n stations indexed from 1 to n . Each station generates the same traffic consisting of three

data streams labeled according to their priorities with high, medium and low. Station n sends packets to station 1. Station i ($i < n$) sends to station $i + 1$ three flows of different classes: Audio (high priority), Video (medium priority), and Background Traffic (denoted by BT of low priority). We use CBR sources to simulate BT, audio, video and traffics. Table 1 shows the network parameters selected for the three traffic classes (TCs).

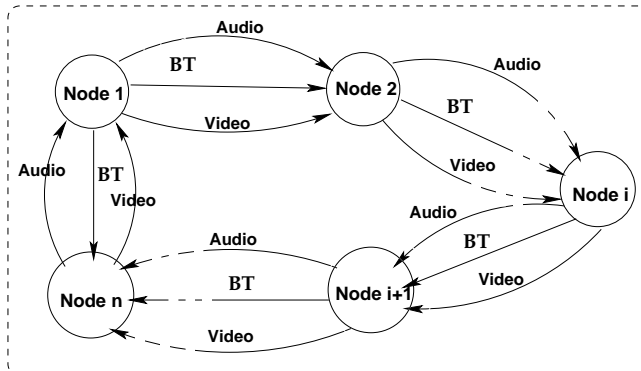

Figure 4: Simulation Topology

Parameters	High	Medium	Low
CW_{min}	5	15	31
CW_{max}	200	500	1023
are	34	43	52
PF	2	4	5
Packet Size(bytes)	160	1280	200
Packet Interval(ms)	20	10	12.5
Sending rate(Kbit/s)	64	1024	260

Table 1: MAC parameters for the three TCs.

In the following simulations, we assume that each wireless station operates at IEEE 802.11a PHY mode-6 [14], see the corresponding network parameters shown in Table 2.

SIFS	$16\mu s$
DIFS	$34\mu s$
ACK size	14 bytes
Data rate	36 Mbits/s
Slot_time	$9\mu s$
CCA Time	$3\mu s$
MAC Header	28 bytes
Modulation	16-QAM
Preamble Length	$20\mu s$
RxTxTurnaround Time	$1\mu s$
PLCP header Length	$4\mu s$

Table 2: IEEE 802.11a PHY/MAC parameters used in simulation

The update period is adjusted from 500 to 38000 time-slots. Figure 5 and 6 show the average delay and goodput, respectively, as a function of the update period value. Twenty-five stations are used to evaluate the effect of the update period. All the results are averaged over 20 simulations. In each iteration, the update period is increased by 500 time slots, i.e. 0.045 ms .

As we can see from Figure 6, the update period has a very few impact on the overall goodput. Indeed, when the update period increases, the goodput decreases from less than 1%. Figure 5 shows that the update period value has much more impact on the average delay than on goodput. The corresponding delay is high when the update period is very short. However, it remains quasi constant in the interval $[3000, 8000]$, but increases with a high value of T_{update} . So, in order to tradeoff between goodput and latency, we recommend a T_{update} value equal to 5000 time-slots.

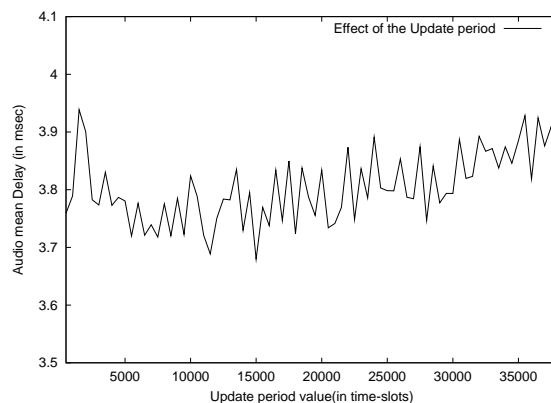

Figure 5: Impact of the update period on average delay

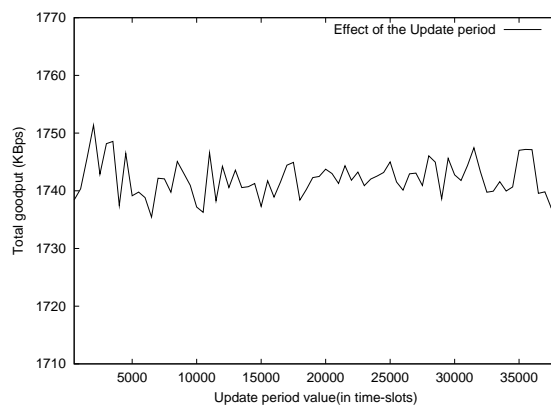

Figure 6: Impact of the update period on the overall goodput

5.2 Impact of the smoothing factor α

Here we analyze the impact of the smoothing factor α on the performance of AEDCF. We remind that this factor is used to estimate the average collision rate, as defined in Equation 4.

We use the same scenario than in the previous section. Figure 7 and Figure 8 show the average delay and goodput as a function of the smoothing factor α , respectively. The results are averaged over 20 simulations. Twenty-five stations, corresponding to a load rate of 94%, are used to evaluate the effect of the smoothing factor. We can note that choosing a value of α in the range of $[0.75, 1]$ gives

the best tradeoff between goodput and average delay. So, we recommend $\alpha = 0.8$ and use this value in the following simulations.

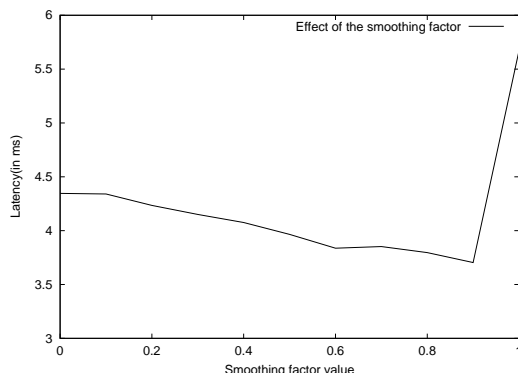

Figure 7: Impact of the smoothing factor on average delay

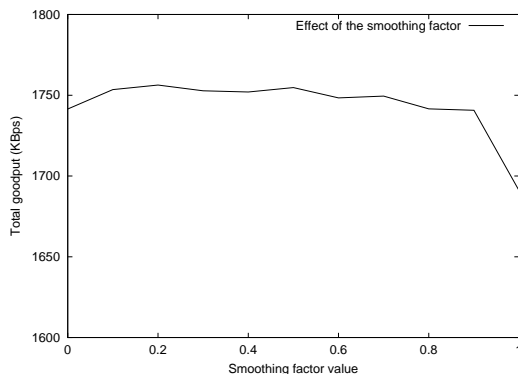

Figure 8: Impact of the smoothing factor on goodput

5.3 Impact of the traffic load

To evaluate the performance of AEDCF, we investigate in this section the effect of the traffic load and compare it with EDCF and SD schemes.

As mentioned in Table 1, our simulations use different types of traffics to evaluate service differentiation. Three queues are used in each station. The highest priority queue in each station generates packets with packet size equal to 160 bytes and inter-packet interval of 20 ms, which corresponds to 64 Kbit/s PCM audio flow. The medium traffic queue generates packets of size equal to 1280 bytes each 10 ms which corresponds to an overall sending rate of 1024 Kbit/s. The low priority queue in each station generates packets with sending rate equal to 260 Kbit/s, using a 200 bytes packet size. To modify the load of the network, we have used a different the number of stations, which gradually increases during the simulations. We all the stations are located within an Independent Basic Service Set such that every station is able to detect a transmission from any other station, and stations are not moving during the simulations. The topology is shown in Figure 4. We start simulations with two wireless stations, then we increase the load rate by incrementing the number of stations by one every eight seconds. Figures 9 - 13 show the averages of delay, goodput gain, medium utilization and collision rate over 5 simulations. The number of stations is increased from 2 to 44 which correspond to load rates from 7.5% to 160%.

The relationship between the load rate and the number of stations is shown in Table 3. To evaluate the performance of the different schemes, the following metrics are used:

- **Gain of goodput:** This metric stands for the gain (in %) of the Average Goodput (AG) for schemes SD or AEDCF, compared with the basic EDCF. It is calculated as follows:

$$Gain_of_goodput = \frac{AG_{new} - AG_{EDCF}}{AG_{EDCF}} * 100\%$$

- **Mean delay:** It is the average delay of all the flows that have the same priority in the different stations. The average delay is used to evaluate how well the schemes can accommodate real-time flows. However, real-time flows require both low average delay and bounded jitter. So we also need the following metrics of latency distribution and delay variation.
- **Latency distribution:** Latency distribution allows to trace the percentage of packets that have latency less than the maximum delay required by the applications.
- **Medium utilization:** Due to the scarcity of wireless bandwidth, we study the medium utilization of the different schemes, by computing the percentage of time used for transmission of data frames: $Medium_utilization = \frac{TotalTxTime - CollisionTime - IdleTime}{TotalTxTime} * 100\%$
- **Collision rate:** Collisions in wireless LAN cause additional delays. The collision rate is calculated as the average number of collisions that occur per second.

Number of stations	Load rate
2	7.5 %
5	19 %
10	37%
15	56%
20	75 %
25	94%
30	110%
35	131 %
40	150 %
42	160 %
44	170 %

Table 3: Correspondence between number of stations and load rate

Figure 9 shows the average delay for the audio flow corresponding to the high priority class. The AEDCF scheme is able to keep the delay low even when the traffic load is very high, i.e., with a large number of stations. We can observe that the average delay of audio for AEDCF is 50% smaller than that for the basic EDCF when the load rate is up to 100% (26 stations). Moreover, the average delay of audio flows with AEDCF is still 38% smaller than the one obtained with EDCF when the load rate reaches 170% (44 stations). Indeed, when the number of stations is more than 13, the delay obtained by the EDCF increases faster than AEDCF and SD schemes, while AEDCF always keeps a lower mean access delay less than 10 ms. We can also note that AEDCF offers an average delay 30% less than the SD scheme when the load rate reaches 170%.

In Figure 10, we plot the gain on goodput as a function of the traffic load of AEDCF and SD schemes. We observe that the goodput gain of AEDCF increases when the traffic load increases. It reaches about 28% when the load rate is about 130% (i.e. for 35 stations). Moreover, the goodput of

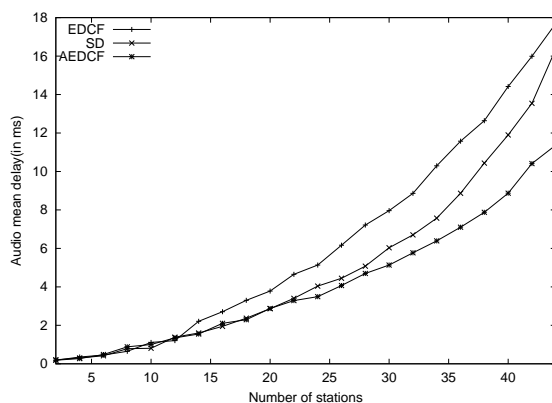

Figure 9: Audio average delay

AEDCF is 10% higher than the SD scheme when the load rate is 170%. Indeed, AEDCF is much more efficient during high load rate.

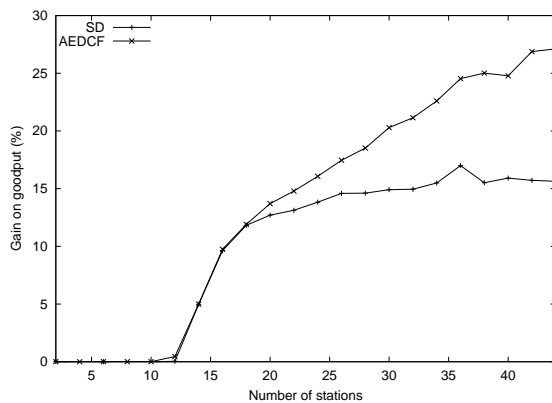

Figure 10: Gain of goodput

Figure 11 shows the medium utilization as a function of the traffic load. For the three schemes the medium utilization decreases when the traffic load increases. However, AEDCF achieves the highest medium utilization whatever the number of stations.

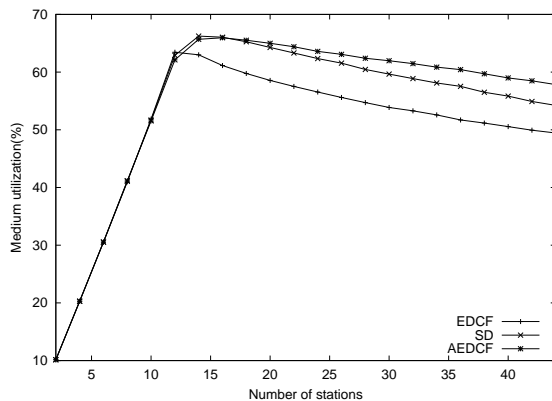

Figure 11: Medium utilization

The corresponding collision rate is shown in Figure 12. Collision rates achieved by the three schemes are similar when the traffic load is low, i.e. the number of stations is less than 8. However, when the traffic load increases, AEDCF is able to maintain a lower collision rate than EDCF and SD schemes. We can explain this behavior by the fact that AEDCF uses an adaptive technique to change the contention windows according to the collision rate. The reduction of collision rate of AEDCF leads to significant goodput improvement and reduces the delay.

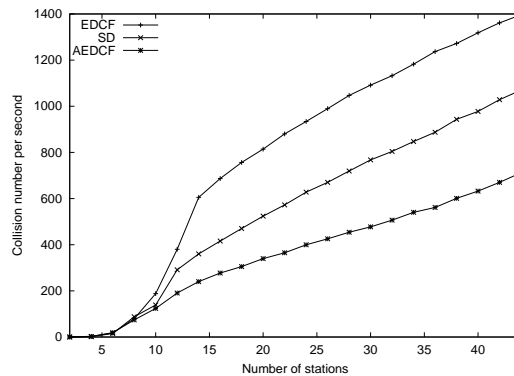

Figure 12: Collision rate

Gains on goodput of audio, video and background traffics are shown in Figure 13. We can note that AEDCF improves significantly the goodput specially for video and background TCs. Since the goodput parameter is more important for video and background data traffics than for audio traffics, the results obtained for these two traffic are very interesting. Indeed, when the load rate is about 100%, the goodput of video and background traffics are increased for respectively 20% and 140%.

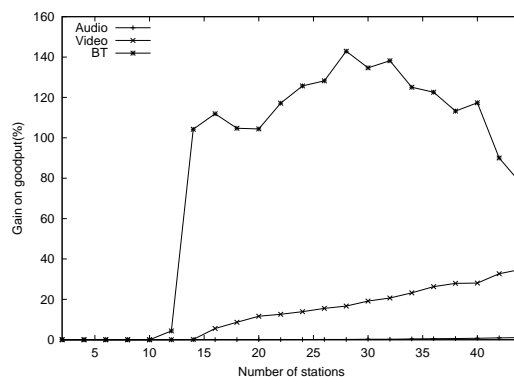
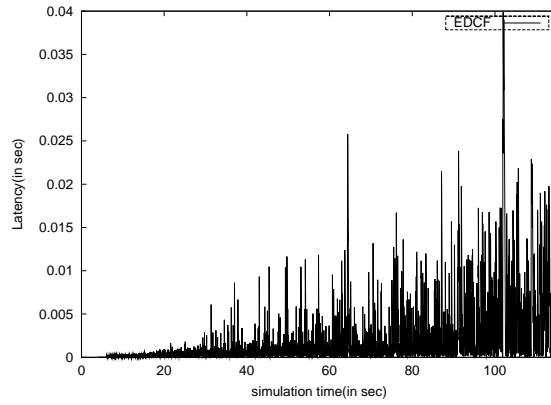

Figure 13: Gain on goodput of each TC compared with EDCF

We have used a different simulation to study performance on delay and jitter. This new experiment has the same topology than Figure 4, but the number of stations is increased from 2 (4 sec) to 25 (100 sec) and the simulation stops at $t = 115$ sec. The delay variations of both EDCF and AEDCF schemes are plotted in Figure 14. AEDCF meets target by maintaining the delay lower than EDCF and stable during the live of audio sessions. However, we can note that both delay and jitter for EDCF are twice higher than AEDCF, which degrade the quality of audio flows.

The latency distribution for each TC is shown in Figures 15 - 18, where a fixed number of 25 stations is used to evaluate delay performance. On a cumulative distribution plot, an ideal result would coincide with the y-axis, representing 100% of results with zero latency. Although we cannot reasonably expect zero latency, we would like to obtain consistent performance, corresponding to a vertical line. In each



(a) Audio delay for EDCF

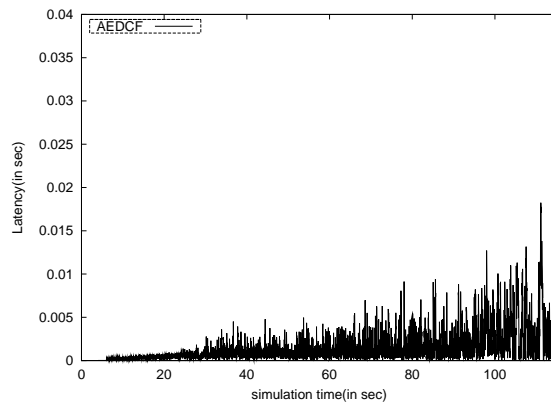

(b) Audio delay for AEDCF

Figure 14: The audio class delay variation

plot, we show the cumulative distribution of each TC for both EDCF and AEDCF schemes. We can note that the delay increases in both AEDCF and EDCF schemes from high to low priority levels. In AEDCF, the delay differentiation is efficiently maintained as shown in Figure 15. The solid lines for all the three figures, show that for a significant cumulative fraction of packets AEDCF gives better results than EDCF.

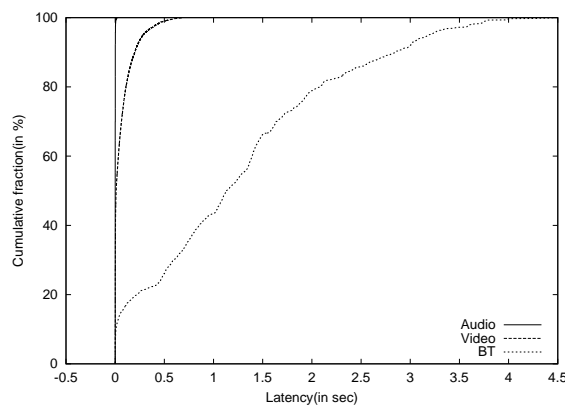

Figure 15: AEDCF latency distributions for each TC

Figure 16 shows that AEDCF always outperforms EDCF. Note that the maximum delay of audio packets for AEDCF is less than 20ms, whereas for EDCF, the maximum value is more than 30ms.

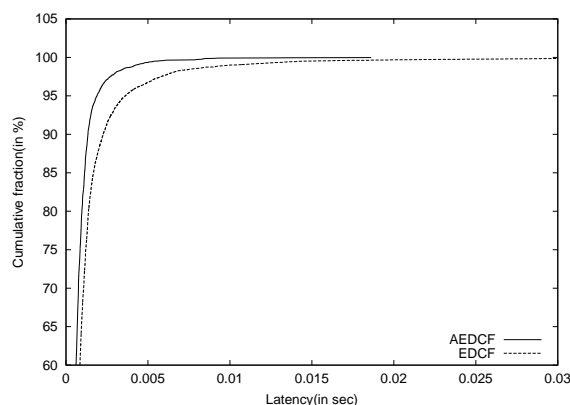

Figure 16: AEDCF and EDCF latency distributions of audio traffic

Figure 17 shows the latency of video (medium priority) traffic for both AEDCF and EDCF schemes. There are considerable differences between them, i.e. more than 85% of video packets for AEDCF have delay less than 200ms, whereas only 30% of video packets for EDCF have delay less than 200ms. Moreover, we can observe from Figure 18 that more than 20% of BT (low priority) packets of EDCF

have delay higher than 4 seconds. These results are due to incorrect fast decreases of the CW s which increase the collision probability for next packet transmissions and thus increase end-to-end delays.

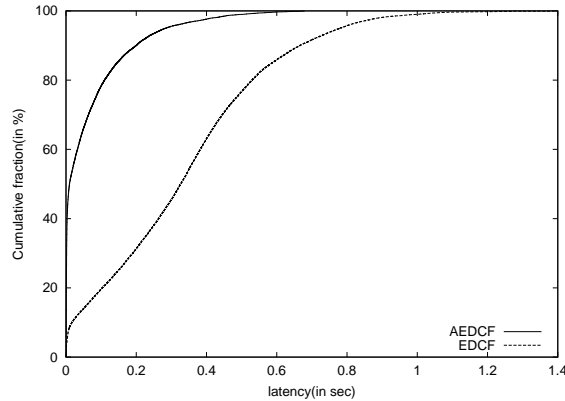

Figure 17: AEDCF and EDCF latency distributions of video traffic

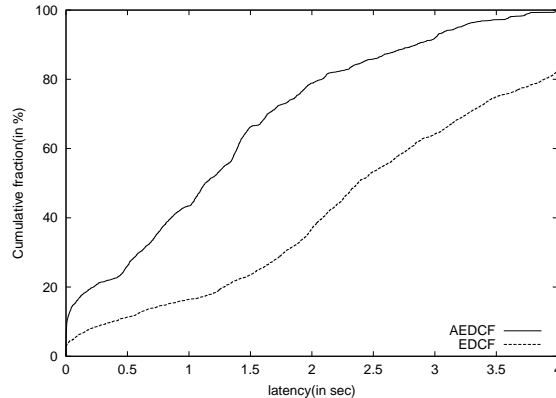

Figure 18: AEDCF and EDCF latency distributions of background traffic

From the simulations, we can conclude that both AEDCF and SD schemes outperform EDCF. Using an adaptive slow decrease algorithm, AEDCF get much higher goodput than the SD scheme. Moreover, the AEDCF scheme can improve the goodput and delay performance of all types of traffics.

6 Conclusion

Our main contribution in this report is the design of a new adaptive scheme for Quality of Service enhancement for IEEE 802.11 ad-hoc WLANs. Simulation results show that AEDCF efficiently differentiates services and achieves better performance of throughput, delay and jitter. We validate our

results by analyzing the impact of sources and network dynamics on the performance metrics and compare the results obtained with the basic EDCF and the SD schemes. Future works include adapting other parameters such as CW_{max} , the maximum number of retransmissions and the packet burst length according to the network load rate. Although AEDCF is intended to improve performance of wireless ad-hoc networks, the same idea can be used in the infrastructure mode with some changes. These changes and the implementation on a real WLAN environment represent our future efforts.

Acknowledgments:

The authors would like to thank Imad Aad for early discussions and fruitful comments. This work has been supported by the French ministry of industry in the context of the national project RNRT-VTHD++.

References

- [1] *IEEE WG, Part 11: Wireless LAN Medium Access Control (MAC) and Physical Layer (PHY) Specifications*, IEEE 802.11 Standard, 1999.
- [2] S. Mangold, S. Choi, P. May, O. Klein, G. Hiertz, and L. Stibor, *IEEE 802.11e Wireless LAN for Quality of Service*, In Proc. of European Wireless (EW2002), Florence, Italy, February 2002.
- [3] *IEEE WG, Draft Supplement to Standard for Telecommunications and Information Exchange between Systems-LAN/MAN Specific Requirements- Part 11: Wireless LAN Medium Access Control (MAC) and Physical Layer (PHY) Specifications: Medium Access Control (MAC) Enhancements for Quality of Service (QoS), 802.11e Draft 3.1*, May, 2002.
- [4] I. Aad and C. Castelluccia, *Differentiation mechanisms for IEEE 802.11*, In Proc. of IEEE Infocom 2001, April 2001.
- [5] A. Lindgren, A. Almquist, and O. Schelen, *Evaluation of Quality of Service Schemes for IEEE 802.11*, In Proc. of IEEE LCN 2001, November 2001.
- [6] I. Aad and C. Castelluccia, *Remarks on per-flow differentiation in IEEE 802.11*, European Wireless 2002, February 2002.
- [7] K.C Chen, *Medium access control of wireless LANs for mobile computing*, IEEE Network, vol. 8, no. 5, pp. 50-63, September 1994.
- [8] H.S. Chahalaya and S. Gupa, *Throughput and fairness properties of asynchronous data transfer methods in the IEEE 802.11 MAC protocol*, Personal Indoor Mobile and Radio communication conference, pp. 613-617, 1995.
- [9] J. Deng and R. S. Chang, *A priority Scheme for IEEE 802.11 DCF Access Method*, IEICE Transactions in Communications, vol. 82-B, no. 1, January 1999.
- [10] N. H. Vaiday, P. Bahl, and S. Gupa, *Distributed Fair Scheduling in a Wireless LAN*, In the sixth Annual International Conference on Mobile Computing and Networking, Boston, August 2000.
- [11] J.L. Sobrinho and A.S. Krishnakumar, *Real-time traffic over the IEEE 802.11 medium access control layer*, Bell Labs Technical Journal, pages 172-187, Autumn 1996.

- [12] A. Veres, A.T. Campbell, M. Barry, and L-H. Sun, *Supporting service differentiation in wireless packet networks using distributed control*, IEEE Journal of Selected Areas in Communications (JSAC), Special Issue on Mobility and Resource Management in Next-Generation Wireless Systems, Vol. 19, No. 10, pp. 2094-2104, October 2001
- [13] *AEDCF*, <http://www-sop.inria.fr/planete/qni/Research.html>.
- [14] *IEEE 802.11a, Part 11: Wireless LAN Medium Access Control (MAC) and Physical Layer(PHY) Specifications: High-speed Physical Layer in the 5 Ghz Band, Supplement to IEEE 802.11 Standard*, Sep., 1999.



Unité de recherche INRIA Sophia Antipolis

2004, route des Lucioles - BP 93 - 06902 Sophia Antipolis Cedex (France)

Unité de recherche INRIA Lorraine : LORIA, Technopôle de Nancy-Brabois - Campus scientifique
615, rue du Jardin Botanique - BP 101 - 54602 Villers-lès-Nancy Cedex (France)

Unité de recherche INRIA Rennes : IRISA, Campus universitaire de Beaulieu - 35042 Rennes Cedex (France)

Unité de recherche INRIA Rhône-Alpes : 655, avenue de l'Europe - 38330 Montbonnot-St-Martin (France)

Unité de recherche INRIA Rocquencourt : Domaine de Voluceau - Rocquencourt - BP 105 - 78153 Le Chesnay Cedex (France)

Éditeur

INRIA - Domaine de Voluceau - Rocquencourt, BP 105 - 78153 Le Chesnay Cedex (France)

<http://www.inria.fr>

ISSN 0249-6399